

DREMEL®

2009-2010 PRODUCT AND ACCESSORIES CATALOG



INDEX

Corded Rotary Tools*

4 - 5	Rotary Tool Overview	12	Dremel® 200 Series
6 - 9	Dremel® 4000	13	Dremel® 100 Series
10 - 11	Dremel® 300 Series		

Cordless Rotary Tools*

14 - 15	10.8V Lithium-Ion Cordless™	17	MiniMITE® Cordless
16	Two-Speed Cordless	18 - 19	Dremel® Stylus™

Rotary Tool Attachments*

20	MultiSaw	23	Mini Saw
20	Planer	23 - 25	Lawn Mower, Garden Tool & Chain Saw Sharpening Attachments
21	Work Station™	24	Circle Cutter and Straight Edge Guide
21	Flex Shaft Attachment	25	Multi-Vise™
21	Routing Attachments		
22	Cutting Kits		
22	Grout Removal Attachment		
23	Right Angle Attachment		

Rotary Tool Accessories*

26 - 27	Carving/Engraving	34 - 35	Cleaning/Polishing
28	Routing	36 - 37	Sanding
29 - 30	Grinding/Sharpening	38 - 39	Miscellaneous
31 - 33	Cutting	39 - 41	Accessory Kits

Multi-Max™ Tool System and Accessories* – 42-45

Glue Gun and Accessories* – 46

VersaTip™ Multipurpose Tool and Accessories* – 47

Engraver and Accessories* – 48

* Features and specifications subject to change without notice.



Call for Your Free Dremel DVD

1(800) 437-3635



Customer Support

Answering questions for consumers about our tools is accomplished by a well-prepared staff known as the Dremel Experts. With over 450 total years of combined work experience, the Dremel Experts are ready to serve you. Call:

1-800-4-DREMEL (1-800-437-3635) USA.
1-888-285-3476 CANADA.
www.dremel.com

DREMEL®



What Is a Rotary Tool?

Rotary tools are hand held power tools that use high rpm and low torque to safely and manageably undertake a variety of tasks. Why a Dremel high speed rotary tool over any other? For starters, we invented the category. Since AJ Dremel invented the first high-speed rotary tool over 70 years ago no other brand has worked harder to bring its users a more complete and innovative system of tools, accessories, and attachments. Over the years Dremel rotary tools have become the gold standard in versatility, performance, comfort, and quality by which all other rotary tools are judged.



What Is an Oscillating Tool?

Oscillating tools, like rotary tools, utilize a variety of accessories that enable them to take on tasks that it once took many other tools to accomplish. But, rather than using a spinning motion like a rotary tool, an oscillating tool's accessory "oscillates" using 3° of rapid side-to-side motion occurring between 10,000 and 20,000 times per minute. With the broad range of Multi-Max accessories available from the Dremel brand; you can use your tool as a power scraper, plunge saw, multi-purpose cutting tool, detail sander, grout remover, rust remover and a mini grinder.



Tools That Perform When the Other Tools Won't.

A comment we hear fairly frequently is, "The only way I could do it was with a Dremel tool." Sometimes, when you can't figure out how to get the job done, a Dremel rotary tool or oscillating tool provides the only solution. Dremel tool attributes of compact size, versatility and superior ergonomics are the perfect characteristics for completing work in tight spaces, demanding precision, or requiring superior tool control. The Dremel brand has the tools, attachments and accessories to help you make your specialized project a success.

DREMEL®

ROTARY TOOL OVERVIEW - CORDED



Model	4000	300SERIES	200SERIES	100SERIES
Amps	1.6	1.15	1.15	1.15
Speed Range	5,000 - 35,000 RPM	5,000 - 35,000 RPM	15,000 and 35,000 RPM	35,000 RPM
Electronic Feedback Control	Yes	No	No	No
Number of Speeds	Variable	Variable	2	1
Soft Grip	Yes	Yes	No	No
Grip Style	In-line	In-line	In-line	In-line
Separate On/Off Speed Control	Yes	No	No	No
Accepts High Performance Attachments	Yes	No	No	No
Weight [oz.]	18.8	18.0	18.0	18.0
Warranty	5 year	4 year	3 year	2 year

ROTARY TOOL OVERVIEW - CORDLESS



Model	10.8V*	STYLUS*	7.2V*	4.8V*
Voltage	10.8	7.2	7.2	4.8
Battery Type	Lithium Ion	Lithium Ion	Ni Cd	Ni Cd
Speed Range	5,000 - 35,000 RPM	5,000 - 25,000 RPM	10,000 and 20,000 RPM	6,500 and 13,000 RPM
Electronic Feedback Control	No	No	No	No
Number of Speeds	Variable	Variable	2	2
Soft Grip	Yes	Yes	No	No
Grip Style	In-line	Pistol	In-line	In-line
Separate On/Off Speed Control	No	Yes	No	No
Accepts High Performance Attachments	No	No	No	No
Weight [oz.]	14.0	9.0	12.0	9.0
Warranty	2 year	2 year	2 year	2 year

DREMEL 4000

HIGH PERFORMANCE ROTARY TOOL

Does it All, Better.™

Separate On/Off Switch

Retains speed setting for ease of use.

Quick Collet Lock

For fast accessory changes.

Pencil Grip

Close to bit.

Maximum Versatility

Can be used with all Dremel attachments and accessories.

360° Grip Zone

With soft grip for comfort and control.

5
YEAR
Limited
Warranty

HIGH PERFORMANCE ATTACHMENTS

Designed to utilize the power and performance of the High Performance Rotary Tool.



PLANER – MODEL PL400



MULTISAW – MODEL MS400

ATTACHMENTS



DETAILER'S GRIP – MODEL A577*



SANDING/GRINDING GUIDE – MODEL A576*



Electronic Feedback

Maintains speed under load.

Variable Speed

For greater versatility. Controls do not interfere with grip.

New!



High-Performance Motor

For maximum performance at all speeds.

Replaceable Motor Brushes

For longer motor life.

4000 KIT – MODEL 4000-6/50

CONTENTS



- 4000 High Performance Rotary Tool
- Planer
- Flex Shaft
- Circle Cutter
- Sanding/Grinding Guide
- Cutting Guide
- Detail Nose Piece
- Lawn Mower and Garden Tool Sharpener
- Storage Case
- Accessory Case
- Quick Start Book
- Wrench

50 ASSORTED ACCESSORIES

- | | | |
|----------------------------------|----------------------------------|---|
| 107 Engraving cutter | 420 HD emery cut-off wheel (4) | 84922 Silicon carbide stone |
| 150 Drill bit | 421 Polishing compound | EZ402 EZ Lock mandrel |
| 191 High speed cutter | 428 Carbon steel brush | EZ409 1-1/2" Thin reinforced cutoff wheel |
| 194 High speed cutter | 429 Large felt wheel | EZ423 EZ Lock cloth polishing wheel |
| 401 Mandrel | 432 Medium 1/2" sanding band (2) | EZ456 1-1/2" reinforced cutoff wheel (2) |
| 402 Mandrel | 442 Carbon steel brush | EZ476 1-1/2" reinforced cutoff wheel (2) |
| 405 Bristle brush | 445 Fine 1/2" sanding band (2) | |
| 407 Coarse 1/2" sanding drum | 481 3/32" collet | |
| 408 Coarse 1/2" sanding band (2) | 540 1-1/4" cut-off wheel bulk | |
| 411 Coarse sanding discs (2) | 541 Aluminum oxide wheel | EZ511 180 and 280 grit abrasive buffs |
| 412 Medium sanding discs (2) | 561 Multipurpose cutting bit | EZ512 320 grit abrasive buff |
| 413 Fine sanding discs (2) | 932 Aluminum oxide stone | |
| 414 Small felt wheel (3) | 8193 Aluminum oxide stone | |

4000 KIT – MODEL 4000-3/34



CONTENTS

- 4000 High Performance Rotary Tool
- Detailer's Grip
- Sanding/Grinding Guide
- Cutting Guide
- Storage Case
- Accessory Case
- Quick Start Book
- Wrench

34 ASSORTED ACCESSORIES

107 Engraving cutter	413 Fine sanding disc	540 1-1/4" cut-off wheel bulk
150 Drill bit	414 Small felt wheel (3)	561 Multipurpose cutting bit
401 Mandrel	420 HD emery cut-off wheel (2)	932 Aluminum oxide stone
402 Mandrel	421 Polishing compound	8193 Aluminum oxide stone
403 Bristle brush	428 Carbon steel brush	84922 Silicon carbide stone
407 Coarse 1/2" sanding drum	429 Large felt wheel (2)	85602 Silicon carbide stone
408 Coarse 1/2" sanding band	432 Medium 1/2" sanding band (3)	EZ402 EZ Lock mandrel
411 Coarse sanding discs (2)	445 Fine 1/2" sanding band (2)	EZ456 1-1/2" reinforced cut-off wheel
412 Medium sanding disc	481 3/32" collet	

4000 KIT – MODEL 4000-2/30



CONTENTS

- 4000 High Performance Rotary Tool
- Sanding/Grinding Guide
- Circle Cutter
- Storage Case
- Accessory Case
- Quick Start Book
- Wrench

30 ASSORTED ACCESSORIES

191 High speed cutter	413 Fine sanding discs (20)	432 Medium 1/2" sanding band (2)
401 Mandrel	414 Small felt wheel	445 Fine 1/2" sanding band (2)
402 Mandrel	420 HD emery cut-off wheel (2)	541 Aluminum oxide wheel
407 Coarse 1/2" sanding drum	421 Polishing compound	561 Multipurpose cutting bit
408 Coarse 1/2" sanding band (3)	426 Fiberglass cut-off wheel (2)	932 Aluminum oxide stone
411 Coarse sanding discs (3)	428 Carbon steel brush	84922 Silicon carbide stone
412 Medium sanding discs (2)	429 Large felt wheel	

DREMEL 300 SERIES

Dynamic Styling

For additional comfort and control every time you use your rotary tool.

Ball Bearing Universal Motor

Runs cool and smooth under load.

Increased Comfort Grip Area

For more comfort and control.

Improved Convenient Collet Lock Button

For quick and easy accessory changes.

5,000 – 35,000 RPM Speed Range

No other AC power tool is faster. "Let speed do the work!"

4
YEAR
Limited
Warranty

Dove-Tail Feature

Accommodates new attachments for additional functionality.



On-Tool Wrench Storage

Keeps the wrench at your fingertips.

Replaceable Motor Brushes

For longer motor life.

300 SERIES KIT – MODEL 300-1/24



24 ASSORTED ACCESSORIES

- 191 High speed cutter
- 401 Mandrel
- 402 Mandrel
- 403 Bristle brush
- 407 Coarse 1/2" sanding drum
- 414 Small felt wheel (2)
- 420 HD emery cut-off wheel (2)
- 421 Polishing compound
- 422 Felt buff cone
- 426 Fiberglass cut-off wheel
- 428 Carbon steel brush
- 429 Large felt wheel
- 430 Coarse 1/4" sanding drum
- 431 Coarse 1/4" sanding band
- 432 Medium 1/2" sanding band
- 442 Carbon steel brush
- 540 1-1/4" cut-off wheel
- 561 Multipurpose cutting bit
- 932 Aluminum oxide stone
- 952 Aluminum oxide stone
- 8193 Aluminum oxide stone
- 85422 Silicon carbide stone

CONTENTS

- 300 Series Variable Speed Rotary Tool
- Circle Cutter
- Storage Case
- Accessory Case
- Quick Start Book
- Wrench

300 SERIES KIT – MODEL 300-2/28



28 ASSORTED ACCESSORIES

- 105 Engraving cutter
- 107 Engraving cutter
- 150 Drill bit
- 191 High speed cutter
- 194 High speed cutter
- 401 Mandrel (2)
- 402 Mandrel
- 403 Bristle brush
- 405 Bristle brush
- 407 Coarse 1/2" sanding drum
- 408 Coarse 1/2" sanding band
- 414 Small felt wheel
- 421 Polishing compound
- 426 Fiberglass cut-off wheel
- 428 Carbon steel brush
- 429 Large felt wheel
- 432 Medium 1/2" sanding band
- 445 Fine 1/2" sanding band
- 481 3/32" collet
- 511 Medium abrasive buff
- 540 1-1/4" cut-off wheel
- 560 Drywall cut-out bit
- 561 Multipurpose cutting bit
- 932 Aluminum oxide stone
- 952 Aluminum oxide stone
- 7144 Diamond wheel point
- 84922 Silicon carbide stone

CONTENTS

- 300 Series Variable Speed Rotary Tool
- Lawn Mower and Garden Tool Sharpener
- Cutting Guide
- Storage Case
- Accessory Case
- Quick Start Book
- Wrench

DREMEL 200 SERIES**3**
YEARLimited
Warranty

Can be Used with All
Dremel Accessories and
Attachments, Except MS400
and PL400 Attachments

**Replaceable
Motor Brushes**

For longer motor life.

**Ball Bearing
Universal Motor**Runs cool and smooth
under load.**200 SERIES KIT – MODEL 200-1/15****15 ASSORTED
ACCESSORIES**

- 194 High speed cutter
- 401 Mandrel
- 402 Mandrel
- 407 Coarse 1/2" sanding drum
- 408 Coarse 1/2" sanding band
- 420 HD emery cut-off wheel
- 421 Polishing compound
- 422 Felt buff cone
- 425 Emery wheel
- 426 Fiberglass cut-off wheel
- 429 Large felt wheel
- 432 Medium 1/2" sanding band
- 932 Aluminum oxide stone
- 8193 Aluminum oxide stone
- 83322 Silicon carbide stone

CONTENTS

- Two-Speed Rotary Tool
- Lawn Mower and Garden Tool Sharpener
- Corrugated Storage Case
- Product Reference Sheet
- Wrench

200 SERIES KIT – MODEL 200-1/21**21 ASSORTED
ACCESSORIES**

- 194 High speed cutter
- 401 Mandrel
- 402 Mandrel
- 407 Coarse 1/2" sanding drum
- 414 Small felt wheel (2)
- 415 Dressing stone
- 420 HD emery cut-off wheel
- 421 Polishing compound
- 425 Emery wheel (2)
- 426 Fiberglass cut-off wheel
- 429 Large felt wheel (2)
- 432 Medium 1/2" sanding band
- 445 Fine 1/2" sanding band
- 561 Multipurpose cutting bit
- 932 Aluminum oxide stone
- 8193 Aluminum oxide stone
- 83142 Silicon carbide stone
- 84922 Silicon carbide stone

CONTENTS

- Two-Speed Rotary Tool
- Cutting Guide
- Corrugated Storage Case
- Product Reference Sheet
- Wrench

DREMEL 100 SERIES**100 SERIES KIT – MODEL 100-N/7**

- Ideal for sanding, carving
and drilling.

2
YEARLimited
Warranty**7 ASSORTED
ACCESSORIES**

- 402 Mandrel
- 407 Coarse 1/2" sanding drum
- 415 Dressing stone
- 420 HD emery cut-off wheel
- 432 Medium 1/2" sanding band
- 932 Aluminum oxide stone
- 84922 Silicon carbide stone

CONTENTS

- Single-Speed Rotary Tool
- Product Reference Sheet
- Wrench

DREMEL® 10.8V CORDLESS

- Higher Speeds 5,000-35,000 RPM.** Corded performance in a cordless tool.
- Variable Speeds.** Handle a greater range of applications with more precision.
- Increased Versatility.** Over 150 attachments and accessories available.
- Soft Grip.** Designed for superior control and balance.
- Small and Lightweight.** For easier handling and less fatigue.
- Battery Fuel Gauge.** Know when it's time to recharge.
- High Capacity 10.8V Lithium-Ion Battery Pack.** For longer run-times.



2
YEAR
Limited
Warranty

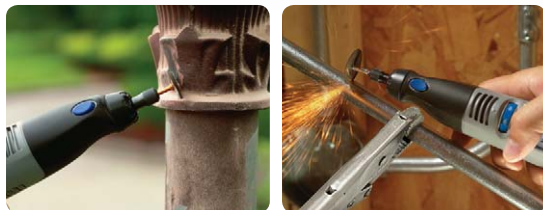

10.8V LITHIUM-ION CORDLESS ROTARY TOOL KIT – MODEL 8000-03



CONTENTS

- 10.8V Lithium-Ion Cordless Rotary Tool
- Compact Storage Case
- Battery Charger
- Wrench

40 ASSORTED ACCESSORIES

- | | | |
|---|---------------------------------------|---|
| 150 Drill bit | 409 Emery cut-off wheel (6) | 432 Medium 1/2" sanding band (3) |
| 401 Mandrel | 411 Coarse sanding discs (10) | 541 Aluminum oxide wheel |
| 402 Mandrel | 414 Small felt wheel (4) | 8193 Aluminum oxide stone |
| 191 High speed cutter | 420 HD emery cut-off wheel (2) | 84922 Silicon carbide stone |
| 407 Coarse 1/2" sanding drum | 425 Emery wheel (2) | |
| 408 Coarse 1/2" sanding band (4) | 429 Large felt wheel (3) | |



THE POWER AND FREEDOM TO TACKLE ANY PROJECT, ANYWHERE!



WHY LITHIUM-ION?

- More Power in a Smaller Size.** Lithium-Ion technology delivers more power in a smaller size and with less weight than conventional Ni-Cd batteries.
- Always Ready.** When in storage, battery holds a charge **6X** longer than standard Ni-Cd batteries.
- No Memory Effects.** Lithium-Ion batteries can be recharged at any time without reducing charge capacity or run time.

10.8V LITHIUM-ION CORDLESS ROTARY TOOL ACCESSORIES



**Lithium-Ion
Battery Pack –
Model 855-02**



**Lithium-Ion
Battery Charger –
Model 856-02**

7.2V TWO-SPEED CORDLESS KIT – MODEL 7700-1/15

- Two-speed 10,000 and 20,000 RPM.
- 7.2 volts of power. . . goes anywhere.

Motor: 7.2V DC (7.2 V)
Two-speed: 10,000/20,000 RPM
Weight with Battery: 12oz. (340g)

2
YEAR

Limited
Warranty

15 ASSORTED ACCESSORIES

- 191 High speed cutter
- 401 Mandrel
- 402 Mandrel
- 403 Bristle brush
- 407 Coarse 1/2" sanding drum
- 408 Coarse 1/2" sanding band
- 414 Small felt wheel
- 420 HD emery cut-off wheel
- 421 Polishing compound
- 430 Coarse 1/4" sanding drum
- 540 1-1/4" cut-off wheel
- 932 Aluminum oxide stone
- 952 Aluminum oxide stone
- 8193 Aluminum oxide stone
- 84922 Silicon carbide stone



CONTENTS

- 7.2 Two-Speed Cordless Rotary Tool
- 3-Hour Charger
- Lawn Mower and Garden Tool Sharpener
- Product Reference Sheet
- Corrugated Storage Case
- Accessory Organizer
- Wrench



Light and Compact. Easy to handle and fun to use — anywhere!

Removable battery pack. Continuous use to finish your projects.

Two Speeds. For better control and accuracy.

758-01 3-Hour Charger. Quick battery recharge with LED light. Light indicates battery is correctly placed into the charger for proper charging.



7700-02 ACCESSORIES



7.2V Battery Pack –
Model 757-01



3-Hour Battery
Charger – Model 758-01

MINIMITE® CORDLESS KIT – MODEL 750-02

Take it anywhere. 4.8 volts of power for light duty precision jobs.

Motor: 4.8V DC (4.8 V)
Two-speed: 6,500/13,000 RPM
Weight with Battery: 9oz. (255g)

2
YEAR

Limited
Warranty

5 ASSORTED ACCESSORIES

- 401 Mandrel
- 407 Coarse 1/2" sanding drum
- 414 Small felt wheel
- 432 Medium 1/2" sanding band
- 84922 Silicon carbide stone



CONTENTS

- 4.8 Two-Speed MINIMITE®
- 3-Hour Charger
- Wrench



Light and Compact. Easy to handle and fun to use — anywhere!

Removable Battery Pack. Continuous use to finish your projects.

Two Speeds. For better control and accuracy.

756-01 3-Hour Charger. Quick battery recharge with LED light. Light indicates battery is correctly placed into the charger for proper charging.



750-02 ACCESSORIES



4.8V Battery Pack –
Model 755-01



3-Hour Battery
Charger – Model 756-01

DREMEL[®] STYLUS[™]

C O R D L E S S

**Created to Fit Your Hand
and Your Lifestyle[™]**

- Always Ready
- Goes Everywhere

Finger-Tip On/Off Switch

For one-handed operation.

Unique Contoured Grip

Designed for superior precision, control, and comfort in your hand.

STYLUS KIT – MODEL 1100-N/25



CONTENTS

- Dremel Stylus Rotary Tool
- 7.2V Lithium-Ion Battery
- Charging Base and Accessory Organizer
- Accessory Case
- Product Reference Sheet
- Wrench

25 ASSORTED ACCESSORIES

- 105 Engraving cutter
- 107 Engraving cutter
- 191 High speed cutter
- 194 High speed cutter
- 401 Mandrel
- 402 Mandrel
- 403 Bristle brush
- 414 Small felt wheel (4)
- 421 Polishing compound
- 425 Emery wheel
- 429 Large felt wheel (3)
- 430 Coarse 1/4" sanding drum
- 431 Coarse 1/4" sanding band
- 438 Medium 1/4" sanding band (2)
- 446 Fine 1/4" sanding band
- 481 3/32" collet
- 512E Fine abrasive buff
- 932 Aluminum oxide stone
- 84922 Silicon carbide stone

Variable Speed 5,000 - 25,000 RPM

For precise control in a variety of materials and applications.

2
YEAR

Limited
Warranty



**Compact and
Ultra-Lightweight**

Shaft Lock

For quick accessory changes.

Rechargeable 7.2V Lithium-ion Battery

Holds a charge 2 years while in storage.

Docking Station Continually Charges

So the tool is always fully charged and ready to use.

Premium Accessories

Specifically for intricate work.



POWERED BY
LITHIUM-ION
TECHNOLOGY

WHY LITHIUM-ION?

More Power in a Smaller Size. Lithium-Ion technology delivers more power in a smaller size and with less weight than conventional Ni-Cd batteries.

Always Ready. When in storage, battery holds a charge **6X** longer than standard Ni-Cd batteries.

No Memory Effects. Lithium-Ion batteries can be recharged at any time without reducing charge capacity or run time.





TOOL MODEL NUMBER	ATTACHMENT COMPATIBILITY KEY																				
	ATTACHMENT MODEL NUMBER																				
	220	225	231	335	365	366	368	575	A576	A577	670	675	677	678-01	A679	1453	2222	2300-01	MS-400	PL-400	
4000
400
300
398
395
200
100
800
770
750
1100

Use this chart to find out which attachments work with your tool, or use the mini charts included with the attachments' descriptions. Adapters may be needed.

MULTISAW – MODEL MS400

4000	400	300	398	395	200	100	800	780	770	750
.	.									

Goes where ordinary saws can't. Like having a jig saw, reciprocating saw, and scroll saw in one compact attachment.

- Universal blade holder uses standard "U" and "T" shank jigsaw blades.
- 3/8" blade stroke for fast and controlled scroll and straight line cutting.
- Pivot foot provides easier control in a variety of materials and shapes.
- Includes one wood cutting blade for straight and curved cutting.
- For use with the 400 Series and Dremel 4000 Rotary Tools.



PLANER – MODEL PL400

4000	400	300	398	395	200	100	800	780	770	750
.	.									

Refinish furniture, fix stuck doors and cabinets, chamfer sharp edges, fit wood flooring and more.

- High speed steel, precision-ground blade lasts up to 500 linear feet.
- 2-1/4" planing width removes approximately 1/64" with each pass.
- Features a 90 and 45 degree edge guide.
- For use with the 400 Series and Dremel 4000 Rotary Tools.



DREMEL WORK STATION™ – MODEL 220-01

4000	400	300	398	395	200	100	800	780	770	750
.

Functions as an articulating drill press that rotates 90°, rotary tool holder, and flex-shaft tool stand.

- Detents click the tool in place in 15° increments from vertical to horizontal.
- "Crow's Nest" provides on-board storage for Dremel accessories.
- Durable, die-cast aluminum base.



FLEX SHAFT ATTACHMENT – MODEL 225-01

4000	400	300	398	395	200	100	800	780	770	750
.

Ideal for hard to reach places and fine detail work.

- Quick connect attach system.
- 36" long cable with new 5" bend radius provides more flexibility.
- Comfort grip hand piece.
- Integrated shaft lock button.
- Holds up to 1/8" shank.
- Works with collet system and Dremel chuck.



SHAPER/ROUTER TABLE – MODEL 231

4000	400	300	398	395	200	100	800	780	770	750
.

Converts your corded Rotary Tool into a bench mounted wood shaper.

- Features an adjustable fence and large 8" x 6" worktable.
- Slot, groove, sand and trim edges.



PLUNGE ROUTER ATTACHMENT – MODEL 335-01

4000	400	300	398	395	200	100	800	780	770	750
.

Converts your corded Rotary Tool into a plunge router.

- Clear base.
- Two depth stops.
- Includes edge guide and circle guide.
- Rout circles, parallel to edge, signs and inlay work and decorative edges.



TOOLS NOT INCLUDED WITH ATTACHMENTS

MULTIPURPOSE CUTTING KIT – MODEL 565

	4000	400	300	398	395	200	100	800	780	770	750
	•	•	•	•	•	•	•	•	•	•	•

- Allows for sturdy controlled cuts with maximum visibility.
- Easy depth adjustment. Set to the correct cutting depth for the material you are working on.
- Includes cutting guide, 2 drywall cutting bits for cutting drywall for electrical boxes & air vents.
- Includes 1 multipurpose cutting bit for making cuts in ceiling tile, wood, plastic, fiberglass, drywall, laminate and vinyl siding.



TILE CUTTING KIT – MODEL 566

	4000	400	300	398	395	200	100	800	780	770	750
	•	•	•	•	•	•	•	•	•	•	•

- Allows for sturdy controlled cuts with maximum visibility.
- Easy depth adjustment. Set to the correct cutting depth for the material you are working on.
- Includes cutting guide and tile cutting bit.
- Shape ceramic wall tile around fixtures or plumbing pipes.



Not for use on ceramic floor tile.

GROUT REMOVAL ATTACHMENT – MODEL 568

	4000	400	300	398	395	200	100	800	780	770	750
	•	•	•	•	•	•	•	•	•	•	•

For use on wall and floor grout!

- Multiple slide depth adjustment.
- 30° angle for controlled cutting.
- Guides 180° apart to keep bit centered between tiles.
- Easy screw-on mounting.
- Excellent cutting visibility.
- Includes 1/16" Grout Removal Bit – Model 569. Made of solid carbide, the bit will remove both wall and floor grout.



570

- Also available: Model 570 1/8" Grout Removal Bit (Not included with 568).

RIGHT ANGLE ATTACHMENT – MODEL 575

	4000	400	300	398	395	200	100	800	780	770	750
	•	•	•	•	•	•	•	•	•	•	•

Enhances the versatility of your Dremel Rotary Tool by allowing you to get into hard-to-reach areas.

- Quick connect system easily attaches to your rotary tool in place of the housing cap, no wrenches required.
- Compact, durable design for those "hard-to-reach" places.



MINI SAW ATTACHMENT – MODEL 670

	4000	400	300	398	395	200	100	800	780	770	750
	•	•	•	•	•	•	•	•	•	•	•

Works great on wood and all wood-like materials.

- Quick connect system attaches to your rotary tool in seconds.
- Make clean, straight perpendicular cuts up to 1/4" thick.
- Includes blade.



RIP/CROSSCUT BLADE – MODEL 546

- Long-lasting steel blade.
- 1-1/4" diameter, 48 teeth.
- One blade per package.
- For use with Mini Saw Attachment only.



LAWN MOWER AND GARDEN TOOL SHARPENER – MODEL 675

	4000	400	300	398	395	200	100	800	780	770	750
	•	•	•	•	•	•	•	•	•	•	•

The fastest, easiest, safest way to sharpen your lawn mower blade and other garden tools.

- Guide provides optimum sharpening angle.
- Sharpens most rotary lawn mower blades.
- Long-wearing ABS plastic material.
- Includes grinding stone, #932 (see p.30).



CIRCLE CUTTER AND STRAIGHT EDGE GUIDE – MODEL 678-01

	4000	400	300	398	395	200	100	800	780	770	750
	•	•	•	•	•	•	•	•	•	•	•

The simple way to cut circular holes in many types of materials. Convenient measurement guides in both inches and centimeters, so you can cut out the right-sized circle every time.

- Makes circles from 3/4" -12" (1.9-30 cm).
- Attaches quickly and easily without tools.
- Depth adjustment allows easy setting of the correct cutting depth.
- Straight Edge Guide allows routing or cutting in a straight line.
- Includes 1/16" Multipurpose Cutting Bit – Model 561 (see p. 33).



561

LAWN MOWER, GARDEN TOOL & CHAIN SAW SHARPENING KIT – MODEL A679

	4000	400	300	398	395	200	100	800	780	770	750
	•	•	•	•	•	•	•	•	•	•	•

The Dremel chain saw sharpening attachment as well as the Dremel lawn mower and garden tool sharpening attachment are included together in one kit for your convenience.

- Guide provides optimum sharpening angle.
- Sharpens most rotary lawn mower blades.
- Easily sharpen the dullest of chains.



CONTENTS

- Lawn Mower and Garden Tool Sharpening Attachment
- Chain Saw Sharpening Attachment
- Gauge
- 4 Sharpening Stones Nos. 453, 454, 455, (see p. 29) and 932 (see p. 30)
- 2 Spacers
- Wrench
- Instruction Manual

CHAIN SAW SHARPENING ATTACHMENT – MODEL 1453

	4000	400	300	398	395	200	100	800	780	770	750
	•	•	•	•	•	•	•	•	•	•	•

- Easily sharpen the dullest of chains.

CONTENTS

- Sharpening Attachment
- 3 Sharpening Stones Nos. 453, 454 and 455 (see p. 29)
- Gauge
- 2 Spacers
- Wrench
- Instruction Manual



MULTI-VISE™ – MODEL 2500-01

	4000	400	300	398	395	200	100	800	780	770	750
	•	•	•	•	•	•	•	•	•	•	•

Gets a Grip on Anything, Anywhere!

- Portable vise holds work piece for projects such as woodworking, home projects, crafts and hobbies.
- Clamps to any work surface up to 2-1/2" thick.
- Rotates 360° and tilts 50° allowing user to lock the workpiece in any position.
- Tool holder turns Dremel Rotary Tools into a stationary sander, grinder or polisher.
- Removable clamping jaws creates a stand-alone bar clamp.



CARVING - SOFT MATERIALS



HIGH SPEED CUTTERS High speed cutters can be used for shaping, hollowing, grooving, slotting, making tapered holes in soft metals, plastics and woods. No. 199 cutter can be used to make small slits.

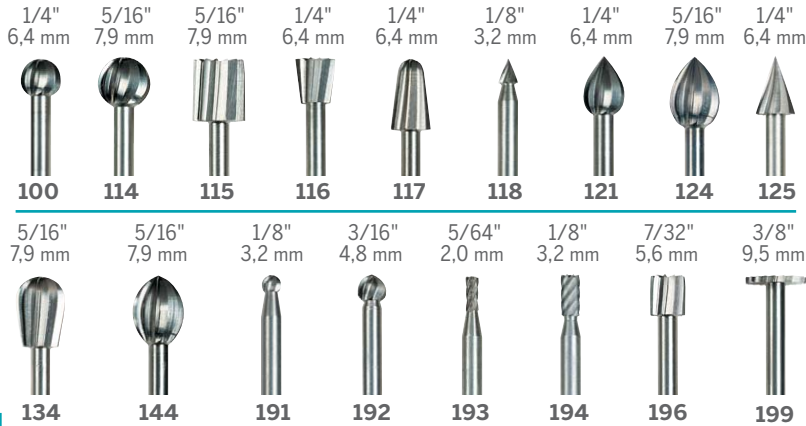
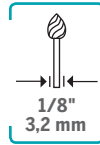

STRUCTURED TOOTH TUNGSTEN CARBIDE CUTTERS

Fast-cutting sharp teeth for greater material removal. Use on fiberglass, wood, plastic, epoxy, rubber, laminates, particle board and ceramic tile.

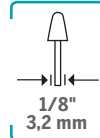

CARVING - HARD MATERIALS

TUNGSTEN CARBIDE CUTTERS Use for shaping, smoothing and material removal. Use on hardened steel, stainless steel, cast iron, nonferrous metals, fired ceramics, plastics, hardwoods and other hard materials. Not for use with floor tile.

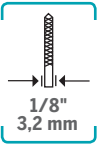

ENGRAVING - SOFT MATERIALS



ENGRAVING CUTTERS Quality cutters for detail engraving, carving, routing in wood, fiberglass, plastic and soft metals.

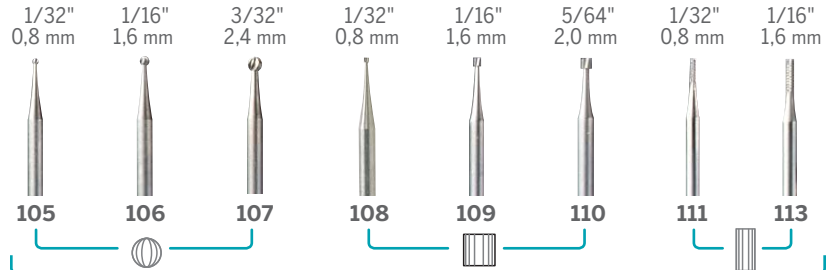
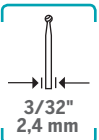

ENGRAVING - HARD MATERIALS

DIAMOND WHEEL POINTS For fine detail work, engraving, carving, touch-up and finishing. Use on wood, jade, ceramic, glass, hardened steel, semi precious stones and other hard materials. Bits are covered with diamond particles.



7150 – Dual Package which includes 1 ea. 7103 and 7144.

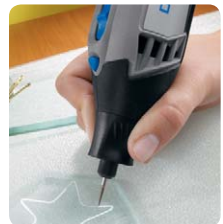

ROUTING

ROUTER BITS For routing, inlaying, and mortising in wood and other soft materials. Use with Dremel No. 330 Router Attachment, No. 335 Plunge Router Attachment, and No. 231 Shaper/Router Table. Made of high speed steel.



3/32"
2,4 mm
Piloted
Beading



612



1/8"
3,2 mm
Corner
Rounding



615



1/4"
6,4 mm
Core Box



617



1/2"
12,7 mm
Chamfer



618



1/4"
6,4 mm
V-Groove



640



1/8"
3,2 mm
Straight



650



3/16"
4,8 mm
Straight



652



1/4"
6,4 mm
Straight



654



5/16"
7,9 mm
Keyhole



655



GRINDING/SHARPENING - FERROUS MATERIALS

CHAIN SAW SHARPENING STONES Precision-ground for quick, easy sharpening of chain saw blades. Each package contains 2 stones.



5/32"
4,0 mm



453

3/16"
4,8 mm



454

7/32"
5,6 mm



455

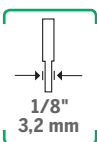

ALUMINUM OXIDE ABRASIVE WHEEL Perfect for cleaning, de-burring, removing rust, and polishing of most metals, including stainless steel.



500

1"
25,4 mm

Medium

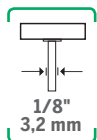

ALUMINUM OXIDE ABRASIVE POINT Abrasive point is great for finishing work and light de-burring. It can be used for paint and rust removal without removing any of the base material.

1/2"
12,7 mm



516

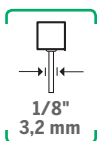

ALUMINUM OXIDE GRINDING WHEEL Use for de-burring, rust removal and general purpose grinding.



541

2 Per Pack

Use with Mandrel 402.

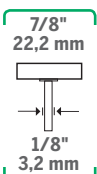

GRINDING/SHARPENING - FERROUS MATERIALS

ALUMINIUM OXIDE GRINDING STONES (ORANGE/BROWN)

Use on metals, castings, welded joints, rivets and rust. Ideal for sharpening, de-burring and general purpose grinding of most materials.

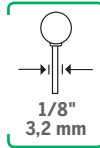

7/16" 11,1 mm 3/8" 9,5 mm 5/8" 15,9 mm 3/16" 4,8 mm 3/8" 9,5 mm



911 932 941 945 952



1/4" 6,4 mm 5/8" 15,9 mm 1/8" 3,2 mm 3/16" 4,8 mm 3/8" 9,5 mm 5/8" 15,9 mm 1" 25,4 mm

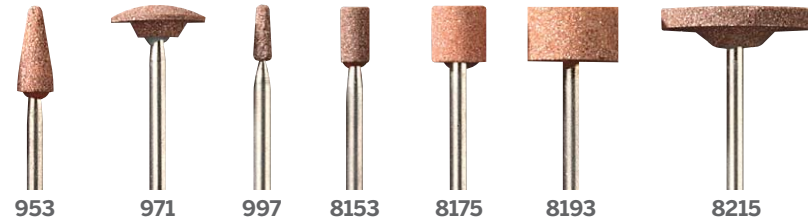

953 971 997 8153 8175 8193 8215

GRINDING/SHARPENING - NON-FERROUS MATERIALS

SILICON CARBIDE GRINDING STONES (BLUE/GREEN)

Designed to work well on stone, glass, ceramics, porcelain and non-ferrous metals.

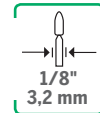

9/32" 7,1 mm 1/8" 3,2 mm 1/8" 3,2 mm 3/16" 4,8 mm 25/32" 19,8 mm 13/32" 10,3 mm 1/2" 12,7 mm



83142 83322 83702 84922 85422 85602 85622

CUTTING

EZ Lock™ STARTER KIT – MODEL EZ406

- Includes 1 EZ Lock™ mandrel and 5 reinforced cut-off wheels.



Faster Accessory Changes – Easy as 1, 2, 3

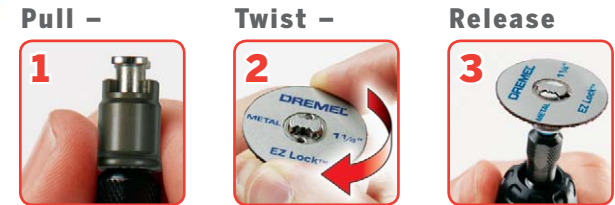

EZ Lock™ 1-1/2" THIN REINFORCED CUT-OFF WHEEL – EZ409
For use with EZ Lock™. Reinforced cut-off wheels for cutting metal. 2X more cuts compared with 409. 5pc.



EZ Lock™ 1-1/2" REINFORCED CUT-OFF WHEEL – EZ456 For use with EZ Lock™. Reinforced cut-off wheels for cutting metal. 2X more cuts compared with 426. 5pc.



EZ Lock™ 1-1/2" REINFORCED CUT-OFF WHEEL BULK PACK – EZ456B For use with EZ Lock™. Reinforced cut-off wheels for cutting metal. 12pc. Bulk pack.



EZ Lock™ 1-1/2" REINFORCED CUT-OFF WHEEL – EZ476 For use with EZ Lock™. Reinforced cut-off wheel makes clean cuts in plastic. 5pc.



CUTTING - METAL [Limited use on wood and plastic]

CUT-OFF WHEELS For slicing and cutting metal, wood and plastic. Cut-off wheels make it easy to cut or slot bolts, screws, sheet metal, thin wood and plastic. The cut-off wheel cuts only along its edge. Do not attempt to sand or cut curved holes with them.

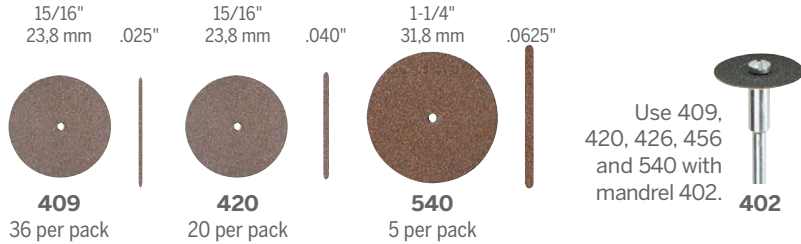

FIBERGLASS REINFORCED CUT-OFF WHEELS



456 package includes 10 cut-off wheels and a washer set. Mandrel 402 is sold separately. *Washer set only used with 456.

CUTTING - WOOD



CUTTING/SHAPING WHEEL - 543 (CARBIDE) For cutting and shaping on soft and hard woods, fiberglass, plastics and laminates. Do not use on metal. Mandrel included. Thickness .070" (1.8 mm).



EZ Lock™ 1-1/2" CUTTING/SHAPING WHEEL - EZ544 For use with EZ Lock™.

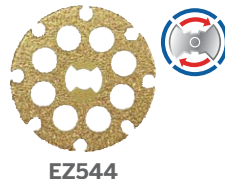

CUTTING - WOOD (Continued)



RIP/CROSSCUT BLADE - 546 For use with Mini Saw Attachment 670 only (page 23). Thickness .023" (0,6 mm).



CUTTING - HARD MATERIALS

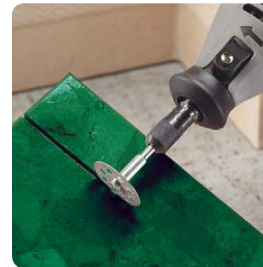

DIAMOND WHEEL - 545 Great for cutting, sawing and carving of hard materials such as marble, concrete, brick, porcelain, ceramics, hard epoxy, soft and hard wood. Mandrel 402 is included. Thickness .023" (0,6 mm). Do not run in excess of 20,000 RPM.

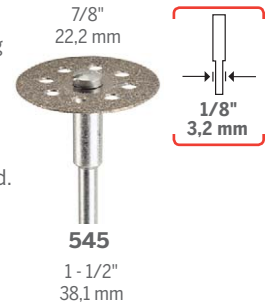

EZ Lock™ 1-1/2" DIAMOND WHEEL - EZ545 For use with EZ Lock™. Diamond cutting wheel makes clean cuts in hard materials.

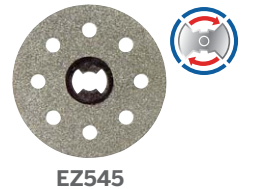

DRYWALL, MULTIPURPOSE, TILE AND GROUT ACCESSORIES

DRYWALL CUTTING BIT - 560* Gives you fast clean cuts in drywall.

MULTIPURPOSE CUTTING BIT - 561* Cuts hardwood up to 3/8" and softwood up to 5/8". Also cuts plastic, fiberglass, drywall, laminate, aluminum & vinyl siding.

TILE CUTTING BIT - 562* Cuts ceramic wall tile, cement board, and plaster. (Not for use on floor tile.)

CARBIDE GROUT REMOVAL BITS - 569 AND 570† Ideal for replacing wall and floor grout or removing grout to replace broken tiles.

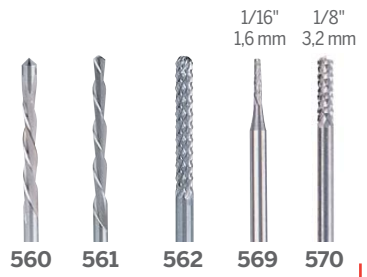

* Use with cutting guide (page 22).

† Use with grout removal guide (page 22).

CLEANING/POLISHING

POLISHING ACCESSORIES Ideal for polishing metals and plastics. Using polishing compound No. 421 with wheels produces a high luster.

Felt 1/2" dia.
6 per pack



414

Felt 3/8" dia.



422

Felt 1" dia.



429



401

Use 414, 422 and 429 with Mandrel 401.

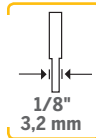

POLISHING CLOTH Made to take a smooth finish and polish it to a high luster.

Cloth 1" dia.



423E



EZ Lock™ COMPATIBLE



EZ402

402

Use with either EZ402, or with 402. Mandrels sold separately.

POLISHING COMPOUND – 421

Use with felt or cloth accessories to polish metals and plastics. Compound will remove a dull oxidized film and/or light surface imperfections. A solid compound.



RUBBER POLISHING POINTS Blue points for finishing and polishing all ferrous metals. Removes small burrs and scratch marks left by grinding and sanding, and cleans and defines grooves. Also effective on many stones and ceramics.

1/4" dia.
6,4 mm



461

1/4" dia.
6,4 mm



462

1/4" dia.
6,4 mm



463

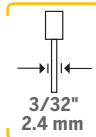

EMERY IMPREGNATED POLISHING WHEEL

Ideal for general polishing of most ferrous metal, stone, glass and ceramic. Use 425 with mandrel 402.



425



402



ABRASIVE BRUSH – 538

Dremel's strongest and longest lasting brush. Extra-thick nylon bristles are coated with an abrasive grit for material removal on the toughest jobs. Use for de-burring metal or wood and for removing rust and paint.

Do not run brush in excess of 20,000 RPM.



1" dia.
25,4 mm

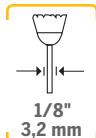

1/8" dia.
3,2 mm

538



POLISHING WHEEL – 520

Use for light stock removal and high luster polishing of metals and hard plastics. The wheel is impregnated with a silicon carbide abrasive and lubricant, eliminating the need for polishing compound.

1/2" dia.
12,7 mm



520

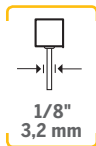

1/8" dia.
3,2 mm



3/4" dia.
19,1 mm

403

1/2" dia.
12,7 mm



404

1/8" dia.
3,2 mm



405

BRISTLE BRUSHES

Use for light de-burring, cleaning, polishing of silverware, jewelry and other precious metals; can use with polishing compound.

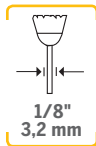

1/8" dia.
3,2 mm



3/4" dia.
19,1 mm



428

1/2" dia.
12,7 mm



442

1/8" dia.
3,2 mm



443

CARBON STEEL BRUSHES

Versatile brush for removing rust and corrosion, polish metal surfaces. De-burr and blend surface junctures, clean electrical components.

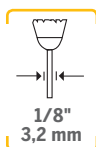

1/8" dia.
3,2 mm



3/4" dia.
19,1 mm



530

1/2" dia.
12,7 mm



531

1/8" dia.
3,2 mm



532

STAINLESS STEEL BRUSHES

Stainless steel brushes do not cause "after-rust" when used on corrosive-resistant materials like pewter, aluminum and stainless steel.

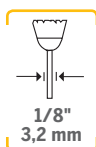

1/8" dia.
3,2 mm



3/4" dia.
19,1 mm



535

1/2" dia.
12,7 mm



536

1/8" dia.
3,2 mm



537

BRASS BRUSHES

Brass brushes are non-sparking and softer than steel. They will not scratch soft metals like gold, copper, brass.

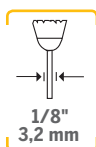

1/8" dia.
3,2 mm

Do not run brushes in excess of 15,000 RPM.

SANDING



New!

DETAIL ABRASIVE BRUSHES

Great for detail cleaning and light sanding. Use on metal, glass, wood, aluminum and plastics. Not to be used in excess of 15,000 RPM.

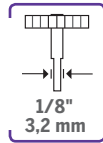

EZ471SA 36 Grit Coarse
EZ472SA 120 Grit Medium
EZ473SA 220 Grit Fine



EZ402 **402**
EZ LockTM
COMPATIBLE



Use with either EZ402, or 402. Mandrels sold separately.



FINISHING ABRASIVE BUFFS

Great for cleaning and light sanding. Use on metal, glass, wood, aluminum and plastics. The 512 fine-grit buff is particularly ideal for removing tarnish from brass. Not to be used in excess of 15,000 RPM.

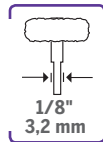

511E 180 Grit Coarse
512E 280 Grit Medium
512E 320 Grit Fine



EZ402 **402**
EZ LockTM
COMPATIBLE



Use 511E and 512E with either EZ402, or 402. Mandrels sold separately.



FLAPWHEELS

Flapwheels grind and polish flat or contoured surfaces. They are used most effectively as a finishing sander after heavier surface sanding and material removal is completed.

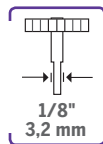

SANDING BANDS For rough shaping and smoothing wood and fiberglass; removing rust from metal surfaces; shaping rubber surfaces. Sander bands are easily replaceable on drums, and are available in packages of 6 each.

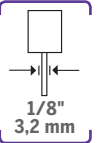

SANDING DISCS For rough shaping and smoothing wood and fiberglass; removing rust from metal surfaces; shaping rubber surfaces. 36 pieces per pack.

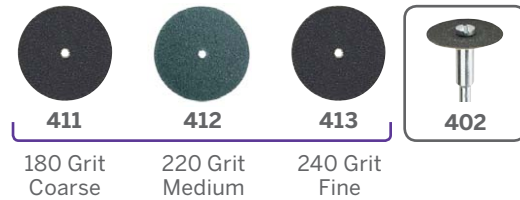
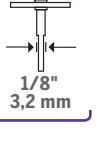

Use 411, 412 and 413 with mandrel 402.

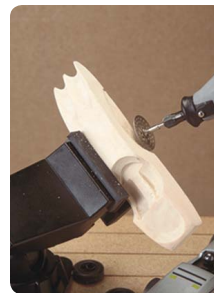

CARBIDE SHAPING WHEEL

A powerful shaping tool that quickly and efficiently removes material. Easily creates compound curves and works on a variety of materials including woods, fiberglass, laminates, plastic, and leather. Mandrel included.

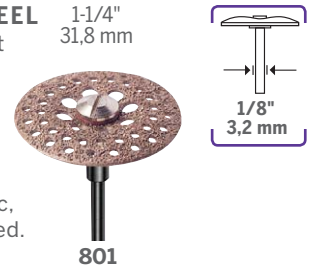

CARBIDE SANDING BAND

The carbide grit surface is extremely durable and the edges of the band will stay crisp and sharp. Use on a variety of materials including woods, fiberglass, laminates, plastic, and leather. Drum sander mandrel included. 80 Grit.

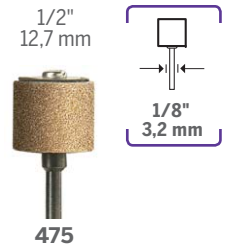

MISCELLANEOUS

MANDRELS



EZ Lock™ EZ402 – Use with EZ409, EZ544, EZ545, EZ456, EZ471SA, EZ472SA, EZ473SA, EZ476, 423E, 511E, and 512E.



401 – Use with 414 and 422. May be used with 429.



402 – Use with 409, 411, 412, 413, 420, 423E, 425, 426, 429, 456, EZ471SA, EZ472SA, EZ473SA, 511E, 512E, 540, and 541.

DREMEL CHUCK – 4486 This chuck allows you to quickly and easily change accessories on Dremel Rotary Tools without changing collets. Accepts accessories with 1/32" - 1/8" shanks. Use with rotary tool models 275, 285, 300, 395, 398, 400, 4000, 750, 770, 780, and 800. Also use with Dremel attachments 212, 225, 575, and 961.



QUICK CHANGE COLLET NUT SET – MODEL 4485

Includes Collet Nut and 4 Collets. For use with all Rotary Tools except models 1, 2 & 260, 270, 280 series 1 or earlier.

Collets also available separately.

1/8" 3,2 mm 3/32" 2,4 mm 1/16" 1,6 mm 1/32" 0,8 mm



480 481 482 483

DRILL BIT SET – MODEL 628



1/8-IN. DRILL – MODEL 150*



1/32-IN. DRILL – MODEL 660
4 pc. per pack. Use with 483 Collet.



3/64-IN. DRILL – MODEL 661
4 pc. per pack. Use with 482 Collet.

BRAD POINT DRILL BIT SET – MODEL 631-01

Titanium coated brad points stay on center and begin drilling immediately. For use on wood.



*Available as service part only.

WRENCH – 90962

For ease of changing bits.



DRESSING STONE – 415*

Clean grinding wheels. Shape or reshape for desired applications.



*Available as service part only.

MINI ACCESSORY KITS

- New reusable storage box
- Application and material usage information included
- XPR™ storage case compatible
- Removable organizer tray



CLEANING/POLISHING KIT – MODEL 684-01

Polish a variety of materials to a high luster, clean those tough-to-reach areas, plus a whole lot more!



SANDING/GRINDING KIT – MODEL 686-01

Sharpen lawn tools, remove rust, sand down a sticking door, and engrave on glass, plus a whole lot more!

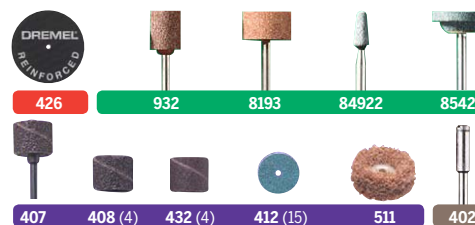

CARBON MOTOR BRUSHES

BRUSH	TOOLS	TYPE
90826*	260	
90827*	270, 280, 370 & 380	
90828*	232 & 332	
90929*	275, 285 & 395	1 & 2
90930	275, 285, 300, 395 & 595	3,4,5 & 6
90930	6000	1 & 2
90931	398	
90935	732	
90936	Advantage 9000	
90937	400 XPR™	

MINI ACCESSORY KITS

GENERAL PURPOSE KIT – MODEL 687-01

Everything you need to cut, carve, sand, grind, clean, and polish, plus a whole lot more!



ROUTER BIT KIT – MODEL 692

For routing, inlaying and mortising in wood and other soft materials. Use with #330 Router Attachment, #335 Plunge Router Attachment, and #231 Shaper/Router Table.



CUTTING KIT – MODEL 688-01

Reslot a screw, cut conduit, sheet metal, rusted hose clamps, plus a whole lot more!

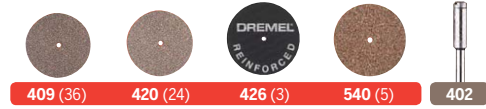

SUPER ACCESSORY KIT – MODEL 697-06

This versatile and re-usable accessory kit includes everything you need to cut, grind, sand, polish, drill, sharpen, clean and more.



EZ LOCK™ CUTTING KIT – MODEL EZ688-01

Reslot a screw, cut conduit, sheet metal, rusted hose clamps, plus a whole lot more!



185 PIECE ACCESSORY KIT – MODEL 700-03

This versatile and re-usable accessory kit includes everything you need to cut, grind, sand, polish, drill, sharpen, clean and more. Features a convenient, foldable storage bag and mini kit.



CARVING/ENGRAVING KIT – MODEL 689-01

Sharpen lawn tools, remove rust, sand down a sticking door, and engrave on glass, plus a whole lot more!

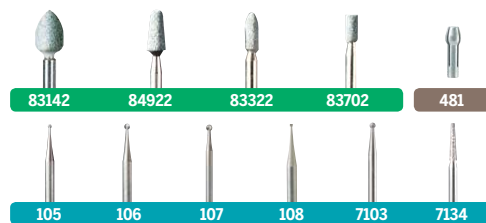

DREMEL® MULTI-MAX™

Oscillating Tool System

Repair. Remodel. Restore.

The new Dremel® Multi-Max™ Oscillating Tool System offers remodeling enthusiasts a versatile and effective multitasking tool. With fast side-to-side motion, the Multi-Max can take on a variety of projects that involve repair, remodeling or restoration.

2
YEAR
Limited
Warranty

Variable Speed 10,000-21,000 Oscillations Per Minute (OPM)

For a variety of applications.

Soft-Start Feature

Provides smooth starts.

Separate On/Off Switch

Maintains a previously selected speed setting.

Powerful 1.5 Amp Motor

To help cut through tougher materials.

Electronic Feedback Circuitry

Provides consistent tool speed through even tough applications.

Ergonomic Grip

Allows for comfort and control.

Compact Design

Provides access in tight areas.



MULTI-MAX™ TOOL - MODEL 6300-05



CONTENTS

- Dremel Multi-Max Oscillating Tool
- 3 Sanding Sheets
- 3/4" Wood Flush Cut Blade
- 3" Wood & Drywall Saw Blade
- Hook & Loop Pad
- Carry Case
- Manual



Quick Fit™ Accessory Change System

Provides accessory changes twice as fast as similar oscillating tool systems.



DREMEL® MULTI-MAX™

Oscillating Tool System

SANDING

Restore windows, make stuck doors work, and remove rust from metal. Available in assorted grit for sanding bare or painted wood and metal.



Hook & Loop Pad



MM11

Sanding Sheets - Paint

6 per pack:
80(2), 120(2),
240(2) Grit



MM70P

Sanding Sheets - Wood

18 per pack:
80(6), 120(6),
240(6) Grit



MM80P

6 per pack:
60(2), 120(2),
240(2) Grit



MM70W

18 per pack:
60(6), 120(6),
240(6) Grit



MM80W

SCRAPING

Use the rigid scraper blade for removing stuck vinyl flooring, carpeting and carpet pad, and the flexible scraper blade for projects such as removing old caulking around the tub or shower.



Rigid
Scraper Blade



MM600

Flexible
Scraper Blade



MM610

GROUT REMOVAL

Remove wall and floor grout to free a broken tile. Available in a 1/8" size and a 1/16" size.



1/8" Grout
Removal Blade



MM500

1/16" Grout
Removal Blade



MM501

CUTTING



Flush cut a baseboard to install new flooring or cut out drywall to install a new light switch. Choose from four blades to accomplish a variety of tough cuts.

3/8"
Wood
Flush
Cut Blade



MM411

3/4" Wood & Metal
Flush Cut Blade
(also great for
cutting plastics)



MM422

3/4"
Wood
Flush
Cut Blade



MM440

3" Wood
& Drywall
Saw
Blade



MM450

New!



MM462

1-1/8" Hard
Wood Flush
Cut Blade



MM463

Bulk Packs - 3 per pack



MM422B

MM440B

MM450B

3-Pack Cutting Assortment
(MM440, MM450, MM422)



MM491

GRINDING

When replacing ceramic floor tile, remove cement residue from subfloor quickly and efficiently using the 60 grit diamond sanding paper. Also great for removing grout adhesive, thin set or mortar.



60 Grit
Diamond Paper



MM900

Carbide
Rasp



New!

MM920

DREMEL® GLUE GUN



GLUE GUN KIT – MODEL 1200-01

CONTENTS

- 80 watt Glue Gun
- Three Interchangeable Nozzles (1 Fine, 1 Standard, 1 Wide)
- Six Dual-Temperature 11 mm Glue Sticks
- Instructions

GLUE GUN KIT – MODEL 1200-02

CONTENTS

- 80 watt Glue Gun
- Three Interchangeable Nozzles (1 Fine, 1 Standard, 1 Wide)
- Six Dual-Temperature 11 mm Glue Sticks
- Carrying Bag
- Instructions



GLUE GUN – MODEL 1200

2
YEAR

Limited
Warranty



Separate on/off switch to turn off glue gun without unplugging.

Dual temperature settings for use with all glue sticks between .44" and .45" diameter.

Green and Red LED lights indicate "on" and "ready" positions.

Anti-drip nozzle reduces glue drip for a cleaner and safer work area.

One-touch kickstand provides stable placement at the touch of a button.

Operating Temp: 380°F High, 250°F Low
Volts: 110-120V, AC
Watts: 80 W
Tool Length: 8-3/4"

Broad base for optimal stability.

Built-in worklight illuminates work area.

Comfort-grip handle and extended trigger allow for continual use without fatigue.

ACCESSORIES:



Fine Nozzle



Standard Nozzle



Wide Nozzle

VERSATIP™ MULTIPURPOSE TOOL – MODEL 1550

Multipurpose tool for wood burning, soldering, hot knife cutting of styrofoam and plastics, cutting and fusing rope.

CONTENTS

- VersaTip™ Tool
- 5 Tips (470, 471, 473, 474 & 499)
- Tool Stand
- Handy Tip Storage Tube



2
YEAR

Limited
Warranty

Max. Tip Temp: 1,050° F (565° C)

Volts: 110-120V, AC

Watts: 30

Tool Length: 7-3/8" (187,3 mm)

Maximum tip temperature 1,050° F. Safely burn faster and darker.

6 Different design tips. Replaceable and interchangeable for maximum versatility.

Short shaft length. Excellent control of tip.

Ergonomic, stay cool design. Maximum user comfort and control.

Versatile tool stand. Convenient for storage and protects work surface.



ACCESSORIES*:



Soldering Tip –
Model 470



General Purpose Tip –
Model 471



Script Tip –
Model 473



Fine Cutting Tip –
Model 474



Hot Knife Tip –
Model 499

*Available only through Service Center.

ENGRAVER – MODEL 290-01

Identify and personalize your valuables. Use for decorative engraving.

- Engraves metal, glass, wood, plastic, and ceramics.
- Holding area allows for extended use.
- Soft grip adds extra comfort and control.

CONTENTS

- Engraver Tool
- Carbide Point (9924)
- Letter / Number Template

2
YEAR

Limited
Warranty



Motor: 115V, AC/115V, 60Hz,
.2 amps/0,2 A

Strokes: 7,200/SPM

Tool Weight: 12 oz. (340 g)



Light and compact design. Comfortable use for precision engraving performance.



Stroke adjustment dial. Regulates engraving depth from fine lines to deep grooves.



Replaceable carbide and diamond points. Engrave on soft or hard materials.

ACCESSORIES:



Carbide Point – Model 9924
(normal applications)



Diamond Point – Model 9929
(for continuous use)