



**C.H.
HANSON**[®]
Since 1866 • Tools for Generations™



MARKING | HAND AND LAYOUT TOOLS | TAPE AND SAFETY

Promising Focus On YOU, Our Customer, In Today's Busy World

After 150+ years, I can say our company has changed a lot since it was founded by my great grandfather, Christian Henry Hanson, in 1866. We have grown out of several facilities and introduced thousands of new products; but one thing that has never wavered is our commitment to the customer. We work each day to Glorify God by delivering on our promise to help you succeed.



We strive to be...

INNOVATIVE

Always improving, always creating

AVAILABLE

Get what you need, when you need it

ECONOMICAL

High performance at the most competitive price

TRUSTWORTHY

Always doing the right thing

Your partners at C.H. Hanson will continue to bring you solutions that support your business today and well into the future!

Blessings,

A handwritten signature in black ink, appearing to read "Phil Hanson".

Phil Hanson

President, C.H. Hanson



TABLE OF CONTENTS

MARKING

Hansco-Mark.....	6
Metal Tags	12
Steel Stamps	22
Commercial Stencils.....	30
Interlocking Brass Stencils	35
Pencils, Crayons, Markers	40

HAND AND LAYOUT TOOLS

Heritage Spring and Wood Clamps.....	44
Manual Locking Pliers and Clamps.....	48
Shims	50
Layout Tools.....	51
Masonry Line.....	53

TAPE/SAFETY

Barricade Tape.....	54
Safety Tape	57
Flagging Tape	57
Aisle Tape	58
Stake Flags.....	59
Safety Accessories	61

p: 800-827-3398
 f: 800-827-5834
 sales@chhanson.com





C.H.HANSON

PALMGREN

PALMGREN
Model No. 10000
Made in Taiwan



PALMGREN...

A NEW FAMILY OF PRODUCTS FROM A NAME YOU CAN TRUST

We manufacture and market the best vises, machine tool accessories and metalworking machine tools under our Palmgren brand name. You get the highest quality products that deliver consistent performance, friendly and efficient service and unmatched technical support. Check out our full offering at www.palmgren.com.

- ABRASIVE FINISHING MACHINES
- SAWS
- LATHES
- MILLING MACHINES
- TAPPING MACHINES
- DRILL PRESSES
- VISES
- BENCH PRESSES AND STANDS
- CLAMPS

PALMGREN®
a CH Hanson brand



Hansco-Mark™

The Machine for Your Marking and ID Needs

Marking Features:

- **Serialization**
- **Date/Time/Shift**
- **Graphics/Logos**
- **Dot or Line Fonts**
- **2-D Data Matrix**
- **Angular Text Mode**



**C.H.
HANSON®**
Since 1866 • Tools for Generations™





Hansco-Mark™ Permanent Micro-Percussion Marking Machine

Model No.	MP150i
Hanson Item No.	20000
Weight	78.3 lbs.

EVERY MP150i COMES WITH:

- Air regulator with on/off valve
- Main Power cable
- Air hose with all connectors
- 6 Square Nuts plus spare for mounting fixture plate to MP150i frame
- Electrical Ground line
- 1 engraving bit with holder
- 1 spare engraving bit
- 1 Foot switch
- DVD with operation video, manual, and troubleshooting instructions
- Keyboard

MP150i

- C.H. Hanson Limited Three Year Warranty
- Precision and ease in one very capable machine
- Versatile design: light and compact with a large 6" x 4" marking surface
- The very best quality and dependable construction for daily production use
- Over 400 megabytes of memory to store over 30,000 marking files
- Easy integration with additional I/O and RS-232 for marking files or PC computer communication
- USB port allows for easy import of marking files, logos, and fonts
- VGA port allows users to project marking surface to additional monitor
- Fully assembled with power unit, controller, 5.7" LCD monitor, air hoses and fittings
- Mark up to 63 Rockwell (HRC 63), stainless steel, hardened steels, copper, brass, aluminium, or any plastic
- No extra PC computer needed for operation
- 110/220 volt
- Marks 1 – 4 characters / second
- Comes with 2 engraving bits

MARKING FEATURES:

- Serialization
- Date/Time/Shift
- Graphics/Logos
- Dot or Line Fonts
- 2-D Data Matrix
- Angular Text Mode



For an operation manual, or to learn more about the C.H. Hanson Hansco-Mark™ MP150i call 800-827-3398 or email sales@chanson.com

Hansco-Mark™ Permanent Micro-Percussion Portable Marking Machine

Model No. MP5-P
Hanson Item No. 20005
Weight 26 lbs.



EVERY MP5-P COMES WITH:

- Portable marking machine MP5-P head with portable flat fixture
- MP5-P Controller
- Portable Tube-V fixture for tube marking
- 3 meter cable line to connect MP5-P head and controller
- Air hose tube connects the air regulator to the head
- Air regulator with on/off valve
- Main Power cable
- Air hose with all connectors
- Electrical Ground line
- 1 engraving bit with holder
- 1 spare engraving bit
- 1 Foot switch
- DVD with operation video, manual, and troubleshooting instructions
- Keyboard

MARKING FEATURES:

- Serialization
- Date/Time/Shift
- Graphics/Logos
- Dot or Line Fonts
- 2-D Data Matrix
- Angular Text Mode

MP5-P

- C.H. Hanson Limited Three Year Warranty
- Precision and ease in one very portable machine
- Versatile design: light and compact with a large 6" x 2.5" marking surface
- 26 pounds and ergonomic design for easy lifting and holding
- Over 400 megabytes of memory to store over 30,000 marking files
- Easy integration with additional I/O and RS-232 for marking files or PC computer communication
- Easily programmable with keyboard and monitor and detaches to be a single unit marking machine
- USB port allows for easy import of marking files, logos, and fonts
- Fully assembled with power unit, controller, 5.7" LCD monitor, air hoses and fittings
- Mark up to 63 Rockwell (HRC 63), stainless steel, hardened steels, copper, brass, aluminium, or any plastic
- No extra PC computer needed for operation
- 110/220 volt
- Marks 1 - 4 characters / second

For an operation manual, or to learn more about the C.H. Hanson Hansco-Mark™ MP150i call 800-827-3398 or email sales@chhanson.com



Hansco-Mark™ Accessories

FIXTURE PLATE WITH MAGNETIC CLAMP

Hanson Part No. 20014
Weight 20 lbs.

The C.H. Hanson Hansco-Mark™ Fixture Plate with Magnetic Clamp is an attachment part for the Micro-Percussion marking machine (Model #MP150i, C.H. Hanson #20000). The fixture plate and magnetic clamp are designed to secure your name plate and tag during the marking operation by; supporting, clamping, and holding the workpiece in place.

- #20000 with optional
- #20010 C-Axis Pneumatic Chuck and
- #20014 Fixture Plate with Magnetic Clamp

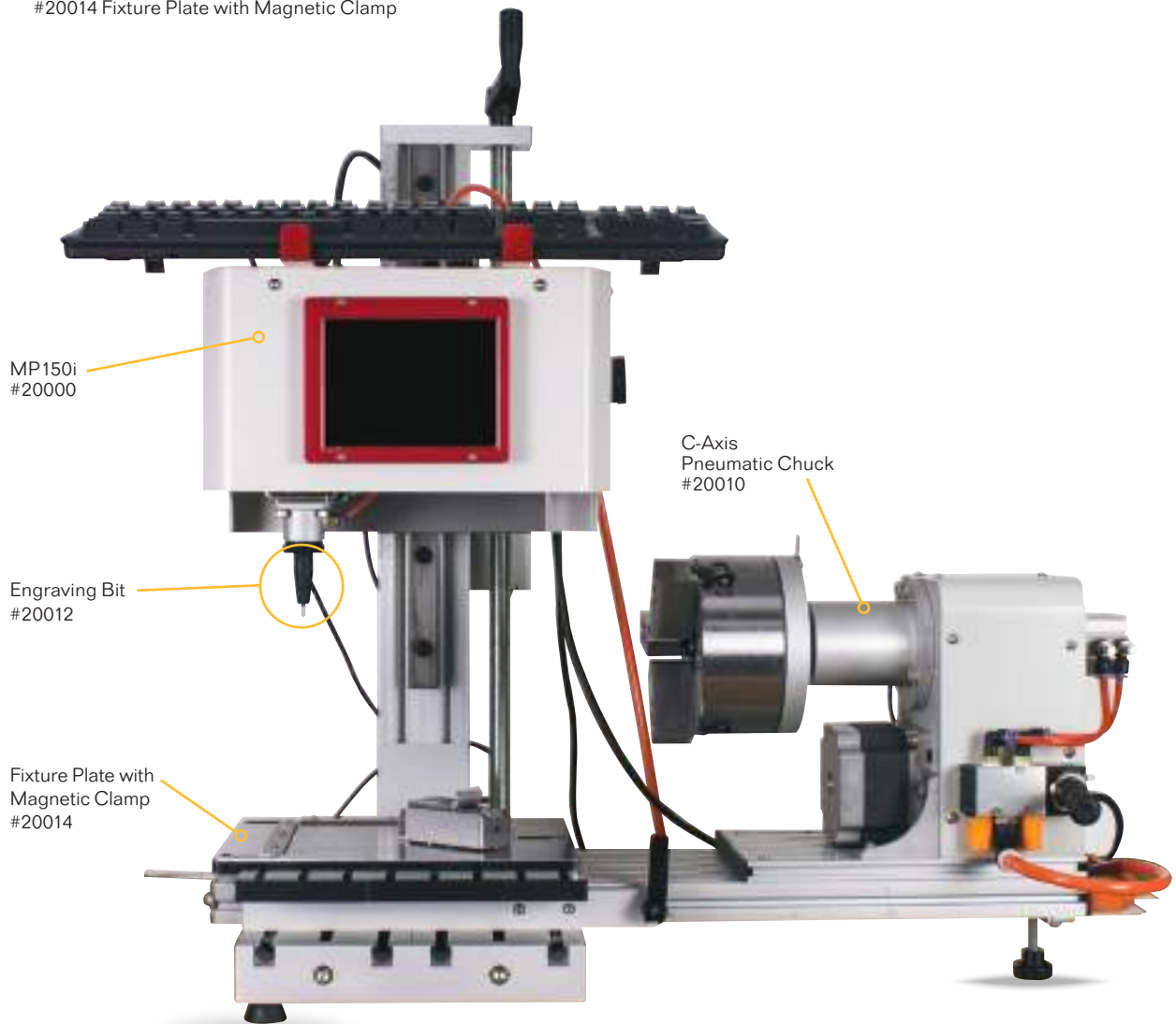



Hansco-Mark™ Accessories

C-AXIS PNEUMATIC CHUCK

Model No. 042-A
Hanson Part No. 20010
Weight 49 lbs.

- C.H. Hanson Limited Three Year Warranty
- Most secure way to hold rounded objects and parts while marking, bar coding, scribing
- Fits Micro-percussion marking machine (Model #MP150i, C.H. Hanson #20000)
- Most accurate way to mark rounded parts and maintain a consistent cut depth

The C.H. Hanson Hansco-Mark™ C-Axis Pneumatic Chuck is an essential accessory when marking round parts. The C-Axis Pneumatic Chuck fits the Hansco-Mark™ micro-percussion machine (MP150i). When particular applications call for permanent marking of cylinders or round parts, the C-Axis Pneumatic Chuck will securely hold the part you wish to mark using compressed air and simultaneously spin the part as the micro-percussion marks. This precision machined unit allows for accurate and consistent marking depth on rounded objects and parts that would otherwise pose as a challenge to mark properly.



REPLACEMENT ENGRAVING BIT

Hanson Part No. 20012
Weight 3.3 lbs.

- Oil hardened steel for maximum durability
- Length: 5"
- Fit both Hansco-Mark permanent marking machines (Model #MP5-P and #MP150i)

The C.H. Hanson Hansco-Mark™ Replacement Engraving Bit can be used on either Micro-Percussion marking machine (Model #MP5-P and #MP150i). This bit is produced from quality steel and oil hardened for durability.

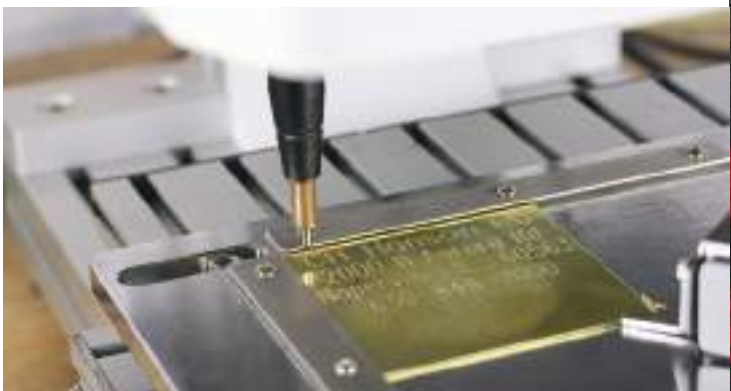



**C.H.
HANSON**[®]
Since 1866 • Tools for Generations™



CUSTOM TAGS AVAILABLE



EMBOSSSED



BLANK



SEALS & ACCESSORIES



PRE-MARKED

800-827-3398  chhanson.com  sales@chhanson.com

Blank Metal Tags - ROUND

- Brass, Aluminum and Anodized Tags: 18 Gauge
- Stainless Steel and 316 Stainless Steel Tags: 20 Gauge
- Package - bagged. (100 per bag unless otherwise noted)

Item No.	Die Reference	Dimensions	Hole Size	Holes
ALUMINUM				
41821	1078A	1" diameter	3/16"	1
41831	1085A	1-3/32" diameter	3/16"	1
41841	1090A	1-1/4" diameter	3/16"	1
41846	1094A	1-3/8" diameter	3/16"	1
41856	1098A	1-1/2" diameter	3/16"	1
41881	1110A	2" diameter	3/16"	1
43474**	1124A	3" diameter	3/16"	1
43475*	1124A	3" diameter	3/16"	1
43476	1124A	3" diameter	3/16"	1
BRASS				
41822	1078B	1" diameter	3/16"	1
41832	1085B	1-3/32" diameter	3/16"	1
41842	1090B	1-1/4" diameter	3/16"	1
41847	1094B	1-3/8" diameter	3/16"	1
41849	1094M	1-3/8" diameter	3/8"	1
41857	1098B	1-1/2" diameter	3/16"	1
41882	1110B	2" diameter	3/16"	1
43468**	1124B	3" diameter	3/16"	1
43469*	1124B	3" diameter	3/16"	1
43470	1124B	3" diameter	3/16"	1
STAINLESS STEEL				
41823	1078S	1" diameter	3/16"	1
41833	1085S	1-3/32" diameter	3/16"	1
41843	1090S	1-1/4" diameter	3/16"	1
41848	1094S	1-3/8" diameter	3/16"	1
41858	1098S	1-1/2" diameter	3/16"	1
41883	1110S	2" diameter	3/16"	1
43471**	1124S	3" diameter	3/16"	1
43472*	1124S	3" diameter	3/16"	1
43473	1124S	3" diameter	3/16"	1
316 STAINLESS STEEL				
43122*	1078	1" diameter	3/16"	1
43123**	1090	1-1/4" diameter	3/16"	1
43124**	1094	1-3/8" diameter	3/16"	1
43125**	1098	1-1/2" diameter	3/16"	1
43126***	1110	2" diameter	3/16"	1
ANODIZED ALUMINUM - RED				
43008****	1078	1" diameter	3/16"	1
43138****	1090	1-1/4" diameter	3/16"	1
43145****	1098	1-1/2" diameter	3/16"	1
43013****	1110	2" diameter	3/16"	1
43018****	1124	3" diameter	3/16"	1
ANODIZED ALUMINUM - BLUE				
43139****	1090	1-1/4" diameter	3/16"	1
43146****	1098	1-1/2" diameter	3/16"	1
43011****	1110	2" diameter	3/16"	1
43016****	1124	3" diameter	3/16"	1

*50 per pack

**25 per pack

***10 per pack

****5 per pack



ALUMINUM
(lightweight, cost effective)



STAINLESS STEEL
(maximum durability)



BRASS
(durable and polished)



ANODIZED ALUMINUM - RED
(light weight)

ANODIZED ALUMINUM - BLACK

43005****	1078	1" diameter	3/16"	1
43140****	1090	1-1/4" diameter	3/16"	1
43147****	1098	1-1/2" diameter	3/16"	1
43010****	1110	2" diameter	3/16"	1
43015****	1124	3" diameter	3/16"	1

ANODIZED ALUMINUM - GOLD

43007****	1078	1" diameter	3/16"	1
43141****	1090	1-1/4" diameter	3/16"	1
43148****	1098	1-1/2" diameter	3/16"	1
43012****	1110	2" diameter	3/16"	1
43017****	1124	3" diameter	3/16"	1

ANODIZED ALUMINUM - GREEN

43082****	1078	1" diameter	3/16"	1
43143****	1090	1-1/4" diameter	3/16"	1
43102****	1098	1-1/2" diameter	3/16"	1
43084****	1110	2" diameter	3/16"	1
43086****	1124	3" diameter	3/16"	1

ANODIZED ALUMINUM - ORANGE

43009****	1078	1" diameter	3/16"	1
43142****	1090	1-1/4" diameter	3/16"	1
43001****	1098	1-1/2" diameter	3/16"	1
43014****	1110	2" diameter	3/16"	1
43019****	1124	3" diameter	3/16"	1

ANODIZED ALUMINUM - YELLOW

43081****	1078	1" diameter	3/16"	1
43144****	1090	1-1/4" diameter	3/16"	1
43077****	1098	1-1/2" diameter	3/16"	1
43083****	1110	2" diameter	3/16"	1
43085****	1124	3" diameter	3/16"	1

MARKING



CUSTOM SOLUTIONS AVAILABLE



Blank Metal Tags - ROUND WITH EARS and OVAL

- Brass, Aluminum and Anodized Tags: 18 Gauge
- Stainless Steel and 316 Stainless Steel Tags: 20 Gauge
- Package - bagged. (100 per bag unless otherwise noted)



ALUMINUM
(lightweight, cost effective)



STAINLESS STEEL
(maximum durability)



BRASS
(durable and polished)



ALUMINUM
(lightweight, cost effective)



STAINLESS STEEL
(maximum durability)



BRASS
(durable and polished)



ANODIZED ALUMINUM - RED
(light weight)

ROUND WITH EARS

Item No.	Die Reference	Dimensions	Hole Size	Holes
ALUMINUM				
41376	722A	1" diameter plus Ear	7/64"	1
41386	723A	1-1/4" diameter plus Ear	11/64"	1
BRASS				
41377	722B	1" diameter plus Ear	7/64"	1
41387	723B	1-1/4" diameter plus Ear	11/64"	1
42387**	723B	1-1/4" diameter plus Ear	11/64"	1
STAINLESS STEEL				
41378	722S	1" diameter plus Ear	7/64"	1
41388	723S	1-1/4" diameter plus Ear	11/64"	1
316 STAINLESS STEEL				
43127**	722	1" diameter plus Ear	7/64"	1
43128***	723	1-1/4" diameter plus Ear	11/64"	1

OVAL TAGS

ALUMINUM				
41696	993A	3/4" x 1-11/32"	3/32"	2
41741	1009A	1" x 1-7/8"	1/8"	2
41771	1019A	1-5/32" x 2-1/16"	1/8"	2
BRASS				
41697	993B	3/4" x 1-11/32"	3/32"	2
41742	1009B	1" x 1-7/8"	1/8"	2
41772	1019B	1-5/32" x 2-1/16"	1/8"	2
STAINLESS STEEL				
41698	993S	3/4" x 1-11/32"	3/32"	2
41743	1009S	1" x 1-7/8"	1/8"	2
41773	1019S	1-5/32" x 2-1/16"	1/8"	2
316 STAINLESS STEEL				
43120***	1009	1"x1-7/8"	1/8"	2
43121***	1019	1-5/32"x2-1/16"	1/8"	2
ANODIZED ALUMINUM - RED				
43149***	1019	1-5/32"x2-1/16"	1/8"	2
ANODIZED ALUMINUM - BLUE				
43150***	1019	1-5/32"x2-1/16"	1/8"	2
ANODIZED ALUMINUM - BLACK				
43151***	1019	1-5/32"x2-1/16"	1/8"	2
ANODIZED ALUMINUM - GOLD				
43152***	1019	1-5/32"x2-1/16"	1/8"	2
ANODIZED ALUMINUM - ORANGE				
43153***	1019	1-5/32"x2-1/16"	1/8"	2
ANODIZED ALUMINUM - GREEN				
43154***	1019	1-5/32"x2-1/16"	1/8"	2
ANODIZED ALUMINUM - YELLOW				
43155***	1019	1-5/32"x2-1/16"	1/8"	2

**25 per pack

***10 per pack

****5 per pack

Blank Metal Tags - HEXAGON, OCTAGON

- Brass, Aluminum and Anodized Tags: 18 Gauge
- Stainless Steel and 316 Stainless Steel Tags: 20 Gauge
- Package - bagged. (100 per bag unless otherwise noted)



ALUMINUM
(lightweight, cost effective)



ALUMINUM
(lightweight, cost effective)



BRASS
(durable and polished)



BRASS
(durable and polished)



STAINLESS STEEL
(maximum durability)



STAINLESS STEEL
(maximum durability)

HEXAGON TAGS

Item No.	Die Reference	Dimensions	Hole Size	Holes
ALUMINUM				
41250	928A	1-1/16"	1/8"	1
41260	932A	1-1/4"	3/16"	1
BRASS				
41482	928B	1-1/16"	1/8"	1
41261	932B	1-1/4"	3/16"	1
42492**	932B	1-1/4"	3/16"	1
STAINLESS STEEL				
41483	928S	1-1/16"	1/8"	1
41262	932S	1-1/4"	3/16"	1
316 STAINLESS STEEL				
43130**	932	1-1/4"	3/16"	1

OCTAGON TAGS

ALUMINUM				
41516	943A	1-1/64"	3/16"	1
41526	947A	1-1/4"	3/16"	1
41531	950A	1-1/2"	3/16"	1
BRASS				
41517	943B	1-1/64"	3/16"	1
41527	947B	1-1/4"	3/16"	1
41532	950B	1-1/2"	3/16"	1
42527**	947B	1-1/4"	3/16"	1
42532**	950B	1-1/2"	3/16"	1
STAINLESS STEEL				
41518	943S	1-1/64"	3/16"	1
41528	947S	1-1/4"	3/16"	1
41533	950S	1-1/2"	3/16"	1
316 STAINLESS STEEL				
43133**	945	1-1/8"	3/16"	1
43131**	947	1-1/4"	3/16"	1
43132**	950	1-1/2"	3/16"	1

**25 per pack

MARKING



CUSTOM SOLUTIONS AVAILABLE



Blank Metal Tags - SQUARE

- Brass, Aluminum and Anodized Tags: 18 Gauge
- Stainless Steel and 316 Stainless Steel Tags: 20 Gauge
- Package - bagged. (100 per bag unless otherwise noted)

Item No.	Die Reference	Dimensions	Hole Size	Holes
ALUMINUM				
41421	913A	1"	3/16"	1
41431	916A	1-1/4"	3/16"	1
41451	3590A	1-1/2"	3/16"	1
41461	3581A	2"	3/16"	1
BRASS				
41422	913B	1"	3/16"	1
41432	916B	1-1/4"	3/16"	1
41452**	3590B	1-1/2"	3/16"	1
41462**	3581B	2"	3/16"	1
42452	3590B	1-1/2"	3/16"	1
42462	3581B	2"	3/16"	1
STAINLESS STEEL				
41423	913S	1"	3/16"	1
41433	916S	1-1/4"	3/16"	1
41453	3590S	1-1/2"	3/16"	1
41463	3581S	2"	3/16"	1
316 STAINLESS STEEL				
43134**	913	1"	3/16"	1
43135**	916	1-1/4"	3/16"	1
43136***	3590	1-1/2"	3/16"	1
43137***	3581	2"	3/16"	1
ANODIZED ALUMINUM - BLACK				
43020****	913	1"	3/16"	1
43025****	916	1-1/4"	3/16"	1
43158****	3590	1-1/2"	3/16"	1
43030****	3581	2"	3/16"	1
43409****	3590	1-1/2"	3/16"	1
ANODIZED ALUMINUM - BLUE				
43021****	913	1"	3/16"	1
43026****	916	1-1/4"	3/16"	1
43157****	3590	1-1/2"	3/16"	1
43031****	3581	2"	3/16"	1
43410****	3590	1-1/2"	3/16"	1
ANODIZED ALUMINUM - GOLD				
43022****	913	1"	3/16"	1
43027****	916	1-1/4"	3/16"	1
43159****	3590	1-1/2"	3/16"	1
43032****	3581	2"	3/16"	1
ANODIZED ALUMINUM - GREEN				
43088****	913	1"	3/16"	1
43090****	916	1-1/4"	3/16"	1
43104****	3590	1-1/2"	3/16"	1
43092****	3581	2"	3/16"	1



ALUMINUM
(lightweight, cost effective)



BRASS
(durable and polished)



STAINLESS STEEL
(maximum durability)



ANODIZED ALUMINUM - RED
(light weight)

ANODIZED ALUMINUM - ORANGE

43024****	913	1"	3/16"	1
43029****	916	1-1/4"	3/16"	1
43003****	3590	1-1/2"	3/16"	1
43034****	3581	2"	3/16"	1

Item No.	Die Reference	Dimensions	Hole Size	Holes
----------	---------------	------------	-----------	-------

ANODIZED ALUMINUM - RED

43023****	913	1"	3/16"	1
43028****	916	1-1/4"	3/16"	1
43156****	3590	1-1/2"	3/16"	1
43033****	3581	2"	3/16"	1

ANODIZED ALUMINUM - YELLOW

43087****	913	1"	3/16"	1
43089****	916	1-1/4"	3/16"	1
43079****	3590	1-1/2"	3/16"	1
43091****	3581	2"	3/16"	1

25 per pack *10 per pack ****5 per pack

Blank Metal Tags - RECTANGLE TAGS WITH ROUNDED CORNERS

- Brass, Aluminum and Anodized Tags: 18 Gauge
- Stainless Steel and 316 Stainless Steel Tags: 20 Gauge
- Package - bagged. (100 per bag unless otherwise noted)

Item No.	Die Reference	Dimensions	Hole Size	Holes
ALUMINUM				
41221	50A	1/2" x 1-9/32"	1/8"	2
41241	140A	5/8" x 2-1/2"	1/8"	2
41251	60A	3/4" x 1-3/4"	1/8"	2
41271	76A	1" x 2"	1/8"	2
41281	3575A	1" x 2-1/2"	1/8"	2
41291	432A	1" x 3"	1/8"	2
41316	96A	1-1/2" x 3"	1/8"	2

Item No.	Die Reference	Dimensions	Hole Size	Holes
BRASS				
41222	50B	1/2" x 1-9/32"	1/8"	2
41242	140B	5/8" x 2-1/2"	1/8"	2
41252	60B	3/4" x 1-3/4"	1/8"	2
41272	76B	1" x 2"	1/8"	2
41282	3575B	1" x 2-1/2"	1/8"	2
41292	432B	1" x 3"	1/8"	2
43411****	432B-16GA	1" x 3"	3/16"	2
41317	96B	1-1/2" x 3"	1/8"	2

Item No.	Die Reference	Dimensions	Hole Size	Holes
STAINLESS STEEL				
41223	50S	1/2" x 1-9/32"	1/8"	2
41243	140S	5/8" x 2-1/2"	1/8"	2
41253	60S	3/4" x 1-3/4"	1/8"	2
41273	76S	1" x 2"	1/8"	2
41283	3575S	1" x 2-1/2"	1/8"	2
41293	432S	1" X 3"	1/8"	2
41318	96S	1-1/2" x 3"	1/8"	2

Item No.	Die Reference	Dimensions	Hole Size	Holes
316 STAINLESS STEEL				
43110**	50	1/2"x1-9/32"	1/8"	2
43111***	140	5/8"x2-1/2"	1/8"	2
43112**	60	3/4"x1-3/4"	1/8"	2
43113***	76	1"x2"	1/8"	2
43114***	3575	1"x2-1/2"	1/8"	2
43115***	432	1"x3"	1/8"	2
43116***	96	1-1/2"x3"	1/8"	2

Item No.	Die Reference	Dimensions	Hole Size	Holes
ANODIZED ALUMINUM - BLACK				
43050****	60	3/4"x1-3/4"	1/8"	2
43035****	76	1"x2"	1/8"	2
43169****	432	1"x3"	1/8"	2
43040****	96	1-1/2"x3"	1/8"	2
43045****	434	2"x4"	1/8"	2
43412****	438	3"x5"	3/16"	2
43413****	432	1"x3"	1/8"	2

Item No.	Die Reference	Dimensions	Hole Size	Holes
ANODIZED ALUMINUM - BLUE				
43051****	60	3/4"x1-3/4"	1/8"	2
43036****	76	1"x2"	1/8"	2
43168****	432	1"x3"	1/8"	2
43041****	96	1.5"x3"	1/8"	2
43046****	434	2"x4"	1/8"	2
43414****	438	3"x5"	3/16"	2
43415****	432	1"x3"	1/8"	2



ALUMINUM
(lightweight, cost effective)



STAINLESS STEEL
(maximum durability)

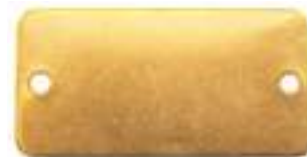

BRASS
(durable and polished)



ANODIZED ALUMINUM - RED
(light weight)

Item No.	Die Reference	Dimensions	Hole Size	Holes
----------	---------------	------------	-----------	-------

ANODIZED ALUMINUM - GOLD				
43052****	60	3/4"x1-3/4"	1/8"	2
43037****	76	1"x2"	1/8"	2
43170****	432	1"x3"	1/8"	2
43042****	96	1-1/2"x3"	1/8"	2
43047****	434	2"x4"	1/8"	2
43416****	438	3"x5"	3/16"	2

ANODIZED ALUMINUM - GREEN				
43101****	60	3/4"x1-3/4"	1/8"	2
43094****	76	1"x2"	1/8"	2
43105****	432	1"x3"	1/8"	2
43096****	96	1.5"x3"	1/8"	2
43099****	434	2"x4"	1/8"	2

ANODIZED ALUMINUM - ORANGE				
43054****	60	3/4"x1-3/4"	1/8"	2
43039****	76	1"x2"	1/8"	2
43004****	432	1"x3"	1/8"	2
43044****	96	1.5"x3"	1/8"	2
43049****	434	2"x4"	1/8"	2

ANODIZED ALUMINUM - RED				
43053****	60	3/4"x1-3/4"	1/8"	2
43038****	76	1"x2"	1/8"	2
43167****	432	1"x3"	1/8"	2
43043****	96	1-1/2"x3"	1/8"	2
43048****	434	2"x4"	1/8"	2
43418****	438	3"x5"	3/16"	2

ANODIZED ALUMINUM - YELLOW				
43100****	60	3/4"x1-3/4"	1/8"	2
43093****	76	1"x2"	1/8"	2
43080****	432	1"x3"	1/8"	2
43095****	96	1.5"x3"	1/8"	2
43098****	434	2"x4"	1/8"	2

ANODIZED ALUMINUM - CLEAR				
43419****	432	1" x3"	1/8"	2

25 per pack *10 per pack ****5 per pack

MARKING



CUSTOM SOLUTIONS AVAILABLE



Blank Metal Tags - RECTANGLES WITH NOTCHED CORNERS and WITH ROUNDED ENDS

- Brass, Aluminum and Anodized Tags: 18 Gauge
- Stainless Steel and 316 Stainless Steel Tags: 20 Gauge
- Package - bagged. (100 per bag unless otherwise noted)



ALUMINUM
(lightweight, cost effective)



BRASS
(durable and polished)



STAINLESS STEEL
(maximum durability)



ALUMINUM
(lightweight, cost effective)



STAINLESS STEEL
(maximum durability)



BRASS
(durable and polished)

RECTANGLES WITH NOTCHED CORNERS

Item No.	Die Reference	Dimensions	Hole Size	Holes
ALUMINUM				
41331	190A	1-7/16" x 3-1/16"	5/32"	2
BRASS				
41332	190B	1-7/16" x 3-1/16"	5/32"	2
STAINLESS STEEL				
41333	190S	1-7/16" x 3-1/16"	5/32"	2
316 STAINLESS STEEL				
43119***	190	1-7/16"x3-1/16"	5/32"	2
ANODIZED ALUMINUM - RED				
43160****	190	1-7/16"x3-1/16"	5/32"	2
ANODIZED ALUMINUM - BLUE				
43161****	190	1-7/16"x3-1/16"	5/32"	2
ANODIZED ALUMINUM - BLACK				
43162****	190	1-7/16"x3-1/16"	5/32"	2
ANODIZED ALUMINUM - GOLD				
43163****	190	1-7/16"x3-1/16"	5/32"	2
ANODIZED ALUMINUM - ORANGE				
43164****	190	1-7/16"x3-1/16"	5/32"	2
ANODIZED ALUMINUM - GREEN				
43165****	190	1-7/16"x3-1/16"	5/32"	2
ANODIZED ALUMINUM - YELLOW				
43166****	190	1-7/16"x3-1/16"	5/32"	2

RECTANGLES WITH ROUNDED ENDS

Item No.	Die Reference	Dimensions	Hole Size	Holes
ALUMINUM				
41136	21A	5/8" x 1-29/32"	1/8"	2
41151	24A	5/8" x 2-13/16"	5/32"	2
41176	30A	3/4" x 3-1/8"	5/32"	2
41186	32A	49/64" x 1-13/16"	1/8"	2
41196	3585A	1" x 2-1/8"	1/8"	2
BRASS				
41137	21B	5/8" x 1-29/32"	1/8"	2
41152	24-316B	5/8" x 2-13/16"	3/16"	2
41154	24-18B	5/8" x 2-13/16"	5/32"	2
41177	30B	3/4" x 3-1/8"	5/32"	2
41187	32B	49/64" x 1-13/16"	1/8"	2
41197	3585B	1" x 2-1/8"	1/8"	2
STAINLESS STEEL				
41138	21S	5/8" x 1-29/32"	1/8"	2
41153	24S	5/8" x 2-13/16"	5/32"	2
41178	30S	3/4" x 3-1/8"	5/32"	2
41188	32S	49/64" x 1-13/16"	1/8"	2
41198	3585S	1" x 2-1/8"	1/8"	2
316 STAINLESS STEEL				
43106**	21	5/8"x1-29/32"	1/8"	2
43107***	24	5/8"x2-13/16"	5/32"	2
43108***	30	3/4"x3-1/8"	5/32"	2
43109***	3585	1"x2-1/8"	1/8"	2
ANODIZED ALUMINUM - BLACK				
43173****	21	5/8"x1-29/32"	1/8"	2
43180****	3585	1"x2-1/8"	1/8"	2
ANODIZED ALUMINUM - BLUE				
43172****	21	5/8"x1-29/32"	1/8"	2
43179****	3585	1"x2-1/8"	1/8"	2
ANODIZED ALUMINUM - GOLD				
43174****	21	5/8"x1-29/32"	1/8"	2
43181****	3585	1"x2-1/8"	1/8"	2
ANODIZED ALUMINUM - GREEN				
43176****	21	5/8"x1-29/32"	1/8"	2
43183****	3585	1"x2-1/8"	1/8"	2
ANODIZED ALUMINUM - ORANGE				
43175****	21	5/8"x1-29/32"	1/8"	2
43182****	3585	1"x2-1/8"	1/8"	2
ANODIZED ALUMINUM - RED				
43171****	21	5/8"x1-29/32"	1/8"	2
43178****	3585	1"x2-1/8"	1/8"	2
ANODIZED ALUMINUM - YELLOW				
43177****	21	5/8"x1-29/32"	1/8"	2
43184****	3585	1"x2-1/8"	1/8"	2

25 per pack *10 per pack ****5 per pack

NUMBERED CHECKS and NUMBERED VALVE TAGS

NUMBERED CHECKS

- Easy to read black filled numbers
- Available only in unbroken series of 25: 1-25,26-50, up to 200
- All tags are 18 Gauge and have a 3/16" hole
- All sets are wired together in groups of 25



Item No.	Description	Package
40001	1" Brass - 1 to 100	Bagged
40002	1" Brass - 1 to 200	Bagged
40003	1" Brass - 1 to 25	Bagged
40004	1" Brass - 26 to 50	Bagged
40005	1" Brass - 51 to 75	Bagged
40006	1" Brass - 76 to 100	Bagged
40007	1" Brass - 101 to 125	Bagged
40008	1" Brass - 126 to 150	Bagged
40009	1" Brass - 151 to 175	Bagged
40010	1" Brass - 176 to 200	Bagged
40011	1- 1/4" Brass - 1 to 100	Bagged
40012	1- 1/4" Brass - 1 to 200	Bagged
40013	1- 1/4" Brass - 1 to 25	Bagged
40014	1- 1/4" Brass - 26 to 50	Bagged
40015	1- 1/4" Brass - 51 to 75	Bagged
40016	1- 1/4" Brass - 76 to 100	Bagged
40017	1- 1/4" Brass - 100 to 125	Bagged
40018	1- 1/4" Brass - 126 to 150	Bagged
40019	1- 1/4" Brass - 150 to 175	Bagged
40020	1- 1/4" Brass - 175 to 200	Bagged
40021	1- 1/2" Brass -001 to 100	Bagged
40022	1- 1/2" Brass -001 to 200	Bagged
40023	1- 1/2" Brass -001 to 025	Bagged
40024	1- 1/2" Brass -026 to 050	Bagged
40025	1- 1/2" Brass -051 to 075	Bagged
40026	1- 1/2" Brass -076 to 100	Bagged
40027	1- 1/2" Brass -101 to 125	Bagged
40028	1- 1/2" Brass -126 to 150	Bagged
40029	1- 1/2" Brass -151 to 175	Bagged
40030	1- 1/2" Brass -176 to 200	Bagged
40031	1- 1/4" Aluminum - 1 to 100	Bagged
40032	1- 1/4" Aluminum - 1 to 200	Bagged
40033	1- 1/4" Aluminum - 1 to 25	Bagged
40034	1- 1/4" Aluminum - 26 to 50	Bagged
40035	1- 1/4" Aluminum - 51 to 75	Bagged
40036	1- 1/4" Aluminum - 76 to 100	Bagged
40037	1- 1/4" Aluminum - 101 to 125	Bagged
40038	1- 1/4" Aluminum - 126 to 150	Bagged
40039	1- 1/4" Aluminum - 151 to 175	Bagged
40040	1- 1/4" Aluminum - 176 to 200	Bagged

NUMBERED VALVE TAGS

- Easy to read brass tags with black filled letters and numbers
- Lettered in 6 titles and numbered consecutively in unbroken sets of 25: 1-25, 26-50, 51-75, 76-100, etc. up to 200



Item No.	Description	Package
43420	HTG - Brass - 001 to 025	Bagged
43421	HTG - Brass - 026 to 050	Bagged
43422	HTG - Brass - 051 to 075	Bagged
43423	HTG - Brass - 076 to 100	Bagged
43424	HTG - Brass - 101 to 125	Bagged
43425	HTG - Brass - 126 to 150	Bagged
43426	HTG - Brass - 151 to 175	Bagged
43427	HTG - Brass - 176 to 200	Bagged
43428	PLBG - Brass - 001 to 025	Bagged
43429	PLBG - Brass - 026 to 050	Bagged
43430	PLBG - Brass - 051 to 075	Bagged
43431	PLBG - Brass - 076 to 100	Bagged
43432	PLBG - Brass - 101 to 125	Bagged
43433	PLBG - Brass - 126 to 150	Bagged
43434	PLBG - Brass - 151 to 175	Bagged
43435	PLBG - Brass - 176 to 200	Bagged
43436	CW - Brass - 001 to 025	Bagged
43437	CW - Brass - 026 to 050	Bagged
43438	CW - Brass - 051 to 075	Bagged
43439	CW - Brass - 076 to 100	Bagged
43440	CW - Brass - 101 to 125	Bagged
43441	CW - Brass - 126 to 150	Bagged
43442	CW - Brass - 151 to 175	Bagged
43443	CW - Brass - 176 to 200	Bagged
43444	HW - Brass - 001 to 025	Bagged
43445	HW - Brass - 026 to 050	Bagged
43446	HW - Brass - 051 to 075	Bagged
43447	HW - Brass - 076 to 100	Bagged
43448	HW - Brass - 101 to 125	Bagged
43449	HW - Brass - 126 to 150	Bagged
43450	HW - Brass - 151 to 175	Bagged
43451	HW - Brass - 176 to 200	Bagged
43452	CHWR - Brass - 001 to 025	Bagged
43453	CHWR - Brass - 026 to 050	Bagged
43454	CHWR - Brass - 051 to 075	Bagged
43455	CHWR - Brass - 076 to 100	Bagged
43456	CHWR - Brass - 101 to 125	Bagged
43457	CHWR - Brass - 126 to 150	Bagged
43458	CHWR - Brass - 151 to 175	Bagged
43459	CHWR - Brass - 176 to 200	Bagged
43460	GAS - Brass - 001 to 025	Bagged
43461	GAS - Brass - 026 to 050	Bagged
43462	GAS - Brass - 051 to 075	Bagged
43463	GAS - Brass - 076 to 100	Bagged
43464	GAS - Brass - 101 to 125	Bagged
43465	GAS - Brass - 126 to 150	Bagged
43466	GAS - Brass - 151 to 175	Bagged
43467	GAS - Brass - 176 to 200	Bagged



Blank Metal Tags - ACCESSORIES



SPRING SLEEVE CHECK RING

- Easy access to add or remove tags
- Chrome plated
- Does not come with tags
- Bagged per hundred

Item No.	Description	Package
40087	Spring Sleeve Check Ring	Bagged



BEADED CHAIN

- For quick, permanent fastening of checks and tags
- Easily closed by hand
- Bagged per hundred

40096	4.5" Nickel plated beaded chain	Bagged
40097	4.5" Brass plated beaded chain	Bagged
40098	6" Brass plated beaded chain	Bagged



BRASS/NICKEL PLATED S-HOOK LINKS

- For quick, permanent fastening of checks and tags
- Easily closed with pliers
- Bagged per hundred

41000	Brass # 5 - 7/8" long	Bagged
41001	Brass # 3 - 1-1/8" long	Bagged
41002	Brass #2 - 1-1/2" long	Bagged



SPLIT KEY RINGS

- Made of spring tempered steel
- Bagged per hundred

40080	5/8" I.D. Split Key Rings	Bagged
40081	3/4" I.D. Split Key Rings	Bagged
40082	1" I.D. Split Key Rings	Bagged
40083	1.25" I.D. Split Key Rings	Bagged
40084	1.5" I.D. Split Key Rings	Bagged
40085	2" I.D. Split Key Rings	Bagged

ALUMINUM WRITE ON TAGS

- Easily marked with pen, pencil, or other writing tool
- Bagged per hundred

X1291A	1 3/8" x 3 1/8" Aluminum write on tag	Bagged
97443	3" x 5" Aluminum write on tag	Bagged



Blank Metal Tags - ACCESSORIES



BLANK CABLE TAGS

- Made from 28 Gauge soft aluminum
- Easily folds and re-folds multiple times
- Perfect for holding and organizing cables
- Bagged per hundred

Item No.	Description	Die Reference
41901	Length 1-15/16"	585A
41911	Length 2"	588A
41914	Length 3-15/16"	589A
41917	Length 6-1/2"	590A
41920	Length 11"	591A
41924	Length 10"	592A
41930	Length 11"	593A
41939	Length 1-11/16"	3467A
41942	Length 3-3/8"	3470A
41945	Length 5-3/4"	3508A
41951	Length 3-1/2"	3527A
41956	Length 6-3/4"	3555A

PREMIER AUTOMATIC SEALS

- Self-locking, permanent mechanical closure
- 8-3/4" x 5/16" metal strap can be embossed with name and consecutive numbering
- Available in lots of 1,000
- Lettering has a maximum capacity of 20 spaces
- Bagged per thousand
- For custom, call customer service

Item No.	Description	Package
2799PN	Premier Automatic Seals	Bagged

MECHANICAL SEALS

- Precision built to stay locked
- Embossed identity and consecutive numbering
- 8-1/2" x 5/8" with plain or colored heads
- Available in lots of 1,000
- Lettering has a maximum capacity of 20 spaces
- Bagged per thousand
- For custom, call customer service

Item No.	Description	Package
2799GN	Globe Mechanical Seals	Bagged

SECURITY

- Cannot be opened or tampered without detection
- Lead seals are available separately or with wires attached
- Wires are annealed (copper coated) steel unless indicated
- Bagged per hundred, except for the wire spools

Item No.	Description	Package
27911	7/16" SI. Leads With 10" 2-Ply #23 CC Wires	Bagged
27913	1/2" Plain Leads	Bagged
27915	10" 2-Ply #23 CC Wires	Bagged
27916	1000 ft. spool of 27915	Bagged
27917	12" 2-Ply #26 Galv. Wires	Bagged
27918	12" 2-Ply #27 SS Wires	Bagged

SEALING PRESS

- Available with blank dies or marking dies (7/16" diameter) for one or both sides of the lead disc
- Provide copy (max. 4 characters) if desired, and state whether one or both dies are to be lettered
- Strong, small (2-1/2" x 5" closed) press tightly closes seals
- Bagged as each

Item No.	Description	Package
27905	Sealing Press with two blank dies	Bagged
27905A	Sealing Press with one die engraved	Bagged
27905B	Sealing Press with both dies engraved	Bagged
27906	Extra blank dies	Bagged
27906B	Extra engraved dies	Bagged





STEEL STAMPS

Individual Letters

Individual Numbers

Reverse

Sharp faced characters, extra deep cut for marking drop forging dies, die castings, forming dies and molding applications. On a mold stamp the character is engraved normal and reads left to right giving a reverse impression in the mold. When the product is removed from the mold, the lettering produced is raised and can be read normally.

Round Face

Characters are continuous line, round face not sharp like other stamps. Used where reduced stress marking is required.

Spanish

Lower Case

Dot

Offers the most reduced stress mark by producing a character that is impressed in a dot formation. Used where reduced stress marking is required.

Statement, Code, & Symbols

Allow for production and quality control through permanent marks stamped on part for certification/inspection.

Type & Type Holder

Steel Type and Type Holders provide the answer for all batch and general purpose marking. Simply build a series of characters into a holder and with just one strike produce a multi-character mark.

CUSTOM SOLUTIONS AVAILABLE



800-827-3398 | chanson.com | sales@chanson.com

Stamp Selection Guide - ordering the right stamp for all applications



Grade:	Standard	Heavy Duty	Premier	Rhino
Recommended use:	Medium to light duty	Moderate industrial applications	Ideal for prolonged industrial use	Greatest durability and longevity in all applications
Features:	Standard size shank for hand striking	Oversized shank to deliver more consistent stamp control	Larger shank for better impression and tempered for durability and safety	Largest shank for best impression fully tempered shank Highest quality alloy steel for toughest materials, even stamps materials up to 50 HRC
Character Size	Shank Size			
1/32" .7938mm	-	1/4" x 2-3/8"	5/16" x 2-1/2"	-
1/16" 1.5875mm	1/4" x 2-3/8"	5/16" x 2-1/2"	5/16" x 2-1/2"	-
3/32" 2.7781mm	1/4" x 2-3/8"	5/16" x 2-1/2"	5/16" x 2-3/4"	-
1/8" 3.1750mm	1/4" x 2-3/8"	5/16" x 2-1/2"	3/8" x 2-3/4"	1/2" x 3-1/2"
5/32" 3.9688mm	-	3/8" x 2-3/4"	7/16" x 2-3/4"	-
3/16" 4.7625mm	5/16" x 2-3/8"	3/8" x 2-3/4"	7/16" x 2-3/4"	9/16" x 3-1/2"
1/4" 6.3500mm	3/8" x 2-5/8"	7/16" x 3"	1/2" x 3"	5/8" x 3-1/2"
5/16" 7.9375mm	-	9/16" x 3"	9/16" x 3-1/8"	-
3/8" 9.5250mm	1/2" x 2-3/4"	9/16" x 3-1/8"	5/8" x 3-1/8"	3/4" x 3-1/2"
1/2" 12.7000mm	5/8" x 3"	3/4" x 3-3/4"	7/8" x 4"	-
5/8" 15.875mm	-	3/4" x 3-3/4"	7/8" x 4"	-
3/4" 19.05mm	-	7/8" x 3-3/4"	7/8" x 4"	-
1" 25.4mm	-	1-1/4" x 1 x 4-1/2"	1-1/4" x 1-1/4" x 4-1/2"	-

Grade of Stamp	Frequency of Use	Wood	Leather	Aluminum	Brass	Sheet Metal	Cold Roll Steel	Stainless Steel	Water, Oil, Hardened Steel	Heat Treated Material up to 50 HRC
Standard	Occasional	Not Recommended	Not Recommended	Not Recommended	Not Recommended	Not Recommended	Not Recommended	Not Recommended	Not Recommended	Not Recommended
Heavy Duty	Moderate	Better	Better	Better	Better	Better	Good	Not Recommended	Not Recommended	Not Recommended
Premier	Every Day	Better	Better	Better	Better	Better	Better	Better	Good	Not Recommended
Rhino	High Volume	Best	Best	Best	Best	Best	Best	Best	Best	Best

Not Recommended

Good

Better

Best

MARKING



CUSTOM SOLUTIONS AVAILABLE



Steel Letter and Number Stamp Sets - For hand-held, hammer struck applications

Steel Letter Stamp Sets

- Letter sets contain 27 pieces A thru Z plus ampersand (&)
- Tempered shanks for extra safety

Steel Number Stamp Sets

- Number sets contain 9 pieces 0 thru 9 (the 6 is used as a 9)
- Crowned striking surface ensures full force to the center of the stamp & textured shank provides firm easy grip

Steel Letter and Number Combo Stamp Sets

- Contains: A thru Z, ampersand, plus 0 thru 9 (the 6 is used as a 9)
- Fits flat in tool boxes

Refer to page 79 when selecting grade of stamp
Weights included below Item Number



LETTERS

SIZE	1/32"	1/16"	3/32"	1/8"	5/32"	3/16"	1/4"	5/16"	3/8"	1/2"	5/8"	3/4"	1"
Standard	—	20100 (1.46 lbs.)	20150 (1.48 lbs.)	20200 (1.48 lbs.)	—	20250 (2.14 lbs.)	20300 (3.17 lbs.)	—	20350 (5.67 lbs.)	20400 (10.84 lbs.)	—	—	—
Heavy Duty	20741 (1.44 lbs.)	20751 (2.01 lbs.)	20801 (2.11 lbs.)	20851 (2.14 lbs.)	20901 (3.17 lbs.)	20951 (3.11 lbs.)	21051 (4.61 lbs.)	21101 (7.65 lbs.)	21151 (7.55 lbs.)	21201 (16.64 lbs.)	21251 (16.55 lbs.)	21252 (22.45 lbs.)	21253 (62.7 lbs.)
Premier	22000 (1.44 lbs.)	22050 (2.10 lbs.)	22100 (2.3 lbs.)	22150 (3.18 lbs.)	22200 (4.16 lbs.)	22250 (4.14 lbs.)	22350 (5.75 lbs.)	22400 (7.52 lbs.)	22450 (10.69 lbs.)	22550 (17.54 lbs.)	22600 (24.33 lbs.)	—	22750 (25.25 lbs.)
Rhino	—	—	—	21730 (7.77 lbs.)	—	21750 (8.54 lbs.)	21760 (10.20 lbs.)	—	21770 (14.71 lbs.)	—	—	—	—
Lower Case	—	—	—	—	—	20260 (4.4 lbs.)	—	—	20360 (10.2 lbs.)	—	—	—	—
Spanish	—	—	—	20220 (4.7 lbs.)	—	20270 (7.0 lbs.)	20320 (7.0 lbs.)	—	—	—	—	—	—

NUMBERS

SIZE	1/32"	1/16"	3/32"	1/8"	5/32"	3/16"	1/4"	5/16"	3/8"	1/2"	5/8"	3/4"	1"
Standard	—	20501 (0.50 lbs.)	20521 (0.50 lbs.)	20541 (0.51 lbs.)	—	20561 (0.72 lbs.)	20581 (1.07 lbs.)	—	20601 (1.90 lbs.)	20621 (3.41 lbs.)	—	—	—
Heavy Duty	21301 (0.50 lbs.)	21320 (0.72 lbs.)	21340 (0.73 lbs.)	21360 (0.73 lbs.)	21380 (1.07 lbs.)	21400 (1.06 lbs.)	21440 (1.56 lbs.)	21460 (2.57 lbs.)	21480 (2.58 lbs.)	21500 (2.70 lbs.)	21520 (5.80 lbs.)	21521 (7.3 lbs.)	21522 (20.1 lbs.)
Premier	22801 (0.50 lbs.)	22821 (0.72 lbs.)	22841 (0.79 lbs.)	22861 (1.07 lbs.)	22881 (1.39 lbs.)	22901 (1.40 lbs.)	22941 (1.93 lbs.)	22961 (2.55 lbs.)	22981 (3.38 lbs.)	23021 (6.31 lbs.)	23041 (7.97 lbs.)	—	24001 (17.75 lbs.)
Rhino	—	—	—	21830 (2.61 lbs.)	—	21850 (3.17 lbs.)	21870 (3.82 lbs.)	—	21880 (5.27 lbs.)	—	—	—	—

LETTERS AND NUMBERS COMBO SET

SIZE	1/32"	1/16"	3/32"	1/8"	5/32"	3/16"	1/4"	5/16"	3/8"	1/2"	5/8"	3/4"	1"
Standard	—	20622 (2.88 lbs.)	20623 (2.85 lbs.)	20624 (2.95 lbs.)	—	20625 (3.78 lbs.)	20626 (5.14 lbs.)	—	—	20628 (12.18 lbs.)	—	—	—
Heavy Duty	21622 (2.84 lbs.)	21623 (3.75 lbs.)	21624 (3.71 lbs.)	21625 (3.76 lbs.)	21626 (5.08 lbs.)	21627 (5.13 lbs.)	21628 (7.68 lbs.)	21629 (9.5 lbs.)	21630 (12.25 lbs.)	21631 (29.75 lbs.)	21632 (22 lbs.)	21633 (28.95 lbs.)	21634 (80.9 lbs.)
Premier	24002 (3.67 lbs.)	24003 (3.68 lbs.)	24004 (3.93 lbs.)	24005 (5.13 lbs.)	24006 (7.07 lbs.)	24007 (7.11 lbs.)	24008 (9.07 lbs.)	24009 (11.51 lbs.)	—	21633 (23.65 lbs.)	—	24011 (31.75 lbs.)	24012 (77.15 lbs.)

Steel Letter and Number Stamp Sets - *For hand-held, hammer struck applications* Reversed, Round Face, and Dot Design

Steel Letter Sets

- Letter sets contain 27 pieces A thru Z plus ampersand (&)
- Tempered shanks for extra safety

Steel Number Sets

- Number sets contain 9 pieces 0 thru 9 (the 6 is used as a 9)
- Crowned striking surface ensures full force to the center of the stamp & textured shank provides firm easy grip

Steel Letter and Number Combo Sets

- Contains: A thru Z, ampersand, plus 0 thru 9 (the 6 is used as a 9)
- Fits flat in tool boxes

Refer to page 79 when selecting grade of stamp
Weights included below Item Number



LETTER STAMPS - PREMIER GRADE

SIZE	1/32"	1/16"	3/32"	1/8"	5/32"	3/16"	1/4"	5/16"	3/8"	1/2"
Reversed	25000 (1.44 lbs.)	25050 (2.08 lbs.)	25100 (2.23 lbs.)	25150 (3.19 lbs.)	25200 (4.18 lbs.)	25250 (4.17 lbs.)	25300 (5.70 lbs.)	25350 (7.56 lbs.)	25400 (5.67 lbs.)	25450 (10.69 lbs.)
Round Face	—	25700 (2.10 lbs.)	25750 (2.28 lbs.)	25800 (3.15 lbs.)	—	25850 (4.17 lbs.)	25900 (5.73 lbs.)	—	25950 (10.15 lbs.)	26000 (17.51 lbs.)
Dot Design	—	—	—	26200 (3.11 lbs.)	—	26250 (4.13 lbs.)	26300 (7.77 lbs.)	—	26350 (10.20 lbs.)	26400 (17.80 lbs.)

NUMBER STAMPS - PREMIER GRADE

SIZE	1/32"	1/16"	3/32"	1/8"	5/32"	3/16"	1/4"	5/16"	3/8"	1/2"
Reversed	25501 (0.50 lbs.)	25521 (0.73 lbs.)	25541 (0.53 lbs.)	25561 (1.40 lbs.)	25581 (1.06 lbs.)	25601 (1.40 lbs.)	25621 (1.93 lbs.)	25641 (2.53 lbs.)	25661 (3.23 lbs.)	25681 (5.97 lbs.)
Round Face	—	26061 (0.72 lbs.)	26081 (2.78 lbs.)	26101 (1.06 lbs.)	—	26121 (1.41 lbs.)	26141 (1.92 lbs.)	—	26161 (3.39 lbs.)	26181 (6.15 lbs.)
Dot Design	—	—	—	26601 (1.06 lbs.)	—	26621 (1.4 lbs.)	26641 (1.94 lbs.)	—	26661 (3.34 lbs.)	26681 (6.32 lbs.)

LETTERS AND NUMBER COMBO SET STAMPS - PREMIER GRADE

SIZE	1/32"	1/16"	3/32"	1/8"	5/32"	3/16"	1/4"	5/16"	3/8"	1/2"
Reversed	25682 (3.67 lbs.)	25683 (3.67 lbs.)	25684 (3.95 lbs.)	25685 (5.13 lbs.)	25686 (7.10 lbs.)	25687 (7.60 lbs.)	25688 (9.01 lbs.)	25689 (11.49 lbs.)	25690 (12.25 lbs.)	25691 (22.45 lbs.)
Round Face	—	26183 (3.67 lbs.)	26184 (3.91 lbs.)	26185 (5.04 lbs.)	—	26187 (7.06 lbs.)	26188 (9.01 lbs.)	—	26189 (12.25 lbs.)	26190 (22.45 lbs.)
Dot Design	—	—	—	26685 (5.04 lbs.)	—	26687 (7.07 lbs.)	26688 (9.06 lbs.)	—	—	—

DOUBLE DIGIT SETS

SIZE	1/4"
00-09	21080 (4.63 lbs.)
10-19	21081 (4.63 lbs.)
20-29	21082 (4.63 lbs.)
30-39	21083 (4.63 lbs.)
40-49	21084 (4.63 lbs.)
50-59	21085 (4.63 lbs.)
60-69	21086 (4.63 lbs.)
70-79	21087 (4.63 lbs.)
80-89	21088 (4.63 lbs.)
90-99	21089 (4.63 lbs.)

MARKING



CUSTOM SOLUTIONS AVAILABLE



Single Pieces and New 440C Stainless Steel Stamps

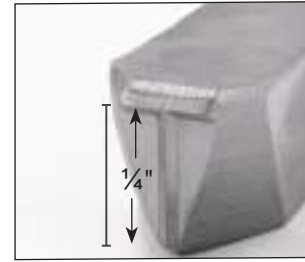

Single Pieces

- Individual Stamps
- Choice of Standard, Heavy Duty, Premier, Rhino, Reversed, Round Face, and Dot Design
- To order Single pieces use the letter set part number of the size and grade, followed by the character you wish to order

FOR EXAMPLE:

- 1/8" Standard Grade Letter "H" is item number 20200H
- 1/8" Standard Grade Number "5" is item number 202005

The size of the stamp describes the actual dimension of the mark that will be made by the stamp.

Refer to page 79 when selecting grade of stamp
Weights included below Item Number

SINGLE PIECE STAMPS

SIZE	1/32"	1/16"	3/32"	1/8"	5/32"	3/16"	1/4"	5/16"	3/8"	1/2"	5/8"	1"
Standard	—	20100 (0.04 lbs.)	20150 (0.04 lbs.)	20200 (0.04 lbs.)	—	20250 (0.06 lbs.)	20300 (0.10 lbs.)	—	20350 (0.20 lbs.)	20400 (0.32 lbs.)	—	—
Heavy Duty	20741 (0.04 lbs.)	20751 (0.04 lbs.)	20801 (0.06 lbs.)	20851 (0.06 lbs.)	20901 (0.10 lbs.)	20951 (0.16 lbs.)	21051 (0.16 lbs.)	21101 (0.20 lbs.)	21151 (0.26 lbs.)	21201 (0.54 lbs.)	21251 (0.56 lbs.)	—
Premier	22000 (0.06 lbs.)	22050 (0.06 lbs.)	22100 (0.08 lbs.)	22150 (0.10 lbs.)	22200 (0.14 lbs.)	22250 (0.14 lbs.)	22350 (0.18 lbs.)	22400 (0.26 lbs.)	22450 (0.32 lbs.)	22550 (0.58 lbs.)	22600 (0.82 lbs.)	22750 (1.70 lbs.)
Rhino	—	—	—	21730 (0.06 lbs.)	—	21750 (0.30 lbs.)	21760 (0.38 lbs.)	—	21770 (0.50 lbs.)	—	—	—
Reversed	25000 (0.06 lbs.)	25050 (0.06 lbs.)	25100 (0.06 lbs.)	25150 (0.10 lbs.)	25200 (0.14 lbs.)	25250 (0.14 lbs.)	25300 (0.20 lbs.)	25350 (0.26 lbs.)	25400 (0.32 lbs.)	25450 (0.58 lbs.)	—	—
Round Face	—	25700 (0.06 lbs.)	25750 (0.06 lbs.)	25800 (0.10 lbs.)	—	25850 (0.14 lbs.)	25900 (0.20 lbs.)	—	25950 (0.32 lbs.)	26000 (0.58 lbs.)	—	—
Dot Design	—	—	—	26200 (0.10 lbs.)	—	26250 (0.14 lbs.)	26300 (0.20 lbs.)	—	26350 (0.30 lbs.)	26400 (0.56 lbs.)	—	—

NEW 440C STAINLESS STEEL STAMPS

- Withstands highly corrosive environments
- Ideal for industries where cross contamination and corrosion resistance are critical
- Letter sets contain 27 pieces A thru Z plus ampersand (&)
- Number sets contain 9 pieces 0 thru 9 (the 6 is used as a 9)

Item No.	Description	Weight
29100	1/8" Stainless Steel Letter Set	3.18 lbs.
29150	1/8" Stainless Steel Number Set	1.91 lbs.
29175	1/8" Stainless Steel Combo Letter/Number Set	5.13 lbs.
29200	1/4" Stainless Steel Letter Set	6 lbs.
29250	1/4" Stainless Steel Number Set	2.02 lbs.
29275	1/4" Stainless Steel Combo Letter/Number Set	9.46 lbs.
29300	3/8" Stainless Steel Letter Set	10.69 lbs.
29350	3/8" Stainless Steel Number Set	2.14 lbs.
29375	3/8" Stainless Steel Combo Letter/Number Set	13.85 lbs.



Steel Hand Stamps

KEY STAMPS

- 1/2 x 3 inches long steel stamp

Item No.	Description	Pkg.
DO NOT DUPLICATE		
26990	1/16" Do Not Duplicate (2 Lines)	Box
26991	3/32" Do Not Duplicate (2 Lines)	Box
DO NOT COPY		
26992	3/32" Do Not Copy (2 Lines)	Box
MASTER		
26993	3/32" Master	Box



STAMPING HAMMERS

- Hammers are available with an engraved (fixed) character in one or both ends
- Hammers are also available with one interchangeable end
- Available with letters, numbers or symbols
- Available in 1/8", 3/16", 1/4" characters
- 2 character stamping hammers available upon request. Please call for a quote.

Item No.	Description	Pkg.
28060	Stamping Hammer with fixed character on one end	Bulk
28061	Stamping Hammer with two fixed ends	Bulk
28062	Stamping Hammer with interchangeable slot	Bulk
28063	Stamping Hammer Insert with character for 28062	Bulk



STEEL STAMP HOLDER

- Industrial grade steel stamp holder
- Protects your hand from striking a steel stamp
- Textured handle for comfortable and secure grip
- Allows the user to strike a steel stamp harder knowing their hand is safely out of harms way
- Slide lock keeps the steel stamp securely locked in place
- Holder will fit one (1) steel stamp with a character size ranging from 1/32" to 1/2" (a shank size up to 7/8" thick)

Item No.	Description	Weight
28065	Hand Stamp Holder 6.5" long	.72 lbs



Electric 2-Speed Pen Engraver

C.H. Hanson's 2-speed electric pencil engraver has a solid stainless steel body with a polymer ergonomic grip which provides comfort and ease of use. Its unique design provides a lightweight, slender and well balanced unit. With three types of engraving points and adjustable power, the most delicate to hardest material can be marked.

Item No.	Description	Weight
50002	Electric 2-speed pencil engraver	0.65 oz.

REPLACEMENT BITS:

50003	1 - HSS replacement bit
50004	1 - Carbide replacement bit
50005	1 - Diamond replacement bit

- Speeds 2
- Strokes per minute Low-3600/High-7200
- Voltage 110V
- Watts 8
- Point diameter 1/16" (.062)
- Tool length 7-1/4"
- Each unit includes one carbide, one HSS bit, and one diamond bit



Type and Type Holders

- Made of high shock alloy steel
- To order single type pieces, use the part number below and add the desired character
- For example: 1/16" letter "C" is 27630C



1/4 " CHARACTER TYPE

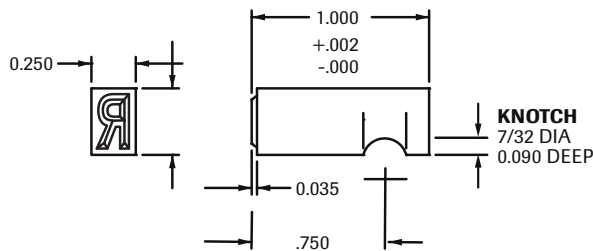

1/4 " CHARACTER TYPE

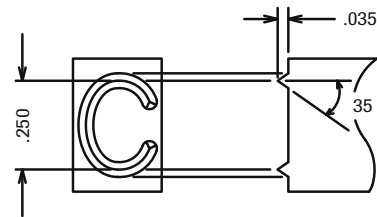

CHARACTER SIZE

BLANK SIZE

- 1/16" = .093 x .250 x 1.000
- 1/8" = .125 x .250 x 1.000
- 3/16" = .187 x .250 x 1.000
- 1/4" = .250 x .375 x 1.000

W-1 MATERIAL

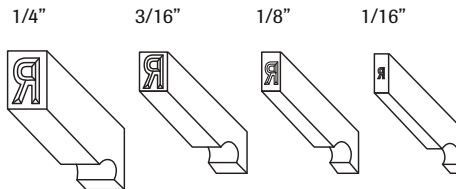

TYPE LETTER SETS

- Contains alloy letters from A-Z

Item No.	Description	Package
27640	1/2" Single Piece	Bagged
27630	1/16" Steel Type Letter Sets	Bagged
27632	1/8" Steel Type Letter Sets	Bagged
27634	3/16" Steel Type Letter Sets	Bagged
27636	1/4" Steel Type Letter Sets	Bagged
27638	3/8" Steel Type Letter Sets	Bagged

TYPE NUMBER SETS

- Contains alloy steel numbers from 0-9

27631	1/16" Steel Type Number Sets	Bagged
27633	1/8" Steel Type Number Sets	Bagged
27635	3/16" Steel Type Number Sets	Bagged
27637	1/4" Steel Type Number Sets	Bagged
27639	3/8" Steel Type Number Sets	Bagged
27641	1/2" Steel Type Number Sets	Bagged

SINGLE TYPE PIECES

- Individual pieces are letters A-Z or numbers from 0-9

Item No.	Description	Package
27630_	1/16" Single Piece	Bagged
27632_	1/8" Single Piece	Bagged
27634_	3/16" Single Piece	Bagged
27636_	1/4" Single Piece	Bagged
27638_	3/8" Single Piece	Bagged
27640_	1/2" Single Piece	Bagged

TYPE BLANKS/SPACERS

- Used to separate letters, numbers or add spaces

27630BL	1/16" Blank Space	Bagged
27632BL	1/8" Blank Space	Bagged
27634BL	3/16" Blank Space	Bagged
27636BL	1/4" Blank Space	Bagged
27638BL	3/8" Blank Space	Bagged
27640BL	1/2" Blank Space	Bagged

Type and Type Holders

- Made of high shock alloy steel
- Most durable steel type holders on the market
- Easily interchangeable letters and numbers
- Save time and money with one step marking
- Steel type not included unless purchased as a kit

TYPE HOLDERS

- Unique locking bar prevents type from incorrect insertion
- Allows for marking one line of characters into various industrial products
- Package - bagged

Item No.	Description	Weight
27600	1/16" Type Holder - character capacity 10	0.68 lbs.
27601	1/16" Type Holder - character capacity 16	0.77 lbs.
27620	1/8" Type Holder - character capacity 8	0.69 lbs.
27621	1/8" Type Holder - character capacity 12	0.28 lbs.
27624	1/8" Type Holder - character capacity 15	0.84 lbs.
27604	3/16" Type Holder - character capacity 10	0.98 lbs.
27605	3/16" Type Holder - character capacity 15	0.87 lbs.
27608	1/4" Type Holder - character capacity 8	1.04 lbs.
27609	1/4" Type Holder - character capacity 12	0.86 lbs.
27610	3/8" Type Holder - character capacity 6	1.07 lbs.
27611	3/8" Type Holder - character capacity 10	0.81 lbs.
27612	1/2" Type Holder - character capacity 4	0.93 lbs.
27613	1/2" Type Holder - character capacity 6	0.93 lbs.



KITS

- Packed in sturdy, professional grade wooden box
- Includes type holder and type
- 40 pieces: A-Z, 0-9, Dash, 3 Blank Spacers
- 48 pieces also include 8 extra characters of your choice

Item No.	Description	Package
27770	40 piece kit of type 1/16"	Box
27771	48 piece kit of type 1/16"	Box
27774	40 piece kit of type 1/8"	Box
27775	48 piece kit of type 1/8"	Box
27778	40 piece kit of type 3/16"	Box
27779	48 piece kit of type 3/16"	Box
27782	40 piece kit of type 1/4"	Box
27783	48 piece kit of type 1/4"	Box





HANDICAP STENCIL



Item No.	Character Size	Height	Width
70340	21.5"	24"	24"
70341	28"	34"	32"
70342	34"	40"	36"
70343*	39"	48"	40"

***Most Popular Size**

Commercial Stencils - 1/8" Heavy Duty Low Density Polyethylene (LDPE)

- Long Lasting material built for daily use
- Not damaged by any paint or solvents
- Lays flat and resists lifting when painted with a spray gun or spray can
- Precision cut to ensure high quality marking
- Cleans easily after paint has dried
- Custom wording and images available
- Character sizes from 1/2" to 12" available
- Most stencils in stock and ship within 24 hours
CALL FOR AVAILABILITY
- (Curb) has additional material above legend for optimal use when stenciling curbs



NO PARKING

Item No.	Character Size	Height	Width
69999	4" x 3"	10"	36"
70000	4" x 3" (Curb)	10"	36"
70001	6" x 4"	12"	54"
70002*	12" x 9"	18"	103"
70003	18" x 12"	24"	130"
70004	24" x 12"	30"	130"

FIRE LANE

70029	4" x 3"	10"	36"
70030	4" x 3" (Curb)	10"	36"
70031*	12" x 9"	18"	100"
70032	18" x 12"	24"	120"

RESERVED

70040	6" x 4"	12"	48.5"
70041	12" x 9"	18"	92"

VISITORS

70050	6" x 4"	12"	48.5"
70051*	12" x 9"	18"	92"

STOP

70060	6" x 4"	12"	26.5"
70061	12" x 9"	18"	48"
70062	18" x 12"	24"	60"
70063*	24" x 12"	30"	60"
70064	36" x 12"	42"	60"

ENTER

70080	6" x 4"	12"	32"
70081	12" x 9"	18"	59"

WAY

70140	6" x 4"	12"	21"
70141	12" x 9"	18"	37"

*Most Popular Size



Commercial Stencils - 1/8" Heavy Duty Low Density Polyethylene (LDPE)

- Long Lasting material built for daily use
- Not damaged by any paint or solvents
- Lays flat and resists lifting when painted with a spray gun or spray can
- Precision cut to ensure high quality marking
- Cleans easily after paint has dried
- Custom wording and images available
- Character sizes from 1/2" to 12" available
- Most stencils in stock and ship within 24 hours
CALL FOR AVAILABILITY
- (Curb) has additional material above legend for optimal use when stenciling curbs

LOADING

Item No.	Character Size	Height	Width
70160	6" x 4"	12"	43"
70161	12" x 9"	18"	81"



RESIDENT

70330	6" x 4"	12"	48.5"
70331	12" x 9"	18"	92"



ZONE

70270	6" x 4"	12"	26.5"
70271	12" x 9"	18"	48"



YIELD

70292	18" x 12"	24"	74"
70293	24" x 12"	30"	74"



EXIT

70092	18" x 12"	24"	60"
70093	24" x 12"	30"	60"



ONLY

70103	24" x 12"	30"	74"
-------	-----------	-----	-----



ARROW COMBO

70491*	62" Long	106"	40"
--------	----------	------	-----



ARROW CURVED

70480	42" Long	48"	36"
70481*	62" Long	70"	48"

ARROW STRAIGHT

70470	42" Long	48"	24"
70471*	62" Long	70"	40"
70472	84" Long	96"	48"

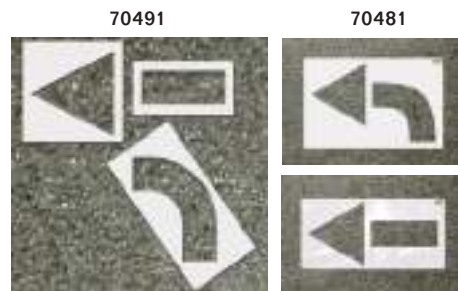

*Most Popular Size

70471

MARKING

CUSTOM SOLUTIONS AVAILABLE

Commercial Stencils - 1/8" Heavy Duty Low Density Polyethylene (LDPE)

- Long Lasting material built for daily use
- Not damaged by any paint or solvents
- Lays flat and resists lifting when painted with a spray gun or spray can
- Precision cut to ensure high quality marking
- Cleans easily after paint has dried
- Custom wording and images available
- Character sizes from 1/2" to 12' available
- Most stencils in stock and ship within 24 hours **CALL FOR AVAILABILITY**
- (Curb) has additional material above legend for optimal use when stenciling curbs



LETTER KIT - 29 PC.

Item No.	Character Size	Height	Width
Curb Marking			
70411	3"x2"	10"	4"
70413	4"x2.75"	10"	4.75"
HWY Fonts			
70410	3"x2"	7"	4"
70412	4"x2.75"	8"	4.75"
70414	5"x3.25"	9"	5.25"
70415	6"x4"	10"	6"
70416	8"x5.25"	12"	7.25"
70417	10"x6.6"	14"	8.6"
70418*	12"x9"	16"	11"

LETTER KIT - 38 PC.

Item No.	Character Size	Height	Width
Curb Marking			
70441	3"x2"	10"	4"
70443	4"x2.75"	10"	4.75"
HWY Fonts			
70440	3"x2"	7"	4"
70445*	6"x4"	10"	6"
70448*	12"x9"	16"	11"



NUMBER KIT - 12 PC.

Item No.	Character Size	Height	Width
For Curb Marking			
70351	3"x2"	10"	4"
70353	4"x2.75"	10"	4.75"
HWY Font			
70350	3"x2"	7"	4"
70352*	4"x2.75"	8"	4.75"
70354	5"x3.25"	9"	5.25"
70355*	6"x4"	10"	6"
70356	8"x5.25"	12"	7.25"
70357	10"x6.6"	14"	8.6"
70358*	12"x9"	16"	11"

NUMBER KIT - 18 PC.

Item No.	Character Size	Height	Width
HWY Font			
70380	3"x2"	7"	4"
70382	4"x2.75"	8"	4.75"
70385	6"x4"	10"	6"
70387	10"x6.6"	14"	8.6"
70388*	12"x9"	16"	11"

*Most Popular Size



CUSTOM WORD

Item No.	Character Height	Character Width
70802	4"	2.5"
70803	6"	4"
70804	8"	5.5"
70805	10"	6.6"
70806	12"	9"



Commercial Stencils - Light Duty



PLASTIC

- Made of interlocking flexible PVC plastic
- Interlocks in the corners
- Washable, cleans with a paint solvent
- Each 46 pc set contains: AABCDEFHGHIJKLMNO P Q RR SSTUVWXYZ, All numbers (10 pieces 0-9), 1-Dollar sign, 1-Ampersand, 1-Large space, 1-Small space, 1-Period, and 1-Dash
- 138 pc set contains 3 of the 46 pc set

Item No.	Description	Package
10191	1" - 46 pc. Plastic Interlocking Stencil	Box
10192	2" - 46 pc. Plastic Interlocking Stencil	Box
10193	3" - 46 pc. Plastic Interlocking Stencil	Box
10194	4" - 46 pc. Plastic Interlocking Stencil	Box
10198	6" - 46 pc. Plastic Interlocking Stencil	Box
10189	1" - 138 pc. Plastic Interlocking Stencil	Box
10190	2" - 138 pc. Plastic Interlocking Stencil	Box
10195	3" - 138 pc. Plastic Interlocking Stencil	Box
10187	4" - 138 pc. Plastic Interlocking Stencil	Box
10188	6" - 138 pc. Plastic Interlocking Stencil	Box

ECONOMY GRADE

- Promotes safety in and around the factory
- 2" characters unless otherwise indicated
- Made of .015" PVC plastic 1/64"
- Conforms to OSHA Regulation 1910.145
- Reusable

Item No.	Description	Package
12400	NO SMOKING	Carded
12401	NO PARKING	Carded
12402	KEEP OUT	Carded
12403	NO TRESPASSING	Carded
12404	FOR SALE	Carded
12405	FOR RENT	Carded
12406	DANGER - 2.5" Characters	Carded
12407	CAUTION - 2.5" Characters	Carded
12408	WARNING - 2.5" Characters	Carded
12409	(Arrow Symbol) 10" long	Carded
12410	FLAMMABLE	Carded
12411	EXIT	Carded
12412	HIGH VOLTAGE	Carded
12413	FIRE EXTINGUISHER	Carded
12414	GARAGE SALE	Carded
12415	BIOHAZARD	Carded
12416	(Handicapped Symbol) - 15.5" dia.	Carded
12417	(No Parking Symbol) - 15.5" dia.	Carded
12418	(No Smoking Symbol) - 15.5" dia.	Carded
12420	WATCH YOUR STEP - 3" char.	Carded
12421	KEEP AISLE CLEAR - 3" char.	Carded



ECONOMY GRADE

- Promotes safety and direct traffic in the parking lot
- 12" characters unless otherwise indicated
- Made of .015" PVC plastic 1/64"
- Large, easy to read characters and symbols

Item No.	Description	Package
12430	NO PARKING	Tube
12431	HANDICAP	Tube
12432	FIRE LANE	Tube
12433	EXIT ONLY	Tube
12434	RESERVED	Tube
12435	VISITORS	Tube
12436	Straight Arrow Symbol - 37" long	Tube
12437	Curved Arrow Symbol - 43" long	Tube
12438	Handicap Symbol - 43" high	Tube
12439	ENTRANCE	Tube
12441	DISABLED	Tube
12460	Stencil Parking Lot Kit inc. 12430, 12434, 12435, 12436, 12437, 12438	Tube





Interlocking Brass Stencils



A

A SINGLE BRASS STENCIL

- Re-usable durable 28 gauge brass stencil
- Cleans easily with paint solvent
- Stencils slide together and come apart easily
- To order individual stencils, use the part number below and add the desired character
- For example 1" letter "H" is item number 10008H, 1/2" number "5" is item number 100065
- For additional punctuation characters use the following:

BG= Beginner	CM=Comma	DL=Dollar
PE= Period Ender	CE= Cent	DA= Dash
PD=Period	SP= Space	

Item No.	Description	Package
10006_	1/2" Single Stencil	Box
10007_	3/4" Single Stencil	Box
10008_	1" Single Stencil	Box
10009_	1-1/2" Single Stencil	Box
10011_	2" Single Stencil	Box
10012_	2-1/2" Single Stencil	Box
10013_	3" Single Stencil	Box
10014_	4" Single Stencil	Box
10015_	5" Single Stencil	Box
10016_	6" Single Stencil	Box
10160_	8" Single Stencil	Box
10161_	10" Single Stencil	Box
10162_	12" Single Stencil	Box
10175_	1" Vertical Stencil	Box
10176_	2" Vertical Stencil	Box
10177_	3" Vertical Stencil	Box

Interlocking Brass Stencils

A



A 15 PIECE SINGLE NUMBER SET

- Each set contains 15 pieces as follows:
1 2 3 4 5 6 7 8 9 0
Other: 1-Beginner 1-Plain Ender 1-Dash 1-Period

Item No.	Description	Package
10006	1/2" Numbers	Box
10007	3/4" Numbers	Box
10008	1" Numbers	Box
10009	1-1/2" Numbers	Box
10011	2" Numbers	Box
10012	2-1/2" Numbers	Box
10013	3" Numbers	Box
10014	4" Numbers	Box
10015	5" Numbers	Box
10016	6" Numbers	Box

B



B 33 PIECE SINGLE LETTER SET

- Each set contains 33 pieces as follows:
All letters (26 pieces A-Z)
Other: 1-Beginner 1-Period Ender 1-Comma
1-Dash 1-Period 1-Ampersand 1-Apostrophe

Item No.	Description	Package
10026	1/2" Letters	Box
10027	3/4" Letters	Box
10028	1" Letters	Box
10029	1-1/2" Letters	Box
10031	2" Letters	Box
10032	2-1/2" Letters	Box
10033	3" Letters	Box
10034	4" Letters	Box
10035	5" Letters	Box
10036	6" Letters	Box

C



C 45 PIECE SINGLE LETTER AND NUMBER SET

- Each set contains 45 pieces as follows:
All letters (26 pieces A-Z), 0123456789
Other: 1-Beginner 1-Plain Ender 1-Period Ender 1-Comma
2-Spacers 1-Dash 1-Period 1-Ampersand 1-Apostrophe

Item No.	Description	Package
10066	1/2" Letters & Numbers	Box
10067	3/4" Letters & Numbers	Box
10068	1" Letters & Numbers	Box
10069	1-1/2" Letters & Numbers	Box
10071	2" Letters & Numbers	Box
10072	2-1/2" Letters & Numbers	Box
10073	3" Letters & Numbers	Box
10074	4" Letters & Numbers	Box
10075	5" Letters & Numbers	Box
10076	6" Letters & Numbers	Box

MARKING



CUSTOM SOLUTIONS AVAILABLE

Interlocking Brass Stencils

A



A 77 PIECE SINGLE LETTER AND NUMBER SET

- Each set contains 77 pieces as follows: AA BB CC DD EE FF GG HH II JJ K LL MM NN OO PP Q RR SS TT UU VV WW XY Z, 11 22 33 44 55 66 77 88 99 00 1-Beginner, 1-Plain Ender, 2-Spacers, 1-Comma, 1-Dash, 2-Period, 1-Period Ender, 1-Ampersand, 1-Apostrophe

Item No.	Description	Package
10106	1/2" Letters & Numbers	Box
10107	3/4" Letters & Numbers	Box
10108	1" Letters & Numbers	Box
10109	1-1/2" Letters & Numbers	Box
10111	2" Letters & Numbers	Box
10112	2-1/2" Letters & Numbers	Box
10113	3" Letters & Numbers	Box
10114	4" Letters & Numbers	Box
10115	5" Letters & Numbers	Box
10116	6" Letters & Numbers	Box

B



B 92 PIECE SINGLE LETTER AND NUMBER SET

- Each set contains 92 pieces as follows: AAA BB CC DD EEEE FF GG HH III JJ KK LL MM NNN OOO PP Q RR SSS TT UU VV WW XX YY ZZ 111 22 33 44 55 66 77 88 99 000, 1-Beginner, 1-Plain Ender, 3-Spacers, 1-Period Ender, 1-Comma, 1-Dash, 2-Periods, 2-Ampersand, 1-Apostrophe

Item No.	Description	Package
10146	1/2" Letters & Numbers	Box
10147	3/4" Letters & Numbers	Box
10148	1" Letters & Numbers	Box
10149	1-1/2" Letters & Numbers	Box
10151	2" Letters & Numbers	Box
10152	2-1/2" Letters & Numbers	Box
10153	3" Letters & Numbers	Box
10154	4" Letters & Numbers	Box
10155	5" Letters & Numbers	Box
10156	6" Letters & Numbers	Box

C



C CONSUMER PACKED SET - CARDED

- Ideal for Retail hanging packaging

Item No.	Description	Package
10303	1" Stencil Numbers (15 pieces)	Carded
10305	2" Stencil Numbers (15 pieces)	Carded
10307	3" Stencil Numbers (15 pieces)	Carded
10323	1" Stencil Letters (33 pieces)	Carded
10325	2" Stencil Letters (33 pieces)	Carded
10327	3" Stencil Letters (33 pieces)	Carded

MARKING



CUSTOM SOLUTIONS AVAILABLE



Interlocking Brass Stencils



A OVERSIZED LETTER

- Each set contains 33 pieces as follows: All letters (26 pieces A-Z), 1-Beginner, 1-Period Ender, 1-Spacer, 1-Comma, 1-Dash, 1-Period, 1-Ampersand

Item No.	Description	Package
10165	8" Gothic Style Letters	Box
10166	10" Gothic Style Letters	Box
10167	12" Gothic Style Letters	Box

B OVERSIZED NUMBER

- Each set contains 13 pieces as follows: All numbers (10 pieces 0-9), 1-Beginner, 1-Plain Ender, 1-Period

Item No.	Description	Package
10160	8" Gothic Style Numbers	Box
10161	10" Gothic Style Numbers	Box
10162	12" Gothic Style Numbers	Box

C VERTICAL COMPOSITION 33 PIECE SET

- Each set contains 33 pieces as follows: All letters (26 pieces A-Z) 1-Beginner, 1-Period Ender, 1-Spacer, 1-Comma, 1-Dash, 1-Period, 1-Ampersand

Item No.	Description	Package
10178	1" Vert. Composition Letters	Box
10179	2" Vert. Composition Letters	Box
10181	3" Vert. Composition Letters	Box

D VERTICAL COMPOSITION 13 PIECE SET

- Each set contains 13 pieces as follows: All numbers (10 pieces 0-9) 1-Beginner, 1-Plain Ender, 1-Period

Item No.	Description	Package
10175	1" Vert. Composition Numbers	13 pc Box
10176	2" Vert. Composition Numbers	13 pc Box
10177	3" Vert. Composition Numbers	13 pc Box

Custom Brass & Plastic Stencils

- C.H. Hanson can cut virtually any message or design in durable .012" thick brass, 1/16" thick polyethylene (LDPE), 1/8" thick polyethylene (LDPE)
- Create a permanent stencil of your company's name or logo, or any special design you need
- Call for quote on all custom stencils



Interlocking Brass Stencils Accessories



A



B

A FIGURE WHEELS - BRASS

- Brass figure wheels make numbering jobs quick & easy
- Gothic figures in style shown, with wood handle for turning and locating
- Other custom made stencils in brass or plastic quoted upon request

Item No.	Description	Package
12311	With 1-1/2" figures	Bulk
12310	With 1" figures	Bulk
12312	With 2" figures	Bulk

B BRISTLE BRUSH

- These varnished wood handle brushes feature a nickel plated steel ferrule to use with ink pot or your own container
- Hog hair bristles
- Compatible with all types of ink

Item No.	Description	Package
12001	No. 4 for 1.5" to 2.5" character	Bag
12002	No. 6 for 3" character	Bag
12003	No. 8 for 4", 5", 6" character	Bag
12004	No.10 for 8", 10", 12" character	Bag
12006	No.14 for 8",10", 12" character	Bag

C FOUNTAIN ROLLERS

- Aluminum construction for long wear and tough applications
- FR100 refillable barrel
- Long-lasting Neoprene roller for fewer replacements

Item No.	Description	Package
12122	FR-150 replacement -1.5"	Box
12121	FR-100 Marsh - 3"	Box
12120	FR-100 Marsh - 1.5"	Box
12123	FR-150 replacement -3"	Box



C



D



E

D FOUNTAIN BRUSH

- Ideal for big stenciling jobs
- Use with both all purpose and porous inks

Item No.	Description	Package
12008	Marsh FB-26 Fountain Brush	Box
12009	Marsh FB-26 Fountain Brush	Box

E STENCIL INKS

Item No.	Description	Package
12164	Black all purpose	Quart
12160	Black all purpose	Gallon



Pencils, Crayons, Markers, and Accessories

A RETRACTABLE PENCIL PULL®

- Self retractable pencil holder
- Holds carpenter pencils, crayons, pens, markers and more
- Easily clips on belt, pocket or shirt
- Stop looking for your pencil, this is one tool you don't think you need until you try it
- Loaded on a clip strip of 12 each per case pack

Item No.	Description	Package
10570	Retractable Pencil Pull® pencil holder	Clip strip

A



B CARPENTER PENCILS

- Perfect for marking fine lines, molding, saw lines, drill points, etc.
- Must be ordered in case pack quantities

Item No.	Description	Package
Case Pack of 72		
10378	Hard Lead	Boxed
10379	Soft Lead	Boxed
10380	Medium Lead	Boxed
10231	Red Lead Carpenter's Pencil	Boxed
10316	Economy Medium Basswood	Boxed
Case Pack of 144 (gross)		
10398	With Hard Lead	Display Box
10399	With Soft Lead	Display Box
10400	With Medium Lead	Display Box
10560_PUR	Sure-Point™ Finish Carpenter's Pencil (Round)	Boxed
10561	Finish Pencil, Red, Lacquered (Round)	Boxed

B



C VERSASHARP

- Sharpens carpenter pencils, lumber crayons, and standard pencils
- Ergonomically designed

Item No.	Description	Package
00202	VersaSharp™ Sharpener-25 count	Display Box
00208	VersaSharp™ Fish Bowl - 25 count	Carded

C



00208



00202



Pencils, Crayons, Markers, and Accessories

A COMBO MARK

- Double-ended marking tool
- For all your construction marking needs
- Combines carpenter pencil with lumber crayon
- Marks wood, concrete, metal, or glass
- 24 each per case pack

Item No.	Description	Package
10456	Combo Mark with yellow lumber crayon	Bulk
10457	Combo Mark with red lumber crayon	Bulk
10458	Combo Mark with blue lumber crayon	Bulk

A



B PENCIL SHARPENER/COMBO

00213	10 Hanson Pencils with 1 VersaSharp	Tube
-------	-------------------------------------	------

• 15 ProSharp™ Pencil Kit contains: 15 of our best selling medium lead round finishing pencils with erasers, ProSharp™ chuckable pencil sharpener and re-usable storage tube
 Case Pack: 02010-9 tubes per case pack, 00206 / 12 each per case pack, 00221 / 12 each per case pack

02010	ProSharp™ with 15 pencils	Tube
00206	Combo 2 Pencils with VersaSharp™	Carded
00221	6 Hanson Pencils with 1 VersaSharp	Carded

B



C PENCIL ARMOR®

- Helps prevent pencil from breaking
- Heavy Duty Pocket Clip
- Case Pack:
10405 - 24 each per case pack / 00118 - 12 each per case pack

Item No.	Description	Package
10405	Pencil Armor®	Display Box
00118	Pencil Armor® and Carp. Pencil	Carded

C



D WOOD LUMBER CRAYON HOLDER

- Securely holds crayon for better control
- Prevents crayon from breaking
- Allows use of full crayon
- 12 each per case pack

Item No.	Description	Package
10387	Wood Lumber Crayon - Holder	Bulk



Pencils, Crayons, Markers, and Accessories

A CRAYON ARMOR

- Securely holds crayon • Prevents crayon from breaking
- Allows use of full crayon
- Case Pack:
10404 - 24 each per case pack / 00125 - 12 each per case pack

Item No.	Description	Package
10404	Crayon Armor® Holder	Display Box
00125	Crayon Armor® Holder and Crayon	Carded

B LUMBER CRAYONS

- Extend working life with Crayon Armor®
- 1/2" hexagon x 4.5" long

Premier - Boxed 12

- Marks lumber, metal, concrete and most other surfaces
- No Melt Crayon withstands 300°F - Weather/fade/sun resistant

Item No.	Description	Package
10382	Red Premier	Boxed
10383	Blue Premier	Boxed
10384	Black Premier	Boxed
10385	Yellow Premier	Boxed

Standard - Boxed 12

- For marking wood, metal, concrete

10365	Red Standard	Boxed
10366	Blue Standard	Boxed
10367	Black Standard	Boxed
10368	Yellow Standard	Boxed
10370	White Standard	Boxed

Standard - 2 pk. Carded

10352	Blue	Carded
10353	Black	Carded
10356	Red	Carded
10386	Yellow	Carded

Standard - 6 pk. Carded

10494	Blue Standard	Carded
10496	Red Standard	Carded
10497	Black Standard	Carded
10498	Yellow Standard	Carded

C CHINA MARKERS

- Marks on china, glass or plastic • Marks on wet surfaces
- Marking pencils for porous and non-porous surfaces
- Easy peel off wrap
- 5/16" diameter x 6-3/4" long

Boxed 12

Item No.	Description	Package
10390	Red China Marker	Boxed
10391	Black China Marker	Boxed
10392	White China Marker	Boxed
10622	Yellow China Marker	Boxed
10623	Green China Marker	Boxed
10625	Blue China Marker	Boxed

Carded - 2 pk.

10260	Black China Marker	Carded
10261	Red China Marker	Carded
10262	White China Marker	Carded
10263	Yellow China Marker	Carded
10264	Green China Marker	Carded
10265	Blue China Marker	Carded

A



B



C



Pencils, Crayons, Markers, and Accessories

A PAINT MARKERS

- Delivers permanent, high visibility mark on all surfaces
- Marks through oily, rusty, greasy films. Resists water, wear, & UV fading
- Marker cap matches color of the paint
- Perfect to use with stencils
- 1/2" diameter x 5.5" long

Carded - 2 each per pack

Item No.	Description	Package
10362	Red Paint Marker	Carded

Boxed 12

10295	Black Paint Markers	Boxed
10297	Red Paint Markers	Boxed
10298	White Paint Markers	Boxed
10299	Yellow Paint Markers	Boxed

B RAILROAD CHALK

- For temporary, high visibility marking of surfaces such as metal, wood & concrete
- 7/8" tapered diameter by 4" long
- Smooth chalk formulation for easy glide application

Item No.	Description	Package
10374	White Railroad Chalk/box of 144	Bulk
10393	Blue Railroad Chalk/box of 144	Bulk
10394	Yellow Railroad Chalk/box of 144	Bulk
10401	Red Railroad Chalk/box of 144	Bulk

C HALF MOON CAKE CARPENTERS CHALK

- Designed for hand marking of chalk lines
- 2-1/2" diameter hemispherical cakes fit easily in your hand
- 72 pieces per box
 - Bold colors

Item No.	Description	Package
10395	White Half Moon Carpenter Chalk	Bulk
10396	Blue Half Moon White Chalk	Bulk
10397	Red Half Moon Carpenter Chalk	Bulk

A



B

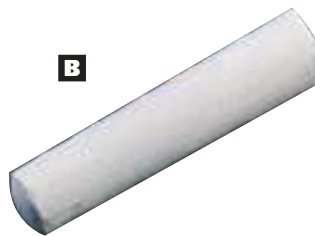

C





Quick, Secure, One-Handed Spring Clamps

Features:

- Made with high quality forged American steel
- Made in the USA
- Stronger than imports*
- Tang compression spring keeps the clamp jaws in alignment

** 2" Heritage Spring Clamps 30% stronger and
1" Heritage Spring Clamps 20% stronger than imports*



ATTENZIONE: PERICOLO DI LESIONI PERSONALI. EVITARE IL CONTATTO DIRETTO CON LE PARTI MOVENTI. LEGGERE IL MANUALE D'ISTRUZIONI. IL MANIPOLATORE DEVE ESSERE USATO IN CONFORMITÀ CON LE ISTRUZIONI. IL MANIPOLATORE DEVE ESSERE USATO IN CONFORMITÀ CON LE ISTRUZIONI. IL MANIPOLATORE DEVE ESSERE USATO IN CONFORMITÀ CON LE ISTRUZIONI.





Heritage Spring Clamps

- Made with high quality forged American steel
- Manufactured in the USA
- Up to 30% stronger than imports
- Tang compression spring keeps the clamp jaws in alignment
- Available in 4 sizes, with and without protective tip

Item #	Description	Package
64011	1" Spring Clamps with Tips	12 pieces
64012	2" Spring Clamps with Tips	12 pieces
64013	3" Spring Clamps with Tips	6 pieces
64014	4" Spring Clamps with Tips	6 pieces
64021	1" Spring Clamps without Tips	12 pieces
64022	2" Spring Clamps without Tips	12 pieces
64023	3" Spring Clamps without Tips	6 pieces
64024	4" Spring Clamps without Tips	6 pieces

Heritage Wood Handscrew Clamps

- Made from quality North American rock maple or birch wood
- Manufactured in the USA for craftsmen everywhere
- 4 each per case pack
- Available in three sizes
- Jaws adjust to any angle for clamping all surfaces

Item #	Description	Package
64001	8" Wood Handscrew Clamp	4 pieces
64002	10" Wood Handscrew Clamp	4 pieces
64003	12" Wood Handscrew Clamp	4 pieces

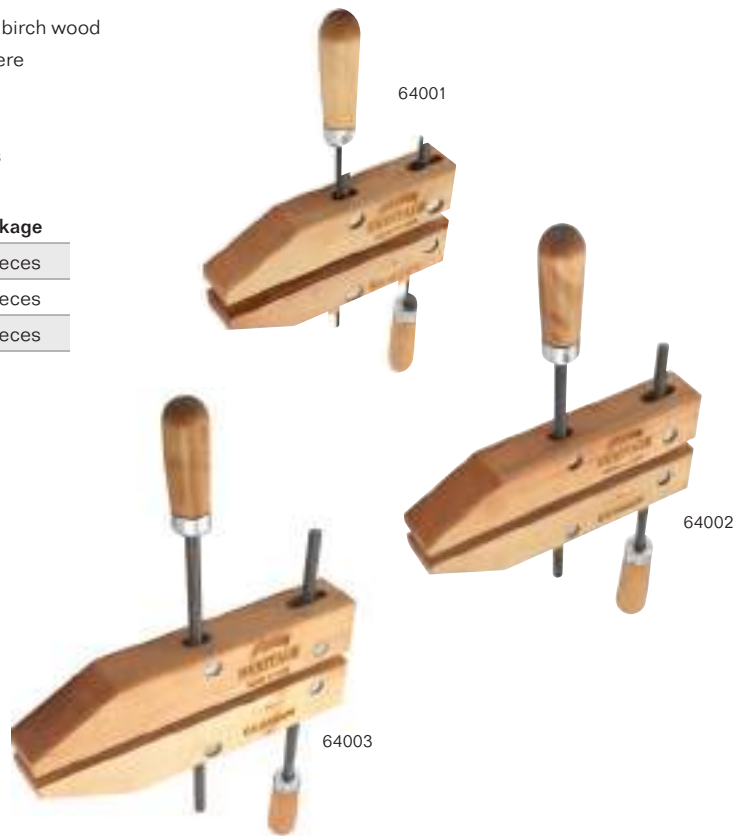

HERITAGE
 CLAMPS





Manual Locking Pliers

- Durable nickel plate finish
- Limited Lifetime Warranty
- Constructed for quality, strength, and durability
- 6 each per case pack

10" Curved Jaw Locking Pliers

Item No.	Jaw Opening	Throat Depth	Jaw Width	Package
71050	2"	1 1/2"	1/2"	Clam Shell

7" Curved Jaw Locking Pliers

Item No.	Jaw Opening	Throat Depth	Jaw Width	Package
70750	1 3/4"	1 1/4"	1/2"	Clam Shell

5" Curved Jaw Locking Pliers

Item No.	Jaw Opening	Throat Depth	Jaw Width	Package
70550	1 1/4"	1 1/4"	3/8"	Clam Shell

10" Straight Jaw Locking Pliers

Item No.	Jaw Opening	Throat Depth	Jaw Width	Package
71000	1 3/4"	1 1/4"	5/8"	Clam Shell

7" Straight Jaw Locking Pliers

Item No.	Jaw Opening	Throat Depth	Jaw Width	Package
70700	1 1/2"	1 1/4"	1/2"	Clam Shell

9" Long Nose Locking Pliers

Item No.	Jaw Opening	Throat Depth	Jaw Width	Package
70950	2 3/4"	2 1/2"	3/8"	Clam Shell

6" Long Nose Locking Pliers

Item No.	Jaw Opening	Throat Depth	Jaw Width	Package
70650	2"	2"	3/8"	Clam Shell



70550



70700



70650

Manual Locking Pliers and Clamps

- Constructed for quality, strength, and durability
- Durable nickel plate finish
- 6 each per case pack
- Limited Lifetime Warranty

11" Locking C-Clamp

Item No.	Jaw Opening	Throat Depth	Jaw Width	Package
71100	3 1/2"	3 1/4"	1/2"	Clam Shell



71100

6" Locking C-Clamp

Item No.	Jaw Opening	Throat Depth	Jaw Width	Inside Clearance	Package
70600	2"	1 3/4"	2 3/8"	2 3/8"	Clam Shell



70620

11" Locking C-Clamp with pads

Item No.	Jaw Opening	Throat Depth	Jaw Width	Package
71120	3 1/2"	3 1/4"	1 1/4"	Clam Shell

6" Locking C-Clamp with pads

Item No.	Jaw Opening	Throat Depth	Jaw Width	Inside Clearance	Package
70620	1 3/4"	1 3/4"	3/4"	2 3/8"	Clam Shell



70800

8" Locking Sheet Metal Clamp

Item No.	Jaw Opening	Throat Depth	Jaw Width	Package
70800	1 1/2"	1 3/4"	3"	Clam Shell

9" Locking Welding Clamp

Item No.	Jaw Opening	Throat Depth	Jaw Width	Package
70900	2"	2 1/2"	2 3/4"	Clam Shell



70900

20" Locking Chain Clamp

Item No.	Jaw Opening	Max Pipe Size	Package
72000	20"	5"	Clam Shell

71999 18" Chain to fit Part No 72000 Bagged



72000

71999

18" Locking C-Clamp • 5 each per case pack

Item No.	Jaw Opening	Throat Depth	Jaw Width	Inside Clearance	Package
71800	8"	10"	1/2"	4"	Carded

18" Locking C-Clamp with pads • 5 each per case pack

Item No.	Jaw Opening	Throat Depth	Jaw Width	Inside Clearance	Package
71825	8"	10"	1 1/4"	4"	Carded



swivel pads



Pre-Cut Stainless Steel Shim Kits



PRE-CUT STAINLESS STEEL FULL SHIM KITS

- Full Shim Kit contains 20 pieces of each thickness
- Pre-packaged and foam protected in sturdy metal toolbox
- Each kit contains the following thicknesses: .001, .002, .003, .004, .005, .010, .015, .020, .025, .050, .075, .100, .125
- A- 2" x 2", Slot width 5/8", Rec. bolt size 1/4"-5/8"
- B- 3" x 3", Slot width 3/4", Rec. bolt size 1/2"-3/4"
- C- 4" x 4", Slot width 1 1/4", Rec. bolt size 3/4"-1 1/4"
- D- 5" x 5", Slot width 1 5/8", Rec. bolt size 1"-1 5/8"

Item No.	Description	Package
A-Ful	A (2" x 2") Full Shim Kit	Box
B-Ful	B (3" x 3") Full Shim Kit	Box
C-Ful	C (4" x 4") Full Shim Kit	Box
D-Ful	D (5" x 5") Full Shim Kit	Box

PRE-CUT STAINLESS STEEL MINI SHIM KITS

- Mini Shim Kit contains 10 pieces of each thickness
- Pre-packaged and foam protected in sturdy metal toolbox
- Each kit contains the following thicknesses: .001, .002, .003, .004, .005, .010, .015, .020, .025, .050, .075, .100, .125

Item No.	Description	Package
A-Mini	A (2" x 2") Mini Shim Kit	Box
B-Mini	B (3" x 3") Mini Shim Kit	Box
C-Mini	C (4" x 4") Mini Shim Kit	Box
D-Mini	D (5" x 5") Mini Shim Kit	Box

PRE-CUT STAINLESS STEEL SHIM PACKS

contains 20 pieces

Item No.	Description	Package
A-001	A (2" x 2") .001" Shim Pk	Box
B-001	B (3" x 3") .001" Shim Pk	Box
C-001	C (4" x 4") .001" Shim Pk	Box
D-001	D (5" x 5") .001" Shim Pk	Box
A-002	A (2" x 2") .002" Shim Pk	Box
B-002	B (3" x 3") .002" Shim Pk	Box
C-002	C (4" x 4") .002" Shim Pk	Box
D-002	D (5" x 5") .002" Shim Pk	Box
A-003	A (2" x 2") .003" Shim Pk	Box
B-003	B (3" x 3") .003" Shim Pk	Box
C-003	C (4" x 4") .003" Shim Pk	Box
D-003	D (5" x 5") .003" Shim Pk	Box
A-004	A (2" x 2") .004" Shim Pk	Box
B-004	B (3" x 3") .004" Shim Pk	Box
C-004	C (4" x 4") .004" Shim Pk	Box
D-004	D (5" x 5") .004" Shim Pk	Box
A-005	A (2" x 2") .005" Shim Pk	Box
B-005	B (3" x 3") .005" Shim Pk	Box
C-005	C (4" x 4") .005" Shim Pk	Box
D-005	D (5" x 5") .005" Shim Pk	Box
A-010	A (2" x 2") .010" Shim Pk	Box
B-010	B (3" x 3") .010" Shim Pk	Box
C-010	C (4" x 4") .010" Shim Pk	Box
D-010	D (5" x 5") .010" Shim Pk	Box
A-015	A (2" x 2") .015" Shim Pk	Box
B-015	B (3" x 3") .015" Shim Pk	Box
C-015	C (4" x 4") .015" Shim Pk	Box
D-015	D (5" x 5") .015" Shim Pk	Box
A-020	A (2" x 2") .020" Shim Pk	Box
B-020	B (3" x 3") .020" Shim Pk	Box
C-020	C (4" x 4") .020" Shim Pk	Box
D-020	D (5" x 5") .020" Shim Pk	Box
A-025	A (2" x 2") .025" Shim Pk	Box
B-025	B (3" x 3") .025" Shim Pk	Box
C-025	C (4" x 4") .025" Shim Pk	Box
D-025	D (5" x 5") .025" Shim Pk	Box
A-050	A (2" x 2") .050" Shim Pk	Box
B-050	B (3" x 3") .050" Shim Pk	Box
C-050	C (4" x 4") .050" Shim Pk	Box
D-050	D (5" x 5") .050" Shim Pk	Box
A-075	A (2" x 2") .075" Shim Pk	Box
B-075	B (3" x 3") .075" Shim Pk	Box
C-075	C (4" x 4") .075" Shim Pk	Box
D-075	D (5" x 5") .075" Shim Pk	Box
A-100	A (2" x 2") .100" Shim Pk	Box
B-100	B (3" x 3") .100" Shim Pk	Box
C-100	C (4" x 4") .100" Shim Pk	Box
D-100	D (5" x 5") .100" Shim Pk	Box
A-125	A (2" x 2") .125" Shim Pk	Box
B-125	B (3" x 3") .125" Shim Pk	Box
C-125	C (4" x 4") .125" Shim Pk	Box
D-125	D (5" x 5") .125" Shim Pk	Box





A MAGNETIC STUD FINDER™

- Powerful rare earth magnets locate metal and wood studs
- Rotating level for horizontal and vertical leveling
- No batteries required
- 6 each per case pack
- Ideal for remodeling, new construction, and DIY projects
- Compact design easily fits in your pocket

Item No.	Description	Package
03040	Magnetic Stud Finder™	Carded

B ANGLE SNAP®

- Unique layout tool
- Accurately measures and marks sheet goods like plywood and drywall
- Measures in Degrees and Pitches
- Comes with chalk reel
- Easy 1 person marking - two adjustable grip pins anchor tool on desired mark
- Measure angles - use as protractor for finding angles and roof pitches
- 6 each per case pack

Item No.	Description	Package
03070	AngleSnap®	Carded

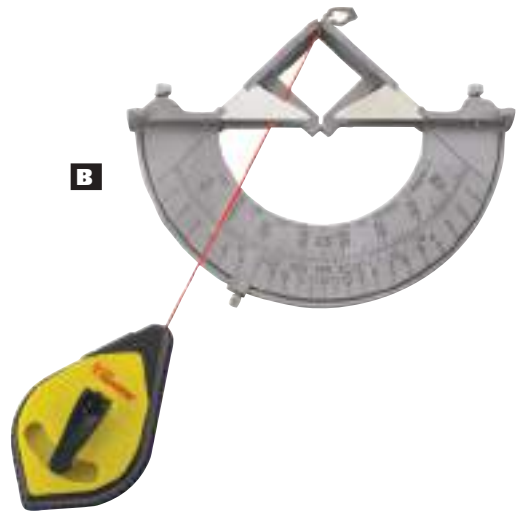

C MEASURING WHEEL - ANALOG

- 5 digit magnified counter measures up to 10,000 feet
- Telescoping aluminum handle for easy storage
- Limited lifetime warranty
- Heavy duty wheel with rubber tires
- Pistol grip handle for easy use
- 1 each per pack

Item No.	Description	Package
11246	4" Measuring Wheel	Carded
11249	13" Measuring Wheel	Carded





Squares

A PIVOT SQUARE®

- Precision measurement tool
- Pivots to easily measure or mark any angle
- Locks in angles • Quickly find roof pitch
- Has three vials to determine roof pitches, indicate grade, and allow for leveling and plumbing
- 4 each per case pack

Item No.	Description	Package
03060	Machined Aluminum Pivot Square®	Clam Shell
00203_PUR	Pivot Square® User's Guide	Box
03065	Resin Pivot Square®	Carded

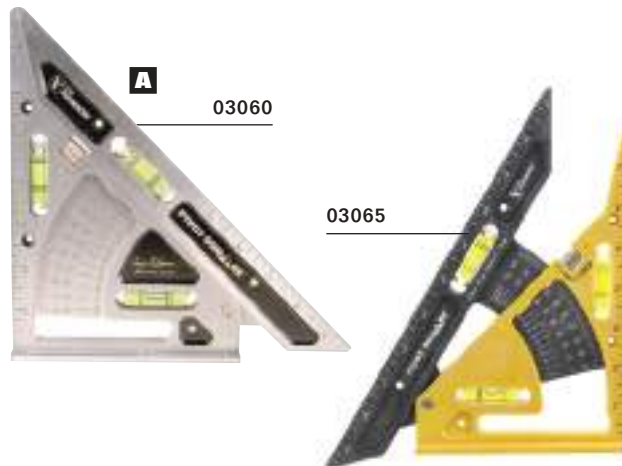

B SLIDE SQUARE®

- This next generation square is the one tool that will easily and accurately solve all your layout needs
- Marks accurate anchor bolt hole locations onto 2" x 4" and 2" x 6" sill plates
- Marks right angles with positive stop at 90°
- Mark common, hip, and valley roof cuts and angles
- Fits in your pocket • 6 each per case pack

Item No.	Description	Package
03050	Slide Square®	Carded





A 3'x4'x5' 90° HEAVY DUTY ALUMINUM FOLDING LAYOUT ASQUARE

- Only true 3' x 4' x 5' square
- Aircraft Aluminum construction
- Collapsing triangle for easy storage
- Easy to use, for quick and accurate work
- Uses: Carpentry, layout, angle layout, squaring, framing timber, masonry, pavers and much more
- Accurate to within 1/32"

Item No.	Description	Package
00345	3'x4'x5' 90° Heavy Duty Alum. Folding Layout Asquare	Tube
34502	3'x4'x5' 90° Heavy Duty Alum. Folding Layout Asquare (3 pack per Tube)	Tube

B 54" 45° HEAVY DUTY ALUMINUM FOLDING LAYOUT ASQUARE

- Provides true 90° angle and two 45° angles in a folding layout square
- Aircraft quality extruded aluminum
- Collapsing triangle slides closed for easy storage
- Precision made, Positive locking, easy to use, more accurate, folds to store
- Great for tile work

Item No.	Description	Package
00045	54" 45° Heavy Duty Alum. Folding Layout Asquare	Tube
45002	54" 45° Heavy Duty Alum. Folding Layout Asquare (3 pack per tube)	Tube



Masonry Line



C MASONRY LINE REELS

- High visibility lines for temporary area marking
- For contractors, carpenters, masons or home use
- For quick, easy unwinding/rewinding
- Reloadable string fits 1" cores 4" - 6" long
- #18 Nylon Construction Line • 12 each per case pack

Item No.	Description	Package
51050	250' Twisted Gold Line & Reel	Cut Case
53200	500' Braided Pink Line & Reel	Cut Case
53500	500' Braided Fl Orange Line & Reel	Cut Case



D MASONRY LINE REFILLS

- High visibility lines for temporary area marking
- Reloadable string fits 1" cores 4" - 6" long
- #18 Nylon Construction Line • 12 each per case pack

Item No.	Description	Package
52050	250' Twisted Gold Line	Cut Case
54200	500' Braided Pink Line	Cut Case



**C.H.
HANSON**[®]
Since 1866 • Tools for Generations™

Barricade Safety Tape

Features:

- Competitive pricing
- Custom legends
- Reinforced tape available for greater strength

CAUTION



CAUTION

Barricade Safety Tapes

- Rolls are individually labeled with UPC code
 - 2" Black characters on 3" wide yellow tape unless indicated.
 - Ask us about other legends and sizes available
 - Boxed packaging
- *Call for availability

- Case Pack:

1,000 ft. length 3 mil - 12 rolls	300 ft. length 2 mil - 16 rolls
1,000 ft. length 2 mil - 12 rolls	200 ft. length 2 mil - 8 rolls
1,000 ft. length 1.5 mil - 15 rolls	3,000 ft. length 2 mil - 4 rolls



1,000 ft. Length			
Legend	3 mil	2 mil	1.5 mil
Attention/Attention	15040	16041	19041
Breathing Air Required In The Area	16200*	16011*	—
Caution	14995	16000	19000
Caution / Cuidado	15036	16002	—
Caution Construction Area	15018	16009	—
Caution Crime Scene	15020	—	—
Caution D N E	15120	—	—
Caution Do Not Enter	15002	16004	19004
Caution Do Not Enter/Cuidado No Se Entre	—	16006*	—
Caution Hazardous Material	15022	—	—
Caution No Parking	15004	—	—
Caution Open Trench	15044	16007	—
Caution Safety Hazard Keep Away	15024	—	—
Caution Symbol	15032	—	—
Caution Wet Paint	15010	16001	—
Cuidado Cuidado	16203	16013	—
Danger (Red)	14998	16003	19005
Danger Do Not Enter (Red)	15041	16005	—
Danger Lead Hazard (Red)	15122*	16012	—
Danger/Peligro (Red)	15129	16554	—
Fire Line Do Not Cross	15034*	—	—
Garage Sale	15008*	—	—
No Legend Yellow Tape	14091	—	—
No Legend Red Tape	15412	—	—
Peligro No Pasar (Red)	15061*	—	—
Peligro Peligro (Red)	15039*	—	—

1,000 ft. Length			
Legend	3 mil	2 mil	1.5 mil
Police Line DNC	15049*	—	—
Police Line Do No Cross	15026	—	—
Restricted Area Keep Out	15121*	—	—
Restricted Area Keep Out	—	16008*	—
Security Line Do Not Cross	15028*	—	—
Utility Line Do Not Cross	15043*	—	—
Warning Restricted Area (Yellow)	15016*	—	—

3,000 ft. Length	
Legend	2 mil
3000' x 3" Yellow CAUTION Tape Jumbo Roll	16091

300 ft. Length (3" wide)	
Legend	2 mil
Caution	16100
Caution / Cuidado	16102
Caution Do Not Enter	16104
Caution Wet Paint	16101
Danger Do Not Enter (Red)	16105
Garage Sale	16110
Danger (Red)	16103
Danger/Peligro (Red)	16653

200 ft. Length	
Legend	2 mil
Caution	14100
Caution Do Not Enter	14101



REINFORCED BARRICADE TAPE - 5 MIL

- Mesh tape for greater strength
- No stretch • 8 rolls per case pack

Item No.	Description	Package
16030	"Caution" Barricade Tape 500 ft.	Boxed
16031	Red Danger Tape 500 ft.	Boxed



EXPANDING YELLOW CAUTION TAPE - 5 MIL

- No stretch • 8 rolls per case pack

Item No.	Description	Package
16092	Expanding Yellow CAUTION Tape 500 ft.	Boxed



Safety Tape

A DISPENSER BOX

- Box dispensed tape
- Easily stands
- Heavy duty 3 mil tape

Item No.	Description	Package
14090	3 MIL 1000 ft. roll Caution	Boxed
15140	3 MIL 1000 ft. roll Caution-Do Not Enter	Boxed
15142	3 MIL 1000 ft. roll Danger (Red)	Boxed
16090	2 MIL 1000 ft. roll Caution with dispenser	Boxed



Flagging Tapes

B FLAGGING TAPES

- Superior visibility when laying out boundaries
- 12 rolls per case pack
- Economical and Reusable
- Fluorescent colors are all 150 feet long

1-3/16" WIDE - 4 MIL

Model	Description	Package
17000	Orange Fluorescent	Box
17001	Lime Fluorescent	Box
17002	Red Fluorescent	Box
17003	Pink Fluorescent	Box
17004	Green Fluorescent	Box
17005	Yellow Fluorescent	Box
17055	Pink Flo/Black Stripe	Box
17056	Orange Flo/Black Stripe	Box

ECONOMY - 1" WIDE - 4 MIL

17000-1	Orange Fluorescent	Box
17001-1	Lime Fluorescent	Box
17002-1	Red Fluorescent	Box
17003-1	Pink Fluorescent	Box
17004-1	Green Fluorescent	Box
17005-1	Yellow Fluorescent	Box

C FLAGGING TAPES - STRIPES AND DOTS

- Visual colorization for differentiation
- Excellent visibility when laying out boundaries
- 1-3/16" wide 2 MIL Economical and Reusable
- Standard colors are 300 feet • 12 rolls per case pack

Model	Description	Package
17025	Standard Red/White Stripes	Box
17057	Standard Red/Black Stripes	Box
17060	Standard Yellow/Black Stripes	Box
17061	Standard Yellow/White Stripes	Box
17063	Standard Orange/White Stripes	Box
17064	Standard Blue/Black Stripes	Box
17065	Standard Blue/White Stripes	Box
17066	Standard White with Blue Dots	Box
17067	Standard White with Red Dots	Box
17068	Standard White with Orange Dots	Box

B



C



D



D FLAGGING TAPES - STANDARD COLORS

- Excellent visibility when laying out boundaries
- 1-3/16" wide 2 MIL Economical and Reusable
- Standard colors are 300 feet • 12 rolls per case pack

Model	Description	Package
17020	Standard White	Box
17021	Standard Red	Box
17022	Standard Orange	Box
17023	Standard Blue	Box
17024	Standard Yellow	Box
17026	Standard Green	Box
17027	Standard Black	Box
17028	Standard Pink	Box



Sub-Zero™ Flagging Tape

- Maximum durability in harsh weather conditions
- Rated to -40° F
- Contains UV Protection
- True 5 mil thickness throughout entire roll
- 1-3/16" wide x 150', Fluorescent colors
- 12 rolls per case pack

Model	Description	Display Box
17006	150' 5MIL Sub-Zero Fluorescent Pink	12
17007	150' 5MIL Sub-Zero Fluorescent Orange	12
17008	150' 5MIL Sub-Zero Fluorescent Blue	12
17009	150' 5MIL Sub-Zero Fluorescent Lime	12
17010	150' 5MIL Sub-Zero Fluorescent Red	12
17011	150' 5MIL Sub-Zero Fluorescent White	12
17012	150' 5MIL Sub-Zero Fluorescent Yellow	12
17013	150' 5MIL Sub-Zero Fluorescent Dark Green	12
17014	150' 5MIL Sub-Zero Fluorescent Purple	12



Aisle Marking and Safety Tape

A REFLECTIVE SAFETY TAPE

- Meets NHTSA Conspicuity Regulations
- Easy to apply strip
- Place on trailer sides, bottom of rear door, and ICC bar
- 1 per package
- 6 each per case pack

Model	Description	Package
55301	2" X 24" Reflective Safety Tape White	Carded
55302	2" X 24" Reflective Safety Tape Red	Carded
55303	2" X 24" Reflective Stripes Black/Yellow	Carded
55304	2" X 24" Reflective Stripes Red/White	Carded
55305	2" X 24" D.O.T. Reflective Stripes Red/Silver	Carded



B AISLE MARKING

- 2" x 54' roll, or otherwise noted
- Highly visible stripes for identifying high traffic areas on floor
- 6 rolls per case pack

Item No.	Description	Package
15045	Black/on Yellow	Boxed



B



Stake Flags

APWA UNIFORM COLOR CODE FOR MARKING UNDERGROUND UTILITIES

Color	Utility
WHITE	Proposed Excavation
PINK	Temporary Survey Markings
RED	Electrical Power Lines, Cables, Conduit and Lighting Cables
YELLOW	Gas, Oil, Steam, Petroleum or Gaseous Materials
ORANGE	Communication, Alarm or Signal Lines, Cables or Conduit
BLUE	Potable Water
LIME	Sewer and Drain Lines



A BULK WIRE STAFF, 2-1/2" X 3-1/2"

- Bundles of 100 flags
- For surveying, construction, agriculture, and more
- Mark location of underground utilities
- Ask us about custom printing

Item No.	Description	Package
15079	21" - Orange Flo Marking Flag	Bundle
15080	21" - Red Flo Marking Flag	Bundle
15081	21" - Pink Flo Marking Flag	Bundle
15082	21" - Lime Flo Marking Flag	Bundle
15084	21" - Yellow Marking Flag	Bundle
15085	21" - Blue Marking Flag	Bundle
15086	21" - White Marking Flag	Bundle
15101	21" - Std. Orange Marking Flag	Bundle
15103	21" - Std. Red Marking Flag	Bundle

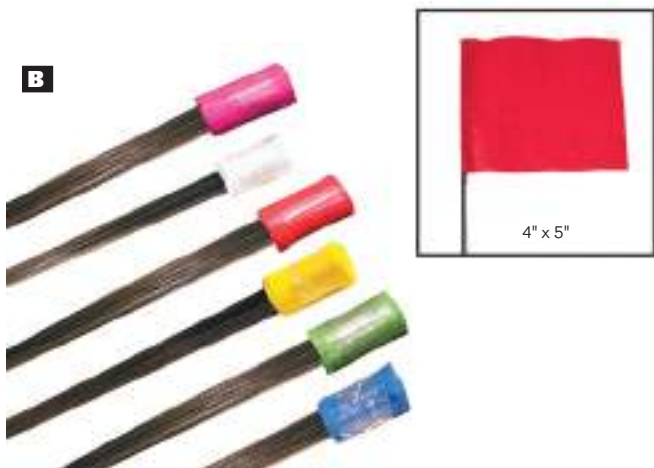

B BULK WIRE STAFF, 4" X 5"

- Oversized flag for added visibility
- Bundles of 100
- For surveying, construction and agriculture
- Mark location of underground utilities
- 100 Flags per bundle
- Ask us about custom printing

Item No.	Description	Package
15073	21" - Yellow Marking Flag	Bundle
15074	21" - Blue Marking Flag	Bundle
15090	21" - Orange Flo Marking Flag	Bundle
15091	21" - Pink Flo Marking Flag	Bundle
15281	21" - Red Flo Marking Flag	Bundle
15282	21" - White Marking Flag	Bundle
15283	21" - Lime Flo Marking Flag	Bundle
15055	30" - Flo Pink Marking Flag	Bundle
15088	30" - Orange Flo Marking Flag	Bundle
15094	36" - Orange Flo Marking Flag	Bundle





Stake Flags

C 10 PACK - WIRE STAFF

- 2-1/2" x 3-1/2", bundles of 10
- For surveying, construction, agriculture, and more
- Mark location of underground utilities
- Ideal for Retail hangable packaging

Item No.	Description	Package
15065	10 ea.- 15" - Red Flo Marking Flags	Carded
15066	10 ea.- 15" - Pink Flo Marking Flags	Carded
15067	10 ea.- 15" - Lime Flo Marking Flags	Carded
15068	10 ea.- 15" - Blue Marking Flags	Carded
15275	10 ea.- 15" - Glo Orange Marking Flags	Carded
15180	10 ea.- 15" - White Marking Flags	Carded
15181	10 ea.- 15" - Yellow Marking Flags	Carded



Safety

A SAFETY VESTS

- Soft mesh vest
- One size fits all
- Reflective stripe
- 10 each per case pack

Item No.	Description	Package
55100	Orange glo vest, soft mesh	Carded
55125	Orange glo vest, soft mesh with reflective stripe	Carded
55150	Premium vest, wider reflective stripes	Carded
55110	Lime green vest, soft mesh	Carded
55120	Premium Lime green vest, wider reflective strips and heaviest mesh	Carded
55115	Lime green vest, with red reflective stripes	Carded



B ANSI CL2 SAFETY VESTS

- ANSI Class 2 safety vests
- 10 each per case pack
- 100% Polyester open weave mesh
- Adjustable sides: each side has a 1" x 3" Velcro strips for easy adjustment, maximum width 56"
- 2" wide silver reflective material stripe
- Side pocket for phone, pens, or tools

Item No.	Description	Package
55180	ANSI Class 2 Lime Safety Vest	Carded



C TRAFFIC FLAGS

- High visibility traffic control flags
- 10 each per case pack

Item No.	Description	Package
55200	Mesh traffic flag with 27" handle	Box
55300	Nylon traffic flag with handle	Box



D RED WARNING FLAGS FOR LUMBER

- High visibility warning flags
- Easily stapled to lumber
- Perfect for oversize vehicle loads
- 300 flags per roll
- 5 rolls per case pack

Item No.	Description	Package
10490	12" x 12" Red Lumber Flags	Roll
10495	16" x 16" Red Lumber Flags	Roll



E STOP/SLOW PADDLES

- 18" Stop/Slow traffic control sign
- High impact plastic handle for 60" model
- Crossing guard 10" wood handle

Item No.	Description	Package
55400	Stop / Slow Sign - 60" plastic pole	Box
55450	Stop / Slow Sign - 10" wood handle	Box



F HIGHWAY WARNING KIT

- Highway Warning kit contains three 17" triangles
- Packed in a handy carrying case
- Color scheme includes fluorescent orange for high visibility during the day, and an outer red reflective border for night use

Item No.	Description	Package
55600	Highway Warning kit	Box



ITEM	PAGE
00045 - 10076	
00045.....	53
00118.....	41
00125.....	42
00202.....	40
00203.....	52
00206.....	41
00208.....	40
00213.....	41
00221.....	41
00345.....	53
02010.....	41
03040.....	51
03050.....	52
03060.....	52
03065.....	52
03070.....	51
10006.....	36
10006_.....	35
10007.....	36
10007_.....	35
10008.....	36
10008_.....	35
10009.....	36
10009_.....	35
10011.....	36
10011_.....	35
10012.....	36
10012_.....	35
10013.....	36
10013_.....	35
10014.....	36
10014_.....	35
10015.....	36
10015_.....	35
10016.....	36
10016_.....	35
10026.....	36
10027.....	36
10028.....	36
10029.....	36
10031.....	36
10032.....	36
10033.....	36
10034.....	36
10035.....	36
10036.....	36
10066.....	36
10067.....	36
10068.....	36
10069.....	36
10071.....	36

ITEM	PAGE
10072.....	36
10073.....	36
10074.....	36
10075.....	36
10076.....	36
10106 - 10405	
10106.....	37
10107.....	37
10108.....	37
10109.....	37
10111.....	37
10112.....	37
10113.....	37
10114.....	37
10115.....	37
10116.....	37
10146.....	37
10147.....	37
10148.....	37
10149.....	37
10151.....	37
10152.....	37
10153.....	37
10154.....	37
10155.....	37
10156.....	37
10160.....	38
10160_.....	35
10161.....	38
10161_.....	35
10162.....	38
10162_.....	35
10165.....	38
10166.....	38
10167.....	38
10175.....	38
10175_.....	35
10176.....	38
10176_.....	35
10177.....	38
10177_.....	35
10178.....	38
10179.....	38
10181.....	38
10187.....	34
10188.....	34
10189.....	34
10190.....	34
10191.....	34
10192.....	34
10193.....	34
10194.....	34

ITEM	PAGE
10195.....	34
10198.....	34
10231.....	40
10260.....	42
10261.....	42
10262.....	42
10263.....	42
10264.....	42
10265.....	42
10295.....	43
10297.....	43
10298.....	43
10299.....	43
10303.....	37
10305.....	37
10307.....	37
10316.....	40
10323.....	37
10325.....	37
10327.....	37
10352.....	42
10353.....	42
10356.....	42
10362.....	43
10365.....	42
10366.....	42
10367.....	42
10368.....	42
10370.....	42
10374.....	43
10378.....	40
10379.....	40
10380.....	40
10382.....	42
10383.....	42
10384.....	42
10385.....	42
10386.....	42
10387.....	41
10390.....	42
10391.....	42
10391.....	42
10393.....	43
10394.....	43
10395.....	43
10396.....	43
10397.....	43
10398.....	40
10399.....	40
10400.....	40
10401.....	43
10404.....	42
10405.....	41

ITEM PAGE

10456 - 11249

10456.....	41
10457.....	41
10458.....	41
10490.....	61
10494.....	42
10495.....	61
10496.....	42
10497.....	42
10498.....	42
10560.....	40
10561.....	40
10570.....	40
10622.....	42
10623.....	42
10625.....	42
11246.....	51
11249.....	51

12001 - 14998

12001.....	39
12002.....	39
12003.....	39
12004.....	39
12006.....	39
12008.....	39
12009.....	39
12120.....	39
12121.....	39
12122.....	39
12123.....	39
12160.....	39
12164.....	39
12310.....	39
12311.....	39
12312.....	39
12400.....	34
12401.....	34
12402.....	34
12403.....	34
12404.....	34
12405.....	34
12406.....	34
12407.....	34
12408.....	34
12409.....	34
12410.....	34
12411.....	34
12412.....	34
12413.....	34
12414.....	34
12415.....	34
12416.....	34

ITEM PAGE

12417.....	34
12418.....	34
12419.....	34
12420.....	34
12421.....	34
12430.....	34
12431.....	34
12432.....	34
12433.....	34
12434.....	34
12435.....	34
12436.....	34
12437.....	34
12438.....	34
12439.....	34
12441.....	34
12460.....	34
14090.....	57
14091.....	56
14100.....	56
14101.....	56
14995.....	56
14998.....	56

15002 - 15412

15002.....	56
15004.....	56
15008.....	56
15010.....	56
15016.....	56
15018.....	56
15020.....	56
15022.....	56
15024.....	56
15026.....	56
15028.....	56
15032.....	56
15034.....	56
15036.....	56
15039.....	56
15040.....	56
15041.....	56
15043.....	56
15044.....	56
15045.....	58
15049.....	56
15055.....	59
15061.....	56
15065.....	60
15066.....	60
15067.....	60
15068.....	60
15073.....	59
15074.....	59

ITEM PAGE

15079.....	59
15080.....	59
15081.....	59
15082.....	59
15084.....	59
15085.....	59
15086.....	59
15088.....	59
15090.....	59
15091.....	59
15094.....	59
15101.....	59
15103.....	59
15120.....	56
15121.....	56
15122.....	56
15129.....	56
15140.....	57
15142.....	57
15180.....	60
15181.....	60
15275.....	60
15281.....	59
15282.....	59
15283.....	59
15412.....	56

16000 - 16203

16000.....	56
16001.....	56
16002.....	56
16003.....	56
16004.....	56
16005.....	56
16006.....	56
16007.....	56
16008.....	56
16009.....	56
16011.....	56
16012.....	56
16013.....	56
16030.....	56
16031.....	56
16041.....	56
16090.....	57
16092.....	56
16100.....	56
16101.....	56
16102.....	56
16103.....	56
16104.....	56
16105.....	56
16110.....	56
16203.....	56

ITEM	PAGE
16554 - 19041	
16554.....	56
16653.....	56
17000.....	57
17000-1.....	57
17001.....	57
17001-1.....	57
17002.....	57
17002-1.....	57
17003.....	57
17003-1.....	57
17004.....	57
17004-1.....	57
17005.....	57
17005-1.....	57
17006.....	58
17007.....	58
17008.....	58
17009.....	58
17010.....	58
17011.....	58
17012.....	58
17013.....	58
17014.....	58
17020.....	57
17021.....	57
17022.....	57
17023.....	57
17024.....	57
17025.....	57
17026.....	57
17027.....	57
17028.....	57
17055.....	57
17056.....	57
17057.....	57
17060.....	57
17061.....	57
17063.....	57
17064.....	57
17065.....	57
17066.....	57
17067.....	57
17068.....	57
19000.....	56
19004.....	56
19005.....	56
19041.....	56
20000 - 20951	
20000.....	8
20005.....	9
20010.....	11

ITEM	PAGE
20012.....	11
20014.....	10
20100.....	24
20100.....	26
20150.....	24, 26
20200.....	24, 26
20220.....	24
20250.....	24, 26
20260.....	24
20270.....	24
20300.....	24, 26
20350.....	26
20360.....	24
20400.....	24, 26
20501.....	24
20521.....	24
20541.....	24
20561.....	24
20581.....	24
20601.....	24
20621.....	24
20622.....	24
20623.....	24
20624.....	24
20625.....	24
20626.....	24
20628.....	24
20741.....	24, 26
20751.....	24, 26
20801.....	24, 26
20851.....	24, 26
20901.....	24, 26
20951.....	24, 26
21051 - 21880	
21051.....	24, 26
21080.....	25
21081.....	25
21082.....	25
21083.....	25
21084.....	25
21085.....	25
21086.....	25
21087.....	25
21088.....	25
21089.....	25
21101.....	26
21151.....	26
21201.....	24, 26
21251.....	24, 26
21252.....	24, 26
21253.....	24
21301.....	24

ITEM	PAGE
21320.....	24
21340.....	24
21360.....	24
21380.....	24
21400.....	24
21460.....	24
21480.....	24
21500.....	24
21520.....	24
21622.....	24
21623.....	24
21624.....	24
21625.....	24
21626.....	24
21627.....	24
21628.....	24
21629.....	24
21630.....	24
21631.....	24
21632.....	24
21633.....	24
21634.....	24
21730.....	24
21730.....	26
21750.....	24
21750.....	26
21760.....	26
21770.....	24, 26
21830.....	24
21850.....	24
21870.....	24
21880.....	24
22000 - 22901	
22000.....	24, 26
22050.....	24, 26
22100.....	24, 26
22150.....	24, 26
22200.....	24, 26
22250.....	24, 26
22350.....	26
22400.....	26
22450.....	24, 26
22550.....	24
22550.....	26
22600.....	24, 26
22750.....	24, 26
22801.....	24
22821.....	24
22841.....	24
22861.....	24
22881.....	24
22901.....	24

ITEM	PAGE
22941 - 24012	
22941.....	24
22961.....	24
22981.....	24
23021.....	24
23041.....	24
24001.....	24
24002.....	24
24003.....	24
24004.....	24
24005.....	24
24006.....	24
24007.....	24
24008.....	24
24009.....	24
24011.....	24
24012.....	24
25000 - 25950	
25000.....	25,26
25050.....	25,26
25100.....	25,26
25150.....	25,26
25200.....	25,26
25250.....	25,26
25300.....	25,26
25350.....	25,26
25400.....	25,26
25450.....	25,26
25501.....	25
25521.....	25
25541.....	25
25561.....	25
25581.....	25
25601.....	25
25621.....	25
25641.....	25
25661.....	25
25681.....	25
25682.....	25
25683.....	25
25684.....	25
25685.....	25
25686.....	25
25687.....	25
25688.....	25
25689.....	25
25690.....	25
25691.....	25
25700.....	25,26
25750.....	25,26
25800.....	25,26
25850.....	25

ITEM	PAGE
25850.....	26
25900.....	25,26
25950.....	25,26
26000 - 26993	
26000.....	25,26
26061.....	25
26081.....	25
26101.....	25
26121.....	25
26141.....	25
26161.....	25
26181.....	25
26183.....	25
26184.....	25
26185.....	25
26187.....	25
26188.....	25
26189.....	25
26190.....	25
26200.....	25,26
26250.....	25,26
26300.....	26
26300.....	25,26
26350.....	25,26
26400.....	25,26
26601.....	25
26621.....	25
26641.....	25
26661.....	25
26681.....	25
26685.....	25
26687.....	25
26688.....	25
26990.....	27
26991.....	27
26992.....	27
26993.....	27
27600 - 2799PN	
27600.....	29
27601.....	29
27604.....	29
27605.....	29
27608.....	29
27609.....	29
27610.....	29
27611.....	29
27612.....	29
27613.....	29
27620.....	29
27621.....	29
27624.....	29
27630.....	28

ITEM	PAGE
27630.....	28
27630BL.....	28
27631.....	28
27632.....	28
27632.....	28
27632BL.....	28
27633.....	28
27634.....	28
27634.....	28
27634BL.....	28
27635.....	28
27636.....	28
27636.....	28
27636BL.....	28
27637.....	28
27638.....	28
27638.....	28
27638BL.....	28
27639.....	28
27640.....	28
27640.....	28
27640BL.....	28
27641.....	28
27770.....	29
27771.....	29
27774.....	29
27775.....	29
27778.....	29
27779.....	29
27782.....	29
27783.....	29
27905.....	21
27905A.....	21
27905B.....	21
27906.....	21
27906B.....	21
27911.....	21
27913.....	21
27915.....	21
27916.....	21
27917.....	21
27918.....	21
2799GN.....	21
2799PN.....	21
28060 - 29175	
28060.....	27
28061.....	27
28062.....	27
28063.....	27
28065.....	27
29100.....	26
29150.....	26
29175.....	26

ITEM	PAGE
29200 - 29375	
29200.....	26
29250.....	26
29275.....	26
29300.....	26
29350.....	26
29375.....	26
34502	
34502.....	53
40001 - 40098	
40001.....	19
40002.....	19
40003.....	19
40004.....	19
40005.....	19
40006.....	19
40007.....	19
40008.....	19
40009.....	19
40010.....	19
40011.....	19
40012.....	19
40013.....	19
40014.....	19
40015.....	19
40016.....	19
40017.....	19
40018.....	19
40019.....	19
40020.....	19
40021.....	19
40022.....	19
40023.....	19
40024.....	19
40025.....	19
40026.....	19
40027.....	19
40028.....	19
40029.....	19
40030.....	19
40031.....	19
40032.....	19
40033.....	19
40034.....	19
40035.....	19
40036.....	19
40037.....	19
40038.....	19
40039.....	19
40040.....	19
40080.....	20

ITEM	PAGE
40081.....	20
40082.....	20
40083.....	20
40084.....	20
40085.....	20
40087.....	20
40096.....	20
40097.....	20
40098.....	20
41000 - 41846	
41000.....	20
41001.....	20
41002.....	20
41136.....	18
41137.....	18
41138.....	18
41151.....	18
41152.....	18
41153.....	18
41154.....	18
41176.....	18
41177.....	18
41178.....	18
41186.....	18
41187.....	18
41188.....	18
41196.....	18
41197.....	18
41198.....	18
41421.....	16
41422.....	16
41423.....	16
41431.....	16
41432.....	16
41433.....	16
41451.....	16
41452.....	16
41453.....	16
41461.....	16
41462.....	16
41463.....	16
41221.....	17
41222.....	17
41223.....	17
41241.....	17
41242.....	17
41243.....	17
41250.....	15
41251.....	17
41252.....	17
41253.....	17
41260.....	15

ITEM	PAGE
41261.....	15
41262.....	15
41271.....	17
41272.....	17
41273.....	17
41281.....	17
41282.....	17
41283.....	17
41291.....	17
41292.....	17
41293.....	17
41316.....	17
41317.....	17
41318.....	17
41331.....	18
41332.....	18
41333.....	18
41376.....	14
41377.....	14
41378.....	14
41386.....	14
41387.....	14
41388.....	14
41482.....	15
41483.....	15
41516.....	15
41517.....	15
41518.....	15
41526.....	15
41527.....	15
41528.....	15
41531.....	15
41532.....	15
41533.....	15
41696.....	14
41697.....	14
41698.....	14
41741.....	14
41742.....	14
41743.....	14
41771.....	14
41772.....	14
41773.....	14
41821.....	13
41822.....	13
41823.....	13
41831.....	13
41832.....	13
41833.....	13
41841.....	13
41842.....	13
41843.....	13
41846.....	13

ITEM PAGE
41847 - 42532

41847..... 13
41848..... 13
41849..... 13
41857..... 13
41858..... 13
41881..... 13
41882..... 13
41883..... 13
41901..... 21
41911..... 21
41914..... 21
41917..... 21
41920..... 21
41924..... 21
41930..... 21
41939..... 21
41942..... 21
41945..... 21
41951..... 21
41956..... 21
42387..... 14
42492..... 15
42527..... 15
42532..... 15

43001 - 43160

43001..... 13
43003..... 16
43004..... 17
43005..... 13
43006..... 13
43007..... 13
43008..... 13
43009..... 13
43010..... 13
43011..... 13
43012..... 13
43013..... 13
43014..... 13
43015..... 13
43016..... 13
43017..... 13
43018..... 13
43019..... 13
43020..... 16
43021..... 16
43022..... 16
43023..... 16
43024..... 16
43025..... 16
43026..... 16
43027..... 16

ITEM PAGE

43028..... 16
43029..... 16
43030..... 16
43031..... 16
43032..... 16
43033..... 16
43034..... 16
43035..... 17
43036..... 17
43037..... 17
43039..... 17
43040..... 17
43041..... 17
43042..... 17
43043..... 17
43044..... 17
43045..... 17
43046..... 17
43047..... 17
43048..... 17
43049..... 17
43050..... 17
43051..... 17
43052..... 17
43053..... 17
43054..... 17
43068..... 17
43077..... 13
43079..... 16
43080..... 17
43081..... 13
43082..... 13
43083..... 13
43084..... 13
43085..... 13
43086..... 13
43087..... 16
43088..... 16
43089..... 16
43090..... 16
43091..... 16
43092..... 16
43093..... 17
43094..... 17
43095..... 17
43096..... 17
43098..... 17
43099..... 17
43100..... 17
43101..... 17
43102..... 13
43104..... 16
43105..... 17

ITEM PAGE

43106..... 18
43107..... 18
43108..... 18
43109..... 18
43110..... 17
43111..... 17
43112..... 17
43113..... 17
43114..... 17
43115..... 17
43116..... 17
43119..... 18
43120..... 14
43121..... 14
43122..... 13
43123..... 13
43124..... 13
43125..... 13
43126..... 13
43127..... 14
43128..... 14
43130..... 15
43131..... 15
43132..... 15
43133..... 15
43134..... 16
43135..... 16
43136..... 16
43137..... 16
43138..... 13
43139..... 13
43140..... 13
43141..... 13
43141..... 13
43142..... 13
43143..... 13
43144..... 13
43145..... 13
43146..... 13
43147..... 13
43148..... 13
43149..... 14
43150..... 14
43151..... 14
43152..... 14
43153..... 14
43154..... 14
43155..... 14
43156..... 16
43157..... 16
43158..... 16
43159..... 16
43160..... 18

ITEM	PAGE
43161 - 43184	
43161.....	18
43162.....	18
43163.....	18
43164.....	18
43165.....	18
43166.....	18
43167.....	17
43168.....	17
43169.....	17
43170.....	17
43171.....	18
43172.....	18
43173.....	18
43174.....	18
43175.....	18
43176.....	18
43177.....	18
43178.....	18
43179.....	18
43180.....	18
43181.....	18
43182.....	18
43183.....	18
43184.....	18
43406 - 45002	
43406.....	13
43406.....	13
43407.....	13
43408.....	13
43409.....	16
43410.....	16
43411.....	17
43412.....	17
43413.....	17
43414.....	17
43415.....	17
43416.....	17
43417.....	17
43418.....	17
43419.....	17
43420.....	19
43421.....	19
43422.....	19
43423.....	19
43424.....	19
43425.....	19
43426.....	19
43427.....	19
43428.....	19
43429.....	19
43430.....	19

ITEM	PAGE
43431.....	19
43432.....	19
43433.....	19
43434.....	19
43435.....	19
43436.....	19
43437.....	19
43438.....	19
43439.....	19
43440.....	19
43441.....	19
43442.....	19
43443.....	19
43444.....	19
43445.....	19
43446.....	19
43447.....	19
43448.....	19
43449.....	19
43450.....	19
43451.....	19
43452.....	19
43453.....	19
43454.....	19
43455.....	19
43456.....	19
43457.....	19
43458.....	19
43459.....	19
43460.....	19
43461.....	19
43462.....	19
43463.....	19
43464.....	19
43465.....	19
43466.....	19
43467.....	19
43468.....	13
43469.....	13
43470.....	13
43471.....	13
43472.....	13
43473.....	13
45002.....	53
50002 - 55600	
50002.....	27
50003.....	27
50004.....	27
50005.....	27
51050.....	53
52050.....	53
53200.....	53

ITEM	PAGE
53500.....	53
54200.....	53
55100.....	61
55110.....	61
55115.....	61
55120.....	61
55125.....	61
55150.....	61
55175.....	61
55180.....	61
55200.....	61
55300.....	61
55301.....	58
55302.....	58
55303.....	58
55304.....	58
55305.....	58
55400.....	61
55450.....	61
55600.....	61
64001 - 70080	
64001.....	47
64002.....	47
64003.....	47
64011.....	46
64012.....	46
64013.....	46
64014.....	46
64021.....	46
64022.....	46
64023.....	46
64024.....	46
69999.....	31
70000.....	31
70001.....	31
70002.....	31
70003.....	31
70004.....	31
70029.....	31
70030.....	31
70031.....	31
70032.....	31
70040.....	31
70041.....	31
70050.....	31
70051.....	31
70060.....	31
70061.....	31
70062.....	31
70063.....	31
70064.....	31
70080.....	31

ITEM PAGE
70081 - 7200

70081..... 31
70092..... 32
70093..... 32
70103..... 32
70140..... 31
70141..... 31
70160..... 32
70161..... 32
70270..... 32
70271..... 32
70292..... 32
70293..... 32
70330..... 32
70331..... 32
70340..... 30
70341..... 30
70342..... 30
70343..... 30
70350..... 33
70351..... 33
70352..... 33
70353..... 33
70354..... 33
70355..... 33
70356..... 33
70357..... 33
70358..... 33
70380..... 33
70382..... 33
70385..... 33
70387..... 33
70388..... 33
70410..... 33
70411..... 33
70412..... 33
70413..... 33
70414..... 33
70415..... 33
70416..... 33
70417..... 33
70418..... 33
70440..... 33
70441..... 33
70443..... 33
70445..... 33
70448..... 33
70470..... 32
70471..... 32
70472..... 32
70480..... 32
70481..... 32
70491..... 32

70550..... 48
70600..... 49
70620..... 49
70650..... 48
70700..... 48
70750..... 48
70800..... 49
70802..... 33
70802..... 33
70803..... 33
70803..... 33
70804..... 33
70804..... 33
70805..... 33
70805..... 33
70806..... 33
70806..... 33
70900..... 49
70950..... 48
71000..... 48
71050..... 48
71100..... 49
71120..... 49
71800..... 49
71825..... 49
72000..... 49

97443

97443..... 20

A

A-001..... 50
A-002..... 50
A-003..... 50
A-004..... 50
A-005..... 50
A-010..... 50
A-015..... 50
A-020..... 50
A-025..... 50
A-050..... 50
A-075..... 50
A-100..... 50
A-125..... 50
A-FUL..... 50
A-Mini..... 50

B

B-001..... 50
B-002..... 50
B-003..... 50
B-004..... 50
B-005..... 50
B-010..... 50
B-015..... 50
B-020..... 50

B-025..... 50
B-050..... 50
B-075..... 50
B-100..... 50
B-125..... 50
B-FUL..... 50
B-Mini..... 50

C

C-001..... 50
C-002..... 50
C-003..... 50
C-004..... 50
C-005..... 50
C-010..... 50
C-015..... 50
C-020..... 50
C-025..... 50
C-050..... 50
C-075..... 50
C-100..... 50
C-125..... 50
C-FUL..... 50
C-Mini..... 50

D

D-001..... 50
D-002..... 50
D-003..... 50
D-004..... 50
D-005..... 50
D-010..... 50
D-015..... 50
D-020..... 50
D-025..... 50
D-050..... 50
D-075..... 50
D-100..... 50
D-125..... 50
D-FUL..... 50
D-Mini..... 50

X

X1291A..... 20



NOTES

INDEX



TERMS AND CONDITIONS



NOTE:

All items are available from our Midwest Warehouse, in Naperville, IL. Custom made items will be made and shipped from Naperville, IL.

**2000 N. Aurora Road
Naperville, IL 60563**

**Unable to locate an item?
Call or e-mail us for a quote.**

**p: 800-827-3398
f: 800-827-5834
sales@chanson.com**

PRODUCT RETURN POLICY

(see detailed policy below)

Return Requests must be approved by C.H. Hanson with an RGA number and sent prepaid. These returns will be subject to an inspection (for original condition) and assessed a restocking fee. All shortages must be reported within 30 days. No returns will be accepted after 45 days from the date of shipment by C.H. Hanson. Custom made items cannot be returned.

DISCLAIMER OF IMPLIED WARRANTIES AND LIMITATIONS ON CONSEQUENTIAL DAMAGES. THERE IS NO IMPLIED WARRANTY OF MERCHANTABILITY OR FITNESS WITH RESPECT TO THIS PRODUCT. NOR ARE THERE ANY OTHER WARRANTY TIES WHICH EXTEND BEYOND PROVISIONS OF THAT ATTACHED PRODUCT RETURN POLICY.

In any event no implied warranty of merchantability or fitness shall be of a duration greater than the duration referred to in the foregoing Product Return Policy.

C.H. Hanson shall have no liability whatsoever for CONSEQUENTIAL DAMAGES

C.H. Hanson rejects any contradictory or additional terms contained in any purchase order or other document submitted by the Buyer.

On all C.H. Hanson products

- Tapes (Flagging, Barricade, Stake Flags, all Tape items): 30 Day Warranty
- Marking Tools (Paint Markers, Crayons, China Markers, Paint Crayons): 30 Day Warranty
- All other C.H. Hanson product will fall into a Lifetime Warranty with exclusion of abuse (Limited Lifetime Warranty).

Tax Exemption

Illinois, California, Michigan, and Washington state law requires C.H. Hanson to collect sales taxes. It is the responsibility of the buyer to provide a hard copy of the applicable exemption certificate. Actual sales tax is calculated at time of shipment and reflected on the final invoice.

CUSTOM PRODUCTS

C.H. Hanson specializes in creating custom products to fit your business needs. Contact us to get started.

STAMPS



TAGS



TAPE



PENCILS



STENCILS



2000 N. Aurora Rd., Naperville, IL 60563
p: 800-827-3398
sales@chhanson.com
chhanson.com



**C.H.
HANSON**[®]
Since 1866 • Tools for Generations™



MARKING | HAND AND LAYOUT TOOLS | TAPE AND SAFETY

Promising Focus On YOU, Our Customer, In Today's Busy World

After 150+ years, I can say our company has changed a lot since it was founded by my great grandfather, Christian Henry Hanson, in 1866. We have grown out of several facilities and introduced thousands of new products; but one thing that has never wavered is our commitment to the customer. We work each day to Glorify God by delivering on our promise to help you succeed.



We strive to be...

INNOVATIVE

Always improving, always creating

AVAILABLE

Get what you need, when you need it

ECONOMICAL

High performance at the most competitive price

TRUSTWORTHY

Always doing the right thing

Your partners at C.H. Hanson will continue to bring you solutions that support your business today and well into the future!

Blessings,

A handwritten signature in black ink, appearing to read "Phil Hanson".

Phil Hanson

President, C.H. Hanson



TABLE OF CONTENTS

MARKING

Hansco-Mark.....	6
Metal Tags	12
Steel Stamps	22
Commercial Stencils	30
Interlocking Brass Stencils	35
Pencils, Crayons, Markers	40

HAND AND LAYOUT TOOLS

Heritage Spring and Wood Clamps.....	44
Manual Locking Pliers and Clamps.....	48
Shims	50
Layout Tools.....	51
Masonry Line.....	53

TAPE/SAFETY

Barricade Tape.....	54
Safety Tape	57
Flagging Tape	57
Aisle Tape	58
Stake Flags.....	59
Safety Accessories	61

p: 800-827-3398
 f: 800-827-5834
 sales@chhanson.com







PALMGREN...

A NEW FAMILY OF PRODUCTS FROM A NAME YOU CAN TRUST

We manufacture and market the best vises, machine tool accessories and metalworking machine tools under our Palmgren brand name. You get the highest quality products that deliver consistent performance, friendly and efficient service and unmatched technical support. Check out our full offering at www.palmgren.com.

- ABRASIVE FINISHING MACHINES
- SAWS
- LATHES
- MILLING MACHINES
- TAPPING MACHINES
- DRILL PRESSES
- VISES
- BENCH PRESSES AND STANDS
- CLAMPS

PALMGREN®
a CH Hanson brand



Hansco-Mark™

The Machine for Your Marking and ID Needs

Marking Features:

- **Serialization**
- **Date/Time/Shift**
- **Graphics/Logos**
- **Dot or Line Fonts**
- **2-D Data Matrix**
- **Angular Text Mode**



**C.H.
HANSON®**
Since 1866 • Tools for Generations™



MP150i

MD

DEWITT ROBINSON CO



Hansco-Mark™ Permanent Micro-Percussion Marking Machine

Model No.	MP150i
Hanson Item No.	20000
Weight	78.3 lbs.

EVERY MP150i COMES WITH:

- Air regulator with on/off valve
- Main Power cable
- Air hose with all connectors
- 6 Square Nuts plus spare for mounting fixture plate to MP150i frame
- Electrical Ground line
- 1 engraving bit with holder
- 1 spare engraving bit
- 1 Foot switch
- DVD with operation video, manual, and troubleshooting instructions
- Keyboard

MP150i

- C.H. Hanson Limited Three Year Warranty
- Precision and ease in one very capable machine
- Versatile design: light and compact with a large 6" x 4" marking surface
- The very best quality and dependable construction for daily production use
- Over 400 megabytes of memory to store over 30,000 marking files
- Easy integration with additional I/O and RS-232 for marking files or PC computer communication
- USB port allows for easy import of marking files, logos, and fonts
- VGA port allows users to project marking surface to additional monitor
- Fully assembled with power unit, controller, 5.7" LCD monitor, air hoses and fittings
- Mark up to 63 Rockwell (HRC 63), stainless steel, hardened steels, copper, brass, aluminium, or any plastic
- No extra PC computer needed for operation
- 110/220 volt
- Marks 1 – 4 characters / second
- Comes with 2 engraving bits

MARKING FEATURES:

- Serialization
- Date/Time/Shift
- Graphics/Logos
- Dot or Line Fonts
- 2-D Data Matrix
- Angular Text Mode



For an operation manual, or to learn more about the C.H. Hanson Hansco-Mark™ MP150i call 800-827-3398 or email sales@chanson.com

Hansco-Mark™ Permanent Micro-Percussion Portable Marking Machine

Model No. MP5-P
Hanson Item No. 20005
Weight 26 lbs.



EVERY MP5-P COMES WITH:

- Portable marking machine MP5-P head with portable flat fixture
- MP5-P Controller
- Portable Tube-V fixture for tube marking
- 3 meter cable line to connect MP5-P head and controller
- Air hose tube connects the air regulator to the head
- Air regulator with on/off valve
- Main Power cable
- Air hose with all connectors
- Electrical Ground line
- 1 engraving bit with holder
- 1 spare engraving bit
- 1 Foot switch
- DVD with operation video, manual, and troubleshooting instructions
- Keyboard

MARKING FEATURES:

- Serialization
- Date/Time/Shift
- Graphics/Logos
- Dot or Line Fonts
- 2-D Data Matrix
- Angular Text Mode

MP5-P

- C.H. Hanson Limited Three Year Warranty
- Precision and ease in one very portable machine
- Versatile design: light and compact with a large 6" x 2.5" marking surface
- 26 pounds and ergonomic design for easy lifting and holding
- Over 400 megabytes of memory to store over 30,000 marking files
- Easy integration with additional I/O and RS-232 for marking files or PC computer communication
- Easily programmable with keyboard and monitor and detaches to be a single unit marking machine
- USB port allows for easy import of marking files, logos, and fonts
- Fully assembled with power unit, controller, 5.7" LCD monitor, air hoses and fittings
- Mark up to 63 Rockwell (HRC 63), stainless steel, hardened steels, copper, brass, aluminium, or any plastic
- No extra PC computer needed for operation
- 110/220 volt
- Marks 1 - 4 characters / second

For an operation manual, or to learn more about the C.H. Hanson Hansco-Mark™ MP150i call 800-827-3398 or email sales@chhanson.com



Hansco-Mark™ Accessories

FIXTURE PLATE WITH MAGNETIC CLAMP

Hanson Part No. 20014
Weight 20 lbs.

The C.H. Hanson Hansco-Mark™ Fixture Plate with Magnetic Clamp is an attachment part for the Micro-Percussion marking machine (Model #MP150i, C.H. Hanson #20000). The fixture plate and magnetic clamp are designed to secure your name plate and tag during the marking operation by; supporting, clamping, and holding the workpiece in place.

- #20000 with optional
- #20010 C-Axis Pneumatic Chuck and
- #20014 Fixture Plate with Magnetic Clamp

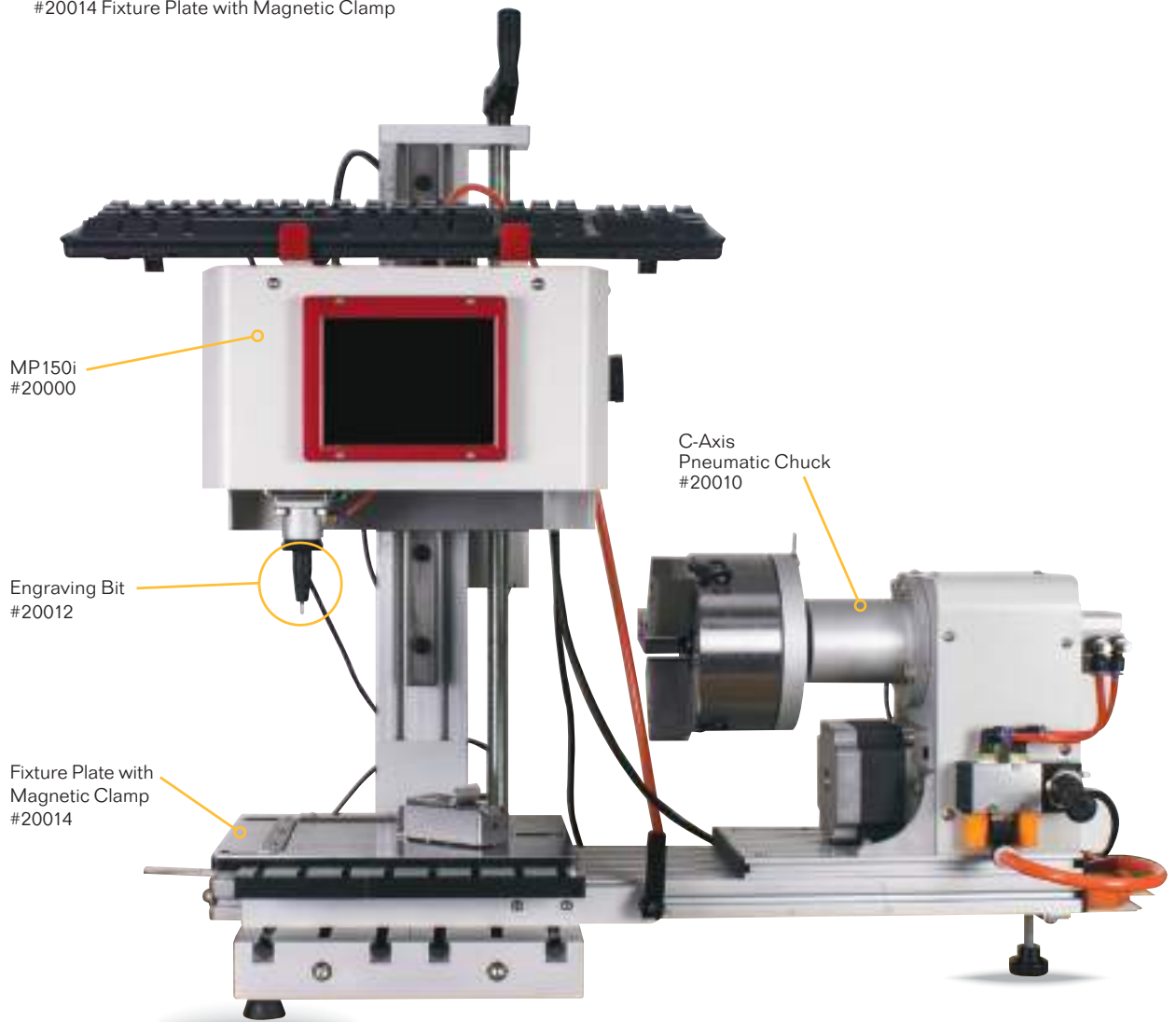



Hansco-Mark™ Accessories

C-AXIS PNEUMATIC CHUCK

Model No. 042-A
Hanson Part No. 20010
Weight 49 lbs.

- C.H. Hanson Limited Three Year Warranty
- Most secure way to hold rounded objects and parts while marking, bar coding, scribing
- Fits Micro-percussion marking machine (Model #MP150i, C.H. Hanson #20000)
- Most accurate way to mark rounded parts and maintain a consistent cut depth

The C.H. Hanson Hansco-Mark™ C-Axis Pneumatic Chuck is an essential accessory when marking round parts. The C-Axis Pneumatic Chuck fits the Hansco-Mark™ micro-percussion machine (MP150i). When particular applications call for permanent marking of cylinders or round parts, the C-Axis Pneumatic Chuck will securely hold the part you wish to mark using compressed air and simultaneously spin the part as the micro-percussion marks. This precision machined unit allows for accurate and consistent marking depth on rounded objects and parts that would otherwise pose as a challenge to mark properly.



REPLACEMENT ENGRAVING BIT

Hanson Part No. 20012
Weight 3.3 lbs.

- Oil hardened steel for maximum durability
- Length: 5"
- Fit both Hansco-Mark permanent marking machines (Model #MP5-P and #MP150i)

The C.H. Hanson Hansco-Mark™ Replacement Engraving Bit can be used on either Micro-Percussion marking machine (Model #MP5-P and #MP150i). This bit is produced from quality steel and oil hardened for durability.

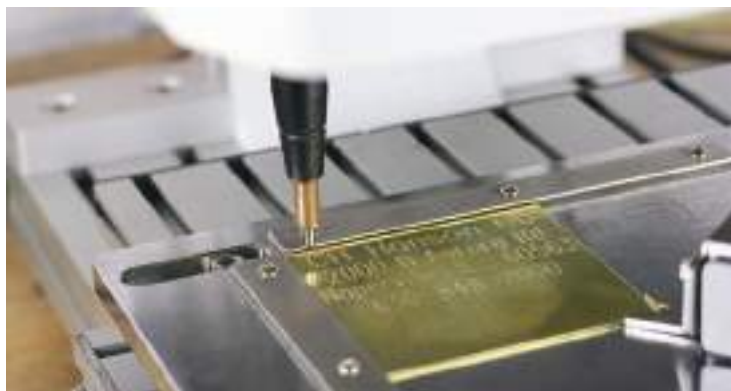



**C.H.
HANSON**[®]
Since 1866 • Tools for Generations™



CUSTOM TAGS AVAILABLE



EMBOSSSED



BLANK



SEALS & ACCESSORIES



PRE-MARKED

800-827-3398



chhanson.com



sales@chhanson.com

Blank Metal Tags - ROUND

- Brass, Aluminum and Anodized Tags: 18 Gauge
- Stainless Steel and 316 Stainless Steel Tags: 20 Gauge
- Package - bagged. (100 per bag unless otherwise noted)

Item No.	Die Reference	Dimensions	Hole Size	Holes
ALUMINUM				
41821	1078A	1" diameter	3/16"	1
41831	1085A	1-3/32" diameter	3/16"	1
41841	1090A	1-1/4" diameter	3/16"	1
41846	1094A	1-3/8" diameter	3/16"	1
41856	1098A	1-1/2" diameter	3/16"	1
41881	1110A	2" diameter	3/16"	1
43474**	1124A	3" diameter	3/16"	1
43475*	1124A	3" diameter	3/16"	1
43476	1124A	3" diameter	3/16"	1
BRASS				
41822	1078B	1" diameter	3/16"	1
41832	1085B	1-3/32" diameter	3/16"	1
41842	1090B	1-1/4" diameter	3/16"	1
41847	1094B	1-3/8" diameter	3/16"	1
41849	1094M	1-3/8" diameter	3/8"	1
41857	1098B	1-1/2" diameter	3/16"	1
41882	1110B	2" diameter	3/16"	1
43468**	1124B	3" diameter	3/16"	1
43469*	1124B	3" diameter	3/16"	1
43470	1124B	3" diameter	3/16"	1
STAINLESS STEEL				
41823	1078S	1" diameter	3/16"	1
41833	1085S	1-3/32" diameter	3/16"	1
41843	1090S	1-1/4" diameter	3/16"	1
41848	1094S	1-3/8" diameter	3/16"	1
41858	1098S	1-1/2" diameter	3/16"	1
41883	1110S	2" diameter	3/16"	1
43471**	1124S	3" diameter	3/16"	1
43472*	1124S	3" diameter	3/16"	1
43473	1124S	3" diameter	3/16"	1
316 STAINLESS STEEL				
43122*	1078	1" diameter	3/16"	1
43123**	1090	1-1/4" diameter	3/16"	1
43124**	1094	1-3/8" diameter	3/16"	1
43125**	1098	1-1/2" diameter	3/16"	1
43126***	1110	2" diameter	3/16"	1
ANODIZED ALUMINUM - RED				
43008****	1078	1" diameter	3/16"	1
43138****	1090	1-1/4" diameter	3/16"	1
43145****	1098	1-1/2" diameter	3/16"	1
43013****	1110	2" diameter	3/16"	1
43018****	1124	3" diameter	3/16"	1
ANODIZED ALUMINUM - BLUE				
43139****	1090	1-1/4" diameter	3/16"	1
43146****	1098	1-1/2" diameter	3/16"	1
43011****	1110	2" diameter	3/16"	1
43016****	1124	3" diameter	3/16"	1

*50 per pack

**25 per pack

***10 per pack

****5 per pack



ALUMINUM
(lightweight, cost effective)



STAINLESS STEEL
(maximum durability)



BRASS
(durable and polished)



ANODIZED ALUMINUM - RED
(light weight)

ANODIZED ALUMINUM - BLACK

43005****	1078	1" diameter	3/16"	1
43140****	1090	1-1/4" diameter	3/16"	1
43147****	1098	1-1/2" diameter	3/16"	1
43010****	1110	2" diameter	3/16"	1
43015****	1124	3" diameter	3/16"	1

ANODIZED ALUMINUM - GOLD

43007****	1078	1" diameter	3/16"	1
43141****	1090	1-1/4" diameter	3/16"	1
43148****	1098	1-1/2" diameter	3/16"	1
43012****	1110	2" diameter	3/16"	1
43017****	1124	3" diameter	3/16"	1

ANODIZED ALUMINUM - GREEN

43082****	1078	1" diameter	3/16"	1
43143****	1090	1-1/4" diameter	3/16"	1
43102****	1098	1-1/2" diameter	3/16"	1
43084****	1110	2" diameter	3/16"	1
43086****	1124	3" diameter	3/16"	1

ANODIZED ALUMINUM - ORANGE

43009****	1078	1" diameter	3/16"	1
43142****	1090	1-1/4" diameter	3/16"	1
43001****	1098	1-1/2" diameter	3/16"	1
43014****	1110	2" diameter	3/16"	1
43019****	1124	3" diameter	3/16"	1

ANODIZED ALUMINUM - YELLOW

43081****	1078	1" diameter	3/16"	1
43144****	1090	1-1/4" diameter	3/16"	1
43077****	1098	1-1/2" diameter	3/16"	1
43083****	1110	2" diameter	3/16"	1
43085****	1124	3" diameter	3/16"	1

MARKING



CUSTOM SOLUTIONS AVAILABLE



Blank Metal Tags - ROUND WITH EARS and OVAL

- Brass, Aluminum and Anodized Tags: 18 Gauge
- Stainless Steel and 316 Stainless Steel Tags: 20 Gauge
- Package - bagged. (100 per bag unless otherwise noted)



ALUMINUM
(lightweight, cost effective)



STAINLESS STEEL
(maximum durability)



BRASS
(durable and polished)



ALUMINUM
(lightweight, cost effective)



STAINLESS STEEL
(maximum durability)



BRASS
(durable and polished)



ANODIZED ALUMINUM - RED
(light weight)

ROUND WITH EARS

Item No.	Die Reference	Dimensions	Hole Size	Holes
ALUMINUM				
41376	722A	1" diameter plus Ear	7/64"	1
41386	723A	1-1/4" diameter plus Ear	11/64"	1
BRASS				
41377	722B	1" diameter plus Ear	7/64"	1
41387	723B	1-1/4" diameter plus Ear	11/64"	1
42387**	723B	1-1/4" diameter plus Ear	11/64"	1
STAINLESS STEEL				
41378	722S	1" diameter plus Ear	7/64"	1
41388	723S	1-1/4" diameter plus Ear	11/64"	1
316 STAINLESS STEEL				
43127**	722	1" diameter plus Ear	7/64"	1
43128***	723	1-1/4" diameter plus Ear	11/64"	1

OVAL TAGS

ALUMINUM				
41696	993A	3/4" x 1-11/32"	3/32"	2
41741	1009A	1" x 1-7/8"	1/8"	2
41771	1019A	1-5/32" x 2-1/16"	1/8"	2
BRASS				
41697	993B	3/4" x 1-11/32"	3/32"	2
41742	1009B	1" x 1-7/8"	1/8"	2
41772	1019B	1-5/32" x 2-1/16"	1/8"	2
STAINLESS STEEL				
41698	993S	3/4" x 1-11/32"	3/32"	2
41743	1009S	1" x 1-7/8"	1/8"	2
41773	1019S	1-5/32" x 2-1/16"	1/8"	2
316 STAINLESS STEEL				
43120***	1009	1"x1-7/8"	1/8"	2
43121***	1019	1-5/32"x2-1/16"	1/8"	2
ANODIZED ALUMINUM - RED				
43149****	1019	1-5/32"x2-1/16"	1/8"	2
ANODIZED ALUMINUM - BLUE				
43150****	1019	1-5/32"x2-1/16"	1/8"	2
ANODIZED ALUMINUM - BLACK				
43151****	1019	1-5/32"x2-1/16"	1/8"	2
ANODIZED ALUMINUM - GOLD				
43152****	1019	1-5/32"x2-1/16"	1/8"	2
ANODIZED ALUMINUM - ORANGE				
43153****	1019	1-5/32"x2-1/16"	1/8"	2
ANODIZED ALUMINUM - GREEN				
43154****	1019	1-5/32"x2-1/16"	1/8"	2
ANODIZED ALUMINUM - YELLOW				
43155****	1019	1-5/32"x2-1/16"	1/8"	2

**25 per pack

***10 per pack

****5 per pack

MARKING



CUSTOM SOLUTIONS AVAILABLE

Blank Metal Tags - HEXAGON, OCTAGON

- Brass, Aluminum and Anodized Tags: 18 Gauge
- Stainless Steel and 316 Stainless Steel Tags: 20 Gauge
- Package - bagged. (100 per bag unless otherwise noted)



ALUMINUM
(lightweight, cost effective)



ALUMINUM
(lightweight, cost effective)



BRASS
(durable and polished)



BRASS
(durable and polished)



STAINLESS STEEL
(maximum durability)



STAINLESS STEEL
(maximum durability)

HEXAGON TAGS

Item No.	Die Reference	Dimensions	Hole Size	Holes
ALUMINUM				
41250	928A	1-1/16"	1/8"	1
41260	932A	1-1/4"	3/16"	1
BRASS				
41482	928B	1-1/16"	1/8"	1
41261	932B	1-1/4"	3/16"	1
42492**	932B	1-1/4"	3/16"	1
STAINLESS STEEL				
41483	928S	1-1/16"	1/8"	1
41262	932S	1-1/4"	3/16"	1
316 STAINLESS STEEL				
43130**	932	1-1/4"	3/16"	1

OCTAGON TAGS

ALUMINUM				
41516	943A	1-1/64"	3/16"	1
41526	947A	1-1/4"	3/16"	1
41531	950A	1-1/2"	3/16"	1
BRASS				
41517	943B	1-1/64"	3/16"	1
41527	947B	1-1/4"	3/16"	1
41532	950B	1-1/2"	3/16"	1
42527**	947B	1-1/4"	3/16"	1
42532**	950B	1-1/2"	3/16"	1
STAINLESS STEEL				
41518	943S	1-1/64"	3/16"	1
41528	947S	1-1/4"	3/16"	1
41533	950S	1-1/2"	3/16"	1
316 STAINLESS STEEL				
43133**	945	1-1/8"	3/16"	1
43131**	947	1-1/4"	3/16"	1
43132**	950	1-1/2"	3/16"	1

**25 per pack

MARKING



CUSTOM SOLUTIONS AVAILABLE



Blank Metal Tags - SQUARE

- Brass, Aluminum and Anodized Tags: 18 Gauge
- Stainless Steel and 316 Stainless Steel Tags: 20 Gauge
- Package - bagged. (100 per bag unless otherwise noted)

Item No.	Die Reference	Dimensions	Hole Size	Holes
ALUMINUM				
41421	913A	1"	3/16"	1
41431	916A	1-1/4"	3/16"	1
41451	3590A	1-1/2"	3/16"	1
41461	3581A	2"	3/16"	1
BRASS				
41422	913B	1"	3/16"	1
41432	916B	1-1/4"	3/16"	1
41452**	3590B	1-1/2"	3/16"	1
41462**	3581B	2"	3/16"	1
42452	3590B	1-1/2"	3/16"	1
42462	3581B	2"	3/16"	1
STAINLESS STEEL				
41423	913S	1"	3/16"	1
41433	916S	1-1/4"	3/16"	1
41453	3590S	1-1/2"	3/16"	1
41463	3581S	2"	3/16"	1
316 STAINLESS STEEL				
43134**	913	1"	3/16"	1
43135**	916	1-1/4"	3/16"	1
43136***	3590	1-1/2"	3/16"	1
43137***	3581	2"	3/16"	1
ANODIZED ALUMINUM - BLACK				
43020****	913	1"	3/16"	1
43025****	916	1-1/4"	3/16"	1
43158****	3590	1-1/2"	3/16"	1
43030****	3581	2"	3/16"	1
43409****	3590	1-1/2"	3/16"	1
ANODIZED ALUMINUM - BLUE				
43021****	913	1"	3/16"	1
43026****	916	1-1/4"	3/16"	1
43157****	3590	1-1/2"	3/16"	1
43031****	3581	2"	3/16"	1
43410****	3590	1-1/2"	3/16"	1
ANODIZED ALUMINUM - GOLD				
43022****	913	1"	3/16"	1
43027****	916	1-1/4"	3/16"	1
43159****	3590	1-1/2"	3/16"	1
43032****	3581	2"	3/16"	1
ANODIZED ALUMINUM - GREEN				
43088****	913	1"	3/16"	1
43090****	916	1-1/4"	3/16"	1
43104****	3590	1-1/2"	3/16"	1
43092****	3581	2"	3/16"	1



ALUMINUM
(lightweight, cost effective)



BRASS
(durable and polished)



STAINLESS STEEL
(maximum durability)



ANODIZED ALUMINUM - RED
(light weight)

ANODIZED ALUMINUM - ORANGE

43024****	913	1"	3/16"	1
43029****	916	1-1/4"	3/16"	1
43003****	3590	1-1/2"	3/16"	1
43034****	3581	2"	3/16"	1

Item No.	Die Reference	Dimensions	Hole Size	Holes
----------	---------------	------------	-----------	-------

ANODIZED ALUMINUM - RED

43023****	913	1"	3/16"	1
43028****	916	1-1/4"	3/16"	1
43156****	3590	1-1/2"	3/16"	1
43033****	3581	2"	3/16"	1

ANODIZED ALUMINUM - YELLOW

43087****	913	1"	3/16"	1
43089****	916	1-1/4"	3/16"	1
43079****	3590	1-1/2"	3/16"	1
43091****	3581	2"	3/16"	1

25 per pack *10 per pack ****5 per pack

Blank Metal Tags - RECTANGLE TAGS WITH ROUNDED CORNERS

- Brass, Aluminum and Anodized Tags: 18 Gauge
- Stainless Steel and 316 Stainless Steel Tags: 20 Gauge
- Package - bagged. (100 per bag unless otherwise noted)

Item No.	Die Reference	Dimensions	Hole Size	Holes
ALUMINUM				
41221	50A	1/2" x 1-9/32"	1/8"	2
41241	140A	5/8" x 2-1/2"	1/8"	2
41251	60A	3/4" x 1-3/4"	1/8"	2
41271	76A	1" x 2"	1/8"	2
41281	3575A	1" x 2-1/2"	1/8"	2
41291	432A	1" x 3"	1/8"	2
41316	96A	1-1/2" x 3"	1/8"	2

BRASS				
41222	50B	1/2" x 1-9/32"	1/8"	2
41242	140B	5/8" x 2-1/2"	1/8"	2
41252	60B	3/4" x 1-3/4"	1/8"	2
41272	76B	1" x 2"	1/8"	2
41282	3575B	1" x 2-1/2"	1/8"	2
41292	432B	1" x 3"	1/8"	2
43411****	432B-16GA	1" x 3"	3/16"	2
41317	96B	1-1/2" x 3"	1/8"	2

STAINLESS STEEL				
41223	50S	1/2" x 1-9/32"	1/8"	2
41243	140S	5/8" x 2-1/2"	1/8"	2
41253	60S	3/4" x 1-3/4"	1/8"	2
41273	76S	1" x 2"	1/8"	2
41283	3575S	1" x 2-1/2"	1/8"	2
41293	432S	1" X 3"	1/8"	2
41318	96S	1-1/2" x 3"	1/8"	2

316 STAINLESS STEEL				
43110**	50	1/2"x1-9/32"	1/8"	2
43111***	140	5/8"x2-1/2"	1/8"	2
43112**	60	3/4"x1-3/4"	1/8"	2
43113***	76	1"x2"	1/8"	2
43114***	3575	1"x2-1/2"	1/8"	2
43115***	432	1"x3"	1/8"	2
43116***	96	1-1/2"x3"	1/8"	2

ANODIZED ALUMINUM - BLACK				
43050****	60	3/4"x1-3/4"	1/8"	2
43035****	76	1"x2"	1/8"	2
43169****	432	1"x3"	1/8"	2
43040****	96	1-1/2"x3"	1/8"	2
43045****	434	2"x4"	1/8"	2
43412****	438	3"x5"	3/16"	2
43413****	432	1"x3"	1/8"	2

ANODIZED ALUMINUM - BLUE				
43051****	60	3/4"x1-3/4"	1/8"	2
43036****	76	1"x2"	1/8"	2
43168****	432	1"x3"	1/8"	2
43041****	96	1.5"x3"	1/8"	2
43046****	434	2"x4"	1/8"	2
43414****	438	3"x5"	3/16"	2
43415****	432	1"x3"	1/8"	2



ALUMINUM
(lightweight, cost effective)



STAINLESS STEEL
(maximum durability)



BRASS
(durable and polished)



ANODIZED ALUMINUM - RED
(light weight)

Item No.	Die Reference	Dimensions	Hole Size	Holes
----------	---------------	------------	-----------	-------

ANODIZED ALUMINUM - GOLD				
43052****	60	3/4"x1-3/4"	1/8"	2
43037****	76	1"x2"	1/8"	2
43170****	432	1"x3"	1/8"	2
43042****	96	1-1/2"x3"	1/8"	2
43047****	434	2"x4"	1/8"	2
43416****	438	3"x5"	3/16"	2

ANODIZED ALUMINUM - GREEN				
43101****	60	3/4"x1-3/4"	1/8"	2
43094****	76	1"x2"	1/8"	2
43105****	432	1"x3"	1/8"	2
43096****	96	1.5"x3"	1/8"	2
43099****	434	2"x4"	1/8"	2

ANODIZED ALUMINUM - ORANGE				
43054****	60	3/4"x1-3/4"	1/8"	2
43039****	76	1"x2"	1/8"	2
43004****	432	1"x3"	1/8"	2
43044****	96	1.5"x3"	1/8"	2
43049****	434	2"x4"	1/8"	2

ANODIZED ALUMINUM - RED				
43053****	60	3/4"x1-3/4"	1/8"	2
43038****	76	1"x2"	1/8"	2
43167****	432	1"x3"	1/8"	2
43043****	96	1-1/2"x3"	1/8"	2
43048****	434	2"x4"	1/8"	2
43418****	438	3"x5"	3/16"	2

ANODIZED ALUMINUM - YELLOW				
43100****	60	3/4"x1-3/4"	1/8"	2
43093****	76	1"x2"	1/8"	2
43080****	432	1"x3"	1/8"	2
43095****	96	1.5"x3"	1/8"	2
43098****	434	2"x4"	1/8"	2

ANODIZED ALUMINUM - CLEAR				
43419****	432	1" x3"	1/8"	2

25 per pack *10 per pack ****5 per pack

MARKING



CUSTOM SOLUTIONS AVAILABLE



Blank Metal Tags - RECTANGLES WITH NOTCHED CORNERS and WITH ROUNDED ENDS

- Brass, Aluminum and Anodized Tags: 18 Gauge
- Stainless Steel and 316 Stainless Steel Tags: 20 Gauge
- Package - bagged. (100 per bag unless otherwise noted)



ALUMINUM
(lightweight, cost effective)



BRASS
(durable and polished)



STAINLESS STEEL
(maximum durability)



ALUMINUM
(lightweight, cost effective)



STAINLESS STEEL
(maximum durability)



BRASS
(durable and polished)

RECTANGLES WITH NOTCHED CORNERS

Item No.	Die Reference	Dimensions	Hole Size	Holes
ALUMINUM				
41331	190A	1-7/16" x 3-1/16"	5/32"	2
BRASS				
41332	190B	1-7/16" x 3-1/16"	5/32"	2
STAINLESS STEEL				
41333	190S	1-7/16" x 3-1/16"	5/32"	2
316 STAINLESS STEEL				
43119***	190	1-7/16"x3-1/16"	5/32"	2
ANODIZED ALUMINUM - RED				
43160****	190	1-7/16"x3-1/16"	5/32"	2
ANODIZED ALUMINUM - BLUE				
43161****	190	1-7/16"x3-1/16"	5/32"	2
ANODIZED ALUMINUM - BLACK				
43162****	190	1-7/16"x3-1/16"	5/32"	2
ANODIZED ALUMINUM - GOLD				
43163****	190	1-7/16"x3-1/16"	5/32"	2
ANODIZED ALUMINUM - ORANGE				
43164****	190	1-7/16"x3-1/16"	5/32"	2
ANODIZED ALUMINUM - GREEN				
43165****	190	1-7/16"x3-1/16"	5/32"	2
ANODIZED ALUMINUM - YELLOW				
43166****	190	1-7/16"x3-1/16"	5/32"	2

RECTANGLES WITH ROUNDED ENDS

Item No.	Die Reference	Dimensions	Hole Size	Holes
ALUMINUM				
41136	21A	5/8" x 1-29/32"	1/8"	2
41151	24A	5/8" x 2-13/16"	5/32"	2
41176	30A	3/4" x 3-1/8"	5/32"	2
41186	32A	49/64" x 1-13/16"	1/8"	2
41196	3585A	1" x 2-1/8"	1/8"	2
BRASS				
41137	21B	5/8" x 1-29/32"	1/8"	2
41152	24-316B	5/8" x 2-13/16"	3/16"	2
41154	24-18B	5/8" x 2-13/16"	5/32"	2
41177	30B	3/4" x 3-1/8"	5/32"	2
41187	32B	49/64" x 1-13/16"	1/8"	2
41197	3585B	1" x 2-1/8"	1/8"	2
STAINLESS STEEL				
41138	21S	5/8" x 1-29/32"	1/8"	2
41153	24S	5/8" x 2-13/16"	5/32"	2
41178	30S	3/4" x 3-1/8"	5/32"	2
41188	32S	49/64" x 1-13/16"	1/8"	2
41198	3585S	1" x 2-1/8"	1/8"	2
316 STAINLESS STEEL				
43106**	21	5/8"x1-29/32"	1/8"	2
43107***	24	5/8"x2-13/16"	5/32"	2
43108***	30	3/4"x3-1/8"	5/32"	2
43109***	3585	1"x2-1/8"	1/8"	2
ANODIZED ALUMINUM - BLACK				
43173****	21	5/8"x1-29/32"	1/8"	2
43180****	3585	1"x2-1/8"	1/8"	2
ANODIZED ALUMINUM - BLUE				
43172****	21	5/8"x1-29/32"	1/8"	2
43179****	3585	1"x2-1/8"	1/8"	2
ANODIZED ALUMINUM - GOLD				
43174****	21	5/8"x1-29/32"	1/8"	2
43181****	3585	1"x2-1/8"	1/8"	2
ANODIZED ALUMINUM - GREEN				
43176****	21	5/8"x1-29/32"	1/8"	2
43183****	3585	1"x2-1/8"	1/8"	2
ANODIZED ALUMINUM - ORANGE				
43175****	21	5/8"x1-29/32"	1/8"	2
43182****	3585	1"x2-1/8"	1/8"	2
ANODIZED ALUMINUM - RED				
43171****	21	5/8"x1-29/32"	1/8"	2
43178****	3585	1"x2-1/8"	1/8"	2
ANODIZED ALUMINUM - YELLOW				
43177****	21	5/8"x1-29/32"	1/8"	2
43184****	3585	1"x2-1/8"	1/8"	2

25 per pack *10 per pack ****5 per pack

NUMBERED CHECKS and NUMBERED VALVE TAGS

NUMBERED CHECKS

- Easy to read black filled numbers
- Available only in unbroken series of 25: 1-25,26-50, up to 200
- All tags are 18 Gauge and have a 3/16" hole
- All sets are wired together in groups of 25



Item No.	Description	Package
40001	1" Brass - 1 to 100	Bagged
40002	1" Brass - 1 to 200	Bagged
40003	1" Brass - 1 to 25	Bagged
40004	1" Brass - 26 to 50	Bagged
40005	1" Brass - 51 to 75	Bagged
40006	1" Brass - 76 to 100	Bagged
40007	1" Brass - 101 to 125	Bagged
40008	1" Brass - 126 to 150	Bagged
40009	1" Brass - 151 to 175	Bagged
40010	1" Brass - 176 to 200	Bagged
40011	1- 1/4" Brass - 1 to 100	Bagged
40012	1- 1/4" Brass - 1 to 200	Bagged
40013	1- 1/4" Brass - 1 to 25	Bagged
40014	1- 1/4" Brass - 26 to 50	Bagged
40015	1- 1/4" Brass - 51 to 75	Bagged
40016	1- 1/4" Brass - 76 to 100	Bagged
40017	1- 1/4" Brass - 100 to 125	Bagged
40018	1- 1/4" Brass - 126 to 150	Bagged
40019	1- 1/4" Brass - 150 to 175	Bagged
40020	1- 1/4" Brass - 175 to 200	Bagged
40021	1- 1/2" Brass -001 to 100	Bagged
40022	1- 1/2" Brass -001 to 200	Bagged
40023	1- 1/2" Brass -001 to 025	Bagged
40024	1- 1/2" Brass -026 to 050	Bagged
40025	1- 1/2" Brass -051 to 075	Bagged
40026	1- 1/2" Brass -076 to 100	Bagged
40027	1- 1/2" Brass -101 to 125	Bagged
40028	1- 1/2" Brass -126 to 150	Bagged
40029	1- 1/2" Brass -151 to 175	Bagged
40030	1- 1/2" Brass -176 to 200	Bagged
40031	1- 1/4" Aluminum - 1 to 100	Bagged
40032	1- 1/4" Aluminum - 1 to 200	Bagged
40033	1- 1/4" Aluminum - 1 to 25	Bagged
40034	1- 1/4" Aluminum - 26 to 50	Bagged
40035	1- 1/4" Aluminum - 51 to 75	Bagged
40036	1- 1/4" Aluminum - 76 to 100	Bagged
40037	1- 1/4" Aluminum - 101 to 125	Bagged
40038	1- 1/4" Aluminum - 126 to 150	Bagged
40039	1- 1/4" Aluminum - 151 to 175	Bagged
40040	1- 1/4" Aluminum - 176 to 200	Bagged

NUMBERED VALVE TAGS

- Easy to read brass tags with black filled letters and numbers
- Lettered in 6 titles and numbered consecutively in unbroken sets of 25: 1-25, 26-50, 51-75, 76-100, etc. up to 200



Item No.	Description	Package
43420	HTG - Brass - 001 to 025	Bagged
43421	HTG - Brass - 026 to 050	Bagged
43422	HTG - Brass - 051 to 075	Bagged
43423	HTG - Brass - 076 to 100	Bagged
43424	HTG - Brass - 101 to 125	Bagged
43425	HTG - Brass - 126 to 150	Bagged
43426	HTG - Brass - 151 to 175	Bagged
43427	HTG - Brass - 176 to 200	Bagged
43428	PLBG - Brass - 001 to 025	Bagged
43429	PLBG - Brass - 026 to 050	Bagged
43430	PLBG - Brass - 051 to 075	Bagged
43431	PLBG - Brass - 076 to 100	Bagged
43432	PLBG - Brass - 101 to 125	Bagged
43433	PLBG - Brass - 126 to 150	Bagged
43434	PLBG - Brass - 151 to 175	Bagged
43435	PLBG - Brass - 176 to 200	Bagged
43436	CW - Brass - 001 to 025	Bagged
43437	CW - Brass - 026 to 050	Bagged
43438	CW - Brass - 051 to 075	Bagged
43439	CW - Brass - 076 to 100	Bagged
43440	CW - Brass - 101 to 125	Bagged
43441	CW - Brass - 126 to 150	Bagged
43442	CW - Brass - 151 to 175	Bagged
43443	CW - Brass - 176 to 200	Bagged
43444	HW - Brass - 001 to 025	Bagged
43445	HW - Brass - 026 to 050	Bagged
43446	HW - Brass - 051 to 075	Bagged
43447	HW - Brass - 076 to 100	Bagged
43448	HW - Brass - 101 to 125	Bagged
43449	HW - Brass - 126 to 150	Bagged
43450	HW - Brass - 151 to 175	Bagged
43451	HW - Brass - 176 to 200	Bagged
43452	CHWR - Brass - 001 to 025	Bagged
43453	CHWR - Brass - 026 to 050	Bagged
43454	CHWR - Brass - 051 to 075	Bagged
43455	CHWR - Brass - 076 to 100	Bagged
43456	CHWR - Brass - 101 to 125	Bagged
43457	CHWR - Brass - 126 to 150	Bagged
43458	CHWR - Brass - 151 to 175	Bagged
43459	CHWR - Brass - 176 to 200	Bagged
43460	GAS - Brass - 001 to 025	Bagged
43461	GAS - Brass - 026 to 050	Bagged
43462	GAS - Brass - 051 to 075	Bagged
43463	GAS - Brass - 076 to 100	Bagged
43464	GAS - Brass - 101 to 125	Bagged
43465	GAS - Brass - 126 to 150	Bagged
43466	GAS - Brass - 151 to 175	Bagged
43467	GAS - Brass - 176 to 200	Bagged



Blank Metal Tags - ACCESSORIES



SPRING SLEEVE CHECK RING

- Easy access to add or remove tags
- Chrome plated
- Does not come with tags
- Bagged per hundred

Item No.	Description	Package
40087	Spring Sleeve Check Ring	Bagged

BEADED CHAIN

- For quick, permanent fastening of checks and tags
- Easily closed by hand
- Bagged per hundred

40096	4.5" Nickel plated beaded chain	Bagged
40097	4.5" Brass plated beaded chain	Bagged
40098	6" Brass plated beaded chain	Bagged

BRASS/NICKEL PLATED S-HOOK LINKS

- For quick, permanent fastening of checks and tags
- Easily closed with pliers
- Bagged per hundred

41000	Brass # 5 - 7/8" long	Bagged
41001	Brass # 3 - 1-1/8" long	Bagged
41002	Brass #2 - 1-1/2" long	Bagged

SPLIT KEY RINGS

- Made of spring tempered steel
- Bagged per hundred

40080	5/8" I.D. Split Key Rings	Bagged
40081	3/4" I.D. Split Key Rings	Bagged
40082	1" I.D. Split Key Rings	Bagged
40083	1.25" I.D. Split Key Rings	Bagged
40084	1.5" I.D. Split Key Rings	Bagged
40085	2" I.D. Split Key Rings	Bagged

ALUMINUM WRITE ON TAGS

- Easily marked with pen, pencil, or other writing tool
- Bagged per hundred

X1291A	1 3/8" x 3 1/8" Aluminum write on tag	Bagged
97443	3" x 5" Aluminum write on tag	Bagged



Blank Metal Tags - ACCESSORIES



BLANK CABLE TAGS

- Made from 28 Gauge soft aluminum
- Easily folds and re-folds multiple times
- Perfect for holding and organizing cables
- Bagged per hundred

Item No.	Description	Die Reference
41901	Length 1-15/16"	585A
41911	Length 2"	588A
41914	Length 3-15/16"	589A
41917	Length 6-1/2"	590A
41920	Length 11"	591A
41924	Length 10"	592A
41930	Length 11"	593A
41939	Length 1-11/16"	3467A
41942	Length 3-3/8"	3470A
41945	Length 5-3/4"	3508A
41951	Length 3-1/2"	3527A
41956	Length 6-3/4"	3555A

PREMIER AUTOMATIC SEALS

- Self-locking, permanent mechanical closure
- 8-3/4" x 5/16" metal strap can be embossed with name and consecutive numbering
- Available in lots of 1,000
- Lettering has a maximum capacity of 20 spaces
- Bagged per thousand
- For custom, call customer service

Item No.	Description	Package
2799PN	Premier Automatic Seals	Bagged

MECHANICAL SEALS

- Precision built to stay locked
- Embossed identity and consecutive numbering
- 8-1/2" x 5/8" with plain or colored heads
- Available in lots of 1,000
- Lettering has a maximum capacity of 20 spaces
- Bagged per thousand
- For custom, call customer service

Item No.	Description	Package
2799GN	Globe Mechanical Seals	Bagged

SECURITY

- Cannot be opened or tampered without detection
- Lead seals are available separately or with wires attached
- Wires are annealed (copper coated) steel unless indicated
- Bagged per hundred, except for the wire spools

Item No.	Description	Package
27911	7/16" SI. Leads With 10" 2-Ply #23 CC Wires	Bagged
27913	1/2" Plain Leads	Bagged
27915	10" 2-Ply #23 CC Wires	Bagged
27916	1000 ft. spool of 27915	Bagged
27917	12" 2-Ply #26 Galv. Wires	Bagged
27918	12" 2-Ply #27 SS Wires	Bagged

SEALING PRESS

- Available with blank dies or marking dies (7/16" diameter) for one or both sides of the lead disc
- Provide copy (max. 4 characters) if desired, and state whether one or both dies are to be lettered
- Strong, small (2-1/2" x 5" closed) press tightly closes seals
- Bagged as each

Item No.	Description	Package
27905	Sealing Press with two blank dies	Bagged
27905A	Sealing Press with one die engraved	Bagged
27905B	Sealing Press with both dies engraved	Bagged
27906	Extra blank dies	Bagged
27906B	Extra engraved dies	Bagged





STEEL STAMPS

Individual Letters

Individual Numbers

Reverse

Sharp faced characters, extra deep cut for marking drop forging dies, die castings, forming dies and molding applications. On a mold stamp the character is engraved normal and reads left to right giving a reverse impression in the mold. When the product is removed from the mold, the lettering produced is raised and can be read normally.

Round Face

Characters are continuous line, round face not sharp like other stamps. Used where reduced stress marking is required.

Spanish

Lower Case

Dot

Offers the most reduced stress mark by producing a character that is impressed in a dot formation. Used where reduced stress marking is required.

Statement, Code, & Symbols

Allow for production and quality control through permanent marks stamped on part for certification/inspection.

Type & Type Holder

Steel Type and Type Holders provide the answer for all batch and general purpose marking. Simply build a series of characters into a holder and with just one strike produce a multi-character mark.

CUSTOM SOLUTIONS AVAILABLE



**C.H.
HANSON**
Since 1866 • Tools for Generations™

800-827-3398 | chanson.com | sales@chanson.com

Stamp Selection Guide - ordering the right stamp for all applications



Grade:	Standard	Heavy Duty	Premier	Rhino
Recommended use:	Medium to light duty	Moderate industrial applications	Ideal for prolonged industrial use	Greatest durability and longevity in all applications
Features:	Standard size shank for hand striking	Oversized shank to deliver more consistent stamp control	Larger shank for better impression and tempered for durability and safety	Largest shank for best impression fully tempered shank Highest quality alloy steel for toughest materials, even stamps materials up to 50 HRC
Character Size	Shank Size			
1/32" .7938mm	-	1/4" x 2-3/8"	5/16" x 2-1/2"	-
1/16" 1.5875mm	1/4" x 2-3/8"	5/16" x 2-1/2"	5/16" x 2-1/2"	-
3/32" 2.7781mm	1/4" x 2-3/8"	5/16" x 2-1/2"	5/16" x 2-3/4"	-
1/8" 3.1750mm	1/4" x 2-3/8"	5/16" x 2-1/2"	3/8" x 2-3/4"	1/2" x 3-1/2"
5/32" 3.9688mm	-	3/8" x 2-3/4"	7/16" x 2-3/4"	-
3/16" 4.7625mm	5/16" x 2-3/8"	3/8" x 2-3/4"	7/16" x 2-3/4"	9/16" x 3-1/2"
1/4" 6.3500mm	3/8" x 2-5/8"	7/16" x 3"	1/2" x 3"	5/8" x 3-1/2"
5/16" 7.9375mm	-	9/16" x 3"	9/16" x 3-1/8"	-
3/8" 9.5250mm	1/2" x 2-3/4"	9/16" x 3-1/8"	5/8" x 3-1/8"	3/4" x 3-1/2"
1/2" 12.7000mm	5/8" x 3"	3/4" x 3-3/4"	7/8" x 4"	-
5/8" 15.875mm	-	3/4" x 3-3/4"	7/8" x 4"	-
3/4" 19.05mm	-	7/8" x 3-3/4"	7/8" x 4"	-
1" 25.4mm	-	1-1/4" x 1 x 4-1/2"	1-1/4" x 1-1/4" x 4-1/2"	-

Grade of Stamp	Frequency of Use	Wood	Leather	Aluminum	Brass	Sheet Metal	Cold Roll Steel	Stainless Steel	Water, Oil, Hardened Steel	Heat Treated Material up to 50 HRC
Standard	Occasional	Not Recommended	Not Recommended	Not Recommended	Not Recommended	Not Recommended	Not Recommended	Not Recommended	Not Recommended	Not Recommended
Heavy Duty	Moderate	Better	Better	Better	Better	Better	Good	Not Recommended	Not Recommended	Not Recommended
Premier	Every Day	Better	Better	Better	Better	Better	Better	Better	Good	Not Recommended
Rhino	High Volume	Best	Best	Best	Best	Best	Best	Best	Best	Best

Not Recommended

Good

Better

Best

MARKING



CUSTOM SOLUTIONS AVAILABLE



Steel Letter and Number Stamp Sets - For hand-held, hammer struck applications

Steel Letter Stamp Sets

- Letter sets contain 27 pieces A thru Z plus ampersand (&)
- Tempered shanks for extra safety

Steel Number Stamp Sets

- Number sets contain 9 pieces 0 thru 9 (the 6 is used as a 9)
- Crowned striking surface ensures full force to the center of the stamp & textured shank provides firm easy grip

Steel Letter and Number Combo Stamp Sets

- Contains: A thru Z, ampersand, plus 0 thru 9 (the 6 is used as a 9)
- Fits flat in tool boxes

Refer to page 79 when selecting grade of stamp
Weights included below Item Number



LETTERS

SIZE	1/32"	1/16"	3/32"	1/8"	5/32"	3/16"	1/4"	5/16"	3/8"	1/2"	5/8"	3/4"	1"
Standard	—	20100 (1.46 lbs.)	20150 (1.48 lbs.)	20200 (1.48 lbs.)	—	20250 (2.14 lbs.)	20300 (3.17 lbs.)	—	20350 (5.67 lbs.)	20400 (10.84 lbs.)	—	—	—
Heavy Duty	20741 (1.44 lbs.)	20751 (2.01 lbs.)	20801 (2.11 lbs.)	20851 (2.14 lbs.)	20901 (3.17 lbs.)	20951 (3.11 lbs.)	21051 (4.61 lbs.)	21101 (7.65 lbs.)	21151 (7.55 lbs.)	21201 (16.64 lbs.)	21251 (16.55 lbs.)	21252 (22.45 lbs.)	21253 (62.7 lbs.)
Premier	22000 (1.44 lbs.)	22050 (2.10 lbs.)	22100 (2.3 lbs.)	22150 (3.18 lbs.)	22200 (4.16 lbs.)	22250 (4.14 lbs.)	22350 (5.75 lbs.)	22400 (7.52 lbs.)	22450 (10.69 lbs.)	22550 (17.54 lbs.)	22600 (24.33 lbs.)	—	22750 (25.25 lbs.)
Rhino	—	—	—	21730 (7.77 lbs.)	—	21750 (8.54 lbs.)	21760 (10.20 lbs.)	—	21770 (14.71 lbs.)	—	—	—	—
Lower Case	—	—	—	—	—	20260 (4.4 lbs.)	—	—	20360 (10.2 lbs.)	—	—	—	—
Spanish	—	—	—	20220 (4.7 lbs.)	—	20270 (7.0 lbs.)	20320 (7.0 lbs.)	—	—	—	—	—	—

NUMBERS

SIZE	1/32"	1/16"	3/32"	1/8"	5/32"	3/16"	1/4"	5/16"	3/8"	1/2"	5/8"	3/4"	1"
Standard	—	20501 (0.50 lbs.)	20521 (0.50 lbs.)	20541 (0.51 lbs.)	—	20561 (0.72 lbs.)	20581 (1.07 lbs.)	—	20601 (1.90 lbs.)	20621 (3.41 lbs.)	—	—	—
Heavy Duty	21301 (0.50 lbs.)	21320 (0.72 lbs.)	21340 (0.73 lbs.)	21360 (0.73 lbs.)	21380 (1.07 lbs.)	21400 (1.06 lbs.)	21440 (1.56 lbs.)	21460 (2.57 lbs.)	21480 (2.58 lbs.)	21500 (2.70 lbs.)	21520 (5.80 lbs.)	21521 (7.3 lbs.)	21522 (20.1 lbs.)
Premier	22801 (0.50 lbs.)	22821 (0.72 lbs.)	22841 (0.79 lbs.)	22861 (1.07 lbs.)	22881 (1.39 lbs.)	22901 (1.40 lbs.)	22941 (1.93 lbs.)	22961 (2.55 lbs.)	22981 (3.38 lbs.)	23021 (6.31 lbs.)	23041 (7.97 lbs.)	—	24001 (17.75 lbs.)
Rhino	—	—	—	21830 (2.61 lbs.)	—	21850 (3.17 lbs.)	21870 (3.82 lbs.)	—	21880 (5.27 lbs.)	—	—	—	—

LETTERS AND NUMBERS COMBO SET

SIZE	1/32"	1/16"	3/32"	1/8"	5/32"	3/16"	1/4"	5/16"	3/8"	1/2"	5/8"	3/4"	1"
Standard	—	20622 (2.88 lbs.)	20623 (2.85 lbs.)	20624 (2.95 lbs.)	—	20625 (3.78 lbs.)	20626 (5.14 lbs.)	—	—	20628 (12.18 lbs.)	—	—	—
Heavy Duty	21622 (2.84 lbs.)	21623 (3.75 lbs.)	21624 (3.71 lbs.)	21625 (3.76 lbs.)	21626 (5.08 lbs.)	21627 (5.13 lbs.)	21628 (7.68 lbs.)	21629 (9.5 lbs.)	21630 (12.25 lbs.)	21631 (29.75 lbs.)	21632 (22 lbs.)	21633 (28.95 lbs.)	21634 (80.9 lbs.)
Premier	24002 (3.67 lbs.)	24003 (3.68 lbs.)	24004 (3.93 lbs.)	24005 (5.13 lbs.)	24006 (7.07 lbs.)	24007 (7.11 lbs.)	24008 (9.07 lbs.)	24009 (11.51 lbs.)	—	21633 (23.65 lbs.)	—	24011 (31.75 lbs.)	24012 (77.15 lbs.)

Steel Letter and Number Stamp Sets - *For hand-held, hammer struck applications* Reversed, Round Face, and Dot Design

Steel Letter Sets

- Letter sets contain 27 pieces A thru Z plus ampersand (&)
- Tempered shanks for extra safety

Steel Number Sets

- Number sets contain 9 pieces 0 thru 9 (the 6 is used as a 9)
- Crowned striking surface ensures full force to the center of the stamp & textured shank provides firm easy grip

Steel Letter and Number Combo Sets

- Contains: A thru Z, ampersand, plus 0 thru 9 (the 6 is used as a 9)
- Fits flat in tool boxes

Refer to page 79 when selecting grade of stamp
Weights included below Item Number



LETTER STAMPS - PREMIER GRADE

SIZE	1/32"	1/16"	3/32"	1/8"	5/32"	3/16"	1/4"	5/16"	3/8"	1/2"
Reversed	25000 (1.44 lbs.)	25050 (2.08 lbs.)	25100 (2.23 lbs.)	25150 (3.19 lbs.)	25200 (4.18 lbs.)	25250 (4.17 lbs.)	25300 (5.70 lbs.)	25350 (7.56 lbs.)	25400 (5.67 lbs.)	25450 (10.69 lbs.)
Round Face	—	25700 (2.10 lbs.)	25750 (2.28 lbs.)	25800 (3.15 lbs.)	—	25850 (4.17 lbs.)	25900 (5.73 lbs.)	—	25950 (10.15 lbs.)	26000 (17.51 lbs.)
Dot Design	—	—	—	26200 (3.11 lbs.)	—	26250 (4.13 lbs.)	26300 (7.77 lbs.)	—	26350 (10.20 lbs.)	26400 (17.80 lbs.)

NUMBER STAMPS - PREMIER GRADE

SIZE	1/32"	1/16"	3/32"	1/8"	5/32"	3/16"	1/4"	5/16"	3/8"	1/2"
Reversed	25501 (0.50 lbs.)	25521 (0.73 lbs.)	25541 (0.53 lbs.)	25561 (1.40 lbs.)	25581 (1.06 lbs.)	25601 (1.40 lbs.)	25621 (1.93 lbs.)	25641 (2.53 lbs.)	25661 (3.23 lbs.)	25681 (5.97 lbs.)
Round Face	—	26061 (0.72 lbs.)	26081 (2.78 lbs.)	26101 (1.06 lbs.)	—	26121 (1.41 lbs.)	26141 (1.92 lbs.)	—	26161 (3.39 lbs.)	26181 (6.15 lbs.)
Dot Design	—	—	—	26601 (1.06 lbs.)	—	26621 (1.4 lbs.)	26641 (1.94 lbs.)	—	26661 (3.34 lbs.)	26681 (6.32 lbs.)

LETTERS AND NUMBER COMBO SET STAMPS - PREMIER GRADE

SIZE	1/32"	1/16"	3/32"	1/8"	5/32"	3/16"	1/4"	5/16"	3/8"	1/2"
Reversed	25682 (3.67 lbs.)	25683 (3.67 lbs.)	25684 (3.95 lbs.)	25685 (5.13 lbs.)	25686 (7.10 lbs.)	25687 (7.60 lbs.)	25688 (9.01 lbs.)	25689 (11.49 lbs.)	25690 (12.25 lbs.)	25691 (22.45 lbs.)
Round Face	—	26183 (3.67 lbs.)	26184 (3.91 lbs.)	26185 (5.04 lbs.)	—	26187 (7.06 lbs.)	26188 (9.01 lbs.)	—	26189 (12.25 lbs.)	26190 (22.45 lbs.)
Dot Design	—	—	—	26685 (5.04 lbs.)	—	26687 (7.07 lbs.)	26688 (9.06 lbs.)	—	—	—

DOUBLE DIGIT SETS

SIZE	1/4"
00-09	21080 (4.63 lbs.)
10-19	21081 (4.63 lbs.)
20-29	21082 (4.63 lbs.)
30-39	21083 (4.63 lbs.)
40-49	21084 (4.63 lbs.)
50-59	21085 (4.63 lbs.)
60-69	21086 (4.63 lbs.)
70-79	21087 (4.63 lbs.)
80-89	21088 (4.63 lbs.)
90-99	21089 (4.63 lbs.)

Single Pieces and New 440C Stainless Steel Stamps

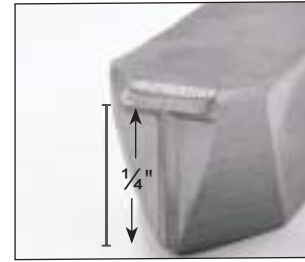

Single Pieces

- Individual Stamps
- Choice of Standard, Heavy Duty, Premier, Rhino, Reversed, Round Face, and Dot Design
- To order Single pieces use the letter set part number of the size and grade, followed by the character you wish to order

FOR EXAMPLE:

- 1/8" Standard Grade Letter "H" is item number 20200H
- 1/8" Standard Grade Number "5" is item number 202005

The size of the stamp describes the actual dimension of the mark that will be made by the stamp.

Refer to page 79 when selecting grade of stamp
Weights included below Item Number

SINGLE PIECE STAMPS

SIZE	1/32"	1/16"	3/32"	1/8"	5/32"	3/16"	1/4"	5/16"	3/8"	1/2"	5/8"	1"
Standard	—	20100 (0.04 lbs.)	20150 (0.04 lbs.)	20200 (0.04 lbs.)	—	20250 (0.06 lbs.)	20300 (0.10 lbs.)	—	20350 (0.20 lbs.)	20400 (0.32 lbs.)	—	—
Heavy Duty	20741 (0.04 lbs.)	20751 (0.04 lbs.)	20801 (0.06 lbs.)	20851 (0.06 lbs.)	20901 (0.10 lbs.)	20951 (0.16 lbs.)	21051 (0.16 lbs.)	21101 (0.20 lbs.)	21151 (0.26 lbs.)	21201 (0.54 lbs.)	21251 (0.56 lbs.)	—
Premier	22000 (0.06 lbs.)	22050 (0.06 lbs.)	22100 (0.08 lbs.)	22150 (0.10 lbs.)	22200 (0.14 lbs.)	22250 (0.14 lbs.)	22350 (0.18 lbs.)	22400 (0.26 lbs.)	22450 (0.32 lbs.)	22550 (0.58 lbs.)	22600 (0.82 lbs.)	22750 (1.70 lbs.)
Rhino	—	—	—	21730 (0.06 lbs.)	—	21750 (0.30 lbs.)	21760 (0.38 lbs.)	—	21770 (0.50 lbs.)	—	—	—
Reversed	25000 (0.06 lbs.)	25050 (0.06 lbs.)	25100 (0.06 lbs.)	25150 (0.10 lbs.)	25200 (0.14 lbs.)	25250 (0.14 lbs.)	25300 (0.20 lbs.)	25350 (0.26 lbs.)	25400 (0.32 lbs.)	25450 (0.58 lbs.)	—	—
Round Face	—	25700 (0.06 lbs.)	25750 (0.06 lbs.)	25800 (0.10 lbs.)	—	25850 (0.14 lbs.)	25900 (0.20 lbs.)	—	25950 (0.32 lbs.)	26000 (0.58 lbs.)	—	—
Dot Design	—	—	—	26200 (0.10 lbs.)	—	26250 (0.14 lbs.)	26300 (0.20 lbs.)	—	26350 (0.30 lbs.)	26400 (0.56 lbs.)	—	—

NEW 440C STAINLESS STEEL STAMPS

- Withstands highly corrosive environments
- Ideal for industries where cross contamination and corrosion resistance are critical
- Letter sets contain 27 pieces A thru Z plus ampersand (&)
- Number sets contain 9 pieces 0 thru 9 (the 6 is used as a 9)

Item No.	Description	Weight
29100	1/8" Stainless Steel Letter Set	3.18 lbs.
29150	1/8" Stainless Steel Number Set	1.91 lbs.
29175	1/8" Stainless Steel Combo Letter/Number Set	5.13 lbs.
29200	1/4" Stainless Steel Letter Set	6 lbs.
29250	1/4" Stainless Steel Number Set	2.02 lbs.
29275	1/4" Stainless Steel Combo Letter/Number Set	9.46 lbs.
29300	3/8" Stainless Steel Letter Set	10.69 lbs.
29350	3/8" Stainless Steel Number Set	2.14 lbs.
29375	3/8" Stainless Steel Combo Letter/Number Set	13.85 lbs.



Steel Hand Stamps

KEY STAMPS

- 1/2 x 3 inches long steel stamp

Item No.	Description	Pkg.
DO NOT DUPLICATE		
26990	1/16" Do Not Duplicate (2 Lines)	Box
26991	3/32" Do Not Duplicate (2 Lines)	Box
DO NOT COPY		
26992	3/32" Do Not Copy (2 Lines)	Box
MASTER		
26993	3/32" Master	Box



STAMPING HAMMERS

- Hammers are available with an engraved (fixed) character in one or both ends
- Hammers are also available with one interchangeable end
- Available with letters, numbers or symbols
- Available in 1/8", 3/16", 1/4" characters
- 2 character stamping hammers available upon request. Please call for a quote.

Item No.	Description	Pkg.
28060	Stamping Hammer with fixed character on one end	Bulk
28061	Stamping Hammer with two fixed ends	Bulk
28062	Stamping Hammer with interchangeable slot	Bulk
28063	Stamping Hammer Insert with character for 28062	Bulk



STEEL STAMP HOLDER

- Industrial grade steel stamp holder
- Protects your hand from striking a steel stamp
- Textured handle for comfortable and secure grip
- Allows the user to strike a steel stamp harder knowing their hand is safely out of harms way
- Slide lock keeps the steel stamp securely locked in place
- Holder will fit one (1) steel stamp with a character size ranging from 1/32" to 1/2" (a shank size up to 7/8" thick)

Item No.	Description	Weight
28065	Hand Stamp Holder 6.5" long	.72 lbs



Electric 2-Speed Pen Engraver

C.H. Hanson's 2-speed electric pencil engraver has a solid stainless steel body with a polymer ergonomic grip which provides comfort and ease of use. Its unique design provides a lightweight, slender and well balanced unit. With three types of engraving points and adjustable power, the most delicate to hardest material can be marked.

Item No.	Description	Weight
50002	Electric 2-speed pencil engraver	0.65 oz.

REPLACEMENT BITS:

50003	1 - HSS replacement bit
50004	1 - Carbide replacement bit
50005	1 - Diamond replacement bit

- Speeds 2
- Strokes per minute Low-3600/High-7200
- Voltage 110V
- Watts 8
- Point diameter 1/16" (.062)
- Tool length 7-1/4"
- Each unit includes one carbide, one HSS bit, and one diamond bit



Type and Type Holders

- Made of high shock alloy steel
- To order single type pieces, use the part number below and add the desired character
- For example: 1/16" letter "C" is 27630C



1/4 " CHARACTER TYPE

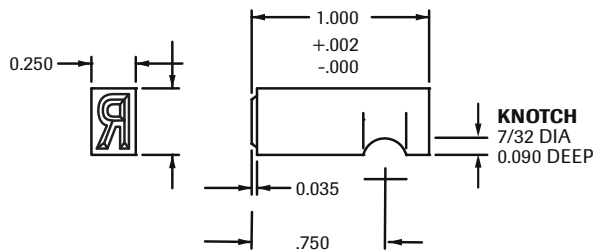

1/4 " CHARACTER TYPE

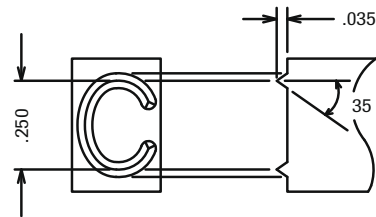

CHARACTER SIZE

BLANK SIZE

- 1/16" = .093 x .250 x 1.000
- 1/8" = .125 x .250 x 1.000
- 3/16" = .187 x .250 x 1.000
- 1/4" = .250 x .375 x 1.000

W-1 MATERIAL

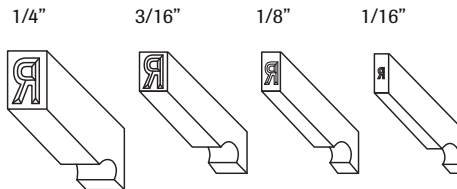

TYPE LETTER SETS

- Contains alloy letters from A-Z

Item No.	Description	Package
27640	1/2" Single Piece	Bagged
27630	1/16" Steel Type Letter Sets	Bagged
27632	1/8" Steel Type Letter Sets	Bagged
27634	3/16" Steel Type Letter Sets	Bagged
27636	1/4" Steel Type Letter Sets	Bagged
27638	3/8" Steel Type Letter Sets	Bagged

TYPE NUMBER SETS

- Contains alloy steel numbers from 0-9

27631	1/16" Steel Type Number Sets	Bagged
27633	1/8" Steel Type Number Sets	Bagged
27635	3/16" Steel Type Number Sets	Bagged
27637	1/4" Steel Type Number Sets	Bagged
27639	3/8" Steel Type Number Sets	Bagged
27641	1/2" Steel Type Number Sets	Bagged

SINGLE TYPE PIECES

- Individual pieces are letters A-Z or numbers from 0-9

Item No.	Description	Package
27630_	1/16" Single Piece	Bagged
27632_	1/8" Single Piece	Bagged
27634_	3/16" Single Piece	Bagged
27636_	1/4" Single Piece	Bagged
27638_	3/8" Single Piece	Bagged
27640_	1/2" Single Piece	Bagged

TYPE BLANKS/SPACERS

- Used to separate letters, numbers or add spaces

27630BL	1/16" Blank Space	Bagged
27632BL	1/8" Blank Space	Bagged
27634BL	3/16" Blank Space	Bagged
27636BL	1/4" Blank Space	Bagged
27638BL	3/8" Blank Space	Bagged
27640BL	1/2" Blank Space	Bagged

Type and Type Holders

- Made of high shock alloy steel
- Most durable steel type holders on the market
- Easily interchangeable letters and numbers
- Save time and money with one step marking
- Steel type not included unless purchased as a kit

TYPE HOLDERS

- Unique locking bar prevents type from incorrect insertion
- Allows for marking one line of characters into various industrial products
- Package - bagged

Item No.	Description	Weight
27600	1/16" Type Holder - character capacity 10	0.68 lbs.
27601	1/16" Type Holder - character capacity 16	0.77 lbs.
27620	1/8" Type Holder - character capacity 8	0.69 lbs.
27621	1/8" Type Holder - character capacity 12	0.28 lbs.
27624	1/8" Type Holder - character capacity 15	0.84 lbs.
27604	3/16" Type Holder - character capacity 10	0.98 lbs.
27605	3/16" Type Holder - character capacity 15	0.87 lbs.
27608	1/4" Type Holder - character capacity 8	1.04 lbs.
27609	1/4" Type Holder - character capacity 12	0.86 lbs.
27610	3/8" Type Holder - character capacity 6	1.07 lbs.
27611	3/8" Type Holder - character capacity 10	0.81 lbs.
27612	1/2" Type Holder - character capacity 4	0.93 lbs.
27613	1/2" Type Holder - character capacity 6	0.93 lbs.



KITS

- Packed in sturdy, professional grade wooden box
- Includes type holder and type
- 40 pieces: A-Z, 0-9, Dash, 3 Blank Spacers
- 48 pieces also include 8 extra characters of your choice

Item No.	Description	Package
27770	40 piece kit of type 1/16"	Box
27771	48 piece kit of type 1/16"	Box
27774	40 piece kit of type 1/8"	Box
27775	48 piece kit of type 1/8"	Box
27778	40 piece kit of type 3/16"	Box
27779	48 piece kit of type 3/16"	Box
27782	40 piece kit of type 1/4"	Box
27783	48 piece kit of type 1/4"	Box





HANDICAP STENCIL



Item No.	Character Size	Height	Width
70340	21.5"	24"	24"
70341	28"	34"	32"
70342	34"	40"	36"
70343*	39"	48"	40"

***Most Popular Size**

Commercial Stencils - 1/8" Heavy Duty Low Density Polyethylene (LDPE)

- Long Lasting material built for daily use
- Not damaged by any paint or solvents
- Lays flat and resists lifting when painted with a spray gun or spray can
- Precision cut to ensure high quality marking
- Cleans easily after paint has dried
- Custom wording and images available
- Character sizes from 1/2" to 12" available
- Most stencils in stock and ship within 24 hours
CALL FOR AVAILABILITY
- (Curb) has additional material above legend for optimal use when stenciling curbs



NO PARKING

Item No.	Character Size	Height	Width
69999	4" x 3"	10"	36"
70000	4" x 3" (Curb)	10"	36"
70001	6" x 4"	12"	54"
70002*	12" x 9"	18"	103"
70003	18" x 12"	24"	130"
70004	24" x 12"	30"	130"

FIRE LANE

70029	4" x 3"	10"	36"
70030	4" x 3" (Curb)	10"	36"
70031*	12" x 9"	18"	100"
70032	18" x 12"	24"	120"

RESERVED

70040	6" x 4"	12"	48.5"
70041	12" x 9"	18"	92"

VISITORS

70050	6" x 4"	12"	48.5"
70051*	12" x 9"	18"	92"

STOP

70060	6" x 4"	12"	26.5"
70061	12" x 9"	18"	48"
70062	18" x 12"	24"	60"
70063*	24" x 12"	30"	60"
70064	36" x 12"	42"	60"

ENTER

70080	6" x 4"	12"	32"
70081	12" x 9"	18"	59"

WAY

70140	6" x 4"	12"	21"
70141	12" x 9"	18"	37"

*Most Popular Size



Commercial Stencils - 1/8" Heavy Duty Low Density Polyethylene (LDPE)

- Long Lasting material built for daily use
- Not damaged by any paint or solvents
- Lays flat and resists lifting when painted with a spray gun or spray can
- Precision cut to ensure high quality marking
- Cleans easily after paint has dried
- Custom wording and images available
- Character sizes from 1/2" to 12" available
- Most stencils in stock and ship within 24 hours
CALL FOR AVAILABILITY
- (Curb) has additional material above legend for optimal use when stenciling curbs

LOADING

Item No.	Character Size	Height	Width
70160	6" x 4"	12"	43"
70161	12" x 9"	18"	81"



RESIDENT

70330	6" x 4"	12"	48.5"
70331	12" x 9"	18"	92"



ZONE

70270	6" x 4"	12"	26.5"
70271	12" x 9"	18"	48"



YIELD

70292	18" x 12"	24"	74"
70293	24" x 12"	30"	74"



EXIT

70092	18" x 12"	24"	60"
70093	24" x 12"	30"	60"



ONLY

70103	24" x 12"	30"	74"
-------	-----------	-----	-----



ARROW COMBO

70491*	62" Long	106"	40"
--------	----------	------	-----

ARROW CURVED

70480	42" Long	48"	36"
70481*	62" Long	70"	48"



ARROW STRAIGHT

70470	42" Long	48"	24"
70471*	62" Long	70"	40"
70472	84" Long	96"	48"

*Most Popular Size

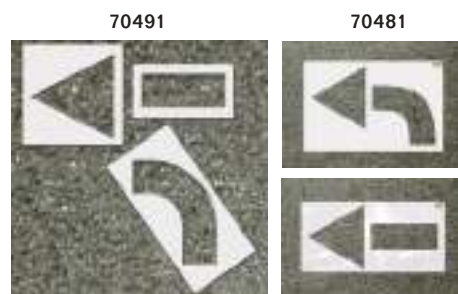

70471

MARKING



CUSTOM SOLUTIONS AVAILABLE

Commercial Stencils - 1/8" Heavy Duty Low Density Polyethylene (LDPE)

- Long Lasting material built for daily use
- Not damaged by any paint or solvents
- Lays flat and resists lifting when painted with a spray gun or spray can
- Precision cut to ensure high quality marking
- Cleans easily after paint has dried
- Custom wording and images available
- Character sizes from 1/2" to 12' available
- Most stencils in stock and ship within 24 hours **CALL FOR AVAILABILITY**
- (Curb) has additional material above legend for optimal use when stenciling curbs



LETTER KIT - 29 PC.

Item No.	Character Size	Height	Width
Curb Marking			
70411	3"x2"	10"	4"
70413	4"x2.75"	10"	4.75"
HWY Fonts			
70410	3"x2"	7"	4"
70412	4"x2.75"	8"	4.75"
70414	5"x3.25"	9"	5.25"
70415	6"x4"	10"	6"
70416	8"x5.25"	12"	7.25"
70417	10"x6.6"	14"	8.6"
70418*	12"x9"	16"	11"

LETTER KIT - 38 PC.

Item No.	Character Size	Height	Width
Curb Marking			
70441	3"x2"	10"	4"
70443	4"x2.75"	10"	4.75"
HWY Fonts			
70440	3"x2"	7"	4"
70445*	6"x4"	10"	6"
70448*	12"x9"	16"	11"



NUMBER KIT - 12 PC.

Item No.	Character Size	Height	Width
For Curb Marking			
70351	3"x2"	10"	4"
70353	4"x2.75"	10"	4.75"
HWY Font			
70350	3"x2"	7"	4"
70352*	4"x2.75"	8"	4.75"
70354	5"x3.25"	9"	5.25"
70355*	6"x4"	10"	6"
70356	8"x5.25"	12"	7.25"
70357	10"x6.6"	14"	8.6"
70358*	12"x9"	16"	11"

NUMBER KIT - 18 PC.

Item No.	Character Size	Height	Width
HWY Font			
70380	3"x2"	7"	4"
70382	4"x2.75"	8"	4.75"
70385	6"x4"	10"	6"
70387	10"x6.6"	14"	8.6"
70388*	12"x9"	16"	11"

*Most Popular Size



CUSTOM WORD

Item No.	Character Height	Character Width
70802	4"	2.5"
70803	6"	4"
70804	8"	5.5"
70805	10"	6.6"
70806	12"	9"



Commercial Stencils - Light Duty



PLASTIC

- Made of interlocking flexible PVC plastic
- Interlocks in the corners
- Washable, cleans with a paint solvent
- Each 46 pc set contains: AABCDEFHGHIJKLMNO PQR SSTUVWXYZ, All numbers (10 pieces 0-9), 1-Dollar sign, 1-Ampersand, 1-Large space, 1-Small space, 1-Period, and 1-Dash
- 138 pc set contains 3 of the 46 pc set

Item No.	Description	Package
10191	1" - 46 pc. Plastic Interlocking Stencil	Box
10192	2" - 46 pc. Plastic Interlocking Stencil	Box
10193	3" - 46 pc. Plastic Interlocking Stencil	Box
10194	4" - 46 pc. Plastic Interlocking Stencil	Box
10198	6" - 46 pc. Plastic Interlocking Stencil	Box
10189	1" - 138 pc. Plastic Interlocking Stencil	Box
10190	2" - 138 pc. Plastic Interlocking Stencil	Box
10195	3" - 138 pc. Plastic Interlocking Stencil	Box
10187	4" - 138 pc. Plastic Interlocking Stencil	Box
10188	6" - 138 pc. Plastic Interlocking Stencil	Box

ECONOMY GRADE

- Promotes safety in and around the factory
- 2" characters unless otherwise indicated
- Made of .015" PVC plastic 1/64"
- Conforms to OSHA Regulation 1910.145
- Reusable

Item No.	Description	Package
12400	NO SMOKING	Carded
12401	NO PARKING	Carded
12402	KEEP OUT	Carded
12403	NO TRESPASSING	Carded
12404	FOR SALE	Carded
12405	FOR RENT	Carded
12406	DANGER - 2.5" Characters	Carded
12407	CAUTION - 2.5" Characters	Carded
12408	WARNING - 2.5" Characters	Carded
12409	(Arrow Symbol) 10" long	Carded
12410	FLAMMABLE	Carded
12411	EXIT	Carded
12412	HIGH VOLTAGE	Carded
12413	FIRE EXTINGUISHER	Carded
12414	GARAGE SALE	Carded
12415	BIOHAZARD	Carded
12416	(Handicapped Symbol) - 15.5" dia.	Carded
12417	(No Parking Symbol) - 15.5" dia.	Carded
12418	(No Smoking Symbol) - 15.5" dia.	Carded
12420	WATCH YOUR STEP - 3" char.	Carded
12421	KEEP AISLE CLEAR - 3" char.	Carded



ECONOMY GRADE

- Promotes safety and direct traffic in the parking lot
- 12" characters unless otherwise indicated
- Made of .015" PVC plastic 1/64"
- Large, easy to read characters and symbols

Item No.	Description	Package
12430	NO PARKING	Tube
12431	HANDICAP	Tube
12432	FIRE LANE	Tube
12433	EXIT ONLY	Tube
12434	RESERVED	Tube
12435	VISITORS	Tube
12436	Straight Arrow Symbol - 37" long	Tube
12437	Curved Arrow Symbol - 43" long	Tube
12438	Handicap Symbol - 43" high	Tube
12439	ENTRANCE	Tube
12441	DISABLED	Tube
12460	Stencil Parking Lot Kit inc. 12430, 12434, 12435, 12436, 12437, 12438	Tube





Interlocking Brass Stencils



A

A SINGLE BRASS STENCIL

- Re-usable durable 28 gauge brass stencil
- Cleans easily with paint solvent
- Stencils slide together and come apart easily
- To order individual stencils, use the part number below and add the desired character
- For example 1" letter "H" is item number 10008H, 1/2" number "5" is item number 100065
- For additional punctuation characters use the following:

BG= Beginner	CM=Comma	DL=Dollar
PE= Period Ender	CE= Cent	DA= Dash
PD=Period	SP= Space	

Item No.	Description	Package
10006_	1/2" Single Stencil	Box
10007_	3/4" Single Stencil	Box
10008_	1" Single Stencil	Box
10009_	1-1/2" Single Stencil	Box
10011_	2" Single Stencil	Box
10012_	2-1/2" Single Stencil	Box
10013_	3" Single Stencil	Box
10014_	4" Single Stencil	Box
10015_	5" Single Stencil	Box
10016_	6" Single Stencil	Box
10160_	8" Single Stencil	Box
10161_	10" Single Stencil	Box
10162_	12" Single Stencil	Box
10175_	1" Vertical Stencil	Box
10176_	2" Vertical Stencil	Box
10177_	3" Vertical Stencil	Box

Interlocking Brass Stencils

A



A 15 PIECE SINGLE NUMBER SET

- Each set contains 15 pieces as follows:
1 2 3 4 5 6 7 8 9 0
Other: 1-Beginner 1-Plain Ender 1-Dash 1-Period

Item No.	Description	Package
10006	1/2" Numbers	Box
10007	3/4" Numbers	Box
10008	1" Numbers	Box
10009	1-1/2" Numbers	Box
10011	2" Numbers	Box
10012	2-1/2" Numbers	Box
10013	3" Numbers	Box
10014	4" Numbers	Box
10015	5" Numbers	Box
10016	6" Numbers	Box

B



B 33 PIECE SINGLE LETTER SET

- Each set contains 33 pieces as follows:
All letters (26 pieces A-Z)
Other: 1-Beginner 1-Period Ender 1-Comma
1-Dash 1-Period 1-Ampersand 1-Apostrophe

Item No.	Description	Package
10026	1/2" Letters	Box
10027	3/4" Letters	Box
10028	1" Letters	Box
10029	1-1/2" Letters	Box
10031	2" Letters	Box
10032	2-1/2" Letters	Box
10033	3" Letters	Box
10034	4" Letters	Box
10035	5" Letters	Box
10036	6" Letters	Box

C



C 45 PIECE SINGLE LETTER AND NUMBER SET

- Each set contains 45 pieces as follows:
All letters (26 pieces A-Z), 0123456789
Other: 1-Beginner 1-Plain Ender 1-Period Ender 1-Comma
2-Spacers 1-Dash 1-Period 1-Ampersand 1-Apostrophe

Item No.	Description	Package
10066	1/2" Letters & Numbers	Box
10067	3/4" Letters & Numbers	Box
10068	1" Letters & Numbers	Box
10069	1-1/2" Letters & Numbers	Box
10071	2" Letters & Numbers	Box
10072	2-1/2" Letters & Numbers	Box
10073	3" Letters & Numbers	Box
10074	4" Letters & Numbers	Box
10075	5" Letters & Numbers	Box
10076	6" Letters & Numbers	Box

MARKING



CUSTOM SOLUTIONS AVAILABLE

Interlocking Brass Stencils

A



A 77 PIECE SINGLE LETTER AND NUMBER SET

- Each set contains 77 pieces as follows: AA BB CC DD EE FF GG HH II JJ K LL MM NN OO PP Q RR SS TT UU VV WW XY Z, 11 22 33 44 55 66 77 88 99 00 1-Beginner, 1-Plain Ender, 2-Spacers, 1-Comma, 1-Dash, 2-Period, 1-Period Ender, 1-Ampersand, 1-Apostrophe

Item No.	Description	Package
10106	1/2" Letters & Numbers	Box
10107	3/4" Letters & Numbers	Box
10108	1" Letters & Numbers	Box
10109	1-1/2" Letters & Numbers	Box
10111	2" Letters & Numbers	Box
10112	2-1/2" Letters & Numbers	Box
10113	3" Letters & Numbers	Box
10114	4" Letters & Numbers	Box
10115	5" Letters & Numbers	Box
10116	6" Letters & Numbers	Box

B



B 92 PIECE SINGLE LETTER AND NUMBER SET

- Each set contains 92 pieces as follows: AAA BB CC DD EEEE FF GG HH III JJ KK LL MM NNN OOO PP Q RR SSS TT UU VV WW XX YY ZZ 111 22 33 44 55 66 77 88 99 000, 1-Beginner, 1-Plain Ender, 3-Spacers, 1-Period Ender, 1-Comma, 1-Dash, 2-Periods, 2-Ampersand, 1-Apostrophe

Item No.	Description	Package
10146	1/2" Letters & Numbers	Box
10147	3/4" Letters & Numbers	Box
10148	1" Letters & Numbers	Box
10149	1-1/2" Letters & Numbers	Box
10151	2" Letters & Numbers	Box
10152	2-1/2" Letters & Numbers	Box
10153	3" Letters & Numbers	Box
10154	4" Letters & Numbers	Box
10155	5" Letters & Numbers	Box
10156	6" Letters & Numbers	Box

C



C CONSUMER PACKED SET - CARDED

- Ideal for Retail hanging packaging

Item No.	Description	Package
10303	1" Stencil Numbers (15 pieces)	Carded
10305	2" Stencil Numbers (15 pieces)	Carded
10307	3" Stencil Numbers (15 pieces)	Carded
10323	1" Stencil Letters (33 pieces)	Carded
10325	2" Stencil Letters (33 pieces)	Carded
10327	3" Stencil Letters (33 pieces)	Carded

MARKING



CUSTOM SOLUTIONS AVAILABLE



Interlocking Brass Stencils

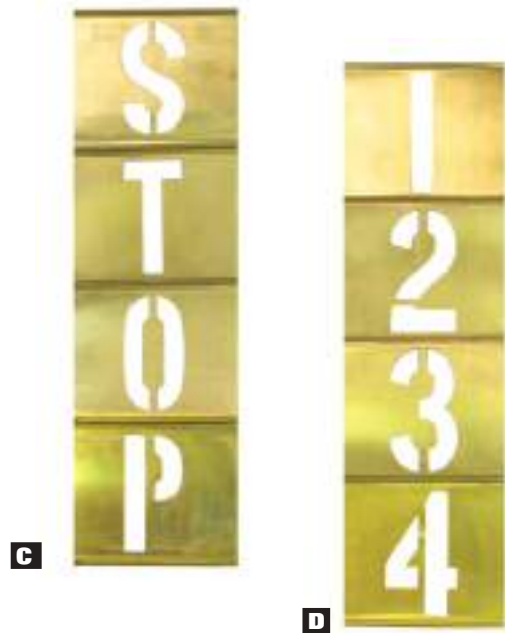

A OVERSIZED LETTER

- Each set contains 33 pieces as follows: All letters (26 pieces A-Z), 1-Beginner, 1-Period Ender, 1-Spacer, 1-Comma, 1-Dash, 1-Period, 1-Ampersand

Item No.	Description	Package
10165	8" Gothic Style Letters	Box
10166	10" Gothic Style Letters	Box
10167	12" Gothic Style Letters	Box

B OVERSIZED NUMBER

- Each set contains 13 pieces as follows: All numbers (10 pieces 0-9), 1-Beginner, 1-Plain Ender, 1-Period

Item No.	Description	Package
10160	8" Gothic Style Numbers	Box
10161	10" Gothic Style Numbers	Box
10162	12" Gothic Style Numbers	Box

C VERTICAL COMPOSITION 33 PIECE SET

- Each set contains 33 pieces as follows: All letters (26 pieces A-Z) 1-Beginner, 1-Period Ender, 1-Spacer, 1-Comma, 1-Dash, 1-Period, 1-Ampersand

Item No.	Description	Package
10178	1" Vert. Composition Letters	Box
10179	2" Vert. Composition Letters	Box
10181	3" Vert. Composition Letters	Box

D VERTICAL COMPOSITION 13 PIECE SET

- Each set contains 13 pieces as follows: All numbers (10 pieces 0-9) 1-Beginner, 1-Plain Ender, 1-Period

Item No.	Description	Package
10175	1" Vert. Composition Numbers	13 pc Box
10176	2" Vert. Composition Numbers	13 pc Box
10177	3" Vert. Composition Numbers	13 pc Box

Custom Brass & Plastic Stencils

- C.H. Hanson can cut virtually any message or design in durable .012" thick brass, 1/16" thick polyethylene (LDPE), 1/8" thick polyethylene (LDPE)
- Create a permanent stencil of your company's name or logo, or any special design you need
- Call for quote on all custom stencils



Interlocking Brass Stencils Accessories



A FIGURE WHEELS - BRASS

- Brass figure wheels make numbering jobs quick & easy
- Gothic figures in style shown, with wood handle for turning and locating
- Other custom made stencils in brass or plastic quoted upon request

Item No.	Description	Package
12311	With 1-1/2" figures	Bulk
12310	With 1" figures	Bulk
12312	With 2" figures	Bulk

B BRISTLE BRUSH

- These varnished wood handle brushes feature a nickel plated steel ferrule to use with ink pot or your own container
- Hog hair bristles
- Compatible with all types of ink

Item No.	Description	Package
12001	No. 4 for 1.5" to 2.5" character	Bag
12002	No. 6 for 3" character	Bag
12003	No. 8 for 4", 5", 6" character	Bag
12004	No.10 for 8", 10", 12" character	Bag
12006	No.14 for 8",10", 12" character	Bag

C FOUNTAIN ROLLERS

- Aluminum construction for long wear and tough applications
- FR100 refillable barrel
- Long-lasting Neoprene roller for fewer replacements

Item No.	Description	Package
12122	FR-150 replacement -1.5"	Box
12121	FR-100 Marsh - 3"	Box
12120	FR-100 Marsh - 1.5"	Box
12123	FR-150 replacement -3"	Box

D FOUNTAIN BRUSH

- Ideal for big stenciling jobs
- Use with both all purpose and porous inks

Item No.	Description	Package
12008	Marsh FB-26 Fountain Brush	Box
12009	Marsh FB-26 Fountain Brush	Box

E STENCIL INKS

Item No.	Description	Package
12164	Black all purpose	Quart
12160	Black all purpose	Gallon



Pencils, Crayons, Markers, and Accessories

A RETRACTABLE PENCIL PULL®

- Self retractable pencil holder
- Holds carpenter pencils, crayons, pens, markers and more
- Easily clips on belt, pocket or shirt
- Stop looking for your pencil, this is one tool you don't think you need until you try it
- Loaded on a clip strip of 12 each per case pack

Item No.	Description	Package
10570	Retractable Pencil Pull® pencil holder	Clip strip

A



B CARPENTER PENCILS

- Perfect for marking fine lines, molding, saw lines, drill points, etc.
- Must be ordered in case pack quantities

Item No.	Description	Package
Case Pack of 72		
10378	Hard Lead	Boxed
10379	Soft Lead	Boxed
10380	Medium Lead	Boxed
10231	Red Lead Carpenter's Pencil	Boxed
10316	Economy Medium Basswood	Boxed
Case Pack of 144 (gross)		
10398	With Hard Lead	Display Box
10399	With Soft Lead	Display Box
10400	With Medium Lead	Display Box
10560_PUR	Sure-Point™ Finish Carpenter's Pencil (Round)	Boxed
10561	Finish Pencil, Red, Lacquered (Round)	Boxed

B



C VERSASHARP

- Sharpens carpenter pencils, lumber crayons, and standard pencils
- Ergonomically designed

Item No.	Description	Package
00202	VersaSharp™ Sharpener-25 count	Display Box
00208	VersaSharp™ Fish Bowl - 25 count	Carded

C



00208



00202



Pencils, Crayons, Markers, and Accessories

A COMBO MARK

- Double-ended marking tool
- For all your construction marking needs
- Combines carpenter pencil with lumber crayon
- Marks wood, concrete, metal, or glass
- 24 each per case pack

Item No.	Description	Package
10456	Combo Mark with yellow lumber crayon	Bulk
10457	Combo Mark with red lumber crayon	Bulk
10458	Combo Mark with blue lumber crayon	Bulk

A



B PENCIL SHARPENER/COMBO

00213	10 Hanson Pencils with 1 VersaSharp	Tube
-------	-------------------------------------	------

• 15 ProSharp™ Pencil Kit contains: 15 of our best selling medium lead round finishing pencils with erasers, ProSharp™ chuckable pencil sharpener and re-usable storage tube
 Case Pack: 02010-9 tubes per case pack, 00206 / 12 each per case pack, 00221 / 12 each per case pack

02010	ProSharp™ with 15 pencils	Tube
00206	Combo 2 Pencils with VersaSharp™	Carded
00221	6 Hanson Pencils with 1 VersaSharp	Carded

B



C PENCIL ARMOR®

- Helps prevent pencil from breaking
- Heavy Duty Pocket Clip
- Case Pack: 10405 - 24 each per case pack / 00118 - 12 each per case pack

Item No.	Description	Package
10405	Pencil Armor®	Display Box
00118	Pencil Armor® and Carp. Pencil	Carded

C



D WOOD LUMBER CRAYON HOLDER

- Securely holds crayon for better control
- Prevents crayon from breaking
- Allows use of full crayon
- 12 each per case pack

Item No.	Description	Package
10387	Wood Lumber Crayon - Holder	Bulk



Pencils, Crayons, Markers, and Accessories

A CRAYON ARMOR

- Securely holds crayon • Prevents crayon from breaking
- Allows use of full crayon
- Case Pack:
10404 - 24 each per case pack / 00125 - 12 each per case pack

Item No.	Description	Package
10404	Crayon Armor® Holder	Display Box
00125	Crayon Armor® Holder and Crayon	Carded

B LUMBER CRAYONS

- Extend working life with Crayon Armor®
- 1/2" hexagon x 4.5" long

Premier - Boxed 12

- Marks lumber, metal, concrete and most other surfaces
- No Melt Crayon withstands 300°F - Weather/fade/sun resistant

Item No.	Description	Package
10382	Red Premier	Boxed
10383	Blue Premier	Boxed
10384	Black Premier	Boxed
10385	Yellow Premier	Boxed

Standard - Boxed 12

- For marking wood, metal, concrete

10365	Red Standard	Boxed
10366	Blue Standard	Boxed
10367	Black Standard	Boxed
10368	Yellow Standard	Boxed
10370	White Standard	Boxed

Standard - 2 pk. Carded

10352	Blue	Carded
10353	Black	Carded
10356	Red	Carded
10386	Yellow	Carded

Standard - 6 pk. Carded

10494	Blue Standard	Carded
10496	Red Standard	Carded
10497	Black Standard	Carded
10498	Yellow Standard	Carded

C CHINA MARKERS

- Marks on china, glass or plastic • Marks on wet surfaces
- Marking pencils for porous and non-porous surfaces
- Easy peel off wrap
- 5/16" diameter x 6-3/4" long

Boxed 12

Item No.	Description	Package
10390	Red China Marker	Boxed
10391	Black China Marker	Boxed
10392	White China Marker	Boxed
10622	Yellow China Marker	Boxed
10623	Green China Marker	Boxed
10625	Blue China Marker	Boxed

Carded - 2 pk.

10260	Black China Marker	Carded
10261	Red China Marker	Carded
10262	White China Marker	Carded
10263	Yellow China Marker	Carded
10264	Green China Marker	Carded
10265	Blue China Marker	Carded



Pencils, Crayons, Markers, and Accessories

A PAINT MARKERS

- Delivers permanent, high visibility mark on all surfaces
- Marks through oily, rusty, greasy films. Resists water, wear, & UV fading
- Marker cap matches color of the paint
- Perfect to use with stencils
- 1/2" diameter x 5.5" long

Carded - 2 each per pack

Item No.	Description	Package
10362	Red Paint Marker	Carded

Boxed 12

10295	Black Paint Markers	Boxed
10297	Red Paint Markers	Boxed
10298	White Paint Markers	Boxed
10299	Yellow Paint Markers	Boxed

A



B RAILROAD CHALK

- For temporary, high visibility marking of surfaces such as metal, wood & concrete
- 7/8" tapered diameter by 4" long
- Smooth chalk formulation for easy glide application

Item No.	Description	Package
10374	White Railroad Chalk/box of 144	Bulk
10393	Blue Railroad Chalk/box of 144	Bulk
10394	Yellow Railroad Chalk/box of 144	Bulk
10401	Red Railroad Chalk/box of 144	Bulk

B

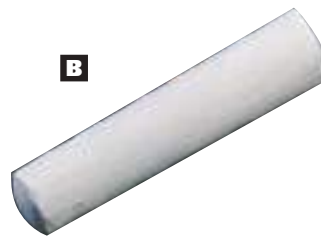

C HALF MOON CAKE CARPENTERS CHALK

- Designed for hand marking of chalk lines
- 2-1/2" diameter hemispherical cakes fit easily in your hand
- 72 pieces per box
- Bold colors

Item No.	Description	Package
10395	White Half Moon Carpenter Chalk	Bulk
10396	Blue Half Moon White Chalk	Bulk
10397	Red Half Moon Carpenter Chalk	Bulk

C





Quick, Secure, One-Handed Spring Clamps

Features:

- Made with high quality forged American steel
- Made in the USA
- Stronger than imports*
- Tang compression spring keeps the clamp jaws in alignment

** 2" Heritage Spring Clamps 30% stronger and
1" Heritage Spring Clamps 20% stronger than imports*



ATTENZIONE! Questo prodotto è destinato all'uso
solo per il taglio di legno. Non utilizzare
per altri scopi. Leggere attentamente il manuale
d'istruzioni. Evitare di usare il prodotto
per tagliare materiali non destinati a questo
scopo. Il taglio di materiali non destinati a questo
scopo può causare danni al prodotto e lesioni
personali.





Heritage Spring Clamps

- Made with high quality forged American steel
- Manufactured in the USA
- Up to 30% stronger than imports
- Tang compression spring keeps the clamp jaws in alignment
- Available in 4 sizes, with and without protective tip

Item #	Description	Package
64011	1" Spring Clamps with Tips	12 pieces
64012	2" Spring Clamps with Tips	12 pieces
64013	3" Spring Clamps with Tips	6 pieces
64014	4" Spring Clamps with Tips	6 pieces
64021	1" Spring Clamps without Tips	12 pieces
64022	2" Spring Clamps without Tips	12 pieces
64023	3" Spring Clamps without Tips	6 pieces
64024	4" Spring Clamps without Tips	6 pieces

Heritage Wood Handscrew Clamps

- Made from quality North American rock maple or birch wood
- Manufactured in the USA for craftsmen everywhere
- 4 each per case pack
- Available in three sizes
- Jaws adjust to any angle for clamping all surfaces

Item #	Description	Package
64001	8" Wood Handscrew Clamp	4 pieces
64002	10" Wood Handscrew Clamp	4 pieces
64003	12" Wood Handscrew Clamp	4 pieces

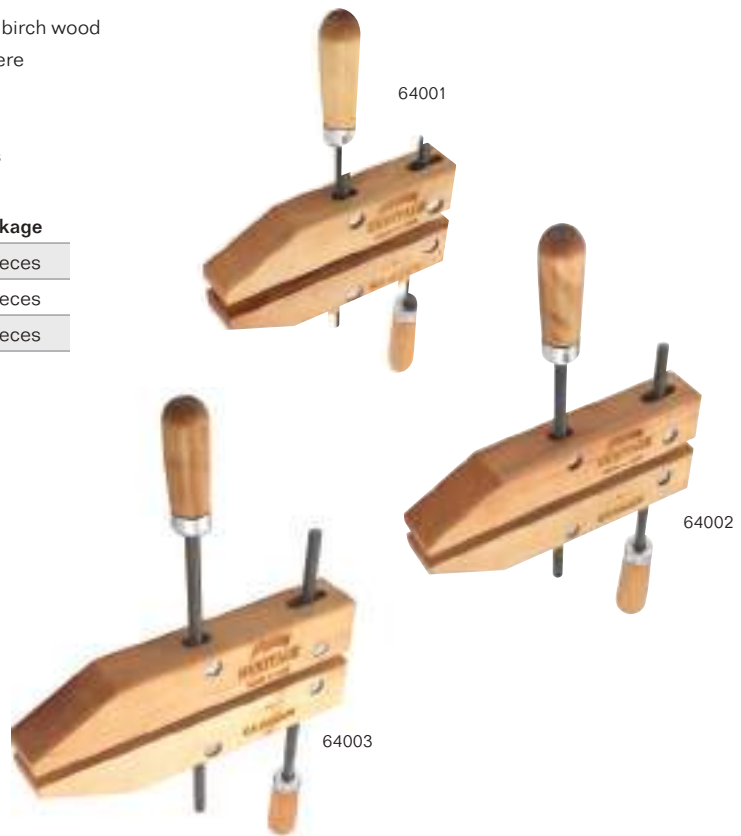

HERITAGE
 CLAMPS





Manual Locking Pliers

- Durable nickel plate finish
- Constructed for quality, strength, and durability
- Limited Lifetime Warranty
- 6 each per case pack

10" Curved Jaw Locking Pliers

Item No.	Jaw Opening	Throat Depth	Jaw Width	Package
71050	2"	1 1/2"	1/2"	Clam Shell

7" Curved Jaw Locking Pliers

Item No.	Jaw Opening	Throat Depth	Jaw Width	Package
70750	1 3/4"	1 1/4"	1/2"	Clam Shell

5" Curved Jaw Locking Pliers

Item No.	Jaw Opening	Throat Depth	Jaw Width	Package
70550	1 1/4"	1 1/4"	3/8"	Clam Shell

10" Straight Jaw Locking Pliers

Item No.	Jaw Opening	Throat Depth	Jaw Width	Package
71000	1 3/4"	1 1/4"	5/8"	Clam Shell

7" Straight Jaw Locking Pliers

Item No.	Jaw Opening	Throat Depth	Jaw Width	Package
70700	1 1/2"	1 1/4"	1/2"	Clam Shell

9" Long Nose Locking Pliers

Item No.	Jaw Opening	Throat Depth	Jaw Width	Package
70950	2 3/4"	2 1/2"	3/8"	Clam Shell

6" Long Nose Locking Pliers

Item No.	Jaw Opening	Throat Depth	Jaw Width	Package
70650	2"	2"	3/8"	Clam Shell



70550



70700



70650

Manual Locking Pliers and Clamps

- Constructed for quality, strength, and durability
- Durable nickel plate finish
- 6 each per case pack
- Limited Lifetime Warranty

11" Locking C-Clamp

Item No.	Jaw Opening	Throat Depth	Jaw Width	Package
71100	3 1/2"	3 1/4"	1/2"	Clam Shell

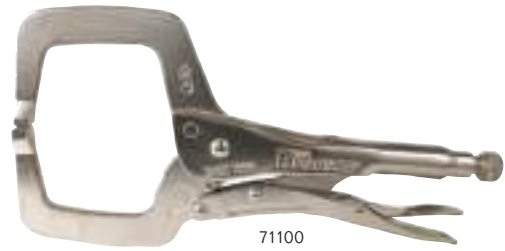

71100

6" Locking C-Clamp

Item No.	Jaw Opening	Throat Depth	Jaw Width	Inside Clearance	Package
70600	2"	1 3/4"	2 3/8"	2 3/8"	Clam Shell



70620

11" Locking C-Clamp with pads

Item No.	Jaw Opening	Throat Depth	Jaw Width	Package
71120	3 1/2"	3 1/4"	1 1/4"	Clam Shell

6" Locking C-Clamp with pads

Item No.	Jaw Opening	Throat Depth	Jaw Width	Inside Clearance	Package
70620	1 3/4"	1 3/4"	3/4"	2 3/8"	Clam Shell



70800

8" Locking Sheet Metal Clamp

Item No.	Jaw Opening	Throat Depth	Jaw Width	Package
70800	1 1/2"	1 3/4"	3"	Clam Shell

9" Locking Welding Clamp

Item No.	Jaw Opening	Throat Depth	Jaw Width	Package
70900	2"	2 1/2"	2 3/4"	Clam Shell



70900

20" Locking Chain Clamp

Item No.	Jaw Opening	Max Pipe Size	Package
72000	20"	5"	Clam Shell

71999	18" Chain to fit Part No 72000	Bagged
-------	--------------------------------	--------



72000

71999

18" Locking C-Clamp • 5 each per case pack

Item No.	Jaw Opening	Throat Depth	Jaw Width	Inside Clearance	Package
71800	8"	10"	1/2"	4"	Carded

18" Locking C-Clamp with pads • 5 each per case pack

Item No.	Jaw Opening	Throat Depth	Jaw Width	Inside Clearance	Package
71825	8"	10"	1 1/4"	4"	Carded



swivel pads



Pre-Cut Stainless Steel Shim Kits



PRE-CUT STAINLESS STEEL FULL SHIM KITS

- Full Shim Kit contains 20 pieces of each thickness
- Pre-packaged and foam protected in sturdy metal toolbox
- Each kit contains the following thicknesses: .001, .002, .003, .004, .005, .010, .015, .020, .025, .050, .075, .100, .125
- A- 2" x 2", Slot width 5/8", Rec. bolt size 1/4"-5/8"
- B- 3" x 3", Slot width 3/4", Rec. bolt size 1/2"-3/4"
- C- 4" x 4", Slot width 1 1/4", Rec. bolt size 3/4"-1 1/4"
- D- 5" x 5", Slot width 1 5/8", Rec. bolt size 1"-1 5/8"

Item No.	Description	Package
A-Ful	A (2" x 2") Full Shim Kit	Box
B-Ful	B (3" x 3") Full Shim Kit	Box
C-Ful	C (4" x 4") Full Shim Kit	Box
D-Ful	D (5" x 5") Full Shim Kit	Box

PRE-CUT STAINLESS STEEL MINI SHIM KITS

- Mini Shim Kit contains 10 pieces of each thickness
- Pre-packaged and foam protected in sturdy metal toolbox
- Each kit contains the following thicknesses: .001, .002, .003, .004, .005, .010, .015, .020, .025, .050, .075, .100, .125

Item No.	Description	Package
A-Mini	A (2" x 2") Mini Shim Kit	Box
B-Mini	B (3" x 3") Mini Shim Kit	Box
C-Mini	C (4" x 4") Mini Shim Kit	Box
D-Mini	D (5" x 5") Mini Shim Kit	Box

PRE-CUT STAINLESS STEEL SHIM PACKS

contains 20 pieces

Item No.	Description	Package
A-001	A (2" x 2") .001" Shim Pk	Box
B-001	B (3" x 3") .001" Shim Pk	Box
C-001	C (4" x 4") .001" Shim Pk	Box
D-001	D (5" x 5") .001" Shim Pk	Box
A-002	A (2" x 2") .002" Shim Pk	Box
B-002	B (3" x 3") .002" Shim Pk	Box
C-002	C (4" x 4") .002" Shim Pk	Box
D-002	D (5" x 5") .002" Shim Pk	Box
A-003	A (2" x 2") .003" Shim Pk	Box
B-003	B (3" x 3") .003" Shim Pk	Box
C-003	C (4" x 4") .003" Shim Pk	Box
D-003	D (5" x 5") .003" Shim Pk	Box
A-004	A (2" x 2") .004" Shim Pk	Box
B-004	B (3" x 3") .004" Shim Pk	Box
C-004	C (4" x 4") .004" Shim Pk	Box
D-004	D (5" x 5") .004" Shim Pk	Box
A-005	A (2" x 2") .005" Shim Pk	Box
B-005	B (3" x 3") .005" Shim Pk	Box
C-005	C (4" x 4") .005" Shim Pk	Box
D-005	D (5" x 5") .005" Shim Pk	Box
A-010	A (2" x 2") .010" Shim Pk	Box
B-010	B (3" x 3") .010" Shim Pk	Box
C-010	C (4" x 4") .010" Shim Pk	Box
D-010	D (5" x 5") .010" Shim Pk	Box
A-015	A (2" x 2") .015" Shim Pk	Box
B-015	B (3" x 3") .015" Shim Pk	Box
C-015	C (4" x 4") .015" Shim Pk	Box
D-015	D (5" x 5") .015" Shim Pk	Box
A-020	A (2" x 2") .020" Shim Pk	Box
B-020	B (3" x 3") .020" Shim Pk	Box
C-020	C (4" x 4") .020" Shim Pk	Box
D-020	D (5" x 5") .020" Shim Pk	Box
A-025	A (2" x 2") .025" Shim Pk	Box
B-025	B (3" x 3") .025" Shim Pk	Box
C-025	C (4" x 4") .025" Shim Pk	Box
D-025	D (5" x 5") .025" Shim Pk	Box
A-050	A (2" x 2") .050" Shim Pk	Box
B-050	B (3" x 3") .050" Shim Pk	Box
C-050	C (4" x 4") .050" Shim Pk	Box
D-050	D (5" x 5") .050" Shim Pk	Box
A-075	A (2" x 2") .075" Shim Pk	Box
B-075	B (3" x 3") .075" Shim Pk	Box
C-075	C (4" x 4") .075" Shim Pk	Box
D-075	D (5" x 5") .075" Shim Pk	Box
A-100	A (2" x 2") .100" Shim Pk	Box
B-100	B (3" x 3") .100" Shim Pk	Box
C-100	C (4" x 4") .100" Shim Pk	Box
D-100	D (5" x 5") .100" Shim Pk	Box
A-125	A (2" x 2") .125" Shim Pk	Box
B-125	B (3" x 3") .125" Shim Pk	Box
C-125	C (4" x 4") .125" Shim Pk	Box
D-125	D (5" x 5") .125" Shim Pk	Box





A **MAGNETIC STUD FINDER™**

- Powerful rare earth magnets locate metal and wood studs
- Rotating level for horizontal and vertical leveling
- No batteries required
- 6 each per case pack
- Ideal for remodeling, new construction, and DIY projects
- Compact design easily fits in your pocket

Item No.	Description	Package
03040	Magnetic Stud Finder™	Carded

B **ANGLE SNAP®**

- Unique layout tool
- Accurately measures and marks sheet goods like plywood and drywall
- Measures in Degrees and Pitches
- Comes with chalk reel
- Easy 1 person marking - two adjustable grip pins anchor tool on desired mark
- Measure angles - use as protractor for finding angles and roof pitches
- 6 each per case pack

Item No.	Description	Package
03070	AngleSnap®	Carded

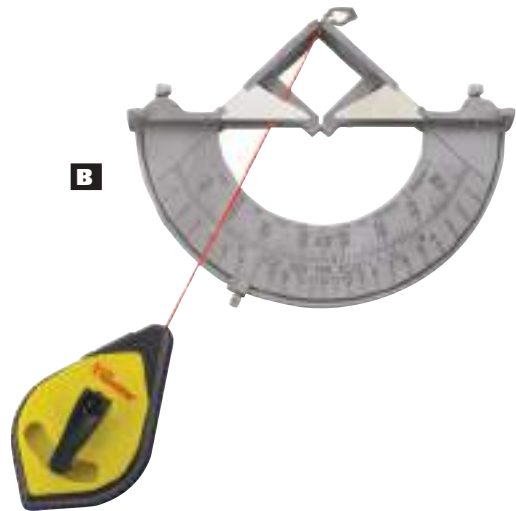

C **MEASURING WHEEL - ANALOG**

- 5 digit magnified counter measures up to 10,000 feet
- Telescoping aluminum handle for easy storage
- Limited lifetime warranty
- Heavy duty wheel with rubber tires
- Pistol grip handle for easy use
- 1 each per pack

Item No.	Description	Package
11246	4" Measuring Wheel	Carded
11249	13" Measuring Wheel	Carded





Squares

A PIVOT SQUARE®

- Precision measurement tool
- Pivots to easily measure or mark any angle
- Locks in angles • Quickly find roof pitch
- Has three vials to determine roof pitches, indicate grade, and allow for leveling and plumbing
- 4 each per case pack

Item No.	Description	Package
03060	Machined Aluminum Pivot Square®	Clam Shell
00203_PUR	Pivot Square® User's Guide	Box
03065	Resin Pivot Square®	Carded

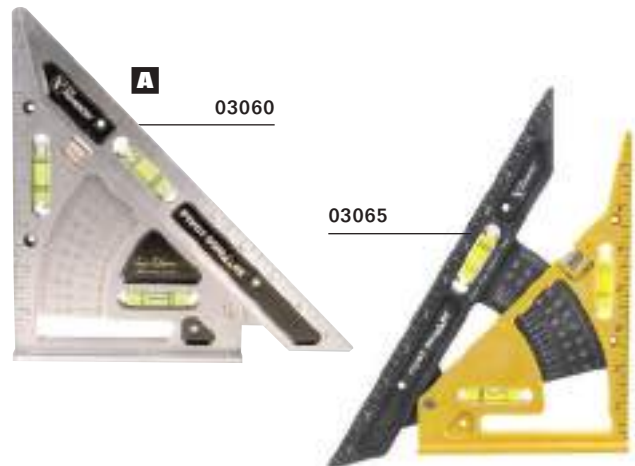

B SLIDE SQUARE®

- This next generation square is the one tool that will easily and accurately solve all your layout needs
- Marks accurate anchor bolt hole locations onto 2" x 4" and 2" x 6" sill plates
- Marks right angles with positive stop at 90°
- Mark common, hip, and valley roof cuts and angles
- Fits in your pocket • 6 each per case pack

Item No.	Description	Package
03050	Slide Square®	Carded





A 3'x4'x5' 90° HEAVY DUTY ALUMINUM FOLDING LAYOUT ASQUARE

- Only true 3' x 4' x 5' square
- Aircraft Aluminum construction
- Collapsing triangle for easy storage
- Easy to use, for quick and accurate work
- Uses: Carpentry, layout, angle layout, squaring, framing timber, masonry, pavers and much more
- Accurate to within 1/32"

Item No.	Description	Package
00345	3'x4'x5' 90° Heavy Duty Alum. Folding Layout Asquare	Tube
34502	3'x4'x5' 90° Heavy Duty Alum. Folding Layout Asquare (3 pack per Tube)	Tube

B 54" 45° HEAVY DUTY ALUMINUM FOLDING LAYOUT ASQUARE

- Provides true 90° angle and two 45° angles in a folding layout square
- Aircraft quality extruded aluminum
- Collapsing triangle slides closed for easy storage
- Precision made, Positive locking, easy to use, more accurate, folds to store
- Great for tile work

Item No.	Description	Package
00045	54" 45° Heavy Duty Alum. Folding Layout Asquare	Tube
45002	54" 45° Heavy Duty Alum. Folding Layout Asquare (3 pack per tube)	Tube



Masonry Line



C MASONRY LINE REELS

- High visibility lines for temporary area marking
- For contractors, carpenters, masons or home use
- For quick, easy unwinding/rewinding
- Reloadable string fits 1" cores 4"- 6" long
- #18 Nylon Construction Line • 12 each per case pack

Item No.	Description	Package
51050	250' Twisted Gold Line & Reel	Cut Case
53200	500' Braided Pink Line & Reel	Cut Case
53500	500' Braided Fl Orange Line & Reel	Cut Case



D MASONRY LINE REFILLS

- High visibility lines for temporary area marking
- Reloadable string fits 1" cores 4"- 6" long
- #18 Nylon Construction Line • 12 each per case pack

Item No.	Description	Package
52050	250' Twisted Gold Line	Cut Case
54200	500' Braided Pink Line	Cut Case



**C.H.
HANSON**[®]
Since 1866 • Tools for Generations™

Barricade Safety Tape

Features:

- Competitive pricing
- Custom legends
- Reinforced tape available for greater strength

CAUTION



Barricade Safety Tapes

- Rolls are individually labeled with UPC code
 - 2" Black characters on 3" wide yellow tape unless indicated.
 - Ask us about other legends and sizes available
 - Boxed packaging
- *Call for availability

- Case Pack:

1,000 ft. length 3 mil - 12 rolls	300 ft. length 2 mil - 16 rolls
1,000 ft. length 2 mil - 12 rolls	200 ft. length 2 mil - 8 rolls
1,000 ft. length 1.5 mil - 15 rolls	3,000 ft. length 2 mil - 4 rolls



1,000 ft. Length			
Legend	3 mil	2 mil	1.5 mil
Attention/Attention	15040	16041	19041
Breathing Air Required In The Area	16200*	16011*	—
Caution	14995	16000	19000
Caution / Cuidado	15036	16002	—
Caution Construction Area	15018	16009	—
Caution Crime Scene	15020	—	—
Caution D N E	15120	—	—
Caution Do Not Enter	15002	16004	19004
Caution Do Not Enter/Cuidado No Se Entre	—	16006*	—
Caution Hazardous Material	15022	—	—
Caution No Parking	15004	—	—
Caution Open Trench	15044	16007	—
Caution Safety Hazard Keep Away	15024	—	—
Caution Symbol	15032	—	—
Caution Wet Paint	15010	16001	—
Cuidado Cuidado	16203	16013	—
Danger (Red)	14998	16003	19005
Danger Do Not Enter (Red)	15041	16005	—
Danger Lead Hazard (Red)	15122*	16012	—
Danger/Peligro (Red)	15129	16554	—
Fire Line Do Not Cross	15034*	—	—
Garage Sale	15008*	—	—
No Legend Yellow Tape	14091	—	—
No Legend Red Tape	15412	—	—
Peligro No Pasar (Red)	15061*	—	—
Peligro Peligro (Red)	15039*	—	—

1,000 ft. Length			
Legend	3 mil	2 mil	1.5 mil
Police Line DNC	15049*	—	—
Police Line Do No Cross	15026	—	—
Restricted Area Keep Out	15121*	—	—
Restricted Area Keep Out	—	16008*	—
Security Line Do Not Cross	15028*	—	—
Utility Line Do Not Cross	15043*	—	—
Warning Restricted Area (Yellow)	15016*	—	—

3,000 ft. Length	
Legend	2 mil
3000' x 3" Yellow CAUTION Tape Jumbo Roll	16091

300 ft. Length (3" wide)	
Legend	2 mil
Caution	16100
Caution / Cuidado	16102
Caution Do Not Enter	16104
Caution Wet Paint	16101
Danger Do Not Enter (Red)	16105
Garage Sale	16110
Danger (Red)	16103
Danger/Peligro (Red)	16653

200 ft. Length	
Legend	2 mil
Caution	14100
Caution Do Not Enter	14101



REINFORCED BARRICADE TAPE - 5 MIL

- Mesh tape for greater strength
- No stretch • 8 rolls per case pack

Item No.	Description	Package
16030	"Caution" Barricade Tape 500 ft.	Boxed
16031	Red Danger Tape 500 ft.	Boxed



EXPANDING YELLOW CAUTION TAPE - 5 MIL

- No stretch • 8 rolls per case pack

Item No.	Description	Package
16092	Expanding Yellow CAUTION Tape 500 ft.	Boxed



Safety Tape

A DISPENSER BOX

- Box dispensed tape
- Easily stands
- Heavy duty 3 mil tape

Item No.	Description	Package
14090	3 MIL 1000 ft. roll Caution	Boxed
15140	3 MIL 1000 ft. roll Caution-Do Not Enter	Boxed
15142	3 MIL 1000 ft. roll Danger (Red)	Boxed
16090	2 MIL 1000 ft. roll Caution with dispenser	Boxed



Flagging Tapes

B FLAGGING TAPES

- Superior visibility when laying out boundaries
- 12 rolls per case pack
- Economical and Reusable
- Fluorescent colors are all 150 feet long

1-3/16" WIDE - 4 MIL

Model	Description	Package
17000	Orange Fluorescent	Box
17001	Lime Fluorescent	Box
17002	Red Fluorescent	Box
17003	Pink Fluorescent	Box
17004	Green Fluorescent	Box
17005	Yellow Fluorescent	Box
17055	Pink Flo/Black Stripe	Box
17056	Orange Flo/Black Stripe	Box

ECONOMY - 1" WIDE - 4 MIL

17000-1	Orange Fluorescent	Box
17001-1	Lime Fluorescent	Box
17002-1	Red Fluorescent	Box
17003-1	Pink Fluorescent	Box
17004-1	Green Fluorescent	Box
17005-1	Yellow Fluorescent	Box

C FLAGGING TAPES - STRIPES AND DOTS

- Visual colorization for differentiation
- Excellent visibility when laying out boundaries
- 1-3/16" wide 2 MIL Economical and Reusable
- Standard colors are 300 feet • 12 rolls per case pack

Model	Description	Package
17025	Standard Red/White Stripes	Box
17057	Standard Red/Black Stripes	Box
17060	Standard Yellow/Black Stripes	Box
17061	Standard Yellow/White Stripes	Box
17063	Standard Orange/White Stripes	Box
17064	Standard Blue/Black Stripes	Box
17065	Standard Blue/White Stripes	Box
17066	Standard White with Blue Dots	Box
17067	Standard White with Red Dots	Box
17068	Standard White with Orange Dots	Box

B



C



D



D FLAGGING TAPES - STANDARD COLORS

- Excellent visibility when laying out boundaries
- 1-3/16" wide 2 MIL Economical and Reusable
- Standard colors are 300 feet • 12 rolls per case pack

Model	Description	Package
17020	Standard White	Box
17021	Standard Red	Box
17022	Standard Orange	Box
17023	Standard Blue	Box
17024	Standard Yellow	Box
17026	Standard Green	Box
17027	Standard Black	Box
17028	Standard Pink	Box



Sub-Zero™ Flagging Tape

- Maximum durability in harsh weather conditions
- Rated to -40° F
- Contains UV Protection
- True 5 mil thickness throughout entire roll
- 1-3/16" wide x 150', Fluorescent colors
- 12 rolls per case pack

Model	Description	Display Box
17006	150' 5MIL Sub-Zero Fluorescent Pink	12
17007	150' 5MIL Sub-Zero Fluorescent Orange	12
17008	150' 5MIL Sub-Zero Fluorescent Blue	12
17009	150' 5MIL Sub-Zero Fluorescent Lime	12
17010	150' 5MIL Sub-Zero Fluorescent Red	12
17011	150' 5MIL Sub-Zero Fluorescent White	12
17012	150' 5MIL Sub-Zero Fluorescent Yellow	12
17013	150' 5MIL Sub-Zero Fluorescent Dark Green	12
17014	150' 5MIL Sub-Zero Fluorescent Purple	12



Aisle Marking and Safety Tape

A REFLECTIVE SAFETY TAPE

- Meets NHTSA Conspicuity Regulations
- Easy to apply strip
- Place on trailer sides, bottom of rear door, and ICC bar
- 1 per package
- 6 each per case pack

Model	Description	Package
55301	2" X 24" Reflective Safety Tape White	Carded
55302	2" X 24" Reflective Safety Tape Red	Carded
55303	2" X 24" Reflective Stripes Black/Yellow	Carded
55304	2" X 24" Reflective Stripes Red/White	Carded
55305	2" X 24" D.O.T. Reflective Stripes Red/Silver	Carded



B AISLE MARKING

- 2" x 54' roll, or otherwise noted
- Highly visible stripes for identifying high traffic areas on floor
- 6 rolls per case pack

Item No.	Description	Package
15045	Black/on Yellow	Boxed



B



Stake Flags

APWA UNIFORM COLOR CODE FOR MARKING UNDERGROUND UTILITIES

Color	Utility
WHITE	Proposed Excavation
PINK	Temporary Survey Markings
RED	Electrical Power Lines, Cables, Conduit and Lighting Cables
YELLOW	Gas, Oil, Steam, Petroleum or Gaseous Materials
ORANGE	Communication, Alarm or Signal Lines, Cables or Conduit
BLUE	Potable Water
LIME	Sewer and Drain Lines



A BULK WIRE STAFF, 2-1/2" X 3-1/2"

- Bundles of 100 flags
- For surveying, construction, agriculture, and more
- Mark location of underground utilities
- Ask us about custom printing

Item No.	Description	Package
15079	21" - Orange Flo Marking Flag	Bundle
15080	21" - Red Flo Marking Flag	Bundle
15081	21" - Pink Flo Marking Flag	Bundle
15082	21" - Lime Flo Marking Flag	Bundle
15084	21" - Yellow Marking Flag	Bundle
15085	21" - Blue Marking Flag	Bundle
15086	21" - White Marking Flag	Bundle
15101	21" - Std. Orange Marking Flag	Bundle
15103	21" - Std. Red Marking Flag	Bundle

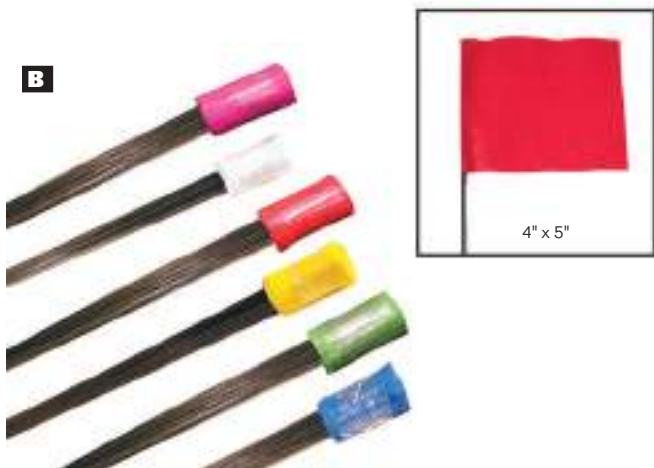

B BULK WIRE STAFF, 4" X 5"

- Oversized flag for added visibility
- Bundles of 100
- For surveying, construction and agriculture
- Mark location of underground utilities
- 100 Flags per bundle
- Ask us about custom printing

Item No.	Description	Package
15073	21" - Yellow Marking Flag	Bundle
15074	21" - Blue Marking Flag	Bundle
15090	21" - Orange Flo Marking Flag	Bundle
15091	21" - Pink Flo Marking Flag	Bundle
15281	21" - Red Flo Marking Flag	Bundle
15282	21" - White Marking Flag	Bundle
15283	21" - Lime Flo Marking Flag	Bundle
15055	30" - Flo Pink Marking Flag	Bundle
15088	30" - Orange Flo Marking Flag	Bundle
15094	36" - Orange Flo Marking Flag	Bundle





Stake Flags

C 10 PACK - WIRE STAFF

- 2-1/2" x 3-1/2", bundles of 10
- For surveying, construction, agriculture, and more
- Mark location of underground utilities
- Ideal for Retail hangable packaging

Item No.	Description	Package
15065	10 ea.- 15" - Red Flo Marking Flags	Carded
15066	10 ea.- 15" - Pink Flo Marking Flags	Carded
15067	10 ea.- 15" - Lime Flo Marking Flags	Carded
15068	10 ea.- 15" - Blue Marking Flags	Carded
15275	10 ea.- 15" - Glo Orange Marking Flags	Carded
15180	10 ea.- 15" - White Marking Flags	Carded
15181	10 ea.- 15" - Yellow Marking Flags	Carded



Safety

A SAFETY VESTS

- Soft mesh vest
- One size fits all
- Reflective stripe
- 10 each per case pack

Item No.	Description	Package
55100	Orange glo vest, soft mesh	Carded
55125	Orange glo vest, soft mesh with reflective stripe	Carded
55150	Premium vest, wider reflective stripes	Carded
55110	Lime green vest, soft mesh	Carded
55120	Premium Lime green vest, wider reflective strips and heaviest mesh	Carded
55115	Lime green vest, with red reflective stripes	Carded



B ANSI CL2 SAFETY VESTS

- ANSI Class 2 safety vests
- 10 each per case pack
- 100% Polyester open weave mesh
- Adjustable sides: each side has a 1" x 3" Velcro strips for easy adjustment, maximum width 56"
- 2" wide silver reflective material stripe
- Side pocket for phone, pens, or tools

Item No.	Description	Package
55180	ANSI Class 2 Lime Safety Vest	Carded



C TRAFFIC FLAGS

- High visibility traffic control flags
- 10 each per case pack

Item No.	Description	Package
55200	Mesh traffic flag with 27" handle	Box
55300	Nylon traffic flag with handle	Box



D RED WARNING FLAGS FOR LUMBER

- High visibility warning flags
- Easily stapled to lumber
- Perfect for oversize vehicle loads
- 300 flags per roll
- 5 rolls per case pack

Item No.	Description	Package
10490	12" x 12" Red Lumber Flags	Roll
10495	16" x 16" Red Lumber Flags	Roll



E STOP/SLOW PADDLES

- 18" Stop/Slow traffic control sign
- High impact plastic handle for 60" model
- Crossing guard 10" wood handle

Item No.	Description	Package
55400	Stop / Slow Sign - 60" plastic pole	Box
55450	Stop / Slow Sign - 10" wood handle	Box



F HIGHWAY WARNING KIT

- Highway Warning kit contains three 17" triangles
- Packed in a handy carrying case
- Color scheme includes fluorescent orange for high visibility during the day, and an outer red reflective border for night use

Item No.	Description	Package
55600	Highway Warning kit	Box



ITEM	PAGE
00045 - 10076	
00045.....	53
00118.....	41
00125.....	42
00202.....	40
00203.....	52
00206.....	41
00208.....	40
00213.....	41
00221.....	41
00345.....	53
02010.....	41
03040.....	51
03050.....	52
03060.....	52
03065.....	52
03070.....	51
10006.....	36
10006_.....	35
10007.....	36
10007_.....	35
10008.....	36
10008_.....	35
10009.....	36
10009_.....	35
10011.....	36
10011_.....	35
10012.....	36
10012_.....	35
10013.....	36
10013_.....	35
10014.....	36
10014_.....	35
10015.....	36
10015_.....	35
10016.....	36
10016_.....	35
10026.....	36
10027.....	36
10028.....	36
10029.....	36
10031.....	36
10032.....	36
10033.....	36
10034.....	36
10035.....	36
10036.....	36
10066.....	36
10067.....	36
10068.....	36
10069.....	36
10071.....	36

ITEM	PAGE
10072.....	36
10073.....	36
10074.....	36
10075.....	36
10076.....	36
10106 - 10405	
10106.....	37
10107.....	37
10108.....	37
10109.....	37
10111.....	37
10112.....	37
10113.....	37
10114.....	37
10115.....	37
10116.....	37
10146.....	37
10147.....	37
10148.....	37
10149.....	37
10151.....	37
10152.....	37
10153.....	37
10154.....	37
10155.....	37
10156.....	37
10160.....	38
10160_.....	35
10161.....	38
10161_.....	35
10162.....	38
10162_.....	35
10165.....	38
10166.....	38
10167.....	38
10175.....	38
10175_.....	35
10176.....	38
10176_.....	35
10177.....	38
10177_.....	35
10178.....	38
10179.....	38
10181.....	38
10187.....	34
10188.....	34
10189.....	34
10190.....	34
10191.....	34
10192.....	34
10193.....	34
10194.....	34

ITEM	PAGE
10195.....	34
10198.....	34
10231.....	40
10260.....	42
10261.....	42
10262.....	42
10263.....	42
10264.....	42
10265.....	42
10295.....	43
10297.....	43
10298.....	43
10299.....	43
10303.....	37
10305.....	37
10307.....	37
10316.....	40
10323.....	37
10325.....	37
10327.....	37
10352.....	42
10353.....	42
10356.....	42
10362.....	43
10365.....	42
10366.....	42
10367.....	42
10368.....	42
10370.....	42
10374.....	43
10378.....	40
10379.....	40
10380.....	40
10382.....	42
10383.....	42
10384.....	42
10385.....	42
10386.....	42
10387.....	41
10390.....	42
10391.....	42
10391.....	42
10393.....	43
10394.....	43
10395.....	43
10396.....	43
10397.....	43
10398.....	40
10399.....	40
10400.....	40
10401.....	43
10404.....	42
10405.....	41

ITEM PAGE

10456 - 11249

10456.....	41
10457.....	41
10458.....	41
10490.....	61
10494.....	42
10495.....	61
10496.....	42
10497.....	42
10498.....	42
10560.....	40
10561.....	40
10570.....	40
10622.....	42
10623.....	42
10625.....	42
11246.....	51
11249.....	51

12001 - 14998

12001.....	39
12002.....	39
12003.....	39
12004.....	39
12006.....	39
12008.....	39
12009.....	39
12120.....	39
12121.....	39
12122.....	39
12123.....	39
12160.....	39
12164.....	39
12310.....	39
12311.....	39
12312.....	39
12400.....	34
12401.....	34
12402.....	34
12403.....	34
12404.....	34
12405.....	34
12406.....	34
12407.....	34
12408.....	34
12409.....	34
12410.....	34
12411.....	34
12412.....	34
12413.....	34
12414.....	34
12415.....	34
12416.....	34

ITEM PAGE

12417.....	34
12418.....	34
12419.....	34
12420.....	34
12421.....	34
12430.....	34
12431.....	34
12432.....	34
12433.....	34
12434.....	34
12435.....	34
12436.....	34
12437.....	34
12438.....	34
12439.....	34
12441.....	34
12460.....	34
14090.....	57
14091.....	56
14100.....	56
14101.....	56
14995.....	56
14998.....	56

15002 - 15412

15002.....	56
15004.....	56
15008.....	56
15010.....	56
15016.....	56
15018.....	56
15020.....	56
15022.....	56
15024.....	56
15026.....	56
15028.....	56
15032.....	56
15034.....	56
15036.....	56
15039.....	56
15040.....	56
15041.....	56
15043.....	56
15044.....	56
15045.....	58
15049.....	56
15055.....	59
15061.....	56
15065.....	60
15066.....	60
15067.....	60
15068.....	60
15073.....	59
15074.....	59

ITEM PAGE

15079.....	59
15080.....	59
15081.....	59
15082.....	59
15084.....	59
15085.....	59
15086.....	59
15088.....	59
15090.....	59
15091.....	59
15094.....	59
15101.....	59
15103.....	59
15120.....	56
15121.....	56
15122.....	56
15129.....	56
15140.....	57
15142.....	57
15180.....	60
15181.....	60
15275.....	60
15281.....	59
15282.....	59
15283.....	59
15412.....	56

16000 - 16203

16000.....	56
16001.....	56
16002.....	56
16003.....	56
16004.....	56
16005.....	56
16006.....	56
16007.....	56
16008.....	56
16009.....	56
16011.....	56
16012.....	56
16013.....	56
16030.....	56
16031.....	56
16041.....	56
16090.....	57
16092.....	56
16100.....	56
16101.....	56
16102.....	56
16103.....	56
16104.....	56
16105.....	56
16110.....	56
16203.....	56

ITEM	PAGE
16554 - 19041	
16554.....	56
16653.....	56
17000.....	57
17000-1.....	57
17001.....	57
17001-1.....	57
17002.....	57
17002-1.....	57
17003.....	57
17003-1.....	57
17004.....	57
17004-1.....	57
17005.....	57
17005-1.....	57
17006.....	58
17007.....	58
17008.....	58
17009.....	58
17010.....	58
17011.....	58
17012.....	58
17013.....	58
17014.....	58
17020.....	57
17021.....	57
17022.....	57
17023.....	57
17024.....	57
17025.....	57
17026.....	57
17027.....	57
17028.....	57
17055.....	57
17056.....	57
17057.....	57
17060.....	57
17061.....	57
17063.....	57
17064.....	57
17065.....	57
17066.....	57
17067.....	57
17068.....	57
19000.....	56
19004.....	56
19005.....	56
19041.....	56
20000 - 20951	
20000.....	8
20005.....	9
20010.....	11

ITEM	PAGE
20012.....	11
20014.....	10
20100.....	24
20100.....	26
20150.....	24, 26
20200.....	24, 26
20220.....	24
20250.....	24, 26
20260.....	24
20270.....	24
20300.....	24, 26
20350.....	26
20360.....	24
20400.....	24, 26
20501.....	24
20521.....	24
20541.....	24
20561.....	24
20581.....	24
20601.....	24
20621.....	24
20622.....	24
20623.....	24
20624.....	24
20625.....	24
20626.....	24
20628.....	24
20741.....	24, 26
20751.....	24, 26
20801.....	24, 26
20851.....	24, 26
20901.....	24, 26
20951.....	24, 26
21051 - 21880	
21051.....	24, 26
21080.....	25
21081.....	25
21082.....	25
21083.....	25
21084.....	25
21085.....	25
21086.....	25
21087.....	25
21088.....	25
21089.....	25
21101.....	26
21151.....	26
21201.....	24, 26
21251.....	24, 26
21252.....	24, 26
21253.....	24
21301.....	24

ITEM	PAGE
21320.....	24
21340.....	24
21360.....	24
21380.....	24
21400.....	24
21460.....	24
21480.....	24
21500.....	24
21520.....	24
21622.....	24
21623.....	24
21624.....	24
21625.....	24
21626.....	24
21627.....	24
21628.....	24
21629.....	24
21630.....	24
21631.....	24
21632.....	24
21633.....	24
21634.....	24
21730.....	24
21730.....	26
21750.....	24
21750.....	26
21760.....	26
21770.....	24, 26
21830.....	24
21850.....	24
21870.....	24
21880.....	24
22000 - 22901	
22000.....	24, 26
22050.....	24, 26
22100.....	24, 26
22150.....	24, 26
22200.....	24, 26
22250.....	24, 26
22350.....	26
22400.....	26
22450.....	24, 26
22550.....	24
22550.....	26
22600.....	24, 26
22750.....	24, 26
22801.....	24
22821.....	24
22841.....	24
22861.....	24
22881.....	24
22901.....	24

ITEM	PAGE
22941 - 24012	
22941.....	24
22961.....	24
22981.....	24
23021.....	24
23041.....	24
24001.....	24
24002.....	24
24003.....	24
24004.....	24
24005.....	24
24006.....	24
24007.....	24
24008.....	24
24009.....	24
24011.....	24
24012.....	24
25000 - 25950	
25000.....	25,26
25050.....	25,26
25100.....	25,26
25150.....	25,26
25200.....	25,26
25250.....	25,26
25300.....	25,26
25350.....	25,26
25400.....	25,26
25450.....	25,26
25501.....	25
25521.....	25
25541.....	25
25561.....	25
25581.....	25
25601.....	25
25621.....	25
25641.....	25
25661.....	25
25681.....	25
25682.....	25
25683.....	25
25684.....	25
25685.....	25
25686.....	25
25687.....	25
25688.....	25
25689.....	25
25690.....	25
25691.....	25
25700.....	25,26
25750.....	25,26
25800.....	25,26
25850.....	25

ITEM	PAGE
25850.....	26
25900.....	25,26
25950.....	25,26
26000 - 26993	
26000.....	25,26
26061.....	25
26081.....	25
26101.....	25
26121.....	25
26141.....	25
26161.....	25
26181.....	25
26183.....	25
26184.....	25
26185.....	25
26187.....	25
26188.....	25
26189.....	25
26190.....	25
26200.....	25,26
26250.....	25,26
26300.....	26
26300.....	25,26
26350.....	25,26
26400.....	25,26
26601.....	25
26621.....	25
26641.....	25
26661.....	25
26681.....	25
26685.....	25
26687.....	25
26688.....	25
26990.....	27
26991.....	27
26992.....	27
26993.....	27
27600 - 2799PN	
27600.....	29
27601.....	29
27604.....	29
27605.....	29
27608.....	29
27609.....	29
27610.....	29
27611.....	29
27612.....	29
27613.....	29
27620.....	29
27621.....	29
27624.....	29
27630.....	28

ITEM	PAGE
27630.....	28
27630BL.....	28
27631.....	28
27632.....	28
27632.....	28
27632BL.....	28
27633.....	28
27634.....	28
27634.....	28
27634BL.....	28
27635.....	28
27636.....	28
27636.....	28
27636BL.....	28
27637.....	28
27638.....	28
27638.....	28
27638BL.....	28
27639.....	28
27640.....	28
27640.....	28
27640BL.....	28
27641.....	28
27770.....	29
27771.....	29
27774.....	29
27775.....	29
27778.....	29
27779.....	29
27782.....	29
27783.....	29
27905.....	21
27905A.....	21
27905B.....	21
27906.....	21
27906B.....	21
27911.....	21
27913.....	21
27915.....	21
27916.....	21
27917.....	21
27918.....	21
2799GN.....	21
2799PN.....	21
28060 - 29175	
28060.....	27
28061.....	27
28062.....	27
28063.....	27
28065.....	27
29100.....	26
29150.....	26
29175.....	26

ITEM	PAGE
29200 - 29375	
29200.....	26
29250.....	26
29275.....	26
29300.....	26
29350.....	26
29375.....	26
34502	
34502.....	53
40001 - 40098	
40001.....	19
40002.....	19
40003.....	19
40004.....	19
40005.....	19
40006.....	19
40007.....	19
40008.....	19
40009.....	19
40010.....	19
40011.....	19
40012.....	19
40013.....	19
40014.....	19
40015.....	19
40016.....	19
40017.....	19
40018.....	19
40019.....	19
40020.....	19
40021.....	19
40022.....	19
40023.....	19
40024.....	19
40025.....	19
40026.....	19
40027.....	19
40028.....	19
40029.....	19
40030.....	19
40031.....	19
40032.....	19
40033.....	19
40034.....	19
40035.....	19
40036.....	19
40037.....	19
40038.....	19
40039.....	19
40040.....	19
40080.....	20

ITEM	PAGE
40081.....	20
40082.....	20
40083.....	20
40084.....	20
40085.....	20
40087.....	20
40096.....	20
40097.....	20
40098.....	20
41000 - 41846	
41000.....	20
41001.....	20
41002.....	20
41136.....	18
41137.....	18
41138.....	18
41151.....	18
41152.....	18
41153.....	18
41154.....	18
41176.....	18
41177.....	18
41178.....	18
41186.....	18
41187.....	18
41188.....	18
41196.....	18
41197.....	18
41198.....	18
41421.....	16
41422.....	16
41423.....	16
41431.....	16
41432.....	16
41433.....	16
41451.....	16
41452.....	16
41453.....	16
41461.....	16
41462.....	16
41463.....	16
41221.....	17
41222.....	17
41223.....	17
41241.....	17
41242.....	17
41243.....	17
41250.....	15
41251.....	17
41252.....	17
41253.....	17
41260.....	15

ITEM	PAGE
41261.....	15
41262.....	15
41271.....	17
41272.....	17
41273.....	17
41281.....	17
41282.....	17
41283.....	17
41291.....	17
41292.....	17
41293.....	17
41316.....	17
41317.....	17
41318.....	17
41331.....	18
41332.....	18
41333.....	18
41376.....	14
41377.....	14
41378.....	14
41386.....	14
41387.....	14
41388.....	14
41482.....	15
41483.....	15
41516.....	15
41517.....	15
41518.....	15
41526.....	15
41527.....	15
41528.....	15
41531.....	15
41532.....	15
41533.....	15
41696.....	14
41697.....	14
41698.....	14
41741.....	14
41742.....	14
41743.....	14
41771.....	14
41772.....	14
41773.....	14
41821.....	13
41822.....	13
41823.....	13
41831.....	13
41832.....	13
41833.....	13
41841.....	13
41842.....	13
41843.....	13
41846.....	13

ITEM PAGE
41847 - 42532

41847..... 13
41848..... 13
41849..... 13
41857..... 13
41858..... 13
41881..... 13
41882..... 13
41883..... 13
41901..... 21
41911..... 21
41914..... 21
41917..... 21
41920..... 21
41924..... 21
41930..... 21
41939..... 21
41942..... 21
41945..... 21
41951..... 21
41956..... 21
42387..... 14
42492..... 15
42527..... 15
42532..... 15

43001 - 43160

43001..... 13
43003..... 16
43004..... 17
43005..... 13
43006..... 13
43007..... 13
43008..... 13
43009..... 13
43010..... 13
43011..... 13
43012..... 13
43013..... 13
43014..... 13
43015..... 13
43016..... 13
43017..... 13
43018..... 13
43019..... 13
43020..... 16
43021..... 16
43022..... 16
43023..... 16
43024..... 16
43025..... 16
43026..... 16
43027..... 16

ITEM PAGE
43028..... 16
43029..... 16
43030..... 16
43031..... 16
43032..... 16
43033..... 16
43034..... 16
43035..... 17
43036..... 17
43037..... 17
43039..... 17
43040..... 17
43041..... 17
43042..... 17
43043..... 17
43044..... 17
43045..... 17
43046..... 17
43047..... 17
43048..... 17
43049..... 17
43050..... 17
43051..... 17
43052..... 17
43053..... 17
43054..... 17
43068..... 17
43077..... 13
43079..... 16
43080..... 17
43081..... 13
43082..... 13
43083..... 13
43084..... 13
43085..... 13
43086..... 13
43087..... 16
43088..... 16
43089..... 16
43090..... 16
43091..... 16
43092..... 16
43093..... 17
43094..... 17
43095..... 17
43096..... 17
43098..... 17
43099..... 17
43100..... 17
43101..... 17
43102..... 13
43104..... 16
43105..... 17

ITEM PAGE
43106..... 18
43107..... 18
43108..... 18
43109..... 18
43110..... 17
43111..... 17
43112..... 17
43113..... 17
43114..... 17
43115..... 17
43116..... 17
43119..... 18
43120..... 14
43121..... 14
43122..... 13
43123..... 13
43124..... 13
43125..... 13
43126..... 13
43127..... 14
43128..... 14
43130..... 15
43131..... 15
43132..... 15
43133..... 15
43134..... 16
43135..... 16
43136..... 16
43137..... 16
43138..... 13
43139..... 13
43140..... 13
43141..... 13
43141..... 13
43142..... 13
43143..... 13
43144..... 13
43145..... 13
43146..... 13
43147..... 13
43148..... 13
43149..... 14
43150..... 14
43151..... 14
43152..... 14
43153..... 14
43154..... 14
43155..... 14
43156..... 16
43157..... 16
43158..... 16
43159..... 16
43160..... 18

ITEM	PAGE
43161 - 43184	
43161.....	18
43162.....	18
43163.....	18
43164.....	18
43165.....	18
43166.....	18
43167.....	17
43168.....	17
43169.....	17
43170.....	17
43171.....	18
43172.....	18
43173.....	18
43174.....	18
43175.....	18
43176.....	18
43177.....	18
43178.....	18
43179.....	18
43180.....	18
43181.....	18
43182.....	18
43183.....	18
43184.....	18
43406 - 45002	
43406.....	13
43406.....	13
43407.....	13
43408.....	13
43409.....	16
43410.....	16
43411.....	17
43412.....	17
43413.....	17
43414.....	17
43415.....	17
43416.....	17
43417.....	17
43418.....	17
43419.....	17
43420.....	19
43421.....	19
43422.....	19
43423.....	19
43424.....	19
43425.....	19
43426.....	19
43427.....	19
43428.....	19
43429.....	19
43430.....	19

ITEM	PAGE
43431.....	19
43432.....	19
43433.....	19
43434.....	19
43435.....	19
43436.....	19
43437.....	19
43438.....	19
43439.....	19
43440.....	19
43441.....	19
43442.....	19
43443.....	19
43444.....	19
43445.....	19
43446.....	19
43447.....	19
43448.....	19
43449.....	19
43450.....	19
43451.....	19
43452.....	19
43453.....	19
43454.....	19
43455.....	19
43456.....	19
43457.....	19
43458.....	19
43459.....	19
43460.....	19
43461.....	19
43462.....	19
43463.....	19
43464.....	19
43465.....	19
43466.....	19
43467.....	19
43468.....	13
43469.....	13
43470.....	13
43471.....	13
43472.....	13
43473.....	13
45002.....	53
50002 - 55600	
50002.....	27
50003.....	27
50004.....	27
50005.....	27
51050.....	53
52050.....	53
53200.....	53

ITEM	PAGE
53500.....	53
54200.....	53
55100.....	61
55110.....	61
55115.....	61
55120.....	61
55125.....	61
55150.....	61
55175.....	61
55180.....	61
55200.....	61
55300.....	61
55301.....	58
55302.....	58
55303.....	58
55304.....	58
55305.....	58
55400.....	61
55450.....	61
55600.....	61
64001 - 70080	
64001.....	47
64002.....	47
64003.....	47
64011.....	46
64012.....	46
64013.....	46
64014.....	46
64021.....	46
64022.....	46
64023.....	46
64024.....	46
69999.....	31
70000.....	31
70001.....	31
70002.....	31
70003.....	31
70004.....	31
70029.....	31
70030.....	31
70031.....	31
70032.....	31
70040.....	31
70041.....	31
70050.....	31
70051.....	31
70060.....	31
70061.....	31
70062.....	31
70063.....	31
70064.....	31
70080.....	31

ITEM PAGE

70081 - 7200

70081..... 31
70092..... 32
70093..... 32
70103..... 32
70140..... 31
70141..... 31
70160..... 32
70161..... 32
70270..... 32
70271..... 32
70292..... 32
70293..... 32
70330..... 32
70331..... 32
70340..... 30
70341..... 30
70342..... 30
70343..... 30
70350..... 33
70351..... 33
70352..... 33
70353..... 33
70354..... 33
70355..... 33
70356..... 33
70357..... 33
70358..... 33
70380..... 33
70382..... 33
70385..... 33
70387..... 33
70388..... 33
70410..... 33
70411..... 33
70412..... 33
70413..... 33
70414..... 33
70415..... 33
70416..... 33
70417..... 33
70418..... 33
70440..... 33
70441..... 33
70443..... 33
70445..... 33
70448..... 33
70470..... 32
70471..... 32
70472..... 32
70480..... 32
70481..... 32
70491..... 32

70550..... 48
70600..... 49
70620..... 49
70650..... 48
70700..... 48
70750..... 48
70800..... 49
70802..... 33
70802..... 33
70803..... 33
70803..... 33
70804..... 33
70804..... 33
70805..... 33
70805..... 33
70806..... 33
70806..... 33
70900..... 49
70950..... 48
71000..... 48
71050..... 48
71100..... 49
71120..... 49
71800..... 49
71825..... 49
72000..... 49

97443

97443..... 20

A

A-001..... 50
A-002..... 50
A-003..... 50
A-004..... 50
A-005..... 50
A-010..... 50
A-015..... 50
A-020..... 50
A-025..... 50
A-050..... 50
A-075..... 50
A-100..... 50
A-125..... 50
A-FUL..... 50
A-Mini..... 50

B

B-001..... 50
B-002..... 50
B-003..... 50
B-004..... 50
B-005..... 50
B-010..... 50
B-015..... 50
B-020..... 50

B-025..... 50
B-050..... 50
B-075..... 50
B-100..... 50
B-125..... 50
B-FUL..... 50
B-Mini..... 50

C

C-001..... 50
C-002..... 50
C-003..... 50
C-004..... 50
C-005..... 50
C-010..... 50
C-015..... 50
C-020..... 50
C-025..... 50
C-050..... 50
C-075..... 50
C-100..... 50
C-125..... 50
C-FUL..... 50
C-Mini..... 50

D

D-001..... 50
D-002..... 50
D-003..... 50
D-004..... 50
D-005..... 50
D-010..... 50
D-015..... 50
D-020..... 50
D-025..... 50
D-050..... 50
D-075..... 50
D-100..... 50
D-125..... 50
D-FUL..... 50
D-Mini..... 50

X

X1291A..... 20

TERMS AND CONDITIONS



NOTE:

All items are available from our Midwest Warehouse, in Naperville, IL. Custom made items will be made and shipped from Naperville, IL.

**2000 N. Aurora Road
Naperville, IL 60563**

**Unable to locate an item?
Call or e-mail us for a quote.**

**p: 800-827-3398
f: 800-827-5834
sales@chanson.com**

PRODUCT RETURN POLICY

(see detailed policy below)

Return Requests must be approved by C.H. Hanson with an RGA number and sent prepaid. These returns will be subject to an inspection (for original condition) and assessed a restocking fee. All shortages must be reported within 30 days. No returns will be accepted after 45 days from the date of shipment by C.H. Hanson. Custom made items cannot be returned.

DISCLAIMER OF IMPLIED WARRANTIES AND LIMITATIONS ON CONSEQUENTIAL DAMAGES. THERE IS NO IMPLIED WARRANTY OF MERCHANTABILITY OR FITNESS WITH RESPECT TO THIS PRODUCT. NOR ARE THERE ANY OTHER WARRANTY TIES WHICH EXTEND BEYOND PROVISIONS OF THAT ATTACHED PRODUCT RETURN POLICY.

In any event no implied warranty of merchantability or fitness shall be of a duration greater than the duration referred to in the foregoing Product Return Policy.

C.H. Hanson shall have no liability whatsoever for CONSEQUENTIAL DAMAGES

C.H. Hanson rejects any contradictory or additional terms contained in any purchase order or other document submitted by the Buyer.

On all C.H. Hanson products

- Tapes (Flagging, Barricade, Stake Flags, all Tape items): 30 Day Warranty
- Marking Tools (Paint Markers, Crayons, China Markers, Paint Crayons): 30 Day Warranty
- All other C.H. Hanson product will fall into a Lifetime Warranty with exclusion of abuse (Limited Lifetime Warranty).

Tax Exemption

Illinois, California, Michigan, and Washington state law requires C.H. Hanson to collect sales taxes. It is the responsibility of the buyer to provide a hard copy of the applicable exemption certificate. Actual sales tax is calculated at time of shipment and reflected on the final invoice.

CUSTOM PRODUCTS

C.H. Hanson specializes in creating custom products to fit your business needs. Contact us to get started.

STAMPS



TAGS



TAPE



PENCILS



STENCILS



2000 N. Aurora Rd., Naperville, IL 60563
p: 800-827-3398
sales@chhanson.com
chhanson.com