



# CABLE TIE EXPRESS

PROUDLY CELEBRATING

TYING SERVICE TO QUALITY SINCE 1995



## PRODUCT CATALOG

- CONVENTIONAL CABLE TIES
- SPECIALTY CABLE TIES
- CLAMPING & BUNDLING PRODUCTS
- WIRE CONNECTORS

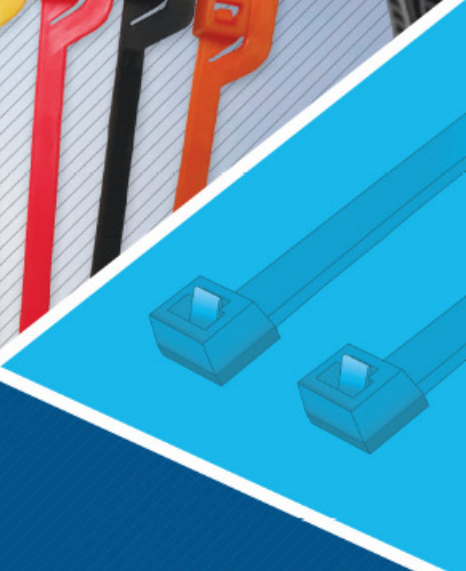



Cable Tie Express, founded in 1995, prides itself as an experienced world market provider in the cable tie and wire management arena. Meeting customer goals in terms of Product Line, Service, Quality, and Product Knowledge are the driving forces behind the Cable Tie Express philosophy and tagline – “tying service to quality.”

As this catalog becomes your tool for meeting your cable tie and wire management requirements, let us know how we can assist you in achieving your goals of success!



## PART NUMBERING SYSTEM QUICK GUIDE

Length, tensile strength, special features, color and quantity – all critical elements in determining the right tie for the application. Our part numbers include them all. Use this illustration to learn how to quickly get the relevant information for your needs and help in the ordering process.

**11\* - 50 - N - 1000**



11	—	*	—	50	—	N	—	1000
LENGTH		FEATURE		STRENGTH		COLOR		QUANTITY

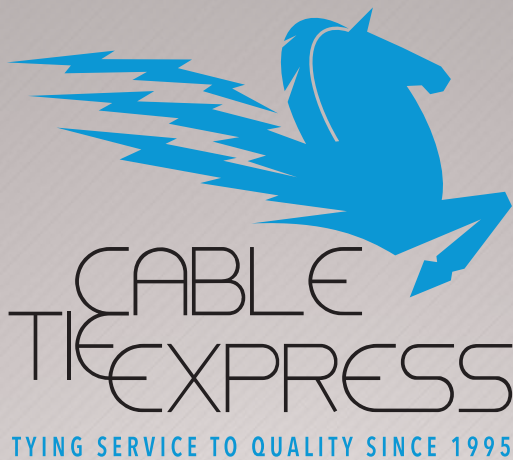

**Cable Tie Express** is a prime source for a wide range of conventional and specialty cable ties, mounting products, heat shrink tubing, and wire connectors, serving distributors and carrying one of the largest stocks of inventory in the United States.

For help with product information or to place an order, contact our experienced Sales Team or visit us online.

*Call Toll-Free*

**1-888-603-1233**

*Email us*

**sales@cabletieexpress.com**

*Visit us online*

**www.cabletieexpress.com**

## **Introduction**

- 2 Material Specifications

## **Conventional Cable Ties**

- 4 Miniature Ties
- 5 Intermediate Ties
- 6 Standard Ties
- 8 Heavy Duty Ties
- 9 Extra Heavy Duty Ties
- 10 Ultra Heavy Duty Ties

## **Specialty Cable Ties**

- 12 Beaded Ties
- 13 Cold Weather Ties
- 14 Colored Ties
- 15 Custom Printed Ties
- 16 Double Loop Ties
- 16 Fir Tree Push Mount Ties
- 17 Heat Stabilized Ties
- 18 Identification Ties
- 19 EZ-OFF™ Ties
- 19 Ladder Ties
- 20 Metal Detectable Ties
- 21 Mil-Spec Ties
- 22 Mounting Hole Ties
- 24 Plenum Ties
- 25 Push Mount Ties
- 26 Releasable Ties - Pawl
- 27 Releasable Ties - Tab
- 28 Sharp Tail Ties
- 28 Solar Rated Ties
- 29 Stainless Steel Ties
- 30 Steel Tooth Ties

## **Clamping & Bundling Products**

- 32 Adhesive Mounting Bases
- 33 Cable Clamps
- 34 Cradle Mounts
- 35 Spiral Wrap
- 36 Split Loom

## **Wire Connectors**

- 38 Screw On
- 38 Wing Twist On

## **Installation Tools**

- 40 Installation Tools

## **Heat Shrink Tubing**

- 42 Heat Shrink Tubing - Thin Wall
- 43 Heat Shrink Tubing - Dual Wall Adhesive Lined

## **Reference Material**

- 46 Moisture Content of Cable Ties
- 47 Cable Tie Performance & Safe Handling
- 48 Ordering & Return Policy

# material specifications

## General Purpose Polyamide 6.6

General purpose nylon 6/6 features light weight, high strength and a wide temperature range. Even at higher than recommended temperatures or exposure to flame, nylon does not give off toxic or irritating by-products. Nylon 6/6 is Hygroscopic and, therefore, absorbs or releases moisture depending on its environment. Moisture level of the material will affect tensile strength, stiffness and elongation of the product.

## Cold Weather Ties

- \* Impact modified performance
- \* Excellent in extreme cold

## Metal Detectable

- \* Used in areas around food and pharmaceutical industries where contamination may be an issue
- \* Manufactured in teal blue for easy identification and impregnated with metal flakes for pick-up with magnets if dropped. Also, could help to prevent critical recall
- \* Available in a variety of lengths and tensile strengths

## UV Stabilized Polyamide 6.6

General purpose nylon 6/6 with increased resistance to ultraviolet light. Carbon black is one of the most effective stabilizers known today. A uniform dispersion of carbon black provides good ultraviolet light resistance without adversely affecting physical properties. The addition of carbon black or any other ultraviolet stabilizer prolongs the useful life of plastic products used outdoors, but it does not totally eliminate the destructive effects of the light.

## Heat Stabilized Polyamide 6.6

Polyamide 6.6 Heat Stabilized material has chemical stabilizers which offer additional benefits for use during higher continuous operating temperature applications.

## Impact Modified, Heat Stabilized with Greater UV Protection Polyamide 6.6

Impact modified Polyamide 6.6 offers heat resistance, flexibility and higher levels of UV resistance. Added features of this material include greater resistance to heat, sunlight and vibration for mobile applications.

MATERIAL	OPERATING TEMPERATURE	COLOR	WEATHERING LIFE EXPECTANCY	FLAMMABILITY	MATERIAL PROPERTIES
Polyamide 6.6	-40°F to 185°F	Natural, Black & Colors	1 to 3 years	UL94V2	High Yield Strength
Polyamide 6.6 UV Resistant	-40°F to 185°F	Black	5 to 9 years	UL94V2	High Yield Strength UV Resistant
Polyamide 6.6 Heat Stabilized	-40°F to 221°F	Black	Natural 1 to 3 years Black 5 to 9 years	UL94V2	High Yield Strength Elevated Max Temps
Polyamide 6.6 Impact Modified	-40°F to 176°F	Black	Natural 1 to 3 years Black 5 to 9 years	UL94HB	Limited Brittleness Good at Low Temps
Polyamide 6.6 Impact Modified Heat Stabilized	-40°F to 221°F	Black	Natural 1 to 3 years Black 5 to 9 years	UL94HB	Limited Brittleness Good at Low Temps Elevated Max Temps
Polyamide 6.6 Cold Weather Heat Stabilized	-40°F to 221°F	Black	5 to 9 years	UL94HB	Limited Brittleness Good at Low Temps Flexible at Cold Temps



# CABLE TIE EXPRESS

TYING SERVICE TO QUALITY SINCE 1995



***conventional  
cable ties***

# miniature ties

## 18LB NATURAL

CABLE TIE EXPRESS #	LENGTH INCHES	TENSILE STRENGTH	TIE COLOR	PACKAGE QUANTITY	CARTON QUANTITY	WIDTH INCHES	THICKNESS INCHES	MAX BUNDLE DIA. IN.
3-18-N-100	3.0	18 lbs	Natural	100	25000	0.10	.04	0.6
3-18-N-1000	3.0	18 lbs	Natural	1000	25000	0.10	.04	0.6
4-18-N-100	4.1	18 lbs	Natural	100	25000	0.10	.04	1.0
4-18-N-1000	4.1	18 lbs	Natural	1000	25000	0.10	.04	1.0
6-18-N-100	6.1	18 lbs	Natural	100	20000	0.10	.05	1.2
6-18-N-1000	6.1	18 lbs	Natural	1000	20000	0.10	.05	1.2
8-18-N-100	8.0	18 lbs	Natural	100	20000	0.10	.05	2.2
8-18-N-1000	8.0	18 lbs	Natural	1000	20000	0.10	.05	2.2
15-18-N-100	15.8	18 lbs	Natural	100	10000	0.10	.06	4.5

## 18LB UV BLACK

CABLE TIE EXPRESS #	LENGTH INCHES	TENSILE STRENGTH	TIE COLOR	PACKAGE QUANTITY	CARTON QUANTITY	WIDTH INCHES	THICKNESS INCHES	MAX BUNDLE DIA. IN.
3-18-UV-100	3.0	18 lbs	UV Black	100	25000	0.10	.04	0.6
3-18-UV-1000	3.0	18 lbs	UV Black	1000	25000	0.10	.04	0.6
4-18-UV-100	4.1	18 lbs	UV Black	100	25000	0.10	.04	1.0
4-18-UV-1000	4.1	18 lbs	UV Black	1000	25000	0.10	.04	1.0
6-18-UV-100	6.1	18 lbs	UV Black	100	20000	0.10	.05	1.2
6-18-UV-1000	6.1	18 lbs	UV Black	1000	20000	0.10	.05	1.2
8-18-UV-100	8.0	18 lbs	UV Black	100	20000	0.10	.05	2.2
8-18-UV-1000	8.0	18 lbs	UV Black	1000	20000	0.10	.05	2.2
15-18-UV-100	15.8	18 lbs	UV Black	100	10000	0.10	.06	4.5

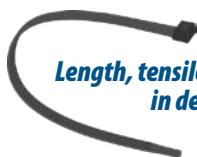

**Length, tensile strength, and bundle diameter – critical elements in determining the right tie for the application. Our part descriptions include them all.**





## 40LB NATURAL

CABLE TIE EXPRESS #	LENGTH INCHES	TENSILE STRENGTH	TIE COLOR	PACKAGE QUANTITY	CARTON QUANTITY	WIDTH INCHES	THICKNESS INCHES	MAX BUNDLE DIA. IN.
5-40-N-100	5.7	40 lbs	Natural	100	10000	.14	.06	1.25
5-40-N-1000	5.7	40 lbs	Natural	1000	10000	.14	.06	1.25
6-40-N-100	6.0	40 lbs	Natural	100	10000	.14	.06	1.5
6-40-N-1000	6.0	40 lbs	Natural	1000	10000	.14	.06	1.5
8-40-N-100	8.6	40 lbs	Natural	100	10000	.14	.06	2.0
8-40-N-1000	8.6	40 lbs	Natural	1000	10000	.14	.06	2.0
11-40-N-100	11.5	40 lbs	Natural	100	10000	.14	.06	3.2
11-40-N-1000	11.5	40 lbs	Natural	1000	10000	.14	.06	3.2
14-40-N-100	14.5	40 lbs	Natural	100	5000	.14	.06	4.1
14-40-N-500	14.5	40 lbs	Natural	500	5000	.14	.06	4.1

## 40LB UV BLACK

CABLE TIE EXPRESS #	LENGTH INCHES	TENSILE STRENGTH	TIE COLOR	PACKAGE QUANTITY	CARTON QUANTITY	WIDTH INCHES	THICKNESS INCHES	MAX BUNDLE DIA. IN.
5-40-UV-100	5.7	40 lbs	UV Black	100	10000	.14	.06	1.25
5-40-UV-1000	5.7	40 lbs	UV Black	1000	10000	.14	.06	1.25
6-40-UV-100	6.0	40 lbs	UV Black	100	10000	.14	.06	1.5
6-40-UV-1000	6.0	40 lbs	UV Black	1000	10000	.14	.06	1.5
8-40-UV-100	8.6	40 lbs	UV Black	100	10000	.14	.06	2.0
8-40-UV-1000	8.6	40 lbs	UV Black	1000	10000	.14	.06	2.0
11-40-UV-100	11.5	40 lbs	UV Black	100	10000	.14	.06	3.2
11-40-UV-1000	11.5	40 lbs	UV Black	1000	10000	.14	.06	3.2
14-40-UV-100	14.5	40 lbs	UV Black	100	5000	.14	.06	4.1
14-40-UV-500	14.5	40 lbs	UV Black	500	5000	.14	.06	4.1



*Consider offering the 40lb Intermediate Ties as a cost effective alternative to the 50lb series when the application allows.*

# standard ties

## 50LB NATURAL

CABLE TIE EXPRESS #	LENGTH INCHES	TENSILE STRENGTH	TIE COLOR	PACKAGE QUANTITY	CARTON QUANTITY	WIDTH INCHES	THICKNESS INCHES	MAX BUNDLE DIA. IN.
4-50-N-100	4.7	50 lbs	Natural	100	10000	.19	.06	1.0
6-50-N-100	6.3	50 lbs	Natural	100	10000	.19	.06	1.5
6-50-N-1000	6.3	50 lbs	Natural	1000	10000	.19	.06	1.5
8-50-N-100	7.6	50 lbs	Natural	100	10000	.19	.06	2.0
8-50-N-1000	7.6	50 lbs	Natural	1000	10000	.19	.06	2.0
11-50-N-100	11.1	50 lbs	Natural	100	5000	.19	.06	3.0
11-50-N-1000	11.1	50 lbs	Natural	1000	5000	.19	.06	3.0
14-50-N-100	14.5	50 lbs	Natural	100	5000	.19	.06	4.0
14-50-N-500	14.5	50 lbs	Natural	500	5000	.19	.06	4.0
15-50-N-100	15.2	50 lbs	Natural	100	5000	.19	.06	4.3
15-50-N-500	15.2	50 lbs	Natural	500	5000	.19	.06	4.3
17-50-N-100	17.0	50 lbs	Natural	100	4000	.19	.06	5.0
19-50-N-100	19.7	50 lbs	Natural	100	2000	.19	.06	5.8
21-50-N-100	21.7	50 lbs	Natural	100	2000	.19	.07	6.4
24-50-N-100	24.0	50 lbs	Natural	100	1000	.19	.07	7.4
36-50-N-50	36.0	50 lbs	Natural	50	1000	.19	.08	10.9

*continued on next page*



**The 50 lb series are the most popular ties on the market.  
Check out our available lengths in this series - stretching  
your options to 36"!**







## 50LB UV BLACK

CABLE TIE EXPRESS #	LENGTH INCHES	TENSILE STRENGTH	TIE COLOR	PACKAGE QUANTITY	CARTON QUANTITY	WIDTH INCHES	THICKNESS INCHES	MAX BUNDLE DIA. IN.
4-50-UV-100	4.7	50 lbs	UV Black	100	10000	.19	.06	1.0
6-50-UV-100	6.3	50 lbs	UV Black	100	10000	.19	.06	1.5
6-50-UV-1000	6.3	50 lbs	UV Black	1000	10000	.19	.06	1.5
8-50-UV-100	7.6	50 lbs	UV Black	100	10000	.19	.06	2.0
8-50-UV-1000	7.6	50 lbs	UV Black	1000	10000	.19	.06	2.0
11-50-UV-100	11.1	50 lbs	UV Black	100	5000	.19	.06	3.0
11-50-UV-1000	11.1	50 lbs	UV Black	1000	5000	.19	.06	3.0
14-50-UV-100	14.5	50 lbs	UV Black	100	5000	.19	.06	4.0
14-50-UV-500	14.5	50 lbs	UV Black	500	5000	.19	.06	4.0
15-50-UV-100	15.2	50 lbs	UV Black	100	5000	.19	.06	4.3
15-50-UV-500	15.2	50 lbs	UV Black	500	5000	.19	.06	4.3
17-50-UV-100	17.0	50 lbs	UV Black	100	4000	.19	.06	5.0
19-50-UV-100	19.7	50 lbs	UV Black	100	2000	.19	.06	5.8
21-50-UV-100	21.7	50 lbs	UV Black	100	2000	.19	.07	6.4
24-50-UV-100	24.0	50 lbs	UV Black	100	1000	.19	.07	7.4
36-50-UV-50	36.0	50 lbs	UV Black	50	1000	.19	.08	10.9



*If the application does not require a 50 lb tensile strength tie, consider offering your customers the Intermediate 40 lb series. Check with your engineering department for viability.*

# heavy duty ties

## 120LB NATURAL

CABLE TIE EXPRESS #	LENGTH INCHES	TENSILE STRENGTH	TIE COLOR	PACKAGE QUANTITY	CARTON QUANTITY	WIDTH INCHES	THICKNESS INCHES	MAX BUNDLE DIA. IN.
8-120-N-100	9.0	120 lbs	Natural	100	2500	.30	.07	2.0
11-120-N-100	12.0	120 lbs	Natural	100	2000	.30	.07	3.0
14-120-N-100	15.0	120 lbs	Natural	100	2000	.30	.07	4.0
18-120-N-50	17.7	120 lbs	Natural	50	1000	.30	.07	5.0
21-120-N-50	21.7	120 lbs	Natural	50	1000	.30	.07	6.3
28-120-N-50	28.0	120 lbs	Natural	50	1000	.35	.08	8.2

## 120LB UV BLACK

CABLE TIE EXPRESS #	LENGTH INCHES	TENSILE STRENGTH	TIE COLOR	PACKAGE QUANTITY	CARTON QUANTITY	WIDTH INCHES	THICKNESS INCHES	MAX BUNDLE DIA. IN.
8-120-UV-100	9.0	120 lbs	UV Black	100	2500	.30	.07	2.0
11-120-UV-100	12.0	120 lbs	UV Black	100	2000	.30	.07	3.0
14-120-UV-100	15.0	120 lbs	UV Black	100	2000	.30	.07	4.0
18-120-UV-50	17.7	120 lbs	UV Black	50	1000	.30	.07	5.0
21-120-UV-50	21.7	120 lbs	UV Black	50	1000	.30	.07	6.3
28-120-UV-50	28.0	120 lbs	UV Black	50	1000	.35	.08	8.2



*Ask us how we can help you customize. We offer private bag labeling, custom carton labeling, prints and specs customized to your part number and special carton and bag quantities.*



# extra heavy duty ties



## 175LB NATURAL

CABLE TIE EXPRESS #	LENGTH INCHES	TENSILE STRENGTH	TIE COLOR	PACKAGE QUANTITY	CARTON QUANTITY	WIDTH INCHES	THICKNESS INCHES	MAX BUNDLE DIA. IN.
18-175-N-50	17.8	175 lbs	Natural	50	1000	.35	.08	5.0
21-175-N-50	21.7	175 lbs	Natural	50	1000	.35	.08	6.3
24-175-N-50	24.5	175 lbs	Natural	50	500	.35	.08	8.0
30-175-N-50	30.0	175 lbs	Natural	50	500	.35	.08	9.0
32-175-N-50	32.0	175 lbs	Natural	50	500	.35	.08	9.6
36-175-N-50	36.7	175 lbs	Natural	50	500	.35	.08	11.0
48-175-N-50	48.0	175 lbs	Natural	50	500	.35	.08	15.0
60-175-N-50	59.0	175 lbs	Natural	50	500	.35	.08	18.2

## 175LB UV BLACK

CABLE TIE EXPRESS #	LENGTH INCHES	TENSILE STRENGTH	TIE COLOR	PACKAGE QUANTITY	CARTON QUANTITY	WIDTH INCHES	THICKNESS INCHES	MAX BUNDLE DIA. IN.
18-175-UV-50	17.8	175 lbs	UV Black	50	1000	.35	.08	5.0
21-175-UV-50	21.7	175 lbs	UV Black	50	1000	.35	.08	6.3
24-175-UV-50	24.5	175 lbs	UV Black	50	500	.35	.08	8.0
30-175-UV-50	30.0	175 lbs	UV Black	50	500	.35	.08	9.0
32-175-UV-50	32.0	175 lbs	UV Black	50	500	.35	.08	9.6
36-175-UV-50	36.7	175 lbs	UV Black	50	500	.35	.08	11.0
48-175-UV-50	48.0	175 lbs	UV Black	50	500	.35	.08	15.0
60-175-UV-50	59.0	175 lbs	UV Black	50	500	.35	.08	18.2



*We can cross reference our competitors' part numbers. Give us a call with your current specifications and we will be happy to do it for you - saving you the time and effort.*

# ultra heavy duty ties

## 250LB NATURAL

CABLE TIE EXPRESS #	LENGTH INCHES	TENSILE STRENGTH	TIE COLOR	PACKAGE QUANTITY	CARTON QUANTITY	WIDTH INCHES	THICKNESS INCHES	MAX BUNDLE DIA. IN.
9-250-N-50	9.0	250 lbs	Natural	50	2000	.50	.09	2.2
11-250-N-50	11.0	250 lbs	Natural	50	2000	.50	.09	3.0
15-250-N-50	14.8	250 lbs	Natural	50	2000	.50	.09	4.1
19-250-N-50	19.0	250 lbs	Natural	50	500	.50	.09	5.4
21-250-N-50	21.6	250 lbs	Natural	50	500	.50	.09	6.3
28-250-N-50	28.7	250 lbs	Natural	50	500	.50	.09	8.5
34-250-N-50	34.6	250 lbs	Natural	50	500	.50	.09	10.4
40-250-N-50	40.6	250 lbs	Natural	50	500	.50	.09	12.3

## 250LB UV BLACK

CABLE TIE EXPRESS #	LENGTH INCHES	TENSILE STRENGTH	TIE COLOR	PACKAGE QUANTITY	CARTON QUANTITY	WIDTH INCHES	THICKNESS INCHES	MAX BUNDLE DIA. IN.
9-250-UV-50	9.0	250 lbs	UV Black	50	2000	.50	.09	2.2
11-250-UV-50	11.0	250 lbs	UV Black	50	2000	.50	.09	3.0
15-250-UV-50	14.8	250 lbs	UV Black	50	2000	.50	.09	4.1
19-250-UV-50	19.0	250 lbs	UV Black	50	500	.50	.09	5.4
21-250-UV-50	21.6	250 lbs	UV Black	50	500	.50	.09	6.3
28-250-UV-50	28.7	250 lbs	UV Black	50	500	.50	.09	8.5
34-250-UV-50	34.6	250 lbs	UV Black	50	500	.50	.09	10.4
40-250-UV-50	40.6	250 lbs	UV Black	50	500	.50	.09	12.3



***Cable Tie Express adheres to the highest standards of excellence.  
You will always be treated with friendliness, honesty,  
and integrity from everyone at Cable Tie Express.***

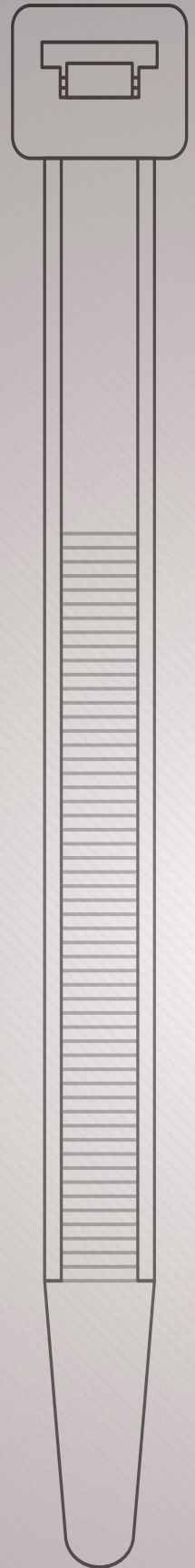



# CABLE TIE EXPRESS

TYING SERVICE TO QUALITY SINCE 1995



***specialty  
cable ties***

**specialty  
cable ties**

# beaded ties

## 18LB NATURAL

CABLE TIE EXPRESS #	LENGTH INCHES	TENSILE STRENGTH	TIE COLOR	PACKAGE QUANTITY	CARTON QUANTITY	MAX BUNDLE DIA. IN.
4B-18-N-1000	4.0	18 lbs	Natural	1000	5000	1.0

## 30LB NATURAL

CABLE TIE EXPRESS #	LENGTH INCHES	TENSILE STRENGTH	TIE COLOR	PACKAGE QUANTITY	CARTON QUANTITY	MAX BUNDLE DIA. IN.
6B-30-N-1000	5.9	30 lbs	Natural	1000	10000	1.5

## 40LB NATURAL

CABLE TIE EXPRESS #	LENGTH INCHES	TENSILE STRENGTH	TIE COLOR	PACKAGE QUANTITY	CARTON QUANTITY	MAX BUNDLE DIA. IN.
9B-40-N-1000	9.0	40 lbs	Natural	1000	5000	2.5

## 75LB NATURAL

CABLE TIE EXPRESS #	LENGTH INCHES	TENSILE STRENGTH	TIE COLOR	PACKAGE QUANTITY	CARTON QUANTITY	MAX BUNDLE DIA. IN.
11B-75-N-1000	11	75 lbs	Natural	1000	5000	3.0

Beaded Ties require no setting tool, are adjustable, and are fully releasable. Check out the 4"- 11" lengths for labeling, tagging and temporary bundling applications.

*The sizes listed are also available in Black*



*We strive to stock a wide selection of cable tie styles and sizes in order to offer a 'one-stop solution' - enabling you to consolidate vendors for ease of ordering.*





## 50LB

CABLE TIE EXPRESS #	LENGTH INCHES	TENSILE STRENGTH	TIE COLOR	PACKAGE QUANTITY	CARTON QUANTITY	WIDTH INCHES	THICKNESS INCHES	MAX BUNDLE DIA. IN.
8-50-CWB-100	7.6	50 lbs	UV Black	100	10000	.180	.054	2.0
11-50-CWB-100	11.1	50 lbs	UV Black	100	5000	.180	.054	3.0
14-50-CWB-100	14.6	50 lbs	UV Black	100	5000	.180	.054	4.0

## 120LB

CABLE TIE EXPRESS #	LENGTH INCHES	TENSILE STRENGTH	TIE COLOR	PACKAGE QUANTITY	CARTON QUANTITY	WIDTH INCHES	THICKNESS INCHES	MAX BUNDLE DIA. IN.
14-120-CWB-100	15.0	120 lbs	UV Black	100	2000	.298	.069	4.0

## 175LB

CABLE TIE EXPRESS #	LENGTH INCHES	TENSILE STRENGTH	TIE COLOR	PACKAGE QUANTITY	CARTON QUANTITY	WIDTH INCHES	THICKNESS INCHES	MAX BUNDLE DIA. IN.
24-175-CWB-50	24.0	175 lbs	UV Black	50	500	.335	.087	8.0

Cold Weather Ties are designed to function in extreme environmental conditions. The Cold Weather Nylon 6/6 resin blend is specifically designed to solve cold temperature (-20°C) and low humidity application issues. Other features of the Cold Weather Tie is its extended UV protection and enhanced flexibility.

***Rated for installations down to -4° F (-20° C)***



***Our highly experienced Sales Team are here to help with your specific requirements and ordering options. We will partner with you to achieve your goals.***

# colored ties

## 18LB COLORS

CABLE TIE EXPRESS #	LENGTH INCHES	TENSILE STRENGTH	PACKAGE QUANTITY	CARTON QUANTITY	WIDTH INCHES	THICKNESS INCHES	MAX BUNDLE DIA. IN.
4-18-COLOR-100	4.1	18 lbs	100	10000	.10	.04	0.8
4-18-COLOR-1000	4.1	18 lbs	1000	10000	.10	.04	0.8

## 40LB COLORS

CABLE TIE EXPRESS #	LENGTH INCHES	TENSILE STRENGTH	PACKAGE QUANTITY	CARTON QUANTITY	WIDTH INCHES	THICKNESS INCHES	MAX BUNDLE DIA. IN.
5-40-COLOR-100	5.7	40 lbs	100	10000	.14	.05	1.5
5-40-COLOR-1000	5.7	40 lbs	1000	10000	.14	.05	1.5
8-40-COLOR-100	8.6	40 lbs	100	10000	.14	.05	2.0
8-40-COLOR-1000	8.6	40 lbs	1000	10000	.14	.05	2.0

## 50LB COLORS

CABLE TIE EXPRESS #	LENGTH INCHES	TENSILE STRENGTH	PACKAGE QUANTITY	CARTON QUANTITY	WIDTH INCHES	THICKNESS INCHES	MAX BUNDLE DIA. IN.
7-50-COLOR-100	7.6	50 lbs	100	10000	.18	.05	2.0
7-50-COLOR-1000	7.6	50 lbs	1000	10000	.18	.05	2.0
11-50-COLOR-100	11.1	50 lbs	100	5000	.18	.05	3.0
11-50-COLOR-500	11.1	50 lbs	500	5000	.18	.05	3.0
14-50-COLOR-100	14.5	50 lbs	100	5000	.18	.05	4.0
14-50-COLOR-500	14.5	50 lbs	500	5000	.18	.05	4.0

## 120LB COLORS

CABLE TIE EXPRESS #	LENGTH INCHES	TENSILE STRENGTH	PACKAGE QUANTITY	CARTON QUANTITY	WIDTH INCHES	THICKNESS INCHES	MAX BUNDLE DIA. IN.
14-120-COLOR-100	15.0	120 lbs	100	2000	.30	.07	4.0

### Standard Color Code

(BE) = Blue	(OE) = Orange
(BR) = Brown	(PE) = Purple
(GN) = Green	(RD) = Red
(GY) = Gray	(YW) = Yellow

### Fluorescent Color Code

(FBE) = Fluorescent Blue
(FGN) = Fluorescent Green
(FOE) = Fluorescent Orange
(FPK) = Fluorescent Pink
(FYW) = Fluorescent Yellow

To order a specific color, substitute color code above for "COLOR" in the part number - Example: 4-18-BE-100





# custom printed ties

## OUR CUSTOM PRINTED TIES ARE AVAILABLE IN ANY SIZE, ANY COLOR, ANY STYLE!

Whatever your custom printed tie needs, Cable Tie Express can supply fully customized solutions for all applications and needs. With our range of fully customizable options, create a custom tie that's perfect for you. Call one of our representatives for more information about our options and how to order.

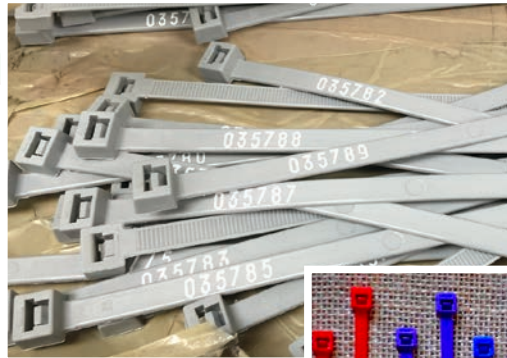

### Applications

- \* Tamper Proof
- \* Identification
- \* Tote Boxes
- \* Hazmat Labeling
- \* Money and Mail Bags

### Custom Print Options

- \* Serial Number
- \* Sequential Numbering
- \* Customer Name
- \* Contact Information
- \* Company Logo

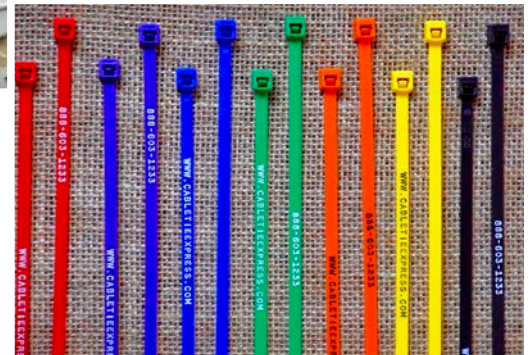

*Call one of our representatives for more information about our options and how to order*



*Length, tensile strength, and bundle diameter – critical elements in determining the right tie for the application. Our part descriptions include them all.*

# double loop ties

## 50LB NATURAL

CABLE TIE EXPRESS #	LENGTH INCHES	TENSILE STRENGTH	TIE COLOR	PACKAGE QUANTITY	CARTON QUANTITY	WIDTH INCHES	THICKNESS INCHES	MAX BUNDLE DIA. IN.
8DL-50-N-100	8.8	50 lbs	Natural	100	5000	.19	.05	.80 x .80
11DL-50-N-100	11.9	50 lbs	Natural	100	5000	.19	.05	1.50 x 1.50
14DL-50-N-100	14.6	50 lbs	Natural	100	5000	.19	.05	2.00 x 2.00

## 50LB UV BLACK

CABLE TIE EXPRESS #	LENGTH INCHES	TENSILE STRENGTH	TIE COLOR	PACKAGE QUANTITY	CARTON QUANTITY	WIDTH INCHES	THICKNESS INCHES	MAX BUNDLE DIA. IN.
8DL-50-UV-100	8.8	50 lbs	UV Black	100	5000	.19	.05	.80 x .80
11DL-50-UV-100	11.9	50 lbs	UV Black	100	5000	.19	.05	1.50 x 1.50
14DL-50-UV-100	14.6	50 lbs	UV Black	100	5000	.19	.05	2.00 x 2.00

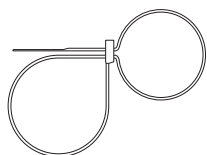

Need to secure two bundles or attach cords or cables to a conduit run or surface? The Double Loop Tie offers tensile strengths of 50lbs for this unique application.



# fir tree push mount ties

## 50LB HEAT STABILIZED BLACK

CABLE TIE EXPRESS #	LENGTH INCHES	TENSILE STRENGTH	TIE COLOR	PACKAGE QUANTITY	CARTON QUANTITY	WIDTH INCHES	THICKNESS INCHES	MAX BUNDLE DIA. IN.
8FT-50-UV-1000	8.6	50 lbs	Heat Stabilized Black	1000	5000	.180	.055	2.0



# heat stabilized ties



## 18LB MINIATURE

CABLE TIE EXPRESS #	LENGTH INCHES	TENSILE STRENGTH	TIE COLOR	PACKAGE QUANTITY	CARTON QUANTITY	WIDTH INCHES	THICKNESS INCHES	MAX BUNDLE DIA. IN.
4-18-HS-1000	4.1	18 lbs	Black	1000	25000	.10	.04	0.75

## 40LB INTERMEDIATE

CABLE TIE EXPRESS #	LENGTH INCHES	TENSILE STRENGTH	TIE COLOR	PACKAGE QUANTITY	CARTON QUANTITY	WIDTH INCHES	THICKNESS INCHES	MAX BUNDLE DIA. IN.
5-40-HS-1000	5.7	40 lbs	Black	1000	10000	.14	.05	1.25
8-40-HS-1000	8.6	40 lbs	Black	1000	10000	.14	.05	2.0

## 50LB STANDARD

CABLE TIE EXPRESS #	LENGTH INCHES	TENSILE STRENGTH	TIE COLOR	PACKAGE QUANTITY	CARTON QUANTITY	WIDTH INCHES	THICKNESS INCHES	MAX BUNDLE DIA. IN.
8-50-HS-100	7.6	50 lbs	Black	100	10000	.18	.05	1.9
8-50-HS-1000	7.6	50 lbs	Black	1000	10000	.18	.05	1.9
11-50-HS-100	11.1	50 lbs	Black	100	5000	.18	.05	3.0
11-50-HS-1000	11.1	50 lbs	Black	1000	5000	.18	.05	3.0
14-50-HS-100	14.5	50 lbs	Black	100	5000	.18	.05	4.0
14-50-HS-1000	14.5	50 lbs	Black	1000	5000	.18	.05	4.0

## 120LB HEAVY DUTY

CABLE TIE EXPRESS #	LENGTH INCHES	TENSILE STRENGTH	TIE COLOR	PACKAGE QUANTITY	CARTON QUANTITY	WIDTH INCHES	THICKNESS INCHES	MAX BUNDLE DIA. IN.
14-120-HS-100	15.0	120 lbs	Black	100	2000	.30	.07	4.0

Heat Stabilized Nylon 6/6 cable ties perform effectively in high temperature applications to 221°F. The working temperature range of standard Nylon 6/6 cable ties is -40°F to 185°F.

**Temperature rating: -40° F (-40° C) to 221° F (105° C)**

# identification ties

## 18LB NATURAL - INTERNAL/HORIZONTAL

CABLE TIE EXPRESS #	LENGTH INCHES	TENSILE STRENGTH	TIE COLOR	PACKAGE QUANTITY	WIDTH INCHES	THICKNESS INCHES	MAX BUNDLE DIA IN.	WRITE ON AREA
4ID-18-N-100	4.0	18 lbs	Natural	100	.10	0.04	1.0	.30 x 1.0

## 18LB UV BLACK - INTERNAL/HORIZONTAL

CABLE TIE EXPRESS #	LENGTH INCHES	TENSILE STRENGTH	TIE COLOR	PACKAGE QUANTITY	WIDTH INCHES	THICKNESS INCHES	MAX BUNDLE DIA IN.	WRITE ON AREA
4ID-18-UV-100	4.0	18 lbs	UV Black	100	.10	0.04	1.0	.30 x 1.0

## 50LB NATURAL - INTERNAL/VERTICAL

CABLE TIE EXPRESS #	LENGTH INCHES	TENSILE STRENGTH	TIE COLOR	PACKAGE QUANTITY	WIDTH INCHES	THICKNESS INCHES	MAX BUNDLE DIA IN.	WRITE ON AREA
8ID-50-N-100	8.0	50 lbs	Natural	100	.18	0.06	2.0	1.1 x .50
14ID-50-N-100	14.0	50 lbs	Natural	100	.18	0.06	4.0	2.0 x .50

## 50LB UV BLACK - INTERNAL/VERTICAL

CABLE TIE EXPRESS #	LENGTH INCHES	TENSILE STRENGTH	TIE COLOR	PACKAGE QUANTITY	WIDTH INCHES	THICKNESS INCHES	MAX BUNDLE DIA IN.	WRITE ON AREA
8ID-50-UV-100	8.0	50 lbs	UV Black	100	.18	0.06	2.0	1.1 x .50
14ID-50-UV-100	14.0	50 lbs	UV Black	100	.18	0.06	4.0	2.0 x .50

## 18LB NATURAL - EXTERNAL/HORIZONTAL

CABLE TIE EXPRESS #	LENGTH INCHES	TENSILE STRENGTH	TIE COLOR	PACKAGE QUANTITY	WIDTH INCHES	THICKNESS INCHES	MAX BUNDLE DIA IN.	WRITE ON AREA
4IDE-18-N-100	4.0	18 lbs	Natural	100	.10	0.04	1.0	.30 x 1.0

## 18LB UV BLACK - EXTERNAL/HORIZONTAL

CABLE TIE EXPRESS #	LENGTH INCHES	TENSILE STRENGTH	TIE COLOR	PACKAGE QUANTITY	WIDTH INCHES	THICKNESS INCHES	MAX BUNDLE DIA IN.	WRITE ON AREA
4IDE-18-UV-100	4.0	18 lbs	UV Black	100	.10	0.04	1.0	.30 x 1.0

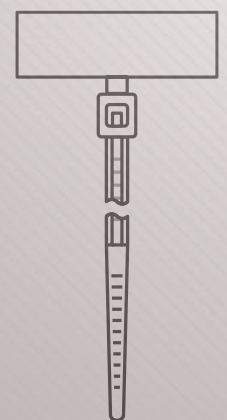
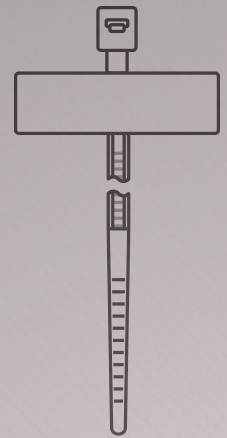

## EZ-OFF™ TIES

CABLE TIE EXPRESS #	LENGTH INCHES	TENSILE STRENGTH	TIE COLOR	PACKAGE QUANTITY	CARTON QUANTITY	WIDTH INCHES
N6-BK-1000	5.375	30 lbs	Black	1000	10000	.140
N6-RD-1000	5.375	30 lbs	Red	1000	10000	.140
N6-OE-1000	5.375	30 lbs	Orange	1000	10000	.140
N6-YW-1000	5.375	30 lbs	Yellow	1000	10000	.140
N6-GN-1000	5.375	30 lbs	Green	1000	10000	.140
N6-BE-1000	5.375	30 lbs	Blue	1000	10000	.140
N6-PE-1000	5.375	30 lbs	Purple	1000	10000	.140
N6-N-1000	5.375	30 lbs	Natural	1000	10000	.140

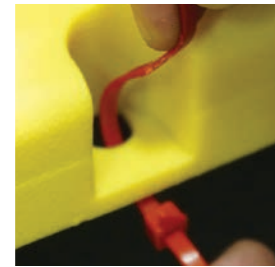
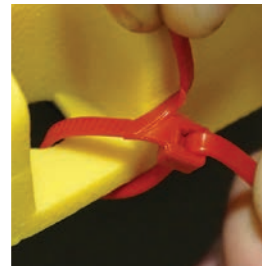

# ladder ties

## LADDER TIES

CABLE TIE EXPRESS #	LENGTH INCHES	TENSILE STRENGTH	TIE COLOR	PACKAGE QUANTITY	CARTON QUANTITY	WIDTH INCHES	THICKNESS INCHES	MAX BUNDLE DIA. IN.
7LD-40-N-1000	7.0	40 lbs	Natural	1000	10000	.137	.035	1.75
7LD-40-HS-1000	7.0	40 lbs	UV Black	1000	10000	.137	.035	1.75
11LD-40-N-1000	11.0	50 lbs	Natural	1000	10000	.137	.035	3.0
11LD-40-HS-1000	11.0	50 lbs	UV Black	1000	10000	.137	.035	3.0

# metal detectable ties

## 18LB

CABLE TIE EXPRESS #	LENGTH INCHES	TENSILE STRENGTH	TIE COLOR	PACKAGE QUANTITY	CARTON QUANTITY	WIDTH INCHES	THICKNESS INCHES	MAX BUNDLE DIA. IN.
4-18-DTN-100	4.1	18 lbs	Teal	100	10000	.096	.035	0.75

## 40LB

CABLE TIE EXPRESS #	LENGTH INCHES	TENSILE STRENGTH	TIE COLOR	PACKAGE QUANTITY	CARTON QUANTITY	WIDTH INCHES	THICKNESS INCHES	MAX BUNDLE DIA. IN.
8-40-DTN-100	8.6	40 lbs	Teal	100	10000	.142	.050	2.0

## 50LB

CABLE TIE EXPRESS #	LENGTH INCHES	TENSILE STRENGTH	TIE COLOR	PACKAGE QUANTITY	CARTON QUANTITY	WIDTH INCHES	THICKNESS INCHES	MAX BUNDLE DIA. IN.
7-50-DTN-100	7.6	50 lbs	Teal	100	10000	.180	.054	1.9
11-50-DTN-100	11.1	50 lbs	Teal	100	5000	.180	.054	3.0
14-50-DTN-100	14.5	50 lbs	Teal	100	5000	.180	.054	4.0

## 120LB

CABLE TIE EXPRESS #	LENGTH INCHES	TENSILE STRENGTH	TIE COLOR	PACKAGE QUANTITY	CARTON QUANTITY	WIDTH INCHES	THICKNESS INCHES	MAX BUNDLE DIA. IN.
14-120-DTN-100	15.0	120 lbs	Teal	100	2000	.298	.069	4.0

Metal Detectable ties are specifically designed for use in the food, beverage, and pharmaceutical processing industries. These ties are manufactured with metal impregnated material that allows for identification by metal detectors, x-ray inspections, and magnets.

***Metal Detectable ties are a teal color per common industry practices for easy visual detection - Custom colors are available upon request***



***Ask us how we can help you customize. We offer private bag labeling, custom carton labeling, prints and specs customized to your part number and special carton and bag quantities.***





## NATURAL

CABLE TIE EXPRESS #	LENGTH INCHES	TENSILE STRENGTH	TIE COLOR	PACKAGE QUANTITY	CARTON QUANTITY	WIDTH INCHES	THICKNESS INCHES	MAX BUNDLE DIA. IN.
MS3367-1-9	7.6	50 lbs	Natural	1000	10000	.18	.05	1.9
MS3367-2-9	14.5	50 lbs	Natural	500	5000	.18	.05	4.0
MS3367-3-9	15.0	120 lbs	Natural	100	2000	.30	.07	4.0
MS3367-4-9	4.1	18 lbs	Natural	1000	25000	.10	.04	0.75
MS3367-5-9	5.7	40 lbs	Natural	1000	10000	.14	.05	1.4
MS3367-7-9	11.1	50 lbs	Natural	1000	5000	.18	.05	3.0
MS3367-10-9	24.5	175 lbs	Natural	50	500	.34	.09	7.2
MS3367-13-9	36.7	175 lbs	Natural	50	500	.34	.09	11.0

## UV BLACK

CABLE TIE EXPRESS #	LENGTH INCHES	TENSILE STRENGTH	TIE COLOR	PACKAGE QUANTITY	CARTON QUANTITY	WIDTH INCHES	THICKNESS INCHES	MAX BUNDLE DIA. IN.
MS3367-1-0	7.6	50 lbs	UV Black	1000	10000	.18	.05	1.9
MS3367-2-0	14.5	50 lbs	UV Black	500	5000	.18	.05	4.0
MS3367-3-0	15.0	120 lbs	UV Black	100	2000	.30	.07	4.0
MS3367-4-0	4.1	18 lbs	UV Black	1000	25000	.10	.04	0.75
MS3367-5-0	5.7	40 lbs	UV Black	1000	10000	.14	.05	1.4
MS3367-7-0	11.1	50 lbs	UV Black	1000	5000	.18	.05	3.0
MS3367-10-0	24.5	175 lbs	UV Black	50	500	.34	.09	7.2
MS3367-13-0	36.7	175 lbs	UV Black	50	500	.34	.09	11.0

Our Mil-Spec ties conform to MS #3367. Additional colors are available in the Mil-Spec range.

***Call us to discuss additional Mil-Spec parts that are available***



***We can cross reference our competitors' part numbers. Give us a call with your current specifications and we will be happy to do it for you - saving you the time and effort.***

# mounting hole ties

## 18LB NATURAL

CABLE TIE EXPRESS #	LENGTH INCHES	TENSILE STRENGTH	TIE COLOR	PACKAGE QUANTITY	CARTON QUANTITY	WIDTH INCHES	THICKNESS INCHES	MAX BUNDLE DIA. IN.	MOUNT SCREW
4M-18-N-100	4.5	18 lbs	Natural	100	10000	.10	.04	1.0	#6
4M-18-N-1000	4.5	18 lbs	Natural	1000	10000	.10	.04	1.0	#6

## 18LB UV BLACK

CABLE TIE EXPRESS #	LENGTH INCHES	TENSILE STRENGTH	TIE COLOR	PACKAGE QUANTITY	CARTON QUANTITY	WIDTH INCHES	THICKNESS INCHES	MAX BUNDLE DIA. IN.	MOUNT SCREW
4M-18-UV-100	4.5	18 lbs	UV Black	100	10000	.10	.04	1.0	#6
4M-18-UV-1000	4.5	18 lbs	UV Black	1000	10000	.10	.04	1.0	#6

## 40LB NATURAL

CABLE TIE EXPRESS #	LENGTH INCHES	TENSILE STRENGTH	TIE COLOR	PACKAGE QUANTITY	CARTON QUANTITY	WIDTH INCHES	THICKNESS INCHES	MAX BUNDLE DIA. IN.	MOUNT SCREW
6M-40-N-100	6.7	40 lbs	Natural	100	10000	.14	.05	1.5	#10
6M-40-N-1000	6.7	40 lbs	Natural	1000	10000	.14	.05	1.5	#10
6M8-40-N-100	6.7	40 lbs	Natural	100	10000	.14	.05	1.5	#8
6M8-40-N-1000	6.7	40 lbs	Natural	1000	10000	.14	.05	1.5	#8

## 40LB UV BLACK

CABLE TIE EXPRESS #	LENGTH INCHES	TENSILE STRENGTH	TIE COLOR	PACKAGE QUANTITY	CARTON QUANTITY	WIDTH INCHES	THICKNESS INCHES	MAX BUNDLE DIA. IN.	MOUNT SCREW
6M-40-UV-100	6.7	40 lbs	UV Black	100	10000	.14	.05	1.5	#10
6M-40-UV-1000	6.7	40 lbs	UV Black	1000	10000	.14	.05	1.5	#10
6M8-40-UV-100	6.7	40 lbs	UV Black	100	10000	.14	.05	1.5	#8
6M8-40-UV-1000	6.7	40 lbs	UV Black	1000	10000	.14	.05	1.5	#8

*continued on next page*

Mounting Hole Cable Ties allow the tie to be attached to the mounting surface via mechanical fasteners. Bundling can be done before or after screwing the clamp in place.

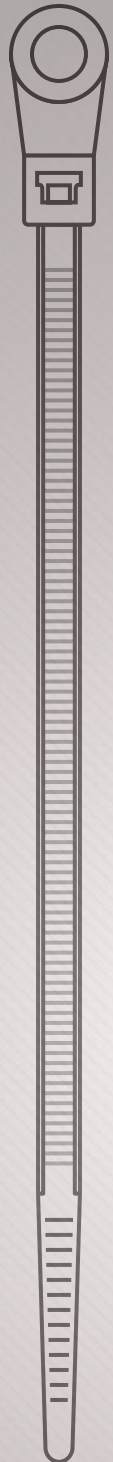



# mounting hole ties

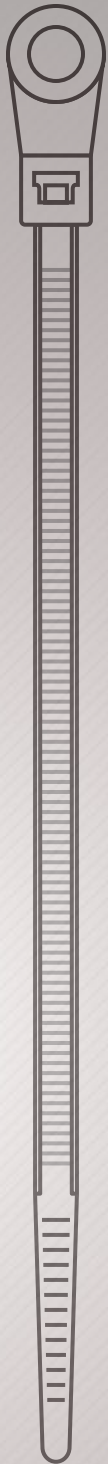

## 50LB NATURAL

CABLE TIE EXPRESS #	LENGTH INCHES	TENSILE STRENGTH	TIE COLOR	PACKAGE QUANTITY	CARTON QUANTITY	WIDTH INCHES	THICKNESS INCHES	MAX BUNDLE DIA. IN.	MOUNT SCREW
8M-50-N-100	8.1	50 lbs	Natural	100	5000	.18	.06	2.0	#10
8M-50-N-1000	8.1	50 lbs	Natural	1000	5000	.18	.06	2.0	#10
11M-50-N-100	11.6	50 lbs	Natural	100	5000	.18	.06	3.0	#10
11M-50-N-500	11.6	50 lbs	Natural	500	5000	.18	.06	3.0	#10
14M-50-N-100	15.1	50 lbs	Natural	100	5000	.18	.06	4.0	#10
14M-50-N-500	15.1	50 lbs	Natural	500	5000	.18	.06	4.0	#10

## 50LB UV BLACK

CABLE TIE EXPRESS #	LENGTH INCHES	TENSILE STRENGTH	TIE COLOR	PACKAGE QUANTITY	CARTON QUANTITY	WIDTH INCHES	THICKNESS INCHES	MAX BUNDLE DIA. IN.	MOUNT SCREW
8M-50-UV-100	8.1	50 lbs	UV Black	100	5000	.18	.06	2.0	#10
8M-50-UV-1000	8.1	50 lbs	UV Black	1000	5000	.18	.06	2.0	#10
11M-50-UV-100	11.6	50 lbs	UV Black	100	5000	.18	.06	3.0	#10
11M-50-UV-500	11.6	50 lbs	UV Black	500	5000	.18	.06	3.0	#10
14M-50-UV-100	15.1	50 lbs	UV Black	100	5000	.18	.06	4.0	#10
14M-50-UV-500	15.1	50 lbs	UV Black	500	5000	.18	.06	4.0	#10

## 120LB NATURAL

CABLE TIE EXPRESS #	LENGTH INCHES	TENSILE STRENGTH	TIE COLOR	PACKAGE QUANTITY	CARTON QUANTITY	WIDTH INCHES	THICKNESS INCHES	MAX BUNDLE DIA. IN.	MOUNT SCREW
14M-120-N-100	15.7	120 lbs	Natural	100	2000	.30	.07	4.0	.25

## 120LB UV BLACK

CABLE TIE EXPRESS #	LENGTH INCHES	TENSILE STRENGTH	TIE COLOR	PACKAGE QUANTITY	CARTON QUANTITY	WIDTH INCHES	THICKNESS INCHES	MAX BUNDLE DIA. IN.	MOUNT SCREW
14M-120-UV-100	15.7	120 lbs	UV Black	100	2000	.30	.07	4.0	.25

# plenum ties

## 18LB

CABLE TIE EXPRESS #	LENGTH INCHES	TENSILE STRENGTH	TIE COLOR	PACKAGE QUANTITY	CARTON QUANTITY	WIDTH INCHES	THICKNESS INCHES	MAX BUNDLE DIA. IN.
4-18-PL-100	4.1	18 lbs	Burgundy	100	25000	.096	.035	0.75

## 50LB

CABLE TIE EXPRESS #	LENGTH INCHES	TENSILE STRENGTH	TIE COLOR	PACKAGE QUANTITY	CARTON QUANTITY	WIDTH INCHES	THICKNESS INCHES	MAX BUNDLE DIA. IN.
8-50-PL-100	7.6	50 lbs	Burgundy	100	10000	.180	.054	2.0
11-50-PL-100	11.1	50 lbs	Burgundy	100	5000	.180	.054	3.0
14-50-PL-100	14.6	50 lbs	Burgundy	100	5000	.180	.054	4.0

## 120LB

CABLE TIE EXPRESS #	LENGTH INCHES	TENSILE STRENGTH	TIE COLOR	PACKAGE QUANTITY	CARTON QUANTITY	WIDTH INCHES	THICKNESS INCHES	MAX BUNDLE DIA. IN.
14-120-PL-100	15.0	120 lbs	Burgundy	100	2000	.298	.069	4.0

Designed specifically for use in plenum air handling spaces, our Plenum Ties are certified to meet UL2043 Standards.

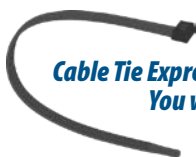

*Cable Tie Express adheres to the highest standards of excellence. You will always be treated with friendliness, honesty, and integrity from everyone at Cable Tie Express.*





## 40LB NATURAL - WITHOUT WINGS

CABLE TIE EXPRESS #	LENGTH INCHES	TENSILE STRENGTH	TIE COLOR	PACKAGE QUANTITY	CARTON QUANTITY	WIDTH INCHES	THICKNESS INCHES	MAX BUNDLE DIA. IN.	MOUNT SCREW
6PM-40-N-100	6.6	40 lbs	Natural	100	10000	.15	.06	1.5	#10
6PM-40-N-1000	6.6	40 lbs	Natural	1000	10000	.15	.06	1.5	#10

## 40LB UV BLACK - WITHOUT WINGS

CABLE TIE EXPRESS #	LENGTH INCHES	TENSILE STRENGTH	TIE COLOR	PACKAGE QUANTITY	CARTON QUANTITY	WIDTH INCHES	THICKNESS INCHES	MAX BUNDLE DIA. IN.	MOUNT SCREW
6PM-40-UV-100	6.6	40 lbs	UV Black	100	10000	.15	.06	1.5	#10
6PM-40-UV-1000	6.6	40 lbs	UV Black	1000	10000	.15	.06	1.5	#10

## 50LB NATURAL - WITHOUT WINGS

CABLE TIE EXPRESS #	LENGTH INCHES	TENSILE STRENGTH	TIE COLOR	PACKAGE QUANTITY	CARTON QUANTITY	WIDTH INCHES	THICKNESS INCHES	MAX BUNDLE DIA. IN.	MOUNT SCREW
8PM-50-N-100	8.0	50 lbs	Natural	100	5000	.18	.06	1.8	.25
8PM-50-N-500	8.0	50 lbs	Natural	500	5000	.18	.06	1.8	.25

## 50LB UV BLACK - WITHOUT WINGS

CABLE TIE EXPRESS #	LENGTH INCHES	TENSILE STRENGTH	TIE COLOR	PACKAGE QUANTITY	CARTON QUANTITY	WIDTH INCHES	THICKNESS INCHES	MAX BUNDLE DIA. IN.	MOUNT SCREW
8PM-50-UV-100	8.0	50 lbs	UV Black	100	5000	.18	.06	1.8	.25
8PM-50-UV-500	8.0	50 lbs	UV Black	500	5000	.18	.06	1.8	.25

## 50LB NATURAL - WITH WINGS

CABLE TIE EXPRESS #	LENGTH INCHES	TENSILE STRENGTH	TIE COLOR	PACKAGE QUANTITY	CARTON QUANTITY	WIDTH INCHES	THICKNESS INCHES	MAX BUNDLE DIA. IN.	MOUNT SCREW
8WPM-50-N-100	8.0	50 lbs	Natural	100	5000	.19	.05	1.8	.25
8WPM-50-N-500	8.0	50 lbs	Natural	500	5000	.19	.05	1.8	.25

## 50LB UV BLACK - WITH WINGS

CABLE TIE EXPRESS #	LENGTH INCHES	TENSILE STRENGTH	TIE COLOR	PACKAGE QUANTITY	CARTON QUANTITY	WIDTH INCHES	THICKNESS INCHES	MAX BUNDLE DIA. IN.	MOUNT SCREW
8WPM-50-UV-100	8.0	50 lbs	UV Black	100	5000	.19	.05	1.8	.25
8WPM-50-UV-500	8.0	50 lbs	UV Black	500	5000	.19	.05	1.8	.25

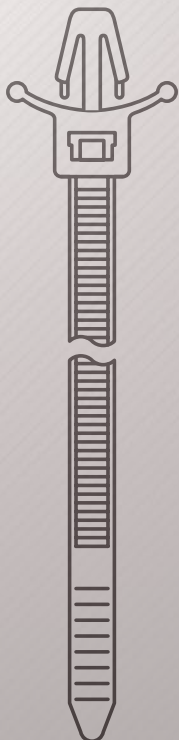

# releasable ties - pawl

## 50LB NATURAL

CABLE TIE EXPRESS #	LENGTH INCHES	TENSILE STRENGTH	TIE COLOR	PACKAGE QUANTITY	CARTON QUANTITY	WIDTH INCHES	THICKNESS INCHES	MAX BUNDLE DIA. IN.
6R-50-N-100	6.0	50 lbs	Natural	100	10000	.18	.06	1.5
6R-50-N-1000	6.0	50 lbs	Natural	1000	10000	.18	.06	1.5
8R-50-N-100	7.6	50 lbs	Natural	100	10000	.18	.06	1.9
8R-50-N-1000	7.6	50 lbs	Natural	1000	10000	.18	.06	1.9
11R-50-N-100	11.1	50 lbs	Natural	100	5000	.18	.06	3.0
11R-50-N-500	11.1	50 lbs	Natural	500	5000	.18	.06	3.0
14R-50-N-100	14.5	50 lbs	Natural	100	5000	.18	.06	4.0
14R-50-N-1000	14.5	50 lbs	Natural	1000	5000	.18	.06	4.0

## 50LB UV BLACK

CABLE TIE EXPRESS #	LENGTH INCHES	TENSILE STRENGTH	TIE COLOR	PACKAGE QUANTITY	CARTON QUANTITY	WIDTH INCHES	THICKNESS INCHES	MAX BUNDLE DIA. IN.
6R-50-UV-100	6.0	50 lbs	UV Black	100	10000	.18	.06	1.5
6R-50-UV-1000	6.0	50 lbs	UV Black	1000	10000	.18	.06	1.5
8R-50-UV-100	7.6	50 lbs	UV Black	100	10000	.18	.06	1.9
8R-50-UV-1000	7.6	50 lbs	UV Black	1000	10000	.18	.06	1.9
11R-50-UV-100	11.1	50 lbs	UV Black	100	5000	.18	.06	3.0
11R-50-UV-500	11.1	50 lbs	UV Black	500	5000	.18	.06	3.0
14R-50-UV-100	14.5	50 lbs	UV Black	100	5000	.18	.06	4.0
14R-50-UV-500	14.5	50 lbs	UV Black	500	5000	.18	.06	4.0

There are two designs for our Releasable Ties - "Releasable Pawl Ties" which have an extended thumb tab and "Releasable Tab Ties" which have a longer vertical tab feature.

Find the option just right for your application requirements.





## 50LB NATURAL

CABLE TIE EXPRESS #	LENGTH INCHES	TENSILE STRENGTH	TIE COLOR	PACKAGE QUANTITY	CARTON QUANTITY	WIDTH INCHES	THICKNESS INCHES	MAX BUNDLE DIA. IN.
4RT-50-N-100	4.0	50 lbs	Natural	100	20000	.30	.05	1.1
4RT-50-N-1000	4.0	50 lbs	Natural	1000	20000	.30	.05	1.1
6RT-50-N-100	6.0	50 lbs	Natural	100	10000	.30	.05	1.4
6RT-50-N-1000	6.0	50 lbs	Natural	1000	10000	.30	.05	1.4
8RT-50-N-100	8.0	50 lbs	Natural	100	5000	.30	.05	2.0
8RT-50-N-1000	8.0	50 lbs	Natural	1000	5000	.30	.05	2.0
11RT-50-N-100	11.9	50 lbs	Natural	100	5000	.30	.05	3.1
11RT-50-N-500	11.9	50 lbs	Natural	500	5000	.30	.05	3.1
14RT-50-N-100	14.6	50 lbs	Natural	100	2500	.30	.05	4.0
14RT-50-N-500	14.6	50 lbs	Natural	500	2500	.30	.05	4.0

## 50LB UV BLACK

CABLE TIE EXPRESS #	LENGTH INCHES	TENSILE STRENGTH	TIE COLOR	PACKAGE QUANTITY	CARTON QUANTITY	WIDTH INCHES	THICKNESS INCHES	MAX BUNDLE DIA. IN.
4RT-50-UV-100	4.0	50 lbs	UV Black	100	20000	.30	.05	1.1
4RT-50-UV-1000	4.0	50 lbs	UV Black	1000	20000	.30	.05	1.1
6RT-50-UV-100	6.0	50 lbs	UV Black	100	10000	.30	.05	1.4
6RT-50-UV-1000	6.0	50 lbs	UV Black	1000	10000	.30	.05	1.4
8RT-50-UV-100	8.0	50 lbs	UV Black	100	5000	.30	.05	2.0
8RT-50-UV-1000	8.0	50 lbs	UV Black	1000	5000	.30	.05	2.0
11RT-50-UV-100	11.9	50 lbs	UV Black	100	5000	.30	.05	3.1
11RT-50-UV-500	11.9	50 lbs	UV Black	500	5000	.30	.05	3.1
14RT-50-UV-100	14.6	50 lbs	UV Black	100	2500	.30	.05	4.0
14RT-50-UV-500	14.6	50 lbs	UV Black	500	2500	.30	.05	4.0

# sharp tail ties

## 50LB UV BLACK

CABLE TIE EXPRESS #	LENGTH INCHES	TENSILE STRENGTH	TIE COLOR	PACKAGE QUANTITY	CARTON QUANTITY	WIDTH INCHES	THICKNESS INCHES	MAX BUNDLE DIA. IN.
7ST-50-UV-1000	7.5	50 lbs	UV Black	1000	10000	.19	.06	2.0

Sharp Tail Ties are designed to penetrate through various materials with ease.

# solar rated ties

## 50LB UV BLACK

CABLE TIE EXPRESS #	LENGTH INCHES	TENSILE STRENGTH	TIE COLOR	PACKAGE QUANTITY	CARTON QUANTITY	WIDTH INCHES
8-50-UV47H-100	7.6	50 lbs	UV Black	100	10000	.18
11-50-UV47H-100	11.1	50 lbs	UV Black	100	5000	.18
14-50-UV47H-100	14.6	50 lbs	UV Black	100	5000	.18

## 120LB UV BLACK

CABLE TIE EXPRESS #	LENGTH INCHES	TENSILE STRENGTH	TIE COLOR	PACKAGE QUANTITY	CARTON QUANTITY	WIDTH INCHES
14-120-UV47H-100	15.0	120 lbs	UV Black	100	2000	.30

### *Special formulation to meet the latest solar environmental applications*

- \* Excellent moisture and chemical resistance
- \* Designed to withstand stress cracking
- \* Smooth edges help against abrasion damage
- \* Ideal for various steel surface contact
- \* Extended 12-15 year UV protection





## 150LB UNCOATED

CABLE TIE EXPRESS #	LENGTH INCHES	TENSILE STRENGTH	TIE FINISH	PACKAGE QUANTITY	WIDTH INCHES	THICKNESS INCHES	MAX BUNDLE DIA. IN.
6S6-150-100	6.0	150 lbs	316 Stainless	100	.18	.01	1.0
8S6-150-100	7.9	150 lbs	316 Stainless	100	.18	.01	2.0
10S6-150-100	10.2	150 lbs	316 Stainless	100	.18	.01	2.7
14S6-150-100	14.3	150 lbs	316 Stainless	100	.18	.01	4.0
20S6-150-100	20.5	150 lbs	316 Stainless	100	.18	.01	6.0
27S6-150-100	26.8	150 lbs	316 Stainless	100	.18	.01	8.0

## 300LB UNCOATED

CABLE TIE EXPRESS #	LENGTH INCHES	TENSILE STRENGTH	TIE FINISH	PACKAGE QUANTITY	WIDTH INCHES	THICKNESS INCHES	MAX BUNDLE DIA. IN.
8S6-300-100	7.9	300 lbs	316 Stainless	100	.31	.01	2.0
10S6-300-100	10.2	300 lbs	316 Stainless	100	.31	.01	2.7
14S6-300-100	14.3	300 lbs	316 Stainless	100	.31	.01	4.0
20S6-300-100	20.5	300 lbs	316 Stainless	100	.31	.01	6.0
27S6-300-100	26.8	300 lbs	316 Stainless	100	.31	.01	8.0

## 150LB POLYESTER COATED

CABLE TIE EXPRESS #	LENGTH INCHES	TENSILE STRENGTH	TIE FINISH	PACKAGE QUANTITY	WIDTH INCHES	THICKNESS INCHES	MAX BUNDLE DIA. IN.
8SC6-150-100	7.9	150 lbs	Polyester Coated	100	.18	.01	2.0
14SC6-150-100	14.3	150 lbs	Polyester Coated	100	.18	.01	4.0
20SC6-150-100	20.5	150 lbs	Polyester Coated	100	.18	.01	6.0
27SC6-150-100	26.8	150 lbs	Polyester Coated	100	.18	.01	8.0

## 300LB POLYESTER COATED

CABLE TIE EXPRESS #	LENGTH INCHES	TENSILE STRENGTH	TIE FINISH	PACKAGE QUANTITY	WIDTH INCHES	THICKNESS INCHES	MAX BUNDLE DIA. IN.
8SC6-300-100	7.9	300 lbs	Polyester Coated	50	.31	.01	2.0
14SC6-300-100	14.3	300 lbs	Polyester Coated	50	.31	.01	4.0
20SC6-300-100	20.5	300 lbs	Polyester Coated	50	.31	.01	6.0
27SC6-300-100	26.8	300 lbs	Polyester Coated	50	.31	.01	8.0

# steel tooth ties

## 18LB

CABLE TIE EXPRESS #	LENGTH INCHES	TENSILE STRENGTH	TIE COLOR	PACKAGE QUANTITY	WIDTH INCHES	MAX BUNDLE DIA. IN.
4-18-N-ST	3.62	18 lbs	Natural	1000	.091	.0625
4-18-UV-ST	3.62	18 lbs	UV Black	1000	.091	.0625
8-18-N-ST	8.00	18 lbs	Natural	1000	.091	1.5
8-18-UV-ST	8.00	18 lbs	UV Black	1000	.091	1.5

## 40LB

CABLE TIE EXPRESS #	LENGTH INCHES	TENSILE STRENGTH	TIE COLOR	PACKAGE QUANTITY	WIDTH INCHES	MAX BUNDLE DIA. IN.
5-40-N-ST	5.50	40 lbs	Natural	1000	.140	1.125
5-40-UV-ST	5.50	40 lbs	UV Black	1000	.140	1.125

## 50LB

CABLE TIE EXPRESS #	LENGTH INCHES	TENSILE STRENGTH	TIE COLOR	PACKAGE QUANTITY	WIDTH INCHES	MAX BUNDLE DIA. IN.
7-50-N-ST	7.31	50 lbs	Natural	1000	.184	1.75
7-50-UV-ST	7.31	50 lbs	UV Black	1000	.184	1.75
11-50-N-ST	11.40	50 lbs	Natural	1000	.184	3.0
11-50-UV-ST	11.40	50 lbs	UV Black	1000	.184	3.0
14-50-N-ST	14.20	50 lbs	Natural	1000	.184	4.0
14-50-UV-ST	14.20	50 lbs	UV Black	1000	.184	4.0

## 120LB

CABLE TIE EXPRESS #	LENGTH INCHES	TENSILE STRENGTH	TIE COLOR	PACKAGE QUANTITY	WIDTH INCHES	MAX BUNDLE DIA. IN.
13-120-N-ST	13.40	120 lbs	Natural	500	.270	3.5
13-120-UV-ST	13.40	120 lbs	UV Black	500	.270	3.5

Steel Tooth Ties have a non-magnetic stainless steel locking device in the head and a smooth body design that allows for the cable tie to be tightened to any size within the bundle diameter

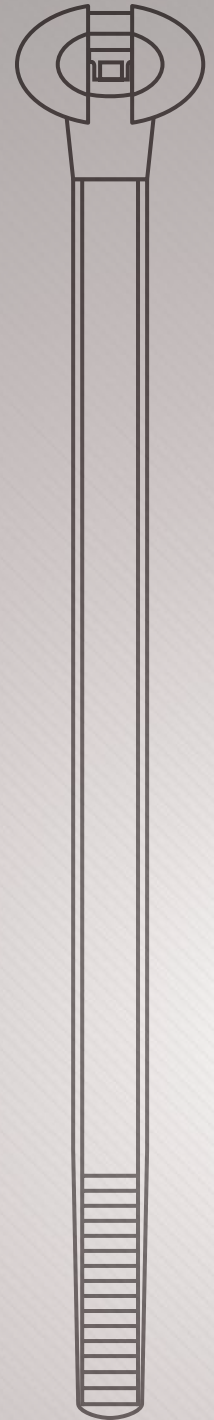





# CABLE TIE EXPRESS

TYING SERVICE TO QUALITY SINCE 1995

***clamping and  
bundling***



**clamping &  
bundling**

# adhesive mounting bases

## RUBBER ADHESIVE NATURAL - 4 WAY ENTRY

CABLE TIE EXPRESS #	LENGTH INCHES	WIDTH INCHES	BASE COLOR	PACKAGE QUANTITY	CARTON QUANTITY	CABLE TIE USE	MOUNT HOLE SIZE
1-5-N-100	.50	.50	Natural	100	10000	18 lb	N/A
1-1-N-100	.75	.75	Natural	100	10000	18-50 lb	2 / #6
1-2-N-100	1.00	1.00	Natural	100	5000	18-50 lb	1 / #10
1-3-N-100	1.50	1.50	Natural	100	2000	18-175 lb	4 / #10
1-4-N-100	2.00	2.00	Natural	100	1000	18-250 lb	5 / .25

## RUBBER ADHESIVE UV BLACK - 4 WAY ENTRY

CABLE TIE EXPRESS #	LENGTH INCHES	WIDTH INCHES	BASE COLOR	PACKAGE QUANTITY	CARTON QUANTITY	CABLE TIE USE	MOUNT HOLE SIZE
1-5-UV-100	.50	.50	UV Black	100	10000	18 lb	N/A
1-1-UV-100	.75	.75	UV Black	100	10000	18-50 lb	2 / #6
1-2-UV-100	1.00	1.00	UV Black	100	5000	18-50 lb	1 / #10
1-3-UV-100	1.50	1.50	UV Black	100	2000	18-175 lb	4 / #10
1-4-UV-100	2.00	2.00	UV Black	100	1000	18-250 lb	5 / .25

## RUBBER ADHESIVE - 2 WAY ENTRY

CABLE TIE EXPRESS #	LENGTH INCHES	WIDTH INCHES	BASE COLOR	PACKAGE QUANTITY	CARTON QUANTITY	CABLE TIE USE	MOUNT HOLE SIZE
1-2-N-2W-100	1.00	1.00	Natural	100	5000	18-50 lb	1 / #10
1-2-UV-2W-100	1.00	1.00	UV Black	100	5000	18-50 lb	1 / #10

## ACRYLIC ADHESIVE NATURAL - 4 WAY ENTRY

CABLE TIE EXPRESS #	LENGTH INCHES	WIDTH INCHES	BASE COLOR	PACKAGE QUANTITY	CARTON QUANTITY	CABLE TIE USE	MOUNT HOLE SIZE
1-1-NAC-100	.75	.75	Natural	100	10000	18-50 lb	1 / #4
1-2-NAC-100	1.00	1.00	Natural	100	5000	18-50 lb	1 / #6

## ACRYLIC ADHESIVE UV BLACK - 4 WAY ENTRY

CABLE TIE EXPRESS #	LENGTH INCHES	WIDTH INCHES	BASE COLOR	PACKAGE QUANTITY	CARTON QUANTITY	CABLE TIE USE	MOUNT HOLE SIZE
1-1-UVAC-100	.75	.75	UV Black	100	10000	18-50 lb	1 / #4
1-2-UVAC-100	1.00	1.00	UV Black	100	5000	18-50 lb	1 / #6

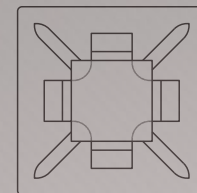

1-5-N-100  
1-5-UV-100

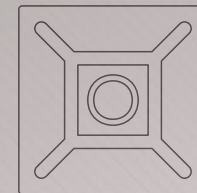

1-1-N-100  
1-1-UV-100

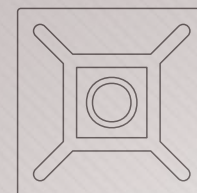

1-2-N-100  
1-2-UV-100

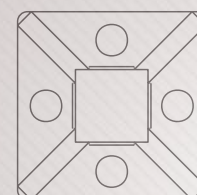

1-3-N-100  
1-3-UV-100

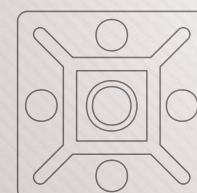

1-4-N-100  
1-4-UV-100

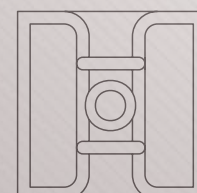

1-2-N-2W-100  
1-2-UV-2W-100

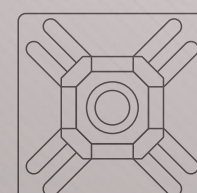

1-1-NAC-100  
1-2-NAC-100  
1-1-UVAC-100  
1-2-UVAC-100

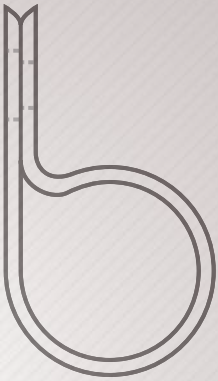
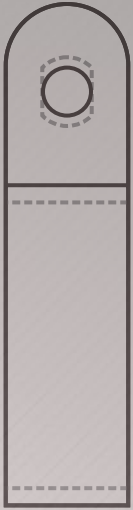

## NATURAL

CABLE TIE EXPRESS #	CLAMP DIA INCHES	CLAMP COLOR	PACKAGE QUANTITY	CARTON QUANTITY	WIDTH INCHES
CC-1/8-N-100	1/8"	Natural	100	10000	3/8"
CC-3/16-N-100	3/16"	Natural	100	10000	3/8"
CC-1/4-N-100	1/4"	Natural	100	10000	3/8"
CC-5/16-N-100	5/16"	Natural	100	10000	3/8"
CC-3/8-N-100	3/8"	Natural	100	10000	1/2"
CC-1/2-N-100	1/2"	Natural	100	5000	1/2"
CC-5/8-N-100	5/8"	Natural	100	5000	1/2"
CC-3/4-N-100	3/4"	Natural	100	5000	1/2"
CC-1-N-100	1"	Natural	100	5000	1/2"
CC-1 1/4-N-100	1 1/4"	Natural	100	2500	1/2"
CC-1 1/2-N-100	1 1/2"	Natural	100	2500	1/2"

## UV BLACK

CABLE TIE EXPRESS #	CLAMP DIA INCHES	CLAMP COLOR	PACKAGE QUANTITY	CARTON QUANTITY	WIDTH INCHES
CC-1/8-UV-100	1/8"	UV Black	100	10000	3/8"
CC-3/16-UV-100	3/16"	UV Black	100	10000	3/8"
CC-1/4-UV-100	1/4"	UV Black	100	10000	3/8"
CC-5/16-UV-100	5/16"	UV Black	100	10000	3/8"
CC-3/8-UV-100	3/8"	UV Black	100	10000	1/2"
CC-1/2-UV-100	1/2"	UV Black	100	5000	1/2"
CC-5/8-UV-100	5/8"	UV Black	100	5000	1/2"
CC-3/4-UV-100	3/4"	UV Black	100	5000	1/2"
CC-1-UV-100	1"	UV Black	100	5000	1/2"
CC-1 1/4-UV-100	1 1/4"	UV Black	100	2500	1/2"
CC-1 1/2-UV-100	1 1/2"	UV Black	100	2500	1/2"

# cradle mounts

## EXTERNAL NATURAL

CABLE TIE EXPRESS #	LENGTH INCHES	WIDTH INCHES	HEIGHT INCHES	BASE COLOR	PACKAGE QUANTITY	CABLE TIE USE	MOUNT HOLE SIZE
CME-6-N-100	.750	.375	.187	Natural	100	18-50 lb	#6
CME-10-N-100	.750	.375	.187	Natural	100	18-50 lb	#10

## EXTERNAL UV BLACK

CABLE TIE EXPRESS #	LENGTH INCHES	WIDTH INCHES	HEIGHT INCHES	BASE COLOR	PACKAGE QUANTITY	CABLE TIE USE	MOUNT HOLE SIZE
CME-6-UV-100	.750	.375	.187	UV Black	100	18-50 lb	#6
CME-10-UV-100	.750	.375	.187	UV Black	100	18-50 lb	#10

## INTERNAL NATURAL

CABLE TIE EXPRESS #	LENGTH INCHES	WIDTH INCHES	HEIGHT INCHES	BASE COLOR	PACKAGE QUANTITY	CABLE TIE USE	MOUNT HOLE SIZE
CMI-6-N-100	.625	.375	.250	Natural	100	18-50 lb	#6
CMI-10-N-100	.875	.625	.375	Natural	100	18-175 lb	#10
CMI-14-N-100	.875	.625	.375	Natural	100	18-175 lb	.250

## INTERNAL UV BLACK

CABLE TIE EXPRESS #	LENGTH INCHES	WIDTH INCHES	HEIGHT INCHES	BASE COLOR	PACKAGE QUANTITY	CABLE TIE USE	MOUNT HOLE SIZE
CMI-6-UV-100	.625	.375	.250	UV Black	100	18-50 lb	#6
CMI-10-UV-100	.875	.625	.375	UV Black	100	18-175 lb	#10
CMI-14-UV-100	.875	.625	.375	UV Black	100	18-175 lb	.250



*We strive to stock a wide selection of cable tie styles and sizes in order to offer a 'one-stop solution' - enabling you to consolidate vendors for ease of ordering.*

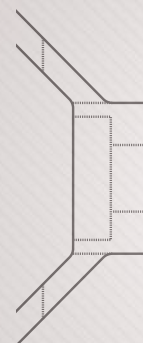
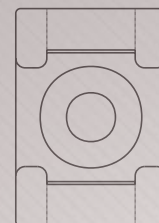

## NATURAL - POLYETHYLENE

CABLE TIE EXPRESS #	INSIDE DIA. INCHES	OUTSIDE DIA. INCHES	BUNDLE RANGE INCHES	SPOOL QUANTITY
SW-1/8-N-100	.125	.177	5/16 - 1/2	100 FT
SW-3/16-N-100	.197	.244	5/16 - 1/2	100 FT
SW-1/4-N-100	.236	.315	1/2 - 2 5/16	100 FT
SW-5/16-N-100	.354	.472	3/4 - 2 3/4	100 FT
SW-1/2-N-100	.472	.590	3/4 - 2 3/4	100 FT
SW-3/4-N-100	.787	.945	3/4 - 5	100 FT

## BLACK - POLYETHYLENE

CABLE TIE EXPRESS #	INSIDE DIA. INCHES	OUTSIDE DIA. INCHES	BUNDLE RANGE INCHES	SPOOL QUANTITY
SW-1/8-B-100	.125	.177	5/16 - 1/2	100 FT
SW-3/16-B-100	.197	.244	5/16 - 1/2	100 FT
SW-1/4-B-100	.236	.315	1/2 - 2 5/16	100 FT
SW-5/16-B-100	.354	.472	3/4 - 2 3/4	100 FT
SW-1/2-B-100	.472	.590	3/4 - 2 3/4	100 FT
SW-3/4-B-100	.787	.945	3/4 - 5	100 FT

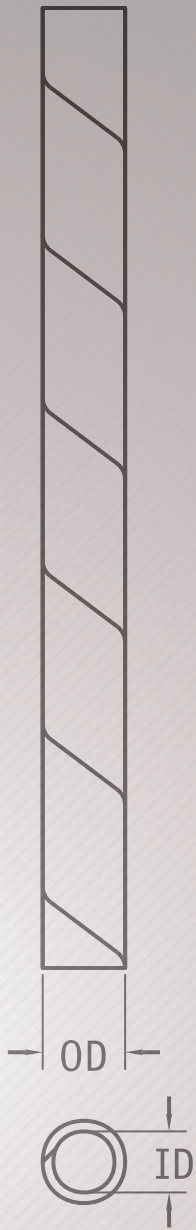

Spiral Wrap, available on spools, is durable and reusable, allowing breakout of single or multiple wires and rerouting of replacement wires.

***Additional colors available upon request. Contact us for your specific requirements***

# split loom

## SPLIT LOOM

CABLE TIE EXPRESS #	SIZE INCHES	A INCHES	B INCHES	C INCHES	SPOOL QUANTITY
SL-025-B-100	.250	.291	.402	.102	100 FT
SL-038-B-100	.375	.421	.630	.130	100 FT
SL-050-B-100	.500	.543	.689	.122	100 FT
SL-063-B-100	.625	.591	.768	.138	100 FT
SL-075-B-100	.750	.760	.937	.138	100 FT
SL-100-B-100	1.00	.957	1.260	.142	100 FT
SL-125-B-100	1.25	1.228	1.575	.162	100 FT
SL-150-B-100	1.50	1.559	1.969	.191	100 FT
SL-200-B-100	2.00	2.047	2.362	.228	100 FT

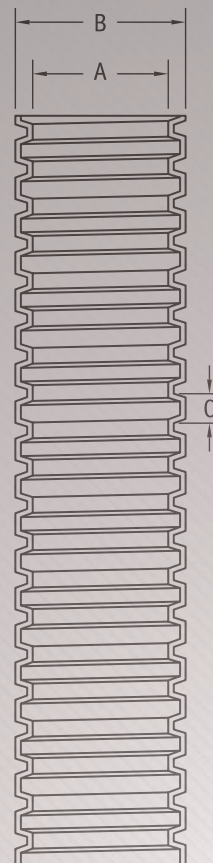
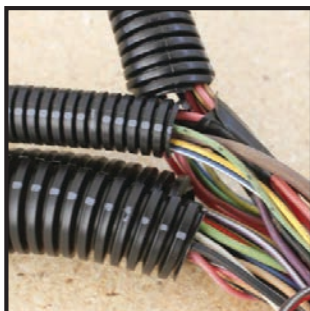

For applications where Spiral Wrap may not offer the amount of protection required, Split Loom, available in easy to handle 100' lengths, may be the product needed.



***Our highly experienced Sales Team are here to help with your specific requirements and ordering options. We will partner with you to achieve your goals.***



# CABLE TIE EXPRESS

TYING SERVICE TO QUALITY SINCE 1995

***wire  
connectors***



**wire  
connectors**

# wire connectors

## SCREW ON

CABLE TIE EXPRESS #	CONNECTOR TYPE	CONNECTOR COLOR	PACKAGE QUANTITY	WIRE RANGE MINIMUM	WIRE RANGE MAXIMUM
WC-GYS-100	Screw On	Grey	100	1#20+1#22	2#16
WC-GYS-1000	Screw On	Grey	1000	1#20+1#22	2#16
WC-BE-100	Screw On	Blue	100	3#20	3#16+1#18
WC-BE-1000	Screw On	Blue	1000	3#20	3#16+1#18
WC-OE-100	Screw On	Orange	100	3#20	3#16+1#18
WC-OE-500	Screw On	Orange	500	3#20	3#16+1#18
WC-YW-100	Screw On	Yellow	100	1#14+1#18	4#14+1#18
WC-YW-500	Screw On	Yellow	500	1#14+1#18	4#14+1#18
WC-RD-100	Screw On	Red	100	2#14	2#10+2#12
WC-RD-500	Screw On	Red	500	2#14	2#10+2#12

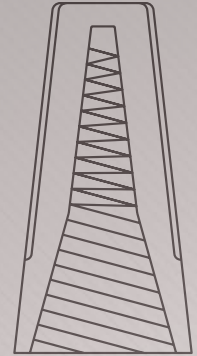

## WING TWIST ON

CABLE TIE EXPRESS #	CONNECTOR TYPE	CONNECTOR COLOR	PACKAGE QUANTITY	WIRE RANGE MINIMUM	WIRE RANGE MAXIMUM
WCW-YW-100	Wing	Yellow	100	2#18	3#12
WCW-YW-500	Wing	Yellow	500	2#18	3#12
WCW-RD-100	Wing	Red	100	2#14	4#10
WCW-RD-500	Wing	Red	500	2#14	4#10
WCW-GY-100	Wing	Grey	100	3#12	4#10
WCW-GY-250	Wing	Grey	250	3#12	4#10
WCW-BE-100	Wing	Blue	100	3#12	1#6+2#8
WCW-BE-250	Wing	Blue	250	3#12	1#6+2#8

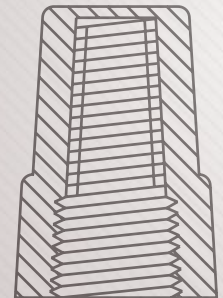

**Length, tensile strength, and bundle diameter – critical elements in determining the right tie for the application. Our part descriptions include them all.**





# CABLE TIE EXPRESS

TYING SERVICE TO QUALITY SINCE 1995



***installation  
tools***

installation  
tools

# installation tools

## INSTALLATION TOOLS

CABLE TIE EXPRESS #	TIE WIDTH INCHES	FOR TIE STRENGTHS	MATERIAL TYPE
TL-1	.09"-.19"	18-50 lbs	Disposable Plastic
TL-2	.09"-.19"	18-50 lbs	Steel
TL-3	.09"-.19"	18-50 lbs	Plastic
TL-4	.09"-.39"	18-175 lbs	Steel
TL-5	.09"-.51"	18-250 lbs	Steel



Setting tool choice will vary on an application to application basis, with tensile strength of ties being a key component. Call us for proper tool selection.

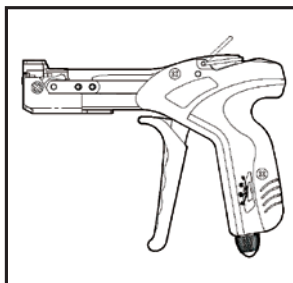

For Stainless Steel tie applications, we offer installation tools TL-6 and TL-8.

Contact us for more information regarding the specifications and availability of these products.



CABLE  
TIE  
EXPRESS

TYING SERVICE TO QUALITY SINCE 1995

***heat shrink  
tubing***

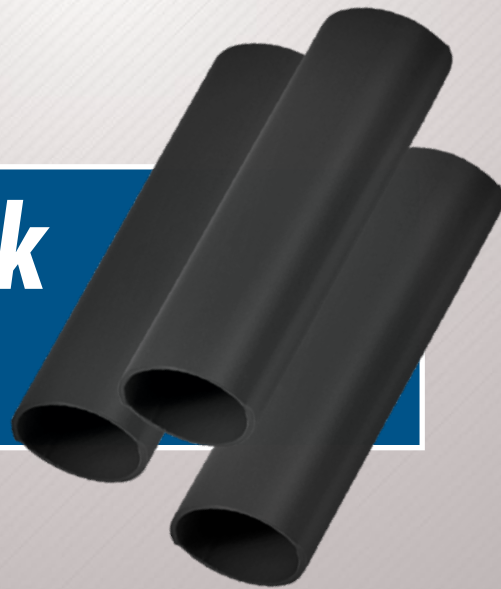

heat shrink  
tubing

# heat shrink tubing - thin wall

## TTWZ - HIGHLY FLAME RETARDANT - SHRINK RATIO 2:1

SIZE INCH	SUPPLIED MM		AFTER RECOVERED MM		STANDARD PACKAGING			
	INSIDE DIAMETER MIN	INSIDE DIAMETER MAX	WALL THICKNESS MIN	MINIATURE SPOOL (MS) LENGTH FEET	STANDARD SPOOL (SS) LENGTH FEET	BOX (BX) LENGTH FEET	CUT TO LENGTH (BG) QTY/BAG 6" 48"	
3/64	1.2	0.6	0.40	100	1000	50	40	25
1/16	1.6	0.8	0.40	100	1000	50	36	25
3/32	2.4	1.2	0.48	100	500	50	32	25
1/8	3.2	1.6	0.48	100	500	50	28	25
3/16	4.8	2.4	0.48	100	500	30	24	25
1/4	6.4	3.2	0.56	100	500	30	20	25
5/16	8.0	4.0	0.62	100	250	30	18	25
3/8	9.5	4.8	0.62	100	250	30	16	25
1/2	12.7	6.4	0.62	50	200	15	14	5
5/8	15.9	8.0	0.68	50	200	15	14	5
3/4	19.1	9.5	0.68	50	200	15	12	5
1	25.4	12.7	0.87	50	200	15	8	5
1 1/4	31.8	15.9	1.00	50	100	N/A	8	5
1 1/2	38.1	19.1	1.00	50	100	N/A	5	5
2	50.8	25.4	1.10	50	100	N/A	3	5
3	76.2	38.1	1.20	N/A	100	N/A	2	2
4	102.0	50.8	1.35	N/A	100	N/A	1	2
5	125.0	63.5	1.40	N/A	50	N/A	1	2
6	151.0	75.0	1.40	N/A	50	N/A	1	2

Provides both commercial and military applications electrical insulation and protects in-line components, disconnect terminals, and splices with its high strength and excellent resilience. Bundles wires for very flexible, light-duty harnesses. Identifies or color-codes wires, cables, terminals, and components.

- \* Operating temperature: -55°C to +135°C
- \* Minimum shrink temperature: 70°C
- \* Full recovery temperature: 100°C
- \* Approved UL File No. E236137, 125°C, VW-1, 600V
- \* RoHS Compliant
- \* Meets SAE-AMS-DTL-23053/5 Class 1 & 3 and Sony-SS-00259
- \* No PBB's, PBBO's, PBBE's, Free of Cadmium and Lead
- \* Available in Black, Red, Blue, Yellow, Green, White and Clear (Class 2)

# heat shrink tubing - dual wall

## TDWF-3 - DUAL WALL, ADHESIVE LINED, FLEXIBLE POLYOLEFIN SHRINK RATIO 3:1

SIZE INCH	SUPPLIED MM		AFTER RECOVERED MM		STANDARD PACKAGING		
	INSIDE DIAMETER MIN	INSIDE DIAMETER MAX	WALL THICKNESS MIN	ADHESIVE THICKNESS NOMINAL	STANDARD SPOOL (SS) LENGTH FEET	CUT TO LENGTH (BG) 6"	QTY/BAG 48"
1/8	3.0	1.0	1.00	0.5	200	28	25
3/16	4.8	1.5	1.00	0.5	100	24	25
1/4	6.0	2.0	1.00	0.5	100	20	25
3/8	9.0	3.0	1.40	0.6	50	16	24
1/2	12.0	4.0	1.60	0.8	25	14	5
3/4	19.0	6.0	2.15	0.8	25	12	5
1	24.0	8.0	2.40	1.0	25	8	5
1 1/4	30.0	10.0	2.40	1.0	25	5	5
1 1/2	40.0	13.0	2.40	1.0	25	5	5
2	50.0	19.0	2.40	1.0	25	3	5

Manufactured by co-extrusion of polyolefin and meltable adhesive, it is designed to provide insulation and create a tight seal for protected articles. Typical applications are environmental sealing of electrical components such as wire splices and harnesses in the automotive and communication industries.

- \* Operating temperature: -45°C to +125°C
  - \* Minimum shrink temperature: 80°C
  - \* Full recovery temperature: 120°C
  - \* Approved UL File No. E236137
  - \* RoHS Compliant
  - \* Meets SAE-AMS-DTL-23053/4 and Sony SS-00259
  - \* Standard color is Black
  - \* Special colors available: Red, Blue, White, Yellow and Clear (non-flame retardant jacket)
- Contact us for availability.



***We can cross reference our competitors' part numbers. Give us a call with your current specifications and we will be happy to do it for you - saving you the time and effort.***





# CABLE TIE EXPRESS

TYING SERVICE TO QUALITY SINCE 1995

***reference  
material***



reference  
material

# moisture content of ties

## **Cable tie performance is directly related to the moisture content of the ties.**

Nylon 6/6 is the material of choice for cable ties for many reasons. With a very high strength to weight ratio, this material is noted for its toughness, impact strength, resistance to abrasion and chemicals, wide temperature range, and versatility in a variety of applications. Nylon 6/6 is a naturally hygroscopic material – it absorbs and releases moisture depending on its environment.

When first produced, cable ties contain nearly zero per cent moisture. At this point, the ties are at their greatest tensile strength but may also be brittle and lack toughness. If exposed to air for an extended period of time, the tie will naturally absorb water. However, this can take several weeks. Where the average relative humidity is about 60%, a normal condition in the United States, the tie will reach about 3% moisture. Figure A of the graph below indicates how relative humidity affects the amount of moisture.

Manufacturers of cable ties, however, want the ties to reach an optimal condition quickly so a measured quantity of water (2-3% by weight) is added during the packaging process. Following the addition of this moisture, it takes about three weeks for the desired level of absorption to take place for optimal performance. Resulting from this procedure is a fine balance between tensile strength and toughness. Figure B of the graph below highlights how the tensile strength decreases with increased moisture and further emphasizes the value of a 2-3% moisture content for cable ties (in this case, this relationship is illustrated for a standard 50 lb tie).

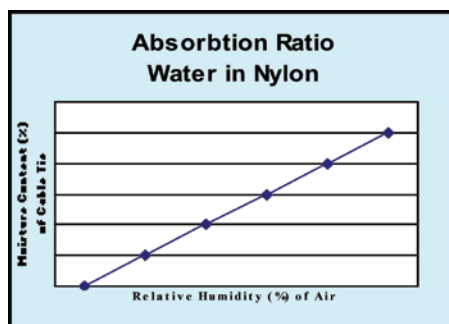

**Figure A – Absorption Ratio**

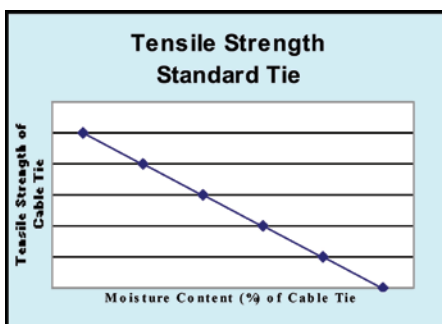

**Figure B – Tensile Strength**

When examining concerns regarding the performance of cable ties, it is clearly evident that moisture is often the issue. Following the recommendations below will minimize this issue and maximize performance.

- [1] Bags of ties should be used in a timely manner or remain sealed until required for application. Bags left open result in ties drying out, becoming brittle, and perhaps breaking.
- [2] Proper quantity per bag should be purchased – bulk bags are ideal for higher volume usage while smaller bags are recommended for low volume requirements.
- [3] A first in first out inventory policy, as we do at Cable Tie Express, is recommended.
- [4] Special attention regarding usage and storage environments is recommended during times of the year when extreme temperatures exist.

We hope this information is helpful in your understanding of cable ties and their performance. We provide this to you in keeping with our Mission Statement - to be the most responsive, dependable, and knowledgeable provider of superior quality cable ties and associated products.

**Please contact the Sales Professionals at Cable Tie Express for further information.**



# performance & safe handling

## ***Cable tie performance and recommendations for handling, storage, purchase and use of cable tie products.***

Cable ties are most frequently manufactured of Nylon 6/6, the material of choice for many reasons. With a very high strength to weight ratio, this material is noted for its toughness, impact strength, resistance to abrasion and chemicals, wide temperature range, and versatility in a variety of applications.

Nylon 6/6 is a naturally hygroscopic material – it absorbs and releases moisture depending on its environment. It is important to understand that cable tie performance is directly related to the moisture content of cable ties. Manufacturers of cable ties produce ties with a water content of approximately 2.5% - 3% which enables proper performance levels to be achieved. These products are sealed in packaging to ensure that the water content in the material remains constant. Please refer to our Moisture Content Information Page for additional information on this relationship.

In order for the purchaser and user of cable ties to maximize performance levels of the product, following are recommendations for the storage, handling, purchase and use of cable tie products:

### ***Storage and Handling Conditions***

- [1] Ideal storage conditions are 70 °F and 50% relative humidity. Cable ties should not be stored in an unheated warehouse. Shelf life can be reduced by temperature and humidity extremes.
- [2] Cable ties should remain packaged in the manufacturer's original sealed bags until ready for use. Any break or hole in the bag can lead to dryness and resulting brittleness of ties. Keeping bags sealed until use should also be followed in bin stocking applications with bags opened and bins filled only after bin is empty of ties.
- [3] A First In/First Out inventory method is recommended.
- [4] Partial cable tie bags should be closed or sealed if at all possible.

### ***Purchase of Cable Ties***

- [1] Cable ties should be purchased with proper length, strength, and bundle diameter to meet requirements of the application.
- [2] Bags should be purchased in quantities (bulk or smaller packages) to meet application requirements. Bulk bags are ideal for higher volume usage while smaller bags are recommended for lower volume applications.
- [3] Cable ties should be purchased as needed to meet application requirements. It is recommended that no more than 1-3 months usage be purchased at a time. Blanket order purchasing with flexibility in release dates is recommended, allowing adjustment to demand fluctuations, ensuring fresh product, and enabling the supplier to secure inventory in a timely fashion.

### ***Use of Cable Ties***

- [1] Careful evaluation of the application requirements should be made to ensure that ties with the proper length, strength, and bundle diameter are obtained.
- [2] Cable ties should not be over tensioned when installing. Over tensioning actually weakens the tie. Once installed, the possibility of breakage is virtually minimized.

We hope this information is helpful in your understanding of cable ties and their performance. We provide this to you in keeping with our Mission Statement - to be the most responsive, dependable, and knowledgeable provider of superior quality cable ties and associated products.

***Please contact the Sales Professionals at Cable Tie Express for further information.***



## ORDER POLICY

- [1] Acceptable Payment Terms: Net 30 Days, Visa, MasterCard, American Express, COD, CIA and Wire Transfer.
- [2] All Payments must be in U.S. Currency.
- [3] There is a \$50.00 order minimum and a \$5.00 line minimum.
- [4] Please allow up to two weeks for any custom orders. This includes colors, packaging and labeling.
- [5] All orders are F.O.B. Cable Tie Express shipping locations.
- [6] There will be a \$50.00 fee applied to any non-standard product documentation.
- [7] Cable Tie Express will not be responsible for any air freight due to customer errors. All air freight orders must be confirmed via fax or email prior to shipment.
- [8] Cable Tie Express will not be responsible for any International Customs charges which include but are not limited to taxes, duties, tariffs, brokerage fees, storage fees, and freight charges. Unless otherwise specified, UPS brokerage service will be used on all UPS Shipments.
- [9] ALL PRICES AND POLICIES ARE SUBJECT TO CHANGE WITHOUT NOTICE.
- [10] Invoice Late Fees & Interest Charge:
  - [10.1] Interest accrues from the invoice due date.
  - [10.2] Cable Tie Express reserves the right to put a hold on any account past due.
  - [10.3] Checks returned unpaid are subject to the maximum fees allowed.

## RETURN POLICY

- [1] No returns will be accepted unless accompanied with a written Return Material Authorization (RMA) from the manufacturing facility.
- [2] All requests for returns must be made within 60 Days of the purchase date.
- [3] All returns are subject to a 15-35% restocking fee.
- [4] All returns must be in original package and sealed bags to be considered for credit.
- [5] No returns accepted on the following:
  - [5.1] Special package products
  - [5.2] Private labeled products
  - [5.3] Custom colors
  - [5.4] Hot stamp orders

MINIATURE TIES  
INTERMEDIATE TIES  
STANDARD TIES  
HEAVY DUTY TIES  
EXTRA HEAVY DUTY TIES  
ULTRA HEAVY DUTY TIES  
BEADED TIES  
COLD WEATHER TIES  
COLORED TIES  
CUSTOM PRINTED TIES  
DOUBLE LOOP TIES  
FIR TREE PUSH MOUNT TIES  
HEAT STABILIZED TIES  
IDENTIFICATION TIES  
EZ-OFF™ TIES  
LADDER TIES  
METAL DETECTABLE TIES  
MIL-SPEC TIES  
MOUNTING HOLE TIES  
PLENUM TIES  
PUSH MOUNT TIES  
RELEASABLE TIES - PAWL  
RELEASABLE TIES - TAB  
SHARP TAIL TIES  
SOLAR RATED TIES  
STAINLESS STEEL TIES  
STEEL TOOTH TIES  
ADHESIVE MOUNTING BASES  
CABLE CLAMPS  
CRADLE MOUNTS  
SPIRAL WRAP  
SPLIT LOOM  
WIRE CONNECTORS  
INSTALLATION TOOLS  
HEAT SHRINK TUBING

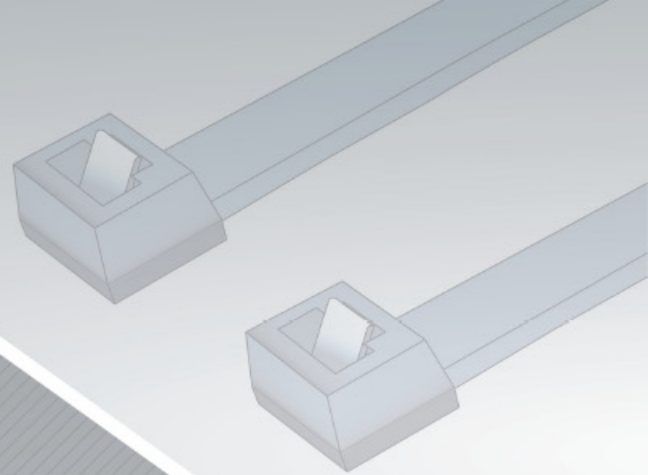

CABLE  
TIE  
EXPRESS

PROUDLY CELEBRATING

TYING SERVICE TO QUALITY SINCE 1995



2019-01

15470 ENDEAVOR DRIVE, SUITE 100  
NOBLESVILLE, IN 46060

TEL: 888.603.1233 · FAX: 800.395.1233  
SALES@CABLETIEEXPRESS.COM

[www.CABLETIEEXPRESS.com](http://www.CABLETIEEXPRESS.com)

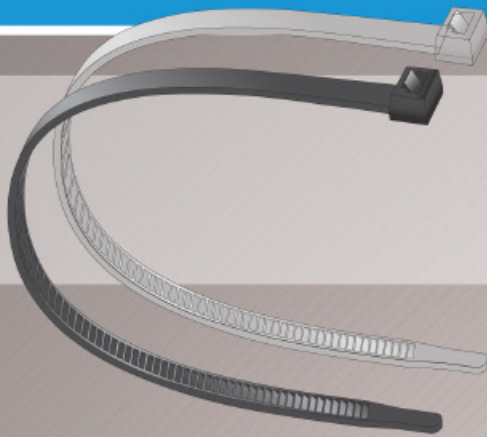

# REPRESENTATIVE AND SHIPPING LOCATIONS

Cable Tie Express has an extensive network of representatives to ensure that all of our customers are aided with the best possible service. Representative coverage areas are shown in the map below.

**Contact us if you need more information about your local representative.**

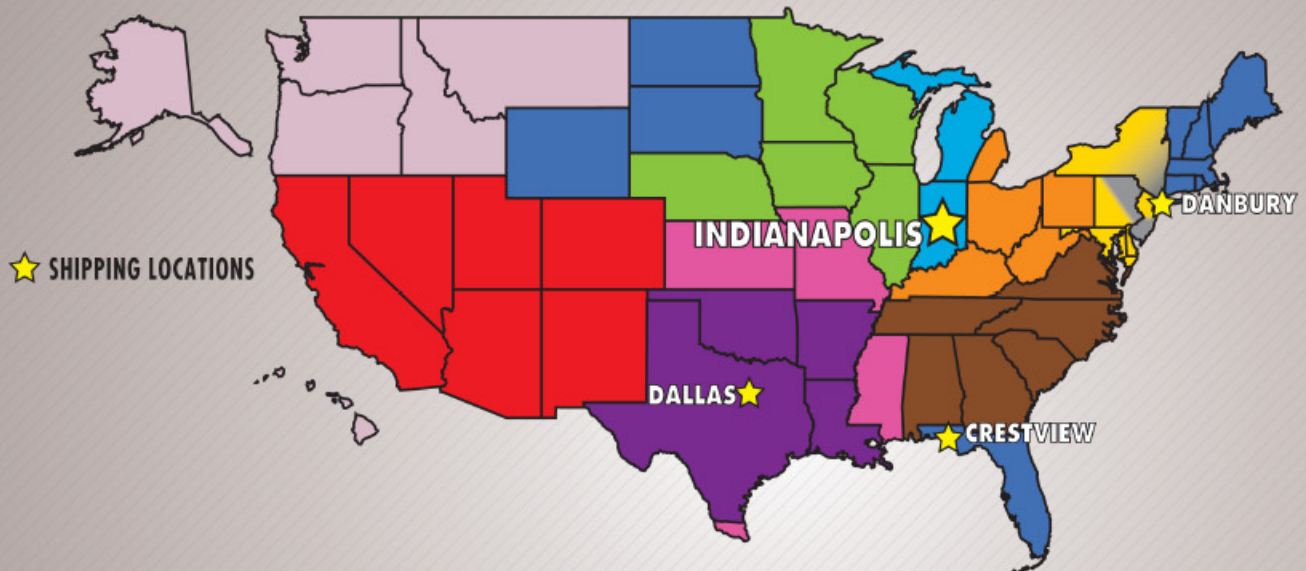

Cable Tie Express recognizes the value of being active and participating members of trade associations within the markets of its network of distribution.

**Cable Tie Express is a member of the following trade associations:**

