



CONSTRUCTION
ELECTRICAL
PRODUCTS

Distributed by: BEST MATERIALS ®

Ph: 800-474-7570, 602-272-8128 Fax: 602-272-8014
www.BestMaterials.com Email: Sales@BestMaterials.com

Distributing Power and Light



Construction
Industry
Rentals
Government and Military
Entertainment

Product Catalog



|| *When we started Construction Electrical Products in 1976, I never could have imagined the growth we have experienced. Thank you with a deep appreciation and gratitude to you our users, distributors, OEM partners and sales reps. Our team is ready and able to serve you – Founders, Bob & Nancy Larrabee* ||

Power Distribution & Lighting Solutions – Construction Electrical Products (CEP) is an industry leader in manufacturing Temporary Power Distribution and Portable Lighting, serving the Construction and Industrial markets for more than 35 years.

In addition to our domestic manufacturing, CEP is also an importer, assembler and reseller of a wide variety of specialty electrical products such as: Extension Cords, Light Strings, GFCIs and Wiring Devices. CEP's extensive offering allows our distributors to support the electrical needs of contractors from the beginning phases of the job to the end. We cover the full spectrum of products from low cost, low end to high quality, high end.

CEP prides itself in the value and support it offers distributors. Encompassing 25 Independent Rep firms, CEP operates 12 warehouses across the United States and Canada. That means CEP products are close to most construction and industrial markets.

One of CEP's greatest strengths is our ability to react quickly to the special needs of customers. Our in-house engineering and Custom UL 1640 manufacturing program allow us to build to spec for specific applications to meet the product needs of customers so they can complete the job safely and efficiently.



Corporate Offices
7800 Las Positas Road
Livermore, CA 94551

800.678.3470
sales@cepnw.com
CEPnow.com



Table of Contents

Single-Phase Power Distribution Boxes	4	Electrical Accessories	18
<ul style="list-style-type: none"> ▶ Traditional 6-Outlet Boxes ▶ Mini-Centers and 4 Outlet Boxes ▶ Barricade Boxes Wall Mounted 8000-Series ▶ 4- or 6-Outlet 50-Amp Rugged Power Distribution Boxes, 6000 Series ▶ Booster Box 		<ul style="list-style-type: none"> ▶ Cable Crossovers & Protection ▶ Power Supply Cords ▶ Power Blocks ▶ Booster Cables ▶ Professional Power Strips 	
3-Phase Power Distribution	8	Ground Fault Circuit Interrupters (GFCI's)	19
<ul style="list-style-type: none"> ▶ 3-Phase Power Distribution Boxes ▶ 3-Phase Power Distribution Panels 		<ul style="list-style-type: none"> ▶ Inline and Right Angle GFCI Extension Cords ▶ GFCI Plugs and Attachables ▶ GFCI Multi-Outlet Boxes 	
3-Phase Transformer Power Stations	10	Wiring Devices	21
Temporary Power Cables	11	Portable Lighting	24
<ul style="list-style-type: none"> ▶ 50-Amp and 30-Amp 125/250V 3P 4W Adapters ▶ NEMA Configurations ▶ California Style and IEC60309 Configurations ▶ CAM-Type Configurations 		<ul style="list-style-type: none"> ▶ Hand Carry & Stand Units ▶ Battery-Powered Units ▶ Tower Units ▶ High-Bay Fixtures ▶ Light Stringers ▶ Quartz Lights & Trouble Lights ▶ Bulbs 	
Extension Cords	14	Technical Help	34
<ul style="list-style-type: none"> ▶ GlowFlex U-Ground 15A 125V Cords ▶ Extreme All Weather ▶ Twist-Lock 20A 125V NEMA L5-20 Cords ▶ Extreme Twist-Lock 20A 125V NEMA L5-20 Cords ▶ Rubber Twist-Lock 20A 125V NEMA L5-20 Cords 		Temp Power Compliance and Safety Guide	35
Temporary Power Cable Adapters	17		
<ul style="list-style-type: none"> ▶ Pigtail, 'Y' and 'W' Adapters ▶ Cord Control System 			

Limited Warranty and Return Policy

Limited Warranty

Construction Electrical Products, hereafter referred to as CEP, warrants all its products to be free from defects in material and workmanship for a period of one hundred eighty (180) days or one year from the manufacture date, whichever occurs first. **CEP will repair or replace product without charge provided the conditions of the warranty are met.** This warranty does not cover damage to the product caused by accident, misuse, and/or improperly applied voltage, neglect, or abuse, including altering construction, or damage in transit.

CEP agrees to repair or replace all products which are determined to be defective upon factory inspection, and are within one hundred eighty (180) days of purchase, or one year from the manufacture date, whichever occurs first.

No products shall be accepted for return or replacement without the written authorization from CEP. **CEP does not accept products that were used, are obsolete, custom product, or considered unsellable.** Upon such authorization, and in accordance with instructions from CEP, the product will be returned to the company, shipping charges prepaid by customer.

CEP will not be liable for any incidental or consequential damages of any kind whether based upon warranty contract or negligence, and arising in connection with the sale, use or repair of the product.

This warranty does not extend to or apply to any unit from which the identification has been removed or altered.

Circuit breakers shall bear only that warranty made by the manufacturer of that product. *Note: Failure associated with transient power surges, which permanently deactivate GFCI circuit breakers, are not covered by the manufacturer's warranty.*

Return Good Authorization (RGA) Policy

All returns to CEP must have an RGA number and form provided by CEP.

For incorrectly ordered items or general returns, the customer is responsible for all freight. CEP reserves the right to charge a restocking fee up to 20% and/or freight charges depending upon the items being returned. Contact CEP for additional details. **CEP does not accept products that were used, are obsolete, custom product, or considered unsellable.**

For all repairs, the buyer is responsible for shipping charges, unless otherwise stated, for both warranty or non-warranty issues. For items considered warranty repairs, standard shipping costs back to the customer for the repaired items is covered at no charge, and expedited charges are the responsibility of the customer.

Single-Phase Power Distribution Boxes

Traditional 6-Outlet Boxes

When you need power at your jobsite, go with the industry's leader in temporary power. Engineered utilizing the latest in GFCI technology, CEP's iconic yellow temporary power boxes have been providing contractors, electricians, and engineers with the highest level of electrical safety for over 35 years. They are cULus Listed Type 3R for outdoor use and designed to stand up to the toughest of jobsite conditions. Each unit has been carefully assembled to provide the ultimate in electrical safety as well as meeting current OSHA standards.

Features & Benefits

- ▶ 14 Ga. Steel or Stainless-Steel Construction endures for years of use
- ▶ Heavy-duty, impact & flame-resistant enclosure
- ▶ GFCI Protection includes open neutral, reverse phasing, & 240V shut-off with indicator light
- ▶ Rugged, Wrap-Around Frame option adds extra durability
- ▶ GFCI meets UL 943 requirements with 4-6 milliamp trip level, <25 milliseconds trip time
- ▶ 50-Amp 125/250V 3 Pole 4 Wire
- ▶ Power Inlet CS6375, Power Outlet CS6369
- ▶ 7-Outlet configurations, 6 x 125V 20-Amp GFCI Protected, 1 x 240V 30-Amp

Pairs With

- ▶ 6606GUSF-254/256 for 3-Phase Power Distribution. Page 8
- ▶ 6212DC and 6220CC for 3-Phase Power Distribution. Page 9
- ▶ 6450S/M/MC and 6400S/M/MC cables for input and output power. Page 11
- ▶ 1035 and 1030 cables for L6-30 receptacle. Page 12



Classic 6506





Rugged 8706



Classic Stainless 7506

NEMA 3R



Output Config.	Cat. No.	Description	Receptacles	Construction	Weight
 5-20 'U-Ground'	6506GU*	Classic - Legs	6 x NEMA 5-20 GFCI Protected, 1 x NEMA L6-30	Powder Coated Steel	36 Lb.
	8706GU*	Rugged - Frame		Powder Coated Steel	34 Lb.
	7506GU*	Classic - Legs		Heavy-Duty Stainless Steel	29 Lb.
	7706GU*	Rugged - Frame		Heavy-Duty Stainless Steel	28 Lb.
 L5-20 'Twist-Lock'	6506G	Classic - Legs	6 x NEMA L5-20 GFCI Protected, 1 x NEMA L6-30	Powder Coated Steel	36 Lb.
	8706G	Rugged - Frame		Powder Coated Steel	34 Lb.
	7506G	Classic - Legs		Heavy-Duty Stainless Steel	35 Lb.
	7706G	Rugged - Frame		Heavy-Duty Stainless Steel	34 Lb.

*Duplex Configurations Available



25kw Generator



Up to 100 Ft. 50A Power Cord



6506G-GU



8706G-GU



Extension Cords

REPLACEMENT PARTS AVAILABLE

Single-Phase Power Distribution Boxes

Mini-Centers and 4 Outlet Boxes

Features & Benefits

- 14 Ga. Steel endures for years of use
- Heavy-duty, impact & flame-resistant enclosure
- GFCI Protection includes open neutral, reverse phasing, & 240V shut-off with indicator light
- Outdoor and Indoor-Rated Options allow application based choices without extra cost
- GFCI meets UL 943 requirements with 4-6 milliamp trip level, <25 milliseconds trip time
- 30-Amp and 50-Amp 125/250V 3 Pole 4 Wire
- 4-Outlet configurations, 6 x 125V 20-Amp GFCI Protected

Pairs With

- 6606GUSF-254/256 for 3-Phase Power Distribution. Page 8
- 6212DC and 6220CC for 3-Phase Power Distribution for 6508. Page 9
- 6450S/M/MC and 6400S/M/MC cables for input power for 6508. Page 11
- 6606GUF-554/556 for Single-Phase Power Distribution for 6507 & 6503. Page 7
- 6415 and 6410 cables for input power for 6507 & 6503. Page 12
- 6606GUF-544/546 for Single-Phase Power Distribution for 6502. Page 7
- 6413 and 6411 cables for input power for 6502. Page 12

NEMA 3R





6508G



6507GU



6503GU

Output Config.	Cat. No.	Description	Rating	Power Input	Receptacles	Weight
 5-20 'U-Ground'	6507GU	Classic 4 Outlet,	30A	L-14-30	4x NEMA 5-20 GFCI Protected Duplex	30 Lb.
	6508GU	NEMA Type 3R	50A	CS6365 Tail	4x NEMA 5-20 GFCI Protected Duplex	32 Lb.
	6504GU*	Outdoor, 4-Circuit	50A	CS6375 Inlet	4x NEMA 5-20 GFCI Protected, 1x NEMA L6-30	32 Lb.
	6502GU	Mini-Center, Dry	20A	L14-20	4x NEMA 5-20 GFCI Protected Duplex	15 Lb.
	6503GU	Location, 2-Circuit	30A	L14-30	4x NEMA 5-20 GFCI Protected Duplex	14 Lb.
 L5-20 'Twist-Lock'	6507G	Classic 4 Outlet,	30A	L14-30	4x NEMA L5-20 GFCI Protected	30 Lb.
	6508G	NEMA Type 3R	50A	CS6365 Tail	4x NEMA L5-20 GFCI Protected	32 Lb.
	6504G	Outdoor, 4-Circuit	50A	CS6375 Inlet	4x NEMA L5-20 GFCI Protected, 1x NEMA L6-30	32 Lb.
	6502GTL	Mini-Center, Dry	20A	L14-20	4x NEMA L5-20 GFCI Protected	14 Lb.
	6503GTL	Location, 2-Circuit	30A	L14-30	4x NEMA L5-20 GFCI Protected	14 Lb.

*Duplex Configurations Available



5kw-10kw Generator



Up to 100 Ft. 30A Power Cord



6503G-GTL



6507G-GU

Power Distribution Boxes

REPLACEMENT PARTS AVAILABLE

Single-Phase Power Distribution Boxes

Barricade Boxes, Wall Mounted 8000-Series

Engineered using the latest in GFCI Technology, and providing the user with the highest level of Electrical Safety, CEP's newest line of wall-mounted Barricade Boxes is an innovation for the construction industry. With OSHA mandating that cords, cables, and hoses be removed from the floor, the Barricade Box gives the user a perfect solution while keeping the outdoor rating of the product. The box is UL Listed for Outdoor Use and required to mount off the floor away from water, dust, mud and other harmful environmental elements, with both 6-circuit and 8-circuit versions available, with or without rugged frame.



8806GUF



8806G

Features & Benefits



- ▶ Meets the current OSHA standards for Electrical Safety and can help meet their latest standard to reduce tripping hazards
- ▶ 14 Ga. Steel or Stainless-Steel Construction endures for years of use
- ▶ Heavy-duty, impact & flame-resistant enclosure
- ▶ Rugged, Wrap-Around Frame option adds extra durability
- ▶ GFCI Protection includes open neutral, reverse phasing, & 240V shut-off with indicator light
- ▶ GFCI meets UL 943 requirements with 4-6 milliamp trip level, <25 milliseconds trip time
- ▶ 50-Amp 125/250V 3 Pole 4 Wire
- ▶ 6-Outlet, 7-Outlet, and 9-Outlet configurations available

Pairs With

- ▶ 6606GUSF-254/256 for 3-Phase Power Distribution. Page 8
- ▶ 6212DC and 6220CC for 3-Phase Power Distribution. Page 9
- ▶ 6450S/M/MC and 6400S/M/MC cables for input and output power. Page 11
- ▶ 1035 and 1030 cables for L6-30 receptacle. Page 12

NEMA 3R



Output Config.	Cat. No.	Rugged Frame	20-Amp GFCI Receptacles	30-Amp 250V L6-30 Receptacle	Weight
 5-20 'U-Ground'	8806GU	No	6	Yes	43 Lb.
	8806GU-2	No	6	No	30 Lb.
	8806GUF	Yes	6	Yes	47 Lb.
	8806GUF-2	Yes	6	No	35 Lb.
	8808GU	No	8	Yes	36 Lb.
	8808GUF	Yes	8	Yes	43 Lb.
 L5-20 'Twist-Lock'	8806G	No	6	Yes	43 Lb.
	8806G-2	No	6	No	30 Lb.
	8806GF	Yes	6	Yes	47 Lb.
	8806GF-2	Yes	6	No	38 Lb.
	8808G	No	8	Yes	32 Lb.
	8808GF	Yes	8	Yes	32 Lb.

REPLACEMENT PARTS AVAILABLE

Single-Phase Power Distribution Boxes

4- or 6-Outlet 50-Amp Rugged Power Distribution Boxes, 6600 Series



Features & Benefits

- ▶ Powers additional Temporary Power Boxes, or plugs directly into Single-Phase Systems
- ▶ 14 Ga. Steel or Stainless-Steel Construction endures for years of use
- ▶ Heavy-duty, impact & flame-resistant enclosure
- ▶ 125/250V 3 Pole 4 Wire to 4- or 6- outlet configurations

Pairs With

- ▶ 6606GUSF-254/256 for 3-Phase Power Distribution. Page 8
- ▶ 6212DC and 6220CC for 3-Phase Power Distribution. Page 9
- ▶ 6450S/M/MC and 6400S/M/MC cables for input power. Page 11
- ▶ Cables for output power. Page 12



6606GUF-554

NEMA 3R



Cat. No.	Rating	Feed-Through	Power Inlet	Receptacles	Weight
6606GUF-524	50A 125/250V	Yes - CS6369	CS6375	4 x NEMA L6-20	35 Lb.
6606GUF-526	50A 125/250V	No	CS6375	6 x NEMA L6-20	35 Lb.
6606GUF-534	50A 125/250V	Yes - CS6369	CS6375	4 x NEMA L6-30	35 Lb.
6606GUF-536	50A 125/250V	No	CS6375	6 x NEMA L6-30	35 Lb.
6606GUF-544	50A 125/250V	Yes - CS6369	CS6375	4 x NEMA L14-20	35 Lb.
6606GUF-546	50A 125/250V	No	CS6375	6 x NEMA L14-20	35 Lb.
6606GUF-554	50A 125/250V	Yes - CS6369	CS6375	4 x NEMA L14-30	35 Lb.
6606GUF-556	50A 125/250V	No	CS6375	6 x NEMA L14-30	35 Lb.

Booster Box

CEP's Booster Box allows your temporary power run to be extended beyond the recommended 300-feet. Adding an approximate 15% voltage boost, the booster box prevents damage to tool and equipment, as well as circuit breaker nuisance caused by low voltage situations.

Features & Benefits

- ▶ Inlet: 50A 125/250V CS 6375
- ▶ Receptacle: 50A 125/250V CS 6369
- ▶ 12 kVA 130-degree Rise transformer
- ▶ Approximate 15% Voltage Boost



6700

Cat. No.	Description	Receptacles	Construction	Dimensions In.	Weight
6700*	1 12kVA Booster Transformer	CS63 Series	Powder Coated Steel	18W x 24L x 18H	55 Lb.

*No NTRL Approval

REPLACEMENT PARTS AVAILABLE

3-Phase Power Distribution

3-Phase Power Distribution Boxes

CEP's heavy duty rugged specialty boxes are made to enable easy connection of temporary power boxes to a larger power source, such as a generator or transformer. They can also be used for tools, heaters, chillers, de-humidifiers, welders, and any type of equipment up to 250V AC. All CEP's Three-Phase Power boxes are UL 1640 Type 3R Outdoor-Rated, and may be custom configured to meet the needs of specific user applications. Please contact us for any modifications required. These boxes are available in either stainless steel with Legs or Rugged Frame.



6606GUSF-256

Features & Benefits

- ▶ 14 Ga. Stainless-Steel Construction endures for years of use
- ▶ Heavy-duty, impact & flame-resistant enclosure
- ▶ Rugged, Wrap-Around Frame adds extra durability

Pairs With

- ▶ 6450S/M/MC and 6400S/M/MC cables for output power. Page 11
- ▶ CAM-Type Power Distribution Boxes Cable Selections. Page 13

NEMA 3R



Cat. No.	Power Inlet	Rating	Feed-Through	Receptacles	Weight
6606GUSF-254	Series 16	200A 120/208V	Yes	4 x CS6369 125/250V 50A 3P4W	45 Lb.
6606GUSF-256	CAM-Type	200A 120/208V	No	6 x CS6369 125/250V 50A 3P4W	45 Lb.
6606GUSF-304	Devices	200A 120/208V	Yes	4 x L21-20 120/208V 20A 4P5W	45 Lb.



Customization Available



REPLACEMENT PARTS AVAILABLE

3-Phase Power Distribution

3-Phase Power Distribution Panels

Our Distribution Panels are designed to act as the feeder to smaller temporary power boxes, or are wired for powering large equipment. Either a larger three phase generator or other source may power them. All of CEP's Three-Phase Power panels are UL 1640 Type 3R Outdoor-Rated, and may be custom configured to meet the needs of specific user applications. Please contact us for any modifications required.

Features & Benefits

- ▶ 16 Ga. Stainless-Steel Construction endures for years of use
- ▶ Clear Breaker panel window allows instant visibility on circuit status
- ▶ Easily stackable heavy-duty cart allows for compact storage yet fast mobility
- ▶ Lifting Rings allow for fast access to hook into a lift and relocate where it is needed
- ▶ Heavy-duty, impact & flame-resistant enclosure
- ▶ **All 120/208V Product is Listed for use in the USA and Canada**
- ▶ **Up to 600-Amp, 480V UL Listed. 600V Configurations available**

NEMA 3R



6210DC



6220CC

120/208 Volt Offerings

Cat. No.	Rating	Type	NEMA 5-20 GFCI Protected Duplex Receptacle Qty.	Additional Output Receptacles
6210DC	120/208V 100-Amp	Direct Wire, 2/5 Type W, 15 Ft.	10	2 x NEMA L6-30R
6211DC			2	4 x NEMA L21-20R
6212DC			2	4 x CS6369 125/250V 50A 3P4W
6220CC	120/208V	Series 16 CAM-Type Devices	2	2 x NEMA L6-30R, 6 x CS6369 125/250V 50A 3P4W
6221CC	200-Amp		2	8 x NEMA L21-20R
6240CC	120/208V	Series 16 CAM-Type Devices	N/A	6 x 560P9W 120/208V 60A 4P5W
6241CC	400-Amp		N/A	4 x 5100R9W 120/208V 100A 4P5W

480 Volt Offerings, Also Available in 600 Volt Offerings

Cat. No.	Rating and Input Type	Main Breaker	Receptacles
992H3XX-1A	480V 3P4W 100A Direct Wire, 2/5 Type W, 15 Ft.	No	6 x NEMA L16-20
992H3XX-1B		No	6 x NEMA L16-30
992H3XX-1C		No	4 x CS8169 480V 50A 3P4W
992H3XX-1D		No	4 x 460RS2W 480V 60A 3P4W
992H3XX-A	480V 3P4W 250A Series 16 CAM-Type Devices	No	6 x 460R7W 480V 60A 3P4W IEC60309
992H3XX-B		Yes	6 x 460R7W 480V 60A 3P4W IEC60309
992H3XX-C		No	6 x NEMA L16-30
992H3XX-D		No	6 x NEMA L16-20
992H3XX-E		No	6 x CS8169 480V 50A 3P4W

REPLACEMENT PARTS AVAILABLE

3-Phase Transformer Power Stations

CEP's line of Transformer Power Stations combine all the features of the 3 Phase Power Distribution Panels with an on-board 480V or 600V Delta/Wye Transformer. These units allow an easy and quick connection of a portable power system to a higher voltage system, without having to purchase or rent an additional generator or power line. CEP offers both 2-wheel and 4-wheel Power Carts that are designed to break down 3-phase 480V Delta power into, 208V 3 phase, 250V single phase, or 125V power. The power supply input may be a direct wire feed, 60A or 100A pin and sleeve, or a CAM-Type device. These are available in 100, 200 or 400-amp configurations. Most applications are 480V 3-Phase Delta service to 120/208V 3-Phase Wye Service, but many different options are available and may be custom configured to meet the needs of specific user applications. Please contact our sales team at sales@cepnw.com for any modifications required.



6210PDC15-2



6210PDC45

Features & Benefits

- ▶ 16 Ga. Stainless-Steel Construction endures for years of use
- ▶ UL Listed Type 3R Outdoor Rating for up to 480V, 400-Amp
- ▶ Clear Breaker panel window allows instant visibility on circuit status
- ▶ Heavy-duty cart allows for compact storage yet fast mobility
- ▶ Lifting Rings allow for fast access to hook into a lift and relocate where it is needed
- ▶ Heavy-duty, impact & flame-resistant enclosure
- ▶ **Up to 600-Amp, 600V UL Listed Configurations available. Built to CSA Standards with either 480 Volt or 600 Volt transformers upon request** 🇨🇦

NEMA 3R



Cat. No.	Cart Type	Panel No. from Page 9	Transformer Type	Transformer	Primary Disconnect	Secondary Main Breaker
6210PDC15	4-Wheel	6210	480V 3P4W to 120/208V 4P5W	15KVA	30A	50A
6212PDC15	4-Wheel	6212	480V 3P4W to 120/208V 4P5W	15KVA	30A	50A
6210PDC15-2	2-Wheel	6210	480V 3P4W to 120/208V 4P5W	15KVA	30A	50A
6212PDC15-2	2-Wheel	6212	480V 3P4W to 120/208V 4P5W	15KVA	30A	50A
6210PDC30	4-Wheel	6210	480V 3P4W to 120/208V 4P5W	30KVA	60A	100A
6212PDC30	4-Wheel	6212	480V 3P4W to 120/208V 4P5W	30KVA	60A	100A
6210PDC30-2	2-Wheel	6210	480V 3P4W to 120/208V 4P5W	30KVA	60A	100A
6212PDC30-2	2-Wheel	6212	480V 3P4W to 120/208V 4P5W	30KVA	60A	100A
6210PDC45-2	2-Wheel	6210	480V 3P4W to 120/208V 4P5W	45KVA	60A	125A
6212PDC45-2	2-Wheel	6212	480V 3P4W to 120/208V 4P5W	45KVA	60A	125A
6212PDC45	4-Wheel	6212	480V 3P4W to 120/208V 4P5W	45KVA	60A	125A
6220PDC45	4-Wheel	6220	480V 3P4W to 120/208V 4P5W	45KVA	60A	125A
6220PDC75	4-Wheel	6220	480V 3P4W to 120/208V 4P5W	75KVA	90A	200A
6221PDC75	4-Wheel	6221	480V 3P4W to 120/208V 4P5W	75KVA	90A	200A
6240PDC150	4-Wheel	6240	480V 3P4W to 120/208V 4P5W	150KVA	400A	NONE
6241PDC150	4-Wheel	6241	480V 3P4W to 120/208V 4P5W	150KVA	400A	NONE
6210PDC15-1	2-Wheel	6210	480V 3P4W to 125/250V 3P4W Dry-Type Single Phase	15KVA	30A	60A
6210PDC25-1	2-Wheel	6210		25KVA	60A	100A
6212PDC25-1	2-Wheel	6212		25KVA	60A	100A
6210PDC15-1E	2-Wheel	6210	480V 3P4W to 125/250V	15KVA	30A	60A
6210PDC25-1E	2-Wheel	6210	3P4W NEMA 4X Encapsulated	25KVA	60A	100A
6212PDC25-1E	2-Wheel	6212	Single Phase	25KVA	60A	100A

REPLACEMENT PARTS AVAILABLE

Temporary Power Cables

CEP offers 3 different varieties of temporary power cables for our 50-Amp 125/250V temporary power boxes. CEP's unique design of rubber alloy STOW cable is the perfect solution to connect your temporary power boxes. Composed of 3-#6 AWG conductors and 1 smaller, #8 conductor for ground, the STOW cables are more cost effective and lighter in weight due to less copper than the typical #6 AWG, 4-conductor SOOW offering.

Features & Benefits

- ▶ Type 'S' cords use MSHA Approved STOW Industrial Duty rubber alloy providing rugged solution without the price
- ▶ -M cords use MSHA Approved SOOW Rubber for years of zero compliance issues
- ▶ -MC use UL and cUL Listed STOW Heavy-Duty Rubber Alloy cable for years of usage and zero compliance issues
- ▶ Cordsets have federal specification (WC596) grade plug and connectors
- ▶ Excellent resistance to oil and moisture
- ▶ High flexibility, excellent abrasion resistance
- ▶ Customization and labeling services available



6450S



Cat. No.	Connector/ NEMA	Length	Voltage	Amps	Poles	Wires	Gauge / No. of Conductors	Type	Jacket
6450S	CS63 Series	50 Ft.	125/250V	50	3	4	6/3-8/1	STOW	Rubber Alloy
6450M	CS63 Series	50 Ft.	125/250V	50	3	4	6/3-8/1	SOW	Rubber
6450MC*	CS63 Series	50 Ft.	125/250V	50	3	4	6/3-8/1	STOW	UL/cUL Rubber Alloy
6400S	CS63 Series	100 Ft.	125/250V	50	3	4	6/3-8/1	STOW	Rubber Alloy
6400M	CS63 Series	100 Ft.	125/250V	50	3	4	6/3-8/1	SOW	Rubber
6400MC*	CS63 Series	100 Ft.	125/250V	50	3	4	6/3-8/1	STOW	UL/cUL Rubber Alloy

🍁 *Made With cULus Approved STOW Cable

50-Amp and 30-Amp 125/250V 3P 4W Adapters



6408M



6404M



6409M

Cat. No.	Male Input Device	Female Output Devices
6404M	CS6365 125/250V 50A 3P4W Locking	2 x CS6364 125/250V 50A 3P4W Locking
6406M	CS6365 125/250V 50A 3P4W Locking	NEMA L14-30 125/250V 30A 3P4W Locking
6407M	CS6365 125/250V 50A 3P4W Locking	NEMA L14-20 125/250V 20A 3P4W Locking
6408M	NEMA 14-30 125/250V 30A 3P4W Straight	CS6364 125/250V 50A 3P4W Locking
6409M	NEMA 14-50 125/250V 50A 3P4W Straight	CS6364 125/250V 50A 3P4W Locking
6408MC*	NEMA 14-30 125/250V 30A 3P4W Straight	CS6364 125/250V 50A 3P4W Locking
6409MC*	NEMA 14-50 125/250V 50A 3P4W Straight	CS6364 125/250V 50A 3P4W Locking

🍁 *Made With cULus Approved STOW Cable

Temporary Power Cables

NEMA Configurations

CEP offers the broadest range of temporary power cords available on the market. We have the ability to assemble power cords with any configuration of wiring device, size, and length of cord. The power cords are used as a transition from your primary power source (such as: transformer, generator, facility power) into our Single Phase and 3-Phase Power Distribution Units. The cords can also be personalized with your name and logo through our custom cord labeling procedure.

Features & Benefits

- ▶ Heavy-Duty Rubber, Industrial Duty, Type SOOW cable for years of usage and zero compliance issues
- ▶ Cordsets have federal specification (WC596) grade plug and connectors
- ▶ Excellent resistance to oil and moisture
- ▶ High flexibility, excellent abrasion resistance



Cat. No.	Connector NEMA	Length	Voltage	Amps	Poles	Wires	Gauge / No. of Conductors	Weight
3105	5-15	50 Ft.	125	15	2	3	10/3	24
3101	5-15	100 Ft.	125	15	2	3	10/3	39
3205	5-15	50 Ft.	125	15	2	3	12/3	21
3201	5-15	100 Ft.	125	15	2	3	12/3	32
1235	L5-20	50 Ft.	125	20	2	3	12/3	21
1230	L5-20	100 Ft.	125	20	2	3	12/3	32
1005	L5-30	50 Ft.	125	30	2	3	10/3	24
1001	L5-30	100 Ft.	125	30	2	3	10/3	39
1225	L6-20	50 Ft.	250	20	2	3	12/3	21
1220	L6-20	100 Ft.	250	20	2	3	12/3	32
1035	L6-30	50 Ft.	250	30	2	3	10/3	24
1030	L6-30	100 Ft.	250	30	2	3	10/3	39
6416	L14-20	50 Ft.	125/250	20	3	4	10/4	28
6411	L14-20	100 Ft.	125/250	20	3	4	10/4	45
6413	L14-20	50 Ft.	125/250	20	3	4	12/4	24
6412	L14-20	100 Ft.	125/250	20	3	4	12/4	38
6415	L14-30	50 Ft.	125/250	30	3	4	10/4	28
6410	L14-30	100 Ft.	125/250	30	3	4	10/4	45
1250	L21-20	50 Ft.	120/208	20	4	5	12/5	26
1251	L21-20	100 Ft.	120/208	20	4	5	12/5	43
1050	L21-30	50 Ft.	120/208	30	4	5	10/5	31
1051	L21-30	100 Ft.	120/208	30	4	5	10/5	52
1245	L15-20	50 Ft.	250	20	3	4	12/4	24
1240	L15-20	100 Ft.	250	20	3	4	12/4	38
1045	L15-30	50 Ft.	250	30	3	4	10/4	28
1040	L15-30	100 Ft.	250	30	3	4	10/4	45
1246	L16-20	50 Ft.	480	20	3	4	12/4	24
1241	L16-20	100 Ft.	480	20	3	4	12/4	38
1046	L16-30	50 Ft.	480	30	3	4	10/4	28
1041	L16-30	100 Ft.	480	30	3	4	10/4	45

Temporary Power Cables

California Style and IEC60309 Configurations

Cat. No.	Device	Length	Voltage	Amps, Poles, Wires	Gauge and Cable Type
8105	CS81 Series	50 Ft.	480	50A 3P4W	6/3-8/1 Type SOOW Rubber
8100	CS81 Series	100 Ft.	480	50A 3P4W	6/3-8/1 Type SOOW Rubber
8305	CS83 Series	50 Ft.	250	50A 3P4W	6/3-8/1 Type SOOW Rubber
8300	CS83 Series	100 Ft.	250	50A 3P4W	6/3-8/1 Type SOOW Rubber
6645	460-12W	50 Ft.	125/250	60A 3P4W	8/4 Type W Rubber
6640	460-12W	100 Ft.	125/250	60A 3P4W	8/4 Type W Rubber
6646	4100-12W	50 Ft.	125/250	100A 3P4W	4/4 Type W Rubber
6641	4100-12W	100 Ft.	125/250	100A 3P4W	4/4 Type W Rubber
6647	460-7W	50 Ft.	480	60A 3P4W	8/4 Type W Rubber
6642	460-7W	100 Ft.	480	60A 3P4W	8/4 Type W Rubber
6648	4100-7W	50 Ft.	480	100A 3P4W	4/4 Type W Rubber
6643	4100-7W	100 Ft.	480	100A 3P4W	4/4 Type W Rubber
6655	560-9W	50 Ft.	120/208	60A 4P5W	6/5 Type W Rubber
6601	560-9W	100 Ft.	120/208	60A 4P5W	6/5 Type W Rubber
6650	5100-9W	50 Ft.	120/208	100A 4P5W	2/5 Type W Rubber
6600	5100-9W	100 Ft.	120/208	100A 4P5W	2/5 Type W Rubber



6647



8100



CAM-Type Configurations

Cat. No.	Gauge	Type	Rating	Length	Description	Approx Weight
6120	2/0	SC	200 AMP	100 Ft.	Extension	71
6120	2/0	W	200 AMP	100 Ft.	Extension	84
6125	2/0	SC	200 AMP	50 Ft.	Extension	46
6125	2/0	W	200 AMP	50 Ft.	Extension	52
61225	2/0	SC	200 AMP	25 Ft.	Extension	33
61225	2/0	W	200 AMP	25 Ft.	Extension	36
6121P	2/0	SC	200 AMP	10 Ft.	Female Tail	15
6121P	2/0	W	200 AMP	10 Ft.	Female Tail	16
6140	4/0	SC	400 AMP	100 Ft.	Extension	102
6140	4/0	W	400 AMP	100 Ft.	Extension	113
6145	4/0	SC	400 AMP	50 Ft.	Extension	61
6145	4/0	W	400 AMP	50 Ft.	Extension	67
61425	4/0	SC	400 AMP	25 Ft.	Extension	41
61425	4/0	W	400 AMP	25 Ft.	Extension	43
6141P	4/0	SC	400 AMP	10 Ft.	Female Tail	18
6141P	4/0	W	400 AMP	10 Ft.	Female Tail	19



6126SC-GR



To Order CAM-TYPE Cords: "Cat. No." + "Jacket" + "Color". Example: 6120WBK

REPLACEMENT PARTS AVAILABLE

Extension Cords

PowerFlex U-Ground 15A 125V NEMA 5-15 Cords

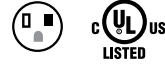

Features & Benefits

- ▶ Versatile, Water Resistant PVC Jacket rated to -31-degrees F
- ▶ No cable kinks, flaws in jacket, or cable lay issues will let the cable be used for years and years of being coiled and un-coiled
- ▶ Molded, Low Profile, tapered, snag-free ends
- ▶ Added webbed strain relief to prevent cracking and separations
- ▶ Available in a variety of colors
- ▶ Custom colors, cable surface printing or indenting is available upon request
- ▶ Triple-Tap options available*



1201

Gauge / No. of Conductors	Cat. No.	Length	Amps	Type	Color	Power Up Indicator	Box Count	Box Weight
10/3	1105	50 Ft.	15	SJTW	Yellow	No	2	24
10/3	1105R	50 Ft.	15	SJTW	Red	Yes	2	24
10/3	1101	100 Ft.	15	SJTW	Yellow	No	2	46
10/3	1101R	100 Ft.	15	SJTW	Red	Yes	2	46
12/3	1202	25 Ft.	15	SJTW	Yellow	No	6	20
12/3	1205	50 Ft.	15	SJTW	Yellow	No	6	42
12/3	1201	100 Ft.	15	SJTW	Yellow	No	4	60
12/3	1250	50 Ft.	15	STW	Yellow	No	4	42
12/3	1200	100 Ft.	15	STW	Yellow	No	2	42
12/3	1258*	50 Ft.	15	SJTW	Yellow	No	4	28
12/3	1218*	100 Ft.	15	SJTW	Yellow	No	2	26
12/3	1205BW	50 Ft.	15	SJTW	Blue/White Stripe	Yes	6	42
12/3	1205RW	50 Ft.	15	SJTW	Red/White Stripe	Yes	6	42
12/3	1205-WHITE	50 Ft.	15	SJTW	White	Yes	6	42
12/3	1205NG	50 Ft.	15	SJTW	Neon Green	Yes	6	42
12/3	1205NO	50 Ft.	15	SJTW	Neon Orange	Yes	6	42
12/3	1205NP	50 Ft.	15	SJTW	Neon Pink	Yes	6	42
12/3	1201BW	100 Ft.	15	SJTW	Blue/White Stripe	Yes	4	60
12/3	1201RW	100 Ft.	15	SJTW	Red/White Stripe	Yes	4	60
12/3	1201-WHITE	100 Ft.	15	SJTW	White	Yes	4	60
12/3	1201NG	100 Ft.	15	SJTW	Neon Green	Yes	4	60
12/3	1201NO	100 Ft.	15	SJTW	Neon Orange	Yes	4	60
12/3	1201NP	100 Ft.	15	SJTW	Neon Pink	Yes	4	60
14/3	1425	25 Ft.	13	SJTW	Orange	No	6	15
14/3	1450	50 Ft.	13	SJTW	Orange	No	6	30
14/3	1400	100 Ft.	13	SJTW	Orange	No	3	30
16/3	1625	25 Ft.	10	SJTW	Orange	No	12	25
16/3	1650	50 Ft.	10	SJTW	Orange	No	12	45
16/3	1600	100 Ft.	10	SJTW	Orange	No	6	45

Extension Cords

GlowFlex U-Ground 15A 125V NEMA 5-15 Cords



- Same features as PowerFlex
- Cords have a clear molded connector with indicator light to confirm your cord has power
- Triple-Tap*

Gauge	Cat. No.	Length	Amps	Type	Color	Receptacle Count	Box Count	Box Weight
12/3	2205	50 Ft.	15	SJTW	Yellow	1	6	44
12/3	2201	100 Ft.	15	SJTW	Yellow	1	4	54
12/3	2258*	50 Ft.	15	SJTW	Yellow	3	4	28
12/3	2218*	100 Ft.	15	SJTW	Yellow	3	2	27



2218

Extreme All Weather 15A 125V NEMA 5-15 Cords



- Construction Grade extension cord meant for the coldest and roughest environments
- Cold Weather Compound rated to -58-degrees F
- TPE Jacketing allows for soft, flexible cable that is easy to coil and uncoil
- Low Profile, tapered, snag-free ends
- Added webbed strain relief to prevent cracking and separations
- Cords have a clear molded connector with indicator light to confirm your cord has power
- Triple-Tap*



Gauge	Cat. No.	Length	Amps	Type	Color	Receptacle Count	Box Count	Box Weight
12/3	4202	25 Ft.	15	SJEOW	Blue	1	6	20
12/3	4205	50 Ft.	15	SJEOW	Blue	1	6	37
12/3	4201	100 Ft.	15	SJEOW	Blue	1	4	15
12/3	4258*	50 Ft.	15	SJEOW	Blue	3	4	26
12/3	4218*	100 Ft.	15	SJEOW	Blue	3	2	26



4201

PowerFlex Twist-Lock 20A 125V NEMA L5-20 Cords



- Versatile, Water Resistant PVC Jacket rated to -31-degrees F
- No cable kinks, flaws in jacket, or cable lay issues will let the cable be used for years and years of being coiled and un-coiled
- Low Profile, tapered, snag-free ends
- Added webbed strain relief to prevent cracking and separations
- Custom colors, cable imprinting, and labeling is available upon request

Gauge	Cat. No.	Length	Amps	Type	Color	Box Count	Box Weight
10/3	93101	100 Ft.	20	SJTW	Yellow	6	47
12/3	93185	50 Ft.	20	SJTW	Yellow	6	41
12/3	93181	100 Ft.	15	SJTW	Yellow	4	57
12/3	93155	50 Ft.	20	STW	Yellow	4	43
12/3	93151	100 Ft.	15	STW	Yellow	2	44



93181

Extension Cords

PowerFlex Extreme Twist-Lock 20A 125V NEMA L5-20 Cords



Features & Benefits

- Extra – Heavy Capacity, Construction Grade extension cord meant for the coldest and roughest environments
- Cold Weather Compound rated to -58-degrees F
- STOW Rubber-Alloy Jacketing allows for soft, flexible cable that is easy to coil and uncoil
- Low Profile, tapered, snag-free ends colored orange for visibility
- Added webbed strain relief to prevent cracking and separations



92181

Gauge	Cat. No.	Length	Amps	Type	Color	Box Count	Box Weight
12/3	92185	50 Ft.	20	SJTOW	Black	6	43
12/3	92181	100 Ft.	15	SJTOW	Black	4	54
12/3	92155	50 Ft.	20	STOW	Black	4	45
12/3	92151	100 Ft.	15	STOW	Black	2	43

PowerFlex Rubber Twist-Lock 20A 125V NEMA L5-20 Cords



Features & Benefits

- Extra – Heavy Capacity, Construction Grade extension cord meant for the coldest and roughest environments
- Cold Weather Compound rated to -58-degrees F
- Rubber Jacketing and ends make this the toughest NEMA L5-20 cable available



7395

Gauge	Cat. No.	Length	Amps	Type	Color	Box Count	Box Weight
12/3	7395	50 Ft.	20	SJOOW	Black	6	46
12/3	7391	100 Ft.	15	SJOOW	Black	4	61

REPLACEMENT PARTS AVAILABLE

Temporary Power Cable Adapters

Pigtail, 'Y' and 'W' Adapters





















1447



1480



1034

Cat. No.	Type	Length	Gauge / No. of Conductors / Type	Plug	Connector	
 	1447	Adapter	12 In.	12/3 STW	5-15P U-Ground	L5-20R Twist-Lock
 	1446	Adapter	12 In.	12/3 STW	L5-20P Twist-Lock	5-15R U-Ground
 	1473	Y Adapter	24 In.	12/3 STW	5-15P U-Ground	2 Ea. 5-15R U-Ground
 	1474	Y Adapter	24 In.	12/3 STW	L5-20P Twist-Lock	2 Ea. L5-20R Twist-Lock
	1476	Y Adapter	24 In.	12/3 STW	Blank Ends	Blank Ends
 	1479	W Adapter	24 In.	12/3 STW	5-15P U-Ground	3 Ea. 5-15R U-Ground
 	1480	W Adapter	24 In.	12/3 STW	L5-20P Twist-Lock	3 Ea. L5-20R Twist-Lock
 	1034	Y Adapter	24 In.	10/3 SOOW	L6-30P Twist-Lock	2 Ea. L6-30R Twist-Lock
 	1449	Tri-Tap Adapter	24 In.	12/3 STW	L5-20P Twist-Lock	3 Ea. 5-15R U-Ground
 	8312	Tri-Tap Adapter	24 In.	12/3 STW	5-15P U-Ground	3 Ea. 5-15R U-Ground

Cord Control System

Features & Benefits

- Keep jobsites safe and organized by suspending temporary power cords above the ground
- Cord Control systems fasten extension cords to strut or directly to a wall to reduce trip hazards
- Strut-Mounting system snaps in for easy installation
- Available in two sizes for temporary power and standard extension cords
- Non-Conductive
- Cable tie mounting port on the bottom for added security

Cat. No.	Description	Max Wire Gauge & Type
8197	Universal 2-Slot Cord Control (10-Pack)	6/4 SOOW
8198	Strut 2-Slot Cord Control (10-Pack)	6/4 SOOW
8199	Universal 4-Slot Extension Cord Control (each)	10/3 SOOW



8198

8199

REPLACEMENT PARTS AVAILABLE

Electrical Accessories



Cable Crossovers & Protection

Cat. No.	Description	Rating	Dimensions In.	Weight
3110	3 Ft. 5-Channel	40,000 Lbs. per Axle	20W x 36L x 2.31H	25 Lb.
3115	Set of Ends for PN# 3110	40,000 Lbs. per Axle	20W x 7.5 & 5.25L x 2.31H	3.5 Lb.
3111	3 Ft. 5-Channel	20,000 Lbs. per Axle	17.5W x 36L x 1.95H	18 Lb.
3116	Set of Ends for PN# 3111	20,000 Lbs. per Axle	17.5W x 4.7"L x 1.95H	2.7 Lb.



3110

Power Supply Cords

	Cat. No.	Length	Gauge	Type	Jacket	NEMA No.
	15367	8 Ft.	16/3	SJTW	Vinyl	5-15P
	15371	12 Ft.	16/3	SJTW	Vinyl	5-15P
	15228	50 Ft.	16/2	SJTW	Vinyl	1-15P
	15167	8 Ft.	16/3	SJTW	Vinyl	L5-20P
	15165	50 Ft.	16/3	SJTW	Vinyl	L5-20P
	15165S	50 Ft.	16/3	SJTOW	Rubber Alloy	L5-20P



15367

Power Blocks

	Cat. No.	Length	Plug	Connector
	8304	Block	5-15P	3 Ea. 5-15R
	8303	Block	5-15P	3 Ea. 5-15R
	1441	3 to 2 Wire	1-15P	5-15R



8304



8303

Booster Cables

Cat. No.	Length	Gauge	Type	Jacket	Color	Dimensions In.	Weight
8612	12 Ft.	6	SJTW	Vinyl	Red/Black	15W x 19L x 12H	30 Lb.
8416	16 Ft.	4	SJTW	Vinyl	Red/Black	11W x 14L x 5H	9 Lb.



8612

Professional Power Strips

- 15-Amp Breaker
- 6 Ft. 14-3 SJTW Cord
- 1050 Joules

Cat. No.	Receptacle Qty.	Material	Dimensions In.
8194	6	Plastic	8W x 15L x 13H
8195	6	HD Steel	12W x 17L x 12H
8196	12	HD Aluminium	8W x 48L x 8H



Ground Fault Circuit Interrupters (GFCI's)

Ground Fault Circuit Interrupters (GFCI's) are a safety device that are used to protect people. While mandated by OSHA and the NEC in certain locations, GFCI's are also a great idea to protect any individual. GFCI's protect people by sensing a ground fault due to a crossed wire, ground fault, or liquid fault.

Inline and Right Angle GFCI Extension Cords

Features & Benefits

- ▶ Provides a solution for GFCI protection when needed quickly
- ▶ All inline GFCI units have rain-proof protection
- ▶ Units have test/reset buttons and indicator light.
- ▶ UL Listed for Class-A Personnel Protection, OSHA Compliant, Jobsite Tested
- ▶ All GFCI inline and right-angle devices utilize manual reset GFCI's
- ▶ GFCI meets UL 943 requirements with 4-6 milliamp trip level, <25 milliseconds trip time
- ▶ All GFCI cords with a 15 Amp plug will have a 15 Amp rated assembly
- ▶ All cords have 12 AWG 3 Conductor cord, either STW or SJTW as noted



1430G50



















1440G50















1443G2

1444G2

NEMA 3R

Cat. No.		GFCI Type	Length	Jacket	Circuitry Rating	Plug	Connector	
		1440G2	Inline	2 Ft.	SJTW	15A/125V	5-15P U-Ground	3 Ea. 5-15R U-Ground
		1442G2	Inline	2 Ft.	STW	20A/125V	5-15P U-Ground	15R U-Ground
		1444G2	Inline	2 Ft.	STW	20A/125V	5-15P U-Ground	3 Ea. 5-15R U-Ground
		1445G2	Right Angle Plug	2 Ft.	SJTW	15A/125V	5-15P U-Ground	3 Ea. 5-15R U-Ground
		1242G2	Inline	2 Ft.	SJTW	20A/125V	5-15P U-Ground	15R U-Ground
		1244G2	Inline	2 Ft.	SJTW	20A/125V	5-15P U-Ground	3 Ea. 5-15R U-Ground
		1447G2	Inline	2 Ft.	STW	20A/125V	L5-20P Twist-Lock	15R U-Ground
		1446G2	Inline	2 Ft.	STW	20A/125V	5-15P U-Ground	L5-20R Twist-Lock
		1443G2	Inline	2 Ft.	STW	20A/125V	L5-20P Twist-Lock	L5-20R Twist-Lock

Cat. No.		GFCI Type	Length	Jacket	Circuitry Rating	Plug	Connector	
		1440G25	Inline	25 Ft.	SJTW	15A/125V	5-15P U-Ground	3 Ea. 5-15R U-Ground
		1440G50	Inline	50 Ft.	SJTW	15A/125V	5-15P U-Ground	3 Ea. 5-15R U-Ground
		1440G100	Inline	100 Ft.	SJTW	15A/125V	5-15P U-Ground	3 Ea. 5-15R U-Ground
		1430G25	Right Angle Plug	25 Ft.	SJTW	15A/125V	5-15P U-Ground	3 Ea. 5-15R U-Ground
		1430G50	Right Angle Plug	50 Ft.	SJTW	15A/125V	5-15P U-Ground	3 Ea. 5-15R U-Ground
		1430G100	Right Angle Plug	100 Ft.	SJTW	15A/125V	5-15P U-Ground	3 Ea. 5-15R U-Ground

Ground Fault Circuit Interrupters (GFCI's)

GFCI Plugs and Attachables

Features & Benefits

- ▶ Can be attached quickly to any power tool or used in a receptacle to add protection
- ▶ Can accept up to 12/3 Type SOOW wire
- ▶ Units have test/reset buttons
- ▶ cULus Listed, OSHA Compliant
- ▶ 15-Amp 125-Volt Rated

	Cat. No.	Device Rating	GFCI Type	Type
	1410G	15A/125V	Manual Reset	Plug
	1420G	15A/125V	Automatic Reset	Plug
	1430G	15A/125V	Manual Reset	Attachable
	1431G	15A/125V	Automatic Reset	Attachable



1410G

GFCI Multi-Outlet Boxes

Features & Benefits

- ▶ 2- or 4- outlet configurations, NEMA 5-20 or L5-20
- ▶ Units have test/reset buttons
- ▶ cULus Listed, OSHA Compliant
- ▶ Both 15-Amp and 20-Amp 125-Volt Options
- ▶ Made with 12/3 SJTW wire, 125V 15-Amp Rating

	Cat. No.	Length	Number of Outlets	Weight
	1460G6	6 Ft.	4 x NEMA 5-15R	2.25 Lb.
	1473G2	2 Ft.	4 x NEMA 5-15R	1 Lb.
	1475G2	2 Ft.	1 x NEMA L5-20R, 2 x NEMA 5-15R	3 Lb.
	1477G2	2 Ft.	2 x NEMA L5-20R	3 Lb.
	1473G2W	2 Ft.	4 x NEMA 5-15R Weatherproof Covers	3 Lb.
	1475G2W	2 Ft.	1x NEMA L5-20R, 2x NEMA 5-15R, with Weatherproof Covers	3 Lb.
	1477G2W	2 Ft.	2 x NEMA L5-20R Weatherproof Covers	3 Lb.



1477G2W



1460G6

REPLACEMENT PARTS AVAILABLE

Wiring Devices

CEP is committed to offering you the widest range of wiring devices on the market. Our devices range from 15-amp up to 400-amps in a variety of straight blade, locking, pin & sleeve, and CAM-Type configurations. This range of devices is manufactured for economy grade, commercial grade, and industrial grade applications. If you do not see the device or configuration needed, simply contact our sales team at sales@cepnw.com and we'll work to find a source.



515P



515C







CS6375



205R





SR50

NEMA	Cat. No.	Manufacturer	Voltage	Amps	Grade	Device Type
 1-15	9754NS	Bryant	125	15	Commercial	Plug
	9755NS	Bryant	125	15	Commercial	Connector
 5-15	515-P	CEP	125	15	Commercial	Plug
	4867	Cooper	125	15	Economy	Plug
	14P47	Woodhead	125	15	Industrial	Plug
	5266MA	Marinco	125	15	Industrial	Plug
	5266N	Bryant	125	15	Industrial	Plug
	14W47	Woodhead	125	15	Marine	Plug
	515-C	CEP	125	15	Commercial	Connector
	4887	Cooper	125	15	Economy	Connector
	15C47	Woodhead	125	15	Industrial	Connector
	5969B	Bryant	125	15	Industrial	Connector
	5269N	Bryant	125	15	Industrial	Connector
	5269MA	Marinco	125	15	Industrial	Connector
15W47	Woodhead	125	15	Marine	Connector	
 L5-15	4721N	Bryant	125	15	Industrial	Plug
	4720MA	Marinco	125	15	Industrial	Plug
	4732N	Bryant	125	15	Industrial	Connector
	4729MA	Marinco	125	15	Industrial	Connector
	4700	Bryant	125	15	Industrial	Receptacle
 5-20	5366N	Bryant	125	20	Industrial	Plug
	5366MA	Marinco	125	20	Industrial	Plug
	5369N	Bryant	125	20	Industrial	Connector
	5369MA	Marinco	125	20	Industrial	Connector
	520-R	CEP	125	20	Industrial	Receptacle
	520R1	Marinco	125	20	Industrial	Receptacle

REPLACEMENT PARTS AVAILABLE

Wiring Devices

NEMA	Cat. No.	Manufacturer	Voltage	Amps	Grade	Device Type
 L5-20	70520NP	Bryant	125	20	Industrial	Plug
	205P	Marinco	125	20	Industrial	Plug
	26W47	Woodhead	125	20	Marine	Plug
	70520NC	Bryant	125	20	Industrial	Connector
	205C	Marinco	125	20	Industrial	Connector
	27W47	Woodhead	125	20	Marine	Connector
	L520R	CEP	125	20	Industrial	Receptacle
	205R	Marinco	125	20	Industrial	Receptacle
 L5-30	70530NP	Bryant	125	30	Industrial	Plug
	305P	Marinco	125	30	Industrial	Plug
	70530NC	Bryant	125	30	Industrial	Connector
	305C	Marinco	125	30	Industrial	Connector
	305R	Marinco	125	30	Industrial	Receptacle
 L6-20	70620NP	Bryant	250	20	Industrial	Plug
	206P	Marinco	250	20	Industrial	Plug
	70620NC	Bryant	250	20	Industrial	Connector
	206C	Marinco	250	20	Industrial	Connector
	206R	Marinco	250	20	Industrial	Receptacle
 L14-20	714205NP	Bryant	125/250	20	Industrial	Plug
	2014P	Marinco	125/250	20	Industrial	Plug
	71420NC	Bryant	125/250	20	Industrial	Connector
	2014C	Marinco	125/250	20	Industrial	Connector
	2014R	Bryant	125/250	20	Industrial	Receptacle
 L15-20	2015P	Marinco	250	20	Industrial	Plug
	2015C	Marinco	250	20	Industrial	Connector
	2015R	Marinco	250	20	Industrial	Receptacle
 L21-20	2021P	Marinco	120/208	20	Industrial	Plug
	2021C	Marinco	120/208	20	Industrial	Connector
	2021R	Marinco	120/208	20	Industrial	Receptacle
 L16-20	2016P	Marinco	480	20	Industrial	Plug
	2016C	Marinco	480	20	Industrial	Connector
	2016R	Marinco	480	20	Industrial	Receptacle
 L6-30	70630NP	Bryant	250	30	Industrial	Plug
	306P	Marinco	250	30	Industrial	Plug
	70630NC	Bryant	250	30	Industrial	Connector
	306C	Marinco	250	30	Industrial	Connector
	L630R	CEP	250	30	Industrial	Receptacle
	306R	Marinco	250	30	Industrial	Receptacle

REPLACEMENT PARTS AVAILABLE

Wiring Devices

NEMA	Cat. No.	Manufacturer	Voltage	Amps	Grade	Device Type
 L14-30	71430NP	Bryant	125/250	30	Industrial	Plug
	3014P	Marinco	125/250	30	Industrial	Plug
	71430NC	Bryant	125/250	30	Industrial	Connector
	3014C	Marinco	125/250	30	Industrial	Connector
	3014R	Marinco	125/250	30	Industrial	Receptacle
 14-30	9432ANP	Bryant	125/250	30	Industrial	Right-Angle Plug
 L15-30	3015P	Marinco	250	30	Industrial	Plug
	3015C	Marinco	250	30	Industrial	Connector
	3015R	Marinco	250	30	Industrial	Receptacle
 L21-30	3021P	Marinco	120/208	30	Industrial	Plug
	3021C	Marinco	120/208	30	Industrial	Connector
	3021R	Marinco	120/208	30	Industrial	Receptacle
 L16-30	3016P	Marinco	480	30	Industrial	Plug
	3016C	Marinco	480	30	Industrial	Connector
	3016R	Marinco	480	30	Industrial	Receptacle
 14-50	9452ANP	Bryant	125/250	50	Industrial	Right-Angle Plug
 CS63 Series	6365H	Hubbell	125/250	50	Industrial	Plug
	6365M	Marinco	125/250	50	Commercial	Plug
	6364H	Hubbell	125/250	50	Industrial	Connector
	6364M	Marinco	125/250	50	Commercial	Connector
	6375H	Hubbell	125/250	50	Industrial	Male Inlet
	6369H	Hubbell	125/250	50	Industrial	Receptacle
	SR50	CEP	125/250	50	Industrial	Weatherproof Box
 CS83 Series	8365M	Marinco	250	50	Industrial	Plug
	8364M	Marinco	250	50	Industrial	Connector
 CS81 Series	8165M	Marinco	480	50	Industrial	Plug
	8164M	Marinco	480	50	Industrial	Connector

REPLACEMENT PARTS AVAILABLE

Portable Lighting — Hand Carry & Stand Units

360-Degree Wing Light



Features & Benefits

- ▶ 3-Panel Design with rotating wings for 360-degree directional lighting and 180-degree tilt to provide illumination on various levels
- ▶ Versatile and can be placed anywhere in the room
- ▶ 51 Watt LED Panel Light and 4000 lumens
- ▶ 5000 K color temperature
- ▶ White LED Illumination reduces eye stress and allows for better color rendering for painting
- ▶ Very Low Energy Consumption – draws 0.47 amps on a 120V circuit
- ▶ ETL and CETL Listed for outdoor use. No additional guard required for Wet Location work
- ▶ Impact Resistant Polycarbonate lenses for durability in harsh environments
- ▶ Replaceable lenses available to cover paint & chemical overspray
- ▶ All steel stand and components with adjustable telescoping masts



5270



5220

Cat. No.	Description	Dimensions In.	Weight	Box Count
5220	LED Portable Work Light	25W x 13L x 12.5H	28 Lb.	4
5270	7 Ft LED Portable Work Light	38W x 11L x 15H	30 Lb.	2

9000-Series High Lumen Heavy Duty LED Fixtures



CEP's line of 9000-series LED work lights presents the brightest and most durable LED work light available in the construction marketplace. Each LED head is capable of 5,500 lumens and 5.6K color temperature, and can be mounted in a variety of ways depending on how it is needed to be used. Versatile and Wet-Location Listed, it is the perfect companion for any type of work.

Features & Benefits

- ▶ 5500 Lumens per head
- ▶ LED's Rated Life = 50,000 Hours
- ▶ 110% LED Efficient Driver
- ▶ 50 Watts, 120V = .042 Amps
- ▶ 5 Ft. 18/3 SJTW Power Cord
- ▶ ETL/cETL for Wet Locations
- ▶ Wire Cages included for additional lens protection
- ▶ 9055 model has included Roll Cage & Springs to Add Additional Protection Against Impact
- ▶ 9125 hand carry model has included 200lb Rated Magnet on Back for instant mounting
- ▶ 9750 and 9810 have all steel stand and components with adjustable telescoping masts



9750



9125

Cat. No.	Height	No. of Heads	Stand/Base Type	Switch	Watts	Cord Length
9055	10 In.	1	Roll Cage	Yes	50	5 Ft.
9125	10 In.	1	Hand Carry & Magnet	Yes	50	5 Ft.
9750	7 Ft.	1	19 In. Base -2 Stage Stand	Yes	50	12 Ft.
9810	8 Ft.	2	30 In. Base -2 Stage Stand	Yes	100	12 Ft.

REPLACEMENT PARTS AVAILABLE

Portable Lighting — Hand Carry & Stand Units

Economy LED Fixtures

CEP's line of economy LED work lights presents a bright source for a much lower cost. These are perfect for the user who needs to upgrade from the quartz products in an economy package.

Features & Benefits

- ▶ Single head models 5250 & 6125I, Dual Head model 6710I
- ▶ Long Lasting 50,000 Hour Chip-On-Board LED
- ▶ COB Technology allows for cooler operating temperature
- ▶ Durable, Polycarbonate Lens
- ▶ cULus Listed
- ▶ Heavy Duty Die-Cast Aluminum Housing
- ▶ 6 Ft. 16/3 SJTW Power Cord
- ▶ Power Switch on Each Fixture
- ▶ 4000K Color Temperature
- ▶ Efficiency: 87.5 Lumens per Watt
- ▶ Model 6710I includes Foldable Tripod, adjusts up to a total of 6.8 feet in height. A carrying handle is included for use while detached from tripod

Cat. No.	Lumens per Head	Height	No. of Heads	Stand/Base Type	Switch	Watts	Cord Length
5250	3700	10 In.	1	Hand Carry	Yes	50	7 Ft.
6125I	3500	10 In.	1	Hand Carry	Yes	41	6 Ft.
6710I	3500	6.8 Ft.	2	19 In. Base -2 Stage Stand	Yes	82	6 Ft.



6710I



6125I

Portable Lighting — Battery-Powered Units

6165i Portable Battery Unit

Introducing Model 6165-I, a tiny, 100% portable, battery powered LED light. At under 8-inches and 1500 lumens maximum, it's small size makes it the perfect addition to any toolbox. It's LiOn battery lasts up to 6 hours, and can be easily re-charged using any USB port, 5-15 receptacle, or vehicle charging port. Perfect for anyone who wants something quick they can grab and get a bright light from, even for only a few hours.

Tag the 6165I on Instagram and Facebook #wherehasyour6561ibeen



Features & Benefits

- ▶ 3 Brightness Options allows for long battery life
- ▶ Up to 6 Hours Run Time with a 3 hour charge time
- ▶ Long Lasting Chip-On-Board LED
- ▶ COB Technology allows for cooler operating temperature
- ▶ Durable Polycarbonate Lens cULus Listed, IP44 Sealed
- ▶ LED Charging indicator on rear of unit
- ▶ 3 charging options included: 120V Wall Charger, USB Charger, 12V Vehicle Charger
- ▶ Heavy Duty Die Cast Aluminum Housing



6165I



Included Accessories

Cat. No.	Watts	Description
6165I	20	Rechargeable LED Work Light

Portable Lighting — Tower Units

CEP offers a high lumen line of LED area work lights that are made to provide the brightest light possible in a portable, mobile package for every jobsite. With metal halide lights fading but still available, the 7000-Series LED's are the newest in industry LED technology, featuring alternating current LED's that are the brightest available, eliminating the need for costly LED drivers. This makes the 7000-Series the perfect upgrade from metal halide carts at close to the same cost. While the metal halide fixtures will continue to be available, the cost savings on the lower current draw that LED's use, plus the radiation safety factor, make LED's the brighter choice.

7000-Series LED Fixtures



Features & Benefits

- ▶ 200 Watts, 120V = 1.7 amp draw
- ▶ 7309 - Single head, 5-10 Ft. mast. 22,000 Lumens
- ▶ 7322 - Double head, 5.5-12 Ft. mast. 22,000 Lumens per fixture for total 44,000 Lumens
- ▶ 110% AC LED Efficiency
- ▶ 12 Ft. 18/3 SJTW Power Cord with NEMA 5-15P
- ▶ ETL/cETL for Wet Locations
- ▶ Wire Cages Included for additional lens protection
- ▶ LED Fixtures can be adjusted to different horizontal angles
- ▶ Model 7322 12 Ft. Mast with 600lb self-braking winch
- ▶ All Steel Cart Base can accept portable generators for remote applications



9000-Series LED Fixtures



CEP's also offers the 9000-Series of tower lights that uses the 5500-lumen head and has both a dual-head and quad-head option. The quad-head option has the added benefit of giving your jobsite either directional or a 360-degree area lighting.

Features & Benefits

- ▶ 50 Watts, 120V = .042 Amps
- ▶ 5500 Lumens per head
- ▶ LED's Rated Life = 50,000 Hours
- ▶ 110% LED Efficient Driver
- ▶ 12 Ft. 18/3 SJTW Power Cord
- ▶ ETL/cETL for Wet Locations
- ▶ Wire Cages included for additional lens protection
- ▶ LED Fixtures can be adjusted to different horizontal angles
- ▶ Model 9842 includes 10 Ft. mast
- ▶ Model 9322 uses a 12 Ft. Mast with 600lb self-braking winch
- ▶ All-Steel Cart Base can accept portable generators for remote applications



9322 (Photo of Head Only)

	Light Head Qty	Watts Per Head	Total Watts	Total Amps at 125V	Handle/Mast	Total Lumens	Height
7309	1	200	200	1.6	2 Stage	22,000	5-10 Ft.
7322	2	200	400	3.2	2 Stage, with 600lb winch	44,000	5 Ft. 6 In.-12 Ft.
7300HA	1	200	200	1.6	Replacement Head for 7309	22,000	N/A
7300DHA	2	200	400	3.2	Replacement Head for 7322	44,000	N/A
9842	2	50	100	0.8	2 Stage	11,000	5-10 Ft.
9322	4	50	200	1.6	2 Stage, with 600lb winch	22,000	5 Ft. 6 In.-12 Ft.
9800DHA	2	50	100	0.8	Replacement Head for 9842	11,000	N/A
9900DHA	4	50	200	1.6	Replacement Head for 9322	22,000	N/A

Portable Lighting — Tower Units

5000-Series Metal Halide Fixtures



CEP will always offer our best selling 5000-Series metal halide lights and carts. CEP's Metal Halide lights feature the LH1000MH, an elliptical shape 1000-watt metal halide fixture. These light heads are extremely strong, compact and the bulbs are rated to last 10,000 hours. CEP's Metal Halide lights are mounted in a heavy-duty steel yoke, providing impact resistance when in use or when transporting to other locations. All models are available with optional GFCI plug. All tower lights are 125V, but may be special ordered in other voltages. Metal Halide lights require a warm-up time of 4-5 minutes for full illumination. A cool-down time of 5-15 minutes is recommended after shutdown to re-light.

Features & Benefits

- ▶ All frames are made of 1-1/4 In. 12 gauge steel tube and are powder coated safety yellow
- ▶ Head assemblies are easily removed from the mast and detach from their ballast. This enables one person setup, and offers safety and convenience in transporting and storage
- ▶ 1000 Watts, 120V = 8.3 Amps, 2000 Watts, 120V = 16.6 Amps
- ▶ Rated Life = 10,000 Hours
- ▶ 12/3 SJTW Power Cord with either 15-Amp U-Ground Plug (5309) or 20-Amp Twist-Lock plug & included adapter (5322)
- ▶ ETL/cETL for Wet Locations
- ▶ Model 5309 includes 10 Ft. mast
- ▶ Model 5322 includes 12 Ft. mast with 600lb self-braking winch



5322 and 5309

Cat. No.	Light Head Qty.	Watts Per Head	Total Watts	Total Amps at 125V	Handle/Mast	Total Lumens	Height
5309	1	1000	1000	8.0	2 Stage	110,000	5-10 Ft.
5322	2	1000	2000	16.0	2 Stage, with 600lb winch	220,000	5 Ft. 6 In. - 12 Ft.
LH1000MH	1	1000	1000	8.0	Replacement Head for 5309/5322	110,000	N/A

360-Degree Tower



Features & Benefits

- ▶ 360- horizontal degrees of light and over 180-vertical degrees of light
- ▶ Perfect fixture for general area light to brighten up the whole room
- ▶ 78 Watts, 120V = 0.65 Amps
- ▶ IP65-Rated for continuous outdoor use
- ▶ Includes 7 Foot All-Steel stand



CLM78LED

Cat. No.	Total Watts	Total Amps at 120V	Handle/Mast	Total Lumens	Height
CLM78LED	78	0.65	19-In. base, 2-Stage Stand	9750	7 Ft.

REPLACEMENT PARTS AVAILABLE

Portable Lighting — High-Bay Fixtures

CEP has been offering temporary high-bay lighting for over 10 years. Our metal halide 400-Watt model has been proven as an industry rock, with thousands of fixtures in the field. With the industry change to LED, CEP has introduced one of the industry's first, specifically designed, LED high-bay fixtures, the CL120LED. Utilizing specific tapered panels and the best LED's available in the market, CEP's offering is perfect for temporary high bay lighting, with coverage up to the OSHA required 5fc and up to 20 sq feet (when hung at a height of 15 feet). CEP also has introduced lower-wattage versions, using the same original CEP tapered technology. Independent photometrics reports are available upon request for CAD drafting and lighting engineers. While the metal halide fixtures will continue to be available, the cost savings on the lower current draw that LED's use, plus the radiation safety factor, make LED's the brighter choice.

CALCULATE YOUR SAVINGS AT:

www.cepnow.com/cl120led-outshines-metal-halide-calculate-savings/

120 Watt Model

Features & Benefits

- ▶ 120 Watts = 1A, 120V
- ▶ 14000 lumens, 4800K Color Temperature
- ▶ 120% LED efficiency
- ▶ Includes a 15A Female Receptacle to daisy chain lights downstream
- ▶ Customizable up to 277 VAC upon request
- ▶ Available in Yellow and White
- ▶ Polycarbonate impact resistant lenses
- ▶ 50,000 hour rated LED's
- ▶ 5 Ft. 16/3 SJTW power supply cord
- ▶ Spring Loaded Quick Mount Hook allows unit to be mounted in seconds
- ▶ UL/cUL for Damp Locations.
- ▶ Wire Cage included for additional protection
- ▶ Replacement lenses and optional, glare-free, lenses available



CL120LED

60 Watt, 100-Watt, and 150-Watt Models

Features & Benefits

- ▶ 60 Watt = 7,200 Lumens; 100 Watt = 12,000 Lumens; 150 Watt = 19,500 Lumens
- ▶ 5000K Color Temperature
- ▶ 6 Ft. 16/3 SJTW power supply cord
- ▶ Generation 2 features 1 Ft. Feed-Thru 15A cord to daisy chain lights downstream
- ▶ Operating Temperature = -20F (-29C) to Max 140F (60C)
- ▶ UL Listed for Damp Locations.
- ▶ Generation 2 features tapered LED panels for greater horizontal lux
- ▶ Impact Resistant design gives these units the durability to withstand storage, transportation, and demanding job site environments
- ▶ CL100LEDG2 also available in White
- ▶ Spring Loaded Quick Mount Hook allows unit to be mounted in seconds
- ▶ Wire Cage included for additional protection



CL100LEDG2



CL100LEDG2W

SEE TOP OF PAGE 29 FOR ORDER INFORMATION

REPLACEMENT PARTS AVAILABLE

Portable Lighting — High-Bay Fixtures

Cat. No.	Watts	Lumens	Input Cord	Feedthrough & Type	Color
CL120LED	120	14,000	16/3 SJTW	Yes - Receptacle	Yellow
CL120LEDW	120	14,000	16/3 SJTW	Yes - Receptacle	White
CLM150LED	150	19,500	18/3 SJTW	No	Orange
CL100LEDG2	100	12,000	18/3 SJTW	Yes - 1 Ft. Cord	Orange
CL100LEDG2W	100	12,000	18/3 SJTW	Yes - 1 Ft. Cord	White
CL60LEDG2	60	7,200	18/3 SJTW	Yes - 1 Ft. Cord	Orange
CL60LED	60	7,200	18/3 SJTW	No	Orange

105 Watt Compact Fluorescent

Features & Benefits

- ▶ cUL/UL Listed, suitable for dry locations
- ▶ 105 Watts = .87A, 120V
- ▶ 5800 Lumens
- ▶ Includes a 15A Female Receptacle to daisy chain lights downstream
- ▶ Lamp sold separately (PN# 105WCFL)
- ▶ E26 Lamp Base
- ▶ 6 Ft. 16/3 SJTW power supply cord
- ▶ Spring Loaded Quick Mount Hook
- ▶ Wire Cage Included



CL105CFL

Cat. No.	Watts	Lumens	Input Cord	Feedthrough & Type	Color
CL105CFL	N/A	N/A	16/3 SJTW	Yes - Receptacle	Yellow
105WCFL	105	5,800			

400 Watt Metal Halide

Features & Benefits

- ▶ cUL Listed, suitable for damp locations
- ▶ Compact size for easy handling
- ▶ Heavy-duty formed steel enclosed powder coated finish
- ▶ Clear 400 watt metal halide lamp included
- ▶ 29,000 Lumen Output
- ▶ Multi-Tap Pulse Start Ballast
- ▶ Hook with locking feature allows unit to be mounted in seconds
- ▶ Mogul-base porcelain socket
- ▶ Durable formed and welded wire guard



CL400

Cat. No.	Watts	Lumens	Input Cord	Feedthrough & Type	Color
CL400P	400	29,000	16/3 SJTW	None	White

REPLACEMENT PARTS AVAILABLE

Portable Lighting — Light Stringers



97132



91135

LED Light Stringers

LED light stringers can be up to 15x more efficient than incandescent lighting. With a cool, 56K, color temperature, they are perfect for working indoors or outdoors while reducing eye stress and allowing a good color rendering for any work to be accomplished. Depending upon your application, CEP offers two versions of LED stringers: one with a removable panel, and a brighter version with a fixed panel and a magnetic bracket.

CALCULATE YOUR SAVINGS AT:
www.cepnow.com/cl120led-outshines-metal-halide-calculate-savings/

Features & Benefits (Models 97135, 97132, and 97120)

- ▶ 50,000 hour lamp life (24/7 for 6 yrs)
- ▶ 90x LED – 7.5 watts per fixture allows for connections up to 500 feet continuous run
- ▶ High impact resistant, and compact for easy transportation & storage.
- ▶ Panels use E17 base and can be removed for easy installation
- ▶ NEMA 1-15 Input & Slide lock feed-through connector
- ▶ cETLus Outdoor approved for wet locations
- ▶ Optional magnetic swivel bracket with hook for easy attachment

Features & Benefits (Models 91135 & 91120)

- ▶ 50,000 hour lamp life (24/7 for 6 yrs)
- ▶ cETLus Outdoor approved for wet locations
- ▶ Connect up to 500' of strings together
- ▶ Adjustable yoke with recessed 30lb magnet for quick mounting
- ▶ Impact resistant polycarbonate lens
- ▶ NEMA 1-15 Input & Slide lock feedthrough connector
- ▶ 9.6 Watts, 120V = 0.08 amp draw per fixture



91135 Head



97120

Cat. No.	Length	Light Head Qty.	Watts per Head	Total Watts	Lumens Per Head	Total Lumen	Head Type	Cord Gauge & Type
97132	100 Ft.	10	7.5	75	900	9000	E17 Base w/ hook	18/2 STW
97135	50 Ft.	5	7.5	37.5	900	4500	E17 Base w/ hook	18/2 STW
97120	20 Ft.	1	7.5	7.5	900	900	E17 Base w/ hook & magnetic clip	18/2 STW
91135	50 Ft.	5	9.6	48	1140	5700	Magnetic Bracket w/ Tilt	18/2 SJTW
91120	20 Ft.	1	9.6	9.6	1140	1140	Magnetic Bracket w/ Tilt	18/2 SJTW
9700							Magnetic bracket for 97132/97135	
9709			7.5	7.5	900	900	E17 Base	
9711			7.5	7.5	900	900	E26 Base	

Portable Lighting — Light Stringers



Pre-Assembled Metal Guard Type





Pre-Assembled Plastic Type

Traditional Light Stringers

Features & Benefits

- ▶ Sockets are spaced 10 feet apart
- ▶ Rated for 150 watt bulbs
- ▶ Molded sockets, plugs & connectors to protect against moisture
- ▶ Outdoor approved for wet locations
- ▶ cULus Listed, with exception noted below
- ▶ Lamp & Bulb selections can be found on page 33

	Cat. No.	Length	Sockets Qty.	Gauge & Conductor Count	Cord Jacket	Plug & Connector	Guard Type
	95135	50 Ft.	5	12/3	STW	NEMA 5-15 Plug & Feed Thru NEMA 5-15 Connector	Plastic
	96135*	50 Ft.	5	12/3	SJTW		Plastic
	95137	50 Ft.	5	12/3	STW		Pre Assembled Metal
	95133	100 Ft.	10	12/3	STW		Pre Assembled Metal
	95132	100 Ft.	10	12/3	STW		Pre Assembled Plastic
	96132*	100 Ft.	10	12/3	SJTW		Pre Assembled Plastic
	94132*	100 Ft.	10	14/2	STW		NEMA 5-15 Plug
	95125	50 Ft.	5	12/3	STW	NEMA L5-20 Plug & Feed Thru NEMA L5-20 Connector	Plastic
	96125*	50 Ft.	5	12/3	SJTW		Plastic
	95127	50 Ft.	5	12/3	STW		Pre Assembled Metal
	95123	100 Ft.	10	12/3	STW		Pre Assembled Metal
	95122	100 Ft.	10	12/3	STW		Pre Assembled Plastic
	96122*	100 Ft.	10	12/3	SJTW		Pre Assembled Plastic

*Items Are Not Approved For Use In Canada

REPLACEMENT PARTS AVAILABLE

Portable Lighting — Hand Carry & Stand Units

Quartz Lighting

Built to last, CEP's heavy-duty quartz lights have been designed to endure the harshest of jobsite conditions. All fixtures are either cETLus or cULus Listed as portable work lights approved for use in wet locations. The Heavy Duty portable light stands are made of heavy wall tube steel and have no plastic parts, and the fixtures emit 11,000 lumens of color-corrected light and provide the user with much more light efficiency than the traditional imports. The Economy Quartz Lights provide the same degree of lumens with a different grade assembly.

Features & Benefits

- ▶ Folding tripod base and removable head assemblies for easy set-up and storage
- ▶ Cord retainer mounted on the base to prevent tip over.
- ▶ All-steel stand and components with adjustable telescoping masts
- ▶ 16/3 or 16/2 SJTW power supply cord
- ▶ One rough service quartz halogen bulb included with each fixture
- ▶ Convenient cord wrap
- ▶ Removable head assembly on all Models 5050, 5710, 5810
- ▶ Models 5125I, 5165I, 5610I, and 5650I adjusts from 3 feet to 6 feet
- ▶ Models 5710 adjusts from 4 feet to 7 feet
- ▶ Models 5810 adjusts from 5 feet to 8 feet
- ▶ Economy models are cULus Listed for USA and Canada
- ▶ Heavy-Duty models are UL Listed for use in USA only



Heavy Duty Quartz Group



5125I

Cat. No.	Type	Height	No. of Heads	Stand / Base Type	Switch	Watts	Cord Length	Cord Type
5050*	Heavy-Duty	1 Ft.	1	Magnetic Base	Yes	500	7.5 Ft.	U-Ground
5710*	Heavy-Duty	7 Ft.	2	19" Base -2 Stage Stand	Yes	1000	8 Ft.	U-Ground
5810*	Heavy-Duty	8 Ft.	2	30" Base -2 Stage Stand	Yes	1000	8 Ft.	U-Ground
5123I	Economy	1 Ft.	1	Hand Carry	No	500	3 Ft.	U-Ground
5125I	Economy	1 Ft.	1	Hand Carry	No	500	6 Ft.	U-Ground
5125ITL	Economy	1 Ft.	1	Hand Carry	No	500	6 Ft.	Twist-lock
5165I	Economy	N/A	1	Clamp	Yes	150	6 Ft.	U-Ground
5610I	Economy	6 Ft.	2	3 Stage	Yes	1000	6 Ft.	U-Ground
5650I	Economy	6 Ft.	1	3 Stage	Yes	500	6 Ft.	U-Ground
5700*	Heavy Duty	N/A	1	Replacement Head	Yes	500	6 Ft.	U-Ground

*UL Listed Only

Trouble Lights

Cat. No.	Length	Gauge	Type	Watts	Description
1325T	25	16/3	SJTW	75	Trouble Light 12 In.
1350T	50	16/3	SJTW	75	Trouble Light 12 In.



1325

REPLACEMENT PARTS AVAILABLE

Portable Lighting — Bulbs



10WLED



23WCFL



5905



5910



5911



5903FR

Cat. No.	Box Count	Type	Watts
10WLED	10	LED – 9.9 Watt LED, 800 Lumen	9.9
9711	10	LED – LED Panel Light, E26 Base, 900 Lumens	7.5
5902FR	120	Incandescent – Rough Service, Frosted, Extra-Heavy-Duty	75
5903FR	120	Incandescent – Rough Service, Frosted, Extra-Heavy-Duty	100
5911	50	Quartz – Rough Service Quartz	150
5904	50	Quartz – Rough Service Quartz	300
5905	50	Quartz – Rough Service Quartz	500
5940	1	Metal Halide – Probe Start, Type O	400
5940P	1	Metal Halide – Pulse Start, Type O	400
5910	6	Metal Halide – BT-37 Metal Halide-Elliptical	1000
5910C	6	Metal Halide – BT-56 Metal Halide-Conical	1000
105WCFL	10	Compact Fluorescent – 105 Watt CFL, E26 Base	105
23WCFL	10	Compact Fluorescent – 23 Watt CFL, E26 Base	23

Technical Help

Cord Length & Current Rating Chart

Conductor Size (AWG)	Maximum Current Carrying Capacity (Amps)			
	Length: 6 - 50 Ft.		Length: 51-100 Ft.	
	2 Pole	3 Pole	2 Pole	3 Pole
18	10	7	10	7
16	13	10	13	10
14	18	15	18	15
12	25	20	25	20
10	30	25	30	25
8	40	35	40	35
6	55	45	55	45
4	70	60	70	60

Recommended Wire Gauges

Gauge of Conductor (Cu)	Maximum Current/Load in Amperes	Maximum Cord Length (considering 5% Voltage Drop) in Ft.	Typical Service Length in Ft.	Approximate Voltage Drop for Typical Service Length
18	7	65	100	9%
16	10	71	100	6%
14	15	75	125	8%
12	20	90	125	6%
10	25	115	150	6%
8	35	130	150	5%
6	45	158	200	6%
4	60	188	200	5%

Single Phase & Three Phase kVA to Amperes Chart

Full Load Current In Amperes at Line-To-Line Voltages Listed Below

kVA Rating	Single-Phase	
	120 V	240 V
5	42	21
7.5	63	31
10	83	42
15	125	63
25	208	104
37.5	312	156
50	416	208
75	625	312
100	833	416
167	1390	695

kVA Rating	Three-Phase		
	208 V	240 V	480 V
3	8.3	7.2	3.6
6	16.6	14.4	7.2
9	25	21.6	10.8
15	41.6	36	18
30	83.3	72	36
45	125	108	54
75	208	180	90
112.5	312	271	135
150	416	361	180
225	625	541	271

TEMP POWER

Compliance and Safety Guide

The safety standard for power distribution is UL1640. Make sure you're compliant and your equipment meets the following standards – and avoid these pitfalls:

FOLLOW UL1640 SAFETY STANDARDS

- ▶ Class A-rated GFCI protection (trip level between 4-6 mA) on all 15 and 20 amp 125 Volt circuits
- ▶ Branch-level circuit protection
- ▶ Open neutral and reverse phasing
- ▶ 240 volt shut-off circuitry
- ▶ NEMA 3R outdoor-rated construction
- ▶ Structural integrity with no risk of collapse, fire or conductivity

BEWARE

- ▶ **GFCI Modules and Circuit Breakers Protecting Multiple Circuits** – This invites overload on those components
- ▶ **GFCI Receptacles** – They do not provide the required 240 volt shut off circuitry
- ▶ **Power Distribution Mounted on Wood** – This does not meet the requirements for structural integrity (fire proof, weather protection and collapse proof)



SINGLE PHASE POWER BOX WITH LEGS 50 amps, 125/250v
U-GROUND & TWISTLOCK
MODELS AVAILABLE
PAGE 4



SINGLE PHASE POWERBOX WITH FRAME 50 amps, 125/250v
U-GROUND & TWISTLOCK
MODELS AVAILABLE
PAGE 4



100 & 200 AMP, 3-PHASE DISTRIBUTION PANEL
MULTIPLE SINGLE-PHASE & 3-PHASE INPUT AND OUTPUT
CONFIGURATIONS AVAILABLE
PAGES 8-10



50 AMP TEMPORARY POWER CORDS
25', 50', 75', 100' and "Y"
ADAPTER MODELS AVAILABLE
PAGE 11

TEMP POWER DIAGRAM

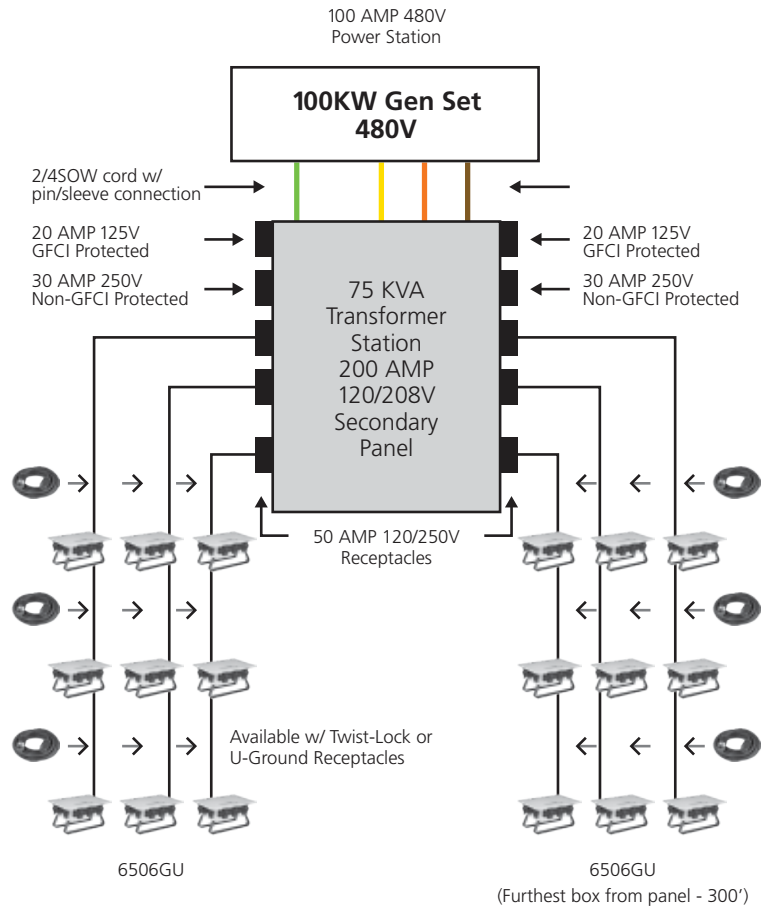

CEP POWER DISTRIBUTION

- ▶ Puts power closer to the work area
- ▶ Protects tools against under-current burn out
- ▶ Allows quick set-up and removal
- ▶ Reduces the cost of labor and materials
- ▶ Reduces extension cord clutter on the jobsite
- ▶ Helps reduce liability because all equipment down stream of the power source is code compliant, agency listed and safe
- ▶ Protects against line-side power deficiencies
- ▶ Protects circuits against over-voltage damage



