

**Crosby**

# Swivel Hoist Ring



**HR-125M**  
Swivel Hoist Ring

Color coded to distinguish between UNC (Red) and Metric (Silver) thread types.



**HR-125**  
Swivel Hoist Ring

- Available in UNC and Metric thread sizes.
  - UNC threads available in sizes from 800 pounds to 100,000 pounds Working Load Limit, with a design factor of 5 to 1.
  - Metric threads available in sizes from 400kg to 16,900kg and dual rated in both a 4 to 1 and 5 to 1 design factor.
- All Components are Alloy Steel - Quenched and Tempered.
- Designed to be used at full WLL within angular loading range.
- 100% individually proof tested to 2-1/2 times the Working Load Limit with certification and Statistically Magnetic Particle inspected. (Can be furnished 100% Magnetic Particle inspected when requested at time of order.)
- Each product has a Product Identification Code (PIC) for material traceability along with a Working Load Limit and the name Crosby or "CG" stamped into it.
- 360° swivel and 180° pivot action.
- Fatigue rated to 20,000 cycles at 1-1/2 times the Working Load Limit.
- Individually packaged along with proper application instructions and warning information.
- Bolt is secured with E-clip, threads are grooved. This method allows for easy disassembly and assembly of hoist ring for thorough examination of all components. Replacement kits are available.
- Bolts are individually Proof Tested.
- Multiple Bolt length available to meet specific application requirements.
- Zinc Plated (Yellow Chromate) finish for increased corrosion protection thru 30,000 pound size.
- Meets or exceeds all the requirements of ASME B30.26 including identification, ductility, design factor, proof load and temperature requirements. Importantly, these hoist rings meet other critical performance requirements including fatigue life, impact properties and material traceability, not addressed by ASME B30.26.



**Fatigue Rated**



**Load Rated**



Scan this QR code with your smart device to view our Eye Bolts & Hoist Rings video.

**WESTECH RIGGING SUPPLY**  
Call Toll Free: 800-442-7475

Call Us or Visit Our Stores:  
Monday - Friday, 8:00am - 5:30pm Pacific



Distributed By

Visit Us Online at: [www.WestechRigging.com](http://www.WestechRigging.com)

4140 West 11th Avenue  
Eugene, Oregon 97402

2439 McGilchrist St SE  
Salem, Oregon 97302

# UNC Swivel Hoist Rings

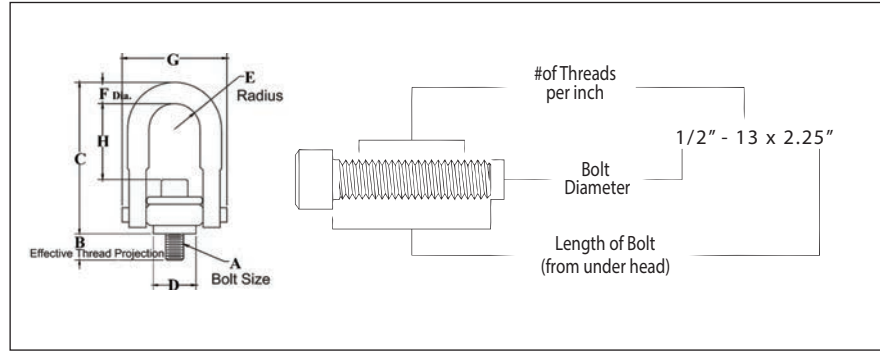

- Top washer has the following features:
  - The Working Load Limit and Recommended Torque value are permanently stamped into each washer.
  - Washer is color coded for easy identification: Red - UNC thread.
- Individually Proof Tested to 2-1/2 times Working Load Limit.
- Bolt specification is an Alloy socket head cap screw to ASTM A 574.
- All threads listed are UNC.
- **BOLT SIZE IDENTIFICATION:** The size of the bolt will be stated as in the drawing above. Illustration shows meaning of each dimension given.
- NOTE: For Special Applications, see page 457.
- Frame 2 and larger are **RFID EQUIPPED**.

Rigging Accessories

**Fatigue Rated**  **Load Rated**



## HR-125 UNC Threads

Frame Size No.	HR-125 Stock No.	Working Load Limit (lbs.)*	Torque in Ft. Lbs.	Dimensions (in.)								Weight Each (lbs.)
				Bolt Size A ‡	Effective Thread Projection Length B	C	D	Radius E	Diameter F	G	H	
1 †	1016887	800	7	5/16 - 18 x 1.50	.58	2.72	.97	.46	.34	1.87	1.12	.37
1 †	1016898	1000	12	3/8 - 16 x 1.50	.58	2.72	.97	.46	.34	1.87	1.05	.39
2	1016909	2500	28	1/2 - 13 x 2.00	.70	4.85	1.96	.87	.75	3.35	2.29	2.33
2 †	1016912	2500	28	1/2 - 13 x 2.50	1.20	4.85	1.96	.87	.75	3.35	2.29	2.36
2	1016920	4000	60	5/8 - 11 x 2.00	.70	4.85	1.96	.87	.75	3.35	2.16	2.41
2 †	1016924	4000	60	5/8 - 11 x 2.75	1.45	4.85	1.96	.87	.75	3.35	2.16	2.47
2	1016931	5000	100	3/4 - 10 x 2.25	.95	4.85	1.96	.87	.75	3.35	2.04	2.52
2 †	1016935	5000	100	3/4 - 10 x 2.75	1.45	4.85	1.96	.87	.75	3.35	2.04	2.59
3	1016942	7000 **	100	3/4 - 10 x 2.75	.89	6.57	2.96	1.36	.94	4.87	2.97	6.72
3 †	1016946	7000 **	100	3/4 - 10 x 3.50	1.64	6.57	2.96	1.36	.94	4.87	2.97	6.81
3	1016953	8000	160	7/8 - 9 x 2.75	.89	6.57	2.96	1.36	.94	4.87	2.84	6.84
3 †	1016957	8000	160	7/8 - 9 x 3.50	1.64	6.57	2.96	1.36	.94	4.87	2.84	6.96
3	1016964	10000	230	1 - 8 x 3.00	1.14	6.57	2.96	1.36	.94	4.87	2.72	7.09
3 †	1016969	10000	230	1 - 8 x 4.00	2.14	6.57	2.96	1.36	.94	4.87	2.72	7.31
4	1016975	15000	470	1-1/4 - 7 x 4.50	2.21	8.72	3.71	1.75	1.19	6.18	3.93	14.51
5	1016986	24000	800	1-1/2 - 6 x 6.75	3.00	12.55	4.71	2.39	1.75	8.48	5.52	37.73
5	1016997	30000	1100	2 - 4-1/2 x 6.75	3.00	12.55	4.71	2.39	1.75	8.48	5.02	40.69
6	1017001	50000	2100	2-1/2 - 4 x 8.0	4.00	16.88	5.75	3.00	2.25	11.00	8.03	88.00
7	1017005	75000	4300	3 - 4 x 10.5	5.00	19.50	6.45	3.75	2.75	14.16	8.50	166.00
8	1017009	100000	5100	3-1/2 - 4 x 13.0 #	7.00	22.09	7.75	4.00	3.25	15.91	9.28	265.00

\*Ultimate Load is 5 times the Working Load Limit.

\*\* Ultimate Load is 4.5 times the Working Load Limit for 7000# Hoist Ring when tested in 90 degree orientation.

† Long Bolts are designed to be used with soft metal (i.e., aluminum) workpiece. While the long bolts may also be used with ferrous metal (i.e., steel & iron) workpiece, short bolts are designed for ferrous workpieces only.

‡ Bolt specification is an Alloy socket head cap screw to ASTM A 574.

# Hex head bolt used on Frame 8 (100,000lb.) Hoist Ring.



# Metric Swivel Hoist Rings

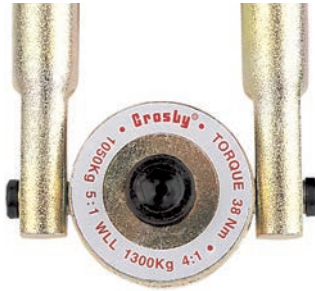

**HR-125M**  
Swivel Hoist Ring

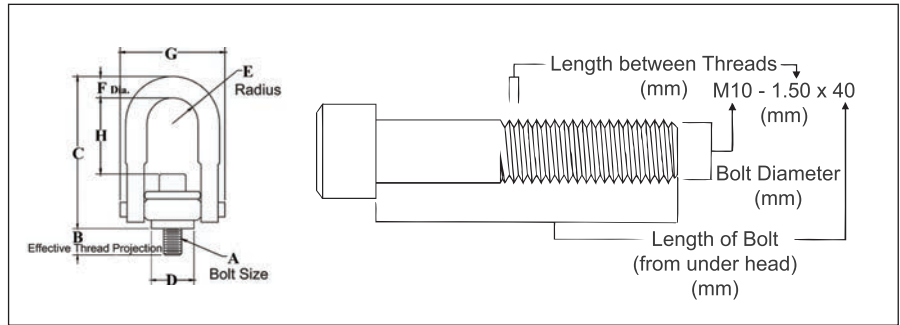

- Top washer has the following features:
  - The Working Load Limit and Recommended Torque value are permanently stamped into each washer.
  - Washer is color coded for easy identification: Silver - Metric thread.
- Individually Proof Tested to 2-1/2 times Working Load Limit.
- Bolt specification is a Grade 12.9 Alloy socket head cap screw to Din 912. All threads listed are metric (ASME B18.3.1m).
- Designed to be used with ferrous workpiece only.
- BOLT SIZE IDENTIFICATION: The size of the bolt will be stated as in the drawing above. Illustration shows meaning of each dimension given.
- NOTE: For Special Applications, see page 457.
- Frame 2 and larger RFID EQUIPPED.



## HR-125M Metric Threads

Frame Size No.	HR-125M Stock No.	Working Load Limit (kg)		Torque in Nm*	Dimensions (mm)							Weight Each (kg)	
		At a 5:1 Design Factor †	At a 4:1 Design Factor †		(A) Bolt Size ‡	(B) Effective Thread Projection Length	C	D	Radius E	Diameter F	G		H
1	1016602	400	500	10	M8X1.25X40	16.9	69.9	24.6	11.8	8.5	47.5	29.9	.17
1	1016613	450	550	16	M10X1.50X40	16.9	69.9	24.6	11.8	8.5	47.5	28.1	.18
2	1016624	1050	1300	38	M12X1.75X50	16.9	123	49.8	22.3	17.5	85.1	60.4	1.05
2	1016635	1900	2400	81	M16X2.00X60	26.9	123	49.8	22.3	17.5	85.1	56.3	1.11
2	1016644	2150	2700	136	M20X2.50X65	31.9	123	49.8	22.3	17.5	85.1	52.3	1.17
3	1016657	3000	3750	136	M20X2.50X75	27.8	167	75.2	34.7	25.4	124	76.6	3.09
3	1016668	4200	5250	312	M24X3.00X80	32.8	167	75.2	34.7	25.4	124	70.5	3.21
4	1016679	7000	8750	637	M30X3.50X120	61.7	222	94.2	44.5	30.5	157	102	6.53
5	1016690	11000	13750	1005	M36X4.00X150	54.0	318	120	60.7	44.5	215	142	16.8
5	1016701	12500	15600	1005	M42X4.50X160	64.0	318	120	60.7	44.5	215	136	17.4
5	1016712	13500	16900	1350	M48X5.00X160	74.0	318	120	60.7	44.5	215	130	18.0

\*The tightening torque values shown are based upon threads being clean, dry and free of lubrication.

† Individually proof loaded to 2-1/2 times the Working Load Limit based on the 4:1 design factor.

‡ Bolt specification is a Grade 12.9 Alloy socket head cap screw to Din 912. All threads are metric (ASME/ANSI B18.3.1m).



# CROSBY SWIVEL HOIST RING

## WARNING & APPLICATION INSTRUCTIONS



**HR-125/SS-125**  
(Red Washer)  
**HR-125M**  
**SS-125M**  
(Silver Washer)



**HR-1000**  
(Red Washer)  
**HR-1000M**  
(Silver Washer)  
**HR-1000CT**  
(Blue Washer)

### Hoist Ring Application Assembly Safety

Use swivel hoist ring only with a ferrous metal (steel, iron) or soft metal (i.e., aluminum) load (workpiece). Do not leave threaded end of hoist ring in aluminum loads for long time periods due to corrosion.

For subsea or marine environment applications, use the HR-1000CT series Hoist Ring only.

- After determining the loads on each hoist ring, select the proper size hoist ring using the Working Load Limit ratings in Tables 1, 2, and 5 for UNC threads and Tables 3, 4 and 6 for Metric threads (on next page).
- Drill and tap the workpiece to the correct size to a minimum depth of one-half the threaded shank diameter plus the threaded shank length. See rated load limit and bolt torque requirements imprinted on top of the swivel trunnion (See Table 1 through Table 6 on next page).
- When a hoist ring is used in a side load application, ensure equal loading on the pins by aligning the bail as shown in (Fig. 3).
- Always be sure total hoist ring bushing mating surface is in contact with the (workpiece) surface. Drilled and tapped hole must be 90 degrees to load (workpiece) surface.
- Install hoist ring to recommended torque with a torque wrench making sure the bushing flange meets the load (workpiece) surface.
- Never use spacers between bushing flange and mounting surface.
- Always select proper load rated lifting device for use with Swivel Hoist Ring.
- Attach lifting device ensuring free fit to hoist ring bail (lifting ring) (Fig. 1).
- Apply partial load and check proper rotation and alignment. There should be no interference between load (workpiece) and hoist ring bail (Fig. 2).
- Special Note: When a Hoist Ring is installed with a retention nut, the nut must have a full thread engagement and must meet one of the following standards to develop the Working Load Limit (WLL).

#### UNC NUTS

- 1. ASTM A-563**  
Grade D  
(Heavy Hex or Hex Thick)  
Grade DH  
Grade DH3
- 2. ASTM A-194**  
Grade 2H  
Grade 4  
Grade 7
- 3. FNL**  
Grade 9
- 4. SAE J995**  
Grade 8

#### METRIC NUTS

- 1. ASTM A-563M**  
Class 10S
- 2. ISO 898-2**  
(EN 20898-2/DIN 267-4)  
Class 10  
Class 12

### Hoist Ring Inspection / Maintenance

- Always inspect hoist ring before use.
- Regularly inspect hoist ring parts.
- Never use hoist ring that shows signs of corrosion, wear or damage.
- Never use hoist ring if bail is bent or elongated.
- Always be sure threads on shank and receiving hole are clean, not damaged, and fit properly.

- Always check with torque wrench before using an already installed hoist ring.
- Always make sure there are no spacers (washers) used between bushing flange and the mounting surface. Remove any spacers (washers) and retorque before use.
- Prior to loading always ensure free movement of bail. The bail should pivot 180 degrees and swivel 360 degrees.

**⚠ WARNING**

- **Loads may slip or fall if proper Hoist Ring assembly and lifting procedures are not used.**
- **A falling load may cause serious injury or death.**
- **Install hoist ring bolt to torque requirements listed in tables 1, 2, 3, 4, 5, & 6 for the HR-125, HR-1000, HR-1000CT, HR-125M, HR-1000M and SS-125.**
- **Read, understand and follow all instructions and chart information.**
- **Do not use with damaged slings, chain, or webbing. For inspection criteria see ASME B30.9.**
- **Use only genuine Crosby parts as replacements.**

### Operating Safety

- Never exceed the capacity of the swivel hoist ring, see Tables 1, 2 and 5 for UNC threads and Tables 3, 4 and 6 for Metric threads. (See next page for tables.)
- When using lifting slings of two or more legs, make sure the forces in the legs are calculated using the angle from the horizontal sling angle to the leg and select the proper size swivel hoist ring to allow for the angular forces.

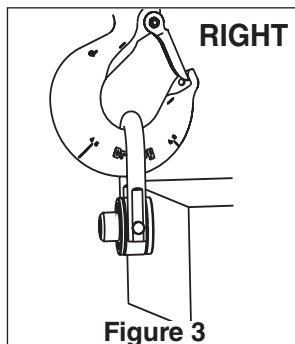
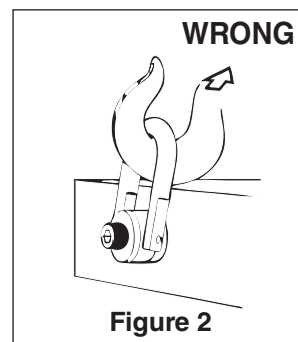
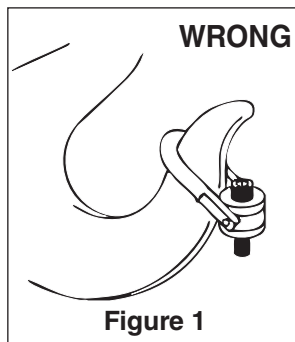

Table 1					
Working Load Limit* 5:1 (lbs.)	Hoist Ring Bolt Torque Ft. lbs. †	HR-125		HR-1000	
		Bolt Size ‡ (in.)	Effective Thread Projection Length (in.)	Bolt Size ‡ (in.)	Effective Thread Projection Length (in.)
800 ††	7	5/16 - 18 x 1.50	.58	5/16 - 18 x 1.50	.52
1000 ††	12	3/8 - 16 x 1.50	.58	3/8 - 16 x 1.50	.52
2500	28	1/2 - 13 x 2.00	.70	1/2 - 13 x 2.25	.69
2500 ††	28	1/2 - 13 x 2.50	1.20	1/2 - 13 x 2.75	1.19
4000	60	5/8 - 11 x 2.00	.70	5/8 - 11 x 2.25	.69
4000 ††	60	5/8 - 11 x 2.75	1.45	5/8 - 11 x 3.00	1.44
5000	100	3/4 - 10 x 2.25	.95	3/4 - 10 x 2.50	.94
5000 ††	100	3/4 - 10 x 2.75	1.45	3/4 - 10 x 3.00	1.44
7000 Ω	100	3/4 - 10 x 2.75	.89	3/4 - 10 x 3.00	.85
7000 ††Ω	100	3/4 - 10 x 3.50	1.64	3/4 - 10 x 3.50	1.35
8000	160	7/8 - 9 x 2.75	.89	7/8 - 9 x 3.00	.85
8000 ††	160	7/8 - 9 x 3.50	1.64	7/8 - 9 x 3.50	1.35
10000	230	1 - 8 x 3.00	1.14	1 - 8 x 3.50	1.35
10000 ††	230	1 - 8 x 4.00	2.14	1 - 8 x 4.50	2.35
15000	470	1-1/4 - 7 x 4.50	2.21	1-1/4 - 7 x 5.00	2.09
24000	800	1-1/2 - 6 x 6.75	2.97	1-1/2 - 6 x 5.50	2.59
30000	1100	2 - 4-1/2 x 6.75	2.97	—	—
50000	2100	2-1/2 - 4 x 8.00	4.00	—	—
75000	4300	3 - 4 x 10.50	5.00	—	—
100000	5100	3-1/2 - 4 x 13.00	7.00	—	—

Ω Ultimate Load is 4.5 times Working Load Limit for 7000# Hoist Ring when tested in 90° orientation. All sizes are individually proof tested to 2-1/2 times the Working Load Limit. \*, †, ††, ‡ (See footnotes at bottom of Table 5).

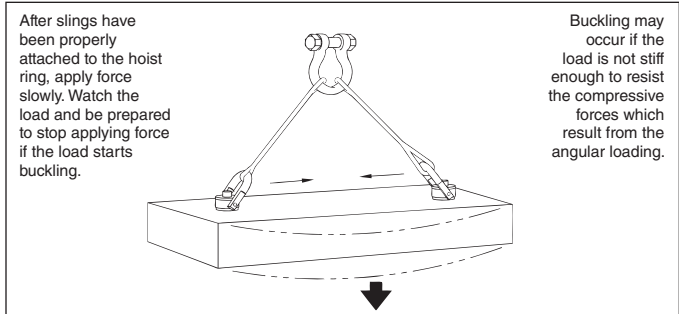
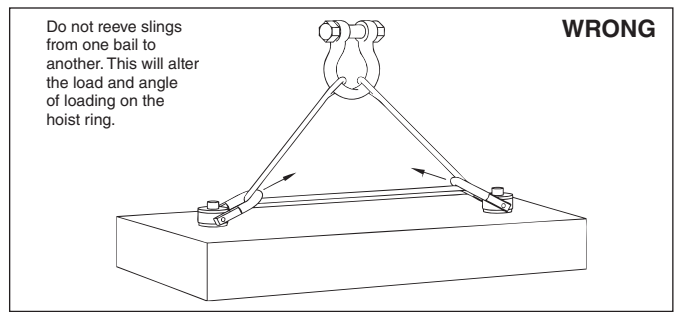

Table 2				
Working Load Limit (kg)****		HR-1000MCT		
Design Factor 5:1	Design Factor 4:1	Hoist Ring Bolt Torque in (Nm) †	Bolt Size (mm) ‡	Effective Thread Projection Length (mm)
825	1030	38	M12 x 1.75 x 55	15.6
1350	1690	81	M16 x 2.00 x 65	25.5
2250	2810	136	M20 x 2.50 x 80	25.3
3175	3970	312	M24 x 3.00 x 90	35.4
5450	6810	637	M30 x 3.50 x 140	65.9
7450	9310	1005	M36 x 4.00 x 130	56.3
13250	16560	1350	M48 x 5.00 x 180	50.7

Table 3			
HR-1000CT			
Working Load Limit 5:1 (lbs.)****	Hoist Ring Bolt Torque in (Ft.-lbs.) †	Bolt Size (in.) Δ	Effective Thread Projection Length (in.)
1900	28	1/2 - 13 x 2.25	.70
1900	28	1/2 - 13 x 2.75	1.20
3000	60	5/8 - 11 x 2.25	.70
4800	100	3/4 - 10 x 3.00	.85
6200	160	7/8 - 9 x 3.00	.85
8300	230	1 - 8 x 3.50	1.35
12500	470	1 1/4 - 7 x 5.00	2.10
20000	800	1 1/2 - 6 x 5.50	2.60
20000	800	1 1/2 - 8 x 5.50	2.60
28000	1100	2 - 4.5 x 7.50	3.20
45000	2100	2 1/2 - 4 x 9.50	3.73

Table 4						
Working Load Limit (kg)***		Hoist Ring Bolt Torque in Nm †	HR-125M		HR-1000M	
Design Factor 5:1	HR-125M Design 4:1		Bolt Size ‡ (mm)	HR-125M Effective Thread Projection Length (mm)	Bolt Size ‡ (mm)	HR-1000M Effective Thread Projection Length (mm)
400	500	10	M 8 X 1.25 X 40	16.9	M 8 X 1.25 X 40	15.2
450	550	16	M 10 X 1.50 X 40	16.9	M 10 X 1.50 X 40	15.2
1050	1300	38	M 12 X 1.75 X 50	17.2	M 12 X 1.75 X 55	15.5
1900	2400	81	M 16 X 2.00 X 60	27.2	M 16 X 2.00 X 65	25.5
2150	2700	136	M 20 X 2.50 X 65	31.2	M 20 X 2.50 X 70	30.5
3000	3750	136	M 20 X 2.50 X 75	28.1	M 20 X 2.50 X 80	25.4
4200	5250	312	M 24 X 3.00 X 80	33.1	M 24 X 3.00 X 90	35.4
7000	8750	637	M 30 X 3.50 X 120	65.1	M 30 X 3.50 X 140	66.2
11000	13750	1005	M 36 X 4.00 X 150	60.6	M 36 X 4.00 X 150	56.2
12500	15600	1005	M 42 x 4.50 x 160	70.6	—	—
13500	16900	1350	M 48 x 5.00 x 160	101	—	—
22300	27900	2847	M 64 x 6.00 x 204	101	—	—
31500	39400	5830	M 72 x 6.00 x 265	132	—	—
44600	55800	6914	M 90 x 6.00 x 330	177	—	—

See Footnotes on next page.

† Tightening torque values shown are based upon threads being clean, dry and free of lubrication.

**Footnotes below relate to tables 1-4**

\* Ultimate load is 5 times the Working Load Limit. Individually proof tested to 2-1/2 times the Working Load Limit.

\*\* Ultimate load is 4 times the Working Load Limit. Individually proof tested to 2-1/2 times the Working Load Limit.

\*\*\* Individually proof tested to 2-1/2 times the Working Load Limit based on 4:1 design factor

\*\*\*\* Ultimate load is 5 times the Working Load Limit. Individually proof tested to 2 times the Working Load Limit.

†† Long bolts are designed to be used with soft metal (i.e., aluminum) workpiece. While the long bolts may also be used with ferrous metal (i.e., steel & iron) workpieces, short bolts are designed for ferrous workpieces only.

‡ Bolt specification is a Alloy socket head cap screw to ASTM A574. All threads are UNC .

†† Bolt specification is a Grade 12.9 Alloy socket head cap screw to DIN 912. All threads are metric (ASME/ANSI B18.3.1m)

Δ Bolt specification is a Grade L7 or L43 Alloy socket head cap screw to ASTM A320. All threads are UNC.

††† Tighten bolt to specified torque, then tighten nut to specified torque.

**All Swivel Hoist Rings are individually proof tested.**

Table 5			
SS-125 ¥¥			
Working Load Limit (lbs.) ¥	Torque in Ft.-lbs. †	Bolt Size (in.) §	Effective Thread Projection (in.)
400	3.5	5/16 - 18 x 1	.29
400	3.5	5/16 - 18 x 1.25	.54
500	6	3/8 - 16 x 1.25	.54
1250	14	1/2 - 13 x 2	.78
1250	14	1/2 - 13 x 2.25	1.03
1250	14	1/2 - 13 x 2.5	1.28
2000	30	5/8 - 11 x 2	.78
2000	30	5/8 - 11 x 2.25	1.03
2000	30	5/8 - 11 x 2.5	1.28
2500	50	3/4 - 10 x 2.25	1.03
2500	50	3/4 - 10 x 2.75	1.53
3500	50	3/4 - 10 x 2.75	1.04
3500	50	3/4 - 10 x 3.25	1.54
4000	80	7/8 - 9 x 2.75	1.04
4000	80	7/8 - 9 x 3	1.29
5000	115	1 - 8 x 3	1.29
5000	115	1 - 8 x 3.25	1.54
5000	115	1 - 8 x 4	2.29
7500	235	1-1/4 - 7 x 4	1.89
12000	400	1-1/2 - 6 x 5.5	2.70
15000	550	2 - 4-1/2 x 5.75	2.96
25000	1050	2-1/2 - 4 x 8	4.00
25000	1050	2-1/2 - 8 x 8	4.00
37500	2150	3 - 4 x 10.25	5.00
50000	2550	3-1/2 - 4 x 13	7.00

Table 6			
SS-125M ¥¥			
SS-125M ¥¥ Working Load Limit (kg) ¥	Torque in Lbs. †	Bolt Size (mm) §§	Effective Thread Projection (mm)
200	4	M 8 x 1.25x30	13
250	8	M 10 x 1.50x35	18
525	18	M 12 x 1.75x50	19
950	40	M 16 x 2.00x60	29
1075	68	M 20 x 2.50x65	34
1500	68	M 20 x 2.50x75	32
2100	108	M 24 x 3.00x80	37
2100	108	M 30 x 3.50x110	58
3500	318	M 30 x 3.50x95	42
3500	318	M 30 x 3.50x115	62
5500	542	M 36 x 4.00x135	64
6250	542	M 42 x 4.50x155	82
6750	746	M 48 x 5.00x155	82
11150	1423	M 64 x 6.00x205	101
15750	2915	M 72 x 6.00x265	132
22300	3459	M 90 x 6.00x330	177

**Footnotes below relate to Tables 5 and 6**

¥ Ultimate load is 5 times the Working Load Limit. Individually proof tested to 2 times the Working Load Limit.

¥¥ All components are 316 Stainless Steel, except Bolt Retainers, which are made from 15-7 PH (UNS 15700) magnetic stainless steel.

§ Bolt specification is 316 Stainless Steel socket head cap screw to ASTM F837 Group 1 (316).

§§ Bolt specification is 316 Stainless Steel socket head cap screw to ASTM F837M (316). All threads are Metric (ASME/ANSI B18.3.1M).