

TOOL GUIDE

FOR EVERYDAY MACHINING



DoubleJet JET-STREAM™

No-Vibration Solution Tool!™

DoubleJet KOOL-CUT™

TABLE OF CONTENTS

Carbide Turning Inserts	3
Square Shank Toolholders	17
Boring Bars	26
Jet-Stream Toolholders and Bars	33
Carbide Boring Bars	40
No-Vibration Solution Tool! TM Bars	46
Threading Tools and Inserts	59
Kool-Cut Turning - Grooving - Part Off	63
Swiss Toolholders	76
Knurling Tools	81
Milling Cutters and Inserts	104
Live Centers	117
Tool Post and Quick Change Holders	129
Angle Heads	143
CAT 40 & 50 V-Flange Tooling	151
Retention Knobs	154
ER Collets	155
Tool Presetters	157
Smart Tool-Setter Tightening Fixtures	159

CARBIDE INSERTS

TECHNOLOGY, QUALITY & PERFORMANCE

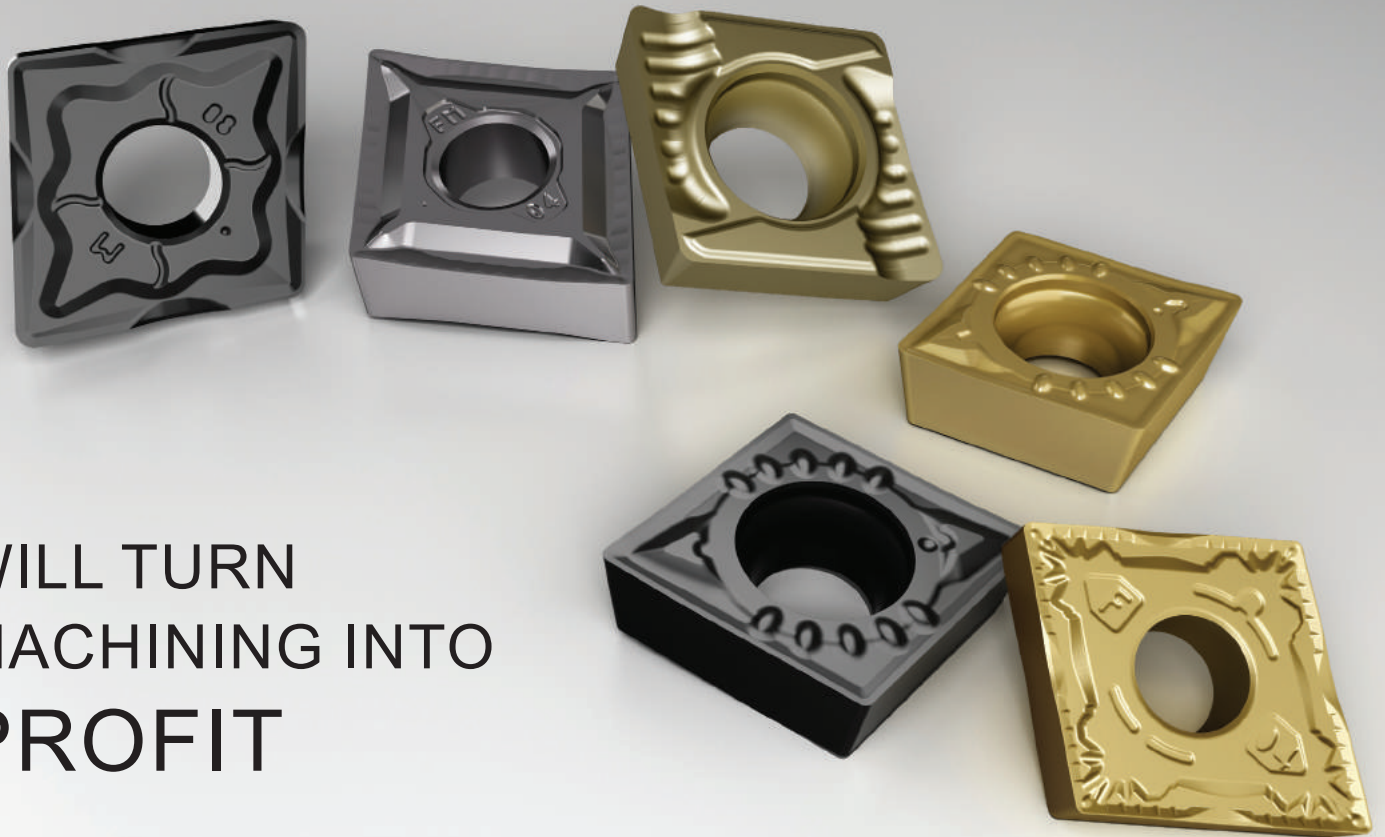

WILL TURN
MACHINING INTO
PROFIT

Material	Turning Application			Grade Specification			Material Application								
	Uninterrupted Cut	Universal	Interrupted Cut	ANSI Grade	ISO Grade	Uncoated	PVD Coated	CVD Coated	<ul style="list-style-type: none"> ● First Choice ○ Second Choice 						
	Hard Wear Resistant	Hard & Tough Impact & Wear Resistant	Tough Impact Resistant												
	05 01	15 10	25 20	35 30	45 40	50									
	High Cutting Speed	Medium Cutting Speed	Low Cutting Speed							P	M	K	N	S	H
P Carbon Steel & Alloy Steel				C6-C7	P20-P35 M20-M35	●			●	○					
				C6-C7	P10-P25 M10-M25		●		●		○				○
				C5-C6	P15-P35 M15-M35		●		●	○					
				C5	P25-P45 M25-M45		●		●	○					
M Stainless Steel				C6-C7	P30 M25		●		○	●					
				C5-C6	P35 M35		●		○	●					
K Cast Iron Ferrous Metal & Material				C3-C4	M10-K10 S10	●					●				
				C2-C3	K10 P10 M10		●			●					○
				C1-C2	K15 P15 M15		●			●					○
N Aluminum Non Ferrous Material				C3-C7	K15 P10 M15 N15 S15	●						●			
				C1-C3	K25 P25 M25 N25 S25	●						●			
				C4-C8	M10 K10-N10 S10		●		○	○		○		○	○
				C1-C3	P10 M15 K25-S25		●					●		○	
S High Temp Super Alloy Multi Material				C3-C4	M10 K10-N10 S10		●			○				●	
				C4-C8	P10 M10 K10 N10 S10		●			○				●	
				C3-C8	M20 K20 N20 S20		●			○				●	○
				C3-C7	P15 M15 K15 N25 S25		●		●	●	●	●	●	●	○
				C3-C7	P20 M25 K30 N30 S30		●		●	●	●	●	●	●	○

Insert Grades

- 1 If inserts wear, reduce Spindle Speed RPM (n) increase Feed (fn) or change to a harder insert grade.
- 2 If inserts chip, increase Spindle Speed (n), decrease Feed (fn), or change to tougher insert grade.
- 3 For uninterrupted, continuous cuts, use hard and wear resistant insert.
- 4 For forgings, castings and interrupted cuts, use tough and impact resistant insert with larger nose radius.

DPP30GT

General Purpose for Alloy Steels. Second choice for Stainless Steels
P30 (P15-P35) Substrate
Thermal deformation and abrasion resistant substrate with PVD TiN

DPC15HT

For high speed turning of Alloy Steels, up to 1000+ SFM.
Most wear resistant steel grade
Second choice for machining cast irons
Second choice for finishing operation on Duplex, 316 and 316L (positive geometries only)
P15 (P10-P25) Fine Grain Substrate (1600 Vickers)
Not for interrupted cuts
CVD Al₂O₃/TiN/TiCN/Alpha Al₂O₃/Nano-TiCN/MT-TiCN/TiN Nanolock Coating Technology (22 microns)

DPC25UT

Universal Turning Grade for Alloy Steels and easy to machine Stainless Steels (316, 316L)
Medium Cutting Speeds, ideally at 400-820 SFM.
For light interrupted and continuous cuts
P25 (P15-P35) Substrate (1550 Vickers)
CVD Al₂O₃/TiN/TiCN/Alpha-Al₂O₃/Nano-TiCN/MT-TiCN/TiN Nanolock Coating Technology (22 microns)

DPC35RT

For heavily interrupted cuts, forgings, castings and uneven surfaces
Tough and impact resistant substrate
Slow cutting speeds, ideally at 160-490 SFM.
P40 (P25-P40) Substrate (1450 Vickers)
For Steels and Stainless Steels
CVD TiN/Al₂O₃/TiCN Nanolock Technology Coating

DMC25HT

High Performance Machining of austenitic stainless steels at higher SFM
M25 (M15-M30) Substrate
Not for interrupted cuts
High cutting speeds, ideally at 400-660 SFM.
PVD Hyper 8 AlTiN Coating

DMC30UT

Tougher alternative to DMC25HT grade for stainless steels
General Purpose for interrupted and continuous cuts
For medium cutting speeds, ideally at 390-560 SFM.
M30 (M25-M40) Substrate (1475 Vickers)
CVD TiN/TiCN/TiN Coating

DKU10HT

Wear and abrasion resistant, uncoated substrate
Not for interrupted cuts
K10 Substrate
For hardened materials, and abrasive materials
For very fine cuts

DKC10UT

Most wear resistant substrate for Nodular, Ductile and Gray Cast Irons and Hardened Steels
K10 (K05-K15) Substrate (1700 Vickers)
Up to 1300 SFM on Gray Cast Iron (GG)
For high cutting speeds, 1000 SFM and above
TAG-Turbo CVD Al₂O₃/TiC/TiCN/TiN Coating with special adhesion interlocking layer
For uninterrupted cuts

DKC15RT

Tougher alternative to DKC10UT, for cast irons
Optimal grade for Nodular Cast Iron (GG) and Gray Cast Iron (GGG)
K15 (K10-K20) Substrate (1600 Vickers)
CVD Al₂O₃/TiC/TiCN/TiN Coating
Suitable for interrupted cuts in cast irons

DNU10GT

Uncoated, high wear resistant grade for aluminum, non-ferrous metals and plastics
K10 (K05-K15) Substrate

DNU25GT

Uncoated, high wear resistant grade for aluminum, non-ferrous metals and plastics
K25 Micrograin Substrate
For continuous and light interrupted cuts

DNX10UT

Coated version of DNU10GT
High wear resistant grade for machining aluminum, non-ferrous metals and plastics
Micropulse Plasma TiAlN coating, ideal for finish machining (fine cuts) of stainless steels and high temp alloys

DNP25GT

Universal grade for high temp alloys, aluminum, non-ferrous and ferrous materials
S25 Substrate with PVD TiN Coating
Not for interrupted cuts

DSP10HT

For Titanium and Titanium Alloys (unalloyed Ti, alpha-alloys, alpha-beta alloys, beta-alloys)
S10 Substrate (1700 Vickers) with CVD TiB₂/TiN coating
For cutting speeds 100-230 SFM.

DSP15HT

Hardest grade for High Temp Alloys
Medium to rough machining of high temp alloys and finish machining of stainless steels
With SER chip-breaker, also suitable for Interrupted machining of high temp alloys
With SEF & SEM chip-breakers, also use on aluminum, non-ferrous metals and plastics
Submicron K30 Substrate with 3 micron PVD Super-Nitride AlTiN Coating

DSP20HT

Tougher alternative to DUP35RT grade
For high temp alloys Inconel 718, Inconel 625, Nimonic, Udimet, Hastelloy, Waspalloy
Submicron S20 Substrate (1700 Vickers) with 8 micron PVD AlTiN coating
For cutting speeds 100-220 SFM.

DUP15VT

Hard & wear resistant for high temp alloys, aluminum, non-ferrous and ferrous materials
S15 Substrate with PVD AlCrN Coating
Not for interrupted cuts



DUP25GT

Universal grade for high temp alloys, aluminum, non-ferrous and ferrous materials
S25 Substrate with PVD TiAlN/WC/C Coating
Not for interrupted cuts

DUP35RT

Tough, roughing grade for multi-material applications.
For roughing of small parts with interrupted cuts.











Negative Inserts

Material	Application	Chip Breaker	Insert	Grade		SFM Surface foot per minute	a _p Depth of Cut inch	f _n Feed Rate inch per Rev		
				← Harder	Tougher →					
P Steel & Alloy Steel	Finishing	PEF		DPC15HT		330	1188	.004" - .079"	.002" - .008"	
					DPC25UT		281			1010
	Medium	PEM		DPC15HT		330	1188	.031" - .197"	.006" - .016"	
					DPC25UT		281			1010
					DPC35RT		165			594
	Roughing	PER		DPC15HT		330	1188	.047" - .315"	.013" - .030"	
					DPC25UT		281			1010
					DPC35RT		165			594
	Wiper (High Surface Finish)	PEX		DPC15HT		330	1188	.060" - .157"	.008" - .031"	
					DPC25UT		281			1010
	Medium and Precision Finishing	UEM		DPC15HT		330	1188	.020" - .157"	.003" - .013"	
					DPC25UT		281			1010
				DPC35RT		165	594			
For Thin Wall Tubing & Deep Boring	UEX		DPC15HT		330	1188	.039" - .126"	.008" - .018"		
				DPC25UT		281			1010	
				DPC35RT		165			594	
Roughing	PSH		DPC15HT		330	1188	.079" - .492"	.016" - .063"		
				DPC25UT		281			1010	
				DPC35RT		165			594	
Heavy Roughing	PSS		DPC15HT		330	1188	.079" - .492"	.016" - .063"		
				DPC25UT		281			1010	
				DPC35RT		165			594	
Extra Heavy Duty Roughing	PST		DPC15HT		330	1188	.098" - .492"	.031" - .063"		
				DPC25UT		281			1010	
				DPC35RT		165			594	
M Stainless Steel	High Performance	MEH		DMC25HT		400	660	.039" - .148"	.007" - .017"	
	Finishing	MEF		DMC30UT				.020" - .157"	.004" - .013"	
	Medium	MEM		DMC30UT		238	594	.047" - .217"	.006" - .016"	
	Roughing	MER		DMC30UT				.047" - .305"	.013" - .031"	
K Cast Iron	Finishing	KEF		DKC10UT		376	891	.004" - .080"	.002" - .012"	
	Roughing	KER		DKC10UT DKC15RT		376 314	891 743	.032" - .472"	.012" - .024"	
S Titanium & Super Alloy	High Performance	SEH		DSP10HT (Titanium Only)		230	100	.039" - .138"	.003" - .018"	
				DSP20HT		200	100			
S Titanium - Super Alloy & Multi-Material	Finishing	SEF		DSP15HT				.020" - .157"	.003" - .010"	
	Medium	SEM		DSP15HT		100	1066	.039" - .138"	.004" - .013"	
	Roughing	SER		DSP15HT				.047" - .236"	.006" - .016"	



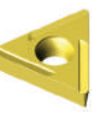





Positive Inserts

Material	Application	Chip Breaker	Insert	Grade		SFM Surface foot per minute	a _p Depth of Cut inch	f _n Feed Rate inch per Rev	
				Harder	Tougher				
S Multi-Material	General Purpose	UEF		DNU25GT		83	545	.002" - .039"	.002" - .008"
	Universal			DUP25GT		96	1123		
	Unstable Condition			DUP35RT		92	1066		
	General Purpose	UEU		DUP15VT		119	1403	.002" - .039"	.002" - .008"
	Universal			DUP25GT		96	1123		
	Unstable Condition			DPC35RT		92	1066		
P Steel & Alloy Steel	Finishing	PEF		DPC15HT		330	1188	.004" - .079"	.002" - .008"
				DPC25UT		281	1010		
				DPC35RT		165	594		
	Medium	PEM		DPC15HT		330	1188	.031" - .197"	.006" - .016"
				DPC25UT		281	1010		
				DPC35RT		165	594		
	Universal	PEU		DPC15HT		330	1188	.020" - .157"	.006" - .016"
				DPC25UT		281	1010		
				DPC35RT		165	594		
	High Performance	UEX		DPC15HT		330	1188	.039" - .126"	.008" - .018"
	Universal			DPC25UT		281	1010		
	Unstable Condition			DPC35RT		165	594		
M Stainless Steel	High Performance	MEH		DMC25HT		400	660	.039" - .148"	.007" - .017"
	Universal	MEM		DCM30UT		238	594	.047" - .217"	.006" - .016"
K Cast Iron	General Application	KEM		DKC15RT		59	743	.008" - .125"	.002" - .012
N Aluminum	General Purpose	NFU		DNU10GT		446	6353	.039" - .315"	.003" - .039"
	High Performance			DNX10UT		581	7623		
S Titanium & Super Alloy	High Performance	SEH		DSP10HT (Titanium Only)		230	100	.039" - .138"	.003" - .018"
				DSP20HT		200	100		

Multi-Material Applications Positive Precision Ground Inserts

Description	ANSI	Grade	Grade	Grade
		DNU25GT	DUP25GT	DUP35RT
CDGX-UEFR 80° Diamond Universal Right Hand 	CDGX-1.510.5-UEFR	68562	68563	68564
	CDGX-1.511-UEFR	68572	68573	68574
CDGX-UEFL 80° Diamond Universal Left Hand 	CDGX-1.510.5-UEFL	68567	68568	
	CDGX-1.511-UEFL	68577	68578	
CCGX-UEFR 80° Diamond Universal Right Hand 	CCGX-21.51-UEFR	68592	68593	68594
CCGX-UEFL 80° Diamond Universal Left Hand 	CCGX-21.51-UEFL	68597	68598	
DCGX-UEFR 55° Diamond Universal Right Hand 	DCGX-21.51-UEFR	68712	68713	68714
DCGX-UEFL 55° Diamond Universal Left Hand 	DCGX-21.51-UEFL	68717	68718	68719
TCGX-UEFR 60° Triangle Universal Right Hand 	TCGX-21.50.5-UEFR	68762	68763	68764
	TCGX-21.51-UEFR	68772	68773	68774
VBGX-UEFR 35° Diamond Universal Right Hand 	VBGX-221-UEFR	68902	68903	
VBGX-UEFL 35° Diamond Universal Left Hand 	VBGX-221-UEFL	68907	68908	68909
VCGX-UEFR 35° Diamond Universal Right Hand 	VCGX-221-UEFR	68962	68963	68964
VCGX-UEFL 35° Diamond Universal Left Hand 	VCGX-221-UEFL	68967	68968	68969



Multi-Material Applications Positive Precision Ground Inserts

Description	ANSI	Grade	Grade	Grade	Grade
		DNU10GT	DUP15VT	DUP25GT	DUP35RT
CCGT-UEU 80° Diamond Universal 	CCGT-21.50.2-UEU	79450	79451		
	CCGT-21.50.5-UEU			79453	79454
	CCGT-21.51-UEU	79455	79456	79458	79459
	CCGT-32.50.5-UEU			79463	79464
	CCGT-32.51-UEU	79465	79466	79468	79469
	CCGT-431-UEU	79475	79476	79478	79479
CPGT-UEU 80° Diamond Universal 	CPGT-1.81.20.5-UEU	79485	79486	79488	79489
	CPGT-1.81.21-UEU	79490	79491	79493	79494
	CPGT-21.51-UEU	79500	79501	79503	79504
	CPGT-32.50.5-UEU	79507		79508	79509
	CPGT-32.51-UEU	79510	79511	79513	79514
DCGT-UEU 55° Diamond Universal 	DCGT-21.50.2-UEU	79530	79531		
	DCGT-21.50.5-UEU			79533	79534
	DCGT-21.51-UEU	79535	79536	79538	79539
	DCGT-32.50.2-UEU	79540	79541		
	DCGT-32.50.5-UEU			79543	79544
	DCGT-32.51-UEU	79545	79546	79548	79549
	DCGT-32.52-UEU	79550	79551	79553	79554
	DCGT-431-UEU	79555	79556	79558	79559
TCGT-UEU 60° Triangle Universal 	TCGT-21.50.2-UEU	79585	79586	79588	79589
	TCGT-21.50.5-UEU			79593	79594
	TCGT-21.51-UEU	79595	79596	79598	79599
	TCGT-32.50.5-UEU			79608	79609
	TCGT-32.51-UEU	79610	79611	79613	79614
	TCGT-32.52-UEU	79615	79616	79618	79619
TPGT-UEU 60° Triangle Universal 	TPGT-21.50.2-UEU			79623	79624
	TPGT-21.50.5-UEU			79628	79629
	TPGT-21.51-UEU	79630	79631	79633	79634
	TPGT-32.50.5-UEU			79643	79644
	TPGT-32.51-UEU	79645	79646	79648	79649
	TPGT-32.52-UEU	79650	79651	79653	79654
VBGT-UEU 35° Diamond Universal 	VBGT-221-UEU	79660	79661	79663	79664
	VBGT-331-UEU	79670	79671	79673	79674
	VBGT-332-UEU	79675	79676	79678	79679
VCGT-UEU 35° Diamond Universal 	VCGT-220.2-UEU	79680	79681		
	VCGT-220.5-UEU			79683	79684
	VCGT-221-UEU	79685	79686	79688	79689
	VCGT-330.5-UEU			79698	79699
	VCGT-331-UEU	79700	79701	79703	79704
WCGT-UEU 80° Trigon Universal 	VCGT-332-UEU	79705	79706	79708	79709
	WCGT-1.51.50.2-UEU	79710	79711	79713	79714
	WCGT-1.51.50.5-UEU	79715	79716	79718	79719
	WCGT-21.51-UEU	79725	79726	79728	79729
	WCGT-32.51-UEU	79735	79736	79738	79739
		79741	79743	79744	

Multi-Material Applications Positive Precision Ground Inserts

Description	ANSI	Grade DKU10HT	Grade DUP15VT	Grade DUP35RT
CDGW-KEU 80° Diamond Universal 	CDGW-1.20.60.2-KEU	79340	79341	79343
	CDGW-1.20.60.5-KEU	79344	79345	79347
	CDGW-1.510.5-KEU	79348	79349	79351
	CDGW-1.511-KEU	79352	79353	79355
CCGW-KEU 80° Diamond Universal 	CCGW-21.51-KEU	79356	79357	79359
	CCGW-32.52-KEU	79364	79365	79367
CPGW-KEU 80° Diamond Universal 	CPGW-1.81.20.5-KEU	79368	79369	79371
	CPGW-1.81.21-KEU	79372	79373	79375
	CPGW-21.51-KEU	79376	79377	79379
	CPGW-32.51-KEU	79380	79381	79383
	CPGW-32.52-KEU	79384	79385	79387
DCGW-KEU DCMW-KEU 55° Diamond Universal 	DCGW-21.51-KEU	79388	79389	79391
	DCMW-32.51-KEU	70770		
	DCMW-32.52-KEU	70771		
TCGW-KEU 60° Triangle Universal 	TCGW-21.51-KEU	79400	79401	79403
	TCGW-32.52-KEU	79408	79409	79411
TPGW-KEU 60° Triangle Universal 	TPGW-21.51-KEU	79412	79413	79415
	TPGW-32.51-KEU	79416	79417	79419
	TPGW-32.52-KEU	79420	79421	79423
VBGW-KEU 35° Diamond Universal 	VBGW-221-KEU	79424	79425	79427
	VBGW-331-KEU	79428	79429	79431
	VBGW-332-KEU	79432	79433	79435
VCGW-KEU 35° Diamond Universal 	VCGW-221-KEU	79436	79437	79439
	VCGW-331-KEU	79440	79441	79443
	VCGW-332-KEU	79444	79445	79447

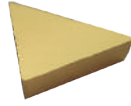
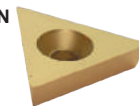
Multi-Material Applications Positive Precision Ground Inserts

Description	ANSI	Grade DNU25GT	Grade DNP25GT	Grade DPP30GT
TPG-UEN 60° Triangle General Purpose 	TPG-221-UEN		71607	71608
	TPG-222-UEN	71611	71613	
	TPG-321-UEN	71617	71619	71620
	TPG-322-UEN	71623	71625	71626
	TPG-431-UEN	71629	71631	71632
	TPG-432-UEN	71635	71637	71638
TPGB-UEN 60° Triangle General Purpose 	TPGB-21.51-UEN	71652		71654
	TPGB-21.52-UEN	71655		71657
	TPGB-321-UEN	71659		71661
	TPGB-322-UEN	71662		71664
TPGH-UEN 60° Triangle General Purpose 	TPGH-21.51-UEN	71700	71703	71704
	TPGH-21.52-UEN	71706	71709	71708
	TPGH-321-UEN	71712	71716	71715
	TPGH-322-UEN	71718	71720	71722
TPHT-UEN 60° Triangle General Purpose 	TPGH-431-UEN	71726	71728	71730
	TPGH-432-UEN	71734	71737	71736
	TPHT-32.51-UEN	71748	71750	71751
	TPHT-32.52-UEN	71753	71755	71756

Positive Convex Radius Inserts for Multi-Material Applications

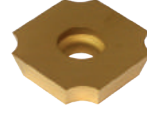

Description	ANSI	Radius	Grade DNU25GT	Grade DUP25GT
SDGX-UEN 3/8" Square Convex Radius 	SDGX-09C01-E	.016"		95299
	SDGX-09C03-E	.047"	95305	95307
	SDGX-09C04-E	.062"	95309	95311
SDGX-UEN 3/4" Square Convex Radius 	SDGX-19C05-E	.078"		95250
	SDGX-19C06-E	.094"	95253	95254
	SDGX-19C07-E	.109"	95257	95258
	SDGX-19C08-E	.125	95261	95262
	SDGX-19C09-E	.141"		95266
	SDGX-19C10-E	.156"	95269	95270
	SDGX-19C11-E	.178"		95274
	SDGX-19C12-E	.188"	95277	95278
	SDGX-19C13-E	.203"		95282
	SDGX-19C14-E	.219"	95285	95286
	SDGX-19C15-E*	.234"	95289	95290
SDGX-19C16-E*	.250"	95293	95294	

*All SDGX inserts have 4 cutting edges, except .234" & .250" radius inserts that have 2 cutting edges.

Aluminum Applications Ground & Polished Inserts

Description	ANSI	Grade DNU10GT	Grade DNX10UT
CCGT-NFU 80° Diamond Universal 	CCGT-21.50.5-NFU	80020	80021
	CCGT-21.51-NFU	80024	80025
	CCGT-32.50.5-NFU	80028	80029
	CCGT-32.51-NFU	80032	80033
	CCGT-32.52-NFU	80036	80037
	CCGT-431-NFU	80040	80041
	CCGT-432-NFU	80044	80045
DCGT-NFU 55° Diamond Universal 	DCGT-21.50.5-NFU	80048	80049
	DCGT-21.51-NFU	80052	80053
	DCGT-32.50.5-NFU	80056	80057
	DCGT-32.51-NFU	80060	80061
	DCGT-32.52-NFU	80064	80065
RCMT-NFU Round Universal 	RCMT-0602MO-NFU	70798	
RCGT-NFU Round Universal 	RCGT-0602MO-NFU	80068	80069
	RCGT-0803MO-NFU	80072	80073
	RCGT-1003MO-NFU	80076	80077
SCGT-NFU Square Universal 	SCGT-432-NFU	80084	80085
TCGT-NFU 60° Triangle Universal 	TCGT-21.51-NFU	80089	80090
	TCGT-32.51-NFU	80093	80094
VCGT-NFU 35° Triangle Universal 	VCGT-220.5-NFU	80098	80099
	VCGT-221-NFU	80103	80104
	VCGT-330.5-NFU	80107	80108
	VCGT-331-NFU	80111	80112
	VCGT-332-NFU	80115	80116
	VCGT-333-NFU	80119	80120
	VCGT-448-NFU	80123	80124
VPGT-NFU 35° Triangle Universal 	VPGT-444-NFU	80135	
WCGT-NFU 80° Trigon Universal 	WCGT-32.50.5-NFU		80141
	WCGT-32.51-NFU	80144	80145
	WCGT-32.52-NFU	80148	80149
	WCGT-431-NFU		80153
	WCGT-432-NFU	80156	80157

Titanium & High Temp Alloy Applications Positive Inserts

Description	ANSI	Titanium Grade	High Temp Grade	
		DSP10HT	DSP15HT	DSP20HT
CCMT-SEH 80° Diamond Universal 	CCMT-32.51-SEH	69725		69722
DCMT-SEH 55° Diamond Universal 	DCMT-32.51-SEH	69728		69729
RCMT-SEH Round Roughing 	RCMX-1204MO-UEx		71960	
	RCMT-1606MO-SEH	69732		
	RCMT-2006MO-SEH	69734		

Stainless Steel Applications Positive Inserts

Description	ANSI	Grade DMC25HT	Grade DMC30UT
CCMT-MEM 80° Diamond Finishing/Medium 	CCMT-32.51-MEM		70750
	CCMT-32.52-MEM		70751
	CCMT-431-MEM		70752
	CCMT-432-MEM		70756
CCMT-MEH 80° Diamond High Performance 	CCMT-21.50.5-MEH	70270	70271
	CCMT-21.51-MEH	70272	70273
	CCMT-32.51-MEH	70274	
	CCMT-32.52-MEH	70275	
	CCMT-431-MEH	70276	
	CCMT-432-MEH	70277	
DCMT-MEF 55° Diamond Finishing 	DCMT-21.50.5-MEF		71810
	DCMT-32.50.5-MEF		71814
DCMT-MEM 55° Diamond Medium 	DCMT-32.51-MEM		70760
	DCMT-32.52-MEM		70761
DCMT-MEH 55° Diamond High Performance 	DCMT-21.51-MEH		71813
	DCMT-32.51-MEH	71816	
	DCMT-32.52-MEH	71817	
SCMT-MEM Square Medium 	SCMT-432-MEM		70772
TCMT-MEM 60° Triangle Medium 	TCMT-21.51-MEM		70776
	TCMT-21.52-MEM		70777
	TCMT-32.51-MEM		70778
	TCMT-32.52-MEM		70779
VCMT-MEM 35° Diamond Medium 	VCMT-331-MEM		70783
	VCMT-332-MEM		70784
	VCMT-333-MEM		70785
VCMT-MEH 35° Diamond Medium 	VCMT-331-MEH	77934	
	VCMT-332-MEH	77935	
	VCMT-333-MEH	77936	
VBMT-MEH 35° Diamond Medium 	VBMT-331-MEH	77930	77931
	VBMT-332-MEH	77932	77933



Cast Iron Applications Positive Inserts

Description	ANSI	Grade DKC10UT	Grade DKC15RT
CCMT-KEM 80° Diamond Finishing/Medium 	CCMT-32.51-KEM		70753
	CCMT-32.52-KEM		70754
	CCMT-432-KEM		70755
DCMT-KEM 55° Diamond Finishing/Medium 	DCMT-21.51-KEM	70762	70763
	DCMT-21.52-KEM	70764	70765
	DCMT-32.51-KEM	70766	70767
	DCMT-32.52-KEM	70768	70769
SCMT-KEM Square Medium 	SCMT-432-KEM		70773
RCMX-UEX Round Medium 	RCMX-1606MO-UEX	71964	71965
	RCMX-2006MO-UEX	71969	71970
	RCMX-2507MO-UEX	71974	71975
	RCMX-3209MO-UEX	71978	71979





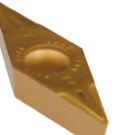

Alloy Steel Applications Positive Inserts

Description	ANSI	Grade DPC15HT	Grade DPC25UT	Grade DPC35RT
CCMT-PEF 80° Diamond Finishing 	CCMT-21.50.5-PEF	71873	71874	
	CCMT-21.51-PEF	71877	71878	
	CCMT-21.52-PEF	71879	71880	
	CCMT-32.51-PEF	71883	71884	
	CCMT-32.52-PEF	71885	71886	
	CCMT-431-PEF	71889	71890	
CCMT-PEM 80° Diamond Medium 	CCMT-21.50.5-PEM	71875	71876	
	CCMT-21.51-PEM	71933	71934	
	CCMT-21.52-PEM	71881	71882	
	CCMT-32.51-PEM	71935	71936	
	CCMT-32.52-PEM	71887	71888	
	CCMT-431-PEM	71937	71938	
	CCMT-432-PEM	71891	71892	
DCMT-PEF 55° Diamond Finishing 	DCMT-21.50.5-PEF	71811	71812	
	DCMT-21.51-PEF	71893	71894	
	DCMT-32.50.5-PEF		71815	
	DCMT-32.51-PEF	71897	71898	
DCMT-PEM 55° Diamond Medium 	DCMT-21.51-PEM	71895	71896	
	DCMT 32.51-PEM	71899	71900	
	DCMT 32.52-PEM	71901	71902	
RCMX-UEX Metric Round 	RCMX-1003MO-UEX			71957
	RCMX-1204MO-UEX		71958	71959
	RCMX-1606MO-UEX	71961	71962	71963
	RCMX-2006MO-UEX	71966	71967	71968
	RCMX-2507MO-UEX	71971	71972	71973
	RCMX-3209MO-UEX		71976	71977
RCMT-UM Inch Round 	RCMT-43-UM		79926	
	RCMT-64-UM		79929	
	RCMT-84-UM		79931	
SCMT-PEF Square Finishing 	SCMT-32.51-PEF	71903	71904	
SCMT-PEM Square Medium 	SCMT-32.52-PEM	71905	71906	
	SCMT-432-PEM	71907	71908	
	SCMT-433-PEM	71939	71940	
TCMT-PEF 60° Triangle Finishing 	TCMT-1.21.20.5-PEF		80249	
	TCMT-21.50.5-PEF	71909	71910	
	TCMT-21.51-PEF	71911	71912	
TCMT-PEM 60° Triangle Medium 	TCMT-21.51-PEM	71941	71942	
	TCMT-21.52-PEM	71913	71914	
	TCMT-32.51-PEM	71915	71916	
	TCMT-32.52-PEM	71917	71918	
TPMR-PEU 60° Triangle Medium 	TPMR-221-PEU	71945	71946	71947
	TPMR-222-PEU	71948	71949	71950
	TPMR-321-PEU	71951	71952	71953
	TPMR-322-PEU	71954	71955	71956
VBMT-PEF 35° Diamond Finishing 	VBMT-331-PEF	71919	71920	
	VBMT-332-PEF	71921	71922	
	VBMT-333-PEF	71923	71924	











Alloy Steel Applications Positive Inserts

Description	ANSI	Grade DPC15HT	Grade DPC25UT	Grade DPC35RT
VCMT-PEF 35° Diamond Finishing 	VCMT-221-PEF	71925	71926	
	VCMT331-PEF	71927	71928	
	VCMT332-PEF	71931	71932	
VCMT-PEM 35° Diamond Medium 	VCMT-331-PEM	71943	71944	
	VCMT-332-PEM	71929	71930	
WCMT-PEF 80° Trigon Finishing 	WCMT-1.210.5-PEF		80251	











Alloy Steel & Stainless Steel Applications Positive Precision Ground Inserts (for lower cutting pressure)

Description	ANSI	Alloy Steel DPC25UT	Alloy Steel DPC35RT	Stainless Steel DMC30UT
CCGT-UEXL 80° Diamond Universal Left Hand 	CCGT-21.51 UEXL	70676	70677	70678
	CCGT-21.52 UEXL	70682	70683	70684
	CCGT-32.51 UEXL	70688	70689	70690
	CCGT-32.52 UEXL	70694	70695	70696
	CCGT-432 UEXL	70700	70701	70702
	CCGT-433 UEXL	70706	70707	70708
CCGT-UEXR 80° Diamond Universal Right Hand 	CCGT-21.51 UEXR	70679	70680	70681
	CCGT-21.52 UEXR	70685	70686	70687
	CCGT-31.51 UEXR	70691	70692	70693
	CCGT-31.52 UEXR	70697	70698	70699
	CCGT-432 UEXR	70703	70704	70705
	CCGT-433 UEXR	70709	70710	70711
DCGT-UEX^L 55° Diamon Medium Left Hand 	DCGT-21.51 UEXL	70712	70713	70714
	DCGT-32.51 UEXL	70718	70719	70720
	DCGT-32.52 UEXL	70725	70726	70727
DCGT-UEXR 55° Diamond Roughing Right Hand 	DCGT-21.51 UEXR	70715	70716	70717
	DCGT-32.51 UEXR	70721	70722	70723
	DCGT-32.52 UEXR	70729	70730	70731
TCGT-UEXL 60° Triangle Universal Left Hand 	TCGT-21.51 UEXL	70732	70733	70734
	TCGT-32.51 UEXL	70738	70739	70740
	TCGT-32.52 UEXL	70744	70745	70746
TCGT-UEXR 60° Triangle Finishing/ Medium Right Hand 	TCGT-21.51 UEXR	70735	70736	70737
	TCGT-32.51 UEXR	70741	70742	70743
	TCGT-32.52 UEXR	70747	70748	70749









Alloy Steel Applications Negative Inserts

Description	ANSI	Grade		
		DPC15HT	DPC25UT	DPC35RT
CNMG-PEF 80° Diamond Finishing 	CNMG-431-PEF	69250	69251	
	CNMG-432-PEF	69252	69253	
CNMG-UEM 80° Diamond Universal 	CNMG-431-UEM	69826	69828	
	CNMG-432-UEM	69832	69833	69834
CNMG-PEM 80° Diamond Medium 	CNMG-322-PEM	69491	69276	69277
	CNMG-432-PEM	69408	69278	69279
	CNMG-433-PEM	69280	69281	69282
	CNMG-434-PEM	71793	71794	71795
	CNMG-542-PEM	69283	69284	69285
	CNMG-543-PEM	69286	69287	69288
	CNMG-544-PEM	69492	69289	69290
	CNMG-643-PEM	69409	69291	69292
CNMG-PER 80° Diamond Roughing 	CNMG-432-PER	69351	69352	69353
	CNMG-433-PER	69354	69355	69356
	CNMG-434-PER	71796	71797	71798
	CNMG-542-PER	69357	69358	69359
	CNMG-543-PER	69360	69361	69362
	CNMG-544-PER	69363	69364	69365
	CNMG-643-PER	69366	69367	69368
	CNMG-644-PER	69369	69370	69371
DNMG-PEF 55° Diamond Finishing 	DNMG-331-PEF	69254	69255	
	DNMG-332-PEF	69256	69257	
	DNMG-431-PEF	69258	69259	
	DNMG-432-PEF	69260	69261	
	DNMG-441-PEF	69262	69263	
	DNMG-442-PEF	69264	69265	
DNMG-UEM 55° Diamond Universal 	DNMG-331-UEM	69835	69836	69837
	DNMG-332-UEM	69840	69841	
	DNMG-432-UEM		69844	
	DNMG-441-UEM	69845	69846	69847
DNMG-PEM 55° Diamond Medium 	DNMG-332-PEM	69295	69296	69297
	DNMG-432-PEM	69298	69299	69300
	DNMG-433-PEM	69301	69302	69303
	DNMG-442-PEM	69304	69305	69306
	DNMG-443-PEM	69307	69308	69309
	DNMG-444-PEM	69310	69311	69312
DNMG-PER 55° Diamond Roughing 	DNMG-432-PER	69375	69376	69377
	DNMG-433-PER	69378	69379	69380
	DNMG-442-PER	69381	69382	69383
	DNMG-443-PER	69384	69385	69386
	DNMG-444-PER	69387	69388	69389
SNMG-PEF Square Finishing 	SNMG-431-PEF	69266	69267	
SNMG-UEM Square Universal 	SNMG-321-UEM	69851	69852	
SNMG-PEM Square Medium 	SNMG-432-PEM	69313	69314	69315
	SNMG-433-PEM	69316	69317	69318
	SNMG-542-PEM	69319	69320	69321
	SNMG-643-PEM	69322	69323	69324

Alloy Steel Applications Negative Inserts

Description	ANSI	Grade		
		DPC15HT	DPC25UT	DPC35RT
SNMG-PER Square Roughing 	SNMG-432-PER	69390	69391	69392
	SNMG-433-PER	69393	69394	69395
	SNMG-643-PER	69396	69397	69398
	SNMG-644-PER	69399	69400	69401
TNMG-PEF 60° Triangle Finishing 	TNMG-331-PEF	69268	69269	
	TNMG-332-PEF	69270	69271	
TNMG-UEM 60° Triangle Universal 	TNMG-331-UEM	69853	69854	69855
	TNMG-332-UEM	69856	69857	69858
TNMG-PEM 60° Triangle Medium 	TNMG-332-PEM	69325	69326	69327
	TNMG-333-PEM	69328	69329	69330
	TNMG-432-PEM	69331	69332	69333
	TNMG-433-PEM	69334	69335	
VNMG-PEF 35° Diamond Finishing 	VNMG-331-PEF	69272	69273	
	VNMG-332-PEF	69274	69275	
VNMG-UEM 35° Diamond Universal 	VNMG-332-UEM	69859	69860	
VNMG-PEM 35° Diamond Finishing 	VNMG-332-PEM	69336	69337	69338
	VNMG-333-PEM	69339	69340	69341
WNMG-UEM 80° Trigon Universal 	WNMG-331-UEM	69861	69862	69863
	WNMG-332-UEM	69864	69865	69866
	WNMG-431-UEM	69867	69868	69869
	WNMG-432-UEM	69870	69871	69872
WNMG-PEM 80° Trigon Medium 	WNMG-332-PEM	69342	69343	69344
	WNMG-432-PEM	69345	69346	69347
	WNMG-433-PEM	69348	69349	69350
	WNMG-434-PEM	77954	77955	77956
WNMG-PER 80° Trigon Roughing 	WNMG-432-PER	69402	69403	69404
	WNMG-433-PER	69405	69406	69407
	WNMG-434-PER	77957	77958	77959

Alloy Steel & Stainless Steel Applications Negative Inserts (for lower cutting pressure)

Description	ANSI	Alloy Steel DPC15HT	Alloy Steel DPC25UT	Alloy Steel DPC35RT	Stainless Steel DMC30UT
CNMX-UEXL 80° Diamond Left Hand 	CNMX-431-UEXL		69411	69412	69413
	CNMX-432-UEXL		69417	69418	69419
CNMX-UEXR 80° Diamond Right Hand 	CNMX-431-UEXR		69414	69415	69416
	CNMX-432-UEXR		69420	69421	69422
DNMX-UEXL 55° Diamond Left Hand 	DNMX-331-UEXL	69429	69430	69431	
	DNMX-332-UEXL	69435	69436	69437	
	DNMX-431-UEXL		69441		
	DNMX-432-UEXL		69447		
	DNMX-441-UEXL	69453	69454	69455	69456
	DNMX-442-UEXL	69461	69462	69463	69464
DNMX-UEXR 55° Diamond Right Hand 	DNMX-331-UEXR	69432	69433	69434	
	DNMX-332-UEXR	69438	69439	69440	
	DNMX-431-UEXR		69444		
	DNMX-432-UEXR		69450		
	DNMX-441-UEXR	69457	69458	69459	69460
	DNMX-442-UEXR	69465	69466	69467	69468
TNMX-UXL 60° Triangle Left Hand 	TNMX-321-UEXL	69469	69470	69471	69472
	TNMX-322-UEXL	69477	69478	69479	69480
TNMX-UEXR 60° Triangle Right Hand 	TNMX-321-UEXR	69473	69474	69475	69476
	TNMX-322-UEXR	69481	69482	69483	69484
WNMX-UEXL 80° Trigon Left Hand 	WNMX-432-UEXL	78281	78282	78283	78280
	WNMX-433-UEXL		78289	78290	78288
WNMX-UEXR 80° Trigon Right Hand 	WNMX-432-UEXR	78285	78286	78287	78284
	WNMX-433-UEXR		78292	78293	78291

Heavy Duty Roughing Steel Applications Single Sided Negative Inserts

Description	ANSI	Grade		
		DPC15HT	DPC25UT	DPC35RT
CNMM-PSH 80° Diamond Roughing 	CNMM-432-PSH	70160	70161	70162
	CNMM-433-PSH	70163	70164	70165
	CNMM-543-PSH	70166	70167	70168
	CNMM-544-PSH	70169	70170	70171
	CNMM-643-PSH	70172	70173	70174
	CNMM-644-PSH	70175	70176	70177
	CNMM-646-PSH	70178	70179	70180
CNMM-PSS 80° Diamond Heavy Roughing 	CNMM-644-PSS	70205	70206	70207
CNMM-PST 80° Diamond Extra Heavy Roughing 	CNMM-856-PST	70216	70217	70218
	CNMM-866-PST	70220	70221	70222
DNMM-PSH 55° Diamond Extra Heavy Roughing 	DNMM-442-PSH	71989	71990	71991
	DNMM-443-PSH	71992	71993	71994
	DNMM-444-PSH	71995	71996	71997
TNMM-PSH 60° Diamond Extra Heavy Roughing 	TNMM-332-PSH	77869	77870	77871
	TNMM-432-PSH	77872	77873	77874
	TNMM-433-PSH	77875	77876	77877
SNMM-PHS Square Roughing 	SNMM-432-PSH	70181	70182	70183
	SNMM-433-PSH	70184	70185	70186
	SNMM-543-PSH	70187	70188	70189
	SNMM-544-PSH	70190	70191	70192
	SNMM-643-PSH	70193	70194	70195
	SNMM-644-PSH	70196	70197	70198
	SNMM-646-PSH	70199	70200	70201
SNMM-648-PSH	70202	70203	70204	
SNMM-PSS Square Heavy Roughing 	SNMM-644-PSS	70210	70211	70212
	SNMM-646-PSS	70213	70214	70215
SNMM-PST Square Extra Heavy Roughing 	SNMM-856-PST	70224	70225	70226
	SNMM-858-PST	73990	73991	73992
	SNMM-866-PST	70228	70229	70230
	SNMM-868-PST	73993	73994	73995

Wiper Inserts for Alloy Steel & Stainless Steel Applications

Description	ANSI	Grade	Grade
		DPC15HT	DPC25UT
CNMG-PEX 80° Diamond High Performance 	CNMG-432-PEX	69485	69486
	CNMG-433-PEX	69489	69490
DNMG-PEX 55° Diamond High Performance 	DNMG-443-PEX	69487	69488
WNMG-PEX 80° Trigon High Performance 	WNMG-432-PEX	77947	77948
	WNMG-433-PEX	77951	77952

Stainless Steel Applications Negative Inserts

Description	ANSI	Grade	Grade
		DMC25HT	DMC30UT
CNMG-MEF 80° Diamond Finishing 	CNMG-321-MEF	71780	69964
	CNMG-431-MEF	71781	69965
	CNMG-432-MEF	71784	69966
	CNMG-433-MEF	71790	69967
CNMG-MEM 80° Diamond Medium 	CNMG-432-MEM		69968
	CNMG-433-MEM		69969
	CNMG-543-MEM		71801
CNMG-MEH 80° Diamond High Performance 	CNMG-432-MEH	71785	71786
	CNMG-433-MEH	71791	71792
	CNMG-543-MEH	71799	71800
	CNMG-544-MEH	71802	71803
	CNMG-643-MEH		71804
	CNMG-644-MEH		71805
CNMG-MER 80° Diamond Roughing 	CNMG-432-MER		71787
	CNMG-433-MER		69970
	CNMG-543-MER		69971
	CNMG-643-MER		69972
DNMG-MEF 55° Diamond Finishing 	DNMG-331-MEF	71998	69973
	DNMG-332-MEF	71980	71981
	DNMG-441-MEF	71984	69974
	DNMG-442-MEF	71986	69975
DNMG-MEM 55° Diamond Medium 	DNMG-332-MEM		69976
	DNMG-432-MEM		69977
	DNMG-442-MEM		69978
	DNMG-443-MEM		69979
DNMG-MEH 55° Diamond High Performance 	DNMG-331-MEH	71999	
	DNMG-332-MEH	71982	
	DNMG-432-MEH	71983	
	DNMG-441-MEH	71985	
	DNMG-442-MEH	71987	
	DNMG-443-MEH	71988	
DNMG-MER 55° Diamond Medium 	DNMG-442-MER		69980
	DNMG-443-MER		69981
SNMG-MEF Square Finishing 	SNMG-321-MEF	77680	69982
SNMG-MEM Square Medium 	SNMG-432-MEM		77682
	SNMG-433-MEM		77686
SNMG-MEH Square High Performance 	SNMG-432-MEH	77681	
	SNMG-433-MEH	77685	
	SNMG-543-MEH	77689	
	SNMG-544-MEH	77690	
SNMG-MER Square Roughing 	SNMG-432-MER		69983
	SNMG-433-MER		69984
	SNMG-643-MER		69985

Call: 979-282-2861

Visit: www.doriantool.com

Stainless Steel Applications Negative Inserts

Description	ANSI	Grade	Grade
		DMC25HT	DMC30UT
TNMG-MEF 60° Triangle Finishing 	TNMG-331-MEF	77860	77861
	TNMG-332-MEF	77862	77863
TNMG-MEM 60° Triangle Medium 	TNMG-332-MEM	77864	69986
	TNMG-333-MEM	77865	77866
	TNMG-432-MEM	77867	69987
	TNMG-433-MEM	77868	69988
WNMG-MEF 80° Trigon Finishing 	WNMG-331-MEF		69989
	WNMG-431-MEF	77943	69990
	WNMG-432-MEF	77944	69991
WNMG-MEH 80° Trigon High Performance 	WNMG-331-MEH	77942	
	WNMG-432-MEH	77945	
	WNMG-433-MEH	77949	
	WNMG-434-MEH	77953	
WNMG-MEM 80° Trigon Medium 	WNMG-332-MEM		69992
	WNMG-432-MEM		69993
	WNMG-433-MEM		69994
	WNMG-434-MEM		69995
WNMG-MER 80° Trigon Roughing 	WNMG-432-MER	77946	69996
	WNMG-433-MER	77950	69997

E-mail: sales@doriantool.com

Cast Iron Applications Negative Inserts

Description	ANSI	DKC	
		DKC10UT	DKC15RT
CNMG-KEF 80° Diamond Finishing	CNMG-431-KEF	67052	67053
CNMA-KEU 80° Diamond General Purpose	CNMA-432-KEU	69874	69875
	CNMA-433-KEU	69876	69877
	CNMA-644-KEU		69878
	CNMA-866-KEU		69879
CNMG-KEM 80° Diamond Medium	CNMG-432-KEM	71782	71783
	CNMG-433-KEM	71788	71789
CNMG-KER 80° Diamond Roughing	CNMG-432-KER	69904	69905
	CNMG-433-KER	69906	69907
	CNMG-434-KER	69908	69909
	CNMG-543-KER	69910	69911
	CNMG-544-KER	69912	69913
DNMG-KEF 55° Diamond Finishing	DNMG-331-KEF	67054	67055
DNMA-KEU 55° Diamond General Purpose	DNMA-442-KEU		69880
	DNMA-443-KEU		71836
DNMG-KER 55° Diamond Roughing	DNMG-432-KER	69914	69915
	DNMG-433-KER	69916	69917
	DNMG-442-KER	69918	69919
	DNMG-443-KER	69920	69921
SNMA-KEU Square General Purpose	SNMA-432-KEU	69882	69883
	SNMA-433-KEU	69884	69885
	SNMA-434-KEU	69886	69887
	SNMA-664-KEU		69888
	SNMA-856-KEU		69889
SNMG-KER Square Roughing	SNMG-432-KER	69922	69923
	SNMG-433-KER	69924	69925
	SNMG-643-KER	69926	
	SNMG-644-KER	69927	69928
TNMA-KEU Triangle General Purpose	TNMA-332-KEU	69890	69891
	TNMA-333-KEU	69892	69893
	TNMA-434-KEU	69894	69895
WNMA-KEU 80° Trigon General Purpose	WNMA-432-KEU	69896	69897
	WNMA-433-KEU	69898	69899
WNMA-KER 80° Trigon Roughing	WNMG-432-KER	69929	69930
	WNMG-433-KER		69931

Titanium & High Temp Alloy Applications Negative Inserts

Description	ANSI	Titanium Grade High Temp		
		DSP10HT	DSP15HT	DSP20HT
CNGG-SEF 80° Diamond Finishing	CNGG-431-SEF		67058	70278
	CNGG-432-SEF		67059	70279
	CNGG-433-SEF		67060	70281
CNM/GG-SEM 80° Diamond Medium	CNGG-431-SEM		67061	
	CNGG-432-SEM		67065	
	CNGG-433-SEM		67066	
	CNMG-431-SEM		67067	
	CNMG-432-SEM		67068	
CNGG-SER 80° Diamond Roughing	CNGG-432-SER		67069	70280
	CNGG-433-SER		67070	70282
CNMG-SEH 80° Diamond Roughing	CNMG-432-SEH	69726		69727
DNGG-SEF 55° Diamond Finishing	DNGG-431-SEF		67071	71830
	DNGG-432-SEF		67072	71831
	DNGG-433-SEF		67073	71832
	DNGG-441-SEF		67074	71833
	DNGG-442-SEF		67082	71834
	DNGG-443-SEF		67083	71835
DNMG-SEM 55° Diamond Medium	DNMG-431-SEM		67084	
	DNMG-432-SEM		67085	
	DNMG-433-SEM		67086	
	DNMG-441-SEM		67087	
	DNMG-442-SEM		67088	
	DNMG-443-SEM		67089	
DNMG-SEH 55° Diamond Roughing	DNMG-442-SEH	69730		69731
VNMG-SEF 35° Diamond Finishing	VNMG-331-SEF		67095	
	VNMG-332-SEF		67096	
WNGG-SEF 80° Trigon Finishing	WNGG-332-SEF		77940	
	WNGG-431-SEF		67097	
	WNGG-432-SEF		67098	
	WNGG-433-SEF		67099	
WNM/GG-SEM 80° Trigon Medium	WNGG-431-SEM		67100	
	WNGG-432-SEM		67101	
	WNGG-433-SEM		77941	
	WNMG-431-SEM		67102	
	WNMG-432-SEM		67103	
	WNMG-433-SEM		67104	
WNMG-SEH 80° Trigon Medium	WNMG-432-SEH	69736		69737
SNMG-SEF Square Finishing	SNMG-432-SEF		77683	
	SNMG-433-SEF		77687	
SNMG-SER Square Roughing	SNMG-432-SER		77684	
	SNMG-433-SER		77688	

TOOL HOLDERS & BORING BARS

MADE IN U.S.A. 

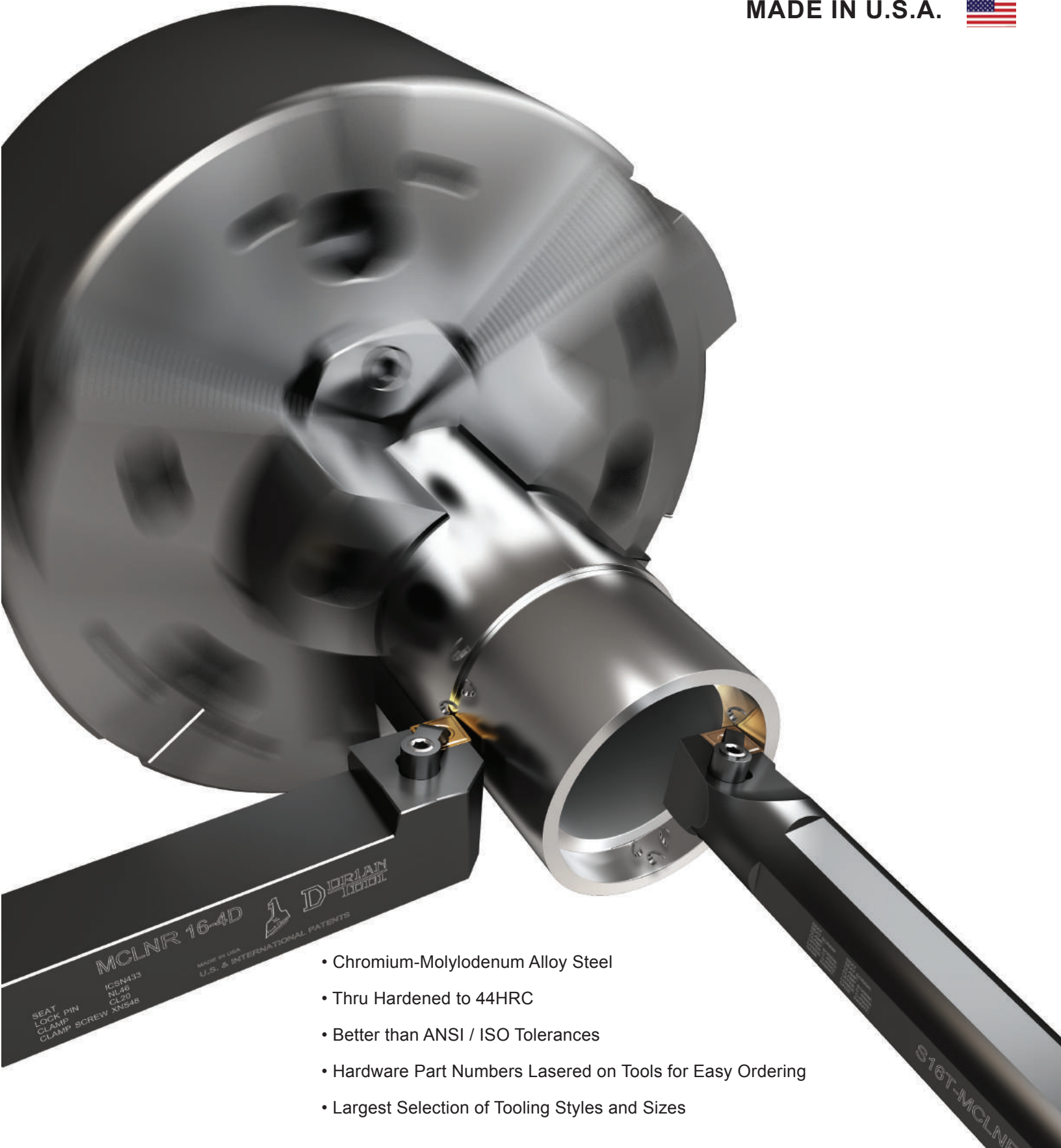

- Chromium-Molybdenum Alloy Steel
- Thru Hardened to 44HRC
- Better than ANSI / ISO Tolerances
- Hardware Part Numbers Lasered on Tools for Easy Ordering
- Largest Selection of Tooling Styles and Sizes

MCFN R/L Toolholder Style F - 0° End Cutting Edge Angle for negative 80° diamond CNM_ inserts

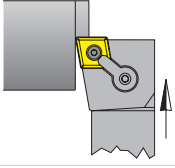

Description	UPC #		Shank		CNM_ Gage Insert
	Right Hand	Left Hand	Height	Length	
MCFNR/L12-4B	-	50011	0.75	4.50	432
MCFNR/L16-4C	50014	50015	1.00	5.00	
MCFNR/L16-4D	-	50019	1.00	6.00	
MCFNR/L16-5D	-	50023	1.00	6.00	543
MCFNR/L16-6D	50026	50027	1.00	6.00	643

MCMNN Toolholder Style M - 40° Side Cutting Edge Angle for negative 80° diamond CNM_ inserts

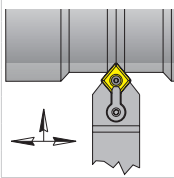

Description	UPC # Neutral	Shank		CNM_ Gage Insert
		Height	Length	
MCMNN12-4B	50198	0.75	4.50	432
MCMNN16-4D	50200	1.00	6.00	
MCMNN16-5D	50202	1.00	6.00	
MCMNN20-5D	50204	1.25	6.00	543
MCMNN20-6D	50208	1.25	6.00	643

MCGN R/L Toolholder Style G - 0° Side Cutting Edge Angle for negative 80° diamond CNM_ inserts

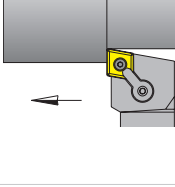

Description	UPC #		Shank		CNM_ Gage Insert
	Right Hand	Left Hand	Height	Length	
MCGNR/L12-4B	50036	50037	0.75	4.50	432
MCGNR/L16-4C	-	50041	1.00	5.00	
MCGNR/L16-4D	50044	50045	1.00	6.00	
MCGNR/L16-5D	50048	-	1.00	6.00	543
MCGNR/L16-6D	-	50053	1.00	6.00	643
MCGNR/L85-6D	50056	50057	1.25	6.00	

MCRN R/L Toolholder Style R - 15° Side Cutting Edge Angle for negative 80° diamond CNM_ inserts

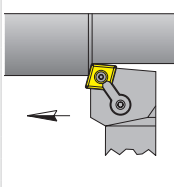

Description	UPC #		Shank		CNM_ Gage Insert
	Right Hand	Left Hand	Height	Length	
MCRNR/L12-3B	50218	50219	0.75	4.5	322
MCRNR/L12-4B	50220	50221	0.75	4.5	432
MCRNR/L16-4C	50224	-	1.00	5.0	
MCRNR/L16-4D	50228	50229	1.00	6.0	
MCRNR/L20-4D	50232	50233	1.25	6.0	543
MCRNR/L24-4E	-	50237	1.50	7.0	
MCRNR/L16-5D	50240	50241	1.00	6.0	543
MCRNR/L20-5D	50244	50245	1.25	6.0	
MCRNR/L85-5D	50248	50249	1.25	6.0	643
MCRNR/L16-6D	50252	50253	1.00	6.0	
MCRNR/L20-6D	50256	50257	1.25	6.0	643
MCRNR/L24-6E	50260	50261	1.50	7.0	
MCRNR/L86-6E	50264	-	1.50	7.0	

MCKN R/L Toolholder Style K - 15° End Cutting Edge Angle for negative 80° diamond CNM_ inserts

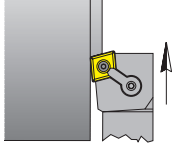

Description	UPC #		Shank		CNM_ Gage Insert
	Right Hand	Left Hand	Height	Length	
MCKNR/L12-4B	50066	-	0.75	4.50	432
MCKNR/L16-4C	50070	50071	1.00	5.00	
MCKNR/L16-4D	50074	50075	1.00	6.00	
MCKNR/L20-4D	50078	50079	1.25	6.00	
MCKNR/L16-5D	50082	50083	1.00	6.00	543
MCKNR/L20-5D	50086	50087	1.25	6.00	
MCKNR/L85-5D	50090	50091	1.25	6.00	643
MCKNR/L20-6D	50098	50099	1.25	6.00	
MCKNR/L24-6E	50102	50103	1.50	7.00	
MCKNR/L86-6E	50106	-	1.50	7.00	

MCYNN Toolholder Style Y - 50° Side Cutting Edge Angle for negative 80° diamond CNM_ inserts

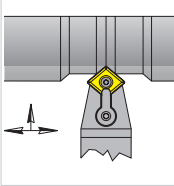

Description	UPC # Neutral	Shank		CNM_ Gage Insert
		Height	Length	
MCYNN12-4B	50274	0.75	4.5	432
MCYNN16-4D	50276	1.00	6.0	
MCYNN20-6D	50286	1.25	6.0	
MCYNN24-6E	50288	1.50	7.0	643

MCLN R/L Toolholder Style L - Negative 5° End or Side Cutting Edge Angle for negative 80° diamond CNM_ inserts

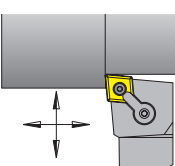

Description	UPC #		Shank		CNM_ Gage Insert
	Right Hand	Left Hand	Height	Length	
MCLNR/L08-3A	50108	50109	0.500	4.00	322
MCLNR/L10-3A	50118	-	0.625	4.00	322
MCLNR/L12-3B	50110	50111	0.750	4.50	
MCLNR/L16-3C	50112	50113	1.000	5.00	
MCLNR/L10-4B	50116	50117	0.625	4.50	432
MCLNR/L12-4B	50120	50121	0.750	4.50	
MCLNR/L16-4C	50124	50125	1.000	5.00	
MCLNR/L16-4D	50128	50129	1.000	6.00	
MCLNR/L20-4D	50132	50133	1.250	6.00	
MCLNR/L24-4D	50136	50137	1.500	6.00	
MCLNR/L24-4E	50140	50141	1.500	7.00	
MCLNR/L85-4D	50144	50145	1.250	6.00	
MCLNR/L16-5C	50148	50149	1.000	5.00	543
MCLNR/L16-5D	50152	50153	1.000	6.00	
MCLNR/L20-5D	50156	50157	1.250	6.00	
MCLNR/L16-6C	-	50165	1.000	5.00	643
MCLNR/L16-6D	50168	50169	1.000	6.00	
MCLNR/L20-6D	50172	50173	1.250	6.00	
MCLNR/L20-6E	50174	50175	1.250	7.00	
MCLNR/L24-6D	50176	50177	1.500	6.00	
MCLNR/L24-6E	50180	50181	1.500	7.00	
MCLNR/L85-6D	50184	50185	1.250	6.00	
MCLNR/L86-6E	50188	50189	1.500	7.00	

MDGN R/L Toolholder Style G - 0° Side Cutting Edge Angle for negative 55° diamond DNM_ inserts

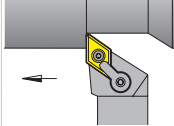

Description	UPC #		Shank		DNM_ Gage Insert
	Right Hand	Left Hand	Height	Length	
MDGNR/L12-4B	50298	-	0.75	4.50	432
MDGNR/L16-5D	50306	-	1.00	6.00	543

MDJN R/L Toolholder Style J - 3° Side Cutting Edge Angle for negative 55° diamond DNM_ inserts

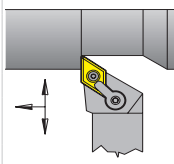

Description	UPC #		Shank		DNM_ Gage Insert
	Right Hand	Left Hand	Height	Length	
MDJNR/L08-3A	50316	-	0.500	4.00	332
MDJNR/L10-3B	50320	-	0.625	4.50	
MDJNR/L12-3B	50312	50313	0.750	4.50	
MDJNR/L16-3C	50314	50315	1.000	5.00	432
MDJNR/L16-3D	50318	50319	1.000	6.00	
MDJNR/L12-4B	50324	50325	0.750	4.50	432
MDJNR/L16-4C	50328	50329	1.000	5.00	
MDJNR/L16-4D	50332	50333	1.000	6.00	432
MDJNR/L20-4D	50336	50337	1.250	6.00	
MDJNR/L24-4D	50340	50341	1.500	6.00	432
MDJNR/L24-4E	50344	50345	1.500	7.00	
MDJNR/L85-4D	-	50349	1.250	6.00	543
MDJNR/L16-5C	50350	50351	1.000	5.00	
MDJNR/L16-5D	50352	50353	1.000	6.00	543
MDJNR/L20-5D	50356	50357	1.250	6.00	
MDJNR/L24-5D	50360	-	1.500	6.00	543
MDJNR/L24-5E	50364	50365	1.500	7.00	
MDJNR/L86-5E	50368	-	1.500	7.00	

MDPNN Toolholder Style P- 27.5° Side Cutting Edge Angle for negative 55° diamond DNM_ inserts

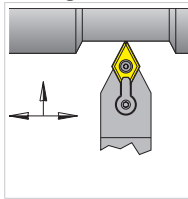

Description	UPC #		Shank		DNM_ Gage Insert
	Neutral	Left Hand	Height	Length	
MDPNN12-4B	50370	-	0.75	4.50	432
MDPNN16-4D	50372	-	1.00	6.00	
MDPNN20-4D	50374	-	1.25	6.00	
MDPNN16-5D	50376	-	1.00	6.00	543
MDPNN20-5D	50378	-	1.25	6.00	
MDPNN24-5D	50380	-	1.50	6.00	

MDQNR/L Toolholder Style Q- 17.5° Side Cutting Edge Angle for negative 55° diamond DNM_ inserts

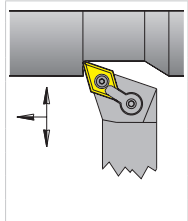

Description	UPC #		Shank		DNM_ Gage Insert
	Right Hand	Left Hand	Height	Length	
MDQNR/L12-4B	50371	50373	0.75	4.5	432
MDQNR/L16-4C	50375	-	1.00	5.0	
MDQNR/L16-4D	50379	50381	1.00	6.0	
MDQNR/L20-4D	50383	50385	1.25	6.0	
MDQNR/L24-4D	-	50389	1.50	6.0	
MDQNR/L20-5D	50395	-	1.25	6.0	543
MDQNR/L24-5E	50403	-	1.50	7.0	

MSDNN Toolholder Style D - 45° Side Cutting Edge Angle for negative square SNM_ inserts

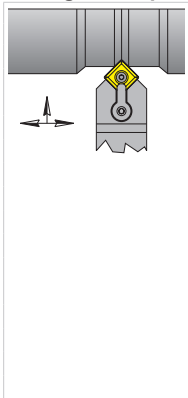

Description	UPC #		Shank		SNM_ Gage Insert
	Neutral	Left Hand	Height	Length	
MSDNN08-3A	50392	-	0.500	4.00	322
MSDNN08-3B	50394	-	0.500	4.50	
MSDNN10-3B	50396	-	0.625	4.50	
MSDNN12-3B	50398	-	0.750	4.50	
MSDNN12-4B	50400	-	0.750	4.50	
MSDNN16-4D	50402	-	1.000	6.00	432
MSDNN85-4D	50404	-	1.250	6.00	
MSDNN16-5D	50406	-	1.000	6.00	543
MSDNN20-5D	50408	-	1.250	6.00	
MSDNN85-5D	50410	-	1.250	6.00	
MSDNN16-6D	50414	-	1.000	6.00	
MSDNN20-6D	50416	-	1.250	6.00	
MSDNN20-6E	50417	-	1.250	7.00	643
MSDNN24-6E	50418	-	1.500	7.00	
MSDNN86-6E	50422	-	1.500	7.00	

MSKNR/L Toolholder Style K- 15° End Cutting Edge Angle for negative square SNM_ inserts

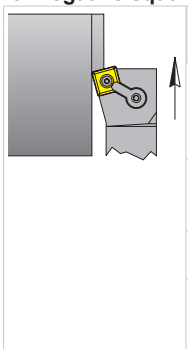

Description	UPC #		Shank		SNM_ Gage Insert
	Right Hand	Left Hand	Height	Length	
MSKNR/L08-3A	50432	-	0.500	4.00	322
MSKNR/L08-3B	50436	50437	0.500	4.50	
MSKNR/L10-3B	50440	-	0.625	4.50	
MSKNR/L12-3B	50444	-	0.750	4.50	
MSKNR/L12-4B	50448	-	0.750	4.50	
MSKNR/L16-4C	50452	-	1.000	5.00	432
MSKNR/L16-4D	50456	50457	1.000	6.00	
MSKNR/L16-5D	50460	50461	1.000	6.00	543
MSKNR/L20-5D	50464	50465	1.250	6.00	
MSKNR/L20-6D	50472	50473	1.250	6.00	643
MSKNR/L24-6D	50476	-	1.500	6.00	
MSKNR/L24-6E	50480	50481	1.500	7.00	

MSSNR/L Toolholder Style S- 45° Side Cutting Edge Angle for negative square SNM_ inserts

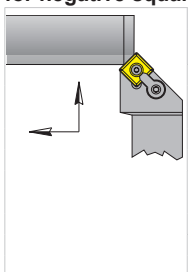

Description	UPC #		Shank		SNM_ Gage Insert
	Right Hand	Left Hand	Height	Length	
MSSNR/L08-3A	50564	50565	0.500	4.00	322
MSSNR/L08-3B	50568	50569	0.500	4.50	
MSSNR/L12-4B	50572	50573	0.750	4.50	432
MSSNR/L16-4D	50580	50581	1.000	6.00	
MSSNR/L85-4D	50582	50583	1.250	6.00	
MSSNR/L16-5D	50584	-	1.000	6.00	543
MSSNR/L20-5D	50588	50589	1.250	6.00	
MSSNR/L20-5E	50590	-	1.250	7.00	
MSSNR/L20-6D	50592	50593	1.250	6.00	643
MSSNR/L24-6E	50596	-	1.500	7.00	

MSRNR/L Toolholder Style R- 15° Side Cutting Edge Angle for negative square SNM_ inserts

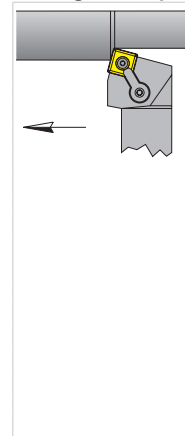

Description	UPC #		Shank		SNM_ Gage Insert
	Right Hand	Left Hand	Height	Length	
MSRNR/L08-3A	50490	-	0.500	4.00	322
MSRNR/L08-3B	-	50495	0.500	4.50	
MSRNR/L10-3B	-	50499	0.625	4.50	
MSRNR/L12-3B	50502	50503	0.750	4.50	432
MSRNR/L12-4B	50506	50507	0.750	4.50	
MSRNR/L16-4C	-	50511	1.000	5.00	
MSRNR/L16-4D	50514	50515	1.000	6.00	
MSRNR/L20-4D	50518	50519	1.250	6.00	
MSRNR/L85-4D	50522	50523	1.250	6.00	
MSRNR/L16-5C	50526	50527	1.000	5.00	
MSRNR/L16-5D	50530	50531	1.000	6.00	
MSRNR/L20-5D	50534	50535	1.250	6.00	
MSRNR/L85-5D	50538	50539	1.250	6.00	
MSRNR/L16-6D	50542	50543	1.000	6.00	643
MSRNR/L20-6D	50546	50547	1.250	6.00	
MSRNR/L24-6E	50550	50551	1.500	7.00	
MSRNR/L85-6D	50554	50555	1.250	6.00	

MTANR/L Toolholder Style A- 0° Side Cutting Edge Angle for negative triangle TNM_ inserts

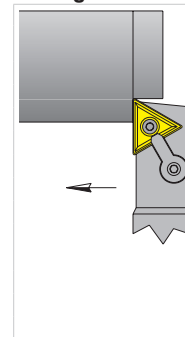

Description	UPC #		Shank		TNM_ Gage Insert
	Right Hand	Left Hand	Height	Length	
MTANR/L08-2A	50606	50607	0.500	4.00	221
MTANR/L10-2B	50610	50611	0.625	4.50	
MTANR/L10-3B	50614	50615	0.625	4.50	322 or 332*
MTANR/L12-3B	50618	50619	0.750	4.50	
MTANR/L16-3D	-	50623	1.000	6.00	
MTANR/L64-3D	50626	50627	1.000	6.00	432
MTANR/L16-4D	50630	50631	1.000	6.00	
MTANR/L85-4D	50638	50639	1.250	6.00	
MTANR/L86-4E	50642	-	1.500	7.00	543
MTANR/L16-5D	50646	-	1.000	6.00	
MTANR/L20-5E	50652	-	1.250	7.00	
MTANR/L24-6E	50654	50655	1.500	7.00	663

* Change shim to ITSN-322 when using TNMG-332 inserts

MTCNN Toolholder Style C- 0° End Cutting Edge Angle for negative triangle TNM_ inserts

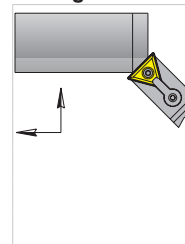

Description	UPC #		Shank		TNM_ Gage Insert
	Neutral	Left Hand	Height	Length	
MTCNN08-3B	50666	-	0.500	4.50	322 or 332*
MTCNN44-3F	50670	-	1.000	8.00	
MTCNN12-4B	50672	-	0.750	4.50	432
MTCNN64-4D	50674	-	1.000	6.00	
MTCNN66-4E	50678	-	1.500	7.00	
MTCNN66-4F	50680	-	1.500	8.00	

* Change shim to ITSN-322 when using TNMG-332 inserts

MTENN Toolholder Style E- 30° Side Cutting Edge Angle for negative triangle TNM_ inserts

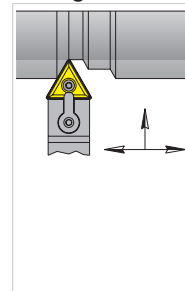

Description	UPC #		Shank		TNM_ Gage Insert
	Neutral	Left Hand	Height	Length	
MTENN08-2A	50690	-	0.500	4.00	221
MTENN10-3B	50692	-	0.625	4.50	322 or 332*
MTENN12-3B	50694	-	0.750	4.50	
MTENN12-4B	50698	-	0.750	4.50	432
MTENN16-4D	50700	-	1.000	6.00	
MTENN85-4D	50702	-	1.250	6.00	
MTENN86-4E	50704	-	1.500	7.00	543
MTENN20-5D	50706	-	1.250	6.00	
MTENN20-5E	50708	-	1.250	7.00	
MTENN24-5E	50710	-	1.500	7.00	

* Change shim to ITSN-322 when using TNMG-332 inserts

MTFN R/L Toolholder Style F- 0° End Cutting Edge Angle for negative triangle TNM_ inserts

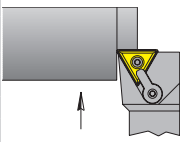

Description	UPC #		Shank		TNM_ Gage Insert
	Right Hand	Left Hand	Height	Length	
MTFNRL08-2A	50722	50723	0.500	4.00	221
MTFNRL10-3B	50734	50735	0.625	4.50	322
MTFNRL12-3B	50738	50739	0.750	4.50	or 332*
MTFNRL16-3D	50746	-	1.000	6.00	432
MTFNRL16-4C	50750	50751	1.000	5.00	
MTFNRL16-4D	50754	50755	1.000	6.00	
MTFNRL20-4D	50758	50759	1.250	6.00	
MTFNRL85-4D	-	50767	1.250	6.00	
MTFNRL16-5D	50774	50775	1.000	6.00	543
MTFNRL20-5D	50778	50779	1.250	6.00	
MTFNRL24-6E	50792	50793	1.500	7.00	663

* Change shim to ITSN-322 when using TNMG-332 inserts

MTGN R/L Toolholder Style G- 0° Side Cutting Edge Angle for negative triangle TNM_ inserts

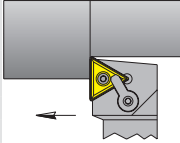

Description	UPC #		Shank		TNM_ Gage Insert
	Right Hand	Left Hand	Height	Length	
MTGNRL08-2A	50802	50803	0.500	4.00	221
MTGNRL10-2B	-	50807	0.625	4.50	
MTGNRL10-3B	50810	50811	0.625	4.50	
MTGNRL12-3B	50814	50815	0.750	4.50	322 or 332*
MTGNRL16-3C	50818	50819	1.000	5.00	
MTGNRL16-3D	50822	50823	1.000	6.00	
MTGNRL16-4C	50826	-	1.000	5.00	
MTGNRL16-4D	50830	50831	1.000	6.00	432
MTGNRL20-4D	50834	50835	1.250	6.00	
MTGNRL24-4D	50836	-	1.500	6.00	
MTGNRL85-4D	50842	50843	1.250	6.00	
MTGNRL86-4E	50846	-	1.500	7.00	
MTGNRL16-5C	50850	50851	1.000	5.00	
MTGNRL16-5D	50854	50855	1.000	6.00	543
MTGNRL20-5D	50858	50859	1.250	6.00	
MTGNRL24-5E	50862	50863	1.500	7.00	
MTGNRL24-6E	50872	50873	1.500	7.00	663

* Change shim to ITSN-322 when using TNMG-332 inserts

MTJN R/L Toolholder Style J- 3° Side Cutting Edge Angle for negative triangle TNM_ inserts

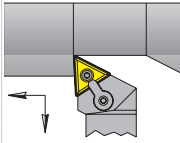

Description	UPC #		Shank		TNM_ Gage Insert
	Right Hand	Left Hand	Height	Length	
MTJNRL08-2A	50882	50883	0.500	4.00	221
MTJNRL10-2B	50886	-	0.625	4.50	
MTJNRL10-3B	50890	50891	0.625	4.50	322
MTJNRL12-3B	50894	50895	0.750	4.50	or 332*
MTJNRL16-3D	50898	50899	1.000	6.00	
MTJNRL16-4D	50902	50903	1.000	6.00	432
MTJNRL20-4D	50906	50907	1.250	6.00	
MTJNRL20-4E	50908	-	1.250	7.00	
MTJNRL16-5D	50914	50915	1.000	6.00	
MTJNRL20-5D	50918	50919	1.250	6.00	
MTJNRL24-5E	50922	50923	1.500	7.00	543
MTJNRL85-5D	50926	50927	1.250	6.00	
MTJNRL86-5E	50930	-	1.500	7.00	
MTJNRL24-6E	50934	50935	1.500	7.00	663

* Change shim to ITSN-322 when using TNMG-332 inserts

MTRN R/L Toolholder Style R- 15° Side Cutting Edge Angle for negative triangle TNM_ inserts

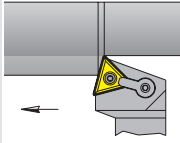

Description	UPC #		Shank		TNM_ Gage Insert
	Right Hand	Left Hand	Height	Length	
MTRNRL08-2A	50960	50961	0.500	4.00	221
MTRNRL10-2B	50964	-	0.625	4.50	
MTRNRL16-3D	50976	50977	1.000	6.00	322 or 332*
MTRNRL16-4D	50980	50981	1.000	6.00	432
MTRNRL20-4D	50984	50985	1.250	6.00	
MTRNRL85-4D	50988	-	1.250	6.00	
MTRNRL16-5D	50992	-	1.000	6.00	543
MTRNRL20-5D	50996	50997	1.250	6.00	
MTRNRL24-6E	51012	51013	1.500	7.00	663

* Change shim to ITSN-322 when using TNMG-332 inserts

MTWN R/L Toolholder Style W- 10° Side Cutting Edge Angle for negative triangle TNM_ inserts

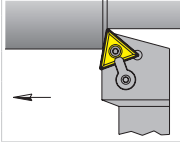

Description	UPC #		Shank		TNM_ Gage Insert
	Right Hand	Left Hand	Height	Length	
MTWNR/L12-3B	51022	51023	0.750	4.50	322 or 332*
MTWNR/L16-4D	51026	-	1.000	6.00	432
MTWNR/L20-4D	51030	51031	1.250	6.00	

* Change shim to ITSN-322 when using TNMG-332 inserts

MVGN R/L Toolholder Style G- 0° Side Cutting Edge Angle for negative 35° diamond VNM_ inserts

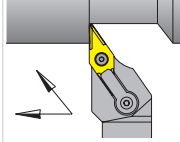

Description	UPC #		Shank		VNM_ Gage Insert
	Right Hand	Left Hand	Height	Length	
MVGNR/L12-3B	51044	51045	0.75	4.50	332
MVGNR/L16-3D	-	51049	1.00	6.00	
MVGNR/L16-4D	51052	-	1.00	6.00	432

MVJN R/L Toolholder Style J- Negative 3° Side Cutting Edge Angle for negative 35° diamond VNM_ inserts

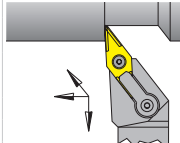

Description	UPC #		Shank		VNM_ Gage Insert
	Right Hand	Left Hand	Height	Length	
MVJNR/L12-3B	51062	51063	0.75	4.50	
MVJNR/L16-3C	51066	51067	1.00	5.00	
MVJNR/L16-3D	51070	51071	1.00	6.00	332
MVJNR/L20-3D	51074	51075	1.25	6.00	
MVJNR/L24-3E	51078	51079	1.50	7.00	
MVJNR/L12-4B	51082	51083	0.75	4.50	
MVJNR/L16-4C	51086	-	1.00	5.00	
MVJNR/L16-4D	51090	51091	1.00	6.00	432
MVJNR/L20-4D	51094	51095	1.25	6.00	
MVJNR/L24-4E	51098	51099	1.50	7.00	

MVLN R/L Toolholder Style L- Negative 5° End Cutting Edge Angle for negative 35° diamond VNM_ inserts

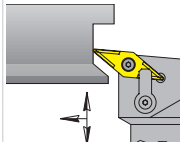

Description	UPC #		Shank		VNM_ Gage Insert
	Right Hand	Left Hand	Height	Length	
MVLNR/L16-4C	51108	51109	1.00	5.00	
MVLNR/L16-4D	51112	51113	1.00	6.00	432
MVLNR/L20-4D	51116	51117	1.25	6.00	
MVLNR/L24-4D	-	51121	1.50	6.00	

MVTN R/L Toolholder Style N- Negative 27.5° End Cutting Edge Angle for negative 35° diamond VNM_ inserts

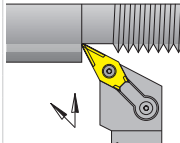

Description	UPC #		Shank		VNM_ Gage Insert
	Right Hand	Left Hand	Height	Length	
MVTNR/L12-3B	51134	-	0.75	4.50	
MVTNR/L16-3C	51138	-	1.00	5.00	
MVTNR/L16-3D	51142	51143	1.00	6.00	332
MVTNR/L20-3D	51146	51147	1.25	6.00	
MVTNR/L24-3E	51150	-	1.50	7.00	

MVVNN Toolholder Style V- 17.5° Side Cutting Edge Angle for negative 35° diamond VNM_ inserts

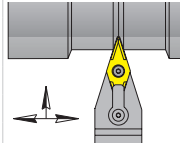

Description	UPC # Neutral	Shank		VNM_ Gage Insert
		Height	Length	
MVVNN12-3B	51160	0.75	4.50	
MVVNN16-3C	51162	1.00	5.00	332
MVVNN16-3D	51164	1.00	6.00	
MVVNN16-4C	51166	1.00	5.00	432
MVVNN16-4D	51168	1.00	6.00	

MRGO R/L Toolholder Style G- Profiling, Plunging and Turning for positive round RCM_ inserts

Description	UPC #		Shank		RCM_ Gage Insert
	Right Hand	Left Hand	Height	Length	
MRGOR/L85-4D	51244	51245	1.250	6.00	43
MRGOR/L20-6E	51248	51249	1.250	7.00	64
MRGOR/L24-8E	51252	-	1.500	7.00	84

WTJN R/L Toolholder Style J- 3° Side Cutting Edge Angle for negative triangle TNM_ inserts

Description	UPC #		Shank		TNM_ Gage Insert
	Right Hand	Left Hand	Height	Length	
WTJNR/L12-3C	51623	-	0.75	5.0	332
WTJNR/L16-3D	-	51629	1.00	6.0	

MRGN R/L Toolholder Style G- 0° Side Cutting Edge Angle for negative round RNM_ inserts

Description	UPC #		Shank		RNM_ Gage Insert	
	Right Hand	Left Hand	Height	Length		
MRGNR/L08-3A	51178	-	0.500	4.00	32	
MRGNR/L10-3B	-	51183	0.625	4.50		
MRGNR/L12-3B	51186	51187	0.750	4.50		
MRGNR/L16-3D	51190	51191	1.000	6.00		
MRGNR/L10-4B	-	51195	0.625	4.50	43	
MRGNR/L12-4B	51198	51199	0.750	4.50		
MRGNR/L16-4C	51202	51203	1.000	5.00	43	
MRGNR/L16-4D	51206	51207	1.000	6.00		
MRGNR/L20-4D	51210	51211	1.250	6.00		
MRGNR/L24-4E	51214	51215	1.500	7.00		
MRGNR/L85-4D	51218	51219	1.250	6.00		
MRGNR/L86-4E	-	51223	1.500	7.00		
MRGNR/L16-5D	51226	51227	1.000	6.00		54
MRGNR/L20-6D	51230	51231	1.250	6.00		64
MRGNR/L24-6E	51234	51235	1.500	7.00		

WWLN R/L Toolholder Style L- 5° End or Side Cutting Edge Angle for negative 80° trigon WNM_ inserts

Description	UPC #		Shank		WNM_ Gage Insert
	Right Hand	Left Hand	Height	Length	
WWLNR/L16-4D	51637	51638	1.00	6.0	432

CKJNR Toolholder Style J- 3° Side Cutting Edge Angle for negative KNUX inserts

Description	UPC #		Shank		KNUX Gage Insert
	Right Hand	Left Hand	Height	Length	
CKJNR12-5C	51592	-	0.75	5.0	160405
CKJNR20-5E	51596	-	1.25	7.0	

MWLN R/L Toolholder Style L- Negative 5° End or Side Cutting Edge Angle for negative 80° trigon WNM_ inserts

Description	UPC #		Shank		WNM_ Gage Insert
	Right Hand	Left Hand	Height	Length	
MWLNLR/L12-3B	51262	51263	0.75	4.50	332
MWLNLR/L16-3C	51264	51265	1.00	5.00	
MWLNLR/L12-4B	51266	51267	0.75	4.50	432
MWLNLR/L12-4D	51268	-	0.75	6.00	
MWLNLR/L16-4C	51280	51281	1.00	5.00	
MWLNLR/L16-4D	51270	51271	1.00	6.00	
MWLNLR/L20-4D	51274	51275	1.25	6.00	
MWLNLR/L20-4E	51276	51277	1.25	7.00	
MWLNLR/L85-4E	51296	-	1.25	7.00	
MWLNLR/L16-5D	51282	51283	1.00	6.00	
MWLNLR/L20-5D	51286	-	1.25	6.00	

CSBP R/L Toolholder Style B- 15° Side Cutting Edge Angle for 11° positive square SPG inserts

Description	UPC #		Shank		SPG Gage Insert
	Right Hand	Left Hand	Height	Length	
CSBPR/L10-3B	51300	-	0.625	4.50	322
CSBPR/L12-3B	51304	-	0.750	4.50	
CSBPR/L12-4B	51308	51309	0.750	4.50	

CSDPN Toolholder Style D- 45° Side Cutting Edge Angle for 11° positive square SPG inserts

Description	UPC #		Shank		SPG Gage Insert
	Right Hand	Left Hand	Height	Length	
CSDPN08-3J	51330	-	0.500	3.50	322
CSDPN10-3B	51332	-	0.625	4.50	
CSDPN12-3B	51334	-	0.750	4.50	
CSDPN12-4B	51336	-	0.750	4.50	422
CSDPN16-4D	51338	-	1.000	6.00	
CSDPN16-6D	51346	-	1.000	6.00	633
CSDPN85-6D	51348	-	1.250	6.00	
CSDPN86-6E	51350	-	1.500	7.00	

TAR R/L Toolholder Style A- 0° Side Cutting Edge Angle for negative triangle TNM_ inserts

Description	UPC #		Shank		TNM_ Gage Insert
	Right Hand	Left Hand	Height	Length	
TAR/L08-2B	54401	54402	0.500	4.500	221
TAR/L10-3B	54407	54408	0.625	4.500	322
TAR/L12-3B	-	54412	0.750	4.500	
TAR/L16-4D	54417	54418	1.000	6.000	432

TEN Toolholder Style E- 30° Side Cutting Edge Angle for negative triangle TNM_ inserts

Description	UPC #		Shank		TNM_ Gage Insert
	Right Hand	Left Hand	Height	Length	
TE10-3B	54428	-	0.625	4.500	322
TE12-3B	54431	-	0.750	4.500	
TE16-4D	54436	-	1.000	6.000	432

CSRP R/L Toolholder Style R- 15° Side Cutting Edge Angle for 11° positive square SPG inserts

Description	UPC #		Shank		SPG Gage Insert
	Right Hand	Left Hand	Height	Length	
CSRPR/L08-3J	51364	51365	0.500	3.50	322
CSRPR/L16-6D	51368	51369	1.000	6.00	633
CSRPR/L85-6D	-	51373	1.250	6.00	
CSRPR/L86-6E	51376	51377	1.500	7.00	

TGR R/L Toolholder Style G- 0° Side Cutting Edge Angle for negative triangle TNM_ inserts

Description	UPC #		Shank		TNM_ Gage Insert
	Right Hand	Left Hand	Height	Length	
TGR/L08-2B	54441	54442	0.500	4.50	221
TGR/L10-3B	54447	-	0.625	4.50	322
TGR/L12-3B	54451	54452	0.750	4.50	
TGR/L16-4D	54457	54458	1.000	6.00	432

CTAP R/L Toolholder Style A- 0° Side Cutting Edge Angle for 11° positive triangle TPG inserts

Description	UPC #		Shank		TPG Gage Insert
	Right Hand	Left Hand	Height	Length	
CTAPR/L06-2J	51382	-	0.375	3.50	221
CTAPR/L08-2J	51386	51387	0.500	3.50	
CTAPR/L10-2B	51390	51391	0.625	4.50	
CTAPR/L12-3B	51398	51399	0.750	4.50	322
CTAPR/L16-3D	51402	51403	1.000	6.00	
CTAPR/L65-3D	51406	51407	1.250	6.00	
CTAPR/L16-4D	51410	51411	1.000	6.00	432
CTAPR/L85-4D	51414	-	1.250	6.00	

**CTCON Toolholder Style C- 0° End Cutting Edge Angle
for 11° positive triangle TPG inserts**

Description	UPC #		Shank		TPG Gage Insert
	Neutral	Height	Length		
CTCON08-3J	51424	0.50	3.50		322
CTCON44-3F	51426	1.00	8.00		
CTCON12-4B	51428	0.75	4.50		
CTCON64-4F	51430	1.00	8.00		
CTCON66-4F	51432	1.50	8.00		

**CTFP R/L Toolholder Style F- 0° End Cutting Edge Angle
for 11° positive triangle TPG inserts**

Description	UPC #		Shank		TPG Gage Insert
	Right Hand	Left Hand	Height	Length	
CTFPR/L10-3B	51442	51443	0.625	4.50	322
CTFPR/L12-3B	51446	51447	0.750	4.50	
CTFPR/L16-3D	51450	-	1.000	6.00	
CTFPR/L12-4B	51454	-	0.750	4.50	
CTFPR/L16-4C	51458	51459	1.000	5.00	
CTFPR/L16-4D	51462	51463	1.000	6.00	432
CTFPR/L20-4D	51466	51467	1.250	6.00	
CTFPR/L85-4D	51470	-	1.250	6.00	

**CTGP R/L Toolholder Style G- 0° Side Cutting Edge Angle
for 11° positive triangle TPG inserts**

Description	UPC #		Shank		TPG Gage Insert
	Right Hand	Left Hand	Height	Length	
CTGPR/L10-3B	51492	51493	0.625	4.50	322
CTGPR/L12-3B	51496	51497	0.750	4.50	
CTGPR/L16-4C	-	51501	1.000	5.00	
CTGPR/L16-4D	51504	51505	1.000	6.00	
CTGPR/L20-4D	51508	51509	1.250	6.00	
CTGPR/L85-4D	51512	51513	1.250	6.00	432
CTGPR/L16-5D	51516	51517	1.000	6.00	
CTGPR/L20-5D	51520	51521	1.250	6.00	
CTGPR/L24-5E	51524	51525	1.500	7.00	543

**CTRP R/L Toolholder Style R- 15° Side Cutting Edge Angle
for 11° positive triangle TPG inserts**

Description	UPC #		Shank		TPG Gage Insert
	Right Hand	Left Hand	Height	Length	
CTRP/R10-2B	51534	51535	0.625	4.50	221
CTRP/R12-3B	51538	51539	0.750	4.50	322
CTRP/R16-3D	51542	51543	1.000	6.00	432
CTRP/R85-4D	51546	51547	1.250	6.00	

**CTCE R/L Toolholder Style L- 10° End Cutting Edge Angle
for 20° positive triangle TEGE inserts**

Description	UPC #		Shank		TEGE Gage Insert
	Right Hand	Left Hand	Height	Length	
CTCER/L06-7	51418	51419	0.375	2.50	1.81.51

**SCGC R/L Toolholder Style G- 0° Side Cutting Edge Angle
for 7° positive 80° diamond CC_T inserts**

Description	UPC #		Shank		CC_T Gage Insert
	Right Hand	Left Hand	Height	Length	
SCGCR/L05-2	51790	51791	0.312	2.50	21.51
SCGCR/L06-2J	51792	-	0.375	3.50	
SCGCR/L08-2A	-	51795	0.500	4.00	
SCGCR/L10-3A	-	51797	0.625	4.00	
SCGCR/L12-3B	-	51799	0.750	4.50	

**SCLC R/L Toolholder Style L- Negative 5° End or Side
Cutting Edge Angle for 7° positive 80° diamond CC_T inserts**

Description	UPC #		Shank		CC_T Gage Insert
	Right Hand	Left Hand	Height	Length	
SCLCR/L05-2	51806	51807	0.312	2.500	21.51
SCLCR/L06-2J	51800	51801	0.375	3.500	
SCLCR/L10-2A	-	51819	0.625	4.000	
SCLCR/L08-3A	51804	51805	0.500	4.000	
SCLCR/L10-3A	-	51823	0.625	4.000	
SCLCR/L10-3B	51808	51809	0.625	4.500	
SCLCR/L12-3B	51812	51813	0.750	4.500	
SCLCR/L16-3D	51816	51817	1.000	6.000	
SCLCR/L12-4B	51820	51821	0.750	4.500	
SCLCR/L16-4D	51824	51825	1.000	6.000	

**SCMCN Toolholder Style M- 40° Side Cutting Edge Angle
for 7° positive 80° diamond CC_T inserts**

Description	UPC #		Shank		CC_T Gage Insert
	Right Hand	Left Hand	Height	Length	
SCMCN08-2J	51833	-	0.500	3.500	21.51
SCMCN10-2A	51829	-	0.625	4.000	
SCMCN08-3J	51830	-	0.500	3.500	
SCMCN08-3A	51836	-	0.500	4.000	
SCMCN10-3A	51831	-	0.625	4.000	
SCMCN10-3B	51838	-	0.625	4.500	
SCMCN12-3B	51840	-	0.750	4.500	
SCMCN16-3D	51832	-	1.000	6.000	

**SCRCR R/L Toolholder Style R- 15° Side Cutting Edge Angle
for 7° positive 80° diamond CC_T inserts**

Description	UPC #		Shank		CC_T Gage Insert
	Right Hand	Left Hand	Height	Length	
SCRCR/L06-2	51859	51861	0.375	2.500	21.51
SCRCR/L08-2J	51863	51865	0.500	3.500	
SCRCR/L10-3A	51868	51869	0.625	4.000	

**SCYCN Toolholder Style Y- 50° Side Cutting Edge Angle
for 7° positive 80° diamond CC_T inserts**

Description	UPC #		Shank		CC_T Gage Insert
	Right Hand	Left Hand	Height	Length	
SCYCN06-2J	51854	-	0.375	3.500	21.51
SCYCN08-3A	51856	-	0.500	4.000	32.52
SCYCN12-4B	51862	-	0.750	4.500	432

**SCGPR R/L Toolholder Style G- 0° End Cutting Edge Angle
for 11° positive 80° diamond CP_T inserts**

Description	UPC #		Shank		CP_T Gage Insert
	Right Hand	Left Hand	Height	Length	
SCGPR/L06-2	51870	51871	0.375	2.500	21.51
SCGPR/L08-3J	51874	51875	0.500	3.500	32.52
SCGPR/L12-3B	51878	51879	0.750	4.500	

**SCLPR R/L Toolholder Style L- Negative 5° End or Side Cutting Edge
Angle for 11° positive 80° diamond CP_T inserts**

Description	UPC #		Shank		CP_T Gage Insert
	Right Hand	Left Hand	Height	Length	
SCLPR/L08-3J	51886	-	0.500	3.500	32.52
SCLPR/L12-3B	51890	51891	0.750	4.500	

SDJC R/L Toolholder Style J- Negative 3° Side Cutting Edge Angle for 7° positive 55° diamond DC_T inserts

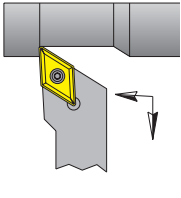

Description	UPC #		Shank		DC_T Gage Insert
	Right Hand	Left Hand	Height	Length	
SDJCR/L06-2J	51872	51873	0.375	3.500	21.51
SDJCR/L08-2A	51876	51877	0.500	4.000	
SDJCR/L08-3A	51880	51881	0.500	4.000	32.52
SDJCR/L10-3B	51884	51885	0.625	4.500	
SDJCR/L12-3B	51888	51889	0.750	4.500	
SDJCR/L16-3D	51892	-	1.000	6.000	
SDJCR/L16-4D	-	51901	1.000	6.000	432

SDPCN Toolholder Style P- 27.5° Side Cutting Edge Angle for 7° positive 55° diamond DC_T inserts

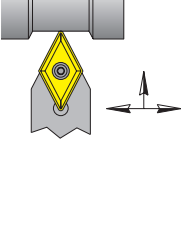

Description	UPC #		Shank		DC_T Gage Insert
	Neutral	Height	Length		
SDPCN06-2J	51910	0.375	3.500	21.51	
SDPCN06-2D	51942	0.375	6.000		
SDPCN08-2A	51912	0.500	4.000	32.52	
SDPCN08-3D	51944	0.500	6.000		
SDPCN10-3B	51914	0.625	4.500		
SDPCN10-3D	51945	0.625	6.000		
SDPCN12-3B	51916	0.750	4.500		
SDPCN16-3D	51918	1.000	6.000		
SDPCN12-4B	51920	0.750	4.500	432	
SDPCN16-4D	51922	1.000	6.000		

SDUC R/L Toolholder Style U- 3° End Cutting Edge Angle for 7° positive 55° diamond DC_T inserts

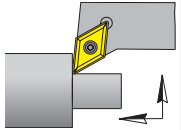

Description	UPC #		Shank		DC_T Gage Insert
	Right Hand	Left Hand	Height	Length	
SDUCR/L08-2J	51946	51947	0.500	3.500	21.51
SDUCR/L10-2A	51948	-	0.625	4.000	
SDUCR/L10-3A	51954	51959	0.625	4.000	32.52

SROCN Toolholder Style O- Profiling, Plunging and Turning for 7° positive round RC_T inserts

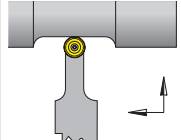

Description	UPC #	Shank	RC_T Gage Insert	
	Neutral	Height	Length	
SROCN20-10D	52169	1.250	6.000	1003MO

SRGCR/L Toolholder Style G- Profiling, Plunging and Turning for 7° positive round RC_T inserts

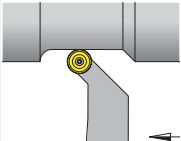

Description	UPC #		Shank		RC_T Gage Insert
	Right Hand	Left Hand	Height	Length	
SRGCR/L16-06D	-	52181	1.000	6.000	0602MO
SRGCR/L12-08B	52184	-	0.750	4.500	0803MO
SRGCR/L12-10B	-	52191	0.750	4.500	1003MO
SRGCR/L20-10D	-	52195	1.250	6.000	

SRCCR/L Toolholder Style C- Profiling, Plunging and Turning for 7° positive round RC_T inserts

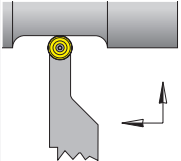

Description	UPC #		Shank		RC_T Gage Insert
	Right Hand	Left Hand	Height	Length	
SRCCR/L12-06B	52214	-	0.750	4.500	0602MO
SRCCR/L16-06D	-	52217	1.000	6.000	
SRCCR/L12-08B	52220	52221	0.750	4.500	0803MO
SRCCR/L16-08D	-	52223	1.000	6.000	
SRCCR/L12-10B	52226	52227	0.750	4.500	1003MO

SROPN Toolholder Style O- Profiling, Plunging and Turning for 11° positive round RP_T inserts

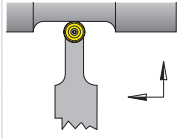

Description	UPC #		Shank		RP_T Gage Insert
	Neutral	Height	Length		
SROPN16-10D	52171	1.000	6.000	1003MO	
SROPN20-10D	52172	1.250	6.000		

SRGPR/L Toolholder Style G- Profiling, Plunging and Turning for 11° positive round RP_T inserts

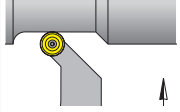

Description	UPC #	Shank	RP_T Gage Insert		
	Right Hand	Left Hand	Height	Length	
SRGPR/L16-10D	52198	-	1.000	6.000	1003MO

SRCP R/L Toolholder Style C- Profiling, Plunging and Turning for 11° positive round RP_T inserts

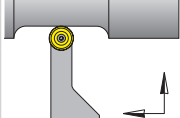

Description	UPC #		Shank		RP_T Gage Insert
	Right Hand	Left Hand	Height	Length	
SRCP R/L12-10B	52232	52233	0.750	4.500	1003MO

SSDCN Toolholder Style D - 45° Side Cutting Edge Angle for 7° positive square SC_T inserts

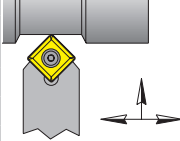

Description	UPC #		Shank		SC_T Gage Insert
	Neutral	Height	Length		
SSDCN08-3A	51932	0.500	4.000	32.52	
SSDCN10-3B	51934	0.625	4.500		
SSDCN12-3B	51936	0.750	4.500		
SSDCN16-4D	51938	1.000	6.000	432	

SSRCR/L Toolholder Style R - 15° Side Cutting Edge Angle for 7° positive square SC_T inserts

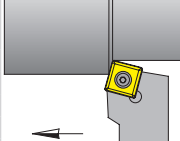

Description	UPC #		Shank		SC_T Gage Insert
	Right Hand	Left Hand	Height	Length	
SSRCR/L08-3A	51952	51953	0.500	4.000	32.52
SSRCR/L10-3A	51956	-	0.625	4.000	
SSRCR/L10-3B	51960	51961	0.625	4.500	
SSRCR/L12-3B	-	51965	0.750	4.500	
SSRCR/L16-4C	51968	-	1.000	5.000	432
SSRCR/L16-4D	51972	51973	1.000	6.000	

STAC R/L Toolholder Style A- 0° Side Cutting Edge Angle for 7° positive triangle TC_T inserts

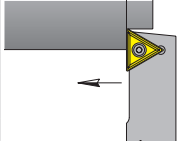

Description	UPC #		Shank		TC_T Gage Insert
	Right Hand	Left Hand	Height	Length	
STACR/L06-2	51556	51557	0.375	2.50	21.51
STACR/L08-2J	51558	-	0.500	3.50	
STACR/L10-2A	51560	51561	0.625	4.00	
STACR/L10-3B	-	51565	0.625	4.50	32.52
STACR/L12-3B	51562	51567	0.750	4.50	
STACR/L64-3D	51564	51569	1.000	6.00	432
STACR/L85-4D	51566	-	1.250	6.00	
STACR/L106-4D	51568	-	1.500	6.00	

STCCR Toolholder Style C - 0° End Cutting Edge Angle for 7° positive triangle TC_T inserts

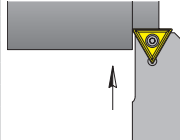

Description	UPC #		Shank		TC_T Gage Insert
	Right Hand	Height	Length		
STCCR06-2	51578	0.375	2.50	21.51	
STCCR08-2J	51580	0.500	3.50		
STCCR12-3B	51584	0.750	4.50	32.52	
STCCR64-3D	51586	1.000	6.00		
STCCR85-4D	51588	1.250	6.00	432	
STCCR106-4D	51590	1.500	6.00		

STDCR Toolholder Style D - 45° Side Cutting Edge Angle for 7° positive triangle TC_T inserts

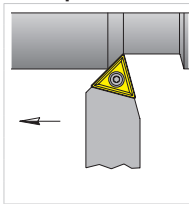

Description	UPC #		Shank		TC_T Gage Insert
	Right Hand	Left Hand	Height	Length	
STDCR06-2	51600	-	0.375	2.50	21.51
STDCR08-2J	51602	-	0.500	3.50	
STDCR10-2A	51604	-	0.625	4.00	
STDCR12-3B	51606	-	0.750	4.50	
STDCR64-3D	51608	-	1.000	6.00	32.52
STDCR85-4D	51610	-	1.250	6.00	432
STDCR106-4D	51612	-	1.500	6.00	

STECN Toolholder Style E - 30° Side Cutting Edge Angle for 7° positive triangle TC_T inserts

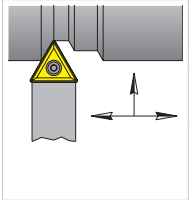

Description	UPC #		Shank		TC_T Gage Insert
	Neutral	Left Hand	Height	Length	
STECN06-2	51622	-	0.375	2.50	21.51
STECN08-2J	51624	-	0.500	3.50	
STECN12-3B	51628	-	0.750	4.50	
STECN64-3D	51630	-	1.000	6.00	
STECN85-4D	51632	-	1.250	6.00	432
STECN106-4D	51634	-	1.500	6.00	

STFCR R/L Toolholder Style F - 0° End Cutting Edge Angle for 7° positive triangle TC_T inserts

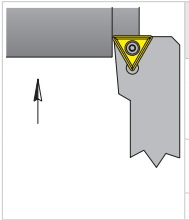

Description	UPC #		Shank		TC_T Gage Insert
	Right Hand	Left Hand	Height	Length	
STFCR/L06-2	-	51645	0.375	2.500	21.51
STFCR/L08-2J	51648	-	0.500	3.500	
STFCR/L10-2A	51652	51653	0.625	4.000	
STFCR/L10-3B	-	51657	0.625	4.500	
STFCR/L16-3D	51664	51665	1.000	6.000	32.52
STFCR/L20-4D	51668	51669	1.250	6.000	432

STGCR R/L Toolholder Style G - 0° Side Cutting Edge Angle for 7° positive triangle TC_T inserts

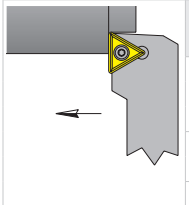

Description	UPC #		Shank		TC_T Gage Insert
	Right Hand	Left Hand	Height	Length	
STGCR/L06-2	51672	-	0.375	2.500	21.51
STGCR/L08-2J	51676	51677	0.500	3.500	
STGCR/L10-2A	51680	51681	0.625	4.000	
STGCR/L10-3B	-	51685	0.625	4.500	
STGCR/L12-3B	51688	51689	0.750	4.500	32.52
STGCR/L16-3D	51720	-	1.000	6.000	432
STGCR/L20-4D	-	51697	1.250	6.000	

STJCR R/L Toolholder Style J - 3° Side Cutting Edge Angle for 7° positive triangle TC_T inserts

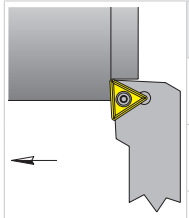

Description	UPC #		Shank		TC_T Gage Insert
	Right Hand	Left Hand	Height	Length	
STJCR/L06-2	51700	51701	0.375	2.500	21.51
STJCR/L08-2J	-	51705	0.500	3.500	
STJCR/L10-2A	51708	51709	0.625	4.000	
STJCR/L10-3B	-	51713	0.625	4.500	
STJCR/L12-3B	51716	-	0.750	4.500	32.52
STJCR/L16-3D	51720	-	1.000	6.000	432
STJCR/L20-4D	51724	51725	1.250	6.000	

STNCR R/L Toolholder Style N - 3° Side Cutting Edge Angle for 7° positive triangle TC_T inserts

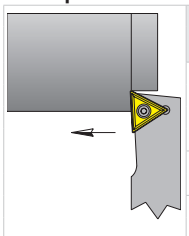

Description	UPC #		Shank		TC_T Gage Insert
	Right Hand	Left Hand	Height	Length	
STNCR/L06-2	51734	51735	0.375	2.500	21.51
STNCR/L08-2J	51736	-	0.500	3.500	
STNCR/L10-2A	51738	-	0.625	4.000	
STNCR/L10-2B	51749	-	0.625	4.500	
STNCR/L12-3B	51740	-	0.750	4.500	32.52
STNCR/L64-3D	51742	-	1.000	6.000	432
STNCR/L85-4D	51746	-	1.250	6.000	
STNCR/L106-4D	51748	51763	1.500	6.000	

STFPR R/L Toolholder Style F - 0° End Cutting Edge Angle for 11° positive triangle TP_T inserts

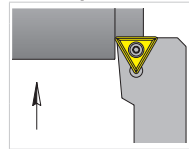

Description	UPC #		Shank		TC_T Gage Insert
	Right Hand	Left Hand	Height	Length	
STFPR/L06-2	51764	51765	0.375	2.500	21.51
STFPR/L08-2J	-	51767	0.500	3.500	

STGPR R/L Toolholder Style G - 0° Side Cutting Edge Angle for 11° positive triangle TP_T inserts

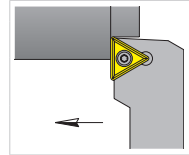

Description	UPC #		Shank		TC_T Gage Insert
	Right Hand	Left Hand	Height	Length	
STGPR/L06-2	51771	51773	0.375	2.500	21.51
STGPR/L08-2J	-	51775	0.500	3.500	

SVJBR R/L Toolholder Style J - Negative 3° Side Cutting Edge Angle for 5° positive 35° diamond VB_T inserts

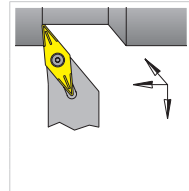

Description	UPC #		Shank		VB_T Gage Insert
	Right Hand	Left Hand	Height	Length	
SVJBR/L06-2	51984	51985	0.375	2.500	221
SVJBR/L08-2J	51986	-	0.500	3.500	
SVJBR/L10-2A	51988	51989	0.625	4.000	
SVJBR/L12-3B	52006	52007	0.750	4.500	
SVJBR/L16-3C	52010	52011	1.000	5.000	332
SVJBR/L16-3D	52014	52015	1.000	6.000	

SVUBR R/L Toolholder Style U - 3° End Cutting Edge Angle for 5° positive 35° diamond VB_T inserts

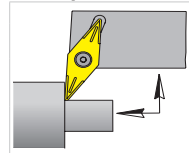

Description	UPC #		Shank		VB_T Gage Insert
	Right Hand	Left Hand	Height	Length	
SVUBR/L08-2J	51996	51997	0.500	3.500	221
SVUBR/L10-2A	-	51999	0.625	4.000	

SVVBN Toolholder Style V - 17.5° Side Cutting Edge Angle for 5° positive 35° diamond VB_T inserts

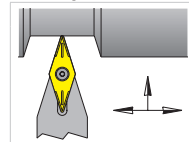

Description	UPC #		Shank		VB_T Gage Insert
	Neutral	Left Hand	Height	Length	
SVVBN12-3B	52062	-	0.750	4.500	332
SVVBN16-3D	52064	-	1.000	6.000	

SVJCR R/L Toolholder Style J - Negative 3° Side Cutting Edge Angle for 7° positive 35° diamond VC_T inserts

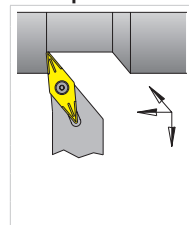

Description	UPC #		Shank		VC_T Gage Insert
	Right Hand	Left Hand	Height	Length	
SVJCR/L06-2J	-	52029	0.375	3.500	221
SVJCR/L08-2A	52032	52033	0.500	4.000	
SVJCR/L10-2B	52036	-	0.625	4.500	
SVJCR/L12-3B	52040	-	0.750	4.500	
SVJCR/L16-3D	52048	52049	1.000	6.000	332
SVJCR/L16-4D	52054	52055	1.000	6.000	

SVVCN Toolholder Style V - 17.5° Side Cutting Edge Angle for 7° positive 35° diamond VC_T inserts

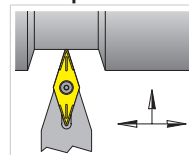

Description	UPC #		Shank		VC_T Gage Insert
	Neutral	Left Hand	Height	Length	
SVVCN20-3D	52086	-	1.250	6.000	

SVTC R/L Toolholder Style T - 27.5° End Cutting Edge Angle for 7° positive 35° diamond VC_T inserts

Description	UPC #		Shank		VC_T Gage Insert
	Right Hand	Left Hand	Height	Length	
SVTCR/L16-4D	52102	52103	1.000	6.000	448
SVTCR/L20-4D	52106	52107	1.250	6.000	

SVJP R/L Toolholder Style J - Negative 3° Side Cutting Edge Angle for 11° positive 35° diamond VP_T inserts

Description	UPC #		Shank		VC_T Gage Insert
	Right Hand	Left Hand	Height	Length	
SVJPR/L16-4D	52248	-	1.000	6.000	448
SVJPR/L20-4D	52250	52251	1.250	6.000	

SVLP R/L Toolholder Style L - 5° End Cutting Edge Angle for 11° positive 35° diamond VP_T inserts

Description	UPC #		Shank		VP_T Gage Insert
	Right Hand	Left Hand	Height	Length	
SVLPR/L16-4D	52274	52275	1.000	6.000	448
SVLPR/L20-4D	52276	52277	1.250	6.000	

SSQD R Toolholder Style Q - Convex Radius Cutting Edge for 15° positive square convex SDGX inserts

Description	UPC #		Shank		SDGX Gage Insert
	Right Hand	Left Hand	Height	Length	
SSQDR12-6B-08	52136		0.750	4.500	
SSQDR16-6D-08	52138		1.000	6.000	19C_
SSQDR20-6D-08	52140		1.250	6.000	
SSQDR12-6B-16	52142		0.750	4.500	19C_
SSQDR20-6D-16	52146		1.250	6.000	

SWLC R/L Toolholder Style L - Negative 5° End or Side Cutting Edge Angle for 7° positive 80° trigon WC_T inserts

Description	UPC #		Shank		WC_T Gage Insert
	Right Hand	Left Hand	Height	Length	
SWLCR/L06-2J	52096	52097	0.375	3.500	21.51
SWLCR/L08-3A	-	52101	0.500	4.000	
SWLCR/L10-3B	52104	52105	0.625	4.500	32.52
SWLCR/L12-3B	52108	52109	0.750	4.500	
SWLCR/L12-4B	52116	-	0.750	4.500	432
SWLCR/L16-4D	52120	52121	1.000	6.000	

DCLN R/L Toolholder Style L - 5° end or side cutting lead angle for negative 80° diamond CNM_ inserts

Description	UPC #		Shank		CNM_ Gage Insert
	Right Hand	Left Hand	Height	Length	
DCLNR/L12-4B	53800	53801	0.75	4.50	432
DCLNR/L16-4D	53802	53803	1.00	6.00	432
DCLNR/L20-4D	53804	53805	1.25	6.00	432

DDJN R/L Toolholder Style J - 3° side cutting lead angle for negative 55° diamond DNM_ inserts

Description	UPC #		Shank		DNM_ Gage Insert
	Right Hand	Left Hand	Height	Length	
DDJNR/L12-4B	53810	53811	0.75	4.50	432
DDJNR/L16-4D	53812	53813	1.00	6.00	432
DDJNR/L20-4D	53814	53815	1.25	6.00	432

NEW

Single Clamp Toolholders

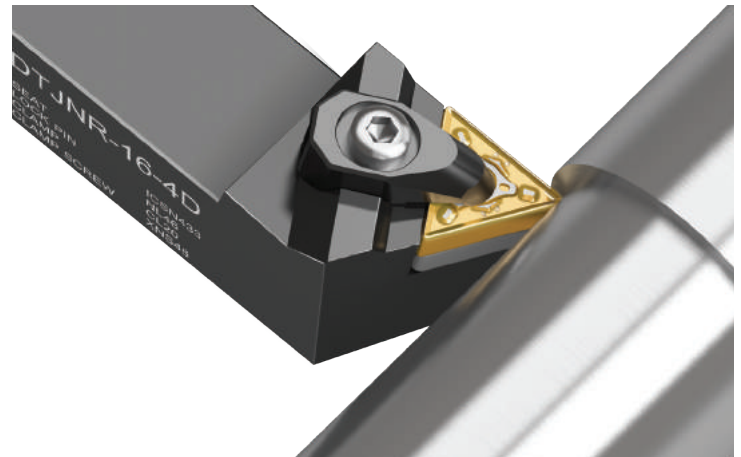

DDPNN Toolholder Style P - 27.5° side cutting lead angle for negative 55° diamond DNM_ inserts

Description	UPC #		Shank		DNM_ Gage Insert
	Neutral	Left Hand	Height	Length	
DDPNN12-4B	53816		0.75	4.50	432
DDPNN16-4D	53817		1.00	6.00	432
DDPNN20-4D	53818		1.25	6.00	432

DTENN Toolholder Style E - 30° side cutting lead angle for negative triangle TNM_ inserts

Description	UPC #		Shank		TNM_ Gage Insert
	Neutral	Left Hand	Height	Length	
DTENN12-3B	53836		0.75	4.50	332
DTENN16-3D	53837		1.00	6.00	332
DTENN16-4D	53838		1.00	6.00	432

DTJN R/L Toolholder Style J - 3° side cutting lead angle for negative triangle TNM_ inserts

Description	UPC #		Shank		TNM_ Gage Insert
	Right Hand	Left Hand	Height	Length	
DTJNR/L12-3B	53828	53829	0.75	4.50	332
DTJNR/L16-3D	53830	53831	1.00	6.00	332
DTJNR/L16-4D	53832	53833	1.00	6.00	432

DVJN R/L Toolholder Style J - Negative 3° side cutting lead angle for negative 35° diamond VNM_ inserts

Description	UPC #		Shank		VNM_ Gage Insert
	Right Hand	Left Hand	Height	Length	
DVJNR/L12-3B	53840	53841	0.75	4.50	332
DVJNR/L16-3D	53842	53843	1.00	6.00	332
DVJNR/L20-3D	53844	53845	1.25	6.00	332

DWLN R/L Toolholder Style L - Negative 5° end or side cutting lead angle for negative 80° trigon WNM_ inserts

Description	UPC #		Shank		WNM_ Gage Insert
	Right Hand	Left Hand	Height	Length	
DWLN R/L12-4B	53848	53849	0.75	4.50	432
DWLN R/L16-4D	53852	53853	1.00	6.00	432

S-MCKN R/L Boring Bar Style K - Negative 15° End Cutting Edge Angle for negative 80° diamond CNM_ inserts

Description	UPC #		Min. Bore	Bar Size	CNM_ Gage Insert
	Right Hand	Left Hand			
S20U-MCKNR/L-4	54992	54993	1.470	1.25	432
S24U-MCKNR/L-4	54994	54995	1.760	1.50	432
S32V-MCKNR/L-4	54996	54997	2.400	2.00	432
S32V-MCKNR/L-5	54998	54999	2.400	2.00	543

S-MCLN R/L Boring Bar Style L - Negative 5° Side & End Cutting Edge Angle for negative 80° diamond CNM_ inserts

Description	UPC #		Min. Bore	Bar Size	CNM_ Gage Insert
	Right Hand	Left Hand			
S12S-MCLNR/L-3	55002	55003	1.000	0.75	322
S16T-MCLNR/L-3	55004	55005	1.280	1.00	322
S12S-MCLNR/L-4	55006	55007	1.000	0.75	432
S16T-MCLNR/L-4	55010	55011	1.280	1.00	432
S20U-MCLNR/L-4	55014	55015	1.530	1.25	432
S24U-MCLNR/L-4	55018	55019	1.780	1.50	432
S28U-MCLNR/L-4	55022	55023	2.030	1.75	432
S32V-MCLNR/L-4	55024	55025	2.562	2.00	432
S24U-MCLNR/L-5	55026	55027	2.374	1.50	543
S32V-MCLNR/L-5	55030	55031	2.562	2.00	543
S40V-MCLNR/L-5	55034	55035	3.062	2.50	543
S48Y-MCLNR/L-5	55038	55039	3.562	3.00	543
S32V-MCLNR/L-6	55042	55043	2.562	2.00	643
S36V-MCLNR/L-6	55046	-	2.812	2.25	643
S40V-MCLNR/L-6	55050	55051	3.062	2.50	643

S-MDPN R/L Boring Bar Style P - Negative 27.5° End Cutting Edge Angle for negative 55° diamond DNM_ inserts

Description	UPC #		Min. Bore	Bar Size	DNM_ Gage Insert
	Right Hand	Left Hand			
S20U-MDPNR/L-4	55053	55054	1.705	1.25	432
S24U-MDPNR/L-4	55055	55056	2.000	1.50	432

S-MDQN R/L Boring Bar Style Q - Negative 17.5° End Cutting Edge Angle for negative 55° diamond DNM_ inserts

Description	UPC #		Min. Bore	Bar Size	DNM_ Gage Insert
	Right Hand	Left Hand			
S20U-MDQNR-4	55057	-	1.705	1.25	432
S24U-MDQNR/L-4	55059	55060	2.000	1.50	432

S-MDUN R/L Boring Bar Style U - Negative 3° End Cutting Edge Angle for negative 55° diamond DNM_ inserts

Description	UPC #		Min. Bore	Bar Size	DNM_ Gage Insert
	Right Hand	Left Hand			
S16T-MDUNR/L-3	55066	55067	1.300	1.00	332
S20U-MDUNR/L-4	55070	55071	2.00	1.25	432
S24U-MDUNR/L-4	55074	55075	2.25	1.50	432
S28U-MDUNR/L-4	55078	55079	2.50	1.75	432
S32V-MDUNR/L-4	55082	55083	3.00	2.00	432
S32V-MDUNR/L-5	55090	55091	3.00	2.00	543
S36V-MDUNR/L-5	55094	55095	3.25	2.25	543
S40V-MDUNR/L-5	55098	55099	3.50	2.50	543

S-MSKN R/L Boring Bar Style K - 15° End Cutting Edge Angle for negative square SNM_ inserts

Description	UPC #		Min. Bore	Bar Size	SNM_ Gage Insert
	Right Hand	Left Hand			
S20U-MSKNR/L-4	55100	55101	1.47	1.25	432
S24U-MSKNR/L-4	55102	55103	1.76	1.50	432
S28U-MSKNR-4	55104	-	2.01	1.75	432
S32V-MSKNR/L-6	55106	55107	2.40	2.00	643
S40V-MSKNR/L-6	55108	55109	3.03	2.50	643

S-MTFN R/L Boring Bar Style F - 0° End Cutting Edge Angle for negative triangle TNM_ inserts

Description	UPC #		Min. Bore	Bar Size	TNM_ Gage Insert
	Right Hand	Left Hand			
S12S-MTFNR-3	55150	-	1.000	0.75	322
S16T-MTFNR/L-3	55154	55155	1.280	1.00	322
S20U-MTFNR/L-3	55158	55159	1.530	1.25	322
S24U-MTFNR-3	55162	-	1.780	1.50	332
S28U-MTFNR/L-3	55166	55167	2.030	1.75	332
S20U-MTFNR/L-4	55170	55171	1.530	1.25	432
S24U-MTFNR/L-4	55174	55175	2.060	1.50	432
S28U-MTFNR/L-4	55178	55179	2.312	1.75	432
S32U-MTFNR/L-4	55182	55183	2.562	2.00	432
S36V-MTFNR-4	55186	-	2.812	2.25	432
S40V-MTFNR/L-4	55190	55191	3.062	2.50	432
S48Y-MTFNR/L-4	55194	55195	3.562	3.00	432

S-MTUN R/L Boring Bar Style U - Negative 3° End Cutting Edge Angle for negative triangle TNM_ inserts

Description	UPC #		Min. Bore	Bar Size	TNM_ Gage Insert
	Right Hand	Left Hand			
S12S-MTUNR/L-3	55204	55205	1.000	0.75	322
S16T-MTUNR/L-3	55208	55209	1.280	1.00	322
S20U-MTUNR/L-3	55212	55213	1.530	1.25	322
S24U-MTUNR/L-3	55216	55217	2.060	1.50	332
S20U-MTUNR/L-4	55220	55221	1.530	1.25	432
S24U-MTUNR/L-4	55224	55225	2.060	1.50	432
S32V-MTUNR/L-4	55228	55229	2.562	2.00	432
S40V-MTUNR/L-4	55232	55233	3.062	2.50	432

S-MVUN R/L Boring Bar Style U - Negative 3° Side Cutting Edge Angle for negative 35° diamond VNM_ inserts

Description	UPC #		Min. Bore	Bar Size	VNM_ Gage Insert
	Right Hand	Left Hand			
S16T-MVUNR/L-3	55266	55267	2.00	1.00	332
S20U-MVUNR/L-3	55270	55271	2.25	1.25	332
S24U-MVUNR/L-3	55274	55275	2.50	1.50	332
S28U-MVUNR/L-4	55278	55279	3.00	1.75	332
S32V-MVUNR/L-4	55282	55283	3.25	2.00	432
S40V-MVUNR/L-4	55290	55291	3.75	2.50	432

S-MVXN R/L Boring Bar Style X - Negative 5° Back Boring Cutting Edge Angle for negative 35° diamond VNM_ inserts

Description	UPC #		Min. Bore	Bar Size	VNM_ Gage Insert
	Right Hand	Left Hand			
S24U-MVXNR/L-3	55300	55301	2.25	1.50	332
S28U-MVXNR/L-3	55304	55305	2.50	1.75	332
S32V-MVXNR-4	55308	-	3.00	2.00	432

S-MWLN R/L Boring Bar Style L - Negative 5° End & Side Cutting Edge Angle for negative trigon WNM_ inserts

Description	UPC #		Min. Bore	Bar Size	WNM_ Gage Insert
	Right Hand	Left Hand			
S12S-MWLN/L-3	55318	55319	1.00	0.75	332
S16T-MWLN/L-3	55320	55321	1.28	1.00	332
S16T-MWLN/L-4	55322	55323	1.28	1.00	432
S20U-MWLN/L-4	55326	55327	1.53	1.25	432
S24U-MWLN/L-4	55330	55331	1.78	1.50	432

S-CTFP R/L Boring Bar Style F - 0° End Cutting Edge Angle for 11° positive triangle TPG inserts

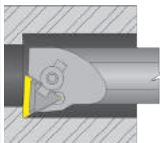

Description	UPC #		Min. Bore	Bar Size	TPG Gage Insert
	Right Hand	Left Hand			
S08R-CTFPR/L-2	55356	55357	0.600	0.500	221
S10S-CTFPR/L-2	55358	55359	0.770	0.625	
S12S-CTFPR/L-3	55360	55361	1.125	0.750	322
S16T-CTFPR/L-3	55364	55365	1.280	1.000	
S20U-CTFPR/L-3	55368	55369	1.530	1.250	
S24U-CTFPR/L-3	55372	55373	1.840	1.500	
S28U-CTFPR/L-3	55376	55377	2.100	1.750	
S20U-CTFPR/L-4	55380	55381	1.530	1.250	
S24U-CTFPR/L-4	55384	55385	2.060	1.500	
S28U-CTFPR/L-4	55388	55389	2.380	1.750	
S32V-CTFPR/L-4	55392	55393	2.562	2.000	432
S36V-CTFPR/L-4	55396	55397	2.880	2.250	
S40V-CTFPR/L-4	-	55401	3.062	2.500	
S48Y-CTFPR/L-4	55404	55405	3.562	3.000	

S-SDXC R/L Boring Bar Style X - Negative 5° Back Boring Cutting Edge Angle for 7° positive 55° diamond DC_T inserts

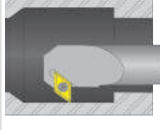

Description	UPC #		Min. Bore	Bar Size	DC_T Gage Insert
	Right Hand	Left Hand			
S08R-SDXCR/L-2	55426	55427	0.73	0.500	21.51
S10S-SDXCL-2	-	55429	0.85	0.625	
S12S-SDXCR/L-3	55430	55431	0.98	0.750	32.52
S16T-SDXCR/L-3	55432	55433	1.30	1.000	

S-SSKC R/L Boring Bar Style K -15° End Cutting Edge Angle for 7° positive square SC_T inserts



Description	UPC #		Min. Bore	Bar Size	SC_T Gage Insert
	Right Hand	Left Hand			
S10R-SSKCR/L-3	55593	55594	0.800	0.625	32.52
S12S-SSKCR/L-3	55595	-	0.975	0.750	
S16T-SSKCR-4	55597	-	1.220	1.000	432

S-SVQB R/L Boring Bar Style Q - Negative 5° End Cutting Edge Angle for 5° positive 35° diamond VB_T inserts

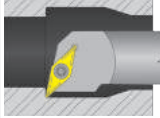

Description	UPC #		Min. Bore	Bar Size	VB_T Gage Insert
	Right Hand	Left Hand			
S10S-SVQBR/L-2	55410	55411	0.85	0.625	221
S12S-SVQBR/L-2	55412	55413	0.98	0.750	
S16T-SVQBR-3	55414	-	1.30	1.000	332

S-STFC R/L Boring Bar Style F - 0° End Cutting Edge Angle for 7° positive triangle TC_T inserts

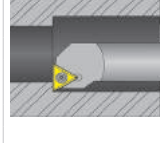

Description	UPC #		Min. Bore	Bar Size	TC_T Gage Insert
	Right Hand	Left Hand			
S06M-STFCR/L-2	55600	55601	0.500	0.375	21.51
S08M-STFCR/L-2	55604	55605	0.625	0.500	
S10R-STFCR/L-2	55608	55609	0.812	0.625	
S12S-STFCR/L-2	55612	55613	1.000	0.750	
S16T-STFCR/L-3	55616	55617	1.280	1.000	32.52
S20U-STFCR/L-3	55620	55621	1.530	1.250	
S24U-STFCL-3	-	55625	1.780	1.500	

S-SCFC R/L Boring Bar Style F - 0° End Cutting Edge Angle for 7° positive 80° diamond CC_T inserts

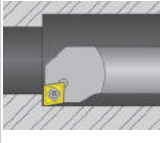

Description	UPC #		Min. Bore	Bar Size	CC_T Gage Insert
	Right Hand	Left Hand			
S06M-SCFCL-2	-	55417	0.48	0.375	21.51
S08R-SCFCR-2	55418	-	0.60	0.500	
S10S-SCFCR-2	55420	-	0.77	0.625	
S12S-SCFCR/L-3	55422	55423	0.93	0.750	32.52
S16T-SCFCR-3	55424	-	1.20	1.000	

S-STUC R Boring Bar Style U - Negative 3° End Cutting Edge Angle for 7° positive triangle TC_T inserts

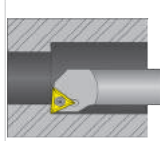

Description	UPC #		Min. Bore	Bar Size	TC_T Gage Insert
	Right Hand	Left Hand			
S06M-STUCR-2	55628	-	0.477	0.375	21.51
S08M-STUCR-2	55629	-	0.602	0.500	
S10R-STUCR-2	55630	-	0.797	0.625	
S12S-STUCR-3	55631	-	0.954	0.750	
S16T-STUCR-3	55632	-	1.280	1.000	32.52
S20T-STUCR-4	55633	-	1.370	1.250	
S24T-STUCR-4	55634	-	1.680	1.500	432

S-SCLC R/L Boring Bar Style L - Negative 5° End & Side Cutting Edge Angle for 7° positive 80° diamond CC_T inserts

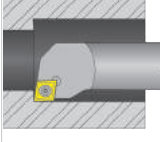

Description	UPC #		Min. Bore	Bar Size	CC_T Gage Insert
	Right Hand	Left Hand			
S06M-SCLCR/L-2	55470	55471	0.477	0.375	21.51
S08M-SCLCR/L-2	55474	55475	0.602	0.500	
S10R-SCLCR/L-2	55478	55479	0.812	0.625	32.52
S08M-SCLCR/L-3	55482	55483	0.625	0.500	
S10R-SCLCR/L-3	55486	55487	0.797	0.625	
S12S-SCLCR/L-3	55490	55491	0.954	0.750	32.52
S16T-SCLCR/L-3	55494	55495	1.250	1.000	
S16T-SCLCR/L-4	55498	55499	1.280	1.000	432
S20U-SCLCR/L-4	55502	55503	1.530	1.250	
S24U-SCLCR/L-4	55506	55507	1.780	1.500	

S-SVMC R Boring Bar Style M - Negative 5° Side Cutting Edge Angle for 7° positive 35° diamond VC_T inserts

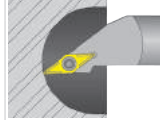

Description	UPC #		Min. Bore	Bar Size	VC_T Gage Insert
	Right Hand	Left Hand			
S08R-SVMCR-2	55730	-	0.580	0.500	221
S10S-SVMCR-2	55731	-	0.980	0.625	
S12S-SVMCR-3	55732	-	1.000	0.750	332
S16T-SVMCR-3	55733	-	1.300	1.000	

S-SDUC R/L Boring Bar Style U - Negative 3° End Cutting Edge Angle for 7° positive 55° diamond DC_T inserts

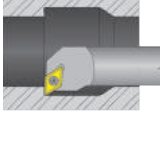

Description	UPC #		Min. Bore	Bar Size	DC_T Gage Insert
	Right Hand	Left Hand			
S06M-SDUCR/L-2	55560	55561	0.625	0.375	21.51
S08M-SDUCR/L-2	55564	55565	0.780	0.500	
S10R-SDUCR/L-2	55568	55569	0.840	0.625	32.52
S12S-SDUCR/L-3	55572	55573	1.125	0.750	
S16T-SDUCR/L-3	55576	55577	1.500	1.000	
S20U-SDUCR/L-3	55580	55581	1.750	1.250	432
S16T-SDUCR/L-4	55582	55583	1.500	1.000	

S-SVQC R Boring Bar Style Q - Negative 17.5° End Cutting Edge Angle for 7° positive 35° diamond VC_T inserts

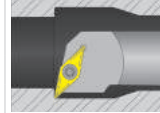

Description	UPC #		Min. Bore	Bar Size	VC_T Gage Insert
	Right Hand	Left Hand			
S10R-SVQCR-2	55814	-	0.85	0.625	221
S12S-SVQCR-2	55816	-	0.98	0.750	
S16T-SVQCR-3	55818	-	1.30	1.000	332

S-SDQC R/L Boring Bar Style Q - Negative 17.5° End Cutting Edge Angle for 7° positive 55° diamond DC_T inserts

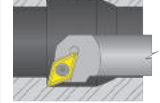

Description	UPC #		Min. Bore	Bar Size	DC_T Gage Insert
	Right Hand	Left Hand			
S08M-SDQCR-2	55585	-	0.73	0.500	21.51
S10R-SDQCR/L-2	55587	55588	0.85	0.625	
S12S-SDQCR-3	55589	-	0.98	0.750	32.52

S-SVUC R/L Boring Bar Style U - Negative 3° End Cutting Edge Angle for 7° positive 35° diamond VC_T inserts

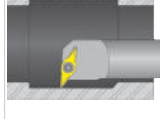

Description	UPC #		Min. Bore	Bar Size	VC_T Gage Insert
	Right Hand	Left Hand			
S12S-SVUCR/L-2	55800	55801	1.125	0.75	221
S16T-SVUCR-2	55804	-	1.300	1.00	
S16T-SVUCR/L-3	55808	55809	1.625	1.00	332
S20U-SVUCR/L-3	55812	55813	1.625	1.25	

S-SVXC R/L Boring Bar Style X - Negative 5° Back Boring Cutting Edge Angle for 7° positive 35° diamond VC_T inserts

Description	UPC #		Min. Bore	Bar Size	VC_T Gage Insert
	Right Hand	Left Hand			
S12S-SVXCR-2	55822	-	1.125	0.75	221
S16T-SVXCR-2	55826	-	1.500	1.00	
S16T-SVXCR/L-3	55830	55831	2.000	1.00	332
S20U-SVXCR/L-3	55834	55835	2.250	1.25	

S-STLP R Boring Bar Style L - Negative 5° End Cutting Edge Angle for 11° positive triangle TPGH and TPGB inserts

Description	UPC #		Min. Bore	Bar Size	TPG_Gage Insert
	Right Hand	Left Hand			
S06M-STLPR-2	55846	-	0.430	0.375	21.51
S08M-STLPR-2	55848	-	0.590	0.500	
S10R-STLPR-2	55850	-	0.682	0.625	
S12S-STLPR-3	55852	-	0.845	0.750	
S16T-STLPR-3	55854	-	1.115	1.000	322
S20T-STLPR-3	55856	-	1.370	1.250	

S-SWUC R/L Boring Bar Style U - Negative 3° End Cutting Edge Angle for 7° positive 80° trigon WC_T inserts

Description	UPC #		Min. Bore	Bar Size	WC_T Gage Insert
	Right Hand	Left Hand			
S06M-SWUCR/L-2	55912	55913	0.500	0.375	21.51
S08M-SWUCR/L-2	55916	55917	0.625	0.500	
S10R-SWUCR/L-2	55920	55921	0.812	0.625	
S08M-SWUCR/L-3	55924	55925	0.625	0.500	
S10R-SWUCR/L-3	55928	55929	0.812	0.625	32.52
S12S-SWUCR/L-3	55932	55933	1.000	0.750	
S16T-SWUCR/L-4	55940	55941	1.280	1.000	432
S24U-SWUCR-4	55948	-	1.780	1.500	

S-STUP R/L Boring Bar Style U - Negative 3° End Cutting Edge Angle for 11° positive triangle TPGH and TPGB inserts

Description	UPC #		Min. Bore	Bar Size	TPG_Gage Insert
	Right Hand	Left Hand			
S16T-STUPR/L-3	55682	55683	1.22	1.00	322
S24U-STUPR/L-3	55690	55691	1.84	1.50	
S28U-STUPR/L-4	55702	55703	2.38	1.75	
S32V-STUPR-4	55706	-	2.62	2.00	
S40V-STUPR-4	55714	-	3.12	2.50	432

S-SCFP R Boring Bar Style F - 0° End Cutting Edge Angle for 11° positive 80° diamond CP_T inserts

Description	UPC #		Min. Bore	Bar Size	CP_T Gage Insert
	Right Hand	Left Hand			
S06M-SCFPR-2	55751	-	0.48	0.375	21.51
S08R-SCFPR-2	55753	-	0.60	0.500	
S10S-SCFPR-2	55755	-	0.77	0.625	

STCMB Boring Bar - Roughing to Finishing, Square Shoulders to Through Bores for 7° positive triangle TCMT Inserts

Description	UPC #		Min. Bore	Bar Size	TC_T Gage Insert
	Right Hand	Left Hand			
STCMB06-2	55738	-	0.500	0.500	21.51
STCMB08-2	55740	-	0.590	0.500	
STCMB10-2	55742	-	0.750	0.625	
STCMB12-3	55744	-	0.845	0.750	32.52
STCMB16-3	55746	-	1.115	1.000	
STCMB20-4	55748	-	1.370	1.250	432

S-SCLP R/L Boring Bar Style L - Negative 5° End & Side Cutting Edge Angle for 11° positive 80° diamond CP_T inserts

Description	UPC #		Min. Bore	Bar Size	CP_T Gage Insert
	Right Hand	Left Hand			
S06M-SCLPR-2	55761	-	0.48	0.375	21.51
S08R-SCLPR/L-2	55763	55764	0.60	0.500	
S10S-SCLPR/L-2	55765	55766	0.77	0.625	
S10S-SCLPR/L-3	55767	55768	0.77	0.625	
S12S-SCLPR/L-3	55769	55770	0.93	0.750	32.52
S16T-SCLPR/L-3	55771	55772	1.20	1.000	

TPBN Boring Bar - Roughing to Finishing, Square Shoulders to Through Bores for 11° positive triangle TPGH or TPGB Inserts

Description	UPC #		Min. Bore	Bar Size	TP_Gage Insert
	Right Hand	Left Hand			
TPBN06-2	55658	-	0.430	0.500	21.51
TPBN08-2	55660	-	0.590	0.500	
TPBN10-2	55662	-	0.682	0.625	
TPBN12-3	55664	-	0.845	0.750	
TPBN16-3	55666	-	1.115	1.000	322
TPBN20-3	55668	-	1.370	1.250	
TPBN20-4	55670	-	1.370	1.250	432
TPBN24-4	55672	-	1.680	1.500	

S-SDUP R/L Boring Bar Style U - Negative 3° End Cutting Edge Angle for 11° positive 55° diamond DP_T inserts

Description	UPC #		Min. Bore	Bar Size	DP_T Gage Insert
	Right Hand	Left Hand			
S06M-SDUPR/L-2	55774	55775	0.60	0.375	21.51
S08R-SDUPR-2	55776	-	0.73	0.500	
S12S-SDUPR/L-3	55780	55781	0.98	0.750	32.52
S16T-SDUPR/L-3	55782	55783	1.30	1.000	

MINI S-SCLC R/L Boring Bar Style L - Negative 5° End & Side Cutting Edge Angle for 7° positive 80° diamond CC_T inserts

Description	UPC #		Min. Bore	Bar Size	CC_T Gage Insert
	Right Hand	Left Hand			
S06H-SCLCR/L-2	55450	55451	.394	.375	21.51
S08K-SCLCR/L-2	55454	55455	.550	.500	
S10M-SCLCR/L-2	55458	55459	.708	.625	

S-SDXP R/L Boring Bar Style X - Negative 5° Back Boring Cutting Edge Angle for 11° positive 55° diamond DP_T inserts

Description	UPC #		Min. Bore	Bar Size	DP_T Gage Insert
	Right Hand	Left Hand			
S10S-SDXPR-2	55786	-	0.85	0.625	21.51
S16T-SDXPL-3	-	55791	1.30	1.000	

MINI S-SDUC R/L Boring Bar Style U - Negative 3° End Cutting Edge Angle for 7° positive 55° diamond DC_T inserts

Description	UPC #		Min. Bore	Bar Size	DC_T Gage Insert
	Right Hand	Left Hand			
S06H-SDUCR-2	55540	-	.492	.375	21.51
S08K-SDUCR/L-2	55544	55545	.610	.500	
S10M-SDUCR-2	55548	-	.768	.625	

S-STFP R/L Boring Bar Style F - 0° End Cutting Edge Angle for 11° positive triangle TPGB and TPGH inserts

Description	UPC #		Min. Bore	Bar Size	TPG_Gage Insert
	Right Hand	Left Hand			
S06M-STFPR/L-2	55636	55637	0.470	0.375	21.51
S08M-STFPR/L-2	55640	55641	0.600	0.500	
S10R-STFPR/L-2	55644	55645	0.770	0.625	
S12S-STFPR-3	55648	-	0.930	0.750	

MINI S-STUC R Boring Bar Style U - Negative 3° End Cutting Edge Angle for 7° positive triangle TC_T inserts

Description	UPC #		Min. Bore	Bar Size	TC_T Gage Insert
	Right Hand	Left Hand			
S08H-STUCR-1.2-2	55724	-	.286	.500	1.21.20.5
S08H-STUCR-1.2-3	55726	-	.313	.500	
S08H-STUCR-1.2-4	55728	-	.374	.500	

MINI S-SWUC R Boring Bar Style U - Negative 3° End Cutting Edge Angle for 7° positive 80° trigon WC_T inserts

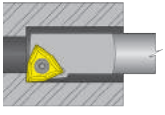

Description	UPC #		Min. Bore	Bar Size	WC_T Gage Insert
	Right Hand				
S08H-SWUCR-1.2-2	55900		.228	.500	1.210.0
S08H-SWUCR-1.2-3	55902		.308	.500	
S08H-SWUCR-1.2-4	55904		.374	.500	
S06H-SWUCR-2	55906		.394	.375	21.51
S08K-SWUCR-2	55907		.550	.500	
S10M-SWUCR-2	55908		.708	.625	

MINI S-DTUC R Boring Bar Style U - Negative 3° End or Side Cutting Edge Angle for double 7° positive triangle TC_T inserts

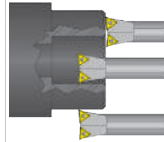

Description	UPC #		Min. Bore	Bar Size	TC_T Gage Insert
	Right Hand				
S08K-DTUC-2	57736		0.875	0.500	21.51
S12M-DTUC-2	57744		1.062	0.750	
S16Q-DTUC-3	57747		1.312	1.000	32.52
S20R-DTUC-3	57750		1.625	1.250	

S-DCLNR Boring Bar Style L - Negative 5° End or Side Cutting Edge Angle for two 80° diamond CNM_ inserts

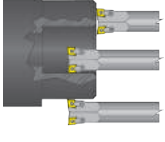

Description	UPC #		Min. Bore	Bar Size	CNM_ Gage Insert
	Right Hand				
S16T-DCLN-4	57510		1.500	1.00	432
S20U-DCLN-4	57514		1.750	1.25	
S24U-DCLN-4	57518		2.000	1.50	
S24U-DCLN-5	57522		2.000	1.50	543

S-DTUNR Boring Bar Style U - Negative 3° End or Side Cutting Edge Angle for two triangle TNM_ inserts

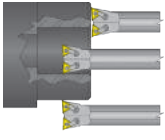

Description	UPC #		Min. Bore	Bar Size	TNM_ Gage Insert
	Right Hand				
S16Q-DTUN-3	57550		1.500	1.00	322
S20R-DTUN-3	57552		1.750	1.25	
S16T-DTUN-3	57554		1.500	1.00	
S32V-DTUN-4	57570		2.625	2.00	432

S-DTUN_T R Bar Style U - Negative 3° End or Side Cutting Edge Angle for one negative triangle TNM_ & one Laydown insert

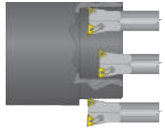

Description	UPC #		Min. Bore	Bar Size	TNM_ Gage Insert
	Right Hand				
S20R-DTUN-3-T16	57578		1.75	1.25	322
S16T-DTUN-3-T16	57580		1.50	1.00	

S-DWLN R Boring Bar Style L - Negative 5° End or Side Cutting Edge Angle for negative 80° trigon WNM_ inserts

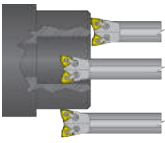

Description	UPC #		Min. Bore	Bar Size	WNM_ Gage Insert
	Right Hand				
S12M-DWLN-3	57610		1.25	0.75	332
S20R-DWLN-4	57620		1.75	1.25	
S20U-DWLN-4	57622		1.75	1.25	
S24U-DWLN-4	57626		2.00	1.50	432

MINI S-DCLC R Boring Bar Style L - Negative 5° End or Side Cutting Edge Angle for double 7° positive 80° diamond CC_T inserts

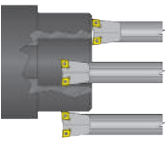

Description	UPC #		Min. Bore	Bar Size	CC_T Gage Insert
	Right Hand				
S08K-DCLC-2	57700		0.688	.500	21.51
S10L-DCLC-2	57704		0.938	.625	
S12M-DCLC-3	57708		1.063	.750	32.52
S16Q-DCLC-4	57710		1.375	1.00	
S20R-DCLC-4	57712		1.625	1.25	

MINI S-DTUC-T R Bar Style U - Negative 3° End or Side Cutting Edge Angle for one 7° positive triangle TC_T & one Laydown inserts

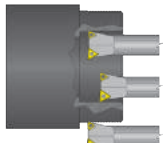

Description	UPC #		Min. Bore	Bar Size	TC_T Gage Insert
	Right Hand				
S08K-DTUC-2-T11	57758		0.875	0.500	21.51
S16Q-DTUC-3-T16	57770		1.312	1.000	
S20R-DTUC-3-T16	57772		1.625	1.250	32.52

STUCR Miniature Boring Set

Negative 3° End Cutting Edge Angle for 7° positive 60° triangle inserts

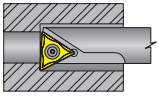

- Small hole boring without the use of reamers
- Greater productivity through better tool utilization
- Close tolerances
- Eliminates reamers
- Better surface finish
- Alloy steel boring bar



Set UPC #	Shank Size	Min. Bore	15 Piece Set Includes			
			3 Boring Bars	10 Inserts	1 Torx Key	1 Storage Box
85076	0.500	0.286	S08H-STUCR-1.2-2	TCMT-1.21.20.2- PEF-DPC25UT	T-6	Storage Box
	0.500	0.313	S08H-STUCR-1.2-3			
	0.500	0.374	S08H-STUCR-1.2-4			

TPBN Medium Boring Set

Negative 5° End Cutting Edge Angle for 11° positive 60° triangle inserts

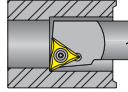

- For a Precise Bore with a Quality Boring Bar
- From Roughing To Finishing
- Square Shoulders to Through Bores



Set UPC #	Shank Size	Min. Bore	27 Piece Set Includes			
			4 Boring Bars	20 Inserts	2 Torx Keys	1 Storage Box
85086	0.500	0.430	TPBN06-2 TPBN08-2 TPBN10-2 TPBN12-3	(10) TPGH-21.51- EZ-DPP30GT	T-8 T-10	Storage Box
	0.500	0.590				
	0.625	0.682				
	0.750	0.845				

SCLCR Miniature Boring Set

Negative 5° End Cutting Edge Angle for 7° positive 80° diamond inserts

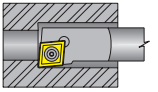

- Precision finishing operation
- For steel & stainless steel
- Sharp cutting edge
- Good chip control

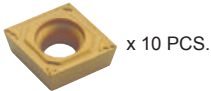

Set UPC #	Shank Size	Min. Bore	15 Piece Set Includes			
			3 Boring Bars	10 Inserts	1 Torx Key	1 Storage Box
85064	0.375	0.394	S06H-SCLCR-2 S08K-SCLCR-2 S10M-SCLCR-2	CCMT-21.51- PEM-DPC25UT	T-8	Storage Box
	0.500	0.550				
	0.625	0.708				

SDUCR Miniature Boring Set

Negative 3° End Cutting Edge Angle for 7° positive 55° diamond inserts

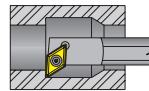

- Precision finishing operation
- For steel & stainless steel
- Sharp cutting edge
- Good chip control

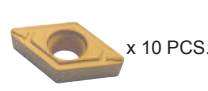

Set UPC #	Shank Size	Min. Bore	15 Piece Set Includes			
			3 Boring Bars	10 Inserts	1 Torx Key	1 Storage Box
85068	0.375	0.492	S06H-SDUCR-2 S08K-SDUCR-2 S10M-SDUCR-2	DCMT-21.51- PEF-DPC25UT	T-8	Storage Box
	0.500	0.610				
	0.625	0.768				

SWUCR Medium Boring Set

Negative 3° End Cutting Edge Angle for 7° positive 80° trigon inserts

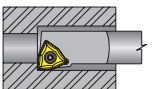

- Precision finishing operation
- For steel & stainless steel
- Sharp cutting edge
- Good chip control



Set UPC #	Shank Size	Min. Bore	15 Piece Set Includes			
			3 Boring Bars	10 Inserts	1 Torx Key	1 Storage Box
85072	.375	.394	S06H-SWUCR-2 S08K-SWUCR-2 S10M-SWUCR-2	WCGT-21.51- UEU-DUP15VT	T-8	Storage Box
	.500	.550				
	.625	.708				

SWUCR Miniature Boring Set

Negative 3° End Cutting Edge Angle for 7° positive 80° trigon inserts

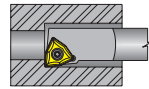



- Precision finishing operation
- For steel & stainless steel
- Sharp cutting edge
- Good chip control



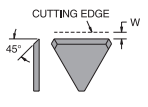
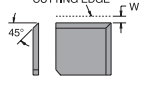
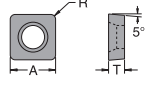
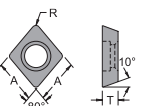
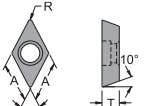
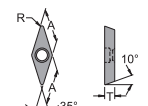

Set UPC #	Shank Size	Min. Bore	15 Piece Set Includes			
			3 Boring Bars	10 Inserts	1 Torx Key	1 Storage Box
85070	.500	.228	S08H-SWUCR-1.2-2 S08H-SWUCR-1.2-3 S08H-SWUCR-1.2-4	WCMT-1.210.2- PEF-DPC25UT	T-6	Storage Box
	.500	.308				
	.500	.374				

Finger Clamp	Description	UPC #	B	C	D	E	G	Thread	PKG.
	CL-5	90680	.280	.52	.350	.102	-	10-32	10
	CL-6	90681	.310	.58	.440	.187	.094	10-32	
	CL-7	90682	.310	.64	.310	.082	-	10-32	
	CL-9	90683	.430	.75	.660	.344	.125	5/16-24	
	CL-12	90684	.430	.88	.660	.344	.125	5/16-24	
	CL-19	90685	.310	.55	.310	.062	-	10-32	
	CL-20	90686	.375	.73	.380	.125	-	1/4-28	
	CL-24	90687	.491	1.0	.785	.453	.136	3/8-24	
	CL-30	90688	.430	1.0	.660	.344	.125	5/16-24	
	Dor-Lock Clamp	Description	UPC #	Dor-Lock Clamp					
	DC-5N	90151							
	DCTW-3N	90153							
	DCTW-4N	53256							
	DD-4N	90152							
	DV-3N	90154							
Dor-Lock Clamp Screw	Description	UPC #	Dor-Lock Clamp Screw						
	DCS-04	90155							
	DSP-04	90156							
Negative Lock Pins	Description	UPC #	Insert I.C.	Nominal Length	Thread	Hex Wrench Size	PKG.		
	Inch								
	NL-23	90472	.250	.328	8-32	1/16	10		
	NL-33	90473	.375	.344	10-32	5/64			
	NL-33L	90474	.375	.406	10-32	5/64			
	NL-34	90475	.375	.453	10-32	5/64			
	NL-34L	90476	.375	.516	10-32	5/64			
	NL-43	90477	.500	.420	10-32	5/64			
	NL-44	90478	.500	.516	1/4-28	3/32			
	NL-46	90479	.500	.672	1/4-28	3/32			
	NL-46L	90480	.500	.730	1/4-28	3/32			
	NL-56	90481	.625	.703	5/16-24	1/8			
	NL-57	90482	.625	.810	5/16-24	1/8			
	NL-58	90483	.625	.859	5/16-24	1/8			
	NL-58L	90484	.625	.890	5/16-24	1/8			
	NL-66	90485	.750	.703	3/8-24	9/64			
	NL-66L	90486	.750	.828	3/8-24	9/64			
	NL-68	90487	.750	.859	3/8-24	9/64			
	NL-68L	90488	.750	.953	3/8-24	9/64			
	NL-808	90489	1.00	.940	7-16-20	5/32			
	NL-810	90490	1.00	1.17	7-16-20	5/32			
Metric									
S535	91320	09	5	-	2.5	10			
S635	91321	12	6	-	3.0				
S840	91322	16	8	-	3.0				
S990	91323	19	10.5	-	3.0				
P0502	91324	16	16	-	-				
P0602	91325	08	15	-	-				
S311	91326	16	11	-	4.0				
Positive Lock Pins	Description	UPC #	Insert I.C.	Nominal Length	Hex Wrench Size		PKG.		
	PL-46	90495	.500	.672	3/32		10		
	PL-58	90496	.625	.859	1/8				
	PL-68	90497	.750	.859	9/64				
Finger Clamp Screws	Description	UPC #	A	B	C	Thread Size	Hex Wrench Size	PKG.	
	XNS-26	90900	0.750	.31	.31	8-32	5/64	10	
	XNS-35	90901	0.625	.22	.22	10-32	3/32		
	XNS-36	90902	0.750	.25	.25	10-32	3/32		
	XNS-37	90903	0.840	.31	.31	10-32	3/32		
	XNS-38	90904	1.000	.37	.37	10-32	3/32		
	XNS-46	90905	0.750	.31	.31	1/4-28	1/8		
	XNS-47	90906	0.875	.28	.28	1/4-28	1/8		
	XNS-48	90907	1.000	.37	.37	1/4-28	1/8		
	XNS-58	90910	1.000	.50	.28	5/16-24	5/32		
	XNS-59	90911	1.125	.47	.41	5/16-24	5/32		
	XNS-510	90908	1.250	.50	.50	5/16-24	5/32		
	XNS-610	90912	1.250	.50	.50	3/8-24	3/16		
Profiling Clamp Pin and Spring	Description	UPC #	Clamp Pin					PKG.	
	SC510	91330						10	
	M428	91331						10	

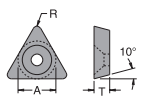
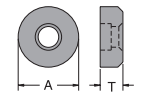
Wedge Lock Clamps / Profiling Clamps	Description	UPC #	Wedge Lock Clamp		PKG.		
	C6016N	91332			10		
	C8008N	91333					
	SKN16R	91334			10		
	SKN16L	91335					
Wedge Clamp Screws	Description	UPC #	Length	Thread	Hex Wrench Size	PKG.	
	V6016	91336	23	M5	2.5	10	
	V8008N	91337	23	M6	3.0	10	
Bridge Clamps	Description	UPC #	L	D	H	PKG.	
	HC-7	90915	.469	.313	.172	10	
	HC-9	90917	.625	.375	.203		
	HC-12	90919	.812	.500	.266		
Bridge Clamp Screws	Description	UPC #	Length	Thread	Hex Wrench Size	PKG.	
	SHC-7	90920	.375	8-32	3-32	10	
	CS-94	90921	.580	10-32	1/8		
	CS-96	90923	.840	10-32	1/8		
	CS-126	90925	.860	1/4-28	5/32		
Bridge Clamp Screw Clip	Description	UPC #	Length	PKG.			
	CLP-9	90928	.312	10			
	CLP-12	90930	.422				
Lever Locks	Description	UPC #	PKG.				
	LV01	91338	10				
	LV02	91339					
	LV05	91340					
	LV06	91341					
	LV09	91342					
Lever Screws	Description	UPC #	Lever	Hex Wrench Size	PKG.		
	V0601	91344	LV01	3.0	10		
	V0802	91345	LV02	3.0			
	V0805	91346	LV05	3.0			
	V1006	91347	LV06	4.0			
	V1209	91348	LV09	4.0			
	Positive Insert Torx Screw	Description	UPC #	I.C.		Torx Key	PKG.
	TS-06	91306	0.156	T-6	10		
	TS-103-4M1	90956	0.500	T-20			
	TS-18.35-1.5M1	91305	0.188	T-6			
	TS-18.35-1M1	91304	0.156	T-6			
	TS-25.45-6M2	90972	0.250	T-8			
	TS-25.45-8M2	90974	0.250	T-8			
	TS-3.5-7M1	90971	0.315	T-8			
	TS-35.6-9M1	90973	0.394	T-15			
	TS-4.7-10M1	90982	0.375	T-15			
	TS-4.7-8M1	90976	0.375	T-15			
	TS-44-3-M	90937	0.375	T-10			
	TS-44-4-M	90939	0.375	T-10			
	TS-5.8-10M1	90986	0.500	T-20			
	TS-83-4M1	90950	0.500	T-20			
	Seat Screw	Description	UPC #	I.C.		Hex Wrench Size	PKG.
	TS-4	90931	.375 or .500	T-10	10		
	TS-6	90944	.500 or .750	T-20			
	TS-10	90955	.625	T-25			
	Description	UPC #	I.C.	Thread	Hex Wrench Size	PKG.	
	S-34	91295	.375	10-32	5/64	10	
	S-46	91296	.500	1/4-28	3/32		
	S-58	91297	.625	5/16-24	1/8		
	S-68	91298	.750	3/8-24	9/64		
	SM-M3	53318	.375	M3	2.5		
	SM-M3-T	53302	.375	M3	2.5		
	SM-M4-245	53311	.375	M4	2.5		
SM-M4	53319	.500	M4	2.5			
SM-M6	53320	.625	M6	4.0			
Metric							
V83006	91327	16	M-3	2.5	10		
B0509	91328	11-16	M-5	3.5			
B0609	91329	12	M-6	4.0			
Torx Keys	Description	UPC #	Description	UPC #			
	T-6	92001	T-15	92006			
	T-7	92002	T-20	92007			
	T-8	92003	T-25	92008			
	T-9	92004	T-30	92009			
	T-10	92005					

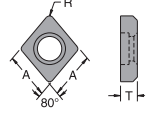
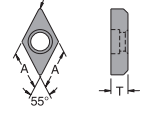
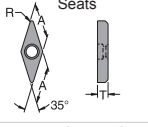
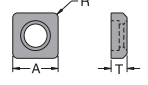
Triangle Chip breakers	Description	UPC #	Effective Width		PKG.	
			I.C.	W		
	T2AC	90446	.250	.060	10	
	T3AC	90452	.375	.060		
	T3AE	90453	.375	.090		
	T3AG	90454	.375	.125		
	T4AC	90459	.500	.060		
	T4AE	90460	.500	.090		
	T4AG	60461	.500	.125		
	T5AC	90465	.625	.100		
	T5AG	90466	.625	.140		
	T5AJ	90467	.625	.180		
	Square Chip breakers	Description	UPC #	Effective Width		PKG.
I.C.				W		
	S3BC	90440	.375	.060	10	
	S4BE	90442	.500	.060		
	S6BG	90444	.750	.125		
Positive Square Shim Seats	Description	UPC #	A	T	R	PKG.
	Inch					
	SM-40	90373	.500	.1250	.0156	10
	SM-36	90374	.750	.1250	.0469	
	Metric					
S9012P	90370	11,4	3,18	0,8	10	
Positive 80° Diamond Shim Seats	Description	UPC #	A	T	R	PKG.
	Metric					
	S8012P	53291	11,4	3,18	0,8	10
Positive 55° Diamond Shim Seats	Description	UPC #	A	T	R	PKG.
	Metric					
	S5515P	91351	8,4	3,18	0,8	10
Positive 35° Diamond Shim Seats	Description	UPC #	A	T	R	PKG.
	Metric					
	S3516P	53299	8,4	3,18	0,8	10
	S3516	91350	8,4	3,18	0,8	
Profiling Shim Seats	Description	UPC #	A	T	R	PKG.
	Metric					
	CKN16R	91353	14,5	4,76	1,0	10
	CKN16L	91354	14,5	4,76	1,0	
Positive Triangle Shim Seats	Description	UPC #	A	T	R	PKG.
	Inch					
	SM-41	90367	.332	.1250	.0156	10
	SM-37	90366	.452	.1250	.0312	
	SM-99	90371	.540	.1875	.0469	
Metric						
S6016P	91355	8,8	3,18	0,8	10	
Positive Round Shim Seats	Description	UPC #	A	T	R	PKG.
	RS-43P	90375	.500	.1875	10	
	RS-63P	90377	.750	.1875		
	RS-83P	90378	1.00	.1875		

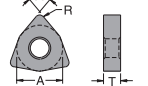
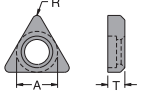
Negative 80° Diamond Seats	Description	UPC #	A	T	R	PKG.
	Inch					
	ICSN-322	90003	.375	.1250	.0312	10
	ICSN-332	90007	.375	.1875	.0312	
	ICSN-422	90004	.500	.1250	.0312	
	ICSN-423	90005	.500	.1250	.0469	
	ICSN-433	90008	.500	.1875	.0469	
	ICSN-533	90010	.625	.1875	.0469	
	ICSN-633	90012	.750	.1875	.0469	
	JC-432	90111	.500	.1250	.0312	
	JC-533	90112	.625	.1875	.0469	
	Metric					
S8009N	91356	8,5	3,18	0,8	10	
S8012N	91357	11,4	3,18	1,2		
S8016N	91358	14,6	4,76	1,4		
S8019N	91359	18,0	4,76	1,6		
Negative 55° Diamond Seats	Description	UPC #	A	T	R	PKG.
	Inch					
	IDSN-322	90016	.375	.1250	.0312	10
	IDSN-423	90018	.500	.1250	.0469	
	IDSN-433	90021	.500	.1875	.0469	
	IDSN-533	90024	.625	.1875	.0469	
	IDSN-534	90025	.625	.1875	0,625	
	JD-432	90113	.500	.1875	.0312	
Metric						
S5515N	91360	11,8	3,18	1,2	10	
Negative 35° Diamond Seats	Description	UPC #	A	T	R	PKG.
	Inch					
	IVSN-322	90065	.375	.1250	.0312	10
	IVSN-324	90066	.375	.1250	.0625	
	IVSN-433	90068	.500	.1875	.0469	
	JV-322	90119	.375	.1250	.0312	
Negative Square Seats	Description	UPC #	A	T	R	PKG.
	Inch					
	ISSN-322	90050	.375	.1250	.0312	10
	ISSN-323	90051	.375	.1250	.0469	
	ISSN-333	90054	.375	.1875	.0469	
	ISSN-423	90056	.500	.1250	.0469	
	ISSN-433	90059	.500	.1875	.0469	
	ISSN-533	90060	.625	.1875	.0469	
	ISSN-633	90062	.750	.1875	.0469	
	ISSN-634	90063	.750	.1875	.0625	
	ISSN-846	90064	1.00	.2500	.0937	
	JS-432	90114	.500	.1875	.0312	
JS-533	90115	.625	.1875	.0469		
Metric						
S9012N	91361	11,4	3,8	0,8	10	
Negative Round Seats	Description	UPC #	A	T	R	PKG.
	Inch					
	IRSN-32	90030	.375	.1250	10	
	IRSN-43	90031	.500	.1875		
	IRSN-53	90032	.625	.1875		
	IRSN-63	90033	.750	.1875		
	IRSN-84	90034	1.00	.2500		
Negative 80° Trigon Seats	Description	UPC #	A	T	R	PKG.
	Inch					
	IWSN-322	90070	.375	.1250	.0312	10
	IWSN-432	90071	.500	.1875	.0312	
	IWSN-433	90072	.500	.1875	.0469	
	IWSN-533	90073	.625	.1875	.0469	
Metric						
S8008P	91362	12,5	3,18	1,0	10	
Negative Triangle Seats	Description	UPC #	A	T	R	PKG.
	Inch					
	ITSN-322	90084	.375	.1250	.0312	10
	ITSN-323	90085	.375	.1250	.0469	
	ITSN-324	90086	.375	.1250	.0625	
	ITSN-332	90087	.375	.1875	.0312	
	ITSN-333	90088	.375	.1875	.0469	
	ITSN-334	90089	.375	.1875	.0625	
	ITSN-423	90090	.500	.1250	.0469	
	ITSN-433	90093	.500	.1875	.0469	
	ITSN-434	90094	.500	.1875	.0625	
	ITSN-533	90098	.625	.1875	.0469	
	ITSN-534	90099	.625	.1875	.0625	
	ITSN-633	90105	.750	.1875	.0469	
	ITSN-636	90106	.750	.1875	.0937	
JT-322	90117	.375	.1250	.0312		
JT-433	90116	.500	.1875	.0469		
Metric						
S6016P	91363	8,4	3,18	0,8	10	

Jet-Stream™

Changing the way metal is cut!



DOUBLE-JET COOLANT SYSTEM Turning-Boring-Threading

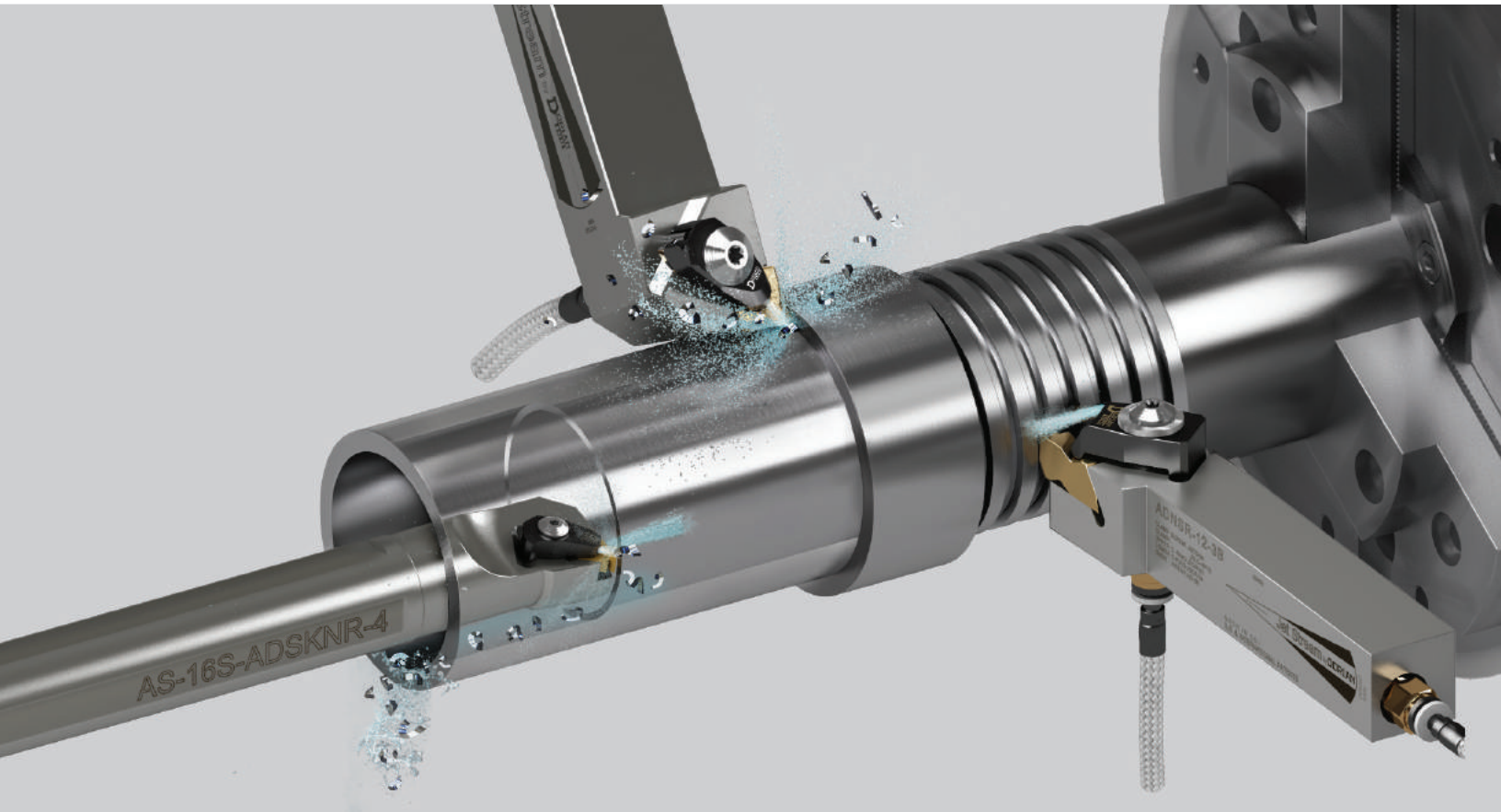

On Target at the Cutting Edge

- Performance
- Quality
- Surface finish
- Insert life
- Chip control

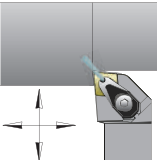

ADCLN R/L Toolholder Style L - 5° end or side cutting lead angle for negative 80° diamond CNM_ inserts

Turning	Description	UPC #		Shank		CNM_ Gage Insert	Seat	Seat Screw	Dor-Lock Clamp	Clamp Screw	Bottom Port Nozzle
		Right Hand	Left Hand	Height	Length						
	ADCLNR/L-12-4B	53000	53001	0.75	4.50	432	JC-432	SM-M4-6	JSLC-HPCTW-4N	JSCS-04	JSBP-M4-039
	ADCLNR/L-16-4D	53002	53003	1.00	6.00	432	JC-432	SM-M4-8	JSLC-HPCTW-4N	JSCS-04	JSBP-M4-039
	ADCLNR/L-20-4D	53004	53005	1.25	6.00	432	JC-432	SM-S4	JSLC-HPCTW-4N	JSCS-04	JSBPE-M4-039
	ADCLNR/L-20-5D	53006	53007	1.25	6.00	543	JC-533	SM-M6	JSLC-HPC5	JSCS-04	JSBPE-M4-039
	ADCLNR/L-20-6E	53012	-	1.25	7.00	643	JC-633	SM-M6	JSLC-HPC6	JSCS-06	JSBPE-M4-039
	ADCLNR/L-24-4E	53008	53009	1.50	7.00	432	JC-432	SM-S4	JSLC-HPCTW-4N	JSCS-04	JSBPE-M4-039
	ADCLNR/L-24-5E	53010	53011	1.50	7.00	543	JC-533	SM-M6	JSLC-HPC5	JSCS-04	JSBPE-M4-039
	ADCLNR/L-24-6E	53014	53015	1.50	7.00	643	JC-633	SM-M6	JSLC-HPC6	JSCS-06	JSBPE-M4-039

ADDJN R/L Toolholder Style J - 3° side cutting lead angle for negative 55° diamond DNM_ inserts

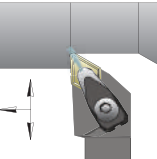
Turning	Description	UPC #		Shank		DNM_ Gage Insert	Seat	Seat Screw	Dor-Lock Clamp	Clamp Screw	Bottom Port Nozzle
		Right Hand	Left Hand	Height	Length						
	ADDJNR/L-12-3B	53016	53017	0.75	4.50	332	IDSN-322	SM-M4-245	JSLC-HPD3	JSCS-04	JSBP-M4-039
	ADDJNR/L-12-4B	53018	53019	0.75	4.50	432	JD-432	SM-M4-6	JSLC-HPD4	JSCS-04	JSBP-M4-039
	ADDJNR/L-16-4D	53020	53021	1.00	6.00	432	JD-432	SM-M4-8	JSLC-HPD4	JSCS-04	JSBPE-M4-039
	ADDJNR/L-20-4D	53022	53023	1.25	6.00	432	JD-432	SM-S4	JSLC-HPD4	JSCS-04	JSBPE-M4-039
	ADDJNR/L-24-4E	53024	53025	1.50	7.00	432	JD-432	SM-S4	JSLC-HPD4	JSCS-04	JSBPE-M4-039

ADDPNN Toolholder Style P - 27.5° side cutting lead angle for negative 55° diamond DNM_ inserts

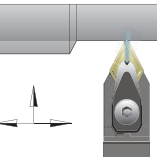
Turning	Description	UPC # Neutral	Shank		DNM_ Gage Insert	Seat	Seat Screw	Dor-Lock Clamp	Clamp Screw	Bottom Port Nozzle
			Height	Length						
	ADDPNN-12-3B	53030	0.75	4.50	332	S5511P	SM-M3	JSLC-HPD3	JSCS-04	JSBP-M4-039
	ADDPNN-12-4B	53031	0.75	4.50	432	JD-432	SM-M4	JSLC-HPD4	JSCS-04	JSBP-M4-039
	ADDPNN-16-3D	53032	1.00	6.00	332	S5511P	SM-M3	JSLC-HPD3	JSCS-04	JSBPE-M4-039
	ADDPNN-16-4D	53033	1.00	6.00	432	JD-432	SM-M4	JSLC-HPD4	JSCS-04	JSBPE-M4-039
	ADDPNN-20-4D	53034	1.25	6.00	432	JD-432	SM-M4	JSLC-HPD4	JSCS-04	JSBPE-M4-039
	ADDPNN-24-4E	53035	1.50	7.00	432	JD-432	SM-M4	JSLC-HPD4	JSCS-04	JSBPE-M4-039

ADSDNN Toolholder Style D - 45° side cutting lead angle for negative square SNM_ inserts

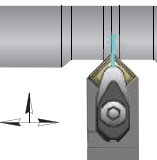
Turning	Description	UPC # Neutral	Shank		SNM_ Gage Insert	Seat	Seat Screw	Dor-Lock Clamp	Clamp Screw	Bottom Port Nozzle
			Height	Length						
	ADSDNN-12-4B	53053	0.75	4.50	432	S9012P	SM-M4	JSLC-HPCTW-4N	JSCS-04	JSBP-M4-039
	ADSDNN-16-4D	53054	1.00	6.00	432	S9012P	SM-M4	JSLC-HPCTW-4N	JSCS-04	JSBPE-M4-039
	ADSDNN-20-4D	53055	1.25	6.00	432	S9012P	SM-M4	JSLC-HPCTW-4N	JSCS-04	JSBPE-M4-039
	ADSDNN-20-5D	53056	1.25	6.00	543	JS-533	SM-M6	JSLC-HPC5	JSCS-04	JSBPE-M4-039
	ADSDNN-24-5E	53058	1.50	7.00	543	JS-533	SM-M6	JSLC-HPC5	JSCS-04	JSBPE-M4-039

ADSRN R/L Toolholder Style R - 15° side cutting lead angle for negative square SNM_ inserts

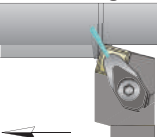
Turning	Description	UPC #		Shank		SNM_ Gage Insert	Seat	Seat Screw	Dor-Lock Clamp	Clamp Screw	Bottom Port Nozzle
		Right Hand	Left Hand	Height	Length						
	ADSRNR/L-12-4B	53040	53041	0.75	4.50	432	S9012P	SM-M4	JSLC-HPCTW-4N	JSCS-04	JSBP-M4-039
	ADSRNR/L-16-4D	53043	53044	1.00	6.00	432	S9012P	SM-M4	JSLC-HPCTW-4N	JSCS-04	JSBPE-M4-039
	ADSRNR/L-20-5D	53045	53046	1.25	6.00	543	JS533	SM-M6	JSLC-HPC5	JSCS-04	JSBPE-M4-039
	ADSRNR/L-24-5E	53047	53048	1.50	7.00	543	JS533	SM-M6	JSLC-HPC5	JSCS-04	JSBPE-M4-039

ADTENN Toolholder Style E - 30° side cutting lead angle for negative triangle TNM_ inserts

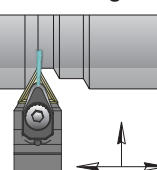
Turning	Description	UPC # Neutral	Shank		TNM_ Gage Insert	Seat	Seat Screw	Dor-Lock Clamp	Clamp Screw	Bottom Port Nozzle
			Height	Length						
	ADTENN-12-3B	53075	0.75	4.50	332	JT-322	SM-M3-T	JSLC-HPTW3N	JSCS-04	JSBP-M4-039
	ADTENN-12-4B	53076	0.75	4.50	432	JT-433	SM-S4	JSLC-HPCTW-4N	JSCS-04	JSBP-M4-039
	ADTENN-16-3D	53077	1.00	6.00	332	JT-322	SM-M3-T	JSLC-HPTW3N	JSCS-04	JSBP-M4-039
	ADTENN-16-4D	53078	1.00	6.00	432	JT-433	SM-S4	JSLC-HPCTW-4N	JSCS-04	JSBP-M4-039
	ADTENN-20-4D	53079	1.25	6.00	432	JT-433	SM-S4	JSLC-HPCTW-4N	JSCS-04	JSBPE-M4-039
	ADTENN-24-4E	53080	1.50	7.00	432	JT-433	SM-S4	JSLC-HPCTW-4N	JSCS-04	JSBPE-M4-039

ADTJN R/L Toolholder Style J - 3° side cutting lead angle for negative triangle TNM_ inserts

Turning	Description	UPC #		Shank		TNM_ Gage Insert	Seat	Seat Screw	Dor-Lock Clamp	Clamp Screw	Bottom Port Nozzle
		Right Hand	Left Hand	Height	Length						
	ADTJNR/L-12-3B	53063	53064	0.75	4.50	332	JT-322	SM-M3-T	JSLC-HPTW3N	JSCS-04	JSBP-M4-039
	ADTJNR/L-12-4B	53065	53066	0.75	4.50	432	JT-433	SM-M4-8	JSLC-HPCTW-4N	JSCS-04	JSBP-M4-039
	ADTJNR/L-16-3D	53067	53068	1.00	6.00	332	JT-322	SM-M3-T	JSLC-HPTW3N	JSCS-04	JSBP-M4-039
	ADTJNR/L-16-4D	53069	53070	1.00	6.00	432	JT-433	SM-S4	JSLC-HPCTW-4N	JSCS-04	JSBP-M4-039
	ADTJNR/L-20-4D	53071	53072	1.25	6.00	432	JT-433	SM-S4	JSLC-HPCTW-4N	JSCS-04	JSBP-M4-039
	ADTJNR/L-24-4E	53073	53074	1.50	7.00	432	JT-433	SM-S4	JSLC-HPCTW-4N	JSCS-04	JSBP-M4-039

ADVJN R/L Toolholder Style J - Negative 3° side cutting lead angle for negative 35° diamond VNM_ inserts

Turning	Description	UPC #		Shank		VNM_ Gage Insert	Seat	Seat Screw	Dor-Lock Clamp	Clamp Screw	Nozzle
		Right Hand	Left Hand	Height	Length						
	ADVJNR/L-12-3B	53081	53082	0.75	4.50	332	JV-322	SM-M3	JSLC-HPV3	JSCS-04	JSBP-M4-039
	ADVJNR/L-16-3D	53083	53084	1.00	6.00	332	JV-322	SM-M3	JSLC-HPV3	JSCS-04	JSBP-M4-039
	ADVJNR/L-20-3D	53085	53086	1.25	6.00	332	JV-322	SM-M3	JSLC-HPV3	JSCS-04	JSBP-M4-039
	ADVJNR/L-24-3E	53087	53088	1.50	7.00	332	JV-322	SM-M3	JSLC-HPV3	JSCS-04	JSBP-M4-039

ADWLN R/L Toolholder Style L - Negative 5° end or side cutting lead angle for negative 80° trigon WNM_ inserts

Turning	Description	UPC #		Shank		WNM_ Gage Insert	Seat	Seat Screw	Dor-Lock Clamp	Clamp Screw	Bottom Port Nozzle
		Right Hand	Left Hand	Height	Length						
	ADWLN/R/L-12-3B	53093	53094	0.75	4.50	332	IWSN-322	SM-M4-6-245	JSLC-HPTW3R/L	JSCS-04	JSBP-M4-039
	ADWLN/R/L-12-4B	53095	53096	0.75	4.50	432	IWSN-423	SM-M4-6	JSLC-HPTW4R/L	JSCS-04	JSBP-M4-039
	ADWLN/R/L-16-3D	53097	53098	1.00	6.00	332	IWSN-322	SM-M4-6-245	JSLC-HPTW3R/L	JSCS-04	JSBP-M4-039
	ADWLN/R/L-16-4D	53099	53100	1.00	6.00	432	IWSN-433	SM-M4-8	JSLC-HPTW4R/L	JSCS-04	JSBP-M4-039
	ADWLN/R/L-20-4D	53101	53102	1.25	6.00	432	IWSN-423	SM-M4-8	JSLC-HPTW4R/L	JSCS-04	JSBP-M4-039
	ADWLN/R/L-24-4E	53103	53104	1.50	7.00	432	IWSN-423	SM-M4-8	JSLC-HPTW4R/L	JSCS-04	JSBP-M4-039

AS-ADCLN R/L Boring Bar Style L - Negative 5° side & end cutting lead angle for negative 80° diamond CNM_ inserts

Boring	Description	UPC #		Min. Bore B	Bar Size	CNM_ Gage Insert	Seat	Seat Screw	Dor-Lock Clamp	Clamp Screw	Chip Flush Plug
		Right Hand	Left Hand								
	AS-12R-ADCLNR/L-3	53120	53121	1.000	0.75	322	N/A	N/A	JSLC-HPC3-B	JSCS-03	JSPN-M3
	AS-16R-ADCLNR/L-4	53122	53123	1.280	1.00	432	DC-432	TS-5.8-10M1	JSLC-HPCTW-4N	JSCS-04	JSPN-M6
	AS-20S-ADCLNR/L-4	53124	53125	1.530	1.25	432	DC-432	TS-5.8-10M1	JSLC-HPCTW-4N	JSCS-04	JSPN-M6
	AS-24S-ADCLNR/L-4	53126	53127	1.780	1.50	432	DC-432	TS-5.8-10M1	JSLC-HPCTW-4N	JSCS-04	JSPN-M6
	AS-32T-ADCLNR/L-4	53128	53129	2.562	2.00	432	DC-432	TS-5.8-10M1	JSLC-HPCTW-4N	JSCS-04	JSPN-M6
	AS-32T-ADCLNR/L-5	53130	53131	2.562	2.00	543	JC-533	SM-M6	JSLC-HPC5	JSCS-04	JSPN-M6

AS-ADTUN R/L Boring Bar Style U - Negative 3° end cutting lead angle for negative triangle TNM_ inserts

Boring	Description	UPC #		Min. Bore B	Bar Size	TNM_ Gage Insert	Seat	Seat Screw	Dor-Lock Clamp	Clamp Screw	Chip Flush Plug
		Right Hand	Left Hand								
	AS-12R-ADTUNR/L-3	53172	53173	1.000	0.75	322	N/A	N/A	JSLC-HPDT3-BR/L	JSCS-03	JSPN-M3
	AS-16R-ADTUNR/L-3	53174	53175	1.280	1.00	332	JT-322	SM-M3-T	JSLC-HPDT3-BR/L	JSCS-03	JSPN-M3
	AS-20S-ADTUNR/L-4	53176	53177	1.530	1.25	432	JT-433	SM-S4	JSLC-HPTW4R/L	JSCS-04	JSPN-M6
	AS-24S-ADTUNR/L-4	53178	53179	2.060	1.50	432	JT-433	SM-S4	JSLC-HPTW4R/L	JSCS-04	JSPN-M6
	AS-32T-ADTUNR/L-4	53180	53181	2.562	2.00	432	JT-433	SM-S4	JSLC-HPTW4R/L	JSCS-04	JSPN-M6

AS-ADDUN R/L Boring Bar Style U - Negative 3° end cutting lead angle for negative 55° diamond DNM_ inserts

Boring	Description	UPC #		Min. Bore B	Bar Size	DNM_ Gage Insert	Seat	Seat Screw	Dor-Lock Clamp	Clamp Screw	Chip Flush Plug
		Right Hand	Left Hand								
	AS-16R-ADDUNR/L-3	53137	53138	1.300	1.00	332	5511P	SM-M3	JSLC-HPDT3-BR/L	JSCS-03	JSPN-M3
	AS-20S-ADDUNR/L-4	53139	53140	2.000	1.25	432	DD-432	TS-5.8-10M1	JSLC-HPD4	JSCS-04	JSPN-M6
	AS-24S-ADDUNR/L-4	53141	53142	2.250	1.50	432	DD-432	TS-5.8-10M1	JSLC-HPD4	JSCS-04	JSPN-M6
	AS-32T-ADDUNR/L-4	53143	53144	3.000	2.00	432	DD-432	TS-5.8-10M1	JSLC-HPD4	JSCS-04	JSPN-M6

AS-ADDPN R/L Boring Bar Style P- Negative 27.5 end cutting lead angle for negative 55° diamond DNM_ inserts

Boring	Description	UPC #		Min. Bore B	Bar Size	DNM_ Gage Insert	Seat	Seat Screw	Dor-Lock Clamp	Clamp Screw	Chip Flush Plug
		Right Hand	Left Hand								
	AS-20S-ADDPNR/L-4	53150	53151	1.705	1.25	432	DD-432	TS-5.8-10M1	JSLC-HPD4	JSCS-04	JSPN-M6
	AS-24S-ADDPNR/L-4	53152	53153	2.000	1.50	432	DD-432	TS-5.8-10M1	JSLC-HPD4	JSCS-04	JSPN-M6

AS-ADSKN R/L Boring Bar Style K - 15° End cutting lead angle for negative square SNM_ inserts

Boring	Description	UPC #		Min. Bore B	Bar Size	SNM_ Gage Insert	Seat	Seat Screw	Dor-Lock Clamp	Clamp Screw	Chip Flush Plug
		Right Hand	Left Hand								
	AS-20S-ADSKNR/L-4	53159	53160	1.53	1.25	432	S9012P	SM-S4	JSLC-HPCTW-4N	JSCS-04	JSPN-M6
	AS-24S-ADSKNR/L-4	53161	53162	1.76	1.50	432	S9012P	SM-S4	JSLC-HPCTW-4N	JSCS-04	JSPN-M6
	AS-32T-ADSKNR/L-4	53163	-	2.400	2.00	432	S9012P	SM-S4	JSLC-HPCTW-4N	JSCS-04	JSPN-M6
	AS-32T-ADSKNR/L-5	53165	53166	2.400	2.00	543	JS-533	SM-M6	JSLC-HPC5	JSCS-04	JSPN-M6

AS-ADVUN R/L Boring Bar Style U - Negative 3° side cutting lead angle for negative 35° diamond VNM_ inserts

Boring	Description	UPC #		Min. Bore B	Bar Size	VNM_ Gage Insert	Seat	Seat Screw	Dor-Lock Clamp	Clamp Screw	Chip Flush Plug
		Right Hand	Left Hand								
	AS-20S-ADVUNR/L-3	53189	53190	2.250	1.25	332	S3516P	SM-M3	JSLC-HPV3	JSCS-04	JSPN-M6
	AS-24S-ADVUNR/L-3	53191	53192	2.500	1.50	332	S3516P	SM-M3	JSLC-HPV3	JSCS-04	JSPN-M6

AS-ADWLN R/L Boring Bar Style L - Negative 5° end & side cutting lead angle for negative 80° trigon WNM_ inserts

Boring	Description	UPC #		Min. Bore B	Bar Size	WNM_ Gage Insert	Seat	Seat Screw	Dor-Lock Clamp	Clamp Screw	Chip Flush Plug
		Right Hand	Left Hand								
	AS-12R-ADWLNRL-3	53198	53199	1.000	0.75	332	N/A	N/A	JSLC-HPW3-B	JSCS-03	JSPN-M3
	AS-16R-ADWLNRL-4	53200	53201	1.550	1.00	432	IWSN-423	SM-S4	JSLC-HPTW-4R/L	JSCS-04	JSPN-M6
	AS-20S-ADWLNRL-4	53202	53203	1.600	1.25	432	IWSN-423	SM-S4	JSLC-HPTW-4R/L	JSCS-04	JSPN-M6
	AS-24S-ADWLNRL-4	53204	53205	1.780	1.50	432	IWSN-423	SM-S4	JSLC-HPTW-4R/L	JSCS-04	JSPN-M6
	AS-32T-ADWLNRL-4	53206	53207	2.000	2.00	432	IWSN-423	SM-S4	JSLC-HPTW-4R/L	JSCS-04	JSPN-M6

ADTVO R Toolholder Style V - O.D. On Edge Threading and shallow grooving for triangle TNMC inserts

Boring	Description	UPC #		Shank		TNMC Gage Insert	Insert Torx Screw	Torx Key
		Right Hand	Left Hand	Height	Length			
	ADTVOR12-3B	53400	-	0.75	4.50	322	GTS-1M	T-10
	ADTVOR16-3D	53402	-	1.00	6.00			
	ADTVOR12-4B	53404	-	0.75	4.50			
	ADTVOR16-4D	53406	-	1.00	6.00	432	GTS-2	T-20
	ADTVOR20-4D	53408	-	1.25	6.00			
	ADTVOR/L20-5D	53414	-	1.50	7.00			

AS-ADTHO R/L Threading Bar Style H - I.D. On Edge Threading and shallow grooving for triangle TNMC inserts

Threading	Description	UPC #		Min. Bore B	Bar Size	TNMC Gage Insert	Insert Torx Screw	Torx Key	Chip Flush Plug
		Right Hand	Left Hand						
	AS-16R-ADTHOR/L-3	53436	-	1.390	1.00	322	GTS-1M	T-10	JSPN-M6
	AS-20S-ADTHOR/L-4	53438	-	1.812	1.25	432	GTS-2	T-20	JSPN-M6
	AS-32T-ADTHOR/L-4	53442	53443	3.000	2.00				

ADNSR R/L Toolholder Style S - External DorNotch toolholder for threading and grooving DorNotch inserts

Threading	Description	UPC #		Shank		Gage Insert	Seat	Seat Screw	Dor-Lock Clamp	Clamp Screw
		Right Hand	Left Hand	Height	Length					
	ADNSR/L12-3B	53450	53451	0.75	4.50	NG-3R NG-3L	N/A	N/A	JSLC-HP72 JSLC-HP73	JSCS-04
	ADNSR/L16-3D	53452	53453	1.00	6.00					
	ADNSR/L20-3D	53454	53455	1.25	6.00					
	ADNSR/L16-4D	53456	-	1.00	6.00	NG-4R NG-4L	SM-420	SL-344	JSLC-HP76 JSLC-HP77	JSCS-04
	ADNSR/L20-4D	53458	53459	1.25	6.00					
	ADNSR/L24-4E	53460	53461	1.50	7.00					

ADNE R/L Toolholder Style E- Gang external DorNotch toolholder for threading and grooving DorNotch inserts

Threading	Description	UPC #		Shank		Gage Insert	Dor-Lock Clamp	Clamp Screw
		Right Hand	Left Hand	Height	Length			
	ADNER/L12-3B	53465	53466	0.75	4.50	NG-3L NG-3R	JSLC-HP73 JSLC-HP72	JSCS-04
	ADNER/L16-3D	53467	53468	1.00	6.00			
	ADNER/L20-3D	53469	53470	1.25	6.00			
	ADNER/L16-4D	53471	53472	1.00	6.00	NG-4L NG-4R	JSLC-HP77 JSLC-HP76	JSCS-04
	ADNER/L20-4D	53473	53474	1.25	6.00			

AS-ADNE R/L Threading Bar Style E- Internal DorNotch Bar for threading and grooving DorNotch inserts

Threading	Description	UPC #		Shank		Gage Insert	Dor-Lock Clamp	Clamp Screw	Chip Flush Plug
		Right Hand	Left Hand	Height	Length				
	AS-16R-ADNER/L-3	53490	53491	1.38	1.00	NG-3L NG-3R	JSLC-HP73 JSLC-HP72	JSCS-04	JSPN-M6
	AS-20S-ADNER/L-3	53492	53493	1.75	1.25				
	AS-24S-ADNER/L-3	53494	-	2.00	1.50				
	AS-32T-ADNER/L-4	53496	53497	2.75	2.00	NG-4L NG-4R	JSLC-HP73 JSLC-HP72	JSCS-08	JSPN-M6

ADLE R/L Toolholder Style E- Laydown toolholder for Laydown inserts

Threading	Description	UPC #		Shank		Gage Insert	Seat	Insert Screw	Dor-Lock Clamp	Clamp Screw	Nozzle
		Right Hand	Left Hand	Height	Length						
	ADLER/L12-16C	53510	-	0.75	5.00	16-G60	GXE/I-16	TS-35.6-14M1	JSLC-HP16R-N JSLC-HP16L-N	JSCS-03	N/A
	ADLER/L16-16D	53512	53513	1.00	6.00	16-G60	GXE/I-16	TS-35.6-14M1		JSCS-03	JSBPE-M4-039

ADLE R/L Qualified Toolholder Style E - Offset head for Laydown inserts

Threading	Description	UPC #		Shank		Gage Insert	Seat	Insert Screw	Dor-Lock Clamp	Clamp Screw	Nozzle
		Right Hand	Left Hand	Height	Length						
	ADLER/L12-16Q-C	53522	-	0.75	5.00	16-G60	GXE/I-16	TS-35.6-14M1	JSLC-HP16R-N JSLC-HP16L-N	JSCS-03	N/A
	ADLER/L16-16Q-D	53524	53525	1.00	6.00	16-G60	GXE/I-16	TS-35.6-14M1		JSCS-03	JSBPE-M4-039
	ADLER/L16-22Q-D	53528	-	1.00	6.00	22-N60	NXE/I-16	TS-45.75-15M1	JSLC-HP22N	JSCS-04	JSBPE-M4-039
	ADLER/L20-22Q-E	53530	-	1.25	6.00						

AS-ADLN R/L Threading Bar Style N - Internal Laydown bar for Laydown threading

Threading	Description	UPC #		Min. Bore B	Bar Size D	Gage Insert	Seat	Insert Screw	Dor-Lock Clamp	Clamp Screw	Chip Flush Plug
		Right Hand	Left Hand								
	AS-12R-ADLNR/L-16	53533	53534	1.12	0.75	16-G60	GXE/I-16	TS-35.6-14M1	JSLC-HP16R-N JSLC-HP16L-N	JSCS-03	JSPN-M3
	AS-16R-ADLNR/L-16	53535	53536	1.37	1.00						
	AS-20S-ADLNR/L-16	53537	53538	1.62	1.25						
	AS-24S-ADLNR/L-16	53539	53540	1.87	1.50						
	AS-24S-ADLNR/L-22	53543	-	2.00	1.50	22-N60	GXE/I-16	TS-45.75-15M1	JSLC-HP22N	JSCS-04	JSPN-M6
	AS-32T-ADLNR/L-22	53545	53546	2.50	2.00						

AS-ADLN R/L API Threading Bar Style N- Internal Laydown API Laydown toolholder for API Laydown inserts

Threading	Description	UPC #		Min. Bore B	D	Gage Insert	Seat	Insert Screw	Dor-Lock Clamp	Clamp Screw	Chip Flush Plug
		Right Hand	Left Hand								
	AS-32T-ADLNR/L-22API	53559	53560	1.60	2.00	22-N60	NXE/I-22	TS-45.75-15M1	JSLC-HP22N	JSCS-04	JSPN-M6

Standard Pressure Coolant Connection 3 Pcs. Kit

Working Pressure

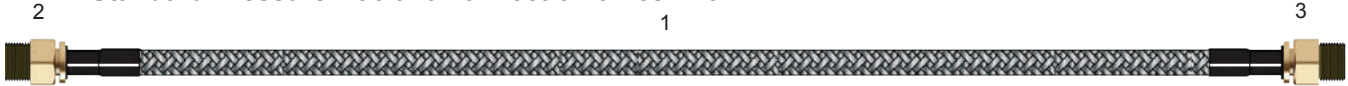

up to 400 psi (30 bar)

Item	Part #	UPC #	Description	Bar	PSI
1/16" NPT Standard Pressure Quick Release Coolant 3 pcs Kit					
1	JSPLPCK-062-250	53303	1/16" NPT Standard Pressure Quick Release Coolant 3 pcs Kit	30	400
1	JS-T250-1200	53349	1/4" OD, 30cm Long Standard Pressure Tubing		
2	JS-MC062-250	53346	1/16" NPT-1/4" Bore, Straight Std Pressure Quick Release Connector		
3	JS-MC125-250	53347	1/8" NPT-1/4" Bore, Straight Std Pressure Quick Release Connector		
1/8" NPT Standard Pressure Quick Release Coolant 3 pcs Kit					
1	JSPLPCK-125-250	53304	1/8" NPT Standard Pressure Quick Release Coolant 3 pcs Kit	30	400
1	JS-T250-1200	53349	1/4" OD, 30cm Long Standard Pressure Tubing		
2	JS-MC125-250	53347	1/8" NPT-1/4" Bore, Straight Std Pressure Quick Release Connector		
3	JS-MC125-250	53347	1/8" NPT-1/4" Bore, Straight Std Pressure Quick Release Connector		
1/4" NPT Standard Pressure Quick Release Coolant 3 pcs Kit					
1	JSPLPCK-250-250	53305	1/4" NPT Standard Pressure Quick Release Coolant 3 pcs Kit	30	400
1	JS-T250-1200	53349	1/4" OD, 30cm Long Standard Pressure Tubing		
2	JS-MC125-250	53347	1/8" NPT-1/4" Bore, Straight Std Pressure Quick Release Connector		
3	JS-MC250-250	53348	1/4" NPT-1/4" Bore, Straight Std Pressure Quick Release Connector		

High Pressure Coolant Connection 5 Pcs. Kit

Working Pressure



over 400 psi (30 bar)

Item	Part #	UPC #	Description	Bar	PSI
1/8" NPT High Pressure Quick Release Coolant 5 pcs Kit					
1	DT-1/8 HP-QRCK	60473	1/8" NPT High Pressure Quick Release Coolant 5 pcs Kit	200	2800
1	DT-HPTU-8X4	60477	8mm High Pressure Coolant Tubing		
2	DT-HPC0-6X8	60479	High Pressure Quick Release Straight Intake		
3	DT-HPC0-6X8	60479	High Pressure Quick Release Straight Intake		
4	DT-HP0SC-1/8X6	60490	1/8" NPT Straight High Pressure Quick Release Connector		
5	DT-HP90C-1/8X6	60489	1/8" NPT 90° Elbow High Pressure Quick Release Connector		
1/4" NPT High Pressure Quick Release Coolant 5 pcs Kit					
1	DT-1/4 HP-QRCK	60474	1/4" NPT High Pressure Quick Release Coolant 5 pcs Kit	200	2800
1	DT-HPTU-8X4	60477	8mm High Pressure Coolant Tubing		
2	DT-HPC0-6X8	60479	High Pressure Quick Release Straight Intake		
3	DT-HPC0-6X8	60479	High Pressure Quick Release Straight Intake		
4	DT-HP0SC-1/4X6	60478	1/4" NPT Straight High Pressure Quick Release Connector		
5	DT-HP90C-1/8X6	60489	1/8" NPT 90° Elbow High Pressure Quick Release Connector		

Item	Part #	UPC #	Description
	DT-HP-PLIERS	60476	High Pressure Disconnecting Pliers

To Disconnect the Coolant Hose Follow 2 Safe & Easy Steps:

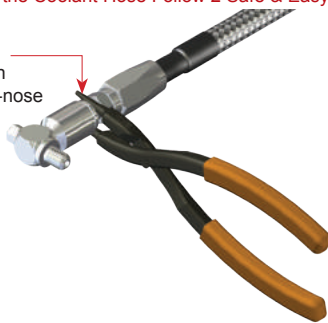

1. Place the thinner section of the wrench-nose between the coolant hose and the connector.

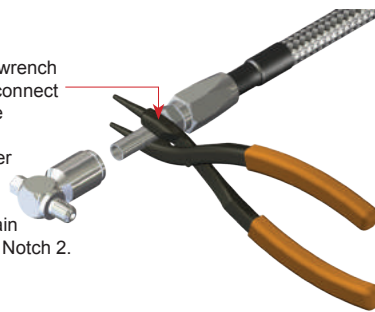

2. Close the wrench and it will disconnect Notch 1 of the coolant hose. Use the thicker section of the wrench-nose and close again to disconnect Notch 2.



Ball-Type Coolant Nozzles Sold Separately

Acetal Material	Brass Material	Ball-Type Coolant Nozzles Size	Acetal (Hard Plastic) Material		Brass Material	
			Description	UPC #	Description	UPC #
		12mm OD, 1/8NPT ID	JSCNA-12	53354	JSCNB-12	53365
		14mm OD, 1/8NPT ID	JSCNA-14	53355	JSCNB-14	53366
		15mm OD, 1/8NPT ID	JSCNA-15	53356	JSCNB-15	53367
		22mm OD, 1/8NPT ID	JSCNA-22	53357	JSCNB-22	53368
		1/2" OD, 1/8NPT ID	JSCNA-50	53358	JSCNB-50	53369
		5/8" OD, 1/8NPT ID	JSCNA-62	53359	JSCNB-62	53370

Note: For machines that have turrets with 1/8 NPT tapped coolant holes, you do not need a ball type coolant nozzle. Ball type coolant nozzles are sold separately.

Jet-Stream™ Thru Coolant System Spare Parts

Image	Description	UPC #
-------	-------------	-------

Dor-Lock Clamps for Laydown Threading holders

60° PARTIAL PROFILE INSERT STYLE 	JSLC-HP16R-N	53242
	JSLC-HP16L-N	53243
	JSLC-HP22N	53232
	JSLC-HP27N	53234

Includes upper and lower o-rings

Dor-Lock Clamps for DorNotch Threading holders

NT & NTP 60° INSERT STYLE 	JSLC-HP72	53350
	JSLC-HP73	53351
	JSLC-HP76	53352
	JSLC-HP77	53353



Includes upper and lower o-rings

Dor-Lock Clamps for CNMG & SNMG holders

CNMG & SNMG INSERT STYLES 	JSLC-HPC3-B	53250
	JSLC-HPCTW-4N	53289
	JSLC-HPC5	53252
	JSLC-HPC6	53248

Includes upper and lower o-rings

Dor-Lock Clamps for DNMG & TNMG holders

DNMG INSERT STYLES 	JSLC-HPD3	53253
	JSLC-HPD4	53254
TNMG INSERT STYLES 	JSLC-HPDT3-BR	53268
	JSLC-HPDT3-BL	53269

Includes upper and lower o-rings

Dor-Lock Clamps for TNMG & WNMG holders

TNMG & WNMG INSERT STYLES 	JSLC-HPTW3N	53261
	JSLC-HPTW3R	53262
	JSLC-HPTW3L	53263
	JSLC-HPCTW-4N	53289
	JSLC-HPTW4R	53265
	JSLC-HPTW4L	53266
JSLC-HPW3-B	53270	

Includes upper and lower o-rings

Dor-Lock Clamps for VNMG holders

VNMG INSERT STYLE 	JSLC-HPV3	53267
---	-----------	-------

Includes upper and lower o-rings







NEW High Volume Turning Dor-Lock Clamp

CNMG / TNMG / WNMG INSERT STYLES 	JSLC-HPCTW-4N-HPV	53290
--	-------------------	-------

Includes upper and lower o-rings

Image	Description	UPC #
-------	-------------	-------

Jet-Stream™ Shim Seats

80° DIAMOND 	JC-432	90111
	JC-533	90112
	JC-633	90118
55° DIAMOND 	JD-432	90113
	IDSN-423	90118
35° DIAMOND 	IDSN-322	90016
	JV-322	90119
SQUARE 	JS-432	90114
	JS-533	90115
	ISSN-423	90056
TRIANGLE 	JT-322	90117
	JT-433	90116
TRIGON 	IWSN-322	90070
	IWSN-423	90074
	IWSN-433	90072
LAYDOWN SHIM SEAT 	GXE/I-16	92070
	NXE/I-22	92071
	VXE/I-27	92074
DORNOTCH SHIM SEAT 	SM-420	90400

Insert Torx Screws/ Shim Screws





INSERT SCREWS 	GTS-1M	90964
	GTS-2	90966
	GTS-3	90967
	TS-35.6-9M1	90973
	TS-35.6-14M1	91303
	TS-45.75-15M1	91319
	TS-5.8-22M1	91302
	SL-344	91008
	SM-M3	53318
	SM-M3-T	53302
SHIM SCREWS 	SM-M6	53320
	SM-M66	53317
	SM-S4	53316
	SM-M4-245	53311
	SM-M4-6	53224
	SM-M4-8	53227
	SM-M4-6-245	53228

Image	Description	UPC #
-------	-------------	-------

Jet-Stream™ Clamp Screws

CLAMP SCREWS 	JSCS-03	53323
	JSCS-04	53324
	JSCS-06	53326
	JSCS-04-HPV	53321

Jet-Stream™ Clamp O-Ring Seals

UPPER "O" RINGS 	JSOR-01	53315
	JSOR-03	53328
LOWER "O" RINGS 	JSOR-04	53314
	JSOR-06	53330
	JSOR-07	53327
	JSOR-08	53329
	JSOR-202	53335

Jet-Stream™ Flush Nozzle/Plug

BORING BAR CHIP FLUSH PLUG 	JSPN-M3	53339
	JSPN-M6	53334
	JSFN-M6	53313

Torx Keys

TORX KEYS 	T-10	92005
	T-20	92007

Jet-Stream™ Clamp Alignment Pin

ALIGNMENT PIN 	JSCAP-01	53325
---	----------	-------

Jet-Stream™ Underport Nozzle

Underport Nozzle 	JSBP-M4-039	53244
	JSB PE-M4-039	53246

Jet-Stream™ Underport Seal

UNDERPORT SEAL 	JSBPS-M4-039	53245
--	--------------	-------

CARBIDE BORING BARS

Thru Coolant - High Performance



Ultimate rigidity
Minimize vibrations
Heavy duty roughing
Very fine finishing
Better surface finish

6xD Boring Ratio (8xD for softer materials)

Superior surface finish compared to steel boring bars

All Thru Coolant Bars (Negative Insert boring bars are Jet-Stream)

1/2" and above sizes have threaded ends for coolant connector

E_SCLD R/L Thru Coolant Integral Carbide Boring Bar Style L - Negative 5° End & Side Cutting Edge Angle for 15° positive 80° diamond CD__ inserts

Bar Description	UPC #			Boring Ratio	Dia.	Min. Bore	Length	CD__ Gage Insert
	Right Hand	Left Hand						
E02.5H-SCLDR/L-1.2	59575	59576		6:1	0.156	0.175	4.00	1.20.60.2
E03.0H-SCLDR/L-1.2	59579	59580			0.187	0.205	4.00	1.20.60.2
E03.5H-SCLDR/L-1.2	59583	59584			0.218	0.245	4.00	
E04H-SCLDR/L-1.5	59587	59588			0.250	0.270	4.00	1.510.5
E05K-SCLDR/L-1.5	59591	59592			0.312	0.335	5.00	

Inserts used: all CD__ series (CDGX, DCMT, CDGW, CDGB).

E_SCLC R/L Thru Coolant Integral Carbide Boring Bar Style L - Negative 5° End & Side Cutting Edge Angle for 7° positive 80° diamond CC__ inserts

Bar Description	UPC #			Boring Ratio	Dia.	Min. Bore	Length	CC__ Gage Insert
	Right Hand	Left Hand						
E06M-SCLCR/L-2	59595	59596		6:1	0.375	0.396	6.00	21.51
E08K-SCLCR/L-2	59599	59600			0.500	0.550	5.00	
E08R-SCLCR/L-2	59603	59604			0.500	0.550	8.00	
E10M-SCLCR/L-2	59607	59608			0.625	0.740	6.00	
E10S-SCLCR/L-2	59611	59612			0.625	0.740	10.00	
E08K-SCLCR/L-3	59615	59616			0.500	0.550	5.00	32.52
E08R-SCLCR/L-3	59619	59620			0.500	0.550	8.00	
E10M-SCLCR/L-3	59623	59624			0.625	0.740	6.00	
E10S-SCLCR/L-3	59627	59628			0.625	0.740	10.00	
E12Q-SCLCR/L-3	59967	59968			0.750	0.930	7.000	
E12S-SCLCR/L-3	59969	59970		0.750	0.930	10.00	32.52	
E16R-SCLCR/L-3	59971	59972		1.000	1.200	8.000		
E16T-SCLCR/L-3	59973	59974		1.000	1.200	12.00		
E20U-SCLCR/L-4	59975	59976		1.250	1.470	14.00		432

Inserts used: all CC__ series (CCGX, CCGT, CCMT, CCGW).

E_SCLP R/L Thru Coolant Integral Carbide Boring Bar Style L - Negative 5° End & Side Cutting Edge Angle for 11° positive 80° diamond CP__ inserts

Bar Description	UPC #			Boring Ratio	Dia.	Min. Bore	Length	CP__ Gage Insert
	Right Hand	Left Hand						
E05K-SCLPR/L-1.8	59631	59632		6:1	0.312	0.335	5.00	1.81.20.5
E06M-SCLPR/L-2	59635	59636			0.375	0.396	6.00	21.51
E08K-SCLPR/L-2	59639	59640			0.500	0.550	5.00	
E08R-SCLPR/L-2	59643	59644			0.500	0.550	8.00	
E10M-SCLPR/L-2	59647	59648			0.625	0.740	6.00	
E10S-SCLPR/L-2	59651	59652			0.625	0.740	10.00	
E08K-SCLPR/L-3	59655	59656			0.500	0.550	5.00	32.52
E08R-SCLPR/L-3	59659	59660			0.500	0.550	8.00	
E10M-SCLPR/L-3	59663	59664			0.625	0.740	6.00	
E10S-SCLPR/L-3	59667	59668			0.625	0.740	10.00	

Inserts used: all CP__ series (CPGX, CPGT, CPGW, CPMT).

E_SDNC R/L Thru Coolant Integral Carbide Boring Bar Style N - Negative 27.5° End & Side Cutting Edge Angle for 7° positive 55° diamond DC__ inserts

Bar Description	UPC #			Boring Ratio	Dia.	Min. Bore	Length	DC__ Gage Insert
	Right Hand	Left Hand						
E06M-SDNCR/L-2	59671	59672		6:1	0.375	0.581	6.00	21.51
E08K-SDNCR/L-2	59675	59676			0.500	0.775	5.00	
E08R-SDNCR/L-2	59679	59680			0.500	0.775	8.00	
E10M-SDNCR/L-2	59683	59684			0.625	0.969	6.00	
E10S-SDNCR/L-2	59687	59688			0.625	0.969	10.00	

Inserts used: all DC__ series (DCMT, DCGW, DCMT, DCGX, DCGT).

E_SDQC R/L Thru Coolant Integral Carbide Boring Bar Style Q - Negative 17.5° End Cutting Edge Angle for 7° positive 55° diamond DC__ inserts

Bar Description	UPC #			Boring Ratio	Dia.	Min. Bore	Length	DC__ Gage Insert
	Right Hand	Left Hand						
E06M-SDQCR/L-2	59691	59692		6:1	0.375	0.487	6.00	21.51
E08K-SDQCR/L-2	59695	59696			0.500	0.650	5.00	
E08R-SDQCR/L-2	59699	59700			0.500	0.650	8.00	
E10M-SDQCR/L-2	59703	59704			0.625	0.781	6.00	
E10S-SDQCR/L-2	59707	59708			0.625	0.781	10.00	

Inserts used: all DC__ series (DCMT, DCGW, DCMT, DCGX, DCGT).

E_SDUC R/L Thru Coolant Integral Carbide Boring Bar Style U - Negative 3° End Cutting Edge Angle for 7° positive 55° diamond DC__ inserts

Bar Description	UPC #			Boring Ratio	Dia.	Min. Bore	Length	DC__ Gage Insert
	Right Hand	Left Hand						
E06M-SDUCR/L-2	59711	59712		6:1	0.375	0.581	6.00	21.51
E08K-SDUCR/L-2	59715	59716			0.500	0.712	5.00	
E08R-SDUCR/L-2	59719	59720			0.500	0.712	8.00	
E10M-SDUCR/L-2	59723	59724			0.625	0.844	6.00	
E10S-SDUCR/L-2	59727	59728			0.625	0.844	10.00	
E12Q-SDUCR/L-3	59987	59988			0.750	1.050	7.000	32.52
E12S-SDUCR/L-3	59989	59990			0.750	1.050	10.00	
E16R-SDUCR/L-3	59991	59992			1.000	1.300	8.000	
E16T-SDUCR/L-3	59993	59994			1.000	1.300	12.00	
E20U-SDUCR/L-3	59995	59996			1.250	1.750	14.00	

Inserts used: all DC__ series (DCMT, DCGW, DCMT, DCGX, DCGT).

E_SDXC R/L Thru Coolant Integral Carbide Boring Bar Style X - Negative 5° Back Boring Cutting Edge Angle for 7° positive 55° diamond DC__ inserts

Bar Description	UPC #			Boring Ratio	Dia.	Min. Bore	Length	DC__ Gage Insert
	Right Hand	Left Hand						
E06M-SDXCR/L-2	59731	59732		6:1	0.375	0.581	5.66	21.51
E08K-SDXCR/L-2	59735	59736			0.500	0.712	4.66	
E08R-SDXCR/L-2	59739	59740			0.500	0.712	7.66	
E10M-SDXCR/L-2	59743	59744			0.625	0.844	5.66	
E10S-SDXCR/L-2	59747	59748			0.625	0.844	9.66	
E12Q-SDXCR/L-3	60007	60008			0.750	0.980	6.115	32.52
E12S-SDXCR/L-3	60009	60010			0.750	0.980	9.115	
E16R-SDXCR/L-3	60011	60012			1.000	1.300	7.186	
E16T-SDXCR/L-3	60013	60014			1.000	1.300	11.186	
E20U-SDXCR/L-3	60015	60016			1.250	1.600	14.00	

Inserts used: all DC__ series (DCMT, DCGW, DCMT, DCGX, DCGT).

E_STUC R/L Thru Coolant Integral Carbide Boring Bar Style U - Negative 3° End Cutting Edge Angle for 7° positive triangle TC__ inserts

Bar Description	UPC #			Boring Ratio	Dia.	Min. Bore	Length	TC__ Gage Insert
	Right Hand	Left Hand						
E04H-STUCR/L-1.2	59751	59752		6:1	0.250	0.281	4.00	1.21.20.2
E05K-STUCR/L-1.2	59755	59756			0.312	0.339	5.00	
E06M-STUCR/L-1.2	59759	59760			0.375	0.409	6.00	
E06M-STUCR/L-2	59763	59764			0.375	0.456	6.00	
E08K-STUCR/L-2	59767	59768			0.500	0.587	5.00	
E08R-STUCR/L-2	59771	59772			0.500	0.587	8.00	21.51
E10M-STUCR/L-2	59775	59776			0.625	0.750	6.00	
E10S-STUCR/L-2	59779	59780			0.625	0.750	10.00	
E12Q-STUCR/L-3	60027	60028			0.750	0.930	7.000	
E12S-STUCR/L-3	60029	60030			0.750	0.930	10.00	
E16R-STUCR/L-3	60031	60032		1.000	1.200	8.000	32.52	
E16T-STUCR/L-3	60033	60034		1.000	1.200	12.00		
E20U-STUCR/L-3	60035	60036		1.250	1.470	14.00		

Inserts used: all TC__ series (TCMT, TCGW, TCGT, TCGX).

E_STUP R/L Thru Coolant Integral Carbide Boring Bar Style U - Negative 3° End Cutting Edge Angle for 11° positive triangle TP__ inserts

Bar Description	UPC #			Boring Ratio	Dia.	Min. Bore	Length	TP__ Gage Insert
	Right Hand	Left Hand						
E06M-STUPR/L-2	59783	59784		6:1	0.375	0.456	6.00	21.51
E08K-STUPR/L-2	59787	59788			0.500	0.587	5.00	
E08R-STUPR/L-2	59791	59792			0.500	0.587	8.00	
E10M-STUPR/L-2	59795	59796			0.625	0.750	6.00	
E10S-STUPR/L-2	59799	59800			0.625	0.750	10.00	

Inserts used: all TP__ series (TPMT, TPGT, TPMR, TPGW, TPGH, TPGB, TPHT).

E_SVMC R/L Thru Coolant Integral Carbide Boring Bar Style M - Negative 50° Side Cutting Edge Angle for 7° positive 35° diamond VC__ inserts

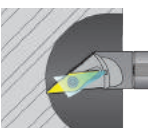

Bar Description	UPC #		Boring Ratio	Dia.	Min. Bore	Length	VC__ Gage Insert
	Right Hand	Left Hand					
E08K-SVMCR/L-2	59803	59804	6:1	0.500	0.587	5.23	221
E08R-SVMCR/L-2	59807	59808					
E10M-SVMCR/L-2	59811	59812					
E10S-SVMCR/L-2	59815	59816					

Inserts used: all VC__series (VCMT, VCGT, VCGW, VCGX).

E_SVQC R/L Thru Coolant Integral Carbide Boring Bar Style Q - Negative 17.5° End Cutting Edge Angle for 7° positive 35° diamond VC__ inserts

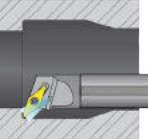

Bar Description	UPC #		Boring Ratio	Dia.	Min. Bore	Length	VC__ Gage Insert
	Right Hand	Left Hand					
E10M-SVQCR/L-2	59819	59820	6:1	0.625	0.844	6.00	221
E10S-SVQCR/L-2	59823	59824					

Inserts used: all VC__series (VCMT, VCGT, VCGW, VCGX).

E_SVUC R/L Thru Coolant Integral Carbide Boring Bar Style U - Negative 3° End Cutting Edge Angle for 7° positive 35° diamond VC__ inserts

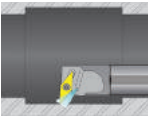

Bar Description	UPC #		Boring Ratio	Dia.	Min. Bore	Length	VC__ Gage Insert
	Right Hand	Left Hand					
E10M-SVUCR/L-2	59827	59828	6:1	0.625	0.844	6.00	221
E10S-SVUCR/L-2	59831	59832					

Inserts used: all VC__series (VCMT, VCGT, VCGW, VCGX).

E_SVXC R/L Thru Coolant Integral Carbide Boring Bar Style X - Negative 5° Back Boring Cutting Edge Angle for 7° positive 35° diamond VC__ inserts

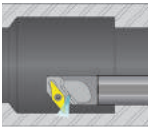

Bar Description	UPC #		Boring Ratio	Dia.	Min. Bore	Length	VC__ Gage Insert
	Right Hand	Left Hand					
E10M-SVXCR/L-2	59835	59836	6:1	0.625	1.0	5.76	221
E10S-SVXCR/L-2	59839	59840					

Inserts used: all VC__series (VCMT, VCGT, VCGW, VCGX).

E_SVQP R/L Thru Coolant Integral Carbide Boring Bar Style Q - Negative 17.5° End Cutting Edge Angle for 11° positive 35° diamond VP__ inserts

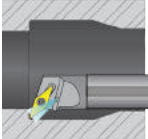

Bar Description	UPC #		Boring Ratio	Dia.	Min. Bore	Length	VP__ Gage Insert
	Right Hand	Left Hand					
E10M-SVQPR/L-2	59843	59844	6:1	0.625	0.844	6.00	221
E10S-SVQPR/L-2	59847	59848					

Inserts used: all VP__series (VPMT, VPGT).

E_SVUP R/L Thru Coolant Integral Carbide Boring Bar Style U - Negative 3° End Cutting Edge Angle for 11° positive 35° diamond VP__ inserts

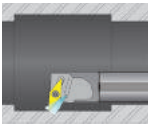

Bar Description	UPC #		Boring Ratio	Dia.	Min. Bore	Length	VP__ Gage Insert
	Right Hand	Left Hand					
E10M-SVUPR/L-2	59851	59852	6:1	0.625	0.844	6.00	221
E10S-SVUPR/L-2	59855	59856					

Inserts used: all VP__series (VPMT, VPGT).

E_SVXP R/L Thru Coolant Integral Carbide Boring Bar Style X - Negative 5° Back Boring Cutting Edge Angle for 11° positive 35° diamond VP__ inserts

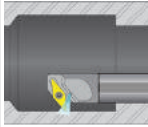

Bar Description	UPC #		Boring Ratio	Dia.	Min. Bore	Length	VP__ Gage Insert
	Right Hand	Left Hand					
E10M-SVXPR/L-2	59859	59860	6:1	0.625	1.00	5.76	221
E10S-SVXPR/L-2	59863	59864					

Inserts used: all VP__series (VPMT, VPGT).

E_SWLC R/L Thru Coolant Integral Carbide Boring Bar Style L - Negative 5° End Cutting Edge Angle for 7° positive 80° trigon WC__ inserts

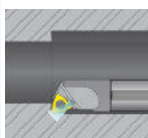

Bar Description	UPC #		Boring Ratio	Dia.	Min. Bore	Length	WC__ Gage Insert			
	Right Hand	Left Hand								
E03.0H-SWLCR/L-1.2	59867	59868	6:1	0.187	0.205	4.00	1.210.2			
E03.5H-SWLCR/L-1.2	59871	59872								
E04H-SWLCR/L-1.2	59875	59876								
E05K-SWLCR/L-1.2	59879	59880								
E06M-SWLCR/L-2	59883	59884								
E08K-SWLCR/L-2	59887	59888								
E08R-SWLCR/L-2	59891	59892								
E10M-SWLCR/L-2	59895	59896								
E10S-SWLCR/L-2	59899	59900								
E08K-SWLCR/L-3	59903	59904								
E08R-SWLCR/L-3	59907	59908	6:1	0.500	0.550	8.00				
E10M-SWLCR/L-3	59911	59912								
E10S-SWLCR/L-3	59915	59916								
E12Q-SWLCR/L-3	60047	60048								
E12S-SWLCR/L-3	60049	60050								
E16R-SWLCR/L-3	60051	60052								
E16T-SWLCR/L-3	60053	60054								
E20U-SWLCR/L-4	60055	60056								
							1.250	1.530	14.00	432

Inserts used: all WC__series (WCMT, WCGT).

E_SN R/L Thru Coolant Integral Carbide Threading Bar Internal Laydown Bar for Laydown Inserts

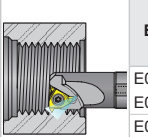

Bar Description	UPC #		Threading Ratio	Dia.	Min. Bore	Length	Laydown Gage Insert				
	Right Hand	Left Hand									
E03.5H-SNR/L-06	59919	59920	3:1	0.218	0.249	4.00	06-A60				
E04H-SNR/L-06	59923	59924									
E05K-SNR/L-08	59927	59928									
E06M-SNR/L-H11	59931	59932									
E08K-SNR/L-H11	59935	59936									
E08R-SNR/L-H11	59939	59940									
E10M-SNR/L-H16	59943	59944									
E10S-SNR/L-H16	59947	59948									
								0.625	0.750	6.00	16-A60

* 8 x Dia. Boring Ratio can be achieved under favorable conditions.

E_NE R/L Thru Coolant Integral Carbide Threading & Grooving Bar Style E - Internal DorNotch Bar for threading and grooving DorNotch inserts

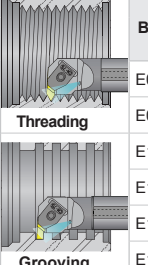

Bar Description	UPC #		Threading Ratio	Dia.	Min. Bore	Length	DorNotch Gage Insert				
	Right Hand	Left Hand									
E08K-NER/L-2	59951	59952	3:1	0.500	0.830	5.12	*NG-2L **NG-2R				
E08R-NER/L-2	59955	59956									
E10M-NER/L-2	59959	59960									
E10S-NER/L-2	59963	59964									
E12Q-NER/L-2	60169	60170									
E12S-NER/L-2	60171	60172									
								0.750	1.125	7.000	*NG-2L **NG-2R

* For right hand tool. ** For left hand tool

E_ADCLN R/L Thru Coolant Jet-Stream™ Carbide Boring Bar Style L - Negative 5° side & end cutting lead angle for negative 80° diamond CN__ inserts

Bar Description	UPC #			Boring Ratio	Dia.	Min. Bore	Length	CN__ Gage Insert
	Right Hand	Left Hand						
E16R-ADCLNR/L-4	60067	60068			1.000	1.280	8.000	
E16T-ADCLNR/L-4	60069	60070	6:1		1.000	1.280	12.00	432
E20U-ADCLNR/L-4	60071	60072			1.250	1.530	14.00	

Inserts used: all CN__ series (CNMG, CNGG, CNMX, CNMM, CNMA).

E_ADDUN R/L Thru Coolant Jet-Stream™ Carbide Boring Bar Style U Negative 3° end cutting lead angle for negative 55° diamond DN__ inserts

Bar Description	UPC #			Boring Ratio	Dia.	Min. Bore	Length	DN__ Gage Insert
	Right Hand	Left Hand						
E16R-ADDUNR/L-3	60093	60094			1.000	1.300	8.000	
E16T-ADDUNR/L-3	60095	60096	6:1		1.000	1.300	12.00	332
E20U-ADDUNR/L-4	60097	60098			1.250	2.000	14.00	432

Inserts used: all DN__ series (DNMG, DNMG, DNMX, DNMA, DNGG).

E_ADTUN R/L Thru Coolant Jet-Stream™ Carbide Boring Bar Style U - Negative 3° end cutting lead angle for negative triangle TN__ inserts

Bar Description	UPC #			Boring Ratio	Dia.	Min. Bore	Length	TN__ Gage Insert
	Right Hand	Left Hand						
E16R-ADTUNR/L-3	60079	60080			1.000	1.280	8.000	
E16T-ADTUNR/L-3	60081	60082	6:1		1.000	1.280	12.00	332
E20U-ADTUNR/L-3	60083	60084			1.250	1.530	14.00	

Inserts used: all TN__ series (TNMG, TNMC, TNMX, TNMA).

E_ADDPN R/L Thru Coolant Jet-Stream™ Carbide Boring Bar Style P- Negative 27.5° end cutting lead angle for negative 55° diamond DN__ inserts

Bar Description	UPC #			Boring Ratio	Dia.	Min. Bore	Length	DN__ Gage Insert
	Right Hand	Left Hand						
E16R-ADDPNR/L-3	60109	60110			1.000	1.500	8.000	
E16T-ADDPNR/L-3	60111	60112	6:1		1.000	1.500	12.00	332
E20U-ADDPNR/L-4	60113	60114			1.250	1.750	14.00	432

Inserts used: all DN__ series (DNMG, DNMG, DNMX, DNMA, DNGG).

E_ADVUN R/L Thru Coolant Jet-Stream™ Carbide Boring Bar Style U - Negative 3° side cutting lead angle for negative 35° diamond VN__ inserts

Bar Description	UPC #			Boring Ratio	Dia.	Min. Bore	Length	VN__ Gage Insert
	Right Hand	Left Hand						
E20U-ADVUNR/L-3	60121	60122	6:1		1.250	2.250	14.00	332

Inserts used: all VN__ series (VNMG).

E_ADWLN R/L Thru Coolant Jet-Stream™ Carbide Boring Bar Style L - Negative 5° end & side cutting lead angle for negative 80° trigon WN__ inserts

Bar Description	UPC #			Boring Ratio	Dia.	Min. Bore	Length	WN__ Gage Insert
	Right Hand	Left Hand						
E16R-ADWLN/L-4	60125	60126			1.000	1.450	8.000	
E16T-ADWLN/L-4	60127	60128	6:1		1.000	1.450	12.00	432
E20U-ADWLN/L-4	60129	60130			1.250	1.530	14.00	

Inserts used: all WN__ series (WNMG, WNMA).

E-ADNE R/L Thru Coolant Jet-Stream™ Carbide Threading Bar Style E- For DorNotch Threading Inserts

Bar Description	UPC #			Threading Ratio	Dia.	Min. Bore	Length	DorNotch Gage Insert
	Right Hand	Left Hand						
E16R-ADNER/L-3	60173	60174			1.000	1.380	8.000	
E16T-ADNER/L-3	60175	60176	3:1		1.000	1.380	12.000	NG-3L* NG-3R**
E20U-ADNER/L-3	60177	60178			1.250	1.750	14.000	

* For right hand holder ** For left hand holder

E-ADLN R/L Thru Coolant Jet-Stream™ Carbide Threading Bar Style N- for LayDown Threading Inserts

Bar Description	UPC #			Threading Ratio	Dia.	Min. Bore	Length	LayDown Gage Insert
	Right Hand	Left Hand						
E12Q-ADLNR/L-16	60145	60146			0.750	1.120	7.000	
E12S-ADLNR/L-16	60147	60148			0.750	1.120	10.00	
E16R-ADLNR/L-16	60149	60150	3:1		1.000	1.375	8.000	16-G60
E16T-ADLNR/L-16	60151	60152			1.000	1.375	12.00	
E20U-ADLNR/L-16	60153	60154			1.250	1.620	14.00	
E20U-ADLNR/L-22	60155	60156			1.250	1.750	14.00	22-N60

* For right hand bar ** For left hand bar

High Performance Quick Change Carbide Boring Bars Body & Boring Heads

for Multi Boring and Threading Operation

1 SCLC R/L
Quick Change
Boring Bar Head
With Thru Coolant

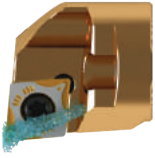

2 SDNC R/L
Quick Change
Boring Bar Head
With Thru Coolant



3 SDQC R/L
Quick Change
Boring Bar Head
With Thru Coolant



4 SDUC R/L
Quick Change
Boring Bar Head
With Thru Coolant



9 Interchangeable Heads

5 SDXC R/L
Quick Change
Boring Bar Head
With Thru Coolant



6 STUC R/L
Quick Change
Boring Bar Head
With Thru Coolant



One Quick Change Carbide Body

7 SVUC R/L
Quick Change
Boring Bar Head
With Thru Coolant



8 SWLC R/L
Quick Change
Boring Bar Head
With Thru Coolant



9 SN R/L
Quick Change
Threading Bar Head
With Thru Coolant



Note: Quick Change Boring Heads will fit the Quick Change Carbide Boring Bar Body, and the Solution Tool Quick Change Boring Bar Body.

Thru Coolant Quick Change Carbide Boring Bar Body

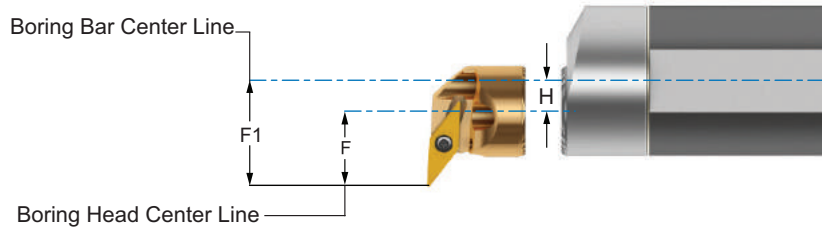
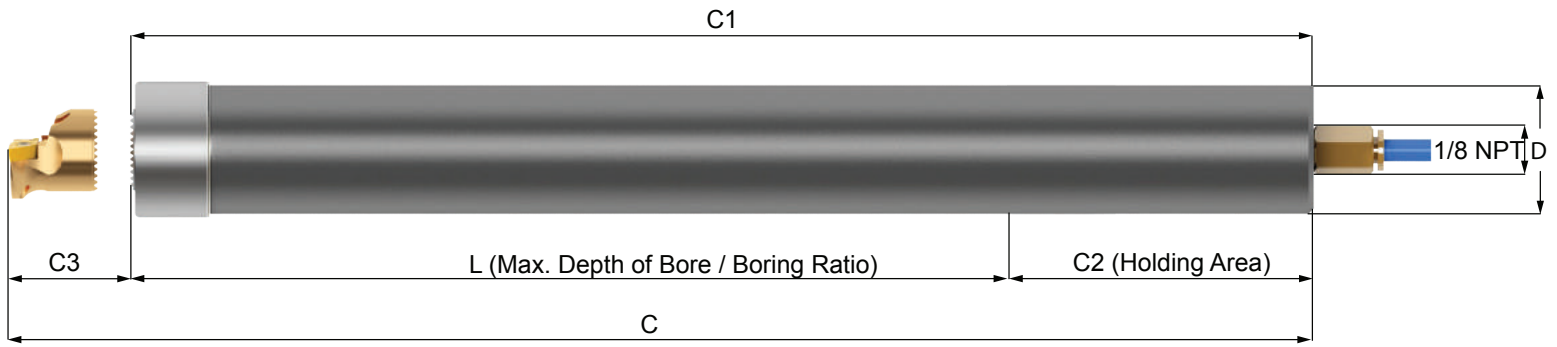

Bar Description	UPC # Neutral	Boring Ratio	Construction	Bar Dia.	Actual Min. Bore B	F1	H	L	C	C1	C2	C3	Modular Head CBBB
AE12I-Q-QCCBB	60195	4 x Dia.	Carbide Body	0.750	$F + H + (1/2 \text{ Bar Dia})$	F1=F+H	0	4.00	7.000	6.200	3.00	0.800	DBOMH-12/20M
AE16I-R-QCCBB	60197			0.125			4.00	8.000	7.200	4.00	0.800		
AE12I-S-QCCBB	60196	6 x Dia.	Carbide Body	0.750	Note: Leave enough room for chip evacuation	F1=F+H	0	7.00	10.000	9.200	3.00	0.800	DBOMH-12/20M
AE16I-T-QCCBB	60198			0.125			8.00	12.000	11.200	4.00	0.800		
AE20I-U-QCCBB	60199			0.250			8.00	12.800	13.000	5.00	0.800		

8 x Dia. Boring Ratio can be achieved under favorable conditions.
For Quick Change Heads, see pages 53 and 54



Solution Tool!™

THE NO! VIBRATION RE-TUNABLE BORING BAR

**Makes Deep Hole Boring
Simple!**

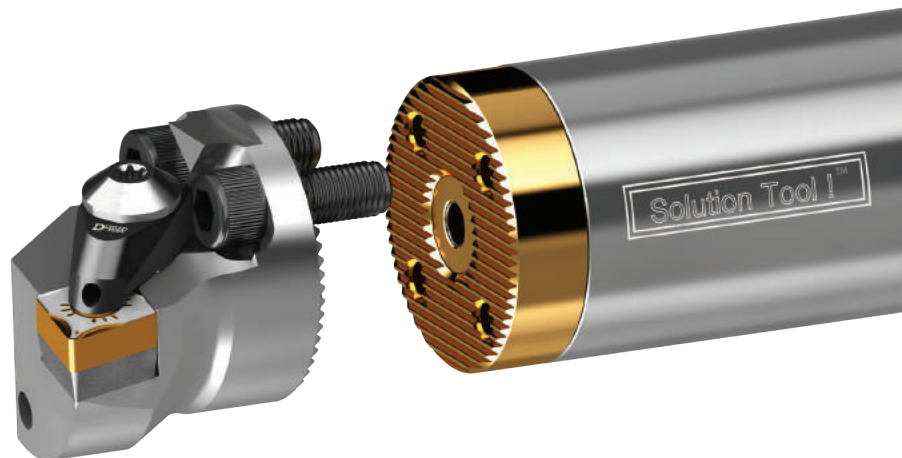

Solution Tool!™ The No! Vibration Re-Tunable Threading & Boring Bar OUTPERFORMS THE BEST



To maximize performance in deep boring operations, Solution Tool!™ is offered in 2 versions:

Steel Body: The steel body for boring depth up to 12 x Boring Bar Diameter

Carbide Body: The carbide body rigidity and stability, allows to bore at higher cutting rate and material removal, and longer depth of cut up to 14xD.

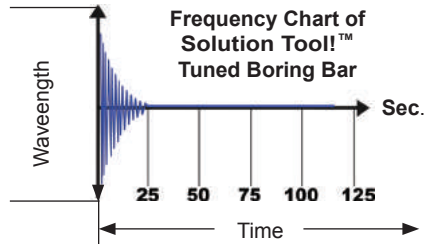

**Boring Bar
TUNED - TESTED - CERTIFIED
Ready to Operate**



Re-tunable Key



**When to Re-tune the Bar?
Re-tune to optimize the Bar performance**

How The Solution Tool!™ The NO! Vibration Re-Tunable Boring Bar Works?

The Solution Tool!™ is dynamically tuned, tested and certified to meet Dorian Tool Quality control standards and performance and ready to be used.

Re-Tuning The Solution Tool!™ Can be re-tuned on the machine to optimize the boring bar performance when:

- Extreme and exotic materials change from very soft to very hard.
- Thin wall parts
- Changing the boring depth. Ex: a boring bar with a 12 x Dia. Boring Ratio will be used for a shorter boring Ratio like 6 x Dia..
- Improving performance for specific machining operations such as finishing, roughing boring, threading, and grooving.

Solution Tool!™ The No! Vibration Re-Tunable Boring Bar

BEST

Split Collar Holding System Boring Bar Holding System

Locks the boring bar at 360° on the diameter, assuring the most rigid and precise boring bar positioning *Without scarring or damaging the bar surface.*

100% Rigidity!

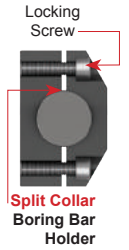
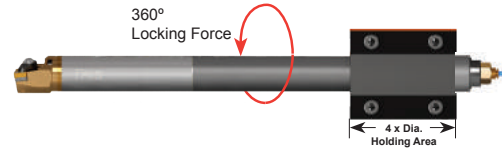

Split Collar Boring Bar Holder

GOOD

Split Bushing Holding System With a solid boring bar holder

The split bushing embraces the boring bar at 360° on the diameter. The boring bar holder screws will squeeze the bushing around the boring bar *Without scarring or damaging the bar surface with precise positioning.*

80% Rigidity!

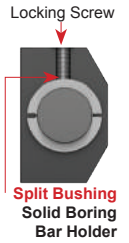
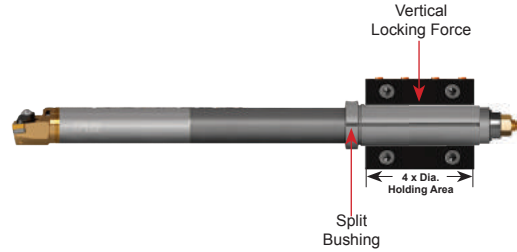

Split Bushing Solid Boring Bar Holder

DO NOT USE IT

Set Screw Lock Holding System

Solid boring bar holder Without bushing

Never lock the screws directly on the boring bar. Locking a screw over the boring bar will create only one point of contact causing very poor rigidity. Additionally, the *screw will damage the boring bar surface and make positioning difficult.*

STOP! Do not Use it

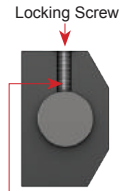
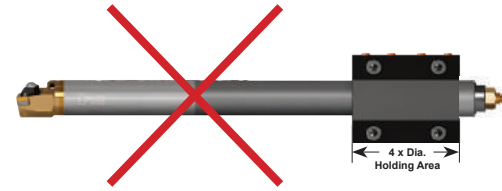

Set Screw Lock Solid Boring Bar Holder

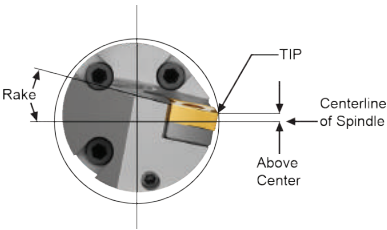

Insert Center Line Set-Up

Due to the cutting pressure placed on the insert during deep boring, the bar flexes downward. Place the insert cutting edge above the center line by 10% of bar diameter to compensate bar deflection and to reduce vibration.
Example: 1" inch bar 1% = .010"z

Important Recommendations

For a Roughing operation with a large depth of cut and a high feed rate, low RPM is recommended. For a Finishing operation with a small depth of cut and a low feed rate, high RPM is recommended. Minimum depth of cut is 1/2 of the insert radius. Maximum feed rate is 1/2 of the insert radius. When wrong cutting parameters are used for the specific material to be bored, and for the operation to be executed, the boring bar will not perform properly, generating poor surface finish and/or vibration.

Maximum Boring & Threading Ratio for Steel, Carbide and Solution Tool! Boring Bars

Steel Bars

4 x Dia. Boring Ratio 2 x Dia. Threading & Grooving Ratio

- General boring bar applications
- Roughing to Finishing

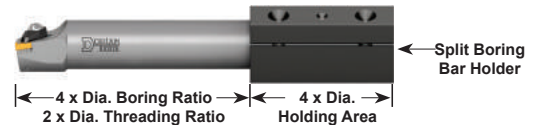

Carbide Bars

6 x Dia. Boring Ratio 3 x Dia. Threading & Grooving Ratio

- Best for boring small holes
- Rigid for close tolerances and good surface finish
- Rigid for heavy material removal at high depth of cut and feed rate.

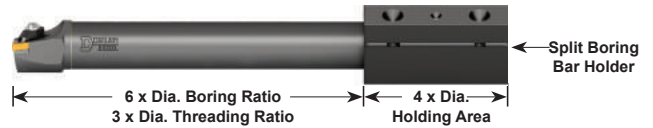

Solution Tool!™ (Steel Body)

6 x Dia., 8 x Dia., 10 x Dia., 12 x Dia. Boring Ratio 4 x Dia. Threading & Grooving Ratio

- For deep hole boring applications

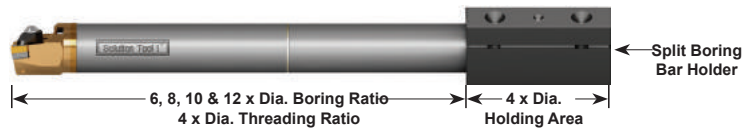

Solution Tool!™ (Carbide Body)

8 x Dia., 10 x Dia., 12 x Dia., 14 x Dia. Boring Ratio 5 x Dia. Threading & Grooving Ratio

- High performance deep hole boring applications for higher material removal rate.

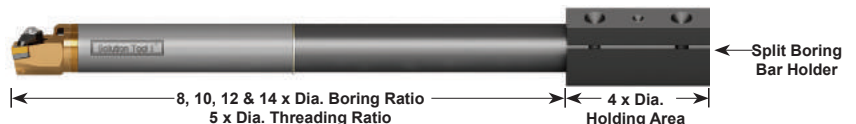

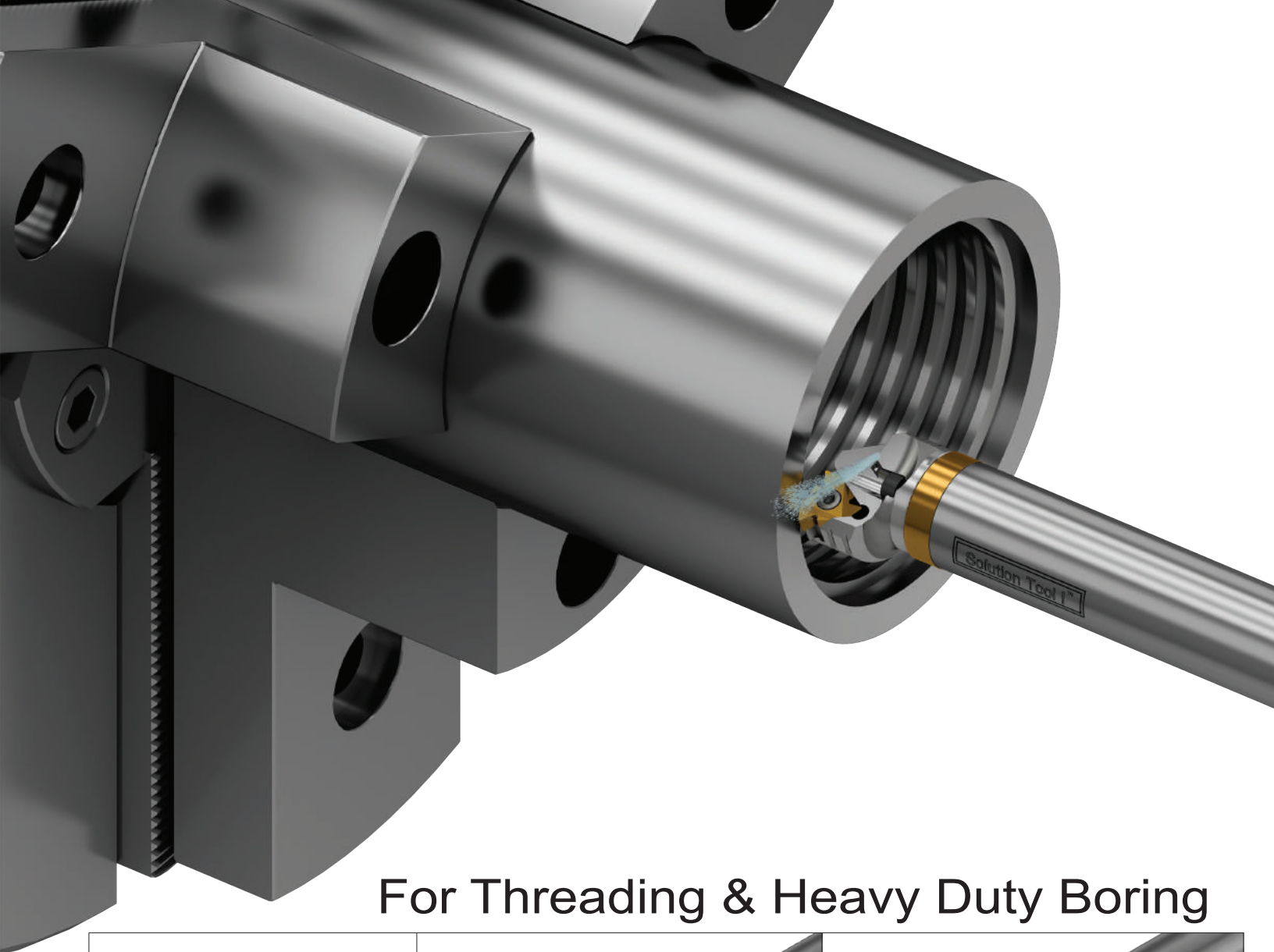

For Threading & Heavy Duty Boring



Integral Threading & Boring

- 1/2" X 6D
- 5/8" X 6D





Quick Change Threading & Boring

- 3/4" X 6D
- 1" X 6D
- 1 1/4" X 6D

Modular Jet-Stream Threading & Boring

- 1 1/2" X 6D
- 2" X 6D
- 2 1/2" X 6D
- 3" X 6D
- 4" X 6D

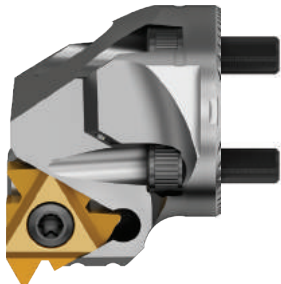

Will fit all the Quick Change Boring Heads on page 53-54

Will fit all the Modular Boring Heads on page 56-58

Solution Tool!™ The No! Vibration Re-Tunable Integral Threading & Heavy Duty Boring Bar

NEW
4 - 6 x Dia.

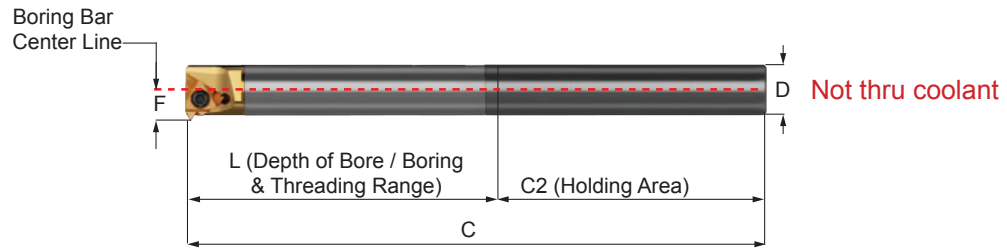

Bar Description	UPC #		Boring & Threading Ratio	Holding Ratio	Construction	Bar Dia. D	Actual Min. Bore B	F	L	C	C1	C2	C3	C4	Gage Insert	Insert Screw
	R.H.	L.H.														
ST108X-06-ITBNR/L06-11-CB	60376	60375	4-6 x Dia.	2-4	Carbide Body	.500	.565	.315	3.000	5.00	4.375	2.000	0.625	2.375	11-A60	TS-25.4-6M2
ST110X-06-ITBNR/L-07-16-CB	60378	60377				.625	.720	.406								

Solution Tool!™ The No! Vibration Re-Tunable Quick Change Threading & Heavy Duty Boring Bar

NEW
4 - 6 x Dia.

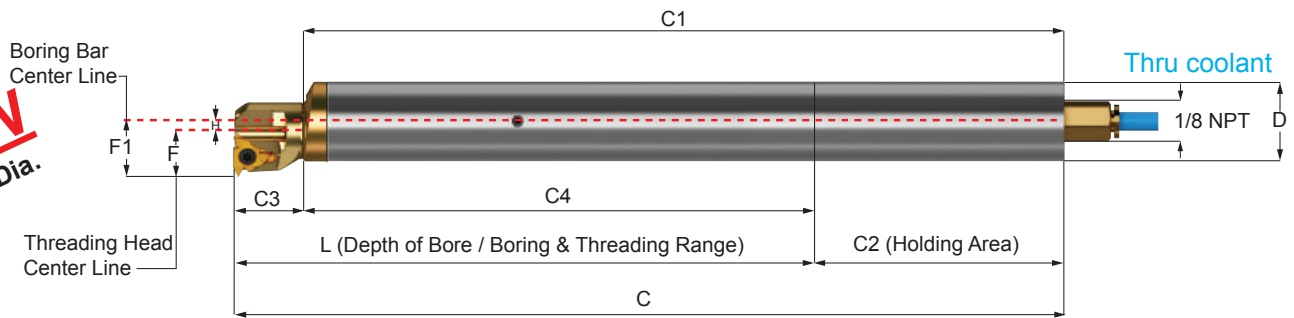

Bar Description	UPC #		Boring & Threading Ratio	Holding Ratio	Construction	Bar Dia. D	Actual Min. Bore B	F1	H	L	C	C1	C2	C3	C4	Threading Head
	R.H.	L.H.														
ST112X-06-QTB08-SB	60383	-	4-6 x Dia.	2-4	Steel Body	0.750	F + H + (1/2 Bar Dia)	F1=F+H	0	4.500	6.000	5.200	1.500	0.800	3.700	DBOMH-12/20M-SNR/L-16
ST116X-06-QTB10-SB	60384	-				1.000	0.125		6.000	8.000	7.200	2.000	0.800	5.200		
ST120X-06-QTB13-SB	60385	-				1.250	0.250		7.500	10.000	9.200	2.500	0.800	6.700		

Solution Tool!™ The No! Vibration Re-Tunable Modular Jet-Stream Threading & Heavy Duty Boring Bar

NEW
4 - 6 x Dia.

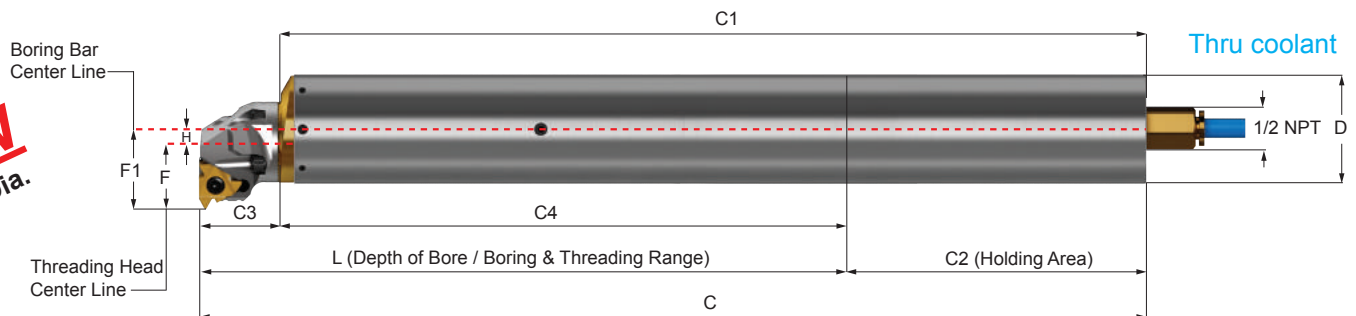

Bar Description	UPC #		Boring & Threading Ratio	Holding Ratio	Construction	Bar Dia. D	Actual Min. Bore B	F1	H	L	C	C1	C2	C3	C4	Threading Head
	R.H.	L.H.														
ST124X-06-MTB14-SB	60389		4-6 x Dia.	2-4	Steel Body	1.500	B = F + H + (1/2 Bar Dia)	F1=F+H	0	9.000	12.000	10.425	3.000	1.575	7.425	DBOMH-24/40M-ADLNR/L-16
ST132X-06-MTB18-SB	60391					2.000			0.250	12.000	16.000	14.425	4.000	1.575	10.425	DBOMH-24/40M-ADLNR/L-22
ST140X-06-MTB23-SB	60392					2.500			0.500	15.000	20.000	18.425	5.000	1.575	13.425	DBOMH-24/40M-ADLNR/L-27
ST148X-06-MTB27-SB	60393					3.000			0.750	18.000	24.000	22.425	6.000	1.575	16.425	DBOMH-24/40M-ADNER/L-3
ST164X-06-MTB36-SB	60394					4.000			1.250	24.000	32.000	30.425	8.000	1.575	22.425	DBOMH-24/40M-ADTHOR/L-4

Solution Tool!™ The No! Vibration Re-Tunable Integral Boring Bar

Small Diameters 1/2" and 5/8"

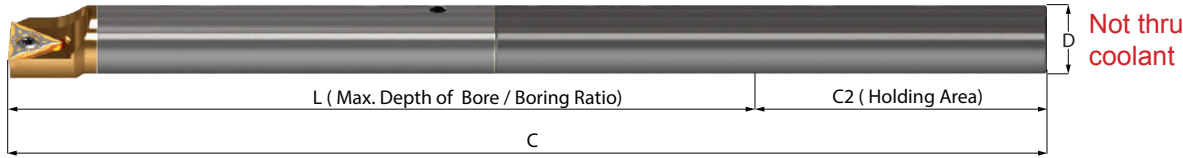

- Deep hole boring made simple
- 8xD, 10xD, 12xD and 14xD boring (overhang) ratios
- For high material removal rate, high surface finish and tight tolerances
- Bars are pre-tuned at the factory to the specific boring ratio
- Bars can be Re-tuned on the machine to optimize boring performance in challenging application

Min Bore (B) in the charts below includes chip clearance.
 Actual minimum bore = F + (1/2 Bar Dia.)
 Always allow enough room for chip evacuation.

Bar Description	UPC #		Boring Ratio	Construction	Min. Bore						Gage Insert	
	Right Hand	Left Hand			Dia.	B	C	L	C2	F	DC__	Insert Screw
DVI06X-08-SCLCR-2-CB	59026	-	8 x Dia.	Carbide Body	0.375	.470	5.63	3.00	2.63	.220	21.51	TS-25.45-6M2
DVI08X-08-SCLCR/L-2-CB	59400	59401			0.500	.625	7.00	4.00	3.00	.275		
DVI10X-08-SCLCR/L-3-CB	59404	59405			0.625	.781	8.13	5.00	3.13	.395		
DVI06X-10-SCLCR-2-CB	59028	-	10 x Dia.		0.375	.470	6.38	3.75	2.63	.220	21.51	TS-25.45-6M2
DVI08X-10-SCLCR/L-2-CB	59034	59035			0.500	.625	8.00	5.00	3.00	.275		
DVI10X-10-SCLCR/L-3-CB	59046	59047			0.625	.781	9.38	6.25	3.13	.395		
DVI06X-12-SCLCR-2-CB	59030	-	12 x Dia.		0.375	.470	7.13	4.50	2.63	.220	21.51	TS-25.45-6M2
DVI08X-12-SCLCR/L-2-CB	59036	59037			0.500	.625	9.00	6.00	3.00	.275		
DVI10X-12-SCLCR/L-3-CB	59048	59049			0.625	.781	10.63	7.50	3.13	.395		
DVI06X-14-SCLCR-2-CB	59032	-	14 x Dia.	0.375	.470	7.88	5.25	2.63	.220	21.51	TS-25.45-6M2	
DVI08X-14-SCLCR/L-2-CB	59038	59039		0.500	.625	10.00	7.00	3.00	.275			
DVI10X-14-SCLCR/L-3-CB	59050	59051		0.625	.781	11.88	8.75	3.13	.395			



Bar Description	UPC #		Boring Ratio	Construction	Min. Bore						Gage Insert	
	Right Hand	Left Hand			Dia.	B	C	L	C2	F	DC__	Insert Screw
DVI06X-08-SDUCR-2-CB	59142	-	8 x Dia.	Carbide Body	0.375	.625	5.63	3.00	2.63	.375	21.51	TS-25.45-6M2
DVI08X-08-SDUCR/L-2-CB	59406	59407			0.500	.750	7.00	4.00	3.00	.437		
DVI10X-08-SDUCR/L-2-CB	59408	59409			0.625	.875	8.13	5.00	3.13	.500		
DVI06X-10-SDUCR-2-CB	59144	-	10 x Dia.		0.375	.625	6.38	3.75	2.63	.375	21.51	TS-25.45-6M2
DVI08X-10-SDUCR/L-2-CB	59150	59151			0.500	.750	8.00	5.00	3.00	.437		
DVI10X-10-SDUCR/L-2-CB	60297	60298			0.625	.875	9.38	6.25	3.13	.500		
DVI06X-12-SDUCR-2-CB	59146	-	12 x Dia.		0.375	.625	7.13	4.50	2.63	.375	21.51	TS-25.45-6M2
DVI08X-12-SDUCR/L-2-CB	59152	59153			0.500	.750	9.00	6.00	3.00	.437		
DVI10X-12-SDUCR/L-2-CB	59158	59159			0.625	.875	10.63	7.50	3.13	.500		
DVI06X-14-SDUCR-2-CB	59148	-	14 x Dia.	0.375	.625	7.88	5.25	2.63	.375	21.51	TS-25.45-6M2	
DVI08X-14-SDUCR/L-2-CB	59154	59155		0.500	.750	10.00	7.00	3.00	.437			
DVI10X-14-SDUCR/L-2-CB	59160	59161		0.625	.875	11.88	8.75	3.13	.500			

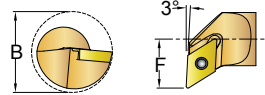

Bar Description	UPC #		Boring Ratio	Construction	Min. Bore						Gage Insert	
	Right Hand	Left Hand			Dia.	B	C	L	C2	F	DC__	Insert Screw
DVI06X-08-SDNCR-2-CB	59094	-	8 x Dia.	Carbide Body	0.375	0.581	5.63	3.00	2.63	.375	21.51	TS-25.45-6M2
DVI08X-08-SDNCR-2-CB	59102	-			0.500	0.813	7.00	4.00	3.00	.500		
DVI10X-08-SDNCR-2-CB	59110	-			0.625	0.938	8.13	5.00	3.13	.562		
DVI06X-10-SDNCR-2-CB	59096	-	10 x Dia.		0.375	0.581	6.38	3.75	2.63	.375	21.51	TS-25.45-6M2
DVI08X-10-SDNCR-2-CB	59104	-			0.500	0.813	8.00	5.00	3.00	.500		
DVI10X-10-SDNCR-2-CB	59112	-			0.625	0.938	9.38	6.25	3.13	.562		
DVI06X-12-SDNCR-2-CB	59098	-	12 x Dia.		0.375	0.581	7.13	4.50	2.63	.375	21.51	TS-25.45-6M2
DVI08X-12-SDNCR-2-CB	59106	-			0.500	0.813	9.00	6.00	3.00	.500		
DVI10X-12-SDNCR-2-CB	59114	-			0.625	0.938	10.63	7.50	3.13	.562		
DVI06X-14-SDNCR/L-2-CB	59100	-	14 x Dia.	0.375	0.581	7.88	5.25	2.63	0.375	21.51	TS-25.45-6M2	
DVI08X-14-SDNCR-2-CB	59108	-		0.500	0.813	10.00	7.00	3.00	.500			
DVI10X-14-SDNCR-2-CB	59116	-		0.625	0.938	11.88	8.75	3.13	.562			

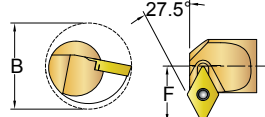

Bar Description	UPC #		Boring Ratio	Construction	Min. Bore						Gage Insert	
	Right Hand	Left Hand			Dia.	B	C	L	C2	F	DC__	Insert Screw
DVI06X-08-SDXCR-2-CB	59182	-	8 x Dia.	Carbide Body	0.375	0.625	5.63	3.00	2.63	.375	21.51	TS-25.45-6M2
DVI08X-08-SDXCR-2-CB	59190	-			0.500	0.750	7.00	4.00	3.00	.437		
DVI10X-08-SDXCR/L-2-CB	59198	-			0.625	0.875	8.13	5.00	3.13	.500		
DVI06X-10-SDXCR-2-CB	59184	-	10 x Dia.		0.375	0.625	6.38	3.75	2.63	.375	21.51	TS-25.45-6M2
DVI08X-10-SDXCR-2-CB	59192	-			0.500	0.750	8.00	5.00	3.00	.437		
DVI10X-10-SDXCR-2-CB	59200	-			0.625	0.875	9.38	6.25	3.13	.500		
DVI06X-12-SDXCR-2-CB	59186	-	12 x Dia.		0.375	0.625	7.13	4.50	2.63	.375	21.51	TS-25.45-6M2
DVI08X-12-SDXCR-2-CB	59194	-			0.500	0.750	9.00	6.00	3.00	.437		
DVI10X-12-SDXCR-2-CB	59202	-			0.625	0.875	10.63	7.50	3.13	.500		
DVI06X-14-SDXCR-2-CB	59188	-	14 x Dia.	0.375	0.625	7.88	5.25	2.63	.375	21.51	TS-25.45-6M2	
DVI08X-14-SDXCR-2-CB	59196	-		0.500	0.750	10.00	7.00	3.00	.437			
DVI10X-14-SDXCR-2-CB	59204	-		0.625	0.875	11.88	8.75	3.13	.500			

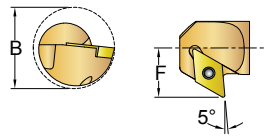

Bar Description	UPC #		Boring Ratio	Construction	Min. Bore						Gage Insert	
	Right Hand	Left Hand			Dia.	B	C	L	C2	F	TC__	Insert Screw
DVI06X-08-STUCR-2-CB	59246	-	8 x Dia.	Carbide Body	0.375	0.447	5.63	3.00	2.63	.220	21.51	TS-25.45-6M2
DVI08X-08-STUCR/L-2-CB	59410	59411			0.500	0.625	7.00	4.00	3.00	.312		
DVI10X-08-STUCR/L-2-CB	59412	59413			0.625	0.781	8.13	5.00	3.13	.406		
DVM10X-10-STUCR-11-CB	59248	-	10 x Dia.		0.375	0.447	6.38	3.75	2.63	.220	21.51	TS-25.45-6M2
DVI08X-10-STUCR/L-2-CB	59262	59263			0.500	0.625	8.00	5.00	3.00	.312		
DVI10X-10-STUCR/L-2-CB	59268	59269			0.625	0.781	9.38	6.25	3.13	.406		
DVI06X-10-STUCR-2-CB	59250	-	12 x Dia.		0.375	0.447	7.13	4.50	2.63	.220	21.51	TS-25.45-6M2
DVI08X-12-STUCR/L-2-CB	59264	59265			0.500	0.625	9.00	6.00	3.00	.312		
DVI10X-12-STUCR/L-2-CB	59270	59271			0.625	0.781	10.63	7.50	3.13	.406		
DVI06X-14-STUCR-2-CB	59252	-	14 x Dia.	0.375	0.447	7.88	5.25	2.63	.220	21.51	TS-25.45-6M2	
DVI08X-14-STUCR/L-2-CB	59266	59267		0.500	0.625	10.00	7.00	3.00	.312			
DVI10X-14-STUCR/L-2-CB	59272	59273		0.625	0.781	11.78	8.75	3.13	.406			

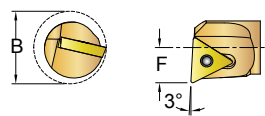

Solution Tool!™ The No! Vibration Re-Tunable Quick Change Boring Bar

Medium Diameters 3/4", 1" and 1 1/4".

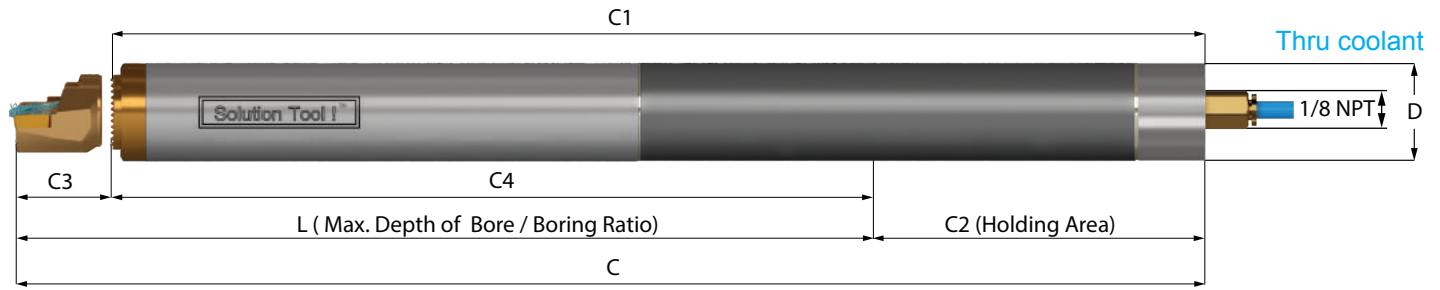

- Deep hole boring made simple
- 8xD, 10xD, 12xD and 14xD boring (overhang) ratios
- For high material removal rate, high surface finish and tight tolerances
- Bars are pre-tuned at the factory to the specific boring ratio
- Bars can be Re-tuned on the machine to optimize boring performance in challenging application

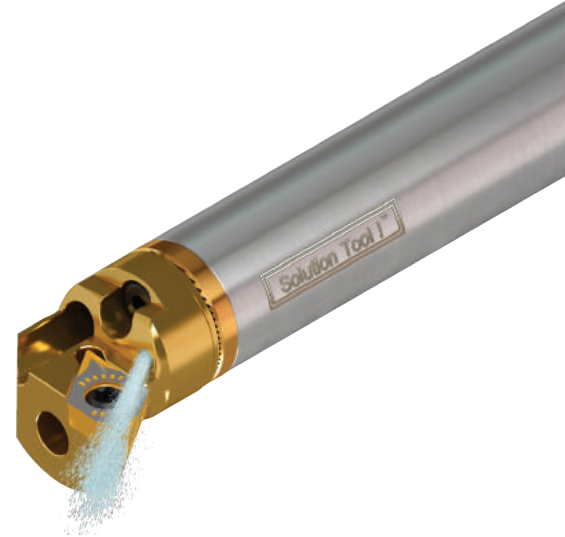
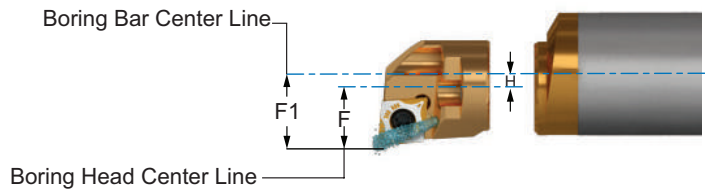

Bar Description	UPC # Neutral	Boring Ratio	Holding Ratio	Construction	Bar Dia. D	Actual Min. Bore B	F1	H	L	C	C1	C2	C3	C4	Quick Change Head	Coolant Attachment Thread
DVI12X-08-MQBBS-9-SB	59428	8 x Dia.	4	Steel Body	0.750	B = F + H + (1/2 Bar Dia) Note: Leave enough room for chip evacuation	F1=F+H	0	6.00	9.00	8.20	3.00	0.8	5.2	DBOMH-12/20M	1/8"-27 NPT
DVI12X-08-MQBBS-9-CB	60360			Carbide Body	0.750			0	6.00	9.00	8.20	3.00	0.8	5.2		
DVI16X-08-MQBBS-12-SB	59340			Steel Body	1.000			0.125	8.00	12.00	11.20	4.00	0.8	7.2		
DVI16X-08-MQBBS-12-CB	60362			Carbide Body	1.000			0.125	8.00	12.00	11.20	4.00	0.8	7.2		
DVI20X-08-MQBBS-15-SB	59341			Steel Body	1.250			0.250	10.00	15.00	14.20	5.00	0.8	9.2		
DVI20X-08-MQBBS-15-CB	60364			Carbide Body	1.250			0.250	10.00	15.00	14.20	5.00	0.8	9.2		

DVI12X-10-MQBBS-11-SB	59342	10 x Dia.	4	Steel Body	0.750	B = F + H + (1/2 Bar Dia) Note: Leave enough room for chip evacuation	F1=F+H	0	7.50	10.50	9.70	3.00	0.8	6.7	DBOMH-12/20M	1/8"-27 NPT
DVI12X-10-MQBBS-11-CB	60361			Carbide Body	0.750			0	7.50	10.50	9.70	3.00	0.8	6.7		
DVI16X-10-MQBBS-14-SB	59429			Steel Body	1.000			0.125	10.00	14.00	13.20	4.00	0.8	9.2		
DVI16X-10-MQBBS-14-CB	60363			Carbide Body	1.000			0.125	10.00	14.00	13.20	4.00	0.8	9.2		
DVI20X-10-MQBBS-18-SB	59471			Steel Body	1.250			0.250	12.50	17.50	16.70	5.00	0.8	11.7		
DVI20X-10-MQBBS-18-CB	60365			Carbide Body	1.250			0.250	12.50	17.50	16.70	5.00	0.8	11.7		

DVI12X-12-MQBBS-12-SB	59360	12 x Dia.	4	Steel Body	0.750	B = F + H + (1/2 Bar Dia) Note: Leave enough room for chip evacuation	F1=F+H	0	9.00	12.00	11.20	3.00	0.8	8.2	DBOMH-12/20M	1/8"-27 NPT
DVI12X-12-MQBBS-12-CB	59343			Carbide Body	0.750			0	9.00	12.00	11.20	3.00	0.8	8.2		
DVI16X-12-MQBBS-16-SB	59361			Steel Body	1.000			0.125	12.00	16.00	15.20	4.00	0.8	11.2		
DVI16X-12-MQBBS-16-CB	59391			Carbide Body	1.000			0.125	12.00	16.00	15.20	4.00	0.8	11.2		
DVI20X-12-MQBBS-20-SB	59362			Steel Body	1.250			0.250	15.00	20.00	19.20	5.00	0.8	14.2		
DVI20X-12-MQBBS-20-CB	59393			Carbide Body	1.250			0.250	15.00	20.00	19.20	5.00	0.8	14.2		

DVI12X-14-MQBBS-14-CB	59344	14 x Dia.	4	Carbide Body	0.750	B = F + H + (1/2 Bar Dia) Note: Leave enough room for chip evacuation	F1=F+H	0	10.50	13.50	12.70	3.00	0.8	9.7	DBOMH-12/20M	1/8"-27 NPT
DVI16X-14-MQBBS-18-CB	59392			Carbide Body	1.000			0.125	14.00	18.00	17.20	4.00	0.8	13.2		
DVI20X-14-MQBBS-23-CB	59394			Carbide Body	1.250			0.250	17.50	22.50	21.70	5.00	0.8	16.7		

Boring Heads for Solution Tool!™ Quick Change Boring Bar 3/4" to 1/4"

Positive Boring Head Specification	Head Description	UPC #		Reference Bar Dia.	B	E	F	K°	Gage Insert	Insert Torx	Torx Key	Locking Head Screw
		R.H.	L.H.									
<p>Thru Coolant Right Hand Shown Left Hand Opposite</p>	DBOMH-12/20M-SCLCR/L-3	60225	60226	0.750	1.000	0.820	0.500	8°	CC_32.52	TS-4.7-10M1	T-15	QCHLS-3MCS
				1.000	1.250	0.820	0.500	8°				
				1.250	1.500	0.820	0.500	8°				
<p>Thru Coolant Right Hand Shown Left Hand Opposite</p>	DBOMH-12/20M-SCLPR-3	60259	-	0.750	1.000	0.820	0.600	8°	DC_32.52	TS-4.7-10M1	T-15	QCHLS-3MCS
				1.000	1.250	0.820	0.600	8°				
				1.250	1.500	0.820	0.600	8°				
<p>Thru Coolant Right Hand Shown Left Hand Opposite</p>	DBOMH-12/20M-SDNCR/L-3	60229	60230	0.750	1.160	0.820	0.660	5°	DC_32.52	TS-4.7-10M1	T-15	QCHLS-3MCS
				1.000	1.410	0.820	0.660	5°				
				1.250	1.660	0.820	0.660	5°				
<p>Thru Coolant Right Hand Shown Left Hand Opposite</p>	DBOMH-12/20M-SDQCR/L-2	60251	60252	0.750	1.125	0.820	.500	7°	DC_21.51	TS-25.45-6M2	T-8	QCHLS-3MCS
				1.000	1.375	0.820	.500	7°				
				1.250	1.625	0.820	.500	7°				
	DBOMH-12/20M-SDQCR/L-3	60231	60232	0.750	1.125	0.820	0.625	7°	DC_32.52	TS-4.7-10M1	T-15	QCHLS-3MCS
				1.000	1.375	0.820	0.625	7°				
				1.250	1.625	0.820	0.625	7°				
<p>Thru Coolant Right Hand Shown Left Hand Opposite</p>	DBOMH-12/20M-SDUCR/L-2	60247	60248	0.750	1.025	0.820	0.525	6°	DC_21.51	TS-25.45-6M2	T-8	QCHLS-3MCS
				1.000	1.275	0.820	0.525	6°				
				1.250	1.525	0.820	0.525	6°				
	DBOMH-12/20M-SDUCR/L-3	60227	60228	0.750	1.038	0.820	0.625	6°	DC_32.52	TS-4.7-10M1	T-15	QCHLS-3MCS
				1.000	1.278	0.820	0.625	6°				
				1.250	1.538	0.820	0.625	6°				
<p>Thru Coolant Right Hand Shown Left Hand Opposite</p>	DBOMH-12/20M-SDXCR/L-3	60233	60234	0.750	1.125	0.468	0.625	5°	DC_32.52	TS-4.7-10M1	T-15	QCHLS-3MCS
				1.000	1.375	0.468	0.625	5°				
				1.250	1.625	0.468	0.625	5°				

Boring Heads for Solution Tool!™ Quick Change Boring Bar 3/4", to 1 1/4".

Positive Boring Head Specification	Head Description	UPC #		Reference Bar Dia.	B	E	F	K°	Gage Insert	Insert Torx	Torx Key	Locking Head Screw
		R.H.	L.H.									
	DBOMH-12/20M-STUCR/L-2	60255	60256	0.750	1.000	0.820	0.500	6°	TC 21.51	TS-25.45-6M2	T-8	QCHLS-3MCS
				1.000	1.250	0.820	0.500	6°				
				1.250	1.500	0.820	0.500	6°				
	DBOMH-12/20M-STUCR/L-3	60235	60236	0.750	1.090	0.820	0.590	9°	TC 32.52	TS-4.7-10M1	T-15	QCHLS-3MCS
				1.000	1.340	0.820	0.590	9°				
				1.250	1.590	0.820	0.590	9°				
	DBOMH-12/20M-SVUCR/L-2	60237	60238	0.750	1.125	0.820	0.625	8°	VC 221	TS-25.45-8M2	T-8	QCHLS-3MCS
				1.000	1.375	0.820	0.625	8°				
				1.250	1.625	0.820	0.625	8°				
	DBOMH-12/20M-SWLCR/L-3	60241	60242	0.750	1.000	0.820	0.500	8°	WC 32.52	TS-4.7-10M1	T-15	QCHLS-3MCS
				1.000	1.250	0.820	0.500	8°				
				1.250	1.500	0.820	0.500	8°				
Threading Head Specification	Head Description	UPC #		Reference Bar Dia.	B	E	F	Gage Insert	Insert Torx	Torx Key	Locking Head Screw	
		R.H.	L.H.									
	DBOMH-12/20M-SNR/L-16	60243	60244	0.750	1.125	0.820	0.613	Laydown 16-A60	TS-35.6-9M1	T-15	QCHLS-3MCS	
				1.000	1.375	0.820	0.613					
				1.250	1.625	0.820	0.613					

Solution Tool!™ The No! Vibration Re-Tunable Modular Jet-Stream™ Boring Bar

Diameters 1 1/2", 2", 2 1/2", 3" and 4".

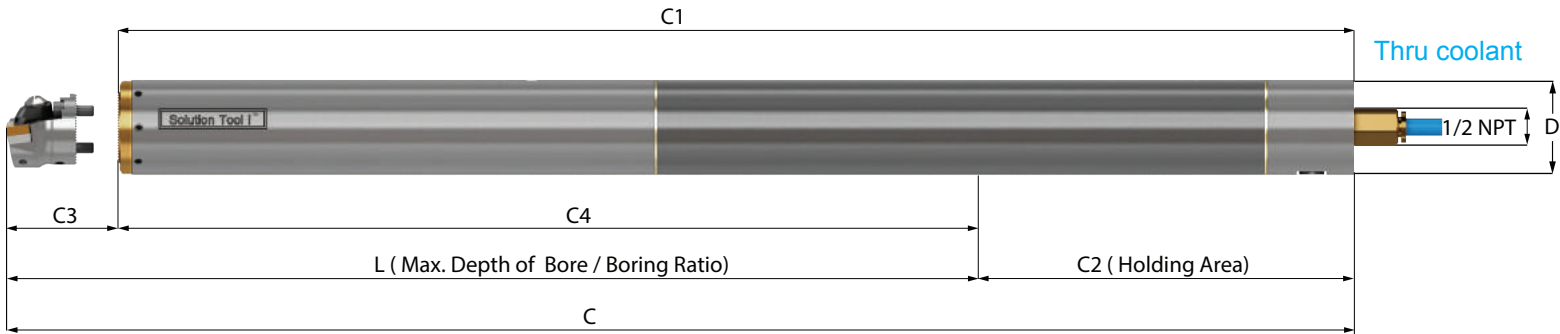

- Deep hole boring made simple
- 8xD, 10xD and 12xD boring (overhang) ratios
- For high material removal rate, high surface finish and tight tolerances
- Bars are pre-tuned at the factory to the specific boring ratio
- Bars can be Re-tuned on the machine to optimize boring performance in challenging applications

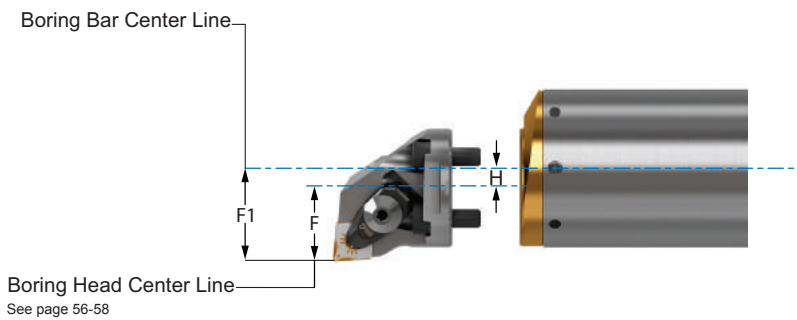

See page 56-58



Bar Description	UPC # Neutral	Boring Ratio	Holding Ratio	Construction	Bar Dia. D	Actual Min. Bore B	F1	H	L	C	C1	C2	C3	C4	Modular Head	Coolant Attachment Thread
ASI24X-8-DVI-MBBB-18-SB	59321	8 x Dia.	4	Steel Body	1.500	B = F + H + (1/2 Bar Dia) Note: Leave enough room for chip evacuation	F1=F+H	0	12.000	18.000	16.500	6.000	1.500	10.500	DBOMH24/40_A_R/L	1/4"-18 NPT
ASI32X-8-DVI-MBBB-24-SB	59323			Steel Body	2.000			0.250	16.000	24.000	22.500	8.000	1.500	14.500		
ASI40X-8-DVI-MBBB-30-SB	59324			Steel Body	2.500			0.500	20.000	30.000	28.500	10.000	1.500	18.500		
ASI48X-8-DVI-MBBB-36-SB	59325			Steel Body	3.000			0.750	24.000	36.000	34.500	12.000	1.500	22.500		
ASI64X-8-DVI-MBBB-48-SB	59326			Steel Body	4.000			1.250	32.000	48.000	46.500	16.000	1.500	30.500		
ASI24X-10-DVI-MBBB-21-SB	59433	10 x Dia.	4	Steel Body	1.500	B = F + H + (1/2 Bar Dia) Note: Leave enough room for chip evacuation	F1=F+H	0	15.000	21.000	19.500	6.000	1.500	13.500	DBOMH24/40_A_R/L	1/4"-18 NPT
ASI32X-10-DVI-MBBB-28-SB	59435			Steel Body	2.000			0.250	20.000	28.000	26.500	8.000	1.500	18.500		
ASI40X-10-DVI-MBBB-35-SB	59436			Steel Body	2.500			0.500	25.000	35.000	33.500	10.000	1.500	23.500		
ASI48X-10-DVI-MBBB-42-SB	59437			Steel Body	3.000			0.750	30.000	42.000	40.500	12.000	1.500	28.500		
ASI64X-10-DVI-MBBB-56-SB	59438			Steel Body	4.000			1.250	40.000	56.000	54.500	16.000	1.500	38.500		
ASI24X-12-DVI-MBBB-24-SB	59446	12 x Dia.	4	Steel Body	1.500	B = F + H + (1/2 Bar Dia) Note: Leave enough room for chip evacuation	F1=F+H	0	18.000	24.000	22.500	6.000	1.500	16.500	DBOMH24/40_A_R/L	1/4"-18 NPT
ASI32X-12-DVI-MBBB-32-SB	59448			Steel Body	2.000			0.250	24.000	32.000	30.500	8.000	1.500	22.500		
ASI40X-12-DVI-MBBB-40-SB	59449			Steel Body	2.500			0.500	30.000	40.000	38.500	10.000	1.500	28.500		
ASI48X-12-DVI-MBBB-48-SB	59450			Steel Body	3.000			0.750	36.000	48.000	46.500	12.000	1.500	34.500		
ASI64X-12-DVI-MBBB-64-SB	59451			Steel Body	4.000			1.250	48.000	64.000	62.500	16.000	1.500	46.500		
ASI24X-14-DVI-MBBB-27-CB	59459	14 x Dia	4	Carbide Body	1.500	B = F + H + (1/2 Bar Dia) Note: Leave enough room for chip evacuation	F1=F+H	0	21.000	27.000	25.500	6.000	1.500	19.500	DBOMH24/40_A_R/L	1/4"-18 NPT
ASI32X-14-DVI-MBBB-36-CB	59461			Carbide Body	2.000			0.250	28.000	36.000	34.500	8.000	1.500	26.500		
ASI40X-14-DVI-MBBB-45-CB	59462			Carbide Body	2.500			0.500	35.000	45.000	43.500	10.000	1.500	33.500		
ASI48X-14-DVI-MBBB-54-CB	59463			Carbide Body	3.000			0.750	42.000	54.000	52.500	12.000	1.500	40.500		
ASI64X-14-DVI-MBBB-72-CB	59464			Carbide Body	4.000			1.250	56.000	72.000	70.500	16.000	1.500	54.500		

Boring Heads for Solution Tool!™ Modular Jet-Stream™ Boring Bar 1/2" to 4" Dia.

Negative Boring Head Specification	Head Description	UPC #		Reference Bar Dia.	B	E	F	K°	Gage Insert	Seat	Seat Screw	Jet-Stream™ Clamp	Clamp Screw	Locking Head Screw for	
		R.H.	L.H.											1.5" Boring Bar	2.0" to 4.0" Boring Bar
<p>Thru Coolant</p> <p>Right Hand Shown Left Hand Opposite</p>	DBOMH-24/40M-ADCLNR/L-4	59507	59508	1.5"/4.0"	1.780	1.515	.940	11°	CN ₄₃₂	DC-432	TS-5.8-10M1	JSLC-HPCTW-4N	JSCS-04	MHLS-5MCS	MHLS-6MCS
	DBOMH-24/40M-ADCLNR/L-5	59509	59510	1.5"/4.0"	2.250	1.715	1.125	11°	CN ₅₄₃	DC-533	TS-5.8-10M1	JSLC-HPC5	JSCS-04		
<p>Thru Coolant</p> <p>Right Hand Shown Left Hand Opposite</p>	DBOMH-24/40M-ADDQNR/L-4	59476	59477	1.5"/4.0"	1.88	1.625	1.125	11°	DN ₄₃₂	DD-432	TS-5.8-10M1	JSLC-HPD4	JSCS-04	MHLS-5MCS	MHLS-6MCS
	DBOMH-24/40M-ADDNNR-4-1250	59565	-	1.5"/4.0"	2.250	1.750	1.250								
<p>Thru Coolant</p> <p>Right Hand Shown Left Hand Opposite</p>	DBOMH-24/40M-ADDNNR-4-1750	59566	-	1.5"/4.0"	2.750	1.750	1.750	10°	DN ₄₃₂	DD-432	TS-5.8-10M1	JSLC-HPD4	JSCS-04	MHLS-5MCS	MHLS-6MCS
	DBOMH-24/40M-ADDNNR-4-2250	59567	-	1.5"/4.0"	3.250	1.750	2.250								
	<p>Thru Coolant</p> <p>Right Hand Shown Left Hand Opposite</p>	DBOMH-24/40M-ADDXNR-4-1250	59571	-	1.5"/4.0"	2.250	.690	1.250							
DBOMH-24/40M-ADDXNR-4-1750		59572	-	1.5"/4.0"	2.750	.690	1.750	10°	DN ₄₃₂	DD-432	TS-5.8-10M1	JSLC-HPD4	JSCS-04	MHLS-5MCS	MHLS-6MCS
DBOMH-24/40M-ADDXNR-4-2250		59573	-	1.5"/4.0"	3.250	.690	2.250								
<p>Thru Coolant</p> <p>Right Hand Shown Left Hand Opposite</p>	DBOMH-24/40M-ADDUNR/L-4	59387	59388	1.5"/4.0"	2.25	1.575	1.125	11°	DN ₄₃₂	DD-432	TS-5.8-10M1	JSLC-HPD4	JSCS-04	MHLS-5MCS	MHLS-6MCS
	<p>Thru Coolant</p> <p>Right Hand Shown Left Hand Opposite</p>	DBOMH-24/40M-ADTUNR/L-3	59515	59516	1.5"/4.0"	2.060	1.575	.890	11°	TN ₃₃₂	DT-322	TS-4.7-10M1	JSLC-HPDT3-BRL	JSCS-03	MHLS-5MCS
DBOMH-24/40M-ADTUNR/L-4		59517	59518	1.5"/4.0"	2.060	1.575	1.125	11°	TN ₄₃₂	DT-432	TS-5.8-10M1	JSLC-HPTW-4R/L	JSCS-04		

Boring Heads for Solution Tool!™ Modular Jet-Stream™ Boring Bar 1/2" to 4" Dia.

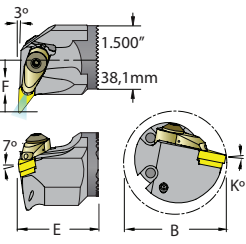
Negative Boring Head Specification	Head Description	UPC #		Reference Bar Dia.	B	E	F	K°	Gage Insert	Seat	Seat Screw	Jet-Stream™ Clamp	Clamp Screw	Locking Head Screw for	
		R.H.	L.H.											1.5" Boring Bar	2.0" to 4.0" Boring Bar
 <p>Thru Coolant Right Hand Shown Left Hand Opposite</p>	DBOMH-24/40M-ADVUNR/L-3	59521	59522	1.5"/4.0"	2.500	1.575	1.312	11°	VN_332	DV-322	TS-4.7-10M1	JSLC-HPV3	JSCS-04	MHLS-5MCS	MHLS-6MCS

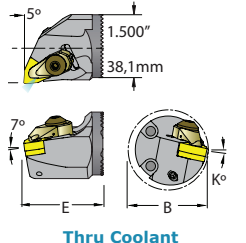
 <p>Thru Coolant Right Hand Shown Left Hand Opposite</p>	DBOMH-24/40M-ADWLNRL-4	59525	59526	1.5"/4.0"	1.900	1.575	.940	11°	WN_432	DW-432	TS-5.8-10M1	JSLC-HPTW-4R/L	JSCS-04	MHLS-5MCS	MHLS-6MCS
---	------------------------	-------	-------	-----------	-------	-------	------	-----	--------	--------	-------------	----------------	---------	-----------	-----------

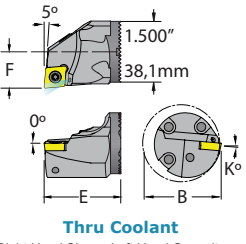
Positive Boring Head Specification	Head Description	UPC #		Reference Bar Dia.	B	E	F	K°	Gage Insert	Insert Screw	Torx Key	Locking Head Screw for	
		R.H.	L.H.									1.5" Boring Bar	2.0" to 4.0" Boring Bar
 <p>Thru Coolant Right Hand Shown Left Hand Opposite</p>	DBOMH-24/40M-ASCLCR/L-4	59529	59530	1.5"/4.0"	1.780	1.575	.920	5°	CC_432	TS-5.8-10M1	T-20	MHLS-5MCS	MHLS-6MCS

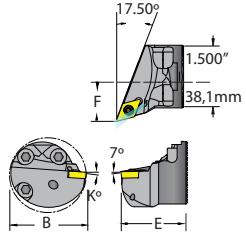
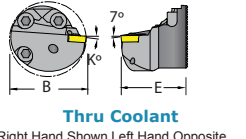
 <p>Thru Coolant Right Hand Shown Left Hand Opposite</p>	DBOMH-24/40M-ASDQCR/L-3	59474	59475	1.5"/4.0"	2.125	1.595	1.06	4°	DC_32.52	TS-4.7-10M1	T-15	MHLS-5MCS	MHLS-6MCS
 <p>Thru Coolant Right Hand Shown Left Hand Opposite</p>	DBOMH-24/40M-ADSQCR/L-4	59389	59390	1.5"/4.0"	2.125	1.595	1.06	4°	DC_432	TS-5.8-10M1	T-20		

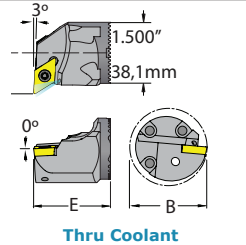
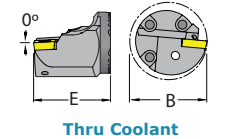
 <p>Thru Coolant Right Hand Shown Left Hand Opposite</p>	DBOMH-24/40M-ASDUCR/L-3	59533	59534	1.5"/4.0"	2.250	1.575	1.125	4°	DC_32.52	TS-4.7-8M1	T-15	MHLS-5MCS	MHLS-6MCS
 <p>Thru Coolant Right Hand Shown Left Hand Opposite</p>	DBOMH-24/40M-ASDUCR/L-4	59535	59536	1.5"/4.0"	2.250	1.575	1.125	4°	DC_432	TS-5.8-10M1	T-20		

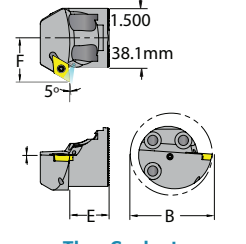
 <p>Thru Coolant Right Hand Shown Left Hand Opposite</p>	DBOMH-24/40M-ASDXCR/L-3	59538	59537	1.5"/4.0"	2.250	1.000	1.125	4°	DC_32.52	TS-4.7-10M1	T-15	MHLS-5MCS	MHLS-6MCS
---	-------------------------	-------	-------	-----------	-------	-------	-------	----	----------	-------------	------	-----------	-----------

Boring Heads for Solution Tool!™ Modular Jet-Stream™ Boring Bar 1/2" to 4" Dia.

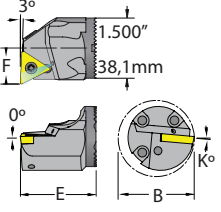
Positive Boring Head Specification	Head Description	UPC #		Reference Bar Dia.	B	E	F	K°	Gage Insert	Insert Screw	Torx Key	Locking Head Screw for	
		R.H.	L.H.									1.5" Boring Bar	2.0" to 4.0" Boring Bar
 <p>Thru Coolant Right Hand Shown Left Hand Opposite</p>	DBOMH-24/40M-ASTUCR/L-3	59539	59540	1.5"/4.0"	1.780	1.575	.890	5°	TC__ 32.52	TS-4.7-8M1	T-15	MHLS-5MCS	MHLS-6MCS
	DBOMH-24/40M-ASTUCR/L-4	59541	59542	1.5"/4.0"	1.780	1.575	.890	5°	TC__ 432	TS-5.8-10M1	T-20		

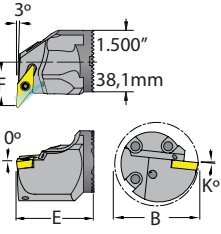
 <p>Thru Coolant Right Hand Shown Left Hand Opposite</p>	DBOMH-24/40M-ASVUCR/L-3	59545	59546	1.5"/4.0"	2.500	1.575	1.200	6°	VC__ 332	TS-4.7-8M1	T-15	MHLS-5MCS	MHLS-6MCS
---	-------------------------	-------	-------	-----------	-------	-------	-------	----	-------------	------------	------	-----------	-----------

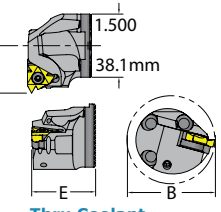
Laydown Threading Head Specification	Head Description	UPC #		Reference Bar Dia.	B	E	F	Gage Insert	Seat	Seat Screw	Chip Flush Nozzle	Locking Head Screw for	
		R.H.	L.H.									1.5" Boring Bar	2.0" to 4.0" Boring Bar
 <p>Thru Coolant Right Hand Shown Left Hand Opposite</p>	DBOMH-24/40M-ADLNR/L-16	59549	59550	1.5"/4.0"	1.870	1.575	.900	Laydown 16-A60	GXE/I-16	TS-35.6-14M1	JSPN-M6	MHLS-5MCS	MHLS-6MCS
	DBOMH-24/40M-ADLNR/L-22	59553	59554	1.5"/4.0"	2.000	1.575	.922	Laydown 22-N60	NXE/I-22	TS-45.75-15M1	JSPN-M6		
	DBOMH-24/40M-ADLNR/L-27	59551	59552	1.5"/4.0"	2.519	1.575	1.575	Laydown 27-Q60	VXE/I-27	TS-5.8-22M1	JSPN-M6	MHLS-5MCS	MHLS-6MCS

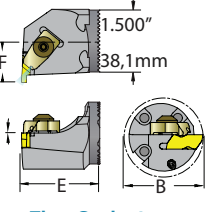
DorNotch Threading Head Specification	Head Description	UPC #		Reference Bar Dia.	B	E	F	Gage Insert	Jet-Stream™ Clamp	Clamp Screw	Chip Flush Nozzle	Locking Head Screw for	
		R.H.	L.H.									1.5" Boring Bar	2.0" to 4.0" Boring Bar
 <p>Thru Coolant Right Hand Shown Left Hand Opposite</p>	DBOMH-24/40M-ADNER/L-3	59557	59558	1.5"/4.0"	2.000	1.575	1.000	DorNotch NG-3L NG-3R	JSLC-HP73 JSLC-HP72	JSCS-04	JSPN-M6	MHLS-5MCS	MHLS-6MCS

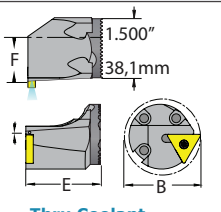
On edge Threading Head Specification	Head Description	UPC #		Reference Bar Dia.	B	E	F	Gage Insert	Jet-Stream™ Clamp	Clamp Screw	Chip Flush Nozzle	Locking Head Screw for	
		R.H.	L.H.									1.5" Boring Bar	2.0" to 4.0" Boring Bar
 <p>Thru Coolant Right Hand Shown Left Hand Opposite</p>	DBOMH-24/40M-ADTHOR/L-4	59561	59562	1.5"/4.0"	2.250	1.575	1.125	TN__ 432	GTS-2	T-20	JSPN-M6	MHLS-5MCS	MHLS-6MCS

THREADING

On Edge - Laydown - DorNotch

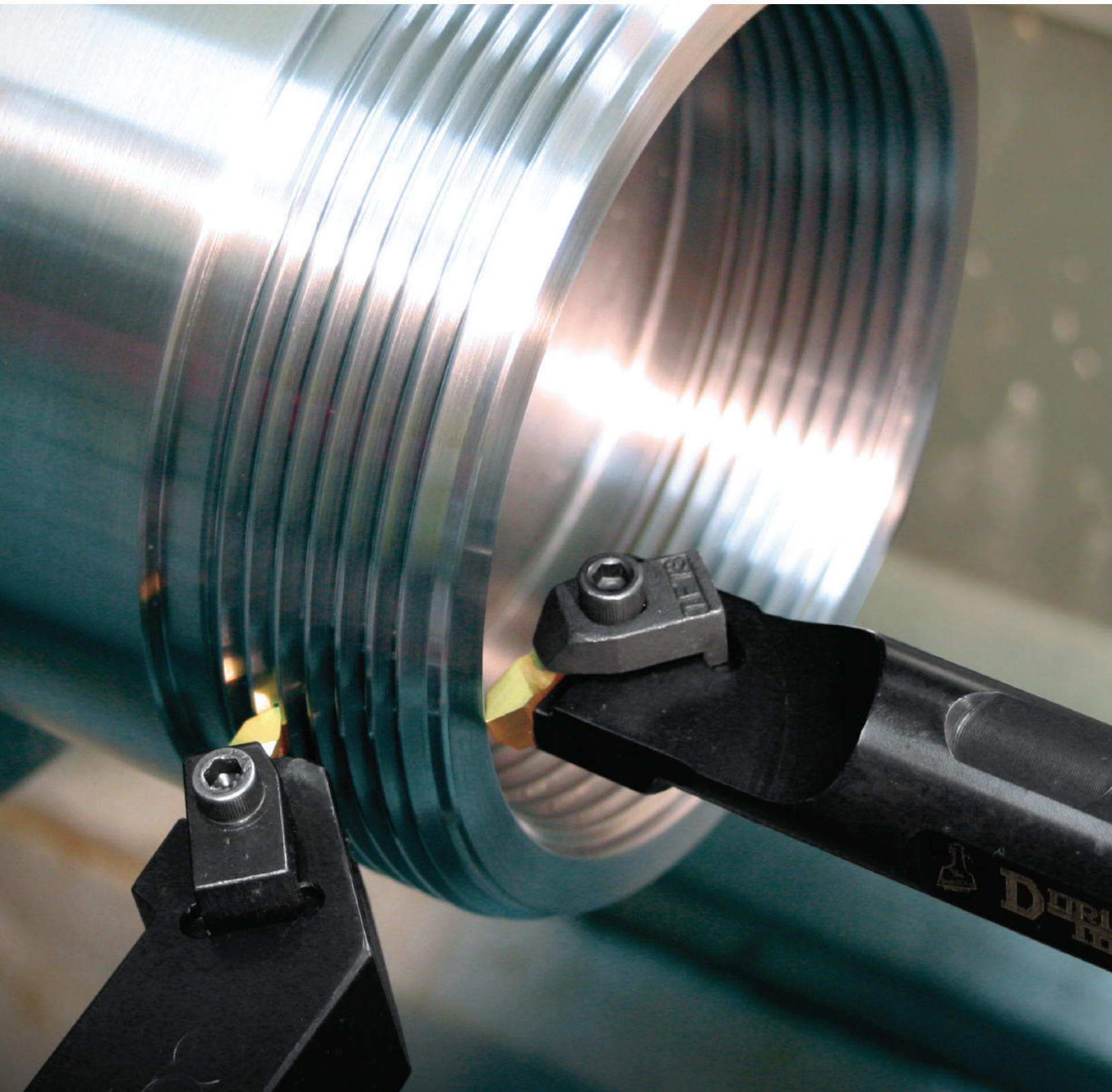

DVK10



Hard and wear resistant C2 substrate with PVD TiN Coating. Very sharp cutting edge. First choice for aluminum and non-ferrous materials.
 Second choice for stainless steels at low SFM.
 Can also be used on cast iron at low SFM.

DVP656

Tough, wear resistant C6 substrate with PVD TiN Coating. Honed edge for edge-security.
 First choice for carbon and alloy steels.

DASK25B

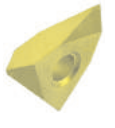
Hard and wear resistant C2 Substrate with PVD TiAlN Coating. Small honed edge provides sharp cutting action and edge security at the same time.
 First choice for stainless steels and high temp alloys.
 Also use on non-ferrous materials except aluminum.
 Second choice for carbon and alloy steels, and cast iron.
 Most universal and general purpose grade for multi-material applications.

	On Edge Threading System: 3 cutting edges. The most economical and popular system. Same insert can be used for external and internal threading, in either right and left hand cutting direction.
	Laydown Threading System: 3 cutting edges. The most compact system. Ideal for ID threading.
	DorNotch Threading System: 2 cutting edges. Most rigid clamping system for high performance threading.

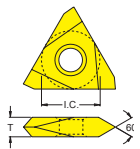
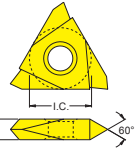
60° On Edge Threading Negative Rake TNMA & TNMC	ANSI Description		DVK10 Grade		DVP656 Grade		DASK25B Grade		Insert Dimensions				
	TNMA	TNMC	TNMA	TNMC	TNMA	TNMC	TNMA	TNMC	I.C.	Thick	Hole Dia.	Rad.	TPI
	TNMA-32NV	TNMC-32NV	72529	72004	72528	72003	72530	72005	.375	.125	.150	.003 .005	8-36
	TNMA-43NV	TNMC-43NV	72536	72008	72535	72010	72537	72011	.500	.187	.203	.003 .005	5-24
	TNMA-43NV .010R	TNMC-43 NV .010R	72543	72018	72542	72017	72544	72019	.500	.187	.203	.010	4-20
	TNMA-54NV	TNMC-54NV	72557	72032	72556	72031	72558	72033	.625	.250	.250	.008 .010	4-20
	TNMA-54NV .010R	TNMC-54NV .010R	72564	72039	72563	72038	72565	72040	.625	.250	.250	.010	4-20
5° Positive Rake TPMA & TPMC	TPMA	TPMC	TPMA	TPMC	TPMA	TPMC	TPMA	TPMC	I.C.	Thick	Hole Dia.	Rad.	TPI
	TPMA-32NV	TPMC-32NV	73394	73056	73393	73055	73395	73057	.375	.125	.150	.003 .005	8-36
	TPMA-43NV	TPMC-43NV	73401	73063	73400	73062	73402	73064	.500	.187	.203	.003 .005	5-24

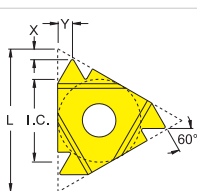
Laydown 60° Partial Profile	Inch Description		DVK10 Grade		DVP656 Grade		Insert Dimensions				Pitch	
	External Right	External Left	External Right	External Left	External Right	External Left	I.C. Inch	L mm	X mm	Y mm	TPI	mm
	11ER-A60	11EL-A60	74001	74005	74000	74004	.250	11	0,8	0,9	16-48	0,5-1,5
	16ER-A60	16EL-A60	74009	74013	74008	74012	.375	16	0,8	0,9	16-48	0,5-1,5
	16ER-G60	16EL-G60	74017	74021	74016	74020	.375	16	1,2	1,7	8-14	1,75-3,0
	16ER-AG60	16EL-AG60	74025	74029	74024	74028	.375	16	1,2	1,7	8-48	0,5-3,0
	22ER-N60	22EL-N60	74033	74037	74032	74036	.500	22	1,7	2,5	5-7	3,5-5,0
	27ER-Q60	27EL-Q60	74045	74049	74044	74048	.625	27	2,1	3,1	4-4,5	5,5-6,0
Internal	Internal Right	Internal Left	Internal Right	Internal Left	Internal Right	Internal Left	I.C. Inch	L mm	X mm	Y mm	TPI	MM
	06IR-A60	06IL-A60	74113	74117	74115	74119	.156	6,9	0,6	0,6	16-48	0,5-1,5
	08IR-A60	08IL-A60	74121	74125	74123	74127	.187	8,7	0,6	0,7	16-48	0,5-1,5
	11IR-A60	11IL-A60	74057	74061	74056	74060	.250	11	0,8	0,9	16-48	0,5-1,5
	16IR-A60	16IL-A60	74065	74069	74064	74068	.375	16	0,8	0,9	16-48	0,5-1,5
	16IR-G60	16IL-G60	74073	74077	74072	74076	.375	16	1,2	1,7	8-14	1,75-3,0
	16IR-AG60	16IL-AG60	74081	74085	74080	74084	.375	16	1,2	1,7	8-48	0,5-3,0
	22IR-N60	22IL-N60	74089	74093	74088	74092	.500	22	1,7	2,5	5-7	3,5-5,0
	27IR-Q60	27IL-Q60	74101	74105	74100	74104	.625	27	2,1	3,1	4-4,5	5,5-6,0

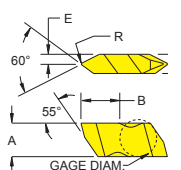
DorNotch 60° Partial Profile NT Negative Rake Angle	ANSI Description		DVK10		DVP656		DASK25B		Insert Dimensions					Pitch				
	NT Right	NT Left	NT Right	NT Left	NT Right	NT Left	NT Right	NT Left	Gage Dia.	A IN	B IN	E IN	R IN	T IN	EXT. IN	INT. IN	EXT. mm	INT. mm
	NT-2R	NT-2L	82901	82905	82900	82904	82902	82906	.1875	.219	.2661	.075	.003 .005	.150	8-36	7-20	0,70	3
	NT-3R	NT-3L	82909	82913	82908	82912	82910	82914	.3750	.344	.3999	.098	.005 .008	.195	6-20	5-12	1,25	4
	NT-4R	NT-4L	82917	82921	82916	82920	82918	82922	.3750	.453	.6239	.128	.005 .008	.255	4-20	4-12	1,00	4

MTVO-A R/L Threading Toolholder- Style V - O.D. Threading and Shallow Grooving for triangle TNMA inserts

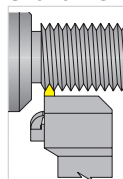

Description	UPC #		Shank			Max. GRV Depth V	TNMA Gage Insert
	Right Hand	Left Hand	Height	Length			
MTVOR/L08-3A-A	58122	58123	0.500	4.000		0.150	322
MTVOR/L08-3B-A	58126	-	0.500	4.500		0.150	
MTVOR/L10-3B-A	58130	-	0.625	4.500		0.150	
MTVOR/L12-3B-A	58134	-	0.750	4.500		0.150	
MTVOR/L16-3D-A	58138	-	1.000	6.000		0.150	432
MTVOR/L12-4B-A	58142	-	0.750	4.500		0.230	
MTVOR/L16-4D-A	58146	58147	1.000	6.000		0.230	
MTVOR/L20-4D-A	58150	58151	1.250	6.000		0.230	
MTVOR/L24-4E-A	58154	-	1.500	7.000		0.230	543
MTVOR/L16-5D-A	58158	58159	1.000	6.000		0.292	
MTVOR/L20-5D-A	58162	58163	1.250	6.000		0.292	
MTVOR/L20-64D-A	58166	-	1.250	6.000		0.360	
MTVOR/L20-66D-A	58170	58171	1.250	6.000		0.360	663

STVO R/L Threading Toolholder- Style V - O.D. Threading and Shallow Grooving for triangle TNMC inserts

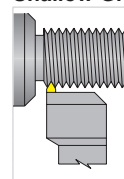

Description	UPC #		Shank			Max. GRV Depth V	TNMC Gage Insert
	Right Hand	Left Hand	Height	Length			
STVOR/L08-3A	58070	-	0.500	4.000		0.150	322
STVOR/L10-3B	58074	58075	0.625	4.500		0.150	
STVOR/L12-3B	58078	58079	0.750	4.500		0.150	
STVOR/L16-3D	58082	58083	1.000	6.000		0.150	
STVOR/L12-4B	58086	58087	0.750	4.500		0.230	432
STVOR/L16-4D	58090	58091	1.000	6.000		0.230	
STVOR/L20-4D	58094	58095	1.250	6.000		0.230	
STVOR/L24-4E	58098	58099	1.500	7.000		0.230	
STVOR/L16-5D	58102	58103	1.000	6.000		0.292	543
STVOR/L20-5D	58106	-	1.250	6.000		0.292	
STVOR/L20-64D	58110	58111	1.250	6.000		0.360	
STVOR/L20-66D	58114	58115	1.250	6.000		0.360	

MTHO-A R/L Threading Toolholder- Style H - Gang Toolholder for Shallow Grooving or I.D. Threading for triangle TNMA inserts

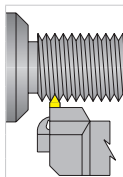

Description	UPC #		Shank		Min. Bore M	Max. GRV Depth V	Min. I.D.	O.D.	TNMA Gage Insert
	Right Hand	Left Hand	Height	Length					
MTHOR/L10-3B	58176	58177	0.625	4.500	2.0	.100	.125	322	
MTHOR/L12-3B	58178	58179	0.750	4.500	3.0	.125	.194	432	
MTHOR/L12-4B	-	58181	0.750	4.500					
MTHOR/L16-4D	58182	-	1.000	6.000	3.0	.170	.242	543	
MTHOR/L16-5D	58186	-	1.000	6.000					
MTHOR/L20-5D	58188	58189	1.250	6.000					

STZO R/L Threading Toolholder-Style Z - Reverse Hand Threading for triangle TNMC inserts

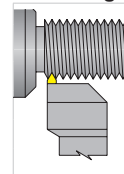

Description	UPC #		Shank			Max. GRV Depth V	TNMC Gage Insert
	Right Hand	Left Hand	Height	Length			
STZOR/L12-3B	58230	-	0.750	4.500		0.150	322
STZOR/L16-3D	-	58235	1.000	6.000		0.150	432
STZOR/L20-4D	58242	-	1.250	6.000		0.230	
STZOR/L16-5D	58246	-	1.000	6.000		0.292	543

MTZOR R/L Threading Toolholder- Style Z - Reverse Hand Threading for triangle TNMA inserts

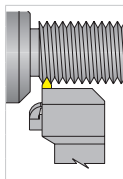

Description	UPC #		Shank			Max. GRV Depth V	TNMA Gage Insert
	Right Hand	Left Hand	Height	Length			
MTZOR/L12-3B	58260	58261	0.750	4.500		0.150	322
MTZOR/L16-4D	58268	-	1.000	6.000		0.230	432
MTZOR/L20-4D	-	58273	1.250	6.000		0.230	
MTZOR/L20-66D	58284	58285	1.250	6.000		0.360	663
MTZOR/L24-66E	58288	-	1.500	7.000		0.360	

S-MTHO-A R/L Threading Bar-Style H - I.D. Threading and Shallow Grooving for triangle TNMA inserts

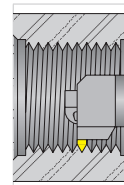

Description	UPC #		Min Bore	Length	Dia.	Max. GRV Depth V	TNMA Gage Insert
	Right Hand	Left Hand					
S16T-MTHOR/L-3-A	58346	-	1.388	12.00	1.000	0.120	322
S20U-MTHOR/L-3-A	58350	58351	1.656	14.00	1.250	0.120	432
S20U-MTHOR/L-4-A	58354	58355	1.812	14.00	1.250	0.190	
S24U-MTHOR/L-4-A	58358	58359	2.250	14.00	1.500	0.190	
S32V-MTHOR/L-4-A	58362	58363	3.000	16.00	2.000	0.190	
S32V-MTHOR/L-5-A	58366	58367	3.500	16.00	2.000	0.250	543
S40V-MTHOR/L-5-A	58370	58371	3.750	16.00	2.500	0.250	
S48Y-MTHOR/L-5-A	58374	58375	4.000	18.00	3.000	0.250	
S40V-MTHOR/L-66-A	58378	58379	4.000	16.00	2.500	0.312	
S48Y-MTHOR/L-66-A	-	58383	4.500	18.00	3.000	0.312	663

MTVO-CN R/L Threading Toolholder- Style V - O.D. Threading and Shallow Grooving for triangle TNMC inserts

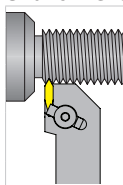

Description	UPC #		Shank			Max. GRV Depth V	TNMC Gage Insert
	Right Hand	Left Hand	Height	Length			
MTVOR/L08-3A-CN	58012	58013	0.500	4.000		0.150	322
MTVOR/L08-3B-CN	58016	58017	0.500	4.500		0.150	
MTVOR/L10-3B-CN	58020	58021	0.625	4.500		0.150	
MTVOR/L12-3B-CN	58024	58025	0.750	4.500		0.150	
MTVOR/L16-3D-CN	58028	58029	1.000	6.000		0.150	432
MTVOR/L12-4B-CN	58032	58033	0.750	4.500		0.230	
MTVOR/L16-4D-CN	58036	58037	1.000	6.000		0.230	
MTVOR/L20-4D-CN	58040	58041	1.250	6.000		0.230	
MTVOR/L24-4E-CN	58044	58045	1.500	7.000		0.230	543
MTVOR/L16-5D-CN	58048	58049	1.000	6.000		0.292	
MTVOR/L20-5D-CN	58052	58053	1.250	6.000		0.292	

S-MTHO-C R/L Threading Bar- Style H - I.D. Threading and Shallow Grooving for triangle TNMC inserts

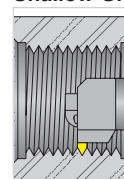

Description	UPC #		Min Bore	Length	Dia.	Max. GRV Depth V	TNMC Gage Insert
	Right Hand	Left Hand					
S16T-MTHOR/L-3-C	58300	-	1.388	12.00	1.000	0.120	322
S20U-MTHOR/L-3-C	58304	-	1.656	14.00	1.250	0.120	432
S20U-MTHOR/L-4-C	58308	58309	1.812	14.00	1.250	0.190	
S24U-MTHOR/L-4-C	58312	58313	2.250	14.00	1.500	0.190	
S32V-MTHOR/L-4-C	58316	58317	3.000	16.00	2.000	0.190	
S32V-MTHOR/L-5-C	58320	58321	3.500	16.00	2.000	0.250	543
S40V-MTHOR/L-5-C	58324	-	3.750	16.00	2.500	0.250	
S40V-MTHOR/L-66-C	58332	58333	4.000	16.00	2.500	0.312	

STHO R/L Threading Toolholder- Style H - Gang Toolholder for Shallow Grooving for I.D. Threading for triangle TNMC inserts

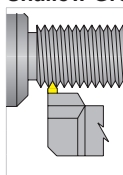

Description	UPC #		Shank		Min. Bore M	Max. GRV Depth V	Min. I.D.	O.D.	TNMC Gage Insert
	Right Hand	Left Hand	Height	Length					
STHOR/L10-3B	58196	-	0.625	4.500	2.0	0.100	0.125	322	
STHOR/L12-3B	-	58201	0.750	4.500	3.0	0.125	0.194	432	
STHOR/L12-4B	-	58205	0.750	4.500					
STHOR/L16-4D	58208	58209	1.000	6.000					

SE R/L Threading Toolholder- Style E- Laydown for LAYDOWN inserts

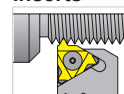

Description	UPC #		Shank			Laydown Gage Insert
	Right Hand	Left Hand	Height	Length		
SER/L037-3-11	58420	-	0.375	3.000		11-A60
SER/L062-4-16	-	58429	0.625	4.000		16-G60
SER/L075-5-16	58432	-	0.750	5.000		
SER/L100-5-16	58436	-	1.000	5.000		
SER/L125-6-22	58444	58445	1.250	6.000		
SER/L100-6-27	-	58449	1.000	6.000		27-Q60
SER/L125-6-27	58452	58453	1.250	6.000		

SE Gang R/L Threading Toolholder- Style EG - Gang Toolholder for Gang Toolposts for LAYDOWN inserts

Description	UPC #		Shank		Laydown Gage Insert
	Right Hand	Left Hand	Height	Length	
SEGR/L037-4-11	58466	58467	0.375	4.000	11-A60
SEGR/L050-5-16	58470	-	0.500	5.000	16-G60
SEGR/L062-5-16	58474	58475	0.625	5.000	
SEGR/L075-5-16	58478	58479	0.750	5.000	

SE R/L Qualified Threading Toolholder- Style - Laydown Offset Head for LAYDOWN inserts

Description	UPC #		Shank		Laydown Gage Insert
	Right Hand	Left Hand	Height	Length	
SER/L050-4-11Q	58488	58489	0.500	4.000	11-A60
SER/L075-5-16Q	58492	-	0.750	5.000	16-G60
SER/L100-6-16Q	58496	-	1.000	6.000	
SER/L125-6-16Q	58500	-	1.250	6.000	
SER/L100-6-22Q	-	58505	1.000	6.000	
SER/L125-6-22Q	58508	-	1.250	6.000	22-N60
SER/L125-6-27Q	58511	58512	1.250	6.000	27-Q60

SE R/L Qualified Threading Toolholder- Style - Drop Head for LAYDOWN inserts

Description	UPC #		Shank		Laydown Gage Insert
	Right Hand	Left Hand	Height	Length	
SER/L075-6-16CQ	-	58523	0.750	6.000	16-G60
SER/L100-6-16CQ	58526	58527	1.000	6.000	
SER/L125-6-16CQ	58530	-	1.250	6.000	

SN R/L Threading Bar- Style - Internal Small Shank Laydown Bar for LAYDOWN inserts

Description	UPC #		Min Bore	Shank		Laydown Gage Insert
	Right Hand	Left Hand		Length	Dia.	
SNR/L037-40-11	58600	58601	0.500	4.000	0.375	11-A60
SNR/L050-55-11	58604	58605	0.600	5.500	0.500	16-G60
SNR/L062-60-16	58608	58609	0.750	6.000	0.625	
SNR/L075-70-16	58612	58613	0.950	7.000	0.750	
SNR/L100-80-16	58616	-	1.150	8.000	1.000	
SNR/L075-70-22	58620	-	0.900	7.000	0.750	22-N60
SNR/L100-80-22	58624	58625	1.500	8.000	1.000	

SN R/L Threading Bar- Style - Internal Laydown Bar for LAYDOWN inserts

Description	UPC #		Min Bore	Shank		Laydown Gage Insert
	Right Hand	Left Hand		Length	Dia.	
SNR/L075-07-16	58636	58637	0.950	7.00	0.750	16-G60
SNR/L100-08-16	58640	58641	1.150	8.00	1.000	
SNR/L125-10-16	58644	58645	1.400	10.00	1.250	
SNR/L150-12-16	58648	58649	1.700	12.00	1.500	
SNR/L200-14-16	58656	58657	2.200	14.00	2.000	
SNR/L125-10-22	58664	-	1.500	10.00	1.250	
SNR/L150-12-22	58668	-	1.800	12.00	1.500	
SNR/L175-14-22	58672	-	2.100	14.00	1.750	
SNR/L200-14-22	58676	-	2.300	14.00	2.000	
SNR/L250-16-22	58680	58681	2.800	16.00	2.500	
SNR/L150-12-27	58684	-	1.900	12.00	1.500	27-Q60
SNR/L250-16-27	58692	-	2.900	16.00	2.500	

SN R/L Threading Bar- Style - Internal Laydown Miniature Threading Bar for LAYDOWN inserts

Description	UPC #		Min Bore	Shank		Laydown Gage Insert
	Right Hand	Left Hand		Length	Dia.	
SNR/L0265-K08	58578	58579	0.307	5.000	0.625	08-A60

NS R/L Threading & Grooving Toolholder- Style - External DorNotch Toolholder for threading and grooving DorNotch inserts

Description	UPC #		Shank		DorNotch Gage Insert
	Right Hand	Left Hand	Height	Length	
NSR/L06-2	58770	58771	0.375	2.500	NG-2R NG-2L
NSR/L08-2J	58774	58775	0.500	3.500	
NSR/L10-2B	58778	58779	0.625	4.500	
NSR/L12-2B	58782	58783	0.750	4.500	
NSR/L16-2C	58786	-	1.000	5.000	NG-3R NG-3L
NSR/L12-3A	58790	-	0.750	4.000	
NSR/L12-3B	58794	58795	0.750	4.500	
NSR/L16-3C	58798	58799	1.000	5.000	
NSR/L16-3D	58802	58803	1.000	6.000	NG-4R NG-4L
NSR/L20-3D	58806	58807	1.250	6.000	
NSR/L16-4C	58810	58811	1.000	5.000	
NSR/L16-4D	58814	58815	1.000	6.000	
NSR/L20-4C	-	58819	1.250	5.000	NG-4R
NSR/L20-4D	58822	58823	1.250	6.000	

NE R/L Threading & Grooving Toolholder- Style - Gang External DorNotch Toolholder for threading and grooving DorNotch inserts

Description	UPC #		Shank		DorNotch Gage Insert
	Right Hand	Left Hand	Height	Length	
NER/L06-2	-	58901	0.375	2.500	NG-2L NG-2R
NER/L08-2J	58904	58905	0.500	3.500	
NER/L12-2B	58912	-	0.750	4.500	NG-3L NG-3R
NER/L12-3B	58916	-	0.750	4.500	
NER/L16-3D	58920	58921	1.000	6.000	
NER/L16-4D	58928	58929	1.000	6.000	
NER/L20-4D	58932	58933	1.250	6.000	NG-4R

NR R/L Grooving Gang Toolholder- Style - Corner Grooving External DorNotch Toolholder for grooving DorNotch inserts

Description	UPC #		Shank		DorNotch Gage Insert
	Right Hand	Left Hand	Height	Length	
NRR/L12-3B	58942	-	0.750	4.500	NG-3L NG-3R
NRR/L16-3C	-	58945	1.000	5.000	
NRR/L16-3D	58946	-	1.000	6.000	
NRR/L20-3D	58948	58949	1.250	6.000	
NRR/L24-3D	58950	58951	1.500	6.000	

S-NE R/L Threading & Grooving Bar - Style - Internal DorNotch Bar for threading and grooving DorNotch inserts

Description	UPC #		Min Bore	Shank		DorNotch Gage Insert
	Right Hand	Left Hand		Length	Dia.	
S10S-NER/L-2	58970	58971	1.000	10.00	10.00	NG-2L
S12S-NER/L-2	58974	58975	1.125	10.00	10.00	NG-2R
S16T-NER/L-3	58978	58979	1.375	12.00	12.00	NG-3L NG-3R
S20U-NER/L-3	58982	58983	1.750	14.00	14.00	
S24U-NER/L-3	58986	58987	2.000	14.00	14.00	
S28U-NER/L-3	58990	-	2.250	14.00	14.00	
S28U-NER/L-4	58994	-	2.500	14.00	14.00	NG-4L
S32V-NER/L-4	58998	58999	2.750	16.00	16.00	NG-4R

KOOL CUT™

MODULAR TURNING & GROOVING SYSTEM

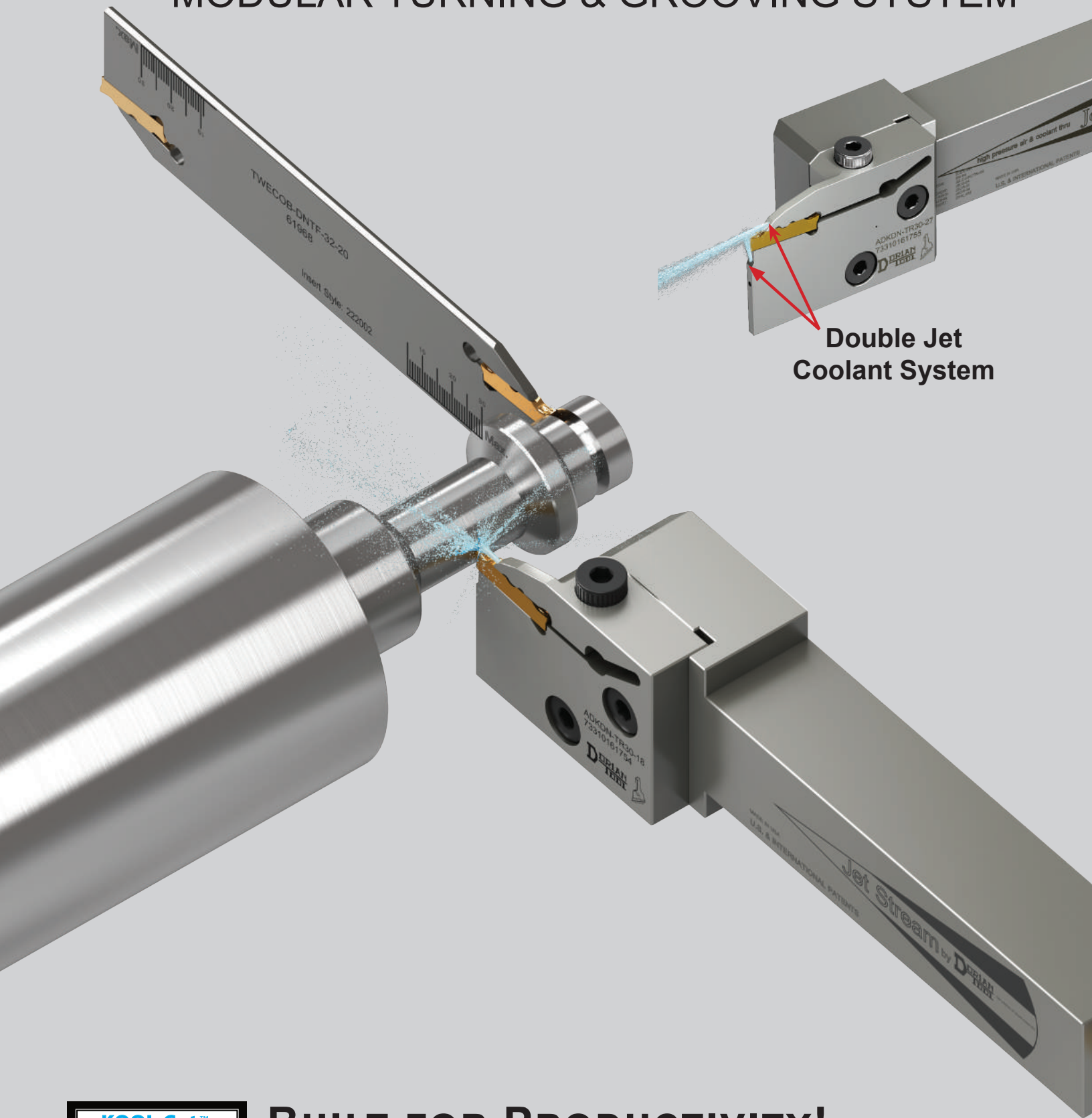

**Double Jet
Coolant System**



BUILT FOR PRODUCTIVITY!

Interchangeable Shanks & Cartridges Technology

Right Hand KOOL Cut™ Modular Turning and Grooving Straight Toolholders

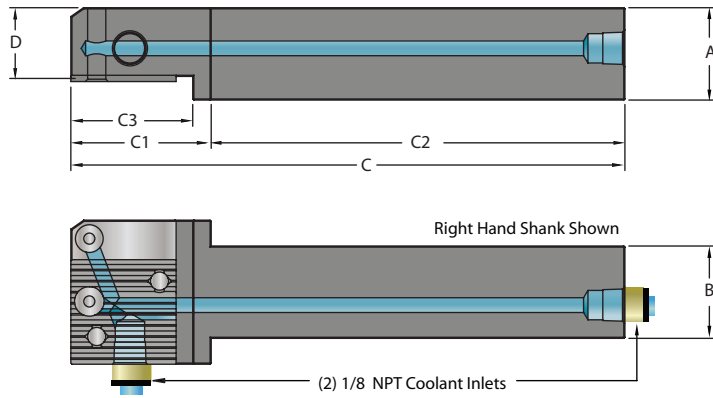
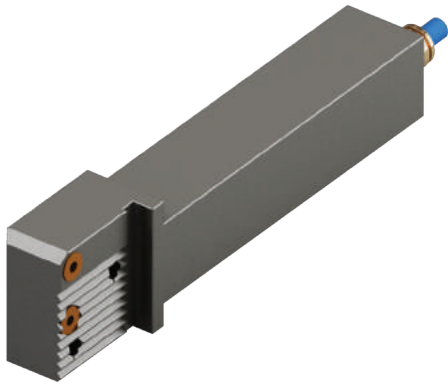

Shank Description	UPC #	Shank Size	A	B	D	C	C1	C2	C3
ADDN-MTR-12-C	61987	3/4"	0.750	0.750	0.59	5.00	1.50	3.50	1.30
ADDN-MTR-16-D	61988	1"	1.000	1.000	0.79	5.50	1.50	4.00	1.30
ADDN-MTR-20-E	61989	1 1/4"	1.250	1.250	1.06	6.00	1.50	4.50	1.30

Right Hand KOOL Cut™ Modular Turning and Grooving 90° Gang Toolholders

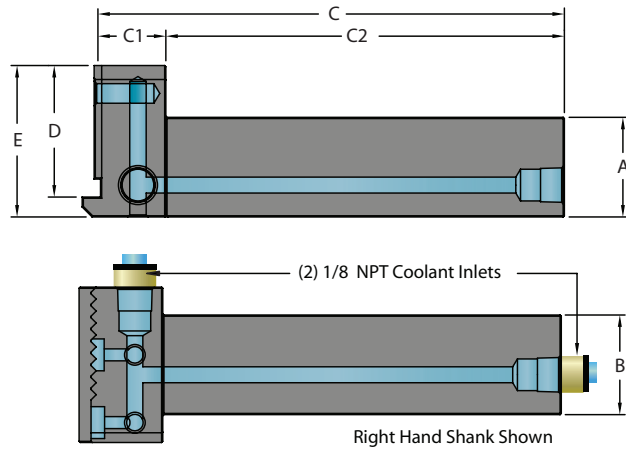

Shank Description	UPC #	Shank Size	A	B	D	E	C	C1	C2
ADDN-MGR-12-C	61996	3/4"	0.750	0.750	1.30	1.50	4.21	0.71	3.50
ADDN-MGR-16-D	61997	1"	1.000	1.000	1.30	1.50	4.71	0.71	4.00
ADDN-MGR-20-E	61998	1 1/4"	1.250	1.250	1.30	1.50	5.21	0.71	4.50

Right Hand Cartridges for Right Hand Toolholders

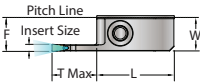

.079" Insert Size Right Hand Cartridge KOOL Cut™ Modular Turning and Grooving

Description	UPC #	T. Max (in)	L (in)	F (in)	W (in)	Insert Width	Insert Style	Insert Lock Screw	Cartridge Lock Screw	Hex Key	Coolant Seal
ADKDN-TR20-06	61750	0.236	1.299	0.598	0.591	.079"	DNTQ-22 2002-3EU-N DNPG-22 2002-1SR-N	CS-M0616	CS-M0620	HAHK-50	CS08-04
ADKDN-TR20-12	61751	0.472	1.299	0.598	0.591	.079"					
ADKDN-TR20-18	61752	0.709	1.299	0.598	0.591	.079"					

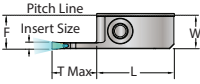

.118" Insert Size Right Hand Cartridge KOOL Cut™ Modular Turning & Grooving

Description	UPC #	T. Max (in)	L (in)	F (in)	W (in)	Insert Width	Insert Style	Insert Lock Screw	Cartridge Lock Screw	Hex Key	Coolant Seal
ADKDN-TR30-09	61753	0.354	1.299	0.606	0.591	.118"	DNTQ-22 3003-3EU-N DNTR-22 3015-3EU-N DNPG-22 3002-1SR-N	CS-M0616	CS-M0620	HAHK-50	CS08-04
ADKDN-TR30-18	61754	0.709	1.299	0.606	0.591	.118"					
ADKDN-TR30-27	61755	1.063	1.299	0.606	0.591	.118"					

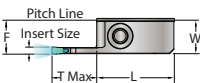

.157" Insert Size Right Hand Cartridge KOOL Cut™ Modular Turning and Grooving

Description	UPC #	T. Max (in)	L (in)	F (in)	W (in)	Insert Width	Insert Style	Insert Lock Screw	Cartridge Lock Screw	Hex Key	Coolant Seal
ADKDN-TR40-12	61756	0.472	1.299	0.606	0.591	.157"	DNTQ-25 4004-3EU-N DNTR-25 4020-3EU-N DNPG-25 4003-1SR-N	CS-M0616	CS-M0620	HAHK-50	CS08-04
ADKDN-TR40-18	61757	0.709	1.299	0.606	0.591	.157"					
ADKDN-TR40-24	61758	0.945	1.299	0.606	0.591	.157"					
ADKDN-TR40-30	61759	1.181	1.299	0.606	0.591	.157"					

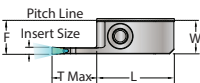

.197" Insert Size Right Hand Cartridge KOOL Cut™ Modular Turning and Grooving

Description	UPC #	T. Max (in)	L (in)	F (in)	W (in)	Insert Width	Insert Style	Insert Lock Screw	Cartridge Lock Screw	Hex Key	Coolant Seal
ADKDN-TR50-10	61760	0.394	1.299	0.610	0.591	.197"	DNTQ-25 5004-3EU-N DNTR-25 5025-3EU-N DNPG-25 5004-1SR-N	CS-M0616	CS-M0620	HAHK-50	CS08-04
ADKDN-TR50-15	61761	0.591	1.299	0.610	0.591	.197"					
ADKDN-TR50-25	61762	0.984	1.299	0.610	0.591	.197"					
ADKDN-TR50-40	61763	1.575	1.299	0.610	0.591	.197"					

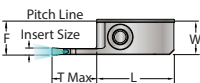

.236" Insert Size Right Hand Cartridge KOOL Cut™ Modular Turning and Grooving

Description	UPC #	T. Max (in)	L (in)	F (in)	W (in)	Insert Width	Insert Style	Insert Lock Screw	Cartridge Lock Screw	Hex Key	Coolant Seal
ADKDN-TR60-12	61764	0.472	1.299	0.610	0.591	.236"	DNTQ-25 6004-3EU-N DNPG-25 6004-1SR-N	CS-M0616	CS-M0620	HAHK-50	CS08-04
ADKDN-TR60-18	61765	0.709	1.299	0.610	0.591	.236"					
ADKDN-TR60-30	61766	1.181	1.299	0.610	0.591	.236"					
ADKDN-TR60-48	61767	1.890	1.299	0.610	0.591	.236"					

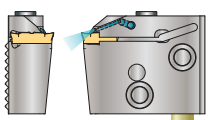
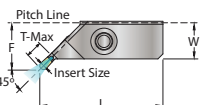

.079" Insert Size Right Hand Cartridge KOOL Cut™ Modular 45° Grooving

Description	UPC #	T. Max (in)	L (in)	F (in)	W (in)	Insert Width	Insert Style	Insert Lock Screw	Cartridge Lock Screw	Hex Key	Coolant Seal
ADKDN-UR30-06	61911	0.236	1.299	0.945	0.591	.118"	DNTR-223015	CS-M0616	CS-M0620	HAHK-50	CS08-04
ADKDN-UR40-08	61912	0.315	1.299	1.024	0.591	.157"	DNTR-254020				
ADKDN-UR50-10	61913	0.394	1.299	1.063	0.591	.197"	DNTR-255025				

Left Hand KOOL Cut™ Modular Turning and Grooving Straight Toolholders

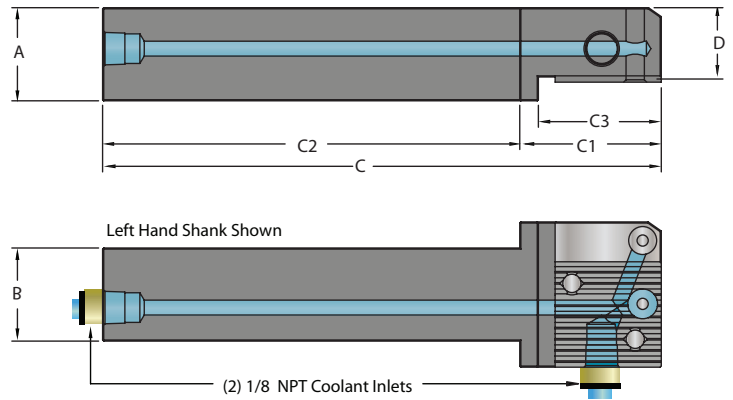

Shank Description	UPC #	Shank Size	A	B	D	C	C1	C2	C3
ADDN-MTL-12-C	61990	3/4"	0.750	0.750	0.59	5.00	1.50	3.50	1.30
ADDN-MTL-16-D	61991	1"	1.000	1.000	0.79	5.50	1.50	4.00	1.30
ADDN-MTL-20-E	61992	1 1/4"	1.250	1.250	1.06	6.00	1.50	4.50	1.30

Left Hand KOOL Cut™ Modular Turning and Grooving 90° Gang Toolholders

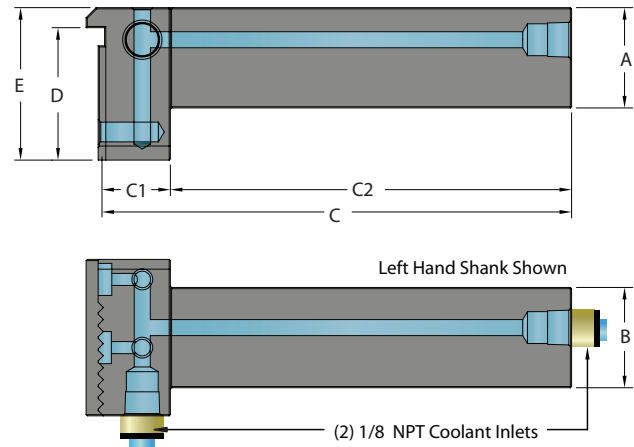

Shank Description	UPC #	Shank Size	A	B	D	C	C1	C2
ADDN-MGL-12-C	61993	3/4"	0.750	0.750	1.30	4.21	0.71	3.50
ADDN-MGL-16-D	61994	1"	1.000	1.000	1.30	4.71	0.71	4.00
ADDN-MGL-20-E	61995	1 1/4"	1.250	1.250	1.30	5.21	0.71	4.50

Left Hand Cartridges for Left Hand Toolholders

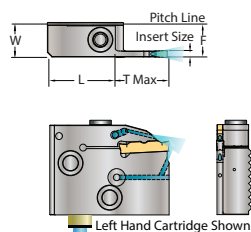

.079" Insert Size Left Hand Cartridge KOOL Cut™ Modular Turning and Grooving

Description	UPC #	T. Max (in)	L (in)	F (in)	W (in)	Insert Width	Insert Style	Insert Lock Screw	Cartridge Lock Screw	Hex Key	Coolant Seal
ADKDN-TL20-06	61768	0.236	1.299	0.598	0.591	.079"	DNTQ-22 2002-3EU-N DNPG-22 2002-1SR-N	CS-M0616	CS-M0620	HAHK-50	CS08-04
ADKDN-TL20-12	61769	0.472	1.299	0.598	0.591	.079"					
ADKDN-TL20-18	61770	0.709	1.299	0.598	0.591	.079"					

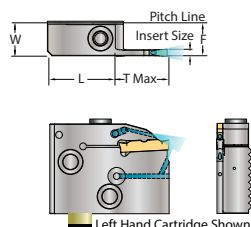

.118" Insert Size Left Hand Cartridge KOOL Cut™ Modular Turning and Grooving

Description	UPC #	T. Max (in)	L (in)	F (in)	W (in)	Insert Width	Insert Style	Insert Lock Screw	Cartridge Lock Screw	Hex Key	Coolant Seal
ADKDN-TL30-09	61771	0.354	1.299	0.602	0.591	.118"	DNTQ-22 3003-3EU-N DNTR-22 3015-3EU-N DNPG-22 3002-1SR-N	CS-M0616	CS-M0620	HAHK-50	CS08-04
ADKDN-TL30-18	61772	0.709	1.299	0.602	0.591	.118"					
ADKDN-TL30-27	61773	1.063	1.299	0.602	0.591	.118"					

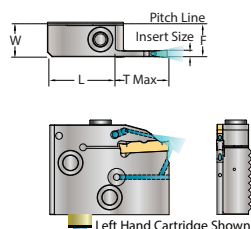

.157" Insert Size Left Hand Cartridge KOOL Cut™ Modular Turning and Grooving

Description	UPC #	T. Max (in)	L (in)	F (in)	W (in)	Insert Width	Insert Style	Insert Lock Screw	Cartridge Lock Screw	Hex Key	Coolant Seal
ADKDN-TL40-12	61774	0.472	1.299	0.606	0.591	.157"	DNTQ-25 4004-3EU-N DNTR-25 4020-3EU-N DNPG-25 4003-1SR-N	CS-M0616	CS-M0620	HAHK-50	CS08-04
ADKDN-TL40-18	61775	0.709	1.299	0.606	0.591	.157"					
ADKDN-TL40-24	61776	0.945	1.299	0.606	0.591	.157"					
ADKDN-TL40-30	61777	1.181	1.299	0.606	0.591	.157"					

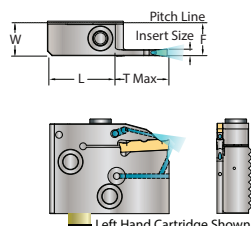

.197" Insert Size Left Hand Cartridge KOOL Cut™ Modular Turning and Grooving

Description	UPC #	T. Max (in)	L (in)	F (in)	W (in)	Insert Width	Insert Style	Insert Lock Screw	Cartridge Lock Screw	Hex Key	Coolant Seal
ADKDN-TL50-10	61778	0.394	1.299	0.610	0.591	.197"	DNTQ-25 5004-3EU-N DNTR-25 5025-3EU-N DNPG-25 5004-1SR-N	CS-M0616	CS-M0620	HAHK-50	CS08-04
ADKDN-TL50-15	61779	0.591	1.299	0.610	0.591	.197"					
ADKDN-TL50-25	61780	0.984	1.299	0.610	0.591	.197"					
ADKDN-TL50-40	61781	1.575	1.299	0.610	0.591	.197"					

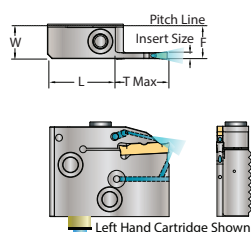

.236" Insert Size Left Hand Cartridge KOOL Cut™ Modular Turning and Grooving

Description	UPC #	T. Max (in)	L (in)	F (in)	W (in)	Insert Width	Insert Style	Insert Lock Screw	Cartridge Lock Screw	Hex Key	Coolant Seal
ADKDN-TL60-12	61782	0.472	1.299	0.610	0.591	.236"	DNTQ-25 6004-3EU-N DNPG-25 6004-1SR-N	CS-M0616	CS-M0620	HAHK-50	CS08-04
ADKDN-TL60-18	61783	0.709	1.299	0.610	0.591	.236"					
ADKDN-TL60-30	61784	1.181	1.299	0.610	0.591	.236"					
ADKDN-TL60-48	61785	1.890	1.299	0.610	0.591	.236"					

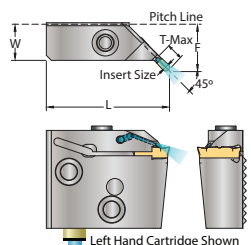

.079" Insert Size Left Hand Cartridge KOOL Cut™ Modular 45° Grooving

Description	UPC #	T. Max (in)	L (in)	F (in)	W (in)	Insert Width	Insert Style	Insert Lock Screw	Cartridge Lock Screw	Hex Key	Coolant Seal
ADKDN-UL30-06	61916	0.236	1.299	0.945	0.591	.118"	DNTR-22 3015-3EU-N	CS-M0616	CS-M0620	HAHK-50	CS08-04
ADKDN-UL40-08	61917	0.315	1.299	1.024	0.591	.157"	DNTR-25 4020-3EU-N				
ADKDN-UL50-10	61918	0.394	1.299	1.063	0.591	.197"	DNTR-25 5025-3EU-N				

Left Hand Face Grooving Cartridges for Left Hand Toolholders (.118" Insert Size)

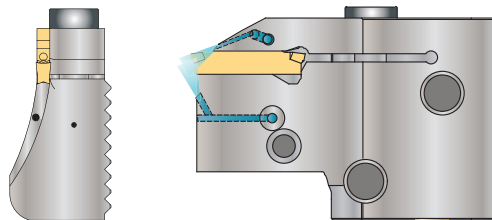
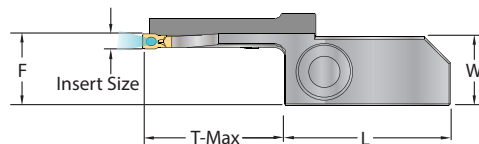
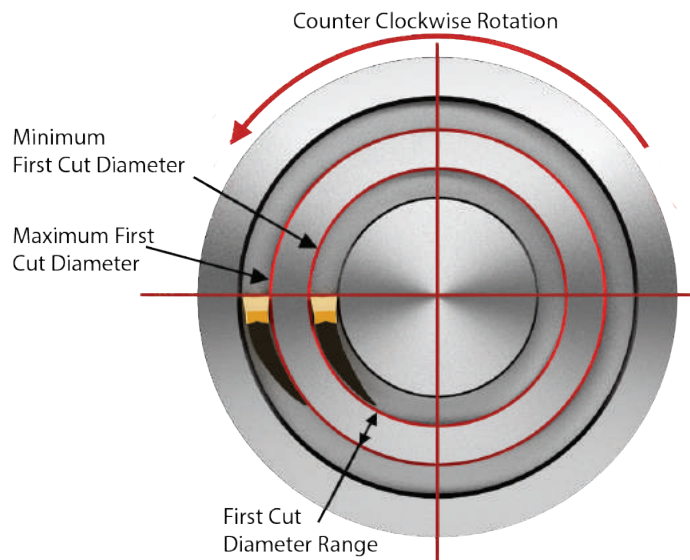

Left Hand Cartridge Shown

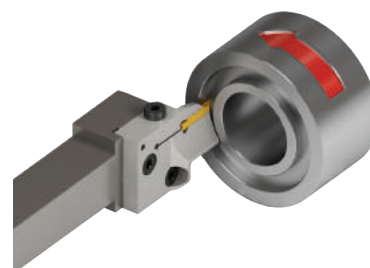

T-Max 0.472"

Description	UPC #	First Cut Diameter		T. Max (in)	L (in)	F (in)	W (in)	Insert Width	Insert Style	Insert Lock Screw	Cartridge Lock Screw	Hex Key	Coolant Seal
		Min. (in)	Max. (in)										
ADCDN-FL30-022030-12	62208	0.866	1.181	0.472	1.299	0.630	0.591	.118"	DNTQ-22 3003-3EU-N DNTR-22 3015-3EU-N DNPG-22 3002-1SR-N	CS-M0616	CS-M0620	HAHK-50	CS08-04
ADCDN-FL30-030038-12	62209	1.181	1.496	0.472	1.299	0.630	0.591	.118"					
ADCDN-FL30-038048-12	62210	1.496	1.890	0.472	1.299	0.630	0.591	.118"					
ADCDN-FL30-048060-12	62211	1.890	2.362	0.472	1.299	0.630	0.591	.118"					
ADCDN-FL30-060075-12	62212	2.362	2.953	0.472	1.299	0.630	0.591	.118"					
ADCDN-FL30-075100-12	62213	2.953	3.937	0.472	1.299	0.630	0.591	.118"					
ADCDN-FL30-100200-12	62214	3.937	7.874	0.472	1.299	0.630	0.591	.118"					
ADCDN-FL30-200300-12	62215	7.874	11.811	0.472	1.299	0.630	0.591	.118"					
ADCDN-FL30-300->-12	62216	11.811	>	0.472	1.299	0.630	0.591	.118"					

T. Max 0.709"

ADCDN-FL30-060075-18	62217	2.362	2.953	0.709	1.299	0.630	0.591	.118"	DNTQ-22 3003-3EU-N DNTR-22 3015-3EU-N DNPG-22 3002-1SR-N	CS-M0616	CS-M0620	HAHK-50	CS08-04
ADCDN-FL30-075100-18	62218	2.953	3.937	0.709	1.299	0.630	0.591	.118"					
ADCDN-FL30-100200-18	62219	3.937	7.874	0.709	1.299	0.630	0.591	.118"					
ADCDN-FL30-200300-18	62220	7.874	11.811	0.709	1.299	0.630	0.591	.118"					
ADCDN-FL30-300->-18	62221	11.811	>	0.709	1.299	0.630	0.591	.118"					

T. Max 0.945"

ADCDN-FL30-100200-24	62222	3.937	7.874	0.945	1.299	0.630	0.591	.118"	DNTQ-22 3003-3EU-N DNTR-22 3015-3EU-N DNPG-22 3002-1SR-N	CS-M0616	CS-M0620	HAHK-50	CS08-04
ADCDN-FL30-200300-24	62223	7.874	11.811	0.945	1.299	0.630	0.591	.118"					
ADCDN-FL30-300->-24	62224	11.811	>	0.945	1.299	0.630	0.591	.118"					

Left Hand Face Grooving Cartridges for Left Hand Toolholders (.236" Insert Size)

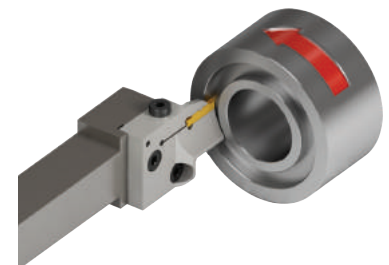
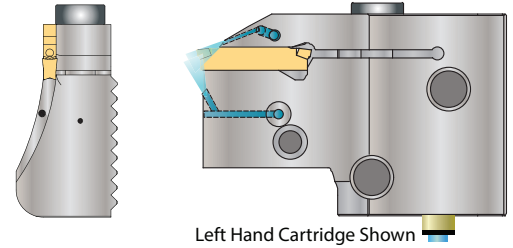
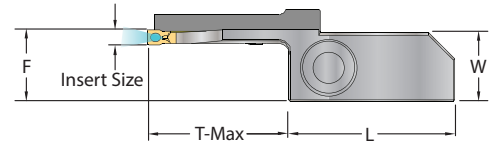
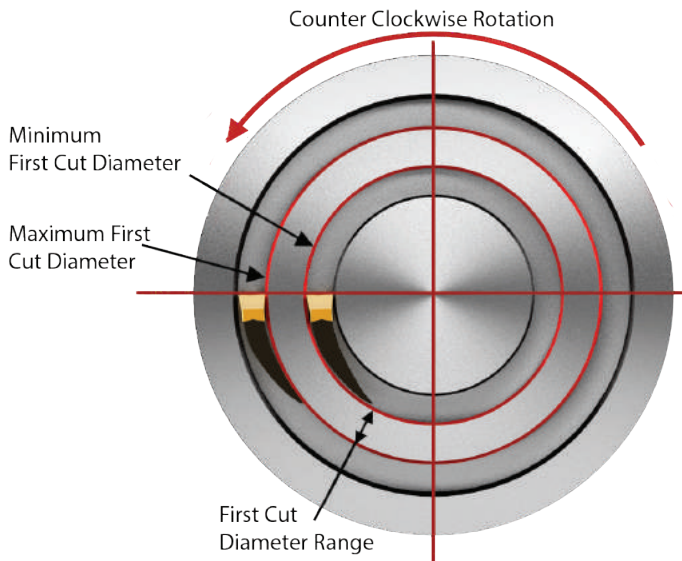

T-Max 0.512"

Description	UPC #	First Cut Diameter Min. (in)	First Cut Diameter Max. (in)	T. Max (in)	L (in)	F (in)	W (in)	Insert Width	Insert Style	Insert Lock Screw	Cartridge Lock Screw	Hex Key	Coolant Seal
ADCDN-FL60-050075-13	62253	1.969	2.953	0.512	1.299	0.630	0.591	.236"	DNTQ-256004-3EU-N DNTR-256030-3EU-N	CS-M0616	CS-M0620	HAHK-50	CS08-04
ADCDN-FL60-075130-13	62254	2.953	5.118	0.512	1.299	0.630	0.591	.236"					
ADCDN-FL60-130300-13	62255	5.118	11.811	0.512	1.299	0.630	0.591	.236"					
ADCDN-FL60-300500-13	62256	11.811	19.685	0.512	1.299	0.630	0.591	.236"					
ADCDN-FL60-500>-13	62257	19.685	>	0.512	1.299	0.630	0.591	.236"					

T-Max 1.024"

ADCDN-FL60-075130-26	62258	2.953	5.118	1.024	1.299	0.630	0.591	.236"	DNTQ-256004-3EU-N DNTR-256030-3EU-N	CS-M0616	CS-M0620	HAHK-50	CS08-04
ADCDN-FL60-130300-26	62259	5.118	11.811	1.024	1.299	0.630	0.591	.236"					
ADCDN-FL60-300500-26	62260	11.811	19.685	1.024	1.299	0.630	0.591	.236"					
ADCDN-FL60-500>-26	62261	19.685	>	1.024	1.299	0.630	0.591	.236"					



T-Max 1.535"

ADCDN-FL60-075130-39	62262	2.953	5.118	1.535	1.299	0.630	0.591	.236"	DNTQ-256004-3EU-N DNTR-256030-3EU-N	CS-M0616	CS-M0620	HAHK-50	CS08-04
ADCDN-FL60-130300-39	62263	5.118	11.811	1.535	0.000	0.000	0.591	.236"					
ADCDN-FL60-300500-39	62264	11.811	19.685	1.535	1.299	0.630	0.591	.236"					
ADCDN-FL60-500>-39	62265	19.685	>	1.535	1.299	0.630	0.591	.236"					

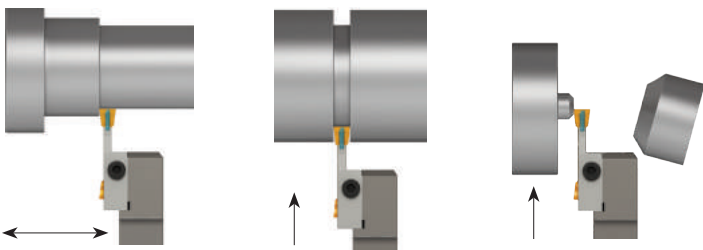
Turning & Grooving Insert Grades

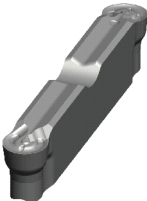
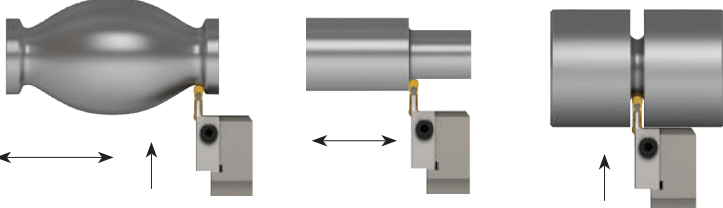
Insert Specification					Insert Application				
Double-End Cutting Edge DNTQ-N- DUP35UG Neutral Straight Nose Multi-Cutting Direction Right Hand and Left Hand									
Turning Grooving Parting-Off									
Cutting Data					Insert Geometry, Material Application				
Insert Dimension			Maximum a_p Depth of Cut for Turning	Maximum f_n Feed Rate for Turning, Grooving and Parting-off	Steel	Stainless Steel	Cast Iron	Non Ferrous	Super Alloys
Width	Length	Radius	inch	in/rev.	●	●	●	○	○
.079" (2mm)	.866"	.002"	.039"	.006 in/rev	●	●	●	○	○
.118" (3mm)	.866"	.003"	.059"	.008 in/rev	●	●	●	○	○
.157" (4mm)	.984"	.004"	.079"	.009 in/rev	●	●	●	○	○
.197" (5mm)	.984"	.004"	.098"	.010 in/rev	●	●	●	○	○
.236" (6mm)	.984"	.004"	.118"	.012 in/rev	●	●	●	○	○

Insert Specification					Insert Application				
Double-End Cutting Edge DNTR-N- DUP35UG Neutral Round Nose Multi-Cutting Direction Right Hand and Left Hand									
Profiling Turning Grooving									
Cutting Data					Insert Geometry, Material Application				
Insert Dimension			Maximum a_p Depth of Cut for Turning	Maximum f_n Feed Rate for Turning, Grooving and Parting-off	Steel	Stainless Steel	Cast Iron	Non Ferrous	Super Alloys
Width	Length	Radius	inch	in/rev.	●	●	●	○	○
.118" (3mm)	.866"	.059" (1.5mm)	.059"	.012 in/rev	●	●	●	○	○
.157" (4mm)	.984"	.079" (2.0mm)	.079"	.014 in/rev	●	●	●	○	○
.197" (5mm)	.984"	.098" (2.5mm)	.098"	.016 in/rev	●	●	●	○	○

Insert Specification					Insert Application				
Double-End Cutting Edge DNPG-N- DPP40SG Neutral Straight Nose Uni-Direction Parting Off & Grooving									
Grooving Parting-Off									
Cutting Data					Insert Geometry, Material Application				
Insert Dimension			Maximum f_n Feed Rate for Parting-off		Steel	Stainless Steel	Cast Iron	Non Ferrous	Super Alloys
Width	Length	Radius		in/rev.	●	●	●	○	○
.079" (2mm)	.866"	.002"		.006 in/rev	●	●	●	○	○
.118" (3mm)	.866"	.003"		.008 in/rev	●	●	●	○	○
.157" (4mm)	.984"	.004"		.009 in/rev	●	●	●	○	○
.197" (5mm)	.984"	.004"		.010 in/rev	●	●	●	○	○
.236" (6mm)	.984"	.004"		.012 in/rev	●	●	●	○	○

Turning & Grooving Insert Grades

DUP35UG					
Material		V _c (SFM)			
Steel		F/min.		m/min.	
P	Carbon Steel	363	627	110	190
	Low Alloy Steel	363	594	110	180
	High Temp Alloys	231	528	70	160
M	Ferritic	396	660	120	200
	Austenitic	330	561	100	170
	Duplex	231	363	70	110
	Martensitic	198	297	60	90
K	Gray Cast Iron	330	660	100	200
	Modular Cast Iron	330	594	100	180
	Malleable Cast Iron	264	528	80	160
N	Unleaded Copper	373	825	113	250
	Brass	663	1472	201	446
	Unleaded Bronze	287	495	87	150
S	Iron Base	86	172	26	52
	Nickel Base	53	116	16	35
	Titanium	198	429	60	130

DPP40SG					
Material		V _c (SFM)			
Steel		F/min.		m/min.	
P	Carbon Steel	264	495	80	150
	Low Alloy Steel	231	396	70	120
	High Temp Alloys	198	330	60	100
M	Ferritic	330	594	100	180
	Austenitic	264	495	80	150
	Duplex	231	363	70	110
	Martensitic	198	297	60	90
K	Gray Cast Iron	264	561	80	170
	Modular Cast Iron	297	495	90	150
	Malleable Cast Iron	231	462	70	140
N	Unleaded Copper				
	Brass				
	Unleaded Bronze				
S	Iron Base				
	Nickel Base				
	Titanium				

DUP35UG	HC-P25/M25 K30 N30 S30	Coated	PVD-TiAlN 4µm
Insert Characteristics	Hard, Wear, Abrasive and Impact Resistant		
First Choice Application	Universal Multi Purpose Turning and Grooving Application; for carbon steel, alloy steel, stainless steel, cast iron, high-temp alloys & non-ferrous materials		
Cutting Speed SFM (Vc)	High Cutting Speed in stable turning and grooving conditions, light interrupted cut		
Cutting Condition	Wet		

DPP40SG	HC-P45/M45	Multi Coated	PVD-TiAlN 7µm
Insert Characteristics	Extremely Tough and Impact Resistant Substrate		
First Choice Application	For Heavy or Interrupted Part Off and Grooving Applications; for Forgings and Castings of Carbon Steel, Alloy Steel, Stainless Steel and Cast Iron		
Cutting Speed SFM (Vc)	Low to Medium Cutting Speed in unstable conditions and heavy interrupted cut		
Cutting Condition	Wet		

Insert Specifications

"T" Square Nose

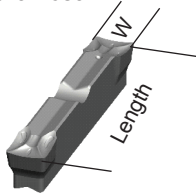

UPC #	Application	Part Number	Insert Size		Radius	Grade
			Width	Length		
82440	Turning Grooving Parting-Off	DNTQ-22 2002-3EU-N DUP25UG	.079" (2mm)	.866"	.002"	DUP35UG
82442		DNTQ-22 3003-3EU-N DUP25UG	.118" (3mm)	.866"	.003"	DUP35UG
82443		DNTQ-25 4004-3EU-N DUP25UG	.157" (4mm)	.984"	.004"	DUP35UG
82444		DNTQ-25 5004-3EU-N DUP25UG	.197" (5mm)	.984"	.004"	DUP35UG
82445		DNTQ-25 6004-3EU-N DUP25UG	.236" (6mm)	.984"	.004"	DUP35UG

"R" Round Nose

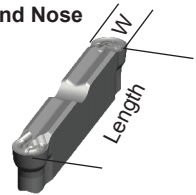

UPC #	Application	Part Number	Insert Size		Radius	Grade
			Width	Length		
82459	Profiling Turning Grooving	DNTR-22 3015-3EU-N DUP25UG	.118" (3mm)	.866"	.059" (1.5mm)	DUP35UG
82460		DNTR-25 4020-3EU-N DUP25UG	.157" (4mm)	.984"	.079" (2.0mm)	DUP35UG
82461		DNTR-25 5025-3EU-N DUP25UG	.197" (5mm)	.984"	.098" (2.5mm)	DUP35UG

"G" Square Nose

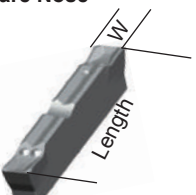

UPC #	Application	Part Number	Insert Size		Radius	Grade
			Width	Length		
82475	Grooving Parting-Off	DNPG-22 2002-1SR-N DPP40SG	.079" (2mm)	.866"	.002"	DPP40SG
82476		DNPG-22 3002-1SR-N DPP40SG	.118" (3mm)	.866"	.003"	DPP40SG
82477		DNPG-25 4003-1SR-N DPP40SG	.157" (4mm)	.984"	.004"	DPP40SG
82478		DNPG-25 5004-1SR-N DPP40SG	.197" (5mm)	.984"	.004"	DPP40SG
82479		DNPG-25 6004-1SR-N DPP40SG	.236" (6mm)	.984"	.004"	DPP40SG

Kool Cut™ Twin Edge Parting-Off Insert Blades *Neutral*

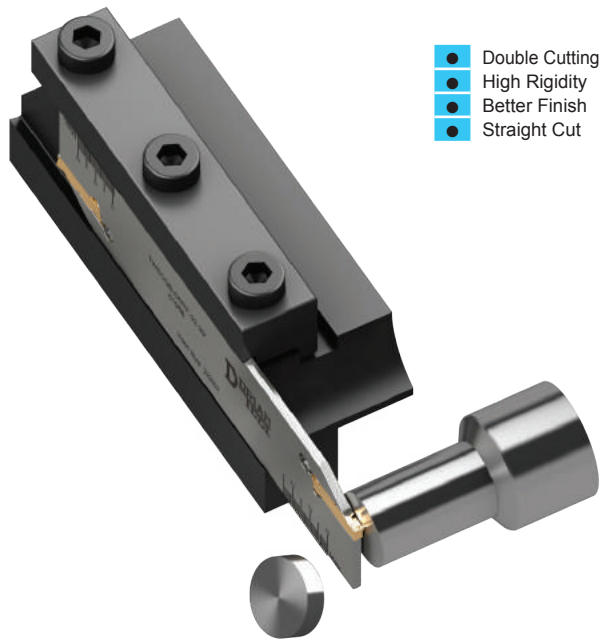

- Double Cutting Edge
- High Rigidity
- Better Finish
- Straight Cut

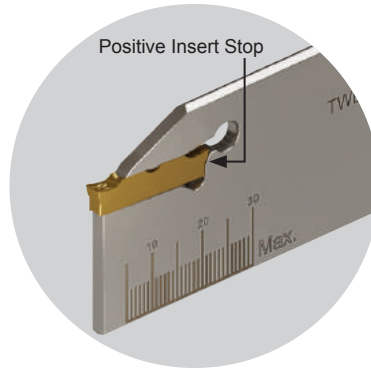

Double "V"
Locking System

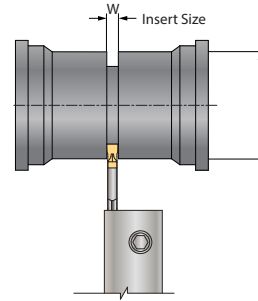
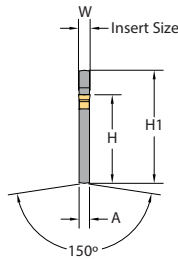
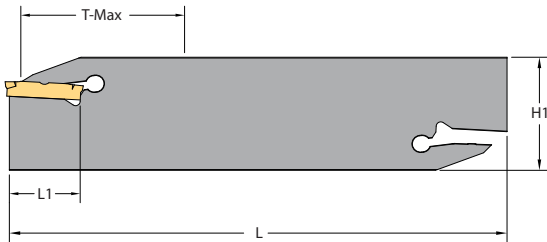

Insert Extraction Key
Sold Separately

19mm (3/4") Twin Edge Blades

Blades Description	UPC #	T. Max	A	D	L	L1	H	H1	Insert Description	Insert Width	Insert Extraction Key Description	UPC #
TWECOB-DNTF-19-20	61973	.785	0.063	1.570	3.380	0.866	0.618	0.750	DNTQ-22 2002-3EU-N	0.079	KCIK-DN	61204
									DNPG-22 2002-1SR-N			

26mm (1") Twin Edge Blades

Blades Description	UPC #	T. Max	A	D	L	L1	H	H1	Insert Description	Insert Width	Insert Extraction Key Description	UPC #
TWECOB-DNTF-26-20	61965	1.000	0.063	2.000	4.331	0.866	0.842	1.024	DNTQ-22 2002-3EU-N DNPG-22 2002-1SR-N	0.079	KCIK-DN	61204
TWECOB-DNTF-26-30	61966	1.550	0.094	3.100	4.331	0.866	0.842	1.024	DNTQ-22 3003-3EU-N	0.118		
									DNTR-22 3015-3EU-N			
									DNPG-22 3002-1SR-N			
TWECOB-DNTF-26-40	61967	1.650	0.125	3.300	4.331	0.866	0.842	1.024	DNTQ-25 4004-3EU-N	0.157		
									DNTR-25 4020-3EU-N			
									DNPG-25 4003-1SR-N			

32mm (1 1/4") Twin Edge Blades

Blades Description	UPC #	T. Max	A	D	L	L1	H	H1	Insert Description	Insert Width	Insert Extraction Key Description	UPC #
TWECOB-DNTF-32-20	61968	1.150	0.063	2.300	5.906	0.866	0.984	1.260	DNTQ-22 2002-3EU-N	0.079	KCIK-DN	61204
									DNPG-22 2002-1SR-N			
TWECOB-DNTF-32-30	61969	1.750	0.094	3.500	5.906	0.866	0.984	1.260	DNTQ-22 3003-3EU-N	0.118		
									DNTR-22 3015-3EU-N			
									DNPG-22 3002-1SR-N			
TWECOB-DNTF-32-40	61970	1.950	0.125	3.900	5.906	0.984	0.984	1.260	DNTQ-25 4004-3EU-N	0.157		
									DNTR-25 4020-3EU-N			
									DNPG-25 4003-1SR-N			
TWECOB-DNTF-32-50	61971	2.350	0.157	4.700	5.906	0.984	0.984	1.260	DNTQ-25 5004-3EU-N	0.197		
									DNTR-25 5025-3EU-N			
									DNPG-25 5004-1SR-N			
TWECOB-DNTF-32-60	61972	2.750	0.203	5.500	5.906	0.984	0.984	1.260	DNTQ-25 6004-3EU-N	0.236		
									DNPG-25 6004-1SR-N			

POSITIVE STOP BLADES FOR CUT-OFF & GROOVING SGTN INSERTS

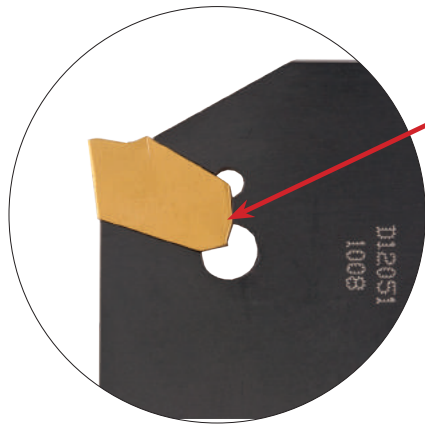

Positive Stop

Improved design featuring a "Positive Stop". Inserts are securely held in Slot Grip Positive Stop Blades by a tapered locking system featuring a "Positive Stop" that prevents insert drift and the blade pocket from spreading once the insert is firmly in place.

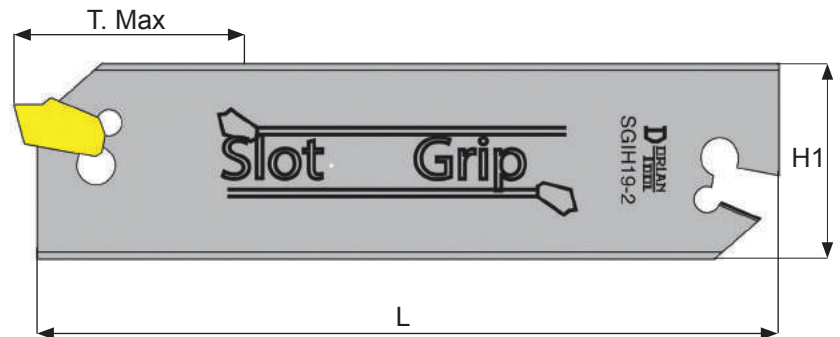
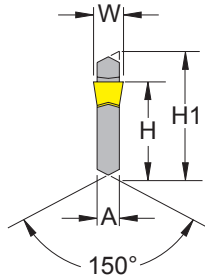
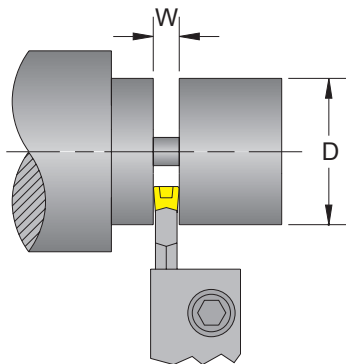

Designed for use with standard SGTN cut-off inserts and standard cut-off blade holders. The insert's cutting edge location repeats accurately and as a result prevents insert splitting under heavy feed and shock loads. The blade and insert geometry allows free chip flow, minimizing insert breakage due to chip build-up.

19mm (3/4") Slot Grip Blades

Blades Description	UPC #	T. Max	A	D	L	H	H1	Insert Description	Insert Width
SGIH19-2	62950	0.785	0.063	1.570	3.380	0.618	0.750	SGT(N/R/L)-2	.079"

26mm (1") Slot Grip Blades

SGIH26-2	62951	1.000	0.063	2.000	4.330	0.842	1.020	SGT(N/R/L)-2	.079"
SGIH26-3	62952	1.500	0.094	3.000				SGT(N/R/L)-3	.118"
SGIH26-4	62953	1.575	0.125	3.150				SGT(N/R/L)-4	.157"

32mm (1 1/4") Slot Grip Blades

SGIH32-3	62956	1.970	0.094	3.940	5.900	0.984	1.250	SGT(N/R/L)-3	.118"
SGIH32-4	62957	1.970	0.125	3.940				SGT(N/R/L)-4	.157"
SGIH32-5	62958	2.355	0.156	4.710				SGT(N/R/L)-5	.197"
SGIH32-6	62959	2.355	0.203	4.710				SGT(N/R/L)-6	.236"
SGIH32-8	62960	2.755	0.268	5.510				SGT(N/R/L)-8	.315"
SGIH32-9	62961	2.755	0.312	5.510				SGT(N/R/L)-9	.354"

For Slot Grip Cut Off inserts see complete Kool Cut Catalog

SGTBN Neutral Hand Cut-Off Toolholder for Cut-Off SGIH blades

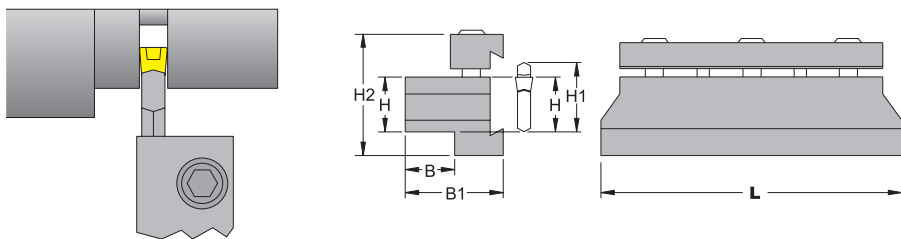

The two piece clamp style of this tool provides a precise and rigid blade locking and easy mounting of the tool into CNC turrets. Simple block design accommodates Slot Grip, Kool-Cut, and competitive blade systems. SGTBN toolholders come in a broad selection of shank sizes.

Description	UPC # Neutral	H	H1	H2	B	B1	L	Blade Used	Screw used
SGTBN12,7-2	62970	0.500	0.750	1.375	0.500	1.000	3.00	SGIH19-2	ASHCSFP-050-080-025-MA
SGTBN16-2	62971	0.625	0.750	1.375	0.625	1.000	3.00		
SGTBN16-5	62972	0.625	1.020	1.750	0.625	1.250	3.50	SGIH26-2 Thru SGIH26-6	ASHCSFP-060-100-030-MA
SGTBN19-5	62973	0.750	1.020	2.000	0.750	1.375	3.50		
SGTBN19-6	62974	0.750	1.250	2.000	0.750	1.375	4.50	SGIH32-3 Thru SGIH32-9	ASHCSFP-060-100-030-MA
SGTBN25,4-6	62975	1.000	1.250	2.125	0.875	1.500	4.50		
SGTBN31,8-6	62976	1.250	1.250	2.375	1.125	1.750	4.50		
SGTBN38,1-6	62977	1.500	1.250	2.875	1.625	2.250	4.50		

SGTHR/L Cut-Off Toolholder for Cut-Off SGTN inserts

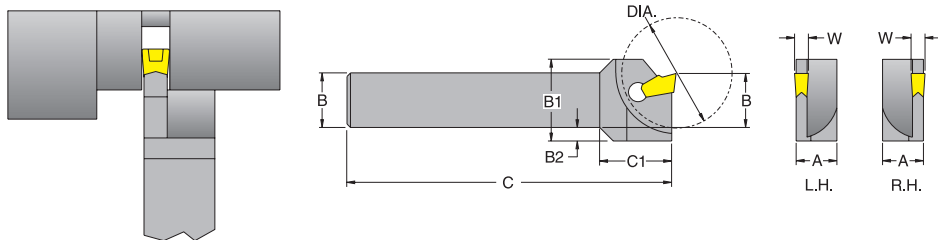

The square shank design of the Cut-Off toolholder ensures a precise center line of the insert with respect to the center of the work-piece, when the toolholder is mounted directly on the CNC turret. Inserts are securely held in Slot Grip blades by a tapered locking system. No additional clamping devices are required. Slot Grip Cut-Off toolholders come in a broad selection of shank sizes.

Description	UPC #		A	B	B1	B2	C	C1	Max. Dia	W	Insert used
	R.H.	L.H.									
SGTHR/L-9,5-2	63000	63001	0.375	0.375	0.750	0.187	3.375	0.703	1.109	0.087 & 0.930	SGTN/R/L-2,2,4
SGTHR/L-12,7-2	63002	63003	0.391	0.500	0.828	0.156	4.328	0.703	1.172	0.087 & 0.930	
SGTHR/L-16-2	-	63005	0.391	0.625	0.750	-	4.328	0.703	1.172	0.087 & 0.930	
SGTHR/L-19-2	63006	63007	0.469	0.750	0.937	-	4.328	0.781	1.266	0.087 & 0.930	
SGTHR/L-19,5-3	63008	63009	0.375	0.375	0.750	0.187	3.375	0.703	1.109	0.120	SGTN/R/L-3
SGTHR/L-12,7-3	63010	63011	0.391	0.500	0.828	0.237	4.328	0.828	1.266	0.120	
SGTHR/L-16-3	63012	63013	0.469	0.625	0.937	0.156	4.328	0.828	1.266	0.120	
SGTHR/L-19-3	63014	63015	0.469	0.750	0.937	-	4.328	0.828	1.406	0.120	
SGTHR/L-25,4-3	63016	-	0.984	1.000	1.187	-	5.875	0.984	2.062	0.120	SGTN/R/L-4
SGTHR/L-16-4	63018	63019	0.469	0.625	0.937	0.156	4.328	0.828	1.328	0.160	
SGTHR/L-19-4	63020	63021	0.469	0.750	0.937	-	4.328	0.906	1.531	0.160	
SGTHR/L-25,4-4	63022	63023	0.984	1.000	1.187	-	5.875	1.187	2.500	0.160	
SGTHR/L-19-5	63024	63025	0.469	0.750	0.937	-	4.328	0.906	1.531	0.187 & 0.200	SGTN/R/L-4,8-5
SGTHR/L-25,4-5	63026	-	0.984	1.000	1.187	-	5.875	1.600	3.000	0.187 & 0.200	

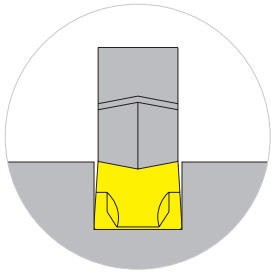

Cut-Off & Grooving Inserts are designed for use with standard cut-off inserts and standard cut-off blade holders. The insert's cutting edge location repeats accurately and as a result prevents insert splitting under heavy feed and shock loads. The blade and insert geometry permits free chip flow, minimizing insert breakage due to chip build-up.





Chip breaker Geometry

- Reduced machining force
- Controlled, coiled chip flow
- Higher material removal rate

Application

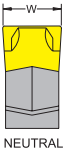
- Quickly inserted into adjustable blades
- For cut-off and grooving
- Fair for interrupted cuts

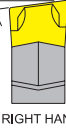
Material	Insert Grade
Carbon & Alloy Steel	P35
Aluminum & Non-Ferrous Metals & Materials	K25 N25
Carbon & Alloy Steel	K25 P25 M25
300 & 400 Series Stainless Steel	
Cast Iron, Copper/Brass	
Aluminum & Non-Ferrous Materials	
High Temp Alloys	
Hard Steel to 58 HRC	

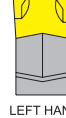
Insert Grade		Insert Coating				DC656	DK25	DASK25B
Insert Grade		Dimensions				UPC #	UPC #	UPC #
Description	ANSI	Insert Size mm	Lead Angle	Width + 0,05		UPC #	UPC #	UPC #
				inch	mm			
SGTN Neutral  	SGTN-2	2	0°	.087	2	82222	82220	82223
	SGTN-2.4	2,4	0	.094	2,4	82306	82304	82307
	SGTN-3	3	0°	.122	3	82226	82224	82227
	SGTN-4	4	0°	.161	4	82230	82228	82231
	SGTN-4.8	4,8	0	.189	4,8	82318	82316	82319
	SGTN-5	5	0°	.201	5	82234	82232	82235
	SGTN-6	6	0°	.252	6	82238	82236	82239
	SGTN-8	8	0°	.315	8	82242	-	-
	SGTN-9	9	0°	.378	9	82246	82244	82247
SGTR Right Hand  	SGTR-2-8	2	8°	.087	2	82250	82248	82251
	SGTR-2.4-8	2,4	8	.094	2,4	82310	82308	82311
	SGTR-3-8	3	8°	.122	3	82254	82252	82255
	SGTR-4-8	4	8°	.161	4	82258	82256	82259
	SGTR-4.8-8	4,8	8	.189	4,8	82322	82320	82323
	SGTR-5-8	5	8°	.201	5	82262	82260	82263
	SGTR-6-8	6	8°	.252	6	82266	-	-
	SGTR-9-8	9	8°	.378	9	82274	-	-
SGTL Left Hand  	SGTL-2-8	2	8°	.087	2	82278	82276	82279
	SGTL-4-8	4	8°	.161	4	-	82284	82287
	SGTL-5-8	5	8°	.201	5	82290	-	-

SWISS SCREW MACHINE TOOLS

with Advanced Thru Coolant Jet-Stream™ System

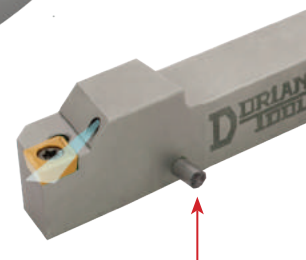
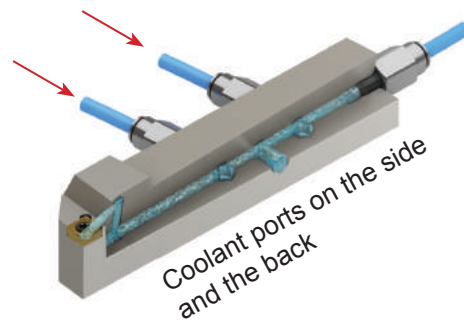
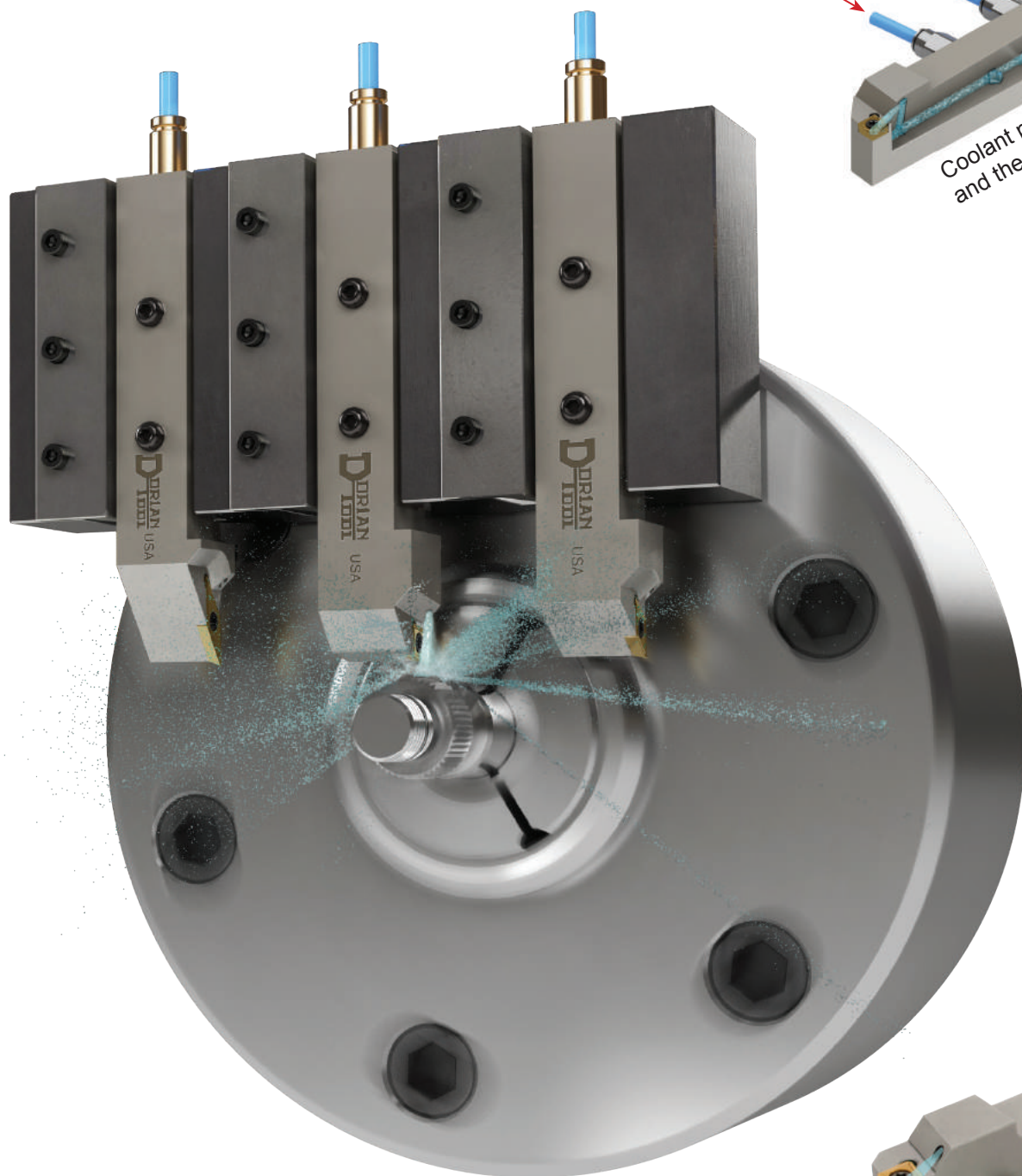

Positive Qualified stop for tool holder after insert change

High Pressure Coolant Quick Connection

for Standard or High Pressure Applications
with Side or End Coolant Connection

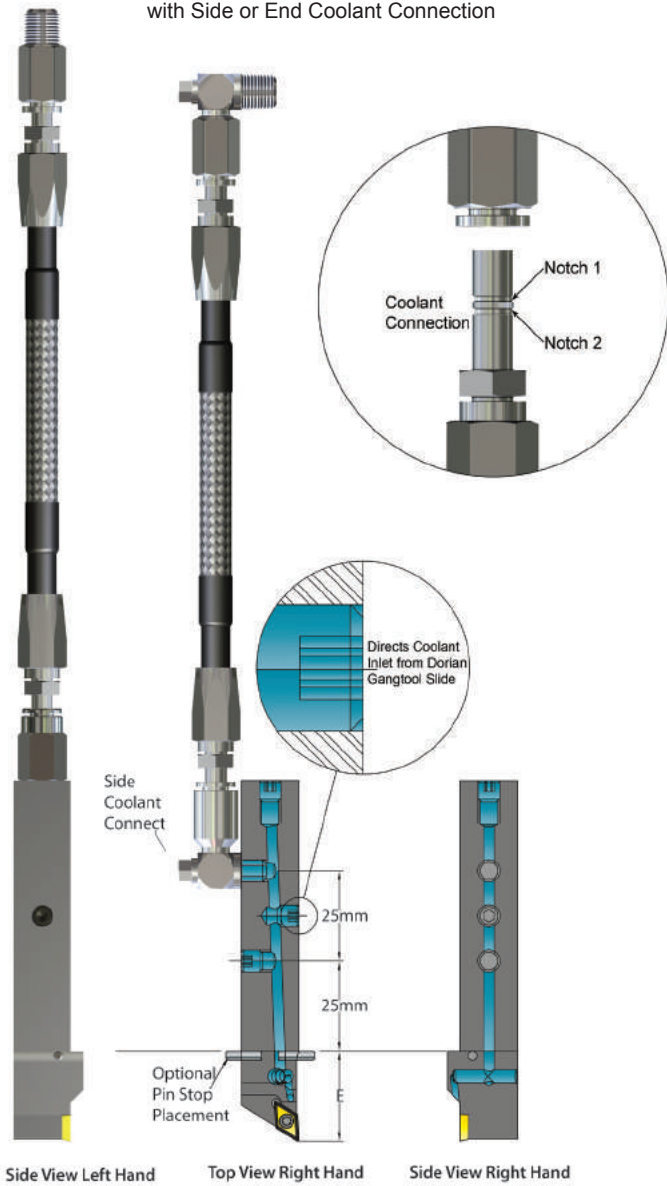

Item	Part Number	UPC #	Description
1	DT-HP-PLIERS	60476	High Pressure Disconnecting Pliers

To Disconnect the Hydraulic Coolant Hose Follow Two Safe & Easy Steps:

1. Place the **thinner section** of the wrench-nose of the coolant hose and the connector.

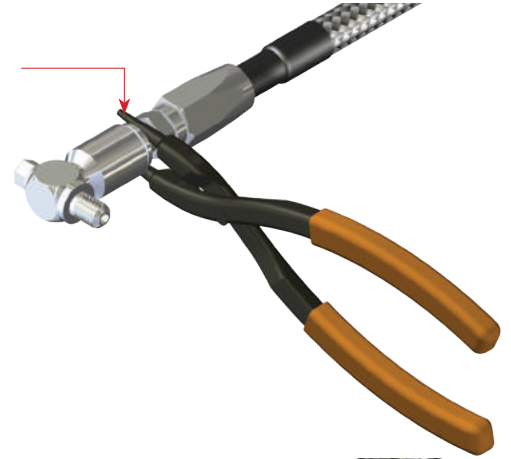

2. Close the wrench and it will disconnect **Notch 1** of the coolant hose. Use the **thicker section** of the wrench-nose and close again to disconnect **Notch 2**.

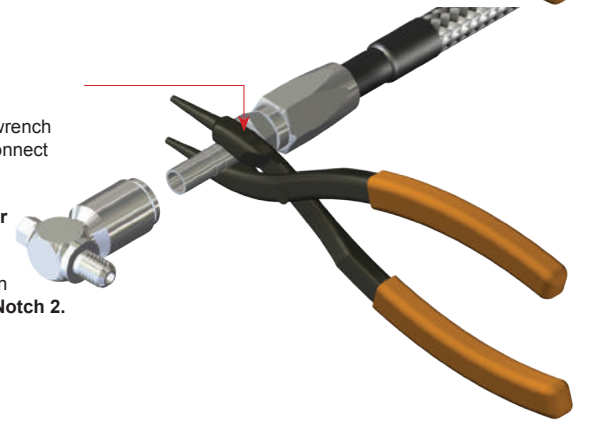

New Hydraulic Coolant Hose For Safe & Easy Disconnection

Swiss Tool holders-High Pressure Coolant Connection 7 Pcs. Kit Working Pressure

Item	Part Number	UPC #	Description	Bar	PSI
	DT-HPTU-ASSY	60480	Swiss High Pressure Quick Release Coolant 7 pcs. Kit	200	2800
1	DT-HPTU-8X4	60477	8mm High Pressure 8mm Coolant Tubing Only		
2	DT-HP90C-8/6	60479	High Pressure Quick Release Straight Intec		
3	DT-HP90C-8/6	60479	High Pressure Quick Release Straight Intec		
4	DT-HP0SC-1/8X6	60490	1/8" NPT Straight High Pressure Quick Release Connector		
5	DT-HP90CE-1/8X6	60489	1/8" NPT 90° Elbow High Pressure Quick Release Connector		
6	DT-HP0SC-6X6	60487	6mm Straight High Pressure Quick Release Connector		
7	DT-HP90C-6X6	60486	6mm 90° Elbow High Pressure Quick Release Connector		

ASCAC Jet-Stream™ Thru Coolant R/L Toolholder Style A - 0° Side Cutting Edge Angle for 7° positive 80° diamond CC_W inserts

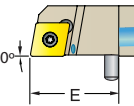

Coolant Outlet	METRIC Description	UPC #		System	Shank		E (Tool Stop)	CC_W Gage Insert
		Right Hand	Left Hand		Height	Length		
	ASCACR/L 1010-H06	60754	60755	mm	10	100	25	CCGW-060204
	ASCACR/L 1212-H06	60756	60757	mm	12	100	25	CCGW-060204
	ASCACR/L 1616-H06	60758	60759	mm	16	100	25	CCGW-060204
	ASCACR/L 1212-H09	60760	60761	mm	12	100	25	CCGW-09T308
	ASCACR/L 1616-H09	60762	60763	mm	16	100	25	CCGW-09T308
	ASCACR/L 2020-K09	60764	60765	mm	20	125	25	CCGW-09T308
Inch								
	ASCACR/L 08-2A	60692	-	inch	0.500	4.000	1.000	CCGW-21.51

ASDPC Jet-Stream™ Thru Coolant Neutral Toolholder Style P - 27.5° Side Cutting Edge Angle for 7° positive 55° diamond DC_W inserts

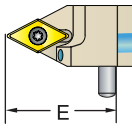

Coolant Outlet	METRIC Description	UPC #		System	Shank		E (Tool Stop)	DC_W Gage Insert
		Neutral	Neutral		Height	Length		
	ASDPCN 1010-H07	60824		mm	10	100	25	DCGW-070204
	ASDPCN 1212-H07	60825		mm	12	100	25	DCGW-070204
	ASDPCN 1212-H11	60826		mm	12	100	25	DCGW-11T308
	ASDPCN 1616-H11	60827		mm	16	100	25	DCGW-11T308
Inch								
	ASDPCN 08-3A	60714		inch	0.500	4.000	1.000	DCGW-32.52

ASCNC Jet-Stream™ Thru Coolant R/L Toolholder Style N - Negative 5° End or Side Cutting Edge Angle for 7° positive 80° diamond CC_W inserts

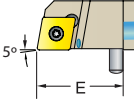

Coolant Outlet	METRIC Description	UPC #		System	Shank		E (Tool Stop)	CC_W Gage Insert
		Right Hand	Left Hand		Height	Length		
	ASCNCR/L 1010-H06	60770	60771	mm	10	100	25	CCGW-060204
	ASCNCR/L 1212-H06	60772	60773	mm	12	100	25	CCGW-060204
	ASCNCR/L 1616-H06	60774	60775	mm	16	100	25	CCGW-060204
	ASCNCR/L 1212-H09	60776	60777	mm	12	100	25	CCGW-09T308
	ASCNCR/L 1616-H09	60778	60779	mm	16	100	25	CCGW-09T308
	ASCNCR/L 2020-K09	60780	60781	mm	20	125	25	CCGW-09T308
Inch								
	ASCNCR/L 08-2A	60698	60699	inch	0.500	4.000	0.500	CCGW-21.51
	ASCNCR/L 08-3A	60701	60702	inch	0.500	4.000	0.500	CCGW-32.52

ASTAC Jet-Stream™ Thru Coolant R/L Toolholder Style A - 0° Side Cutting Edge Angle for 7° positive triangle TC_W inserts

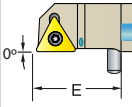

Coolant Outlet	METRIC Description	UPC #		System	Shank		E (Tool Stop)	Gage Insert
		Right Hand	Left Hand		Height	Length		
	ASTACR/L 1010-H11	60846	60847	mm	10	100	25	TCGW-110204
	ASTACR/L 1212-H11	60848	60849	mm	12	100	25	TCGW-110204
	ASTACR/L 1616-H11	60850	60851	mm	16	100	25	TCGW-110204
	ASTACR/L 2020-K11	60852	60853	mm	20	125	25	TCGW-110204
Inch								
	ASTACR/L 08-2A	60716	-	inch	0.500	4.000	1.000	TCGW-21.51

ASTNC Jet-Stream™ Thru Coolant R/L Toolholder Style N - 3° Side Cutting Edge Angle for 7° positive triangle TC_W inserts

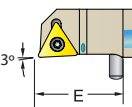

Coolant Outlet	METRIC Description	UPC #		System	Shank		E (Tool Stop)	TC_W Gage Insert
		Right Hand	Left Hand		Height	Length		
	ASTNCR/L 1010-H11	60858	60859	mm	10	100	25	TCGW-110204
	ASTNCR/L 1212-H11	60860	60861	mm	12	100	25	TCGW-110204
	ASTNCR/L 1616-H11	60862	60863	mm	16	100	25	TCGW-110204
	ASTNCR/L 1616-H16	60864	60865	mm	16	100	25	TCGW-16T308
Inch								
	ASTNCR/L 08-2A	60720	-	inch	0.500	4.000	1.000	TCGW-21.51

ASDAC Jet-Stream™ Thru Coolant R/L Toolholder Style A - 0° Side Cutting Edge Angle for 7° positive 55° diamond DC_W inserts

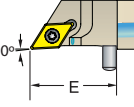

Coolant Outlet	METRIC Description	UPC #		System	Shank		E (Tool Stop)	DC_W Gage Insert
		Right Hand	Left Hand		Height	Length		
	ASDACR/L 1010-H07	60798	60799	mm	10	100	25	DCGW-070204
	ASDACR/L 1212-H07	60800	60801	mm	12	100	25	DCGW-070204
	ASDACR/L 1616-H07	60802	60803	mm	16	100	25	DCGW-070204
	ASDACR/L 1212-H11	60804	60805	mm	12	100	25	DCGW-11T308
	ASDACR/L 1616-H11	60806	60807	mm	16	100	25	DCGW-11T308
	ASDACR/L 2020-K11	60808	-	mm	20	125	25	DCGW-11T308
Inch								
	ASDACR/L 08-3A	60705	-	inch	0.500	4.000	1.000	DCGW-32.52

ASVAB Jet-Stream™ Thru Coolant R/L Toolholder Style A - 0° Side Cutting Edge Angle for 5° positive 35° diamond VB_W inserts

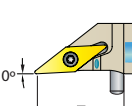

Coolant Outlet	METRIC Description	UPC #		System	Shank		E (Tool Stop)	VB_W Gage Insert
		Right Hand	Left Hand		Height	Length		
	ASVABR/L 1010-H11	60870	60871	mm	10	100	25	VBGW-110304
	ASVABR/L 1212-H11	60872	60873	mm	12	100	25	VBGW-110304
	ASVABR/L 1212-K16	60874	60875	mm	12	107	32	VBGW-160408
	ASVABR/L 1616-K16	60876	60877	mm	16	107	32	VBGW-160408
	ASVABR/L 2020-K16	60878	60879	mm	20	132	32	VBGW-160408
Inch								
	ASVABR/L 08-2A	-	60724	inch	0.500	4.000	1.000	VBGW-110304
	ASVABR/L 08-3A	60725	-	inch	0.500	4.000	1.000	VBGW-332

ASDNC Jet-Stream™ Thru Coolant R/L Toolholder Style N - 3° Side Cutting Edge Angle for 7° positive 55° diamond DC_W inserts

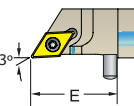

Coolant Outlet	METRIC Description	UPC #		System	Shank		E (Tool Stop)	DC_W Gage Insert
		Right Hand	Left Hand		Height	Length		
	ASDNCR/L 1010-H07	60810	60811	mm	10	100	25	DCGW-070204
	ASDNCR/L 1212-H07	60812	60813	mm	12	100	25	DCGW-070204
	ASDNCR/L 1616-H07	60814	60815	mm	16	100	25	DCGW-070204
	ASDNCR/L 1212-H11	60816	60817	mm	12	100	25	DCGW-11T308
	ASDNCR/L 1616-H11	60818	60819	mm	16	100	25	DCGW-11T308
	ASDNCR/L 2020-K11	60820	60821	mm	20	125	25	DCGW-11T308
Inch								
	ASDNCR/L 08-2A	60708	60709	inch	0.500	4.000	1.000	DCGW-21.51
	ASDNCR/L 08-3A	60711	60712	inch	0.500	4.000	1.000	DCGW-32.52

ASVNB Jet-Stream™ Thru Coolant R/L Toolholder Style N - 3° Side Cutting Edge Angle for 5° positive 35° diamond VB_W inserts

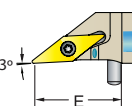
Coolant Outlet	METRIC Description	UPC #		System	Shank		E (Tool Stop)	VB_W Gage Insert
		Right Hand	Left Hand		Height	Length		
	ASVNB/R/L 1010-H11	60882	60883	mm	10	100	25	VBGW-110304
	ASVNB/R/L 1212-H11	60884	60885	mm	12	100	25	VBGW-110304
	ASVNB/R/L 1212-K16	60886	60887	mm	12	107	32	VBGW-160408
	ASVNB/R/L 1616-K16	60888	60889	mm	16	107	32	VBGW-160408
	ASVNB/R/L 2020-K16	60890	60891	mm	20	132	32	VBGW-160408
	Inch							
	ASVNB/R/L 08-2A	60727	60728	inch	0.500	4.000	1.000	VBGW-221
	ASVNB/R/L 08-3A	60729	60730	inch	0.500	4.250	1.250	VBGW-332

ASVNP Jet-Stream™ Thru Coolant R/L Toolholder Style N - 3° Side Cutting Edge Angle for 11° positive 35° diamond VP_W inserts

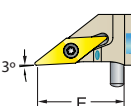
Coolant Outlet	METRIC Description	UPC #		System	Shank		E (Tool Stop)	VP_W Gage Insert
		Right Hand	Left Hand		Height	Length		
	ASVNP/R/L 1010-H11	60948	60649	mm	10	100	25	VPGW-110304
	ASVNP/R/L 1212-H11	60950	60951	mm	12	100	25	VPGW-110304
	ASVNP/R/L 1212-K16	60952	60953	mm	12	107	32	VPGW-160408
	ASVNP/R/L 1616-K16	60954	60955	mm	16	107	32	VPGW-160408
	ASVNP/R/L 2020-K16	60956	60957	mm	20	132	32	VPGW-160408
	Inch							
	ASVNP/R/L 08-2A	60745	60746	inch	0.500	4.000	1.000	VPGW-221
	ASVNP/R/L 08-3A	60747	60748	inch	0.500	4.250	1.250	VPGW-332

ASVVB Jet-Stream™ Thru Coolant Neutral Toolholder Style V - 17.5° Side Cutting Edge Angle for 5° positive 35° diamond VB_W inserts

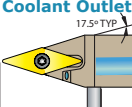
Coolant Outlet	METRIC Description	UPC #		System	Shank		E (Tool Stop)	VB_W Gage Insert
		Neutral			Height	Length		
	ASVVB/N 1010-H11	60893		mm	10	100	25	VBGW-110304
	ASVVB/N 1212-H11	60894		mm	12	100	25	VBGW-110304
	ASVVB/N 1212-K16	60895		mm	12	107	32	VBGW-160408
	ASVVB/N 1616-K16	60896		mm	16	107	32	VBGW-160408

ASVVP Jet-Stream™ Thru Coolant Neutral Toolholder Style V - 17.5° Side Cutting Edge Angle for 11° positive 35° diamond VP_W inserts

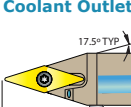
Coolant Outlet	METRIC Description	UPC #		System	Shank		E (Tool Stop)	VP_W Gage Insert
		Neutral			Height	Length		
	ASVVP/N 1010-H11	60959		mm	10	100	25	VPGW-110304
	ASVVP/N 1212-H11	60960		mm	12	100	25	VPGW-110304
	ASVVP/N 1212-K16	60961		mm	12	107	32	VPGW-160408
	ASVVP/N 1616-K16	60962		mm	16	107	32	VPGW-160408

ASVAC Jet-Stream™ Thru Coolant R/L Toolholder Style A - 0° Side Cutting Edge Angle for 7° positive 35° diamond VC_W inserts

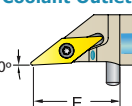
Coolant Outlet	METRIC Description	UPC #		System	Shank		E (Tool Stop)	VC_W Gage Insert
		Right Hand	Left Hand		Height	Length		
	ASVAC/R/L 1010-H11	60902	60903	mm	10	100	25	VCGW-110304
	ASVAC/R/L 1212-H11	60904	60905	mm	12	100	25	VCGW-110304
	ASVAC/R/L 1212-K16	60906	60907	mm	12	107	32	VCGW-160408
	ASVAC/R/L 1616-K16	60908	60909	mm	16	107	32	VCGW-160408

ASE Jet-Stream™ Thru Coolant Threading Toolholder - Right and Left Hand for LayDown Insert

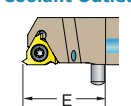
Coolant Outlet	METRIC Description	UPC #		System	Shank		E (Tool Stop)	Gage Insert
		Right Hand	Left Hand		Height	Length		
	ASER/L 1010-H11	61078	-	mm	10	100	25	11-A60
	ASER/L 1212-H11	61080	-	mm	12	100	25	
	ASER/L 1616-H16	61082	61083	mm	16	100	25	16-G60

ASVNC Jet-Stream™ Thru Coolant R/L Toolholder Style N - 3° Side Cutting Edge Angle for 7° positive 35° diamond VC_W inserts

Coolant Outlet	METRIC Description	UPC #		System	Shank		E (Tool Stop)	VC_W Gage Insert
		Right Hand	Left Hand		Height	Length		
	ASVNC/R/L 1010-H11	60914	60915	mm	10	100	25	VCGW-110304
	ASVNC/R/L 1212-H11	60916	60917	mm	12	100	25	VCGW-110304
	ASVNC/R/L 1616-H11	60918	60919	mm	16	100	25	VCGW-110304
	ASVNC/R/L 1212-K16	60920	60921	mm	12	107	32	VCGW-160408
	ASVNC/R/L 1616-K16	60922	60923	mm	16	107	32	VCGW-160408
	ASVNC/R/L 2020-K16	60924	60925	mm	20	132	32	VCGW-160408
	Inch							
	ASVNC/R/L 08-2A	60738	60739	inch	0.500	4.000	1.000	VCGW-221
	ASVNC/R/L 08-3A	60741	60742	inch	0.500	4.250	1.250	VCGW-332

ANS Jet-Stream™ Thru Coolant Threading Toolholder - Right and Left Hand for DorNotch V Thread Inserts

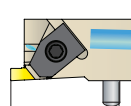
Coolant Outlet	METRIC Description	UPC #		System	Shank		E (Tool Stop)	Gage Insert
		Right Hand	Left Hand		Height	Length		
	ANSR/L 1212-H02	61088	61089	mm	12	100	25	NG-2R NG-2L
	ANSR/L 1616-H02	61090	61091	mm	16	100	25	
	ANSR/L 1212-H03	61092	61093	mm	12	100	25	NG-3R NG-3L
	ANSR/L 1616-H03	61094	61095	mm	16	100	25	
	Inch							
	ANSR/L 08-2A	61108	-	inch	0.500	4.000	1.000	NG-2R NG-2L
	ANSR/L 08-3A	61110	-	inch	0.500	4.000	1.000	NG-3R NG-3L

ASVVC Jet-Stream™ Thru Coolant Neutral Toolholder Style V - 17.5° Side Cutting Edge Angle for 7° positive 35° diamond VC_W inserts

Coolant Outlet	METRIC Description	UPC #		System	Shank		E (Tool Stop)	VC_W Gage Insert
		Neutral			Height	Length		
	ASVVC/N 1010-H11	60927		mm	10	100	25	VCGW-110304
	ASVVC/N 1212-H11	60928		mm	12	100	25	VCGW-110304
	ASVVC/N 1212-K16	60929		mm	12	107	32	VCGW-160408
	ASVVC/N 2020-K16	60931		mm	20	132	32	VCGW-160408

ASTVO Jet-Stream™ Thru Coolant Threading Toolholder - Right and Left Hand for On Edge TNMC Inserts

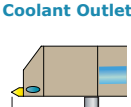
Coolant Outlet	METRIC Description	UPC #		System	Shank		E (Tool Stop)	Gage Insert
		Right Hand	Left Hand		Height	Length		
	ASTVOR/L 1010-H16	61098	-		10	100	25	TNMC-322
	ASTVOR/L 1212-H16	61100	-		12	100	25	
	ASTVOR/L 1616-H16	61102	61103		16	100	25	
Inch								
	ASTVOR/L 08-3A	61112	-		0.500	4.000	1.000	TNMC-322

ASGTH Jet-Stream™ Thru Coolant Cut-Off Toolholder - Right and Left Hand for SGTN Cut-Off Inserts for Swiss Screw Machines

Coolant Outlet	METRIC	UPC #		System	Insert Size		Shank		E (Tool Stop)	Max. Dia.	Gage Insert
	Description	Right Hand	Left Hand		Height	Length					
	ASGTHR/L 1010-H02	62922	62923	mm	2.0	2.4	10	100	25	28	SGTN-2.0
	ASGTHR/L 1212-H02	62924	62925	mm	2.0	2.4	12	100	25	28	
	ASGTHR/L 1616-H02	62926	62927	mm	2.0	2.4	16	100	25	28	
	ASGTHR/L 2020-K02	62928	62929	mm	2.0	2.4	20	125	25	32	
	ASGTHR/L 2525-K02	62930	62931	mm	2.0	2.4	25	132	32	40	
	ASGTHR/L 1010-H03	62932	62933	mm	3.0		10	100	25	28	SGTN-3.0
	ASGTHR/L 1212-H03	62934	62935	mm	3.0		12	100	25	32	
	ASGTHR/L 1616-H03	62936	62937	mm	3.0		16	100	25	32	
	ASGTHR/L 2020-K03	62938	62939	mm	3.0		20	125	25	36	
	ASGTHR/L 2525-K03	62940	62941	mm	3.0		25	132	32	52	
Inch											
ASGTHR/L 08-2A	62942	62943	inch	0.079	0.098	0.500	4.000	1.000	1.102	1.102	SGTN-2.0
ASGTHR/L 16-2C	62944	62945	inch	0.079	0.098	1.000	5.000	1.250	1.575	1.575	SGTN-2.0
ASGTHR/L 08-3A	62946	62947	inch	3.0		0.500	4.000	1.000	1.260	1.260	SGTN-3.0
ASGTHR/L 16-3C	62948	62949	inch	3.0		1.000	5.000	1.250	2.047	2.047	SGTN-3.0

ADDN Jet-Stream™ Thru Coolant External Turning, Grooving & Cut-off Toolholders

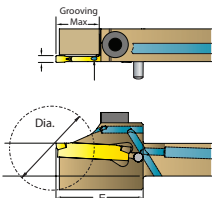
Coolant Outlet	METRIC	UPC #		System	Insert Size		Shank		E (Tool Stop)	Grooving Max.	Max. Dia.	Insert
	Description	Right Hand	Left Hand		Height	Length						
	ADDN-TFR/L-1010-H20-06	61000	61001	mm	2		10	107	32	6	12	DN_-22_N-20
	ADDN-TFR/L-1212-H20-06	61002	61003	mm	2		12	107	32	6	12	DN_-22_N-20
	ADDN-TFR/L-1212-H30-09	61008	61009	mm	3		12	107	32	9	18	DN_-22_N-30-
	ADDN-TFR/L-1616-H20-06	61004	61005	mm	2		16	107	32	6	12	DN_-22_N-20
	ADDN-TFR/L-1616-H30-09	61006	61007	mm	3		16	107	32	9	18	DN_-22_N-30-
	ADDN-TFR/L-2020-K20-06	61028	61029	mm	2		20	132	32	6	12	DN_-22_N-20
	ADDN-TFR/L-2020-K30-09	61030	61031	mm	3		20	132	32	9	18	DN_-22_N-30-
	Inch											
ADDN-TFR/L-08-20A-06	61040	61041	inch	.079		.500	4.250	1.250	0.236	0.472	0.472	DN_-22_N-20
ADDN-TFR/L-08-30A-09	61042	61043	inch	.079		.500	4.250	1.250	0.354	0.709	0.709	DN_-22_N-30-

ADDN Jet-Stream™ Thru Coolant External Turning, Grooving & Cut-off Toolholders

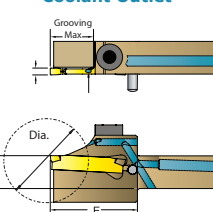
Coolant Outlet	METRIC	UPC #		System	Insert Size		Shank		E (Tool Stop)	Grooving Max.	Max. Dia.	Insert
	Description	Right Hand	Left Hand		Height	Length						
	ADDN-TFR/L-1010-H20-12	61010	61011	mm	2		10	107	32	12	24	DN_-22_N-20
	ADDN-TFR/L-1212-H20-12	61012	61013	mm	2		12	107	32	12	24	DN_-22_N-20
	ADDN-TFR/L-1212-H30-14	61018	61019	mm	3		12	107	32	14	28	DN_-22_N-30-
	ADDN-TFR/L-1616-H20-12	61014	61015	mm	2		16	107	32	12	24	DN_-22_N-20
	ADDN-TFR/L-1616-H30-14	61016	61017	mm	3		16	107	32	14	28	DN_-22_N-30-
	ADDN-TFR/L-2020-K20-12	61032	61033	mm	2		20	132	32	12	24	DN_-22_N-20
	ADDN-TFR/L-2020-K30-14	61034	61035	mm	3		20	132	32	14	28	DN_-22_N-30-
	Inch											
ADDN-TFR/L-08-20A-12	61044	61045	inch	.079		0.500	1.250	4.250	0.472	0.945	0.945	DN_-22_N-20
ADDN-TFR/L-08-30A-14	61046	61047	inch	0.118		0.500	1.250	4.250	0.551	1.102	1.102	DN_-22_N-30-

ADDN Jet-Stream™ Thru Coolant External Turning, Grooving & Cut-off Toolholders

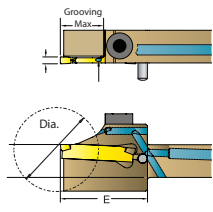
Coolant Outlet	METRIC	UPC #		System	Insert Size		Shank		E (Tool Stop)	Grooving Max.	Max. Dia.	Insert
	Description	Right Hand	Left Hand		Height	Length						
	ADDN-TFR/L-1010-H20-18	61020	61021	mm	2		10	107	32	18	36	DN_-22_N-20
	ADDN-TFR/L-1212-H20-18	61022	61023	mm	2		12	107	32	18	36	DN_-22_N-20
	ADDN-TFR/L-1616-H20-18	61024	61025	mm	2		16	107	32	18	36	DN_-22_N-20
	ADDN-TFR/L-1616-H30-20	61026	61027	mm	3		16	107	32	20	40	DN_-22_N-30-
	ADDN-TFR/L-2020-K20-18	61036	61037	mm	2		20	132	32	18	36	DN_-22_N-20
	ADDN-TFR/L-2020-K30-20	61038	61039	mm	3		20	132	32	20	40	DN_-22_N-30-
	Inch											
	ADDN-TFR/L-08-20A-18	61048	61049	inch	.079		0.500	1.250	4.250	0.709	1.417	1.417

KNURLING TOOLS

From the Knurling Tool Specialists for CNC & Manual Lathes

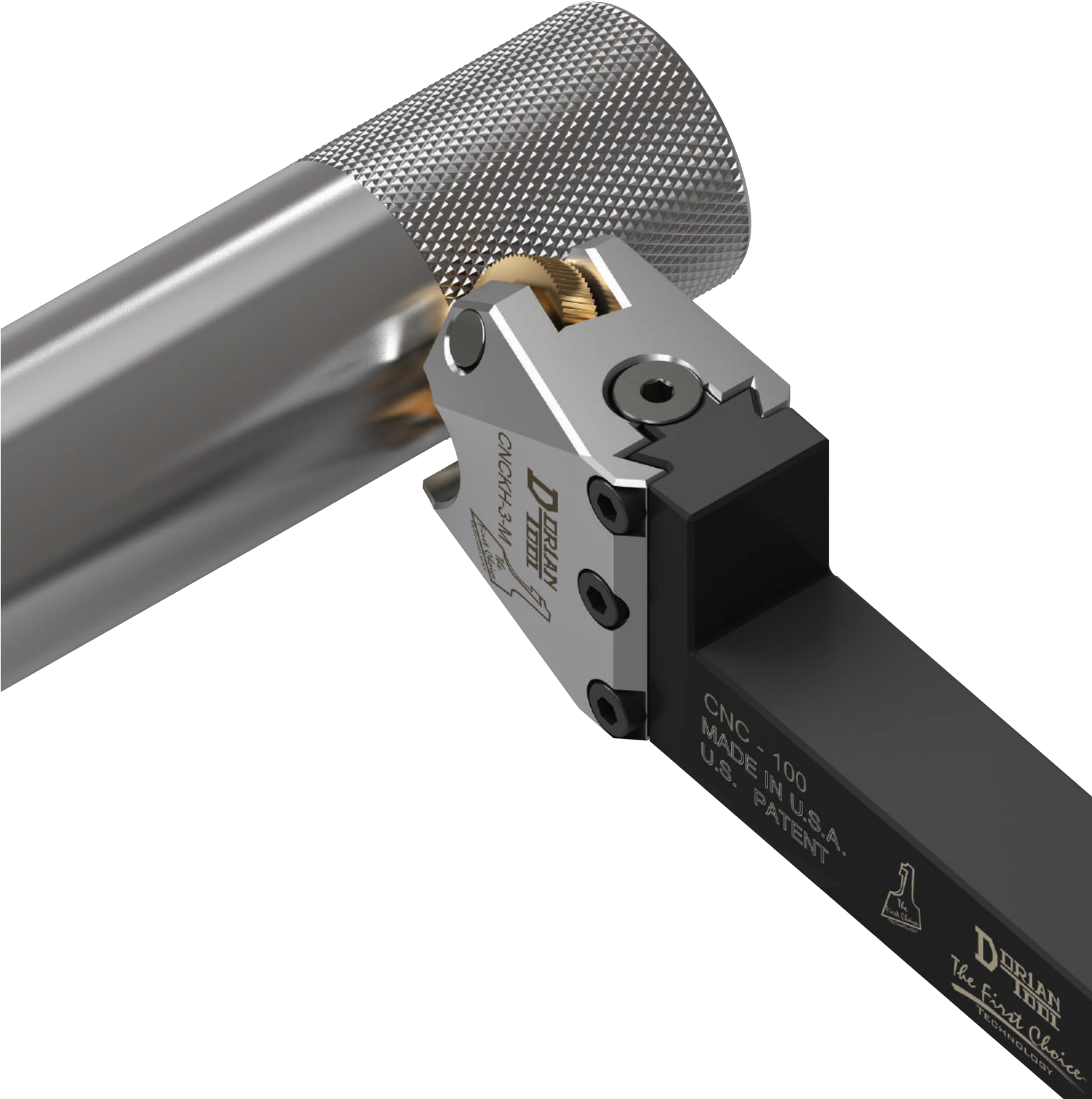



Knurling Tool Applications Form for Manual & CNC Machines

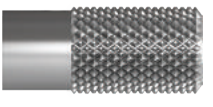

If your knurling application is not in the chart, please supply prints and information.

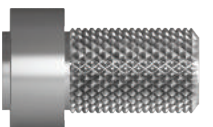

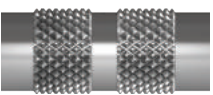
Knurling Application Knurling Tool Recommendation

Diamond Shoulderless	BEST	BETTER	GOOD
	SCNC-_1-2 CNC-_1-2 CNC-_2-R CNC-_3-M 3WKT-_M	SCNC-_7-D CNC-_7-R KTM109-_M KTO109-_O	SCKN-_DW-_ 3SHKT-_ CNC-_4-M

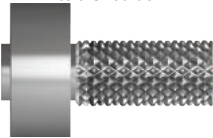
Diamond to a Shoulder	BEST	BETTER	GOOD
	3WKT-_2 KTM109-_4 CNC109-_4	SSCK-__DW SCNC-_6-2 CNC-_6-4	SFKT

Diamond Band	BEST	BETTER	GOOD
	SCNC-_7-D- CNC-_7-R KTM109-_M KTO109-_O	SCKN-__DW-_ 3SHKT-_ CNC-_4-M CNC-_5-O	FKT-__ SWFKT-__
Straight Band	CNC109-_M		
			

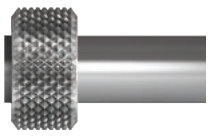
Small Diameter Diamond to a Shoulder	BEST	BETTER	GOOD
	3WKT-_2		
Small Diameter Straight to a Shoulder			
			

Diamond Crest	BEST	BETTER	GOOD
	SCNC-_7-D CNC-_7-R KTM109-_M KTO109-_O CNC109-_M	SCKN-__DW-_ 3SHKT-_ CNC-_4-M CNC-_5-O	FKT-__ SWFKT-__
Straight Crest			
			



Radio Face	BEST	BETTER	GOOD
	Special		

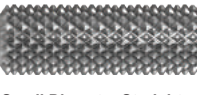

Knurling Application Knurling Tool Recommendation

Straight Shoulderless	BEST	BETTER	GOOD
	SCNC-_7-D CNC-_7-R KTM109-_M KTO109-_O 3WKT-__ CNC109-_M	107ST-_ 107ST-_ CNC-_4-M SCKN-__DW-_ 3SHKT-_ CNC-_5-O	FKT-__ SWFKT-__

Straight to a Shoulder	BEST	BETTER	GOOD
	KTM109-_4 3WKT-__ CNC109-_4	SCNC-_6-2 CNC-_6-4 SSCK	SFKT-__ SSWFKT

Small Diameter Diamond Shoulderless	BEST	BETTER	GOOD
	3WKT-__	SCNC-_7-D CNC-_7-R	
Small Diameter Straight Shoulderless			
			

Taper Diamond	BEST	BETTER	GOOD
	Special		
Taper Straight			
			

Internal Diamond	BEST	BETTER	GOOD
	TIKT-__ SIKT-__		
Internal Straight			
			

Milling Diamond	BEST	BETTER	GOOD
	MMKT-__		
Milling Straight			
			

Knurling Tool Applications Form for Manual & CNC Machines

Figure 1 - Full Knurling

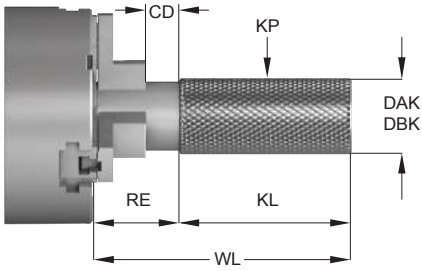

Figure 2 - Band Knurling

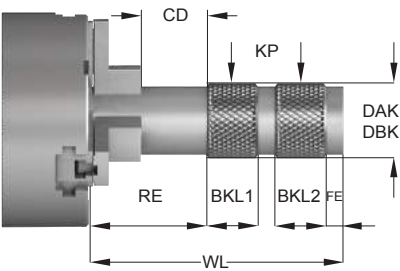

Figure 3 - Shoulder Knurling

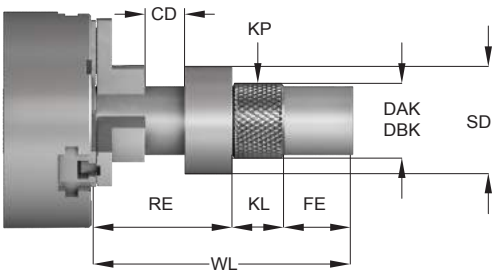
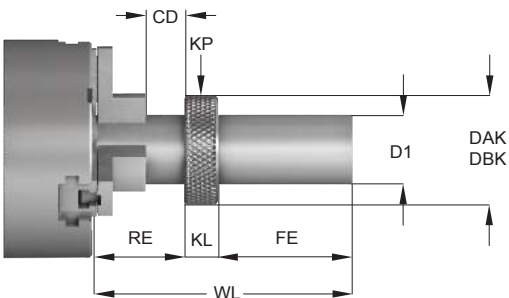
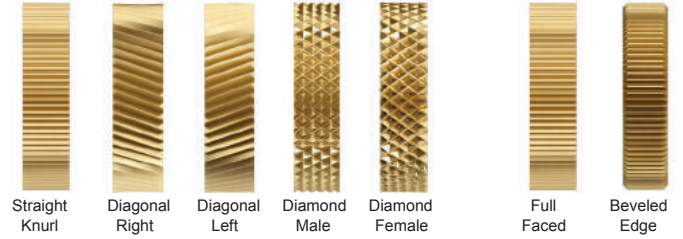

Figure 4 - Crest Knurling



Knurl Wheel Identification



Edge Prep

Knurl Pitch

TPI Is the number of teeth per inch

Circular Pitch Is the distance between tooth to tooth

Diametral Pitch Is the number of teeth per inch of diameter

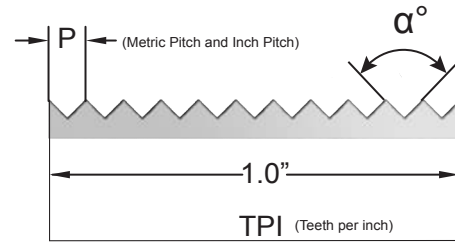

Knurling Specification

Fill out as applicable

- | | | | |
|----------------------------------|--------------------------|----------------------------------|--------------------------|
| SKP Straight Knurl | <input type="checkbox"/> | DKPM Diamond Knurl Male | <input type="checkbox"/> |
| DKPR Diagonal Knurl Right | <input type="checkbox"/> | DKPF Diamond Knurl Female | <input type="checkbox"/> |
| DKPL Diagonal Knurl Left | <input type="checkbox"/> | | |

Fill Knurling Dimension

- | | | | | | |
|---|---------------------------------|-------------------------------|--------------------------|----------------------------|--------------------------|
| KP Knurl Pitch | <input type="checkbox"/> Inch | <input type="checkbox"/> TPI | <input type="checkbox"/> | AP % of Knurl Depth | <input type="checkbox"/> |
| | <input type="checkbox"/> DP | <input type="checkbox"/> | | | |
| | <input type="checkbox"/> Metric | <input type="checkbox"/> P-mm | <input type="checkbox"/> | | |
| DBK Diameter (Blank) Before Knurling | <input type="checkbox"/> | FE Front End Distance | <input type="checkbox"/> | | |
| DAK Diameter After Knurling | <input type="checkbox"/> | RE Rear End Distance | <input type="checkbox"/> | | |
| KL Knurling Length | <input type="checkbox"/> | CD Chuck Distance | <input type="checkbox"/> | | |
| BKL1 Band Knurling Length 1 | <input type="checkbox"/> | SD Shoulder Diameter | <input type="checkbox"/> | | |
| BKL2 Band Knurling Length 2 | <input type="checkbox"/> | D1 Shoulder Diameter | <input type="checkbox"/> | | |
| WL Workpiece Length | <input type="checkbox"/> | | | | |

Knurling Tool Applications Form for Manual & CNC Machines

Figure 5 - ID Internal Knurling

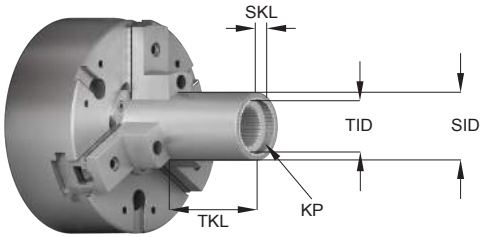

Knurling Specification

Fill out as applicable

TID True Internal Diameter	<input type="text"/>	SKL Shoulder Knurling Length	<input type="text"/>
SID Shoulder Internal Diameter	<input type="text"/>	KP Knurl Pattern	<input type="text"/>
TKL True Knurling Length	<input type="text"/>	PI Knurl Pitch	<input type="text"/> Inch <input type="text"/> TPI <input type="text"/>
			<input type="text"/> DP <input type="text"/>
			<input type="text"/> Metric <input type="text"/> P-mm <input type="text"/>

Figure 6 - Face Knurling

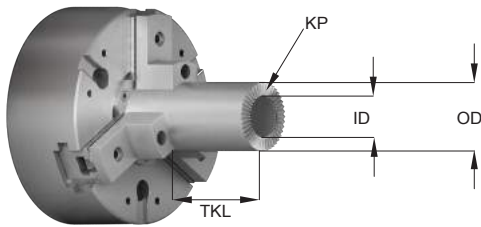

Knurling Specification

Fill out as applicable

ID Inside Diameter	<input type="text"/>	KP Knurl Pattern	<input type="text"/>
OD Outside Diameter	<input type="text"/>	PI Knurl Pitch	<input type="text"/> Inch <input type="text"/> TPI <input type="text"/>
			<input type="text"/> DP <input type="text"/>
			<input type="text"/> Metric <input type="text"/> P-mm <input type="text"/>

Figure 7 - Taper Knurling

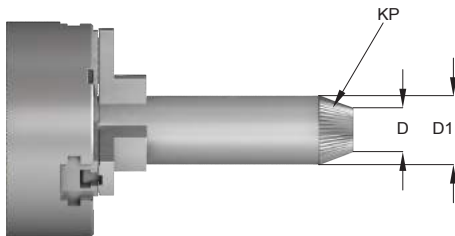

Knurling Specification

Fill out as applicable

D Small Diameter	<input type="text"/>	KP Knurl Pattern	<input type="text"/>
D1 Large Diameter	<input type="text"/>	PI Knurl Pitch	<input type="text"/> Inch <input type="text"/> TPI <input type="text"/>
			<input type="text"/> DP <input type="text"/>
			<input type="text"/> Metric <input type="text"/> P-mm <input type="text"/>

Figure 8 - Milling Knurling

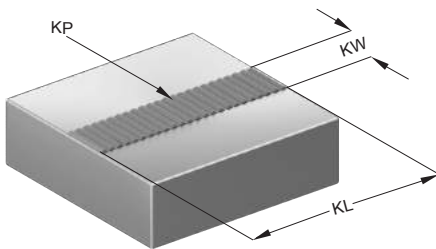

Knurling Specification

Fill out as applicable

KW Knurling Width	<input type="text"/>	KP Knurl Pattern	<input type="text"/>
KL Knurling Length	<input type="text"/>	PI Knurl Pitch	<input type="text"/> Inch <input type="text"/> TPI <input type="text"/>
			<input type="text"/> DP <input type="text"/>
			<input type="text"/> Metric <input type="text"/> P-mm <input type="text"/>

Knurling Production Information			
Material	<input type="text"/>	Annealed <input type="checkbox"/>	Heat Treated <input type="checkbox"/>
Quantity	<input type="text"/>	Hardness	<input type="text"/>
Machine	Manual <input type="checkbox"/>	CNC <input type="checkbox"/>	Swiss <input type="checkbox"/> Other <input type="checkbox"/>
Tool holder Style	Left <input type="checkbox"/>	Right <input type="checkbox"/>	Tool holder Size <input type="text"/>

Knurling Tool Recommendation				
Customer Information	Figure <input type="text"/>	Dorian Tool Recommendation		
Date		Item	UPC	Price
Company		Knurling Tool		
Contact		Knurling Head		
E-mail		Knurling Wheel		
Telephone		Knurling Pin		

For Best Knurling Results

1. Diameter of part being knurled should be turned to size and concentric to achieve a good knurling quality.
2. Knurl wheels must be exactly in center line with the work piece for an even knurl pattern.
3. Knurl wheels are to run freely and the knurl pin must be secured on the tool holder (the use of a carbide pin is recommended).
4. Use heavy flow of coolant to keep the knurl wheels cool and clean.
5. There are formulas to calculate depth of cut, tracking pitch and cutting parameter. Because of different material hardness, before starting production follow the instructions and with trial error the best result will be achieved.

Speed and Feeds

For in-feed knurling, the knurl should be fed toward the work gradually until contact is made with the blank. This can be completed within 5 to 25 work revolutions of the working piece.

For end-feed knurling, the feeds used with the turret vary considerably and are dependent on the pitch of the knurl, the material, the diameter of the work blank, and the hardness being knurled.

Knurling is ordinarily performed at the same speeds used as cutting operations. Use the same SFM used for high speed and cobalt tool bits to calculate speeds and feeds. However, where spindle speeds can be reduced without loss of production, it is recommended that spindle speeds be lowered as much as possible to increase knurl life.

For Best Knurling Performance

Before beginning Knurling process check:

- Diameter before knurl
- Diameter after knurl
- Knurl pitch
- Workpiece to be concentric
- Set wheels on center line of workpiece
- Use beveled edge wheels when form knurling
- Use full faced wheels when cut knurling
- Always use coolant when knurling
- The standard knurling depth is 35% of knurl circular pitch.

Example: Knurling Depth of 20 TPI Knurl

Circular Pitch of 20TPI is: $1.000/20 = .050''$

Knurling Depth is: $.050'' \times .035\% = .0175''$ per side

- If the knurl double tracks, the knurl wheel is not deep enough in to workpiece, increase knurling depth
- If the knurl crest rolls over, the knurl wheel is too deep in to the workpiece, decrease knurling depth
- If the knurl is not tracking, the workpiece diameter is not correct for full number of teeth, diameter must adjusted up or down by using a tracking formula.

In-Feed Knurling, when the knurl wheel enter into the workpiece radially.

Once the knurl wheel has reached the depth, will take from **5 to 20** revolutions to complete the knurling operation. The revolution changes for the same size with the workpiece material hardness and knurl pitch.

End-Feed Knurling, when the knurl wheel enter into the workpiece axially.

The depth of the knurl wheel must be set before the wheel get in contact with the workpiece, the depth and pressure changes for the same size with the workpiece material hardness and knurl pitch.

Knurling Speeds and Feeds

Material and Knurl Pitch				Knurl Forming			Knurl Cutting			
Material Description	Material Specs	TPI	Metric Pitch	Forming Speed (SFM and V _c)		Feed rate (f _n)		Cutting Speed		End Feed
				Smaller <Wheel dia. >Larger		End Feed	In Feed	Smaller <Wheel dia. >Larger		
Low carbon steel	1018 1117 1215	>14	>1,8	50-210 SFM [15-63 V _c m/min]		0.006" [0,15mm]	.001-.003" [.025-.075mm]	100-350 SFM [30-106 m/min]		0.009" [.23mm]
		16-20	1,6-1,2			0.008" [0,20mm]	.002-.004" [0,050-.100mm]			0.011" [.28mm]
		25-35	1,0-0,7			0.010" [.25mm]	.002-.004" [.050-.100mm]			0.013" [.33mm]
		40>	0,6>			0.012" [.30mm]	.002-.004" [.050-.100mm]			0.015" [.38mm]
Alloy Steel Tool steels	4130 4140 D2	>14	>1,8	35-150 SFM [10-45 m/min]		0.004" [.10mm]	.001-.002" [.025-.050mm]	70-250 SFM [21-75 m/min]		0.007" [.18mm]
		16-20	1,6-1,2			0.005" [.13mm]	.001-.003" [.025-.075mm]			0.008" [.20mm]
		25-35	1,0-0,7			0.007" [.18mm]	.001-.003" [.025-.075mm]			0.010" [.25mm]
		40>	0,6>			0.009" [.23mm]	.001-.003" [.025-.075mm]			0.012" [.30mm]
Stainless Steel	304 17-4	>14	>1,8	35-150 SFM [10-45 m/min]		0.004" [.10mm]	.001-.002" [.025-.050mm]	70-250 SFM [21-75 m/min]		0.007" [.18mm]
		16-20	1,6-1,2			0.005" [.13mm]	.001-.003" [.025-.075mm]			0.008" [.20mm]
		25-35	1,0-0,7			0.007" [.18mm]	.001-.003" [.025-.075mm]			0.010" [.25mm]
		40>	0,6>			0.009" [.23mm]	.001-.003" [.025-.075mm]			0.012" [.30mm]
Aluminum Brass Plastic	6061 C360 Delrin	>14	>1,8	90-390 SFM [27-118 m/min]		0.008" [.20mm]	.002-.004" [.050-.100mm]	110-420 SFM [33-127 m/min]		0.011" [.28mm]
		16-20	1,6-1,2			0.010" [.25mm]	.003-.005" [.075-.125mm]			0.013" [.33mm]
		25-35	1,0-0,7			0.013" [.33mm]	.003-.005" [.075-.125mm]			0.016" [.40mm]
		40>	0,6>			0.017" [.43mm]	.003-.005" [.075-.125mm]			0.020" [.50mm]

Note: When knurling, start with low Cutting speed, to evaluate the wheel performance, (to avoid the premature life of the wheel) increase until optimum cutting speed and feed is achieved

Forming Knurling Versus Cutting Knurl

- In Forming Knurl, the knurl wheel's axis is set parallel to the workpiece axis, and forced against workpiece displacing the material to form the knurl pattern
- A large amount of pressure is required to displace the material that forms the knurl pattern, and pressure increases with workpiece diameter, pitch size and hardness
- In a large workpiece diameter, large knurl pitch, and hard material, a multi knurling pass may be required to achieve the correct knurl pattern
- For best performance and quality in Forming Knurl, when possible, a Straddle Knurling Tool is to be used, the pressure is divided within the knurl wheels over the workpiece, and pressure against the spindle of the machine is totally neutralized.
- Use beveled edge wheel when knurl forming to protect the edge from chipping and for smooth knurling surface.
- Use full face Knurled wheel when knurl cutting, the knurl wheels axis are set on negative angle, the sharp edge will cut the knurl pattern into the workpiece
- In cutting knurl, less pressure is required for the operation, higher speed and feed can be used, (use the same cutting date of High Speed or Cobalt turning tools)
- Use full faced knurl wheel when knurl cutting.

Use Forming Knurl Tool for:	Use Cutting Knurl Tool for:
- Small to medium workpiece diameter	- Medium to large workpiece diameter
- To the shoulder knurling	- For shoulderless diameter knurling
- For centerless workpiece	- For hard workpiece materials
- For band knurling application	- For long knurl application with live center
- When high surface finish required	- For higher productivity

Two Ways to Achieve Knurling

(1) Forming

Knurl forming is achieved by pushing the knurl wheels against the blank while rotating. This will cause the material to be displaced in cold form, reproducing the same wheel pattern on the blank circumference. The blank is increased accordingly to the Knurl Pitch. The force applied through forming is increased in larger diameters making knurling difficult and slow.



Use beveled edge wheel when knurl forming to protect the edge from chipping and for smooth knurl surface.

(2) Cutting

Knurl cutting is achieved by using knurl wheels to actually cut instead of forming the blank. The knurl wheels are set at an angle, making the knurling edges of the knurl wheels cut into the blank. Pressure is minimized while speed and feed are increased.

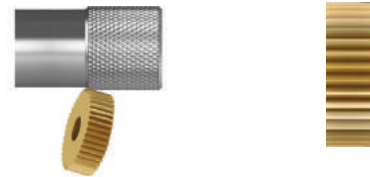

Use full face Knurled wheel when knurl cutting, the knurl wheels axis are set on negative angle, the sharp edge will cut the knurl pattern into the workpiece

Common Knurling Problems		
Problem	Cause	Solution
Knurling double tracking	<ol style="list-style-type: none"> 1) Knurl wheel not deep enough into the workpiece 2) The circumference of the workpiece blank is not a full multiple of the knurl pitch 	<ol style="list-style-type: none"> 1) Increase the depth of the knurl wheel into the workpiece 2) Change the blank diameter +/- .005" (.127mm) or use the tracking formula
Knurling flaking or slivered	<ol style="list-style-type: none"> 1) Knurling a workpiece material with scaling or rough surface 2) Over-rolling the knurl wheel into the workpiece when in-feed knurling 3) Knurl Wheel too deep into the workpiece when end-feeding 4) Using 1:1 knurl to workpiece ratio 	<ol style="list-style-type: none"> 1) Turn the scaling or the rough surface of workpiece into a smooth surface 2) When in-feed knurling, reduce the depth of the knurl wheel, or reduce the number of revolutions after the knurl wheel has reached knurling depth 3) When end-feeding, reduce the depth of the knurl wheel 4) Use larger or smaller diameter wheel
Knurl destruction	<ol style="list-style-type: none"> 1) Knurling a workpiece material with scaling or rough surface 2) Over-rolling the knurl wheel into the workpiece when in-feed knurling 3) Knurl Wheel too deep into the workpiece 4) Use of sharp full faced knurl wheel when knurl forming 	<ol style="list-style-type: none"> 1) Reduce the depth of the knurl wheel 2) Reduce the number of revolutions after the knurl wheel has reached knurling depth 3) Reduce feed and speed and improve coolant flow 4) Use beveled edge when form knurling
Knurl wheel poor life	<ol style="list-style-type: none"> 1) Knurling a workpiece material with scaling or rough surface 2) Over-rolling the knurl wheel into the workpiece when in-feed knurling 3) Knurl Wheel too deep into the workpiece when end-feeding 4) Workpiece material too hard, or difficult to knurl (stainless steels and high temp alloys) 5) Workpiece not running concentric 6) Workpiece too hard 7) Knurl wheel not properly hardened 8) Poor lubrication 9) Not using the correct knurl wheel for the application 10) Knurl wheel not beveled 	<ol style="list-style-type: none"> 1) Turn the scaling or the rough surface of workpiece into a smooth surface 2) When in-feed knurling, reduce the depth of the knurl wheel, or reduce the number of revolutions after the knurl wheel has reached knurling depth 3) When end-feeding, reduce the depth of the knurl wheel 4) Reduce feed and speed and improve coolant flow 5) Turn workpiece concentric and into a smooth surface 6) Reduce workpiece speed 7) Change the knurl wheel 8) Improve coolant flow 9) Use beveled knurl wheel(s) when forming knurling; use full faced knurl wheel(s) for cutting knurling 10) Use a beveled knurl wheel
Uneven depth of knurl	<ol style="list-style-type: none"> 1) Knurling a workpiece material with scaling or rough surface 2) Workpiece not running concentric 3) Using 1:1 knurl to workpiece ratio 	<ol style="list-style-type: none"> 1) Turn the scaling or the rough surface of workpiece into a smooth surface 2) Turn workpiece concentric and into a smooth surface 3) Use larger or smaller diameter wheel
Twisted knurl pattern	<ol style="list-style-type: none"> 1) Knurl wheel not deep enough into the workpiece 2) The circumference of the workpiece blank is not a full multiple of the knurl pitch 	<ol style="list-style-type: none"> 1) Increase the depth of the knurl wheel 2) Change the blank diameter +/- .005" (.127mm) or use the tracking formula
Uneven Knurl Pattern	<ol style="list-style-type: none"> 1) Knurl wheels are not in centerline of the workpiece 	<ol style="list-style-type: none"> 1) For a symmetric and even knurl pattern on the workpiece, the knurl wheels must to be set on centerline properly

CNC Modular Knurling Tools

With the Flexibility of Multiple Knurling Applications!



Versatility

- Multi diameter diamond knurling cutting style
- Reversible Head for Right or Left knurling.
- Heavy duty knurl cutting and knurl forming
- Double Wheel forming knurling head
- Straddle forming knurling head
- Shoulder forming knurling head
- Wide diameter range for small diameter to large diameter parts

Modular

Three shank sizes interchangeable with seven knurling heads.



Adjustable

Dovetail knurling head locking system.
Quick and precise center line setting.
Knurling wheel angle stationary for diamond cutting

Two Ways to Knurl

Forming (four heads available)

Knurl forming action (material displacement by means of rolling) is generally for special application. It creates a better quality of knurl pattern, but speeds and feeds are sacrificed for this quality. The force applied through forming is increased in larger diameters making knurling difficult and slow.

Cutting (three heads available)

Knurl cutting action cuts a perfect knurl pattern 10 to 20 times faster than any conventional knurling tool. It is engineered to knurl any material, including thin wall tubing, with minimum stress to the spindle and work piece. Knurl cutting action speeds up knurling enough to become applicable for CNC use.

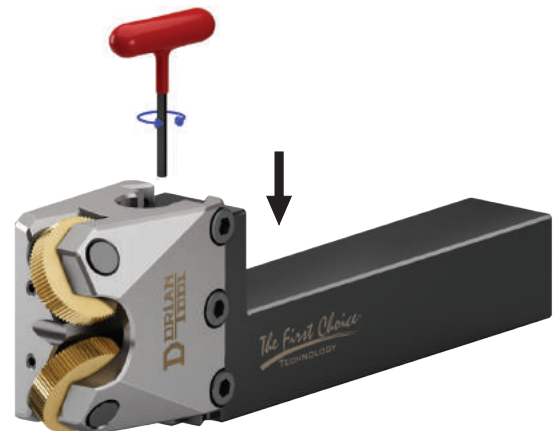

CNC-100-3-M used for examples.

Knurling Tools Cutting Operation

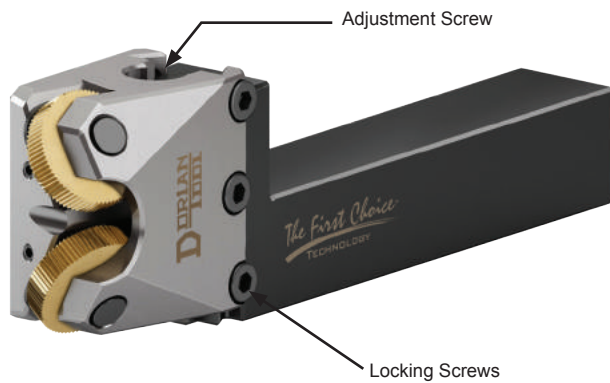

Mounting to the Machine

Clamp the shank at right angles to the axial center line of the machine. The knurl wheels of the knurling tool head should be set exactly on center.

To adjust center-height:

1. Loosen the lock screws.
2. Turning the adjustment screw adjusts the head up or down.
3. Turn adjustment screw until the center height is aligned.
4. Lock head back in place by tightening the lock screws.

Knurling Adjustment Set Up

With the machine spindle rotating slowly, in-feed (Plunge) the tool to make a slight impression for the full width of the cutter. This impression should be equal on both wheels when using Diamond Knurling Head. Misaligned patterns can be corrected by turning the fine adjustment screw in opposite directions.

Starting Cutting Knurl

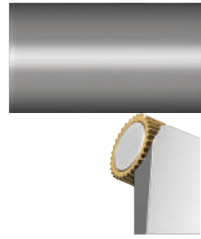

- 1) Touch the workpiece diameter with the knurl wheels.

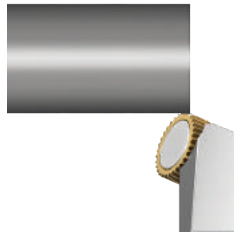

- 2) Move the knurling wheel to the end of the workpiece
Set the cutting depth of the wheel (35% of the circular pitch)

Start knurl

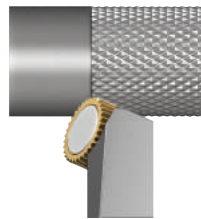

- 3) Use recommended cutting parameters

Use coolant

Knurling head center line adjustments

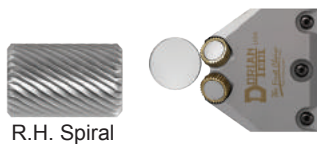

R.H. Spiral

- Knurling tool is too low from center line.
- Top wheel is cutting a deeper R.H. Diagonal Knurl.
- Turn the Fine Center Adjustment Screw until both wheels are on center and touching simultaneously.



L.H. Spiral

- Knurling tool is too high from center line.
- Bottom wheel is cutting a deeper L.H. Diagonal Knurl.
- Turn Fine Center Adjustment Screw until both wheels are on center and touching simultaneously.

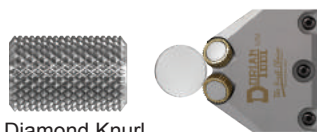

Diamond Knurl

- Tool is on center line.
- Both wheels are touching simultaneously, cutting a perfect diamond knurl.

Full Faced Cutting Knurl Wheel

When cut knurling, a full faced knurl wheel must be used. The edge of the knurl wheel will be cut into the material to be knurled. A sharp edge must be kept to cut a clean and smooth knurl pattern. The knurl wheel can be reground once the edge is dull or chipped.

Edge Prep

Full Faced



Wheel Grinding

When the cutting edges of the knurl wheel become dull, sharpen them by grinding the cutting face of both wheels evenly. You can also grind forming wheels to desired width, but bevel afterwards.

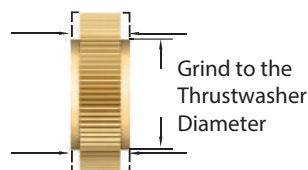

R & M SERIES KNURL WHEEL

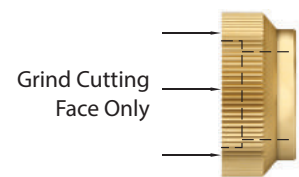

SW SERIES KNURL WHEEL

Easy to set up Simple to operate.

To minimize set up time of knurling application, and simplify the knurling operation, the CNC Modular Knurling Tool has been engineered to create a diamond knurling pattern, without the need of resetting the knurl wheels every time the workpiece diameter changes.

To cover the full range of diameter three modular cutting knurling head have been developed.

- 1) Small diameter modular head
- 2) Medium diameter modular head
- 3) Large diameter modular head

Small Diameter Head

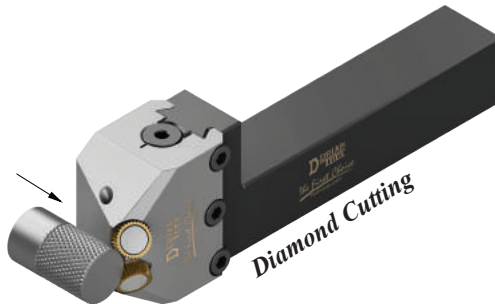

Cutting Range

Small Diameter Cutting Range from 1/2" to 1-1/2"

End feed range: .004" to .012"

- Knurl cutting action
- Twin straight SW series knurl wheels for male diamond pattern
- Supplied with Full Faced SW2S-30-HS knurl wheels - TiN coated

Medium Diameter Head



Medium Diameter Cutting Range from 1" to 5"

End feed range: .004" to .016"

- Knurl cutting action
- Two straight R series knurl wheels for male diamond pattern
- Supplied with Full Faced RS-25-HS knurl wheels - TiN coated

Large Diameter Head



Large Diameter Cutting Range from 2" & up

End feed range: .004" to .025"

- Knurl cutting action
- Two straight M series knurl wheels for male diamond pattern
- Supplied with Full Faced MS-25-HS knurl wheels - TiN coated

How the diamond CNC Modular Knurling tool works.

- 1) Choose the cutting diameter range of the knurl head
- 2) Set the knurling wheel on centerline of the workpiece
- 3) Touch the workpiece diameter with the knurl wheels.
- 4) Set the depth of cut (35% of the circle pitch)
- 6) Start to cut according to recommended cutting parameters

1 Light Duty 60° Diamond Cutting Modular Knurling Head - CNCKH-1-2



Small Diameter Cutting Range 1/2" to 1-1/2"

End feed range: .004" to .012"

- Knurl cutting action
- Twin straight SW series knurl wheels for male diamond pattern
- Supplied with Full Faced SW2S-30-HS knurl wheels - TiN coated

2 Heavy Duty 60° Diamond Cutting Modular Knurling Head - CNCKH-2-R



Medium Diameter Cutting Range 1" to 5"

End feed range: .004" to .016"

- Knurl cutting action
- Two straight R series knurl wheels for male diamond pattern
- Supplied with Full Faced RS-25-HS knurl wheels - TiN coated

3 Extra Heavy Duty 60° Diamond Cutting Modular Knurling Head - CNCKH-3-M



Large Diameter Cutting Range 2" & up

End feed range: .004" to .025"

- Knurl cutting action
- Two straight M series knurl wheels for male diamond pattern
- Supplied with Full Faced MS-25-HS knurl wheels - TiN coated

4 Double Wheel Forming Knurling Modular Head - CNCKH-4-M

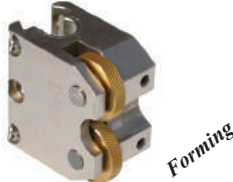

Diameter Range 5/16" & up

End feed range: .004" to .012"

- Knurl Forming action
- Two M series knurl wheels for straight or diamond pattern
- Supplied with Beveled MDR/L-25-HSB knurl wheels - TiN coated

5 Single Wheel Forming Modular Knurling Head - CNCKH-5-O

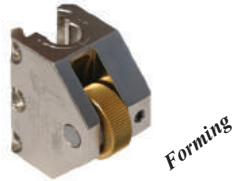

Straight Bump Unlimited Diameter

End feed range: .004" to .012"

- Knurl forming action
- Single O series knurl wheel for straight or diamond pattern
- Supplied with Beveled OS-25-HSB knurl wheel - TiN coated

6 Shoulder Forming Modular Knurling Head - CNCKH-6-4

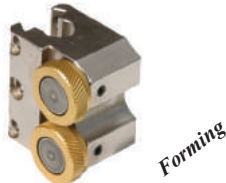

Diameter Range 5/16" & up

End feed range: .004" to .012"

- Knurl forming action
- Two SW series knurl wheels for straight or diamond pattern
- Supplied with Beveled SW4R/L-25-HSB knurl wheels - TiN coated

7 Straddle Forming Modular Knurling Head - CNCKH-7-R

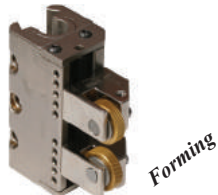

Diameter Range up to 1"

End feed range: .004" to .012"

- Knurl forming action
- Two R series knurl wheels for straight or diamond pattern
- Supplied with Beveled RDR/L-30-HSB knurl wheels - TiN coated



3 Modular Shank Sizes

7 Modular Heads

- Flexibility
- Multiple combinations
- Multiple applications
- Better performance
- Designed for the CNC Lathe
- Precision square shank with preset center height
- Right or Left hand applications
- Interchangeable shanks & heads
- High Speed knurl wheels (TiN coated)
- Supplied with heavy duty parts

1 Light Duty 60° Diamond Cutting Modular Knurling Head + CNC Modular Knurling Tool Shank

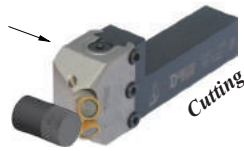

Description	UPC #	Shank Size	Tool Length	Knurl Wheel	Knurl Pin Set		Modular Head
					Description	UPC #	
CNC-75-1-2	20410	.750"	6 7/8"	Series SW2	SW2.0P-2S	29055	CNCKH-1-2
CNC-100-1-2	20420	1.000"	6 7/8"				
CNC-125-1-2	20430	1.250"	7 3/8"				

Supplied with a set of Full Faced straight high speed TiN coated knurl wheels, 30 TPI (.8mm) for a male diamond pattern.

2 Heavy Duty 60° Diamond Cutting Modular Knurling Head + CNC Modular Knurling Tool Shank

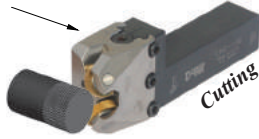

Description	UPC #	Shank Size	Tool Length	Knurl Wheel	Knurl Pin Set		Modular Head
					Description	UPC #	
CNC-75-2-R	20510	.750"	6 7/8"	Series R	KPS-25- 87-C	28925	CNCKH-2-R
CNC-100-2-R	20520	1.000"	6 7/8"				
CNC-125-2-R	20530	1.250"	7 3/8"				

Supplied with a set of Full Faced straight high speed knurl wheels, 25 TPI (1mm) for a male diamond pattern.

3 Extra Heavy Duty 60° Diamond Cutting Modular Knurling Head + CNC Modular Knurling Tool Shank

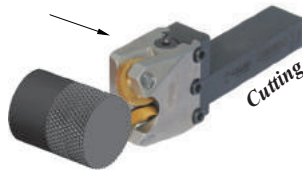

Description	UPC #	Shank Size	Tool Length	Knurl Wheel	Knurl Pin Set		Modular Head
					Description	UPC #	
CNC-75-3-M	20610	.750"	7"	Series M	KPS-31-100-C	28945	CNCKH-3-M
CNC-100-3-M	20620	1.000"	7"				
CNC-125-3-M	20630	1.250"	7 1/2"				

Supplied with a set of Full Faced straight high speed TiN coated knurl wheels, 25 TPI (1mm) for a male diamond pattern

4 Double Wheel Forming Modular Knurling Head + CNC Modular Knurling Tool Shank

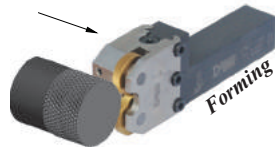

Description	UPC #	Shank Size	Tool Length	Knurl Wheel	Knurl Pin Set		Modular Head
					Description	UPC #	
CNC-75-4-M	20646	.750"	7"	Series M	KPS-31-125-C	28950	CNCKH-4-M
CNC-100-4-M	20648	1.000"	7"				
CNC-125-4-M	20650	1.250"	7 1/2"				

Supplied with a set of Beveled diagonal high speed beveled TiN coated knurl wheels, 25 TPI (1mm) for a male diamond pattern.

5 Single Wheel Forming Modular Knurling Head + CNC Modular Knurling Tool Shank

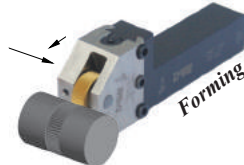

Description	UPC #	Shank Size	Tool Length	Knurl Wheel	Knurl Pin Set		Modular Head
					Description	UPC #	
CNC-75-5-O	20710	.750"	6 3/4"	Series O	KPS-31-125-C	28950	CNCKH-5-O
CNC-100-5-O	20720	1.000"	6 3/4"				
CNC-125-5-O	20730	1.250"	7 1/4"				

Supplied with one Beveled straight high speed beveled TiN coated knurl wheel, 25 TPI (1mm) for a straight pattern

6 Shoulder Forming Modular Knurling Head + CNC Modular Knurling Tool Shank

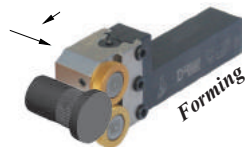

Description	UPC #	Shank Size	Tool Length	Knurl Wheel	Knurl Pin Set		Modular Head
					Description	UPC #	
CNC-75-6-4	20780	.750"	6 3/4"	Series SW4	SW4.0P-2S	29085	CNCKH-6-4
CNC-100-6-4	20790	1.000"	6 3/4"				
CNC-125-6-4	20800	1.250"	7 1/4"				

Supplied with a set of Beveled diagonal high speed beveled TiN coated knurl wheels, 25 TPI (1mm) for a male diamond pattern.

7-R Straddle Forming Modular Knurling Head + CNC Modular Knurling Tool Shank

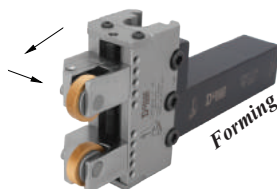

Description	UPC #	Shank Size	Tool Length	Knurl Wheel	Knurl Pin Set		Modular Head
					Description	UPC #	
CNC-75-7-R	20910	.750"	7 3/8"	Series R	KPS-25-75-C	28915	CNCKH-7-R
CNC-100-7-R	20920	1.000"	7 3/8"				
CNC-125-7-R	20930	1.250"	7 7/8"				

Supplied with a set of Beveled diagonal high speed beveled TiN coated knurl wheels, 30 TPI (.8mm) for a male diamond pattern.

1 SMALL Light Duty 60° Diamond Cutting Modular Knurling Head - SCNCKH-1-2

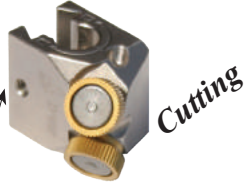

Small Cutting Range 1/2" to 1-1/2"

End feed range: .004" to .012"

- Knurl cutting action
- Twin straight SW series knurl wheels for male diamond pattern
- Supplied with full faced SW2S-30-HS knurl wheels - TiN coated

3 Modular Shank Sizes

3 Modular Heads

- Flexibility
- Multiple combinations
- Multiple applications
- Better performance
- Designed for the CNC Lathe
- Precision square shank with preset center height
- Right or Left hand applications
- Interchangeable shanks & heads
- High Speed knurl wheels (TiN coated)
- Supplied with heavy duty parts



6 SMALL Shoulder Forming Modular Knurling Head - SCNCKH-6-2

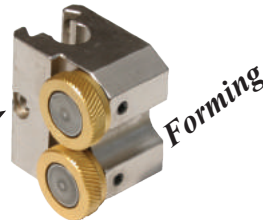

Diameter Range 1/4" & up

End feed range: .004" to .012"

- Knurl forming action
- Twin SW series knurl wheels for straight or diamond pattern
- Supplied with beveled SW2R/L-25-HSB knurl wheels - TiN coated

7-R SMALL Straddle Forming Modular Knurling Head - SCNCKH-7-D

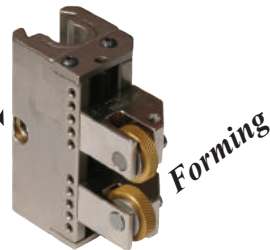

Diameter Range up to 5/8"

End feed range: .004" to .012"

- Knurl forming action
- Twin D series knurl wheels for straight or diamond pattern
- Supplied with beveled DR/L-30-HSB knurl wheels - TiN coated

1 SMALL Light Duty 60° Diamond Cutting Modular Knurling Head + SMALL CNC Modular Knurling Tool Shank

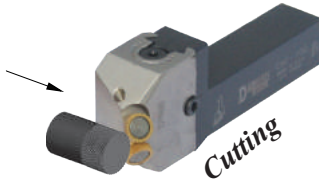

Description	UPC #	Shank Size	Tool Length	Knurl Wheel	Knurl Pin Set		Modular Head Description
					Description	UPC #	
SCNC-37-1-2	20010	3/8"	4"				
SCNC-50-1-2	20020	1/2"	4-1/4"	Series SW2	SW2.0P-2S	29055	SCNCKH-1-2
SCNC-162-1-2	20025	5/8"	4-1/4"				

Supplied with a set of Full Faced straight high speed TiN coated knurl wheels, 30 TPI (.8mm) for a male diamond pattern

6 SMALL Shoulder Forming Modular Knurling Head + SMALL CNC Modular Knurling Tool Shank

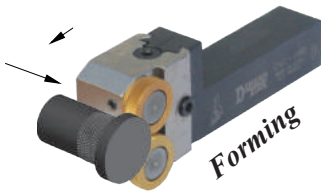

Description	UPC #	Shank Size	Tool Length	Knurl Wheel	Knurl Pin Set		Modular Head Description
					Description	UPC #	
SCNC-37-6-2	20110	3/8"	4"				
SCNC-50-6-2	20120	1/2"	4-1/4"	Series SW4	SW2.0P-2S	29055	SCNCKH-6-2
SCNC-162-6-2	20125	5/8"	4-1/4"				

Supplied with a set of Beveled diagonal high speed TiN coated knurl wheels, 25 TPI (1mm) for a male diamond pattern

7-R SMALL Straddle Forming Modular Knurling Head + SMALL CNC Modular Knurling Tool Shank

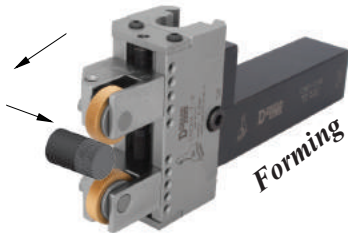

Description	UPC #	Shank Size	Tool Length	Knurl Wheel	Knurl Pin Set		Modular Head Description
					Description	UPC #	
SCNC-37-7-D	20210	3/8"	4-1/2"				
SCNC-50-7-D	20220	1/2"	4-3/4"	Series D	KPS-18-50-C	28905	SCNCKH-7-D
SCNC-162-7-D	20225	5/8"	4-3/4"				

Supplied with a set of Beveled diagonal high speed TiN coated knurl wheels, 30 TPI (.8mm) for a male diamond pattern

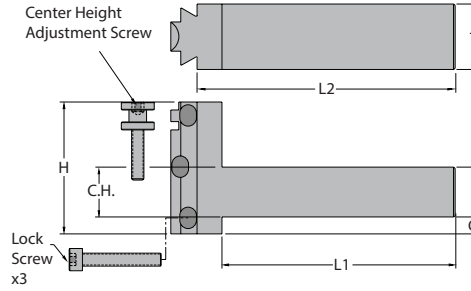

CNC Modular Knurling Tool Shank

Description	UPC #	C.H. & S	G	H	L1	L2	T	Adjustment Screw		Lock Screw Set of 3	
								Description	UPC #	Description	UPC #
CNC-75*	21010	0.750"	0.250	2.000	4.500	4.875	1.000				
CNC-100*	21020	1.000"	0.000	2.000	4.500	4.875	1.000	CNC-1175	28505	CNC-1024**	28515
CNC-125*	21030	1.250"	0.000	2.250	5.000	5.375	1.000				

* Supplied with lock screw set and adjustment screw
 ** One (1) set includes three (3) lock screws

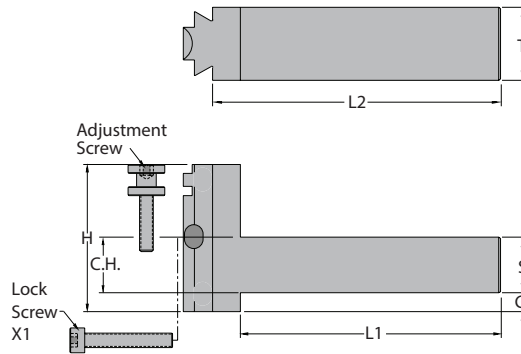

- Easy set-up
- High productivity
- Best knurl quality
- Long knurl wheel life
- Low production cost
- Specifically designed for the CNC Lathe
- Precision square shank with preset center height
- Right or Left hand applications
- Shanks and heads are all interchangeable
- High Speed knurl wheels (TiN coated)
- Carbide knurl pin
- Center height adjustment

CNC Small Modular Knurling Tool Shank

Description	UPC #	C.H. & S	G	H	L1	L2	T	Adjustment Screw		Lock Screw	
								Description	UPC #	Description	UPC #
SCNC-37*	20310	0.375"	0.115	1.000	2.500	2.685	0.750				
SCNC-50*	20320	0.500"	0.000	1.000	2.750	2.935	0.750	SCNC-875	28510	SCNC-832	28520
SCNC-162*	20325	0.625"	0.000	1.125	2.750	2.935	0.750				

* Modular shank supplied with adjustment screw and screw lock

Straddle Style Forming Knurling Tools A diametral adjustment screw regulates the depth of the knurl pattern and the diameter size. The floating head will allow the knurl wheel to self adjust on the work piece - even when the work piece is not perfectly concentric. The tool can be used for twin wheel applications or single wheel knurling applications. This tool comes with a square shank to be used on open slot tool holders, or on a turret, with a preset center height adjustment which will meet the fixed center height of the CNC and the turret lathe. Body and shank are made of heat-treated, precision ground alloy steel. The dovetail guide ensures the most precise accuracy and rigidity for infinite diameter settings.

Heavy Duty Style Forming Knurling Tool

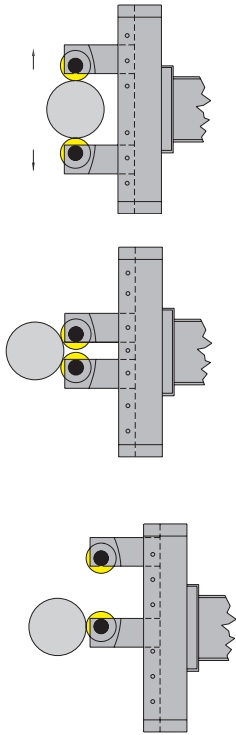

Straddle application is best when pressure and deflection are a problem. The knurling arms are able to "float" somewhat and center on the workpiece, compensating for any off-centering. It has been developed to make a perfect knurling pattern without putting any pressure on the spindle or on the lathe compound.

Bump application is best for narrow knurling applications. The knurling arms are moved closer together so that the tool can "bump" against the side of the working part with two wheels touching the part.

Single wheel application is best for narrow and quick knurling setup. The knurling arms are moved up so that the bottom knurling wheel is locked on center and can "bump" against the side of the working part. With one wheel touching the part, this configuration allows for a quicker setup and knurling of narrow knurling applications.

Uses 2 straight wheels for straight pattern

Uses 2 wheels for 60° diamond pattern
1 Diagonal left
1 Diagonal right

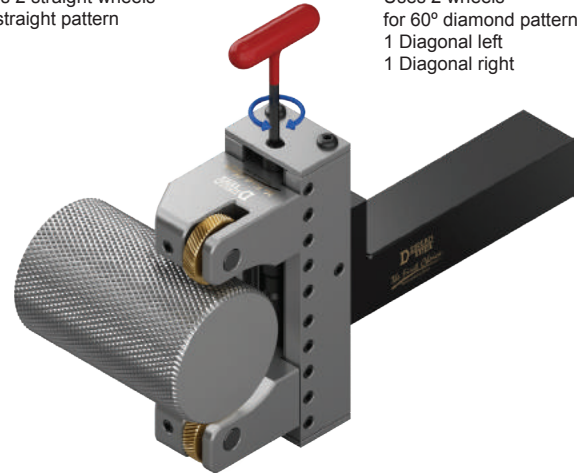

Knurl wheels are supported in a flanged nest to offer best rigidity to handle heavy duty knurling. The knurl wheels are mounted between thrust washers to insure a smooth and even rotation while knurling is performed.

Shoulder Style Forming Knurling Tool

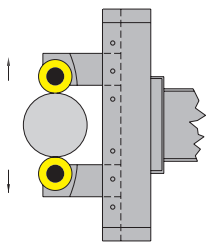

Straddle application is best when pressure and deflection are a problem. The knurling arms are able to "float" somewhat and center on the workpiece, compensating for any off-centering. It has been developed to make a perfect knurling pattern without putting any pressure on the spindle or on the lathe compound.

Designed to knurl against a square shoulder. The knurl wheels are mounted on a thrust washer to insure a smooth and even rotation while knurling is performed. The wheels are held at slight pitch to the work part for better end feeding (feeding across the part towards the chuck).

Uses 2 straight wheels for straight pattern

Uses 2 wheels for 60° diamond pattern
1 Diagonal left
1 Diagonal right

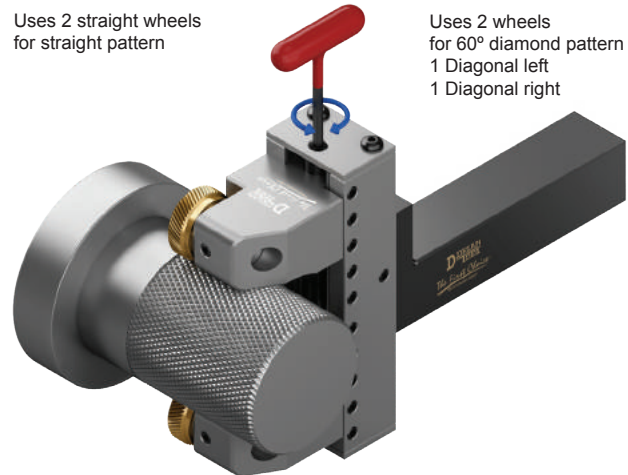

Knurling Tool Shank Mounting

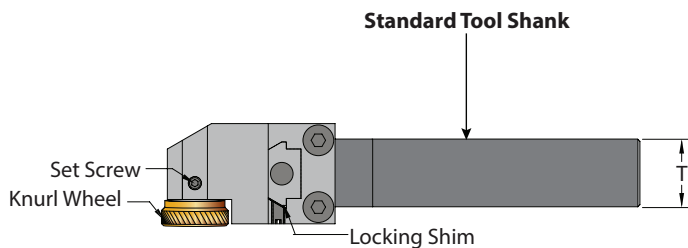

For Standard to Mounting

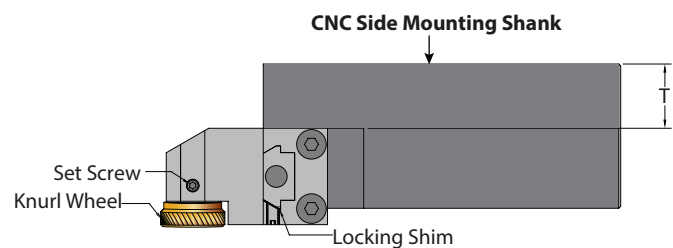

For restricted indexing clearance of the CNC Turret

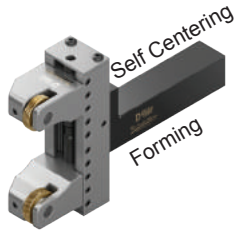

KTM109 Heavy Duty Style Straddle Square Shank Knurling Tool *Reversible Direction*

Description	UPC #	Diameter Range***	Knurl Wheel	Knurl Arm Set		Shank Size
				Supplied	Optional	
KTM109-75-15-M	22814	0 - 1.50" ***	M*	W109-3-25-M	W109-3-25-4	0.750
KTM109-100-15-M	22816		M*	W109-3-25-M	W109-3-25-4	1.000
KTM109-125-15-M	22818		M*	W109-3-25-M	W109-3-25-4	1.250
KTM109-75-25-M	22823	.125 - 2.50" ***	M*	W109-3-25-M	W109-3-25-4	0.750
KTM109-100-25-M	22824		M*	W109-3-25-M	W109-3-25-4	1.000
KTM109-125-25-M	22826		M*	W109-3-25-M	W109-3-25-4	1.250



* Supplied with one (1) set of beveled diagonal high speed TiN coated knurl wheels for a male diamond pattern, 25 TPI

***Warning: This tool has the capability to adjust the wheels until they touch, but physically applying a knurl on small diameters may not be possible

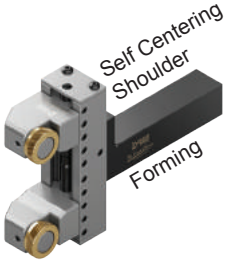

KTW109 Shoulder Style Straddle Square Shank Forming Knurling Tool *Reversible Direction*

Description	UPC #	Diameter Range***	Knurl Wheel	Knurl Arm Set		Shank Size
				Supplied	Optional	
KTW109-75-15-4	22832	0 - 1.50" **	SW4*	W109-3-25-4	W109-3-25-M	0.750
KTW109-100-15-4	22833		SW4*	W109-3-25-4	W109-3-25-M	1.000
KTW109-125-15-4	22834		SW4*	W109-3-25-4	W109-3-25-M	1.250
KTW109-75-25-4	22841	.125 - 2.50" ***	SW4*	W109-3-25-M	W109-3-25-4	0.750
KTW109-100-25-4	22842		SW4*	W109-3-25-M	W109-3-25-4	1.000
KTW109-125-25-4	22843		SW4*	W109-3-25-M	W109-3-25-4	1.250



* Supplied with one (1) set of beveled diagonal high speed TiN coated knurl wheels for a male diamond pattern, 25 TPI

***Warning: This tool has the capability to adjust the wheels until they touch, but physically applying a knurl on small diameters may not be possible

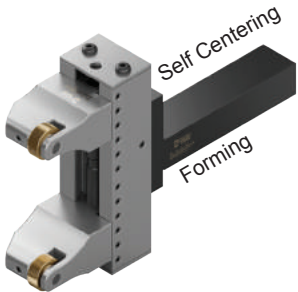

KTO109-40 Heavy Duty Style Straddle Square Shank Knurling Tool *Reversible Direction*

Description	UPC #	Diameter Range***	Knurl Wheel	Knurl Arm Set		Shank Size
				Supplied	Optional	
KTO109-100-40-O	22869	.63 - 4.00"***	O*	W109-3-40-O	W109-3-40-4	1.000
KTO109-125-40-O	22870		O*	W109-3-40-O	W109-3-40-4	1.250



* Supplied with one (1) set of beveled diagonal high speed TiN coated knurl wheels for a male diamond pattern, 25 TPI

***Warning: Physically applying a knurl on small diameters may not be possible

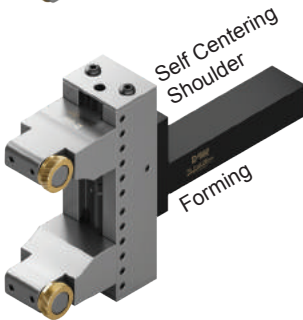

KTW109-40 Shoulder Style Straddle Square Shank Knurling Tool *Reversible Direction*

Description	UPC #	Diameter Range***	Knurl Wheel	Knurl Arm Set		Shank Size
				Supplied	Optional	
KTW109-100-40-4	22873	.63 - 4.00"***	SW4*	W109-3-40-4	W109-3-40-O	1.000
KTW109-125-40-4	22874		SW4*	W109-3-40-4	W109-3-40-O	1.250

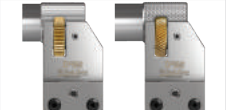

* Supplied with one (1) set of beveled diagonal high speed TiN coated knurl wheels for a male diamond pattern, 25 TPI

***Warning: Physically applying a knurl on small diameters may not be possible

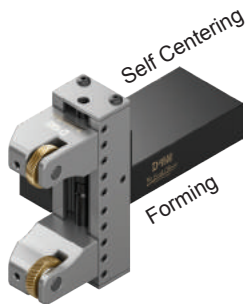

CNC109-M Side Mount Flange Style Square Shank Knurling Tool

Description	UPC #	Diameter Range***	Knurl Wheel	Knurl Arm Set		Shank Size
				Supplied	Optional	
CNC109-75-15-M-R/L	21449 21452	0 - 1.50" ***	M*	W109-3-25-M	W109-3-25-4	0.750
CNC109-100-15-M-R/L	21450 21453		M*	W109-3-25-M	W109-3-25-4	1.000
CNC109-125-15-M-R/L	21451 21454		M*	W109-3-25-M	W109-3-25-4	1.250
CNC109-75-25-M-R/L	21461 21464	.125 - 2.50" ***	M*	W109-3-25-M	W109-3-25-4	0.750
CNC109-100-25-M-R/L	21462 21465		M*	W109-3-25-M	W109-3-25-4	1.000
CNC109-125-25-M-R/L	21463 21466		M*	W109-3-25-M	W109-3-25-4	1.250



* Supplied with one (1) set of beveled diagonal high speed TiN coated knurl wheels, 25 TPI

*** Warning: This tool has the capability to adjust the wheels until they touch, but physically applying a knurl on small diameters may not be possible

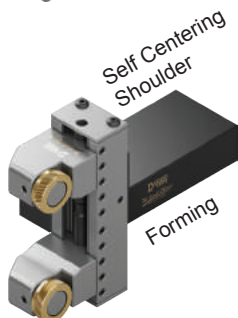

CNC109-4 Side Mount Shoulder Style Square Shank Knurling Tool

Description	UPC #	Diameter Range***	Knurl Wheel	Knurl Arm Set		Shank Size
				Supplied	Optional	
CNC109-75-15-4-R/L	21473 21476	0 - 1.50" ***	SW4*	W109-3-25-4	W109-3-25-M	0.750
CNC109-100-15-4-R/L	21474 21477		SW4*	W109-3-25-4	W109-3-25-M	1.000
CNC109-125-15-4-R/L	21475 21478		SW4*	W109-3-25-4	W109-3-25-M	1.250
CNC109-75-25-4-R/L	21485 21488	.125 - 2.50" ***	SW4*	W109-3-25-4	W109-3-25-M	0.750
CNC109-100-25-4-R/L	21486 21489		SW4*	W109-3-25-4	W109-3-25-M	1.000
CNC109-125-25-4-R/L	21487 21490		SW4*	W109-3-25-4	W109-3-25-M	1.250



* Supplied with one (1) set of beveled diagonal high speed TiN coated knurl wheels, 25 TPI

*** Warning: This tool has the capability to adjust the wheels until they touch, but physically applying a knurl on small diameters may not be possible



SCKN - Self-Centering Knurling Tool **HD SCKN Heavy Duty Self-Centering Knurling Tool** *Reversible Direction*

Description	UPC #	Diameter Range***	Knurl Wheel	Knurl Pin Set		Shank Size
				Description	UPC #	
SCKN-38-DW-D	22151	1/4" & up***	D *	KPS-18-50	28805	0.375
SCKN-50-DW-D	22111		D *	KPS-18-50	28805	0.500
SCKN-162-DW-D	22115		D *	KPS-18-50	28805	0.625
SCKN-75-DW-M	22121	5/16" & up***	M **	KPS-31-100	28845	0.750
SCKN-100-DW-M	22131		M **	KPS-31-100	28845	1.000
SCKN-125-DW-M	22141		M **	KPS-31-100	28845	1.250
HD SCK-75-DW-O	22410	3/4" & up***	O **	KPS-31-125-C	28950	0.750
HD SCK-100-DW-O	22420		O **	KPS-31-125-C	28950	1.000
HD SCK-100-DW-P	22430		P **	KPS-50-125-C	28955	1.000
HD SCK-125-DW-P	22440	1.0" & up ***	P **	KPS-50-125-C	28955	1.250



Supplied with one (1) set of beveled diagonal high speed knurl wheels, *30 TPI, **25 TPI
 *** Warning: May cause deflections on small part diameters, and too much pressure on large diameters



SSCK - Shoulder Self-Centering Knurling Tool *Reversible Direction*

Description	UPC #	Diameter Range***	Knurl Wheel	Knurl Pin Set		Shank Size
				Description	UPC #	
SSCK-38-DW-2	22210	1/4" & up***	SW2 *	SW2.0P-2S	29055	0.375
SSCK-50-DW-2	22220		SW2 *	SW2.0P-2S	29055	0.500
SSCK-162-DW-2	22218		SW2 *	SW2.0P-2S	29055	0.625
SSCK-75-DW-4	22240	5/16" & up***	SW4 **	SW4.0P-2S	29085	0.750
SSCK-100-DW-4	22250		SW4 **	SW4.0P-2S	29085	1.000
SSCK-125-DW-4	22260		SW4 **	SW4.0P-2S	29085	1.250



Supplied with one (1) set of beveled diagonal high speed TiN coated knurl wheels, *30 TPI, **25 TPI
 *** Warning: May cause deflection on small part diameters, and too much pressure on large diameters



3SHKT - Three Swivel Head Knurling Tool *Reversible Direction*

Description	UPC #	Diameter Range***	Knurl Wheel	Knurl Pin Set		Shank Size
				Description	UPC #	
3SHKT-50-D	21510	1/4" & up***	D *	KPS-18-62	28810	0.500
3SHKT-162-D	21515		D *	KPS-18-62	28810	0.625
3SHKT-75-M	21530	5/16" & up ***	M **	KPS-31-100	28845	0.750
3SHKT-100-M	21540		M **	KPS-31-100	28845	1.000
3SHKT-125-M	21550		M **	KPS-31-100	28845	1.250

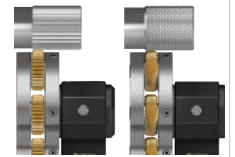

* Supplied with three (3) sets of beveled diagonal right and diagonal left high speed TiN coated knurl wheels, 20 TPI, 30 TPI, 40 TPI
 ** Supplied with three (3) sets of beveled diagonal right and diagonal left high speed TiN coated knurl wheels, 16 TPI, 25 TPI, 35 TPI.
 *** Warning: May cause deflection on small part diameters, and too much pressure on large diameters



FKT - Fixed Forming Knurling Tool

Description	UPC #	Diameter Range***	Knurl Wheel	Knurl Pin Set		Shank Size
				Description	UPC #	
FKT-38-D	21910	1/4" & up***	D *	KPS-18-50	28805	0.375
FKT-50-D	21920		D *	KPS-18-50	28805	0.500
FKT-162-D	21955		D *	KPS-18-62	28810	0.625
FKT-75-M	21930	5/16" & up***	M **	KPS-31-75	28840	0.750
FKT-100-M	21940		M **	KPS-31-100	28845	1.000
FKT-125-O	21950		O **	KPS-31-125	28850	1.250



Supplied with one (1) set of diagonal high speed beveled TiN coated knurl wheels, *30 TPI, ** 25 TPI
 *** Warning: May cause deflection on small part diameters, and too much pressure on large diameters



SFKT - Shoulder Fixed Forming Knurling Tool

Description	UPC #	Diameter Range***	Knurl Wheel	Knurl Pin Set		Shank Size
				Description	UPC #	
SFKT-38-2	22010	1/4" & up***	SW2 *	SW2.0P-2S	29055	0.375
SFKT-50-2	22020		SW2 *	SW2.0P-2S	29055	0.500
SFKT-162-2	22055		SW2 *	SW2.0P-2S	29055	0.625
SFKT-75-4	22030	5/16" & up***	SW4 **	SW4.0P-2S	29085	0.750
SFKT-100-4	22040		SW4 **	SW4.0P-2S	29085	1.000
SFKT-125-4	22050		SW4 **	SW4.0P-2S	29085	1.250

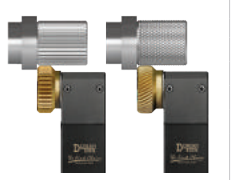

Supplied with one (1) set of beveled diagonal high speed TiN coated knurl wheels, * 30 TPI (0.8mm), ** 25 TPI (1.0mm)
 *** Warning: May cause deflections on small part diameters, and too much pressure on large diameters



SWFKT - Single Wheel Fixed Forming Knurling Tool
HDSWFKT - Heavy Duty Single Wheel Fixed Forming Knurling Tool

Description	UPC #	Diameter Range***	Knurl Wheel	Knurl Pin Set		Shank Size
				Description	UPC #	
SWFKT-831-B	21705	Unlimited***	B *	KPS-12-38	28800	0.312
SWFKT-38-D	21720		D *	KPS-18-50	28805	0.375
SWFKT-50-D	21730		D *	KPS-18-50	28805	0.500
SWFKT-162-D	21765		D *	KPS-18-62	28810	0.625
SWFKT-75-M	21740		M **	KPS-31-75	28840	0.750
SWFKT-100-O	21750		O **	KPS-31-100	28845	1.000
SWFKT-125-O	21760		O **	KPS-31-125	28850	1.250
HDSWFKT-75-O	21810		O **	KPS-31-100-C	28945	0.750
HDSWFKT-100-P	21820		P **	KPS-50-125-C	28955	1.000
HDSWFKT-125-P	21830		P **	KPS-50-125-C	28955	1.250



Supplied with one (1) straight high speed beveled TiN coated knurl wheel, *30 TPI, **25 TPI
 *** Warning: May cause deflection on small part diameters, and too much pressure on large diameters



SSWFKT - Single Shoulder Wheel Fixed Forming Knurling Tool

Description	UPC #	Diameter Range***	Knurl Wheel	Knurl Pin Set		Shank Size
				Description	UPC #	
SSWFKT-38-2	21777	Unlimited***	SW2 *	SW2.0P-1S	29050	0.375
SSWFKT-50-2	21781		SW2 *	SW2.0P-1S	29050	0.500
SSWFKT-162-2	21783		SW2 *	SW2.0P-1S	29050	0.625
SSWFKT-75-4	21789		SW4 **	SW4.0P-1S	29080	0.750
SSWFKT-100-4	21793		SW4 **	SW4.0P-1S	29080	1.000
SSWFKT-125-4	21797		SW4 **	SW4.0P-1S	29080	1.250

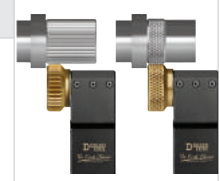

Supplied with one (1) beveled straight high speed TiN coated knurl wheel, * 30 TPI (0.8mm), ** 25 TPI (1.00mm)
 *** Warning: May cause deflection on small part diameters, and too much pressure on large diameters



107ST - Straight Cutting Knurling Tool With A Square Shank For CNC

Description	UPC #		Diameter Range***	Knurl Wheel	Knurl Pin Set		Shank Size
	R.H.	LH.			Description	UPC #	
107ST-50-R-RH/LH	21110	21210	Unlimited***	RDL*	KPS-25-100-C	28930	0.500
107ST-162-R-RH/LH	21115	21215		RDL*	KPS-25-100-C	28930	0.625
107ST-75-M-RH/LH	21130	21230		MDL**	KPS-31-125-C	28950	0.750
107ST-100-M-RH/LH	21140	21240		MDL**	KPS-31-125-C	28950	1.000
107ST-125-M-RH/LH	21150	21250		MDL**	KPS-31-125-C	28950	1.250



Supplied with one (1) full faced diagonal left high speed TiN coated knurl wheel, * 30 TPI, ** 25 TPI
 *** Warning: May cause deflection on small part diameters, and too much pressure on large diameters



107ST - Straight Cutting Shoulder Knurling Tool With A Square Shank For CNC

Description	UPC #		Diameter Range***	Knurl Wheel	Knurl Pin Set		Shank Size
	R.H.	LH.			Description	UPC #	
107ST-50-2-RH/LH	21111	21211	Unlimited***	SW2L*	SW2.0P-1S	29050	0.500
107ST-162-2-RH/LH	21116	21216		SW2L*	SW2.0P-1S	29050	0.625
107ST-75-4-RH/LH	21131	21231		SW4L**	SW4.0P-1S	29080	0.750
107ST-100-4-RH/LH	21141	21241		SW4L**	SW4.0P-1S	29080	1.000
107ST-125-4-RH/LH	21151	21251		SW4L**	SW4.0P-1S	29080	1.250



Supplied with one (1) full faced diagonal left high speed TiN coated knurl wheel, * 30 TPI (.8mm), ** 25 TPI (1.0mm)
 *** Warning: May cause deflection on small part diameters, and too much pressure on large diameters

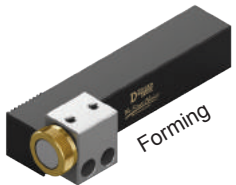

FACEKT - Face Forming Knurling Tool

Description	UPC #	Diameter Range***	Knurl Wheel	Knurl Pin Set		Shank Size
				Description	UPC #	
FACEKT-75-2	21620	Unlimited***	SW2 *	SW2.0P-1S	29050	0.750
FACEKT-100-2	21630		SW2 *	SW2.0P-1S	29050	1.000
FACEKT-75-4	21640		SW4 **	SW4.0P-1S	29080	0.750
FACEKT-100-4	21650		SW4 **	SW4.0P-1S	29080	1.000



Supplied with one (1) beveled straight high speed TiN coated knurl wheel, * 30 TPI (.8mm), ** 25 TPI (1.0mm)
 *** Limited band width from knurl wheel



TIKT - True Internal Forming Knurling Tool

Description	UPC #	Min. Diameter	Knurl Wheel	Knurl Pin Set		Shank Size
				Description	UPC #	
TIKT-50-B	22611	0.562"	B *	KPS-12-38	28800	0.500
TIKT-75-D	22621	1.000"	D *	KPS-18-50	28805	0.750
TIKT-100-R	22631	1.190"	R **	KPS-25-75	28820	1.000
TIKT-125-M	22641	1.500"	M **	KPS-31-100	28845	1.250



Supplied with one (1) set of beveled diagonal high speed knurl wheels, *30 TPI, **25 TPI
 *** Warning: May cause deflections on small part diameters, and too much pressure on large diameters



SIKT - Shoulder Internal Forming Knurling Tool

Description	UPC #	Min. Diameter	Knurl Wheel	Knurl Pin Set		Shank Size
				Description	UPC #	
SIKT-50-2	22610	0.562"	SW2 *	SW2.0P-1S	29050	0.500
SIKT-75-4	22620	1.125"	SW4 **	SW4.0P-1S	29080	0.750
SIKT-100-4	22630	1.125"	SW4 **	SW4.0P-1S	29080	1.000
SIKT-125-4	22640	1.375"	SW4 **	SW4.0P-1S	29080	1.250



Supplied with one (1) beveled straight high speed TiN coated knurl wheel, * 30 TPI, ** 25 TPI.



MMKT - Milling Machine Forming Knurling Tool

Description	UPC #	Knurl Wheel	Knurl Pin Set		Shank Size
			Description	UPC #	
MMKT-38-D	22510	D *	KPS-18-62	28810	0.375
MMKT-50-R	22520	R **	KPS-25-87	28825	0.500
MMKT-75-O	22530	O **	KPS-31-100	28845	0.750
MMKT-100-O	22540	O **	KPS-31-125	28850	1.000
MMKT-125-P	22550	P **	KPS-50-150	28860	1.250

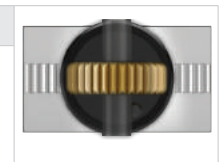

Supplied with one (1) beveled straight high speed TiN coated knurl wheel, *30 TPI (0.8mm), **25 TPI (1.0mm)

3 WHEEL KNURLING TOOL

FOR CUTTING & FORMING

Infinite Lengths with Diameters Small as .085" to 1.500"

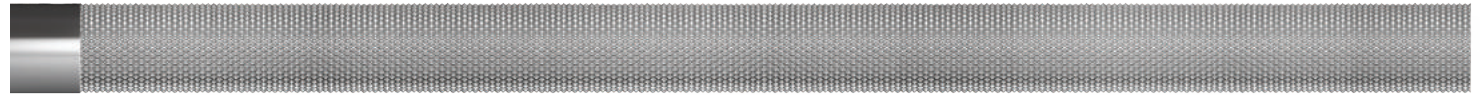

Heavy Duty Shoulderless Carbide Pin



High Speed Pin

PROPERTIES

1. For small diameters

When side pressure does not allow the use of a one or two wheel knurling tool.

2. For long lengths

When support or live center is not permissible. The part would deflect if a standard one or two wheel knurling tool is used.

3. For high precision knurling

When the finished diameter of the knurled part demands close tolerance. The three wheel knurling system applies less pressure per wheel controlling the displacement and the form of the material. This makes the knurl uniform and precise.

4. For high production

High production without sacrificing performance and quality.

5. For automation

When cost is a factor. The high performance of this tool will keep the manufacturing cost lower.

6. Which machine to use on

Automatic Screw Machines, CNC Lathes, and Turret Lathes.

Three wheel knurling tool Features:

- Minimum diameter .085"
- Maximum diameter 1.500"
- For straight or diamond knurl
- Infinite lengths
- Precise scroll gear
- Fine diameter adjustment
- Dial allows for visual diameter adjustment
- Knurl to a shoulder
- Self-adjust to parts and tool misalignment
- Easy to setup
- Simple to operate
- Manual knurl diameter release for manual lathes

3WSKT -Three wheel knurling tool with optional round or square shanks

- Made of heat treated precision ground alloy steel.
- The dovetail guide and adjustable arms ensure the most possible accuracy and rigidity.
- A precise scroll gear allows for fine diameter settings.
- Scaled dial makes setting the diameter easy.
- This tool is engineered for most demanding knurling jobs in Screw Machine, C.N.C. Lathe, and Turret Lathe Applications.
- Square shank can be reversed for right hand or left hand operation.
- Square shank with preset center height.

Resulting Knurl Pattern

Straight pattern with 3 straight wheels

Male 60° diamond pattern with diagonal wheels (2 Right & 1 Left or 2 Left & 1 Right)



Recommended Use:

For best results, use beveled knurl wheels. End-feed the knurling tool into the blank until the desired length of the knurl is done.

The Three Wheel Knurling Tool can knurl up to a shoulder, minimum diameter of 2,16mm up to 38,1mm diameter, and infinite lengths. The Heavy Duty Three Wheel Knurling Tool is recommended for shoulderless applications for improved wheel life.

3 Wheel Knurling Tool Head to the Shoulder

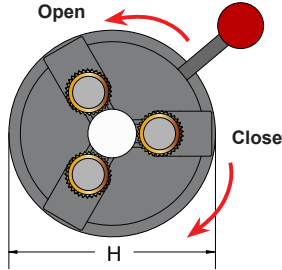

Knurling diameter setting

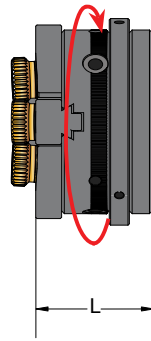

Use to Adjust the knurl Diameter

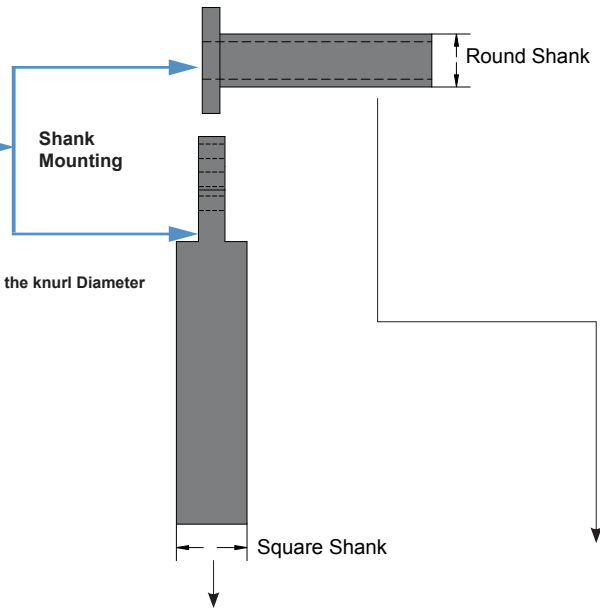

Specifications

Description	UPC #	Max. Capacity	H Body	L Width	Knurl Wheel Style	Knurl Pin Set***	UPC #
3WKT-06-2	23004	.085" to 0.250"	1.750"	1.575"	SW2 *	SW2.0P-3S	29060
3WKT-12-2	23009	.085" to 0.500"	2.250"	1.575"	SW2 *	SW2.0P-3S	29060
3WKT-25-2	23024	0.125" to 1.000"	3.000"	1.575"	SW2 *	SW2.0P-3S	29060
3WKT-40-2	23034	.187" to 1.500"	4.250"	2.440"	SW2 *	SW2.0P-3S	29060

Optional Square Shank

Description	UPC #	Shank Size	
		Square	Length
3WSKT-06-50	23095	.500"	3.00"
3WSKT-06-162	23097	.625"	3.50"
3WSKT-06-75	23099	.750"	4.00"
3WSKT-12-162	23082	.625"	3.50"
3WSKT-12-75	23102	.750"	4.00"
3WSKT-12-100	23078	1.00"	5.00"
3WSKT-25-75	23079	.750"	4.00"
3WSKT-25-100	23080	1.00"	5.00"
3WSKT-40-100	23081	1.00"	5.00"

Optional Round Shank

Description	UPC #	Shank Size	
		Dia.	Length
3WRKT-06-50	23110	.500"	3.00"
3WRKT-06-162	23106	.625"	3.50"
3WRKT-06-75	23111	.750"	4.00"
3WRKT-12-162	23115	.625"	3.50"
3WRKT-12-75	23112	.750"	4.00"
3WRKT-12-100	23114	1.00"	5.00"
3WRKT-25-75	23130	.750"	4.00"
3WRKT-25-100	23124	1.00"	5.00"
3WRKT-40-100	23140	1.00"	5.00"

3-Wheel Knurling Tool Heavy Duty Shoulder-less

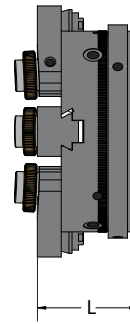
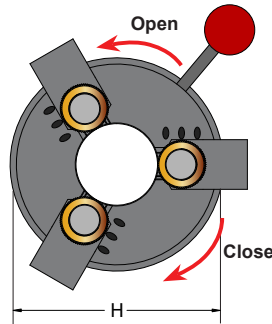

3 Wheels Knurling Tool Head Specification

Description	UPC #	Capacity	H	L	Knurl Wheel Series	Knurl Pin Set	UPC #
3WKT-40-M	23033	.187" to 1.500"	4.250"	2.645"	M**	SM4.0P-3S	29092

Optional Square Shank

Description	UPC #	Shank Size	
		Square	Length
3WSKT-40-100	23081	1.00"	5.00"

Optional Round Shank

Description	UPC #	Shank Size	
		Square	Length
3WRKT-40-100	23140	1.00"	5.00"

Knurling Wheel Tooth Pattern & Workpiece Knurl Pattern

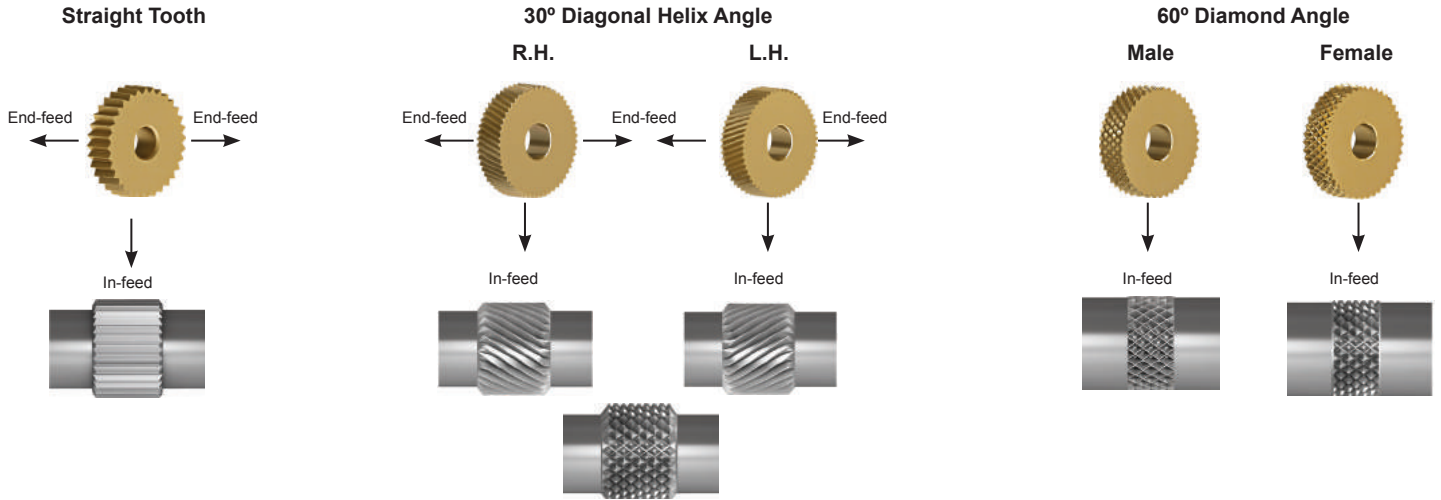

Full Faced: Sharp leading edge for Cutting Type knurling tools only.

Beveled Edge: Edge security for forming type knurling tools only.

Knurl Wheel Material

High Speed Steel Knurl Wheels: Tough and shock resistant. Best recommended for materials such as Carbon Steel, Alloy Steel, and Stainless Steel.

Cobalt Knurl Wheels: The 8.5% cobalt content adds hardness and wear resistance to the wheels. Best recommended for abrasive and soft materials such as Free Machining Steel, Aluminum, and nonferrous materials

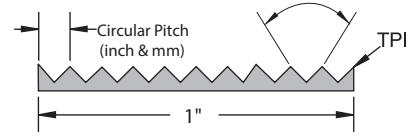

Knurl Wheel Series	Description	Pattern	Grade	Edge Prep	Pitch										
					10 (TPI)	12 (TPI)	14 (TPI)	16 (TPI)	20 (TPI)	25 (TPI)	30 (TPI)	35 (TPI)	40 (TPI)	50 (TPI)	80 (TPI)
A 	AS-TPI-HS	Straight	High Speed	Sharp Corner	23502	23504	23506	23508	23510	23512	23514	23516	23518	23520	-
	AS-TPI-HSB		High Speed	Beveled Corner	-	23537	-	23541	23543	-	-	-	-	-	-
	AS-TPI-C		Cobalt	Sharp Corner	-	-	-	-	23576	23578	23580	23582	-	-	-
	AS-TPI-CB		High Speed	Beveled Corner	-	23603	-	23607	-	23611	23613	23615	23617	23619	-
	ADR-TPI-HS	Diagonal Right	High Speed	Sharp Corner	23634	23636	23638	23640	23642	23644	23646	-	23650	23652	-
	ADR-TPI-HSB		High Speed	Beveled Corner	23667	23669	-	-	23675	23677	-	-	23683	-	-
	ADR-TPI-C		Cobalt	Sharp Corner	23700	23702	-	23706	23708	23710	-	-	-	-	-
	ADR-TPI-CB		High Speed	Beveled Corner	-	-	23737	-	-	23743	-	23747	-	-	-
	ADL-TPI-HS	Diagonal Left	High Speed	Sharp Corner	23766	23768	23770	23772	23774	23776	23778	-	23782	23784	-
	ADL-TPI-HSB		High Speed	Beveled Corner	23799	23801	23803	-	23807	23809	-	-	23815	-	-
	ADL-TPI-C		Cobalt	Sharp Corner	23832	23834	-	23838	23840	23842	-	-	-	-	-
	ADL-TPI-CB		High Speed	Beveled Corner	-	-	23869	-	-	23875	23877	23879	-	-	-
	AM-TPI-HS	Male Diamond	High Speed	Sharp Corner	-	-	-	-	23906	23908	-	-	23914	23916	-
	AM-TPI-HSB		High Speed	Beveled Corner	-	-	-	-	23939	-	-	-	-	-	-
AF-TPI-HS	Female Diamond	High Speed	Sharp Corner	-	-	-	23970	-	-	-	-	-	-	-	
AF-TPI-HSB		High Speed	Beveled Corner	-	-	-	-	-	-	-	-	-	-	-	
B 	BS-TPI-HS	Straight	High Speed	Sharp Corner	-	-	-	-	-	-	-	-	24110	-	-
	BS-TPI-HSB		High Speed	Beveled Corner	-	-	-	-	-	-	24129	-	-	-	24137
	BS-TPI-C		Cobalt	Sharp Corner	-	-	-	-	-	-	24152	24154	24156	24158	-
	BS-TPI-CB		High Speed	Beveled Corner	-	-	-	-	-	-	-	-	-	-	-
	BDR-TPI-HS	Diagonal Right	High Speed	Sharp Corner	-	-	-	-	-	-	-	24200	24202	-	-
	BDR-TPI-HSB		High Speed	Beveled Corner	-	-	-	-	-	-	24221	-	-	-	-
	BDR-TPI-C		Cobalt	Sharp Corner	-	-	-	-	-	-	-	-	24248	-	-
	BDR-TPI-CB		High Speed	Beveled Corner	-	-	-	-	-	-	24267	-	-	-	-
	BDL-TPI-HS	Diagonal Left	High Speed	Sharp Corner	-	-	-	-	-	-	-	24292	24294	-	-
	BDL-TPI-HSB		High Speed	Beveled Corner	-	-	-	-	-	-	24313	-	-	-	-
BDL-TPI-C	Cobalt		Sharp Corner	-	-	-	-	-	-	-	-	24340	-	-	
BDL-TPI-CB	High Speed		Beveled Corner	-	-	-	-	-	-	24359	-	-	-	-	
C 	CS-TPI-HS	Straight	High Speed	Sharp Corner	-	-	-	24502	24504	24506	24508	24510	24512	24514	24516
	CS-TPI-HSB		High Speed	Beveled Corner	-	-	-	-	-	-	-	-	-	-	-
	CS-TPI-C		Cobalt	Sharp Corner	-	-	-	-	-	-	24562	-	24566	24568	24570
	CS-TPI-CB		High Speed	Beveled Corner	-	-	-	-	-	-	-	-	-	-	24597
	CDR-TPI-HS	Diagonal Right	High Speed	Sharp Corner	-	-	-	24610	-	24614	24616	-	-	-	24624
	CDR-TPI-HSB		High Speed	Beveled Corner	-	-	-	-	-	24641	-	-	-	-	-
	CDR-TPI-C		Cobalt	Sharp Corner	-	-	-	-	-	24668	24670	-	24674	-	24678
	CDR-TPI-CB		High Speed	Beveled Corner	-	-	-	-	-	-	-	-	-	-	-
	CDL-TPI-HS	Diagonal Left	High Speed	Sharp Corner	-	-	-	24718	24720	24722	24724	-	-	-	24732
	CDL-TPI-HSB		High Speed	Beveled Corner	-	-	-	-	-	24749	-	-	-	-	-
	CDL-TPI-C		Cobalt	Sharp Corner	-	-	-	-	-	24776	24778	-	24782	-	24786
	CDL-TPI-CB		High Speed	Beveled Corner	-	-	-	-	-	-	-	-	-	-	-
	CM-TPI-HS	Male Diamond	High Speed	Sharp Corner	-	-	-	-	-	-	-	-	24836	-	-
	CM-TPI-HSB		High Speed	Beveled Corner	-	-	-	-	-	-	-	-	-	-	-
CF-TPI-HS	Female Diamond	High Speed	Sharp Corner	-	-	-	-	-	24884	-	-	-	-	24892	
CF-TPI-HSB		High Speed	Beveled Corner	-	-	-	-	-	-	-	-	-	-	-	

NOTE: For forming-type knurling tools, beveled wheels are recommended for longer tool life. For cutting-type tools, full-face (sharp corner) wheels are the only choice. All Dorian Tool knurl wheels are PVD TiN coated to provide less friction and longer tool life. For a complete selection of knurling wheels, please refer to our general catalog.

Knurl Wheel Series	Description	Pattern	Grade	Edge Prep	Pitch										
					10 (TPI)	12 (TPI)	14 (TPI)	16 (TPI)	20 (TPI)	25 (TPI)	30 (TPI)	35 (TPI)	40 (TPI)	50 (TPI)	80 (TPI)
	DS-TPI-HS	Straight	High Speed	Sharp Corner	-	-	-	25001	25003	25005	25007	25009	-	25013	25015
	DS-TPI-HSB		TiN Coated	Beveled Corner	-	-	-	-	25030	25032	25034	25036	25038	25040	-
	DS-TPI-C	Diagonal Right	Cobalt	Sharp Corner	-	-	-	-	25004	25006	25008	25010	-	-	25016
	DS-TPI-CB		TiN Coated	Beveled Corner	-	-	-	-	25031	25033	25035	-	25039	25041	25043
	DDR-TPI-HS	Diagonal Right	High Speed	Sharp Corner	-	-	-	25055	25057	25059	25061	25063	25065	25067	25069
	DDR-TPI-HSB		TiN Coated	Beveled Corner	-	-	-	25082	25084	25086	25088	25090	25092	25094	-
	DDR-TPI-C	Diagonal Left	Cobalt	Sharp Corner	-	-	-	25056	25058	-	25062	-	-	-	-
	DDR-TPI-CB		TiN Coated	Beveled Corner	-	-	-	25083	25085	25087	25089	-	25093	-	25097
	DDL-TPI-HS	Diagonal Left	High Speed	Sharp Corner	-	-	-	25109	25111	25113	25115	25117	25119	25121	25123
	DDL-TPI-HSB		TiN Coated	Beveled Corner	-	-	-	25136	25138	25140	25142	25144	25146	25148	-
	DDL-TPI-C	Female Diamond	Cobalt	Sharp Corner	-	-	-	25110	25112	-	25116	-	-	-	-
	DDL-TPI-CB		TiN Coated	Beveled Corner	-	-	-	25137	25139	25141	25143	-	25147	-	25151
DF-TPI-HS	Female Diamond	High Speed	Sharp Corner	-	-	-	-	-	-	25169	-	-	-	-	
DF-TPI-HSB		TiN Coated	Beveled Corner	-	-	-	-	25192	-	-	-	-	-	-	
DF-TPI-C	Female Diamond	Cobalt	Sharp Corner	-	-	-	-	-	-	25170	-	25174	-	-	
DF-TPI-CB		TiN Coated	Beveled Corner	-	-	-	-	-	-	-	-	-	-	25205	
	MS-TPI-HS	Straight	High Speed	Sharp Corner	25303	25305	25307	25309	25311	25313	25315	25317	-	25321	-
	MS-TPI-HSB		TiN Coated	Beveled Corner	25336	25338	25340	25342	25344	25346	25348	25350	-	-	-
	MS-TPI-C	Diagonal Right	Cobalt	Sharp Corner	25304	25306	25308	25310	25312	25314	25316	25318	-	25322	-
	MS-TPI-CB		TiN Coated	Beveled Corner	25337	25339	25341	25343	25345	25347	25349	-	-	-	-
	MDR-TPI-HS	Diagonal Right	High Speed	Sharp Corner	25369	25371	25373	25375	25377	25379	-	25383	-	-	-
	MDR-TPI-HSB		TiN Coated	Beveled Corner	25402	25404	25406	25408	25410	25412	25414	25416	-	-	-
	MDR-TPI-C	Diagonal Left	Cobalt	Sharp Corner	-	25372	25374	25376	25378	25380	25382	-	25386	-	-
	MDR-TPI-CB		TiN Coated	Beveled Corner	-	25405	25407	25409	25411	25413	25415	-	-	-	-
	MDL-TPI-HS	Diagonal Left	High Speed	Sharp Corner	25435	25437	25439	25441	25443	25445	25447	25449	-	-	-
	MDL-TPI-HSB		TiN Coated	Beveled Corner	25468	25470	25472	25474	25476	25478	25480	25482	-	-	-
	MDL-TPI-C	Female Diamond	Cobalt	Sharp Corner	-	25438	25440	25442	25444	25446	25448	-	25452	-	-
	MDL-TPI-CB		TiN Coated	Beveled Corner	-	25471	25473	25475	25477	25479	25481	-	-	-	-
MF-TPI-HS	Female Diamond	High Speed	Sharp Corner	-	-	-	-	-	-	25513	-	-	-	-	
MF-TPI-HSB		TiN Coated	Beveled Corner	-	-	-	-	-	-	-	-	-	-	-	
MF-TPI-C	Female Diamond	Cobalt	Sharp Corner	-	-	-	-	-	-	25514	-	-	-	-	
MF-TPI-CB		TiN Coated	Beveled Corner	-	-	-	-	25543	-	25547	-	-	-	-	
	OS-TPI-HS	Straight	High Speed	Sharp Corner	25604	25606	25608	25610	25612	25614	25616	25618	-	-	-
	OS-TPI-HSB		TiN Coated	Beveled Corner	-	-	25641	25643	25645	25647	25649	-	-	-	-
	OS-TPI-C	Diagonal Right	Cobalt	Sharp Corner	-	-	25674	25676	25678	25680	25682	25684	-	-	-
	OS-TPI-CB		TiN Coated	Beveled Corner	-	-	25707	25709	25711	25713	-	-	-	-	-
	ODR-TPI-HS	Diagonal Right	High Speed	Sharp Corner	25736	-	-	25742	-	-	-	-	-	-	-
	ODR-TPI-HSB		TiN Coated	Beveled Corner	-	25771	-	-	25777	25779	-	-	-	-	-
	ODR-TPI-C	Diagonal Left	Cobalt	Sharp Corner	-	-	-	-	-	25812	-	-	-	-	-
	ODR-TPI-CB		TiN Coated	Beveled Corner	-	-	25839	-	-	25845	-	-	-	-	-
	ODL-TPI-HS	Diagonal Left	High Speed	Sharp Corner	25868	25870	-	25874	-	-	-	-	-	-	-
	ODL-TPI-HSB		TiN Coated	Beveled Corner	-	25903	-	-	25909	25911	-	-	-	-	-
	ODL-TPI-C	Male Diamond	Cobalt	Sharp Corner	-	-	25938	-	-	25944	-	-	-	-	-
	ODL-TPI-CB		TiN Coated	Beveled Corner	-	-	25971	-	-	25977	-	-	-	-	-
OM-TPI-HS	Female Diamond	High Speed	Sharp Corner	-	-	-	-	26008	26010	26012	-	-	-	-	
OM-TPI-HSB		TiN Coated	Beveled Corner	-	-	-	-	-	26043	-	-	-	-	-	
OF-TPI-HS	Female Diamond	High Speed	Sharp Corner	-	-	-	-	26074	26076	26078	-	-	-	-	
OF-TPI-HSB		TiN Coated	Beveled Corner	-	-	-	-	26107	26109	26111	-	-	-	-	
	PS-TPI-HS	Straight	High Speed	Sharp Corner	-	-	26202	-	-	-	-	-	-	-	-
	PS-TPI-HSB		TiN Coated	Beveled Corner	26215	26217	-	-	-	26225	-	-	-	-	-
	PS-TPI-C	Diagonal Right	Cobalt	Sharp Corner	-	-	-	26238	26240	26242	-	-	-	-	
	PS-TPI-CB		TiN Coated	Beveled Corner	-	-	-	-	26257	26259	26261	-	-	-	-
	PDR-TPI-HS	Diagonal Right	High Speed	Sharp Corner	-	26268	-	-	26274	-	26278	-	-	-	
	PDR-TPI-HSB		TiN Coated	Beveled Corner	-	26285	-	-	-	26293	-	-	-	-	
	PDR-TPI-C	Diagonal Left	Cobalt	Sharp Corner	-	-	-	-	-	-	-	-	-	-	
	PDR-TPI-CB		TiN Coated	Beveled Corner	-	-	-	26323	-	-	-	-	-	-	
	PDL-TPI-HS	Diagonal Left	High Speed	Sharp Corner	-	26336	-	-	26342	-	26346	-	-	-	
	PDL-TPI-HSB		TiN Coated	Beveled Corner	-	26353	-	-	-	26361	-	-	-	-	
	PDL-TPI-C	Male Diamond	Cobalt	Sharp Corner	-	-	-	-	-	-	-	-	-	-	
	PDL-TPI-CB		TiN Coated	Beveled Corner	-	-	-	26391	-	-	-	-	-	-	
PM-TPI-HS	Female Diamond	High Speed	Sharp Corner	-	26404	-	26408	26410	-	-	-	-	-		
PM-TPI-HSB		TiN Coated	Beveled Corner	-	-	-	-	26427	26429	-	-	-	-		
PF-TPI-C	Female Diamond	High Speed	Sharp Corner	-	-	-	26442	-	26446	-	-	-	-		
PF-TPI-CB		TiN Coated	Beveled Corner	-	-	-	26459	-	-	-	-	-	-		

NOTE: For forming-type knurling tools, beveled wheels are recommended for longer tool life. For cutting-type tools, full-face (sharp corner) wheels are the only choice. All Dorian Tool knurl wheels are PVD TiN coated to provide less friction and longer tool life. For a complete selection of knurling wheels, please refer to our general catalog.

Knurl Wheel Series	Description	Pattern	Grade	Edge Prep	Pitch										
					10 (TPI)	12 (TPI)	14 (TPI)	16 (TPI)	20 (TPI)	25 (TPI)	30 (TPI)	35 (TPI)	40 (TPI)	50 (TPI)	80 (TPI)
	RS-TPI-HS	Straight	High Speed TiN Coated	Sharp Corner	26501	26503	26505	26507	26509	26511	26513	26515	26517	26519	-
	RS-TPI-HSB		Beveled Corner	26532	-	26536	26538	26540	26542	26544	-	26548	-	-	
	RS-TPI-C		Cobalt	Sharp Corner	26502	26504	26506	26508	26510	26512	26514	26516	26518	26520	-
	RS-TPI-CB		TiN Coated	Beveled Corner	-	26535	26537	26539	26541	26543	26545	26547	-	-	-
	RDR-TPI-HS	Diagonal Right	High Speed TiN Coated	Sharp Corner	26563	-	26567	26569	26571	26573	26575	-	26579	-	-
	RDR-TPI-HSB		Beveled Corner	-	-	-	-	26604	26606	26608	-	26612	-	-	
	RDR-TPI-C		Cobalt	Sharp Corner	26564	26566	26568	-	26572	26574	26576	-	26580	26582	-
	RDR-TPI-CB		TiN Coated	Beveled Corner	-	-	-	-	26603	-	26607	-	26611	-	-
	RDL-TPI-HS	Diagonal Left	High Speed TiN Coated	Sharp Corner	26625	-	26629	-	26633	26635	26637	26639	26641	-	-
	RDL-TPI-HSB		Beveled Corner	-	-	-	-	26666	26668	26670	-	26674	-	-	
	RDL-TPI-C		Cobalt	Sharp Corner	26626	26628	26630	-	26634	26636	26638	-	26642	26644	-
	RDL-TPI-CB		TiN Coated	Beveled Corner	-	-	-	-	26665	-	26669	-	-	-	-
	RF-TPI-HS	Female Diamond	High Speed TiN Coated	Sharp Corner	-	-	-	-	-	26697	-	-	-	-	-
	RF-TPI-HSB	Beveled Corner	-	-	-	-	-	-	-	-	-	-	-	-	
RF-TPI-C	Female Cobalt	Sharp Corner	-	-	-	-	-	-	-	-	-	26706	-	-	
RF-TPI-CB	Female Diamond	Beveled Corner	-	-	-	-	-	-	-	26731	-	-	-	-	
	SS-TPI-HS	Straight	High Speed TiN Coated	Sharp Corner	-	26804	26806	26808	26810	26812	26814	26816	26818	-	-
	SS-TPI-HSB		Beveled Corner	-	-	-	-	26841	26843	26845	-	-	-	-	
	SS-TPI-C		Cobalt	Sharp Corner	26862	26864	-	26868	26870	26872	26874	-	-	-	-
	SS-TPI-CB		TiN Coated	Beveled Corner	-	26895	-	-	26903	26905	-	-	-	-	
	SDR-TPI-HS	Diagonal Right	High Speed TiN Coated	Sharp Corner	26924	26926	-	-	26934	26936	-	-	26942	-	
	SDR-TPI-HSB		Beveled Corner	-	-	26959	-	-	26965	26967	-	-	-	-	
	SDR-TPI-C		Cobalt	Sharp Corner	-	-	-	-	26994	-	26998	27000	-	27004	-
	SDR-TPI-CB		TiN Coated	Beveled Corner	-	-	-	-	-	-	-	-	27033	-	-
	SDL-TPI-HS	Diagonal Left	High Speed TiN Coated	Sharp Corner	27048	27050	-	-	27058	27060	-	-	-	27066	-
	SDL-TPI-HSB		Beveled Corner	-	-	27083	-	-	27089	-	-	-	-	-	
	SDL-TPI-C		Cobalt	Sharp Corner	-	-	-	-	27118	-	27122	27124	-	27128	-
	SDL-TPI-CB		TiN Coated	Beveled Corner	-	-	-	-	-	-	-	-	27157	-	-
	SM-TPI-HS	Male Diamond	High Speed TiN Coated	Sharp Corner	-	-	-	27178	-	27182	-	-	-	-	-
	SM-TPI-HSB	Beveled Corner	-	-	-	-	-	-	-	-	-	-	-	-	
SF-TPI-HS	Female Diamond	High Speed TiN Coated	Sharp Corner	-	-	-	-	-	-	-	-	27250	27252	-	
SF-TPI-HSB	Beveled Corner	-	-	-	-	-	-	-	-	-	-	-	-		
	SW2S-TPI-HS	Straight	High Speed TiN Coated	Sharp Corner	-	-	-	27401	27403	27405	27407	-	27411	-	-
	SW2S-TPI-HSB		Beveled Corner	-	-	-	-	27428	27430	27432	-	-	-	-	
	SW2S-TPI-C		Cobalt	Sharp Corner	-	-	-	27402	27404	27406	27408	27410	27412	-	-
	SW2S-TPI-CB		TiN Coated	Beveled Corner	-	-	-	27427	27429	27431	27433	27435	27437	27439	-
	SW2R-TPI-HS	Diagonal Right	High Speed TiN Coated	Sharp Corner	-	-	-	27453	-	27457	27459	-	-	-	
	SW2R-TPI-HSB		Beveled Corner	-	-	-	27478	27480	27482	-	-	-	-		
	SW2R-TPI-C		Cobalt	Sharp Corner	-	-	-	27454	27456	27458	-	-	-	-	
	SW2R-TPI-CB		TiN Coated	Beveled Corner	-	-	-	27479	27481	27483	-	-	-	-	
	SW2L-TPI-HS	Diagonal Left	High Speed TiN Coated	Sharp Corner	-	-	-	27501	27503	27505	27507	27509	-	-	
	SW2L-TPI-HSB		Beveled Corner	-	-	-	27526	27528	27530	27532	-	-	-		
	SW2L-TPI-C		Cobalt	Sharp Corner	-	-	-	27504	27506	27508	-	-	-	-	
	SW2L-TPI-CB		TiN Coated	Beveled Corner	-	-	-	27529	27531	27533	-	-	-	-	
	SW2F-TPI-HS	Female Diamond	High Speed TiN Coated	Sharp Corner	-	-	-	27551	-	27555	27557	-	27561	27563	-
	SW2F-TPI-HSB	Beveled Corner	-	-	-	-	-	-	-	-	-	-	-	-	
SW2F-TPI-C	Female Cobalt	Sharp Corner	-	-	-	-	-	-	-	-	-	-	-		
SW2F-TPI-CB	Female Diamond	Beveled Corner	-	-	-	-	-	-	-	-	-	-	-		
	SW4S-TPI-HS	Straight	High Speed TiN Coated	Sharp Corner	-	-	28001	28003	28005	28007	28009	-	28013	-	-
	SW4S-TPI-HSB		Beveled Corner	-	-	28028	28030	28032	28034	28036	-	28040	-	-	
	SW4S-TPI-C		Cobalt	Sharp Corner	-	-	28002	28004	28006	28008	28010	28012	28014	-	-
	SW4S-TPI-CB		TiN Coated	Beveled Corner	-	-	28029	28031	28033	28035	28037	-	28041	28043	-
	SW4R-TPI-HS	Diagonal Right	High Speed TiN Coated	Sharp Corner	-	-	28055	28057	28059	28061	28063	-	-	-	
	SW4R-TPI-HSB		Beveled Corner	-	-	28082	28084	28086	28088	28090	-	-	-		
	SW4R-TPI-C		Cobalt	Sharp Corner	-	-	28056	28058	28060	28062	28064	28066	28068	28070	-
	SW4R-TPI-CB		TiN Coated	Beveled Corner	-	-	28083	28085	28087	28089	28091	28093	-	-	
	SW4L-TPI-HS	Diagonal Left	High Speed TiN Coated	Sharp Corner	-	-	28109	28111	28113	28115	28117	-	-	-	
	SW4L-TPI-HSB		Beveled Corner	-	-	28136	28138	28140	28142	28144	-	-	-		
	SW4L-TPI-C		Cobalt	Sharp Corner	-	-	28110	28112	28114	28116	28118	28120	28122	28124	-
	SW4L-TPI-CB		TiN Coated	Beveled Corner	-	-	28137	28139	28141	28143	28145	28147	-	-	
	SW4F-TPI-HS	Female Diamond	High Speed TiN Coated	Sharp Corner	-	-	28163	28165	28167	-	-	-	-	-	
	SW4F-TPI-HSB	Beveled Corner	-	-	-	-	-	-	-	-	-	-	-		
SW4F-TPI-C	Female Cobalt	Sharp Corner	-	-	-	28166	28168	-	-	-	-	-	-		
SW4F-TPI-CB	Female Diamond	Beveled Corner	-	-	-	28193	28195	-	-	-	-	-			

NOTE: For forming-type knurling tools, beveled wheels are recommended for longer tool life. For cutting-type tools, full-face (sharp corner) wheels are the only choice. All Dorian Tool knurl wheels are PVD TiN coated to provide less friction and longer tool life. For a complete selection of knurling wheels, please refer to our general catalog.

MILLING CUTTERS & INSERTS

- FACE MILLING • CORNER ROUNDING • CHAMFERING
- DOVETAIL • T-SLOT • WOODRUFF KEY SEAT
- SLOT MILLING • SHOULDER MILLING



Convex Radius Cutter - Cutting Rake - 15° for 15° positive square SDGX inserts

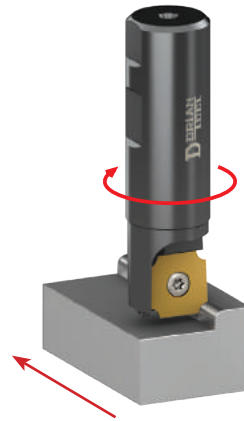
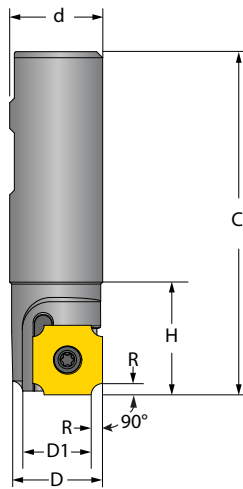

Description	UPC #	C	D	D1	d	R-Range		H	Insert Qty.	SDGX Gage Insert	Torx Key
						Min.	Max.				
QV-062-S304-062	65103	3.250	0.625	0.503	0.625	.0156	.0625	1.000	1	09C_	T-15
QV-100-S608-075	65118	3.500	1.000	0.754	0.750	.0781	.1250	1.000	1	19C_	T-20
QV-100-S608-100	65120	3.625	1.000	0.754	1.000	.0781	.1250	1.125	1		
QV-200-S608-100	65122	3.750	2.000	1.750	1.000	.0781	.1250	1.250	3		
QV-100-S616-075	65130	3.500	1.000	0.510	0.750	.2031	.2500	1.000	1		
QV-100-S616-100	65132	3.750	2.000	1.500	1.000	.2031	.2500	1.250	3		

15° Dovetail Cutter - Cutting Rake - 15° for 15° positive TDEX inserts.

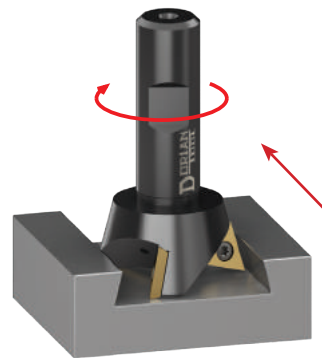
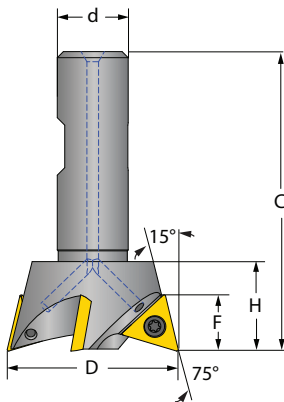

Description	UPC #	C	D	d	F	H	Insert Qty.	TDEX Gage Insert	Insert Torx Screw	Torx Key
D15X-050-TD11-037	65225	2.420	0.500	0.375	0.359	0.420	1	110204	TS-25.45-6M1	T-7
D15X-100-TD11-050	65226	2.420	1.000	0.500	0.359	0.420	3			
D15X-187-TD16-075	65227	3.200	1.875	0.750	0.550	0.750	3	160308	TS-4.7-10M1	T-15
D15X-250-TD22-100	65228	3.750	2.500	1.000	0.750	1.000	3	220408	TS-5.8-10M1	T-20

45° Dovetail Cutter- Cutting Rake - 11° for 11° positive TDEX inserts.

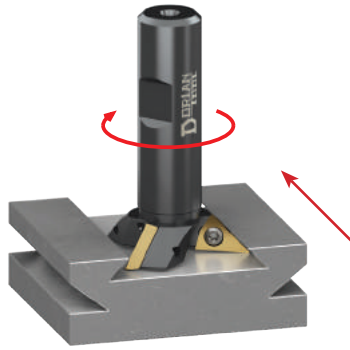
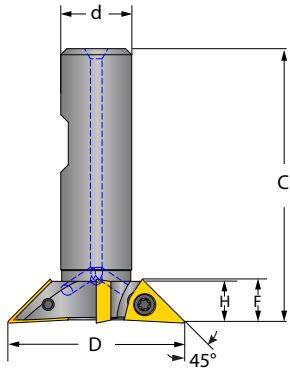

Description	UPC #	C	D	d	F	H	Insert Qty.	TDEX Gage Insert	Insert Torx Screw	Torx Key
D45X-050-TD09-037	65233	2.390	0.500	0.375	0.247	0.125	1	090202	TS-25.45-6M1	T-7
D45X-075-TD09-037	65234	2.390	0.750	0.375	0.247	0.214	2			
D45X-100-TD09-050	65235	2.390	1.000	0.500	0.250	0.244	3			
D45X-137-TD17-062	65236	2.940	1.375	0.625	0.375	0.320	2	17T304	TS-4.7-8M1	T-15
D45X-187-TD17-075	65237	2.940	1.875	0.750	0.468	0.444	3			
D45X-225-TD25-100	65238	3.500	2.250	1.000	0.700	0.696	2	250404	TS-5.8-10M1	T-20
D45X-250-TD25-100	65239	3.500	2.500	1.000	0.700	0.700	3			

60° Dovetail Cutter - Cutting Rake - 15° for 15° positive triangle TDEX inserts.

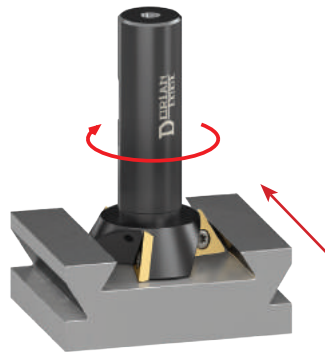
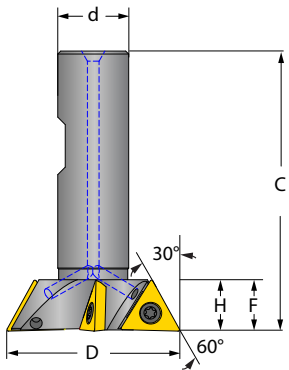

Description	UPC #	C	D	d	F	H	Insert Qty.	TDEX Gage Insert	Insert Torx Screw	Torx Key
D60X-050-TD11-037	65244	2.390	0.500	0.375	0.325	0.142	1	110204	TS-25.45-6M1	T-7
D60X-075-TD11-037	65245	2.390	0.750	0.375	0.325	0.282	2			
D60X-100-TD11-050	65246	2.390	1.000	0.500	0.325	0.375	3			
D60X-137-TD16-062	65247	2.862	1.375	0.625	0.510	0.550	3	160308	TS-4.7-8M1	T-15
D60X-187-TD16-075	65248	3.000	1.875	0.750	0.510	0.550	3		TS-4.7-10M1	T-15
D60X-225-TD22-100	65249	3.500	2.250	1.000	0.700	0.750	3	220408	TS-5.8-10M1	T-20
D60X-250-TD22-100	65250	3.500	2.500	1.000	0.700	0.750	3			

Double 30° Chamfer Mill - Cutting Rake - 15° for 15° positive triangle TDEX inserts

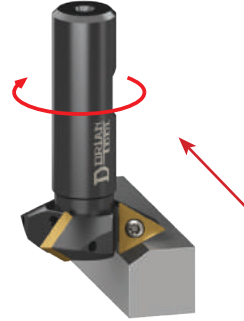
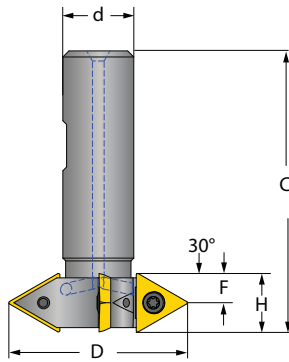

Description	UPC #	C	D	d	F	H	Insert Qty.	TDEX Gage Insert	Insert Torx Screw	Torx Key
C60-075-TD11-037	65252	2.390	0.750	0.375	0.205	0.410	1	110204	TS-25.45-6M1	T-7
C60-100-TD11-050	65253	2.390	1.000	0.500	0.205	0.410	3			
C60-150-TD16-062	65255	3.000	1.500	0.625	0.313	0.627	3	160308	TS-4.7-8M1	T-15
C60-250-TD22-100	65258	3.500	2.500	1.000	0.422	0.844	3	220408	TS-5.8-10M1	T-20

Double 45° Chamfer Mill - Cutting Rake - 15° for 15° positive square SDHW & SPMT inserts

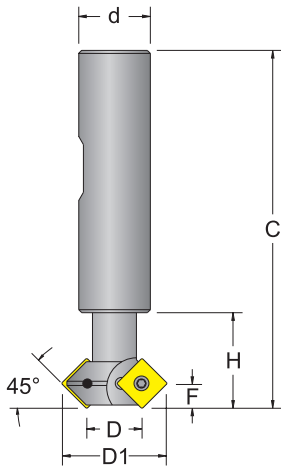

Description	UPC #	C	D	D1	d	F	H	Insert Qty.	SDHW Gage Insert	Insert Torx Screw	Torx Key
C45-112-SD09-075	65414	3.375	0.625	1.125	0.750	0.230	0.750	2	090308	TS-4.7-8M1	T-15
C45-125-SD09-075	65416	3.375	0.772	1.250	0.750	0.230	0.750	2			
C45-150-SD09-100	65418	3.500	1.040	1.500	1.000	0.230	1.000	3			
C45XL-112-SD09-075	65420	7.750	0.625	1.125	0.750	0.230	0.750	2			
C45XL-150-SD09-100	65421	7.750	1.040	1.500	1.000	0.230	1.000	3			

Description	UPC #	C	D	D1	d	F	H	Insert Qty.	SPMT Gage Insert	Insert Torx Screw	Torx Key
C45-062-SP06-062	65410	3.000	0.325	0.625	0.625	0.159	0.750	1	060304	TS-25-45-6M1	T-7
C45-075-SP06-062	65411	3.000	0.448	0.750	0.625	0.159	0.750	2			

WOODRUFF KEY SEAT CUTTER Cutting Rake - 20° for positive TEHW inserts

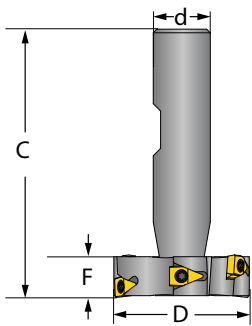

Description	UPC #	C	D	d	F	Insert Qty.	TEHW Gage Insert	Insert Torx Screw	Torx Key
DWKC-806-TEO6-050	65141	2.250	0.750	0.500	0.250	2	0602	TS-06	T-6
DWKC-607-TEO6-050	65142	2.188	0.875	0.500	0.188	2			
DWKC-707-TEO6-050	65143	2.219	0.875	0.500	0.219	2			
DWKC-807-TEO6-050	65144	2.250	0.875	0.500	0.250	2			
DWKC-608-TEO6-050	65145	2.188	1.000	0.500	0.188	3			
DWKC-708-TEO6-050	65146	2.219	1.000	0.500	0.219	3			
DWKC-808-TEO6-050	65147	2.250	1.000	0.500	0.250	3			
DWKC-1008-TEO6-050	65148	2.313	1.000	0.500	0.313	3			
DWKC-609-TEO6-050	65150	2.188	1.125	0.500	0.188	4			
DWKC-709-TEO6-050	65151	2.219	1.125	0.500	0.219	4			
DWKC-809-TEO6-050	65152	2.250	1.125	0.500	0.250	4			
DWKC-1009-TEO6-050	65153	2.313	1.125	0.500	0.313	4			
DWKC-710-TEO6-050	65155	2.219	1.250	0.500	0.219	6			
DWKC-1210-TEO6-050	65158	2.375	1.250	0.500	0.375	6			
DWKC-811-TEO6-050	65159	2.250	1.375	0.500	0.250	6			
DWKC-1011-TEO6-050	65160	2.313	1.375	0.500	0.313	6			
DWKC-1211-TEO6-050	65161	2.375	1.375	0.500	0.375	6			
DWKC-1012-TEO6-050	65163	2.313	1.500	0.500	0.313	6			
DWKC-1212-TEO6-050	65164	2.375	1.500	0.500	0.375	6			

T-SLOT CUTTER Cutting Rake - 20° for SPMT and SDHW positive inserts

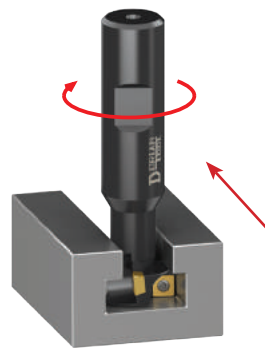
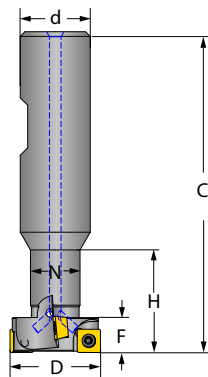

Description	UPC #	C	D	d	F	H	N	No. Inserts	No. Flutes	Gage Insert	Insert Torx Screw	Torx Key
SLOT-078-SP06-075	65183	3.250	0.781	0.750	0.328	0.928	0.406	2	1	SPMT-060304	TS-25.45-6M2	T-8
SLOT-097-SP06-075	65184	3.438	0.969	0.750	0.390	1.100	0.531	4	2			
SLOT-125-SP06-100	65185	3.938	1.250	1.000	0.484	1.375	0.656	3	1			
SLOT-147-SD09-100	65186	4.438	1.469	1.000	0.625	1.757	0.781	4	2	SDHW-090308	TS-35.6-9M1	T-15
SLOT-184-SD09-125	65187	4.813	1.844	1.250	0.828	2.108	1.031	5	2			
SLOT-222-SD09-125	65188	5.375	2.219	1.250	1.094	2.714	1.281	6	2			

30°, 45° and 60° Chamfer Mill - Cutting Rake - 11° for 11° positive triangle TPHT inserts

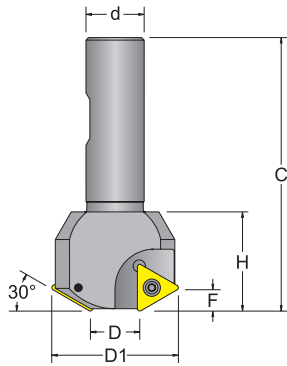

Description		UPC #	C	D	D1	d	F	H	Insert Qty.	TPHT Gage Insert	Insert Torx Screw	Torx Key
30°	C30-062-TP3-075	65400	3.500	1.600	0.750	0.625	0.275	1.250	2	32.52	TS-4.7-8M1	T-15
45°	C45-075-TP3-075	65402		1.517		0.750	0.392					
60°	C60-100-TP3-075	65404		1.560		1.000	0.484					

2" 90° End Mill - Cutting Rake - 20° for 7° positive triangle TC_T inserts

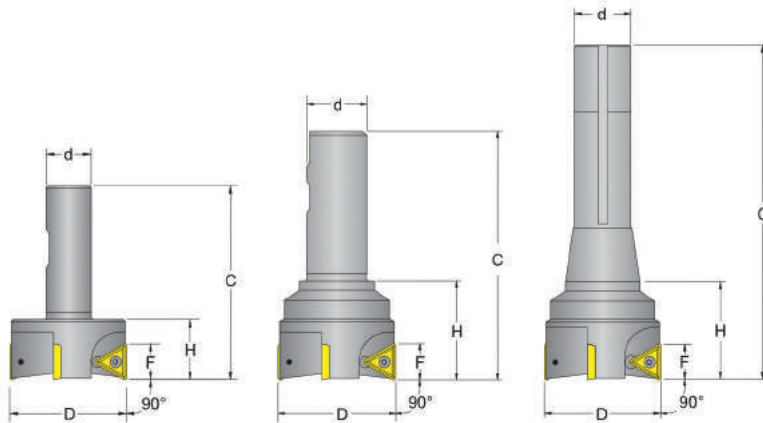

Description	UPC #	C	D	d	F	H	Insert Qty.	TC_T Gage Insert	Insert Torx Screw	Torx Key
E90-200-TC3-075	65800	3.250	2.000	0.750	0.625	1.000	3	32.52	TS-4.7-8M1	T-15
E90-200-TC3-100	65802	4.000		1.000		1.500		32.52		
E90-200-TC3-R8	65804	5.625		R8		1.500		32.52		

High Positive 90° Milling Cutter- Cutting Rake - 20° for 11° positive 85° parallelogram AP_ inserts

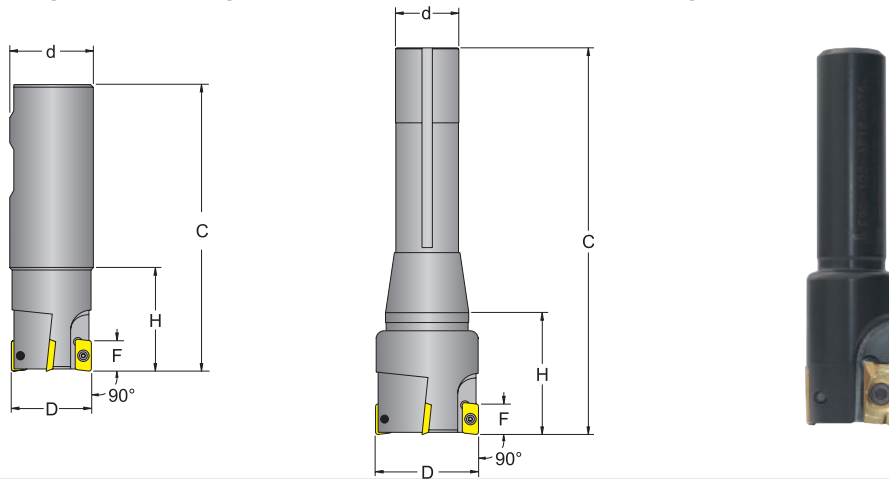

End Mill Description	UPC #	C	D	d	F	H	Insert Qty.	APKT Gage Insert	Insert Torx Screw	Torx Key
E90-038-AP10-050	65600	3.000	0.375	0.500	0.390	1.000	1	1003	TS-25.45-6M1	T-7
E90-044-AP10-062	65601	3.250	0.437	0.625	0.390	1.062	1			
E90-050-AP10-062	65602	3.250	0.500	0.625	0.390	1.062	1			
E90-062-AP10-062	65604	3.250	0.625	0.625	0.390	1.062	2			
E90-075-AP10-075	65606	3.375	0.750	0.750	0.390	1.125	2			
E90-087-AP10-075	65608	3.375	0.875	0.750	0.390	1.125	3			
E90-100-AP10-075	65610	3.500	1.000	0.750	0.390	1.125	3			
E90-100-AP10-100	65612	4.000	1.000	1.000	0.390	1.250	3			
E90-125-AP10-100	65614	4.000	1.250	1.000	0.390	1.250	4			
E90-150-AP10-100	65616	4.000	1.500	1.000	0.390	1.250	5			
E90-200-AP10-100	65618	4.000	2.000	1.000	0.390	1.250	6			
E90-200-AP10-R8	65619	5.625	2.000	R8	0.390	1.640	6			

High Positive 90° Milling Cutter- Cutting Rake - 20° for 11° positive 85° parallelogram AP_ inserts

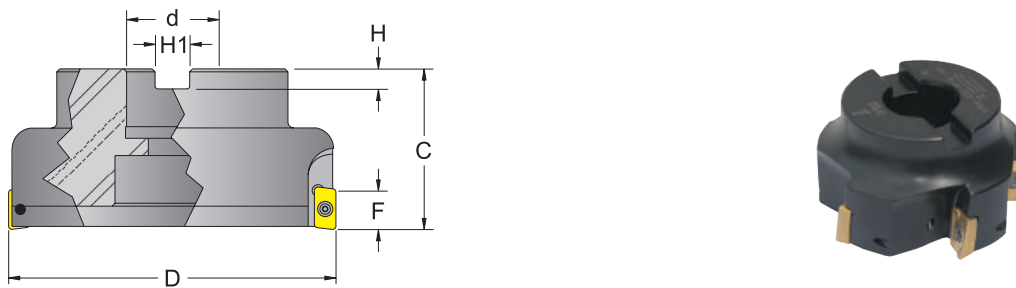

Face Mill Description	UPC #	C	D	d	F	H	H1	Insert Qty.	APKT Gage Insert	Insert Torx Screw	Torx Key
E90A-200-AP10-075	65632	1.570	2.000	0.750	0.390	0.187	0.312	6	1003	TS-25.45-6M1	T-7
E90A-250-AP10-100	65634	1.750	2.500	1.000	0.390	0.219	0.375	8			

High Positive 90° Milling Cutter- Cutting Rake - 20° for 11° positive 85° parallelogram AP_ inserts

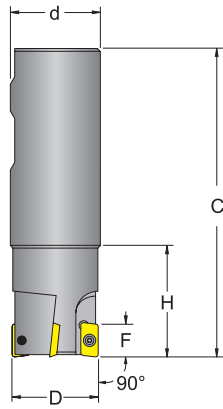

End Mill Description	UPC #	C	D	d	F	H	Insert Qty.	APKT Gage Insert	Insert Torx Screw	Torx Key
E90-100-AP16-075	65646	4.000	1.000	0.750	0.618	1.625	2	1604	TS-4.7-8M1	T-15
E90-100-AP16-100	65648	4.500	1.000	1.000	0.618	1.750	2			
E90-125-AP16-100	65650	4.500	1.250	1.000	0.618	1.625	3			
E90-150-AP16-100	65652	4.500	1.500	1.000	0.618	1.625	3			
E90-150-AP16-125	65654	4.500	1.500	1.250	0.618	1.625	3			

High Positive 90° Milling Cutter- Cutting Rake - 20° for 11° positive 85° parallelogram AP_ inserts

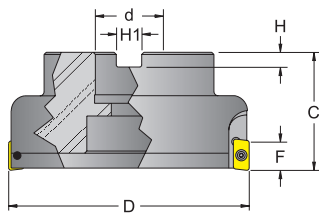

Face Mill Description	UPC #	C	D	d	F	H	H1	Insert Qty.	APKT Gage Insert	Insert Torx Screw	Torx Key
E90A-200-AP16-075	65662	1.570	2.000	0.750	0.618	0.187	0.312	5	1604	TS-4.7-10M1	T-15
E90A-250-AP16-100	65664	1.750	2.500	1.000	0.618	0.219	0.375	5			
E90A-300-AP16-100	65666	1.750	3.000	1.000	0.618	0.219	0.375	5			
E90A-400-AP16-150	65668	2.000	4.000	1.500	0.618	0.375	0.625	8			
E90A-500-AP16-150	65670	2.380	5.000	1.500	0.618	0.375	0.625	10			

Extended 90° Milling Cutter - Cutting Rake - 20° for 11° positive 85° parallelogram AP_ inserts

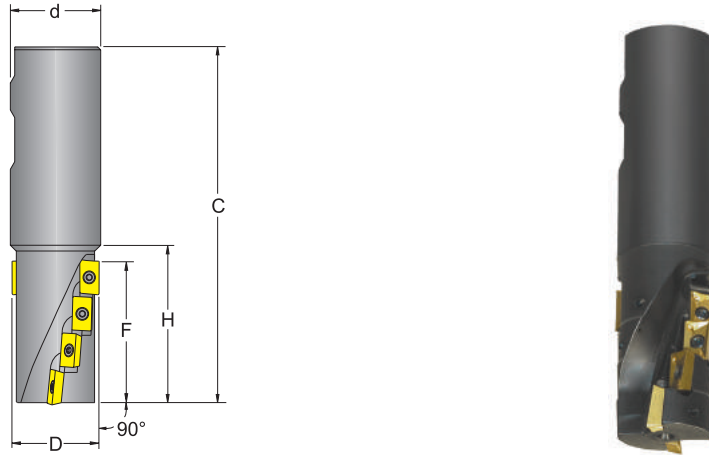

End Mill Description	UPC #	C	D	Shank Size	F	H	Insert Qty.	Flutes Qty.	APKT Gage Insert	Insert Torx Screw	Torx Key
EX90-075-AP10-075	65680	3.500	0.750	0.750	1.125	1.500	4	1	1003	TS-25.45-6M1	T-7
EX90-100-AP10-100	65682	4.250	1.000	1.000	1.500	1.875	8	2			
EX90-125-AP10-125	65684	4.500	1.250	1.250	1.875	2.125	12	4			

Extended 90° Milling Cutter - Cutting Rake - 20° for 11° positive 85° parallelogram AP_ inserts

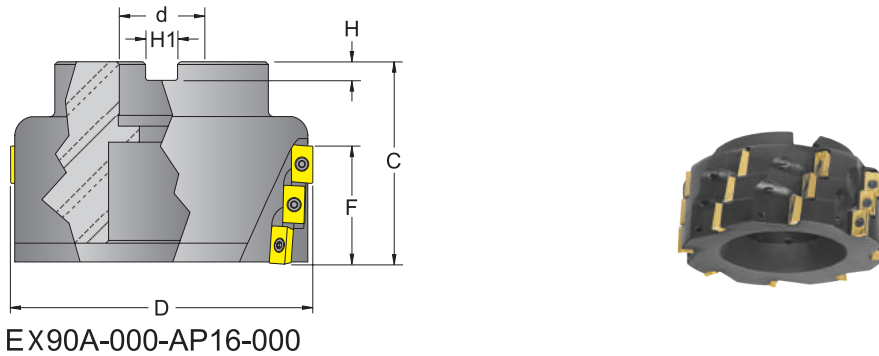

Face Mill Description	UPC #	C	D	d	F	H	H1	Insert Qty.	Flutes Qty.	APKT Gage Insert	Insert Torx Screw	Torx Key
EX90A-200-AP16-100	65690	2.000	2.000	1.000	1.000	0.219	0.375	6	3	1604	TS-4.7-8M1	T-15
EX90A-250-AP16-100	65692	2.500	2.500	1.000	1.750	0.219	0.375	12	4			
EX90A-300-AP16-125	65694	2.500	3.000	1.250	1.750	0.281	0.500	15	5			
EX90A-500-AP16-150	65698	2.500	5.000	1.500	1.750	0.375	0.625	24	8			

90° Aluminum Milling Cutter - Cutting Rake - 7° for 7° positive 35° diamond VCGT inserts

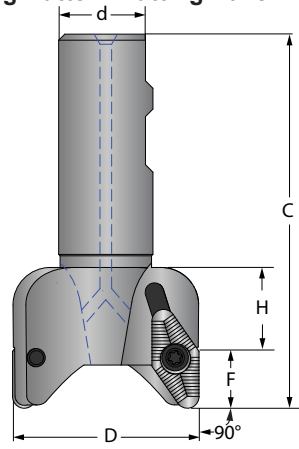

End Mill

Description	UPC #	C	D	d	F	H	Insert Qty.	VCGT Gage Insert	Insert Torx Screw	Torx Key
E90-200-VC22-075	65504	3.750	2.000	0.750	0.610	1.500	2	448	TS-5.8-10M1	T-20
E90-200-VC22-100	65505	4.000	2.000	1.000	0.610	1.500	2			

90° Aluminum Milling Cutter - Cutting Rake - 7° for 7° positive 35° diamond VCGT inserts

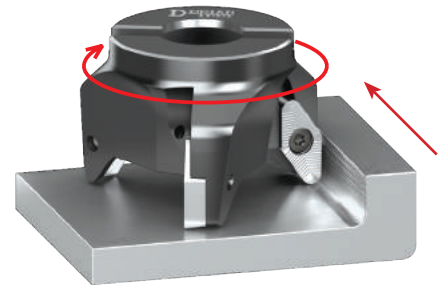
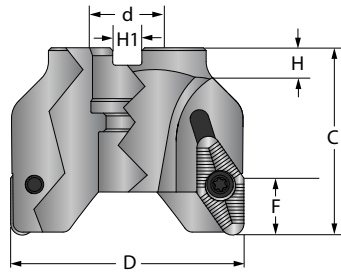

Face Mill

Description	UPC #	C	D	d	F	H	H1	Insert Qty.	VCGT Gage Insert	Insert Torx Screw	Torx Key
E90A-200-VC16-075	65509	2.000	2.000	0.750	0.552	0.187	0.312	2	160412	TS-4.7-8M1	T-15
E90A-250-VC22-075	65510	2.000	2.500	0.750	0.610	0.187	0.312	2			
E90A-300-VC22-100	65511	2.000	3.000	1.000	0.610	0.219	0.375	3	220432	TS-5.8-10M1	T-20
E90A-400-VC22-150	65512	2.000	4.000	1.500	0.610	0.375	0.625	3			
E90A-500-VC22-150	65513	2.000	5.000	1.500	0.610	0.375	0.625	3			
E90A-600VC22-150	65514	2.000	6.000	1.500	0.610	0.375	0.625	6			

Concave 90° Milling Cutter - Cutting Rake - 20° for 11° positive 85° parallelogram APKT inserts

For APKT-1604 inserts with corner radius up to .125"

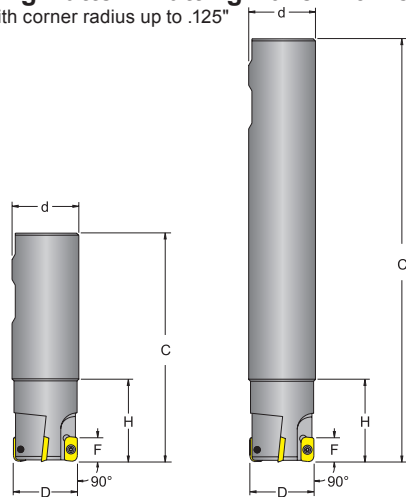

Description	UPC #	C	D	d	F	H	Insert Qty.	APKT Gage Insert	Insert Torx Screw	Torx Key
E90-100-AP16R-075	65674	4.000	1.000	0.750	0.618	1.625	2	160416 160424 160432	TS-4.7-8M1	T-15
E90-125-AP16R-100	65675	4.500	1.250	1.000	0.618	1.625	3			
E90-100-AP16R-100	65676	7.875	1.000	0.750	0.618	1.625	3			
E90-125-AP16R-100	65677	8.625	1.250	1.000	0.618	1.625	3			

Recycle CNMG-432

4 Turning Edges + 4 Milling Edges

After the cutting edges are used on your turning tool holder, **do not throw the insert away, it can be used in this milling cutter** to utilize four more cutting edges that were not used in your lathe work.

From USED TURNING to NEW MILLING

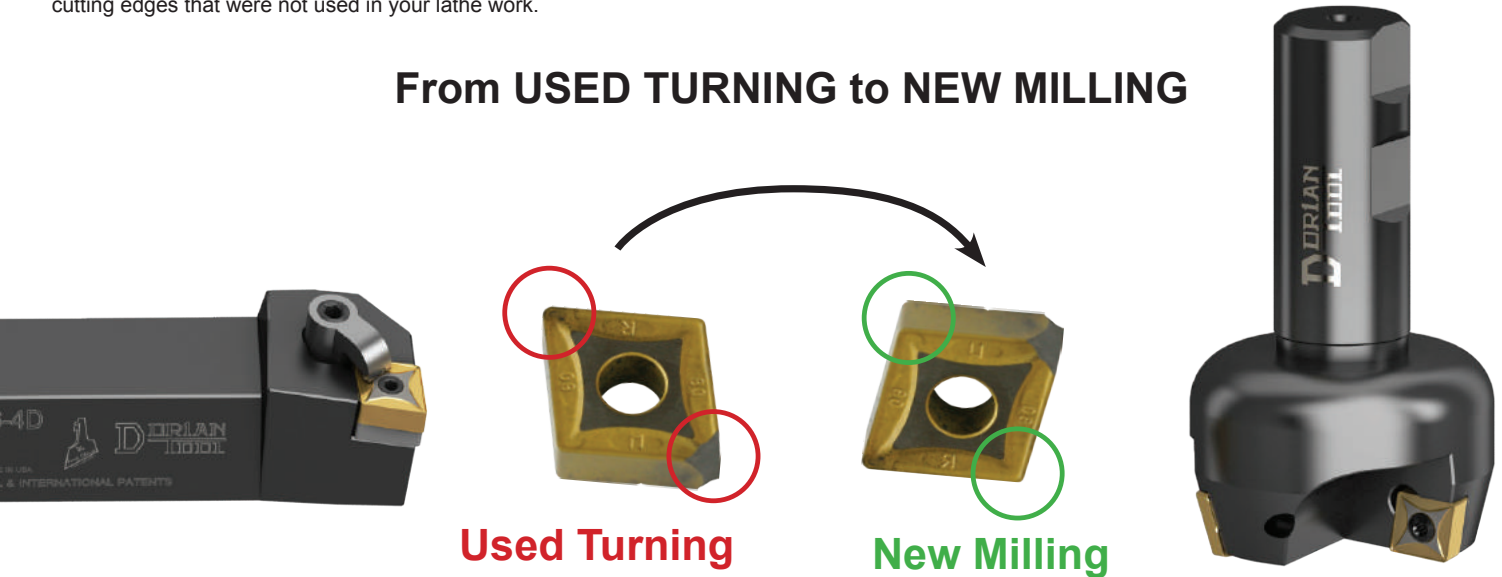

15° CNMG Recycle Milling Cutter - Cutting Rake - Negative 7° for Negative 80° diamond CNMG inserts

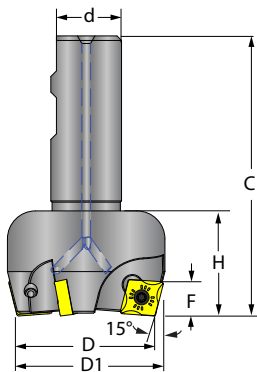

End Mill

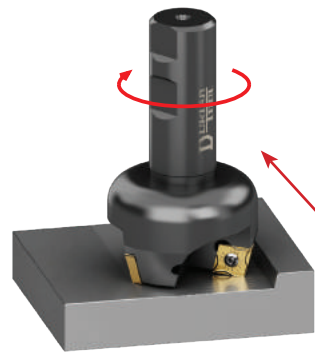

Description	UPC #	C	D	D1	d	F	H	Insert Qty.	CNMG Gage Insert	Insert Torx Screw	Torx Key
REC15-200-CN4-075	65850	3.750	2.000	2.250	0.750	0.450	1.500	3	432	TS-1032-5M1	T-20
REC15-200-CN4-100	65852	4.000	2.000	2.250	1.000	0.450	1.500	3			
REC15-200-CN4-R8	65854	5.625	2.000	2.250	R8	0.450	1.750	3			

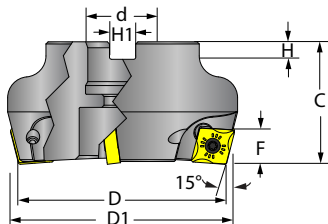

Face Mill

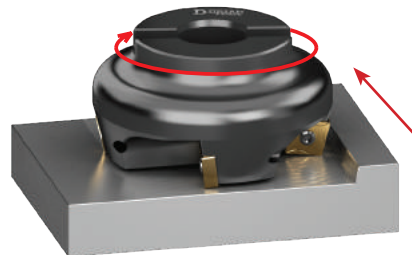

Description	UPC #	C	D	D1	d	F	H	H1	Insert Qty.	CNMG Gage Insert	Insert Torx Screw	Torx Key
REC15A-300-CN4-100	65856	1.750	3.000	3.230	1.000	0.450	0.250	0.375	4	432	TS-1032-5M1	T-20
REC15A-400-CN4-150	65858	2.000	4.000	4.230	1.500	0.450	0.375	0.625	5			

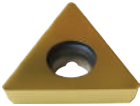
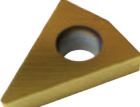
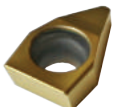
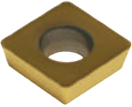
Insert	Description	Radius	DK25M	DASK25B	DASP35B
TDEX 60° 	TDEX-110201-EN	.004"	-	-	95417
	TDEX-110202-EN	.008"	-	-	95419
	TDEX-110204-EN	.015"	95420	95422	95426
	TDEX-110208-EN	.032"	95430	95432	95436
	TDEX-160304-EN	.015"	95440	95442	95446
	TDEX-160308-EN	.032"	95450	95452	95456
	TDEX-220404-EN	.015"	95460	95462	95466
	TDEX-220408-EN	.032"	95470	95472	95476
TDEX 45° 	TDEX-090202-EN	.008"	95490	95492	95495
	TDEX-090204-EN	.015"	95500	95502	95505
	TDEX-17T304-EN	.015"	95510	95512	95515
	TDEX-17T308-EN	.032"	95520	95522	95525
	TDEX-250404-EN	.015"	95530	95532	95535
	TDEX-250408-EN	.032"	95540	95542	95545
TEHW 	TEHW-0602-AEEN	.004"	95590	95593	95595
SDHW 	SDHW-090308-EN	.032"	94996	94998	95002

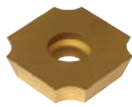
Insert	Description	Radius	DNU25GT	DUP25GT
SDGX-UEN 3/8" Square Convex Radius 	SDGX-09C01-E	0.016"	-	95299
	SDGX-09C03-E	0.047"	95305	95307
	SDGX-09C04-E	0.062"	95309	95311
SDGX-UEN 3/4" Square Convex Radius 	SDGX-19C05-E	0.078"		95250
	SDGX-19C06-E	0.094"	95253	95254
	SDGX-19C07-E	0.109"	95257	95258
	SDGX-19C08-E	0.125	95261	95262
	SDGX-19C09-E	0.141"		95266
	SDGX-19C10-E	0.156"	95269	95270
	SDGX-19C11-E	0.178"		95274
	SDGX-19C12-E	0.188"	95277	95278
	SDGX-19C13-E	0.203"		95282
	SDGX-19C14-E	0.219"	95285	95286
	SDGX-19C15-E*	0.234"	95289	95290
SDGX-19C16-E*	0.250"	95293	95294	

*All SDGX inserts have 4 cutting edges, except 5,943mm & 6,35mm radius inserts that have 2 cutting edges.

Description	ISO	Grade DNU10GT	Grade DNX10UT
VCGT-NFU 35° Triangle Universal 	VCGT-448-NFU	80123	80124

Description	ISO	Grade DMC30UT
TCMT-MEM 60° Triangle Universal 	TCMT-32.51-MEM	70778
	TCMT-32.52-MEM	70779

Insert	Description	DNU25GT	DNP25GT	DPP30GT
TPHT-UEN 	TPHT-32.51-UEN	71748	71750	71751
	TPHT-32.52-UEN	71753	71755	71756

Insert	Description	DUP30M
SPMT 	SPMT-060304-EN	95051

DK25M / DNU25GT

Uncoated, hard and wear resistant C2 Substrate for Aluminum & Non Ferrous materials.

DASK25B

C2 Substrate with PVD TiN-TiAlN-TiN multi-layer coating. For general purpose milling of non-ferrous metals such as aluminum, copper, brass, and bronze, high temp alloys, 300-series stainless steels and cast iron with medium to high SFM.t

DASP35B

C5 Substrate with PVD TiN-TiAlN-TiN multi-layer coating. For general purpose milling of carbon steels, alloy steels and tool steels in annealed state with medium to high SFM.

DUP25GT

C2 Substrate with PVD TiN-TiAlN coating. For general purpose milling of carbon steels, alloy steels, stainless steels, high temp alloys, hardened metals and non ferrous materials with medium to high SFM.

DNP25GT

C2 Substrate with PVD TiN coating. For general purpose milling of high temp alloys, hardened metals and non ferrous materials with medium SFM.

DPP30GT

C5 Substrate with PVD TiN coating. For general purpose milling of carbon steels, alloy steels and stainless steels at medium SFM.

DUP30M

C5 Substrate with PVD TiN-TiAlN multi-layer coating. For general purpose milling of carbon steels, alloy steels and tool steels in annealed state with medium to high SFM. Also use on stainless steels.

DNU10GT





For general milling applications at a high SFM (V_C). Hard, abrasive and wear resistant micro-grained uncoated substrate, for a hard and sharp cutting edge (not for interrupted cuts). Best for Aluminum, Plastics and all Non Ferrous metals and materials.

DNX10UT

For universal milling at a very high SFM (V_C). Hard, abrasive and high resistant substrate with a microplus® plasma TiAlN coating to improve cutting edge hardness, wear and heat resistant, and better chip flow. Best for Aluminum, Plastics and low Silicone Aerospace Aluminum.

DMC30UT

M30 Substrate with CVD TiN/TiCN/TiN Coating. Universal grade for Steels and Stainless Steels.

Insert	Description	Grade	Grade	Grade	Grade	Grade	Grade	Grade
		DPP15HM UPC #	DPC25UM UPC #	DPP35RM UPC #	DMC35UM UPC #	DKC10UM UPC #	DK10M UPC#	DKP10VM UPC#
	APKT-1003-PDSR- (.019" radius)	94757	94758	94759	94754	94753	-	-
	APHT-1003-PDFR- (.019" radius)	-	-	-	-	-	94750	94751
	APKT-1604-PDSR- (.032" radius)	94767	94768	94769	94764	94763	-	-
	APHT-1604-PDFR- (.032" radius)	-	-	-	-	-	94760	94761
	APKT-160416SR- (.063" radius)	-	94771	-	-	-	-	-
	APKT-160424SR- (.094" radius)	-	94772	-	-	-	-	-
	APKT-160432SR- (.125" radius)	-	94774	-	-	-	-	-

DPP15HM:

Multi-purpose grade for milling carbon and alloy steels, stainless steels and cast iron with nodular graphite. This TiAlN P25 grade is especially suitable for high cutting speeds in dry machining.

DPC25UM:

First choice for carbon and alloy steels. Tough P30 substrate with MT-CVD multi-layer Al2O3 coating.

DPP35RM:

First choice for Tool Steels. Very tough P35 substrate with Nanotop PVD AlTiN coating. Ideal for dry milling at low to medium cutting speeds for roughing.

DMC35UM:

First choice for Austenitic Stainless Steels at low to medium cutting speeds and wet machining. Extremely tough M40, fine grained carbide substrate with thin and tough PVD multi-layer coating.

DKC10UM:

First choice for grey cast iron (GG), nodular cast iron (GGG), malleable cast iron and alloyed cast iron. K15 substrate with extremely hard and wear resistant MT-CVD multi-layer coating.

DKP10VM:

First choice for aluminum and other non-ferrous metals. Upsharp cutting edge. Very hard and wear resistant K10 substrate with extremely thin PVD TiAlN coating. Also, first choice for finishing stainless steels and cast irons.

DK10M:

Uncoated grade for Aluminum and Non Ferrous materials.

Spare Parts Milling Insert Torx Screw	Description	UPC #	PKG.
	TS-06	91306	
	TS-25.45-6M2	90972	10
	TS-4.7-6M1	90975	
	TS-4.7-8M1	90976	
	TS-4.7-10M1	90982	10
	TS-1032-5M1	90960	
	TS-5.8-10M1	90986	

HIGH PERFORMANCE LIVE CENTERS

PERFORMANCE, TECHNOLOGY & QUALITY

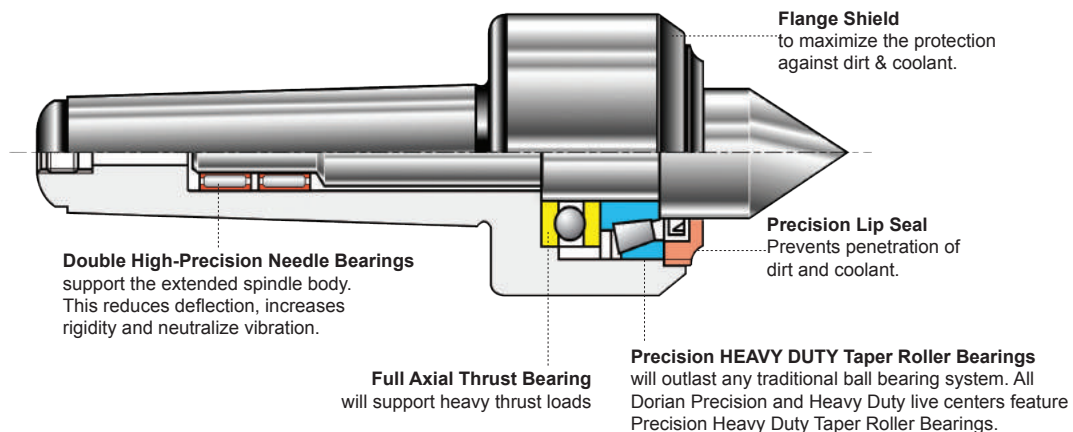



Precision General Purpose
Precision **TAPER ROLLER** Bearings

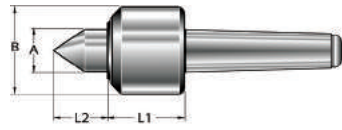

Live Center with 60° Standard Steel Point

UPC #	Description	A	B	L1	L2	Morse Taper	Weight (lb)	Max. RPM	Max. workpiece Weight (lb)	Max. Thrust load (lb)
48200	PLC-PRE-S60-MT1	0.63	1.49	1.45	0.79	MT1	1.10	8500	110	365
48201	PLC-PRE-S60-MT2	0.87	1.89	1.65	0.98	MT2	2.00	6000	220	792
48202	PLC-PRE-S60-MT3	0.87	2.17	1.69	1.06	MT3	2.20	5000	572	1144
48203	PLC-PRE-S60-MT4	1.14	2.40	2.00	1.49	MT4	3.50	4000	1078	1320
48204	PLC-PRE-S60-MT5	1.49	3.15	2.16	1.77	MT5	7.7	3000	1672	1430
48205	PLC-PRE-S60-MT6	1.65	3.70	2.67	2.00	MT6	17.6	2500	3388	3300



Precision General Purpose
Precision **TAPER ROLLER** Bearings

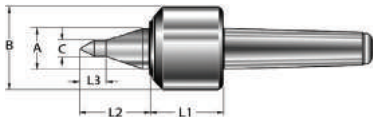

Live Center with 60° Extended Medium Slim Steel Point

UPC #	Description	A	B	C	L1	L2	L3	Morse Taper	Weight (lb)	Max. RPM	Max. workpiece Weight (lb)	Max. Thrust load (lb)
48266	PLC-PRE-EMSSP-MT2	0.87	1.89	0.31	1.65	1.26	0.43	MT2	2.00	6000	220	792
48267	PLC-PRE-EMSSP-MT3	0.87	2.17	0.39	1.69	1.57	0.59	MT3	2.20	5000	572	1144
48268	PLC-PRE-EMSSP-MT4	1.14	2.40	0.47	2.00	1.97	0.62	MT4	3.50	4000	1078	1320



Precision General Purpose
Precision **TAPER ROLLER** Bearings

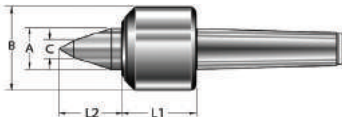

Live Center with 60° Extended Large Steel Point

UPC #	Description	A	B	C	L1	L2	Morse Taper	Weight (lb)	Max. RPM	Max. workpiece Weight (lb)	Max. Thrust load (lb)
48269	PLC-PRE-ELSP-MT3	0.87	2.17	0.23	1.69	1.57	MT3	2.20	5000	572	1144
48270	PLC-PRE-ELSP-MT4	1.14	2.40	0.31	2.00	1.97	MT4	3.50	4000	1078	1320
48271	PLC-PRE-ELSP-MT5	1.49	3.15	0.47	2.16	2.68	MT5	7.7	3000	1672	1430
48272	PLC-PRE-ELSP-MT6	1.65	3.70	0.63	2.67	2.76	MT6	17.6	2500	3388	3300



Heavy Duty
Precision **HEAVY DUTY TAPER ROLLER** Bearings

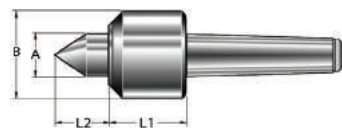

Live Center with 60° Standard Steel Point

UPC #	Description	A	B	L1	L2	Morse Taper	Weight (lb)	Max. RPM	Max. workpiece Weight (lb)	Max. Thrust load (lb)
48206	PLC-HDA-S60-MT2	0.87	2.01	1.69	0.99	MT2	1.98	7500	506	1012
48207	PLC-HDA-S60-MT3	0.87	2.17	1.69	1.10	MT3	2.20	6000	2090	1144
48208	PLC-HDA-S60-MT4	1.14	2.40	2.01	1.50	MT4	3.53	4500	3300	1320
48209	PLC-HDA-S60-MT5	1.50	3.15	2.32	1.85	MT5	7.70	2800	4400	2640
48210	PLC-HDA-S60-MT6	1.65	4.26	3.47	2.17	MT6	22.0	2000	10560	3300
48211	PLC-HDA-S60-MT6S	2.36	5.44	4.57	2.40	MT6S	26.4	1700	19800	6600
48212	PLC-HDA-S60-M80	2.44	5.75	4.57	2.96	M80*	39.6	1100	19800	6600
48213	PLC-HDA-S60-M100	3.07	7.01	5.28	3.06	M100*	85.8	900	29700	11000



Heavy Duty
Precision **HEAVY DUTY TAPER ROLLER** Bearings

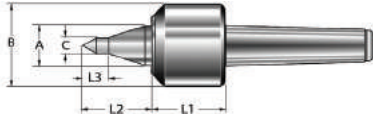

Live Center with 60° Extended Medium Slim Steel Point

UPC #	Description	A	B	C	L1	L2	L3	Morse Taper	Weight (lb)	Max. RPM	Max. workpiece Weight (lb)	Max. Thrust load (lb)
48273	PLC-HDA-EMSSP-MT3	0.87	2.17	0.39	1.69	1.57	0.59	MT3	2.20	6000	2090	1144
48274	PLC-HDA-EMSSP-MT4	1.14	2.40	0.47	2.01	1.97	0.62	MT4	3.53	4500	3300	1320
48275	PLC-HDA-EMSSP-MT5	1.50	3.15	0.62	2.32	2.68	0.70	MT5	7.70	2800	4400	2640



Heavy Duty
Precision **HEAVY DUTY TAPER ROLLER** Bearings

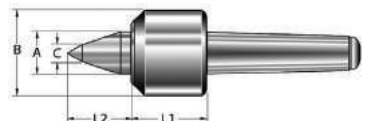

Live Center with 60° Extended Large Steel Point

UPC #	Description	A	B	C	L1	L2	Morse Taper	Weight (lb)	Max. RPM	Max. workpiece Weight (lb)	Max. Thrust load (lb)
48277	PLC-HDA-ELSP-MT3	0.87	2.17	0.23	1.69	1.57	MT3	2.20	6000	2090	1144
48278	PLC-HDA-ELSP-MT4	1.14	2.40	0.31	2.01	1.97	MT4	3.53	4500	3300	1320
48279	PLC-HDA-ELSP-MT5	1.50	3.15	0.47	2.32	2.68	MT5	7.70	2800	4400	2640
48280	PLC-HDA-ELSP-MT6	1.65	4.26	0.63	3.47	2.76	MT6	22.0	2000	10560	3300

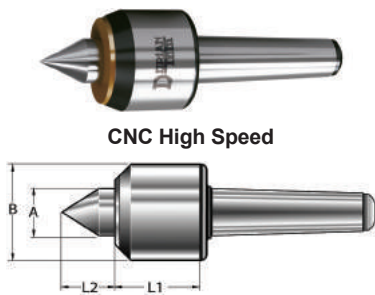

CNC High Speed

CNC High Speed Heavy Duty Live Center with 60° Standard Steel Point

UPC #	Description	A	B	L1	L2	Morse Taper	Weight (lb)	Max. RPM	Max. workpiece Weight (lb)	Max. Thrust load (lb)
48220	PLC-CNC-S60-MT3	0.87	2.17	1.85	1.10	MT3	2.20	7000	1386	1144
48221	PLC-CNC-S60-MT4	1.14	2.40	2.17	1.58	MT4	3.63	5500	1883	1438
48222	PLC-CNC-S60-MT5	1.50	3.15	2.48	1.89	MT5	7.81	4500	2860	2486
48223	PLC-CNC-S60-MT6	1.65	3.66	2.88	2.17	MT6	18.7	3200	3740	2508



CNC High Speed

CNC High Speed Heavy Duty Live Center with 60° Standard Carbide Point

UPC #	Description	A	B	C	L1	L2	Morse Taper	Weight (lb)	Max. RPM	Max. workpiece Weight (lb)	Max. Thrust load (lb)
48224	PLC-CNC-C60-MT3	0.87	2.17	0.39	1.85	1.10	MT3	2.20	7000	1386	1144
48225	PLC-CNC-C60-MT4	1.14	2.40	0.47	2.17	1.58	MT4	3.63	5500	1883	1438
48226	PLC-CNC-C60-MT5	1.50	3.15	0.70	2.48	1.89	MT5	7.81	4500	2860	2486
48227	PLC-CNC-C60-MT6	1.65	3.66	0.78	2.88	2.17	MT6	18.7	3200	3740	2508



CNC High Speed

CNC High Speed Heavy Duty Live Center with 60° Extended Medium Slim Steel Point

UPC #	Description	A	B	C	L1	L2	L3	Morse Taper	Weight (lb)	Max. RPM	Max. workpiece Weight (lb)	Max. Thrust load (lb)
48282	PLC-CNC-EMSSP-MT3	0.87	2.17	0.39	1.85	1.65	0.59	MT3	2.20	7000	1386	1144
48283	PLC-CNC-EMSSP-MT4	1.14	2.40	0.47	2.17	2.01	0.62	MT4	3.63	5500	1883	1438
48284	PLC-CNC-EMSSP-MT5	1.50	3.15	0.62	2.48	2.21	0.70	MT5	7.81	4500	2860	2486
48285	PLC-CNC-EMSSP-MT6	1.65	3.66	0.70	2.88	3.07	0.78	MT6	18.7	3200	3740	2508

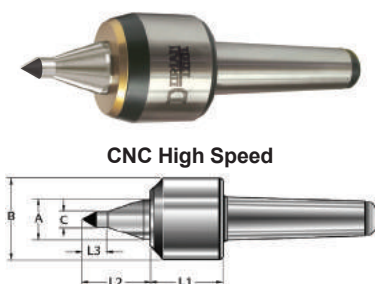

CNC High Speed

CNC High Speed Heavy Duty Live Center with 60° Extended Medium Slim Carbide Point

UPC #	Description	A	B	C	L1	L2	L3	Morse Taper	Weight (lb)	Max. RPM	Max. workpiece Weight (lb)	Max. Thrust load (lb)
48286	PLC-CNC-EMSCP-MT3	0.87	2.17	0.39	1.85	1.65	0.59	MT3	2.20	7000	1386	1144
48287	PLC-CNC-EMSCP-MT4	1.14	2.40	0.47	2.17	2.01	0.62	MT4	3.63	5500	1883	1438
48288	PLC-CNC-EMSCP-MT5	1.50	3.15	0.62	2.48	2.21	0.70	MT5	7.81	4500	2860	2486
48289	PLC-CNC-EMSCP-MT6	1.65	3.66	0.70	2.88	3.07	0.78	MT6	18.7	3200	3740	2508



CNC High Speed

CNC High Speed Heavy Duty Live Center with 60° Extended Small Slim Steel Point

UPC #	Description	A	B	C	L1	L2	L3	Morse Taper	Weight (lb)	Max. RPM	Max. workpiece Weight (lb)	Max. Thrust load (lb)
48600	PLC-CNC-ESSSP-MT3	0.87	2.17	0.27	1.85	1.65	0.787	MT3	2.20	7000	1386	1144
48601	PLC-CNC-ESSSP-MT4	1.14	2.40	0.31	2.17	2.00	0.866	MT4	3.63	5500	1883	1438
48602	PLC-CNC-ESSSP-MT5	1.50	3.15	0.39	2.48	2.24	0.945	MT5	7.81	4500	2860	2486
48603	PLC-CNC-ESSSP-MT6	1.65	3.66	0.39	2.88	3.110	1.102	MT6	18.7	3200	3740	2508

CNC High Speed Heavy Duty Live Center with 60° Extended Small Slim Carbide Point



CNC High Speed

UPC #	Description	A	B	C	L1	L2	L3	Morse Taper	Weight (lb)	Max. RPM	Max. workpiece Weight (lb)	Max. Thrust load (lb)
48604	PLC-CNC-ESSCP-MT3	0.87	2.17	0.27	1.85	1.65	0.787	MT3	2.20	7000	1386	1144
48605	PLC-CNC-ESSCP-MT4	1.14	2.40	0.31	2.17	2.00	0.866	MT4	3.63	5500	1883	1438
48606	PLC-CNC-ESSCP-MT5	1.50	3.15	0.39	2.48	2.24	0.945	MT5	7.81	4500	2860	2486
48607	PLC-CNC-ESSCP-MT6	1.65	3.66	0.39	2.88	3.110	1.102	MT6	18.7	3200	3740	2508

CNC High Speed Heavy Duty Live Center with 60° Extended Large Slim Steel Point

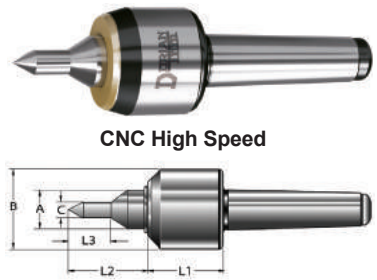

CNC High Speed

UPC #	Description	A	B	C	L1	L2	L3	Morse Taper	Weight (lb)	Max. RPM	Max. workpiece Weight (lb)	Max. Thrust load (lb)
48608	PLC-CNC-ELSSP-MT3	0.87	2.17	0.47	1.85	1.65	1.02	MT3	2.20	7000	1386	1144
48609	PLC-CNC-ELSSP-MT4	1.14	2.40	0.55	2.17	2.00	1.18	MT4	3.63	5500	1883	1438
48610	PLC-CNC-ELSSP-MT5	1.50	3.15	0.70	2.48	2.20	1.26	MT5	7.81	4500	2860	2486
48611	PLC-CNC-ELSSP-MT6	1.65	3.66	0.78	2.88	2.20	1.57	MT6	18.7	3200	3740	2508

CNC High Speed Heavy Duty Live Center with 60° Extended Large Slim Carbide Point



CNC High Speed

UPC #	Description	A	B	C	L1	L2	L3	Morse Taper	Weight (lb)	Max. RPM	Max. workpiece Weight (lb)	Max. Thrust load (lb)
48612	PLC-CNC-ELSCP-MT3	0.87	2.17	0.47	1.85	1.65	1.02	MT3	2.20	7000	1386	1144
48613	PLC-CNC-ELSCP-MT4	1.14	2.40	0.55	2.17	2.00	1.18	MT4	3.63	5500	1883	1438
48614	PLC-CNC-ELSCP-MT5	1.50	3.15	0.70	2.48	2.20	1.26	MT5	7.81	4500	2860	2486
48615	PLC-CNC-ELSCP-MT6	1.65	3.66	0.78	2.88	2.20	1.57	MT6	18.7	3200	3740	2508

CNC High Speed Heavy Duty Live Center with 60° Extended Large Steel Point



CNC High Speed

UPC #	Description	A	B	C	L1	L2	Morse Taper	Weight (lb)	Max. RPM	Max. workpiece Weight (lb)	Max. Thrust load (lb)
48232	PLC-CNC-ELSP-MT3	0.87	2.17	0.23	1.85	1.65	MT3	2.20	7000	1386	1144
48233	PLC-CNC-ELSP-MT4	1.14	2.40	0.31	2.17	2.01	MT4	3.63	5500	1883	1438
48234	PLC-CNC-ELSP-MT5	1.50	3.15	0.47	2.48	2.21	MT5	7.81	4500	2860	2486
48235	PLC-CNC-ELSP-MT6	1.65	3.66	0.59	2.88	3.07	MT6	18.7	3200	3740	2508

CNC High Speed Heavy Duty Live Center with 60° Extended Large Carbide Point



CNC High Speed

UPC #	Description	A	B	C	L1	L2	Morse Taper	Weight (lb)	Max. RPM	Max. workpiece Weight (lb)	Max. Thrust load (lb)
48236	PLC-CNC-ELCP-MT3	0.87	2.17	0.23	1.85	1.65	MT3	2.20	7000	1386	1144
48237	PLC-CNC-ELCP-MT4	1.14	2.40	0.31	2.17	2.01	MT4	3.63	5500	1883	1438
48238	PLC-CNC-ELCP-MT5	1.50	3.15	0.39	2.48	2.21	MT5	7.81	4500	2860	2486
48239	PLC-CNC-ELCP-MT6	1.65	3.66	0.47	2.88	3.07	MT6	18.7	3200	3740	2508

Heavy Duty Live Center for Interchangeable Points (Includes one 60° Interchangeable Steel Point)

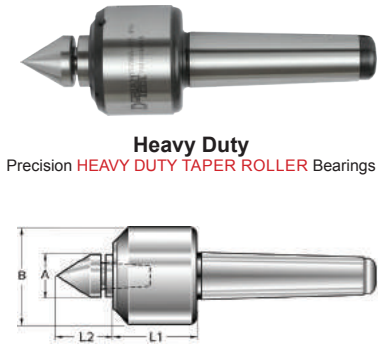

Heavy Duty
Precision **HEAVY DUTY TAPER ROLLER** Bearings

UPC #	Description	A	B	L1	L2	Morse Taper	Weight (lb)	Max. RPM	Max. workpiece Weight (lb)	Max. Thrust load (lb)
48214	PLC-HDA-INT-MT2	0.99	2.01	1.69	1.38	MT2	1.98	7500	506	1012
48215	PLC-HDA-INT-MT3	0.99	2.17	1.69	1.42	MT3	2.20	6000	2090	1144
48216	PLC-HDA-INT-MT4	1.14	2.40	2.01	1.58	MT4	3.53	4500	3300	1320
48217	PLC-HDA-INT-MT5	1.38	3.15	2.32	1.89	MT5	7.70	2800	4400	2640
48218	PLC-HDA-INT-MT6	1.65	4.26	3.47	2.17	MT6	22.0	2000	10560	3300

CNC High Speed Live Center for Interchangeable Points (Includes one 60° Interchangeable Steel Point)

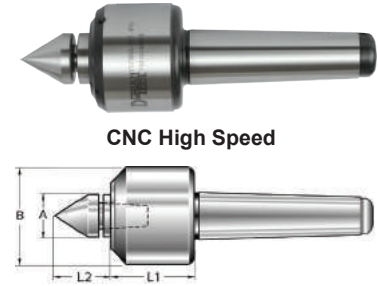

CNC High Speed

UPC #	Description	A	B	L1	L2	Morse Taper	Weight (lb)	Max. RPM	Max. workpiece Weight (lb)	Max. Thrust load (lb)
48228	PLC-CNC-INT-MT3	0.99	2.17	1.85	1.46	MT3	2.20	7000	1386	1144
48229	PLC-CNC-INT-MT4	1.14	2.40	2.17	1.60	MT4	3.63	5500	1883	1438
48230	PLC-CNC-INT-MT5	1.38	3.15	2.48	1.81	MT5	7.81	4500	2860	2486
48231	PLC-CNC-INT-MT6	1.65	3.66	2.88	2.17	MT6	18.7	3200	3740	2508

INP Standard Interchangeable Steel Point

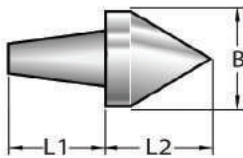

UPC #	Description	Body Size	B	L1	L2
48305	PLCIP-INP-2-3	2&3	1.06	1.06	1.18
48306	PLCIP-INP-4	4	1.14	1.14	1.22
48307	PLCIP-INP-5	5	1.38	1.18	1.42
48308	PLCIP-INP-6	6	1.65	1.30	1.77

USP Undersized Interchangeable Steel Point

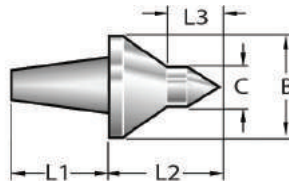

UPC #	Description	Body Size	B	C	L1	L2	L3
48313	PLCIP-USP-2-3	2&3	0.98	0.47	1.06	1.34	0.63
48314	PLCIP-USP-4	4	1.14	0.47	1.14	1.46	0.63
48315	PLCIP-USP-5	5	1.38	0.59	1.18	1.65	0.75
48316	PLCIP-USP-6	6	1.65	0.79	1.30	2.13	0.98

INCP Standard Interchangeable Steel Point with Carbide

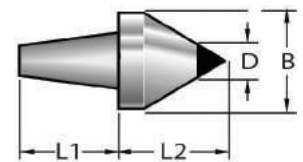

UPC #	Description	Body Size	B	D	L1	L2
48309	PLCIP-INCP-2-3	2&3	1.06	0.39	1.06	1.18
48310	PLCIP-INCP-4	4	1.14	0.47	1.14	1.22
48311	PLCIP-INCP-5	5	1.38	0.55	1.18	1.42
48312	PLCIP-INCP-6	6	1.65	0.55	1.30	1.77

EXP Extended Interchangeable Steel Point

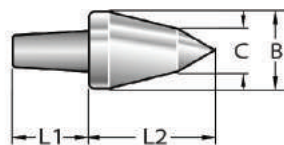

UPC #	Description	Body Size	B	C	L1	L2
48325	PLCIP-EXP-2-3	2&3	0.98	0.32	1.06	1.77
48326	PLCIP-EXP-4	4	1.14	0.39	1.14	1.97
48327	PLCIP-EXP-5	5	1.38	0.47	1.18	2.32
48328	PLCIP-EXP-6	6	1.65	0.47	1.30	2.95

FCUP Female Cup Interchangeable Steel Point

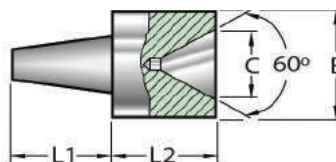

UPC #	Description	Body Size	B	C	L1	L2
48329	PLCIP-FCUP-2-3	2&3	1.14	0.91	1.06	1.18
48330	PLCIP-FCUP-4	4	1.14	0.91	1.14	1.18
48331	PLCIP-FCUP-5	5	1.38	1.06	1.18	1.38
48332	PLCIP-FCUP-6	6	1.46	1.06	1.30	1.38

SBNP Bull Nose Interchangeable Steel Point

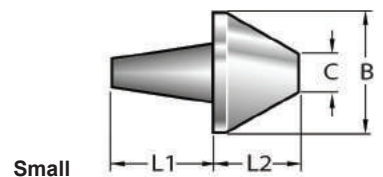

UPC #	Description	Body Size	B	C	L1	L2
48333	PLCIP-SBNP-2-3	2&3	2.32	1.02	1.06	1.38
48334	PLCIP-SBNP-4	4	2.32	1.02	1.14	1.38
48335	PLCIP-SBNP-5	5	2.32	1.02	1.18	1.38
48336	PLCIP-SBNP-6	6	2.32	1.02	1.30	1.38

MBNP Bull Nose Interchangeable Steel Point

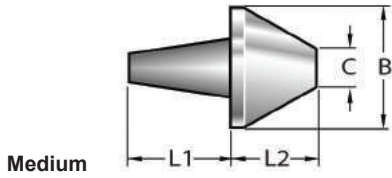

LBNP Bull Nose Interchangeable Steel Point

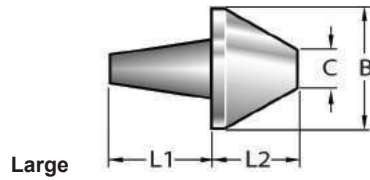

MSP Mini Sized Steel Point

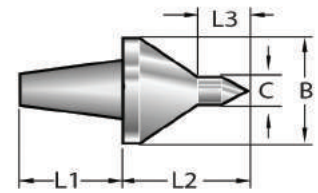

UPC #	Description	Body Size	B	C	L1	L2
48337	PLCIP-MBNP-2-3	2&3	3.07	1.81	1.06	1.38
48338	PLCIP-MBNP-4	4	3.07	1.81	1.14	1.38
48339	PLCIP-MBNP-5	5	3.07	1.81	1.18	1.38
48340	PLCIP-MBNP-6	6	3.07	1.81	1.30	1.38

UPC #	Description	Body Size	B	C	L1	L2
48341	PLCIP-LBNP-2-3	2&3	3.86	2.60	1.06	1.38
48342	PLCIP-LBNP-4	4	3.86	2.60	1.14	1.38
48343	PLCIP-LBNP-5	5	3.86	2.60	1.18	1.38
48344	PLCIP-LBNP-6	6	3.86	2.60	1.30	1.38

UPC #	Description	Body Size	B	C	L1	L2	L3
48317	PLCIP-MSP-2-3	2 & 3	0.98	0.28	1.06	1.33	0.47
48318	PLCIP-MSP-4	4	1.14	0.28	1.14	1.45	0.47
48319	PLCIP-MSP-5	5	1.38	0.28	1.18	1.65	0.47
48320	PLCIP-MSP-6	6	1.65	0.47	1.30	2.12	0.71

USCP Undersized Interchangeable Steel Point with Carbide

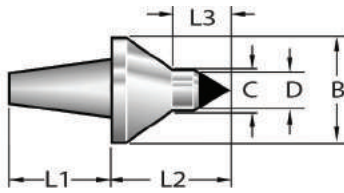

UPC #	Description	Body Size	B	C	D	L1	L2	L3
48321	PLCIP-USCP-2-3	2 & 3	0.98	0.47	0.28	1.06	1.34	0.63
48322	PLCIP-USCP-4	4	1.14	0.47	0.31	1.14	1.46	0.63
48323	PLCIP-USCP-5	5	1.38	0.59	0.47	1.18	1.65	0.75
48324	PLCIP-USCP-6	6	1.65	0.79	0.47	1.30	2.13	0.98

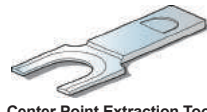

Center Point Extraction Tool

UPC #	Tool Description	Body Size
48345	PLCIP-CPEW-2-3	MT2-3
48346	PLCIP-CPEW-4	MT4
48347	PLCIP-CPEW-5	MT5
48348	PLCIP-CPEW-6	MT6



CNC Lock Nut Wrench

UPC #	Wrench Description	Body Size
48349	PLCIP-LNW-30SP	MT2-3
48350	PLCIP-LNW-40SP	MT4
48351	PLCIP-LNW-50SP	MT5

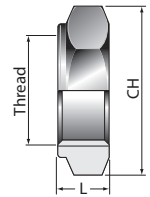

Extractor Nut for Threaded Dead Centers

UPC #	Description	Thread
48449	PLC-CNC-DCEN-36	M36 x 1.5
48450	PLC-CNC-DCEN-41	M48 x 1.5
48451	PLC-CNC-DCEN-48	M48 x 1.5
48452	PLC-CNC-DCEN-68	M68 x 1.5



Spring Loaded

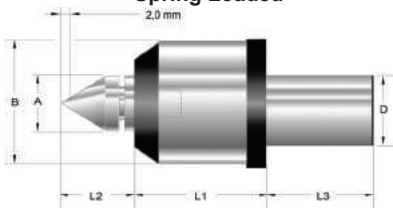

Precision Spring Loaded Live Center for Interchangeable Points (Includes one 60° Interchangeable Steel Point)

UPC #	Description	A	B	L1	L2	L3	D	Weight (lb)	Max. RPM	Max. workpiece Weight (lb)	Max. Thrust load (lb)
48475	PLC-CNC-INT-DIA-30	1.14	2.40	3.11	1.61	2.17	1.18 (30mm)	4.63	5500	1883	1438
48476	PLC-CNC-INT-DIA-40	1.37	3.15	3.35	1.85	2.48	1.57 (40mm)	8.38	4500	2860	2486

CNC High Speed Live Center with Extended Steel Point

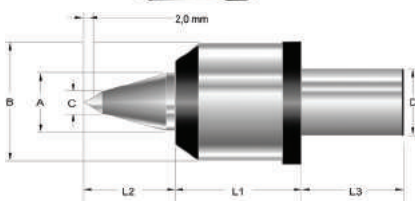

UPC #	Description	A	B	C	L1	L2	L3	D	Weight (lb)	Max. RPM	Max. workpiece Weight (lb)	Max. Thrust load (lb)
48477	PLC-CNC-ELSP-DIA-30	1.14	2.40	0.31	3.11	2.01	2.17	1.18 (30mm)	4.63	5500	1883	1438
48478	PLC-CNC-ELSP-DIA-40	1.50	3.15	0.47	3.35	2.21	2.48	1.57 (40mm)	8.38	4500	2860	2486

CNC Super High Speed Heavy Duty Live Center with 60° Standard Steel Point

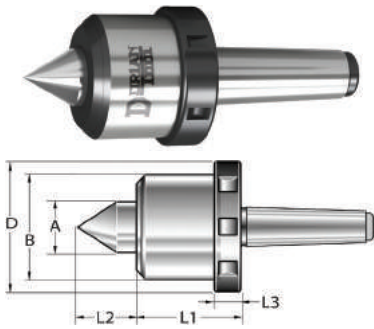

UPC #	Description	A	B	D	L1	L2	L3	Morse Taper	Weight (lb)	Max. RPM	Max. workpiece Weight (lb)	Max. Thrust load (lb)
48240	PLC-SPA-S60-MT3	1.18	2.44	2.89	2.72	1.28	0.95	MT3	4.62	12000	3300	2860
48241	PLC-SPA-S60-MT4	1.38	3.07	3.52	3.14	1.45	0.95	MT4	10.69	9000	5060	4180
48242	PLC-SPA-S60-MT5	1.65	3.66	4.09	3.35	1.83	1.06	MT5	14.30	8000	8140	5280

CNC Super High Speed Heavy Duty Live Center with 60° Standard Carbide Point

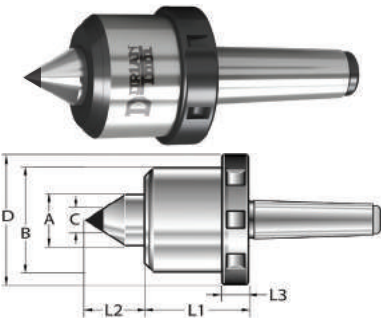

UPC #	Description	A	B	C	D	L1	L2	L3	Morse Taper	Weight (lb)	Max. RPM	Max. workpiece Weight (lb)	Max. Thrust load (lb)
48290	PLC-SPA-C60-MT3	1.18	2.44	0.39	2.89	2.72	1.28	0.95	MT3	4.62	12000	3300	2860
48291	PLC-SPA-C60-MT4	1.38	3.07	0.47	3.52	3.14	1.45	0.95	MT4	10.69	9000	5060	4180
48292	PLC-SPA-C60-MT5	1.65	3.66	0.70	4.09	3.35	1.83	1.06	MT5	14.30	8000	8140	5280

CNC Super High Speed Heavy Duty Live Center with 60° Extended Large Steel Point

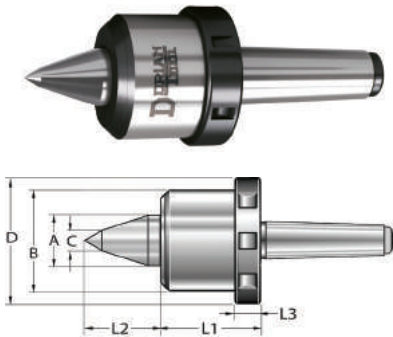

UPC #	Description	A	B	C	D	L1	L2	L3	Morse Taper	Weight (lb)	Max. RPM	Max. workpiece Weight (lb)	Max. Thrust load (lb)
48246	PLC-SPA-ELSP-MT3	1.18	2.44	0.47	2.89	2.72	1.58	0.95	MT3	4.62	12000	3300	2860
48247	PLC-SPA-ELSP-MT4	1.38	3.07	0.62	3.52	3.14	1.73	0.95	MT4	10.69	9000	5060	4180
48248	PLC-SPA-ELSP-MT5	1.65	3.66	0.79	4.09	3.35	2.34	1.06	MT5	14.30	8000	8140	5280

CNC Super High Speed Heavy Duty Live Center with 60° Extended Large Steel Point

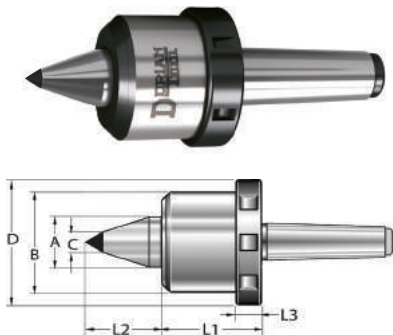

UPC #	Description	A	B	C	D	L1	L2	L3	Morse Taper	Weight (lb)	Max. RPM	Max. workpiece Weight (lb)	Max. Thrust load (lb)
48249	PLC-SPA-ELCP-MT3	1.18	2.44	0.39	2.89	2.72	1.58	0.95	MT3	4.62	12000	3300	2860
48250	PLC-SPA-ELCP-MT4	1.38	3.07	0.55	3.52	3.14	1.73	0.95	MT4	10.69	9000	5060	4180
48251	PLC-SPA-ELCP-MT5	1.65	3.66	0.70	4.09	3.35	2.34	1.06	MT5	14.30	8000	8140	5280

FACE DRIVERS

*The Mechanical and Compact Design of the Dorian Face Driver is
Accurate Powerful Simple Reliable
 Engineered for Proven Performance!*

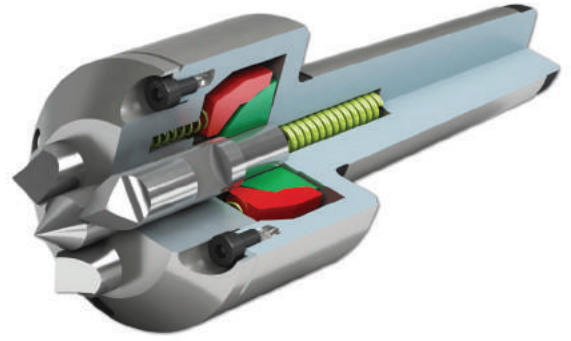

The Perfetta™ Face Driver is engineered to drive a workpiece without clamping the outside diameter, allowing a precision turning of the workpiece over the entire length in one set-up and one operation.
 The center point of the Face Driver holds the work piece with high rigidity, accuracy and concentricity. The Driver Pins, engage and drive the workpiece with a constant force safely and reliably.

12mm (.472") Minimum Diameter

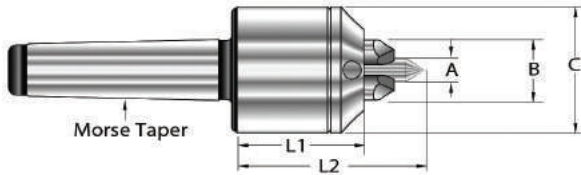

UPC #	Description	Capacity		A	B	C	L1	L2	Shank
		Min.	Max.						
48353	PLC-FD-12-SS30	0.47	1.00	0.32	0.79	1.90	2.05	2.64	30mm Straight
48354	PLC-FD-12-MT3	0.47	1.00	0.32	0.79	1.90	2.05	2.64	MT3
48355	PLC-FD-12-MT4	0.47	1.00	0.32	0.79	1.90	2.05	2.64	MT4

22mm (.866") Minimum Diameter

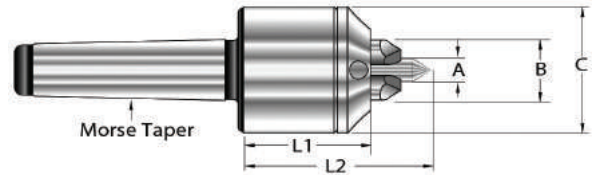

UPC #	Description	Capacity		A	B	C	L1	L2	Shank
		Min.	Max.						
48356	PLC-FD-22-SS30	1.18	1.85	0.47	1.18	2.44	2.52	3.39	30mm Straight
48357	PLC-FD-22-MT3	1.18	1.85	0.47	1.18	2.44	2.52	3.39	MT3
48358	PLC-FD-22-MT4	1.18	1.85	0.47	1.18	2.44	2.52	3.39	MT4
48359	PLC-FD-22-MT5	1.18	1.85	0.47	1.18	2.44	2.52	3.39	MT5

UPC #	Driving Pin Description	UPC #	Driving Pin Description	UPC #	Driving Pin Description	UPC #	Center Point Description
48367	PLC-FDP-12-N	48368	PLC-FDP-12-L	48369	PLC-FDP-12-R	48370	PLC-FDP-12-C
	Clockwise & Counter Clockwise		Counter Clockwise		Clockwise		60° Center Point

UPC #	Driving Pin Description	UPC #	Driving Pin Description	UPC #	Driving Pin Description	UPC #	Center Point Description
48371	PLC-FDP-22-N	48372	PLC-FDP-22-L	48373	PLC-FDP-22-R	48374	PLC-FDP-22-C
	Clockwise & Counter Clockwise		Counter Clockwise		Clockwise		60° Center Point

42mm (1.654") Minimum Diameter

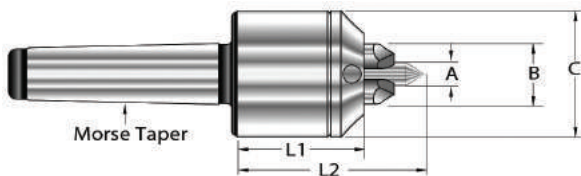

UPC #	Description	Capacity		A	B	C	L1	L2	Morse Taper
		Min.	Max.						
48360	PLC-FD-42-MT4	1.575	2.756	.71	1.61	3.43	3.740	4.921	MT4
48361	PLC-FD-42-MT5	1.575	2.756	.71	1.61	3.43	3.740	4.921	MT5
48362	PLC-FD-42-MT6	1.575	2.756	.71	1.61	3.43	3.740	4.921	MT6

UPC #	Driving Pin Description	UPC #	Driving Pin Description	UPC #	Driving Pin Description	UPC #	Center Point Description
48375	PLC-FDP-42-N	48376	PLC-FDP-42-L	48377	PLC-FDP-42-R	48378	PLC-FDP-42-C
	Clockwise & Counter Clockwise		Counter Clockwise		Clockwise		60° Center Point

65mm (2.559") Minimum Diameter

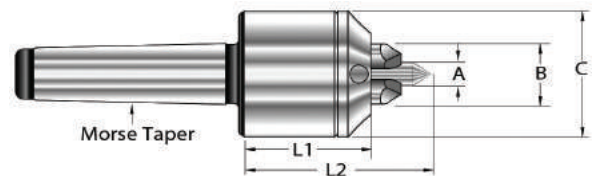

UPC #	Description	Capacity		A	B	C	L1	L2	Morse Taper
		Min.	Max.						
48363	PLC-FD-65-MT4	2.25	3.55	0.91	2.25	4.29	3.94	5.51	MT4
48364	PLC-FD-65-MT5	2.25	3.55	0.91	2.25	4.29	3.94	5.51	MT5
48365	PLC-FD-65-MT6	2.25	3.55	0.91	2.25	4.29	3.94	5.51	MT6

UPC #	Driving Pin Description	UPC #	Driving Pin Description	UPC #	Driving Pin Description	UPC #	Center Point Description
48380	PLC-FDP-65-N	48381	PLC-FDP-65-L	48382	PLC-FDP-65-R	48383	PLC-FDP-65-C
	Clockwise & Counter Clockwise		Counter Clockwise		Clockwise		60° Center Point

CNC Steel Morse Taper Threaded Dead Center with 60° Steel Point

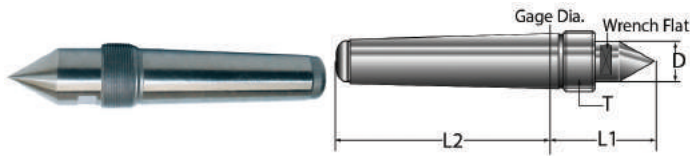

UPC #	Description	D	Gage Dia.	L1	L2	T Thread	Morse Taper
48440	PLC-CNC-TDC-MT3	1.102	0.938	2.560	3.190	M36 x 1.5	MT3
48441	PLC-CNC-TDC-MT4	1.260	1.231	3.010	4.04	M36 x 1.5	MT4
48442	PLC-CNC-TDC-MT5	1.498	1.500	3.407	5.10	M48 x 1.5	MT5

CNC Steel Morse Taper Threaded Dead Center with 60° Extended Steel Point

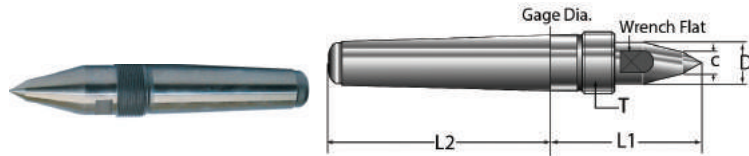

UPC #	Description	D	Gage Dia.	C	L1	L2	T Thread	Morse Taper
48443	PLC-CNC-XTDC-MT3	1.102	0.938	0.510	3.150	3.190	36 x 1.5	MT3
48444	PLC-CNC-XTDC-MT4	1.260	1.231	0.510	3.640	4.04	36 x 1.5	MT4
48445	PLC-CNC-XTDC-MT5	1.498	1.500	0.788	4.115	5.10	48 x 1.5	MT5

Precision CNC Steel Morse Taper Dead Center with 60° Steel Point

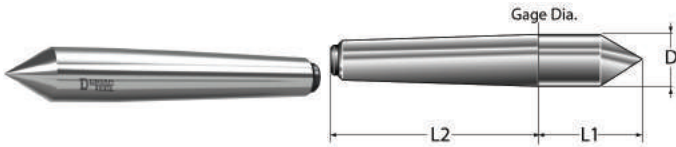

UPC #	Description	D	Gage Dia.	L1	L2	Morse Taper
48453	PLC-MTDC-SMT1	0.48	0.475	1.03	2.12	MT1
48454	PLC-MTDC-SMT2	0.71	0.700	1.38	2.56	MT2
48455	PLC-MTDC-SMT3	0.95	0.938	1.73	3.19	MT3
48456	PLC-MTDC-SMT4	1.24	1.231	2.24	4.06	MT4
48457	PLC-MTDC-SMT5	1.76	1.748	2.68	5.19	MT5
48458	PLC-MTDC-SMT6	2.51	2.494	3.38	7.25	MT6

Precision CNC Steel Morse Taper Dead Center with 60° Partial Carbide Point

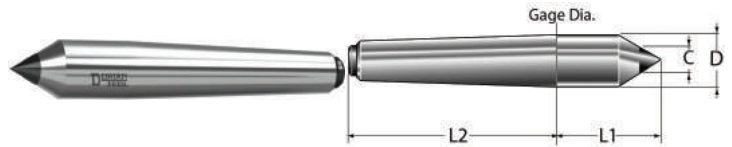

UPC #	Description	D	Gage Dia.	C	L1	L2	Morse Taper
48459	PLC-MTDC-CMT2	0.71	0.700	0.28	1.38	2.56	MT2
48460	PLC-MTDC-CMT3	0.95	0.938	0.43	1.73	3.19	MT3
48461	PLC-MTDC-CMT4	1.24	1.231	0.55	2.24	4.06	MT4
48462	PLC-MTDC-CMT5	1.76	1.748	0.71	2.68	5.19	MT5
48463	PLC-MTDC-CMT6	2.51	2.494	0.79	3.38	7.25	MT6

Precision CNC Steel Morse Taper Half Moon Dead Center with 60° Steel Point

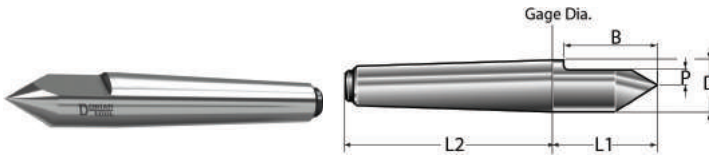

UPC #	Description	D	Gage Dia.	B	P	L1	L2	Morse Taper
48464	PLC-HMDC-SMT1	0.48	0.475	0.87	0.06	1.03	2.12	MT1
48465	PLC-HMDC-SMT2	0.71	0.700	1.18	0.08	1.38	2.56	MT2
48466	PLC-HMDC-SMT3	0.95	0.938	1.50	0.12	1.73	3.19	MT3
48467	PLC-HMDC-SMT4	1.24	1.231	1.97	0.20	2.24	4.06	MT4
48468	PLC-HMDC-SMT5	1.76	1.748	2.48	0.28	2.68	5.19	MT5
48469	PLC-HMDC-SMT6	2.51	2.494	3.11	0.39	3.38	7.25	MT6

Precision CNC Steel Morse Taper Half Moon Dead Center with 60° Carbide Point



UPC #	Description	D	Gage Dia.	B	C	P	L1	L2	Morse Taper
48470	PLC-HMDC-CMT2	0.71	0.700	1.18	0.28	0.08	1.38	2.56	MT2
48471	PLC-HMDC-CMT3	0.95	0.938	1.50	0.43	0.12	1.73	3.19	MT3
48472	PLC-HMDC-CMT4	1.24	1.231	1.97	0.55	0.20	2.24	4.06	MT4
48473	PLC-HMDC-CMT5	1.76	1.748	2.48	0.71	0.28	2.68	5.19	MT5
48474	PLC-HMDC-CMT6	2.51	2.494	3.11	0.79	0.39	3.38	7.25	MT6

Precision CNC Steel Dead Center with Large 60° Carbide Point
(Includes one 60° Intchangeable Steel Point)

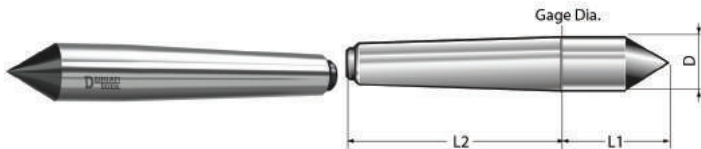

UPC #	Description	D	Gage Dia.	L1	L2	Morse Taper
48557	PLC-LPDC-CMT2	0.71	0.7	1.38	2.56	MT2
48558	PLC-LPDC-CMT3	0.95	0.938	1.73	3.19	MT3
48559	PLC-LPDC-CMT4	1.24	1.231	2.24	4.06	MT4
48560	PLC-LPDC-CMT5	1.76	1.748	2.68	5.19	MT5
48561	PLC-LPDC-CMT6	2.51	2.494	3.38	7.25	MT6

CNC Steel Threaded Dead Center for Interchangeable Point
(Includes one 60° Intchangeable Steel Point)

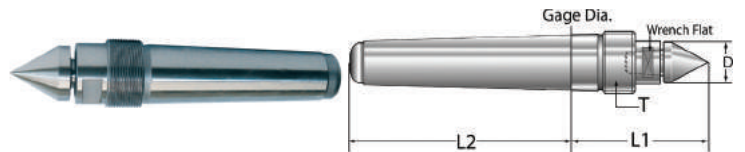

UPC #	Description	D	Gage Dia.	L1	L2	T Thread	Morse Taper
48446	PLC-CNC-ITDC-MT3	1.102	0.938	2.760	3.27	M36 x 1.5	MT3
48447	PLC-CNC-ITDC-MT4	1.260	1.231	2.93	4.11	M36 x 1.5	MT4
48448	PLC-CNC-ITDC-MT5	1.498	1.500	3.130	5.57	M48 x 1.5	MT5

High Speed Steel Morse Taper Extended Dead Center with 60° Carbide Point

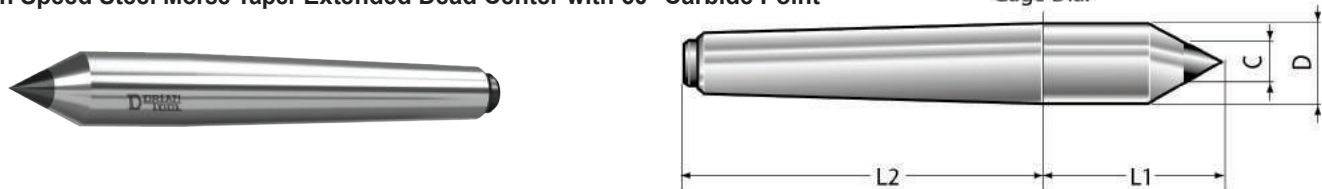

UPC #	Description	D	C	Gage Dia.	L1	L2	Morse Taper	Weight (lb)
48156	PLC-XMTDC-C10-MT2	0.71	0.39	0.700	2.16	2.56	MT2	0.44
48157	PLC-XMTDC-C14-MT2	0.71	0.55	0.700	2.16	2.56	MT2	0.44
48158	PLC-XMTDC-C18-MT2	0.87	0.71	0.700	2.16	2.56	MT2	0.44
48159	PLC-XMTDC-C10-MT3	0.95	0.39	0.938	2.24	4.06	MT3	1.10
48160	PLC-XMTDC-C14-MT3	0.95	0.55	0.938	2.24	4.06	MT3	1.10
48161	PLC-XMTDC-C18-MT3	0.95	0.71	0.938	2.27	4.06	MT3	1.10
48162	PLC-XMTDC-C22-MT3	0.95	0.87	0.938	2.24	4.06	MT3	1.10
48163	PLC-XMTDC-C10-MT4	1.24	0.39	1.231	4.68	3.19	MT4	2.20
48164	PLC-XMTDC-C14-MT4	1.24	0.55	1.231	5.31	2.56	MT4	2.20
48165	PLC-XMTDC-C18-MT4	1.24	0.71	1.231	4.68	3.19	MT4	2.20
48166	PLC-XMTDC-C22-MT4	1.24	0.87	1.231	4.68	3.19	MT4	2.20
48167	PLC-XMTDC-C26-MT4	1.24	1.02	1.231	3.81	4.06	MT4	2.20
48168	PLC-XMTDC-C14-MT5	1.76	0.55	1.748	6.26	3.19	MT5	5.28
48169	PLC-XMTDC-C18-MT5	1.76	0.71	1.748	6.89	2.56	MT5	5.28
48170	PLC-XMTDC-C22-MT5	1.76	0.87	1.748	6.26	3.19	MT5	5.28
48171	PLC-XMTDC-C26-MT5	1.76	1.02	1.748	6.26	3.19	MT5	5.50
48172	PLC-XMTDC-C30-MT5	1.76	1.18	1.748	5.39	4.06	MT5	5.50
48173	PLC-XMTDC-C14-MT6	2.51	0.55	2.494	8.62	3.19	MT6	11.88
48174	PLC-XMTDC-C18-MT6	2.51	0.71	2.494	9.25	2.56	MT6	12.76
48175	PLC-XMTDC-C22-MT6	2.51	0.87	2.494	8.62	3.19	MT6	12.76
48176	PLC-XMTDC-C26-MT6	2.51	1.02	2.494	8.62	3.19	MT6	12.76
48177	PLC-XMTDC-C30-MT6	2.51	1.18	2.494	7.75	4.06	MT6	13.20

High Speed Steel Morse Taper Extended Half Moon Dead Center with 60° Carbide Point

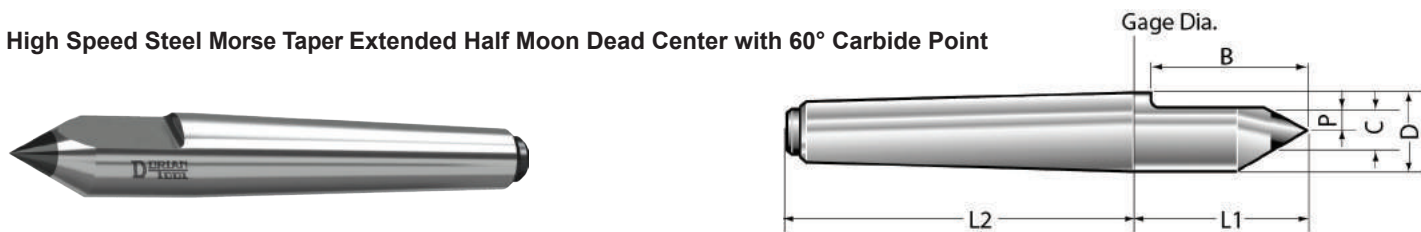

UPC #	Description	D	Gage Dia.	L1	L2	Morse Taper	B	C	P	Weight (lb)
48178	PLC-XMTDC-HC10-MT2	0.71	0.700	2.16	2.56	MT2	0.24	0.39	1.97	0.44
48179	PLC-XMTDC-HC14-MT2	0.71	0.700	2.16	2.56	MT2	0.31	0.55	1.97	0.44
48180	PLC-XMTDC-HC18-MT2	0.87	0.700	2.16	2.56	MT2	0.39	0.71	1.97	0.44
48181	PLC-XMTDC-HC10-MT3	0.95	0.938	3.11	3.19	MT3	0.24	0.39	2.76	1.10
48182	PLC-XMTDC-HC14-MT3	0.71	0.938	3.74	2.56	MT3	0.31	0.55	2.76	1.10
48183	PLC-XMTDC-HC18-MT3	0.95	0.938	3.11	3.19	MT3	0.39	0.71	2.76	1.10
48184	PLC-XMTDC-HC22-MT3	1.24	0.938	2.24	4.06	MT3	0.47	0.87	2.76	1.10
48185	PLC-XMTDC-HC10-MT4	1.24	1.231	4.68	3.19	MT4	0.24	0.39	3.54	2.20
48186	PLC-XMTDC-HC14-MT4	1.24	1.231	5.31	2.56	MT4	0.31	0.55	3.54	2.20
48187	PLC-XMTDC-HC18-MT4	1.24	1.231	4.68	3.19	MT4	0.39	0.71	3.54	2.20
48188	PLC-XMTDC-HC22-MT4	1.24	1.231	4.68	3.19	MT4	0.47	0.87	3.54	2.20
48189	PLC-XMTDC-HC26-MT4	1.24	1.231	3.81	4.06	MT4	0.55	1.02	3.54	2.20
48190	PLC-XMTDC-HC14-MT5	1.76	1.748	6.26	3.19	MT5	0.31	0.55	3.54	5.28
48191	PLC-XMTDC-HC18-MT5	1.76	1.748	6.89	2.56	MT5	0.39	0.71	3.54	5.28
48192	PLC-XMTDC-HC22-MT5	1.76	1.748	6.26	3.19	MT5	0.47	0.87	3.54	5.28
48193	PLC-XMTDC-HC26-MT5	1.76	1.748	6.26	3.19	MT5	0.55	1.02	3.54	5.50
48194	PLC-XMTDC-HC30-MT5	1.76	1.748	5.39	4.06	MT5	0.63	1.18	3.54	5.50
48195	PLC-XMTDC-HC14-MT6	2.51	2.494	8.62	3.19	MT6	0.31	0.55	3.94	5.28
48196	PLC-XMTDC-HC18-MT6	2.51	2.494	9.25	2.56	MT6	0.39	0.71	3.94	5.28
48197	PLC-XMTDC-HC22-MT6	2.51	2.494	8.62	3.19	MT6	0.47	0.87	3.94	5.28
48198	PLC-XMTDC-HC26-MT6	2.51	2.494	8.62	3.19	MT6	0.55	1.02	3.94	5.28
48199	PLC-XMTDC-HC30-MT6	2.51	2.494	7.75	4.06	MT6	0.63	1.18	3.94	5.28

MODULAR BULL NOSE SYSTEM FOR PIPES

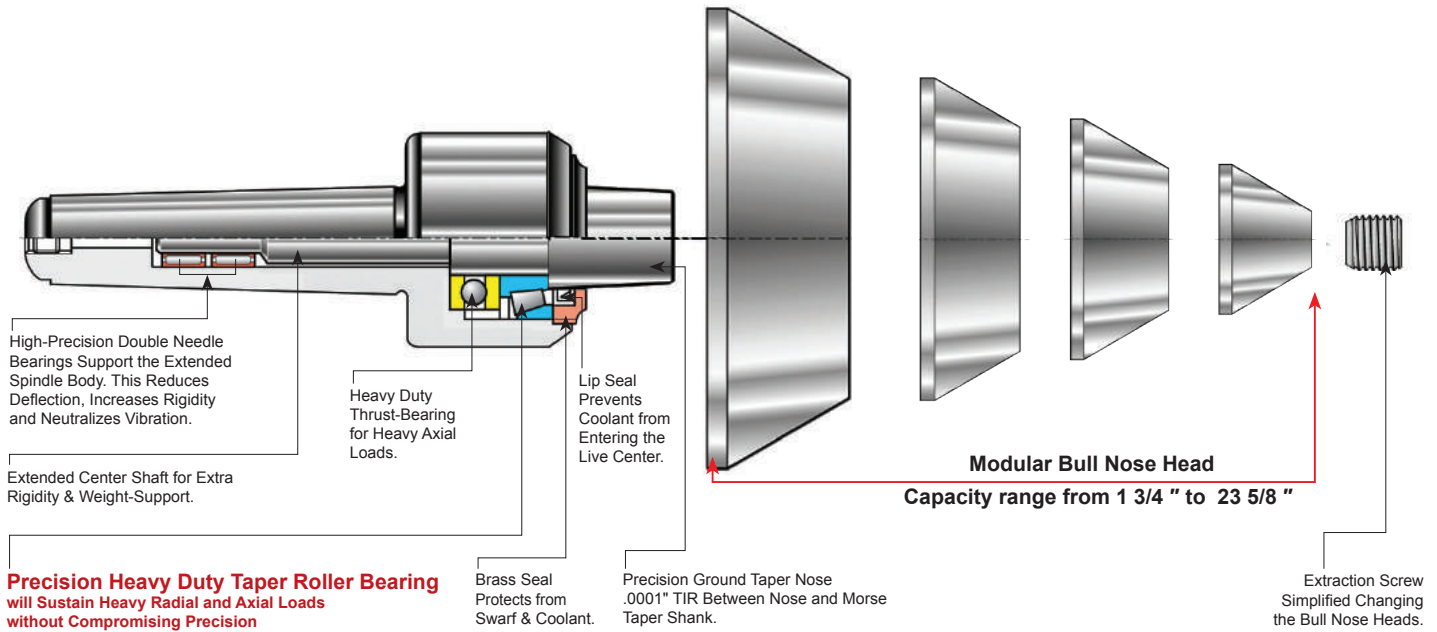

Extra Heavy Duty Modular Bull Nose Live Center



UPC #	Description	Morse Taper	Max. RPM	Max. workpiece weight (lb)	Thrust load (lb)
48400	PLC-HDA-BN-MT3	3	6000	2090	1144
48401	PLC-HDA-BN-MT4	4	4500	3300	1320
48402	PLC-HDA-BN-MT5	5	2800	4400	2640
48403	PLC-HDA-BN-MT6	6	2000	10560	3300
48404	PLC-HDA-BN-MT6X	6	1700	19800	6600

CNC Modular Bull Nose Dead Center



UPC #	Description	Morse Taper	Extractor Nut (sold separately)
48406	PLC-CNC-BNDC-MT3	3	48449
48407	PLC-CNC-BNDC-MT4	4	48450
48408	PLC-CNC-BNDC-MT5	5	48451
48409	PLC-CNC-BNDC-MT6	6	48452

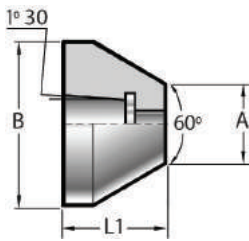

Modular Bull Nose Head Adapters											
UPC #	48420	48421	48422	48423	48424	48425	48426	48427	48428	48429	48430
Description	PLCBN-HA-0177-0386	PLCBN-HA-0374-0583	PLCBN-HA-0571-0780	PLCBN-HA-0768-0977	PLCBN-HA-0965-1174	PLCBN-HA-1162-1371	PLCBN-HA-1359-1568	PLCBN-HA-1556-1765	PLCBN-HA-1753-1962	PLCBN-HA-1950-2147	PLCBN-HA-2147-2364
A	1.77	3.74	5.71	7.68	9.65	11.62	13.59	15.56	17.53	19.50	21.47
B	3.86	5.83	7.80	9.77	11.74	13.71	15.68	17.65	19.62	21.47	23.64
L1	2.17	2.17	2.17	2.17	2.17	2.17	2.17	2.17	2.17	2.17	2.17
Nose Taper	60°	60°	60°	60°	60°	60°	60°	60°	60°	60°	60°

INTEGRAL LIVE PIPE CENTERS

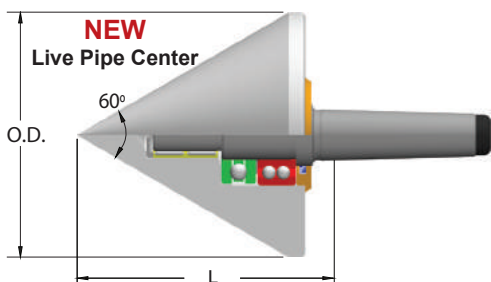

Live Pipe Center							
UPC #	Description	OD in	L in	Morse Taper	Max. workpiece weight	Max. RPM	Thrust load
48390	DPLC-MT4-125	5.31	5.75	MT4	7700 lbs	4000	3372 lbs
48391	DPLC-MT5-150	6.22	6.20	MT5	7700 lbs	3600	3372 lbs
48392	DPLC-MT6-150	6.22	6.25	MT6	7700 lbs	3600	3372 lbs

HEAVY DUTY PIPE DRIVERS ENGINEERED TO PERFORM!

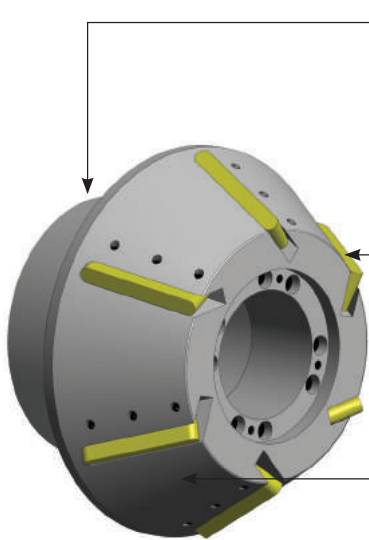
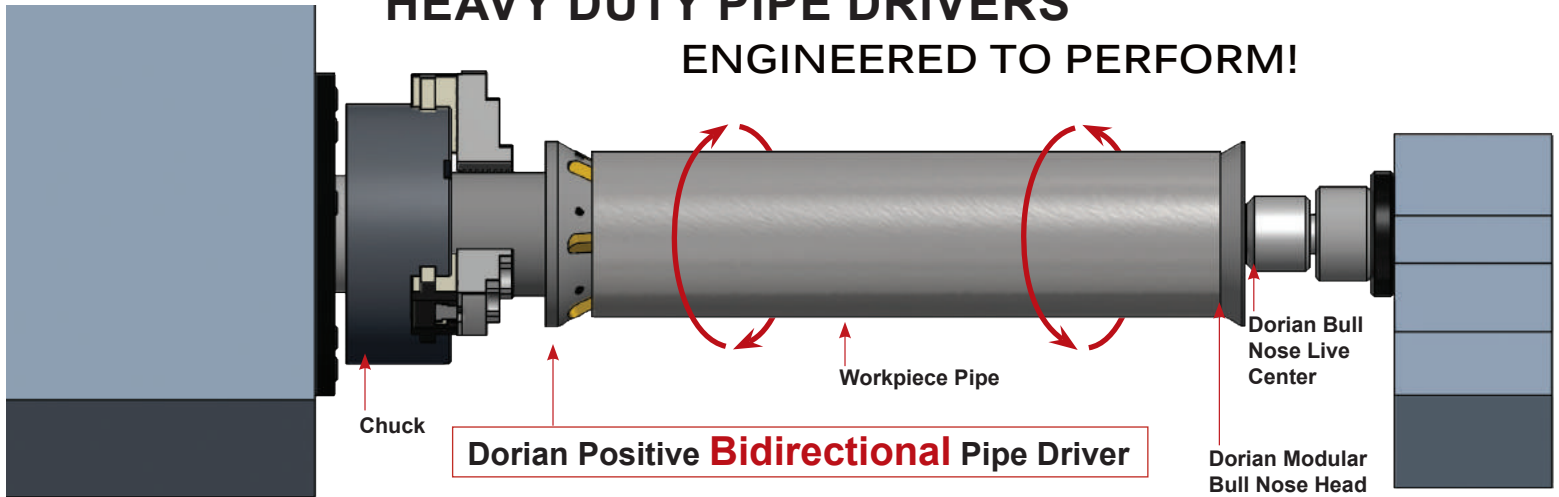

- Replaceable Hub**
- Can be chucked on O.D. or I.D.
 - Regrindable & Replaceable if damaged or scarred without needing to replace the pipe driver body
 - Heat treated alloy steel

- Positive Pipe Driver Blades**
- Indexable blades with 4 driving sides
 - Hardened D2 Tool Steel (60HRC)
 - Simple & Quick Installation
 - Engages to pipe's I.D. with positive locking action

- Pipe Driver Body**
- Heat treated alloy steel
 - Holds the driving blades with a positive rake
 - Blade slots are 45° to maximize grip & driving force

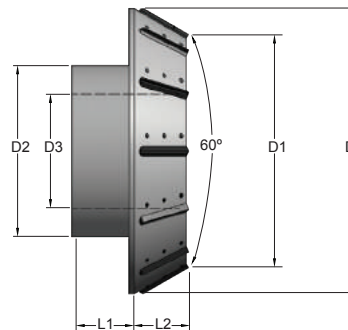
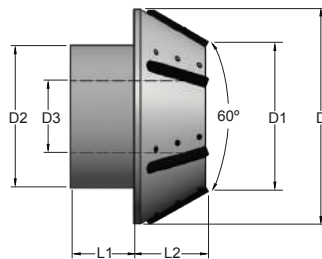
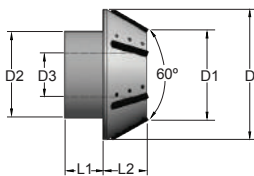
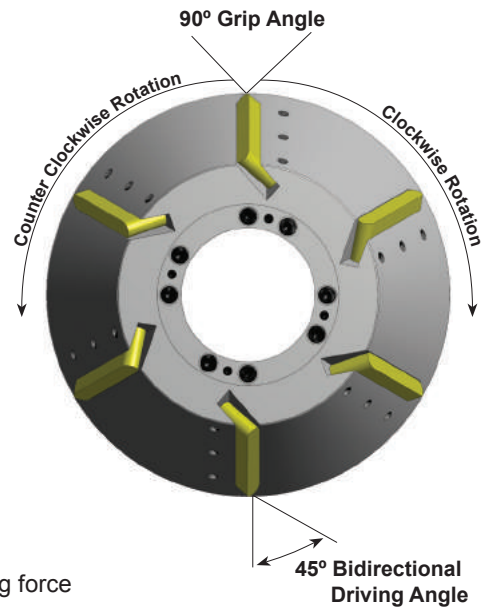

**1 3/4" to 23 5/8"
Pipe ID
Diameter Capacity**

Dorian Positive Pipe Driver								No. Blades Included	Blade Description	Dorian Bull Nose Cross-over		
UPC #	Description	D	D1	D2	D3	L1	L2			UPC #	Description	Range
48540	DPD045-150	5.91	1.77	2.76	-	2.99	4.13	6	PDB045-150	48420	PLCBN-HA0177-0386	1.77-3.86
48541	DPD095-200	7.87	3.74	4.72	1.81	2.99	4.13			48421	PLCBN-HA0374-0583	3.74-5.83
										48421	PLCBN-HA0374-0583	3.74-5.83
										48422	PLCBN-HA0571-0780	5.71-7.80
										48423	PLCBN-HA0768-0977	7.68-9.77
										48424	PLCBN-HA0965-1174	9.65-11.74
48542	DPD195-300	11.81	7.68	7.76	4.06	3.46	4.13	9	PDB200-600	48425	PLCBN-HA1162-1371	11.62-13.71
48543	DPD295-400	15.75	11.61	7.76	4.06	3.46	4.13			48426	PLCBN-HA1359-1568	13.59-15.68
										48427	PLCBN-HA1556-1765	15.56-17.65
										48428	PLCBN-HA1753-1962	17.53-19.62
										48429	PLCBN-HA1950-2147	19.50-21.47
										48430	PLCBN-HA2147-2364	21.47-23.64
48544	DPD395-500	19.69	15.55	11.69	7.99	3.94	4.13	12	PDB200-600			
48545	DPD495-600	23.62	19.49	11.69	7.99	3.94	4.13					

SUPER QUICK CHANGE TOOL POST

Rigidity, Repeatability & Quality

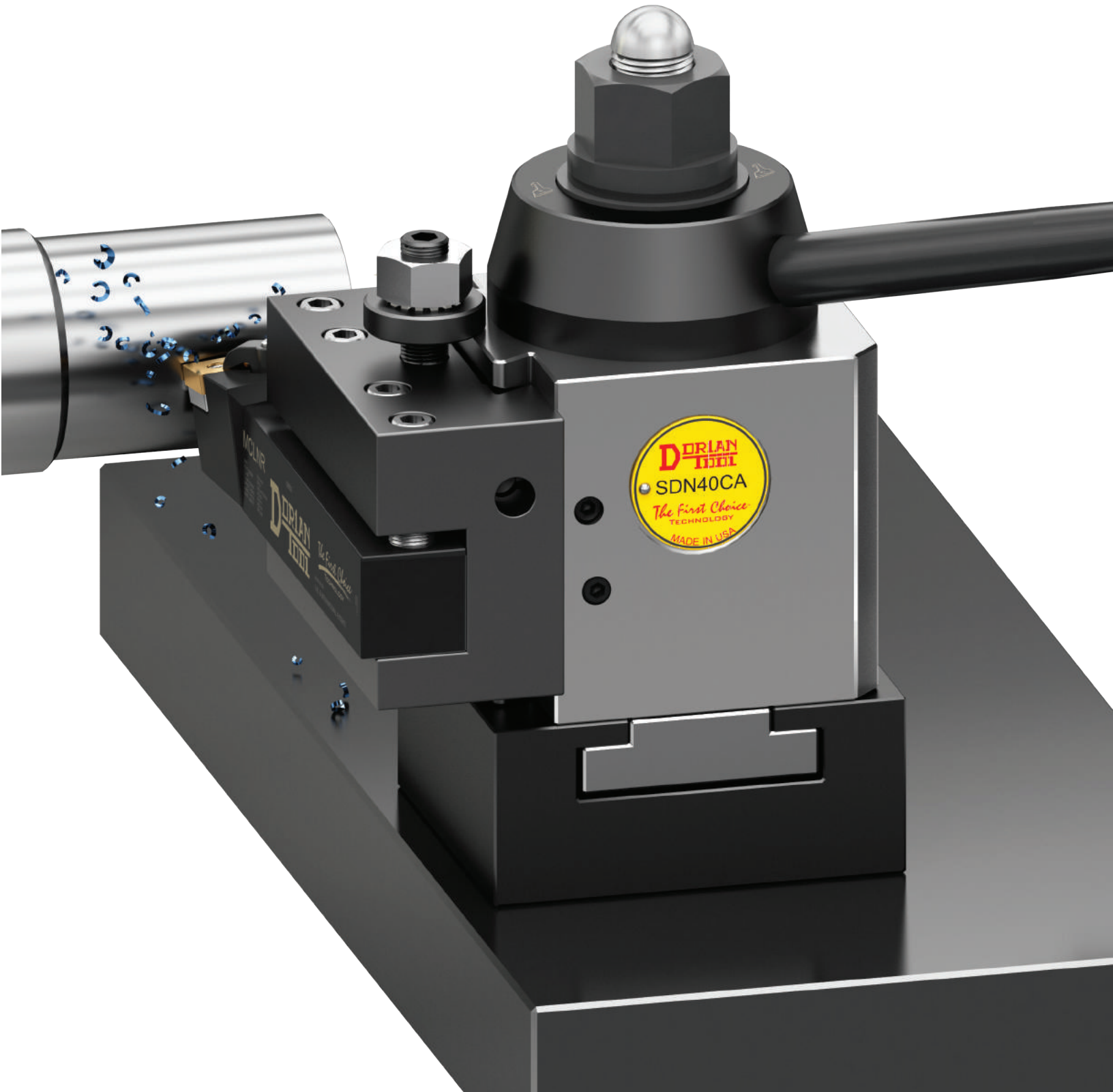

The Triple Action Wedge-Locking System

is a powerful combination of a **downward, outward and inward force** simultaneously locking the holder.

1. F1 Downward Force:

(shown right) Rotating the locking gear moves the gib down, expanding the tool post dovetail to lock the toolholder.

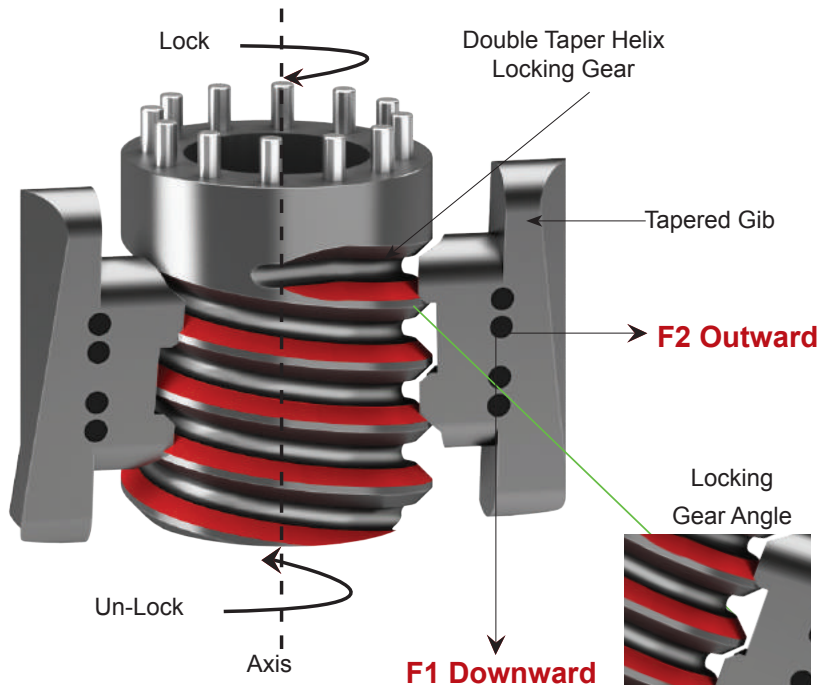

2. F2 Outward Force:

(shown right) When the gibs make full contact with the toolholder dovetail, the double-angle helix of the locking gear forces the gib outward, neutralizing any backlash to zero.

3. F3 Inward Force:

(shown right) The differential between the sliding gib angle and the quick change holder angle pulls the toolholder towards the tool post dovetail surface, creating a one-piece locking effect.

Wedge Style Sliding Gib

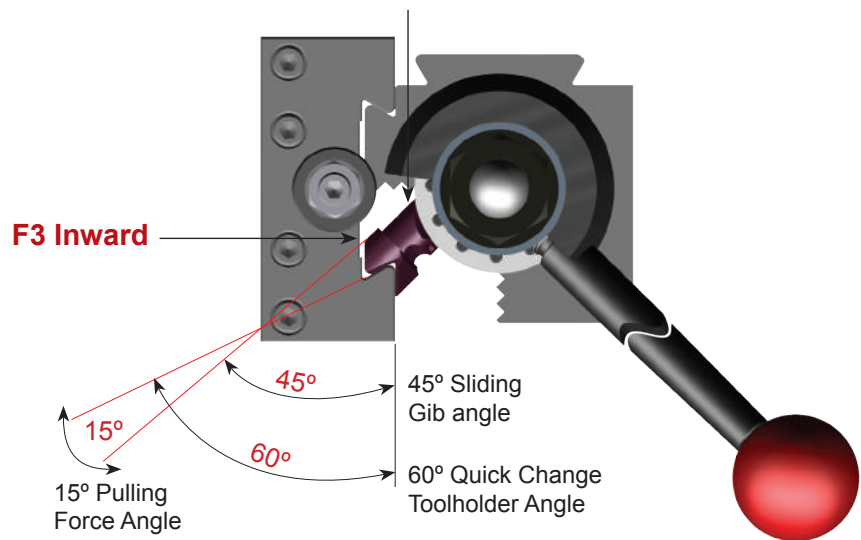

Description	SDN25AXA	SDN30BXA	SDN35CXA	SDN40CA	SDN50DA	SDN60EA
UPC #	01000	01002	01004	01006	01008	01010
Lathe Swing Over Bed	≤12	13-15	14-17	16-20	17-32	≥25
A	2.625	3.000	3.500	4.000	5.000	6.000
B	2.500	2.750	3.250	3.750	4.625	5.000
C	4.240	4.710	5.650	6.335	7.435	8.060
D	0.500	0.625	0.750	0.875	1.000	1.125
E	0.880	1.115	1.199	1.530	1.900	2.207
T-Tool Capacity	1/2-3/4	5/8-1.0	3/4-1.0	1.0-1¼	1¼-1½	1 1/2
Optimum Center Height	1.250	1.312	1.625	1.937	2.562	3.000
Minimum Center Height	0.875	1.062	1.250	1.562	2.000	2.500
Maximum Center Height	1.875	1.937	2.250	2.562	3.575	3.500
Holding Post Thread	1/2-20	5/8-18	3/4-16	7/8-14	1.0-14	1½-12

* Optimum center height is calculated with the smaller tool System of the tool capacity. If the higher System tool is to be used, add 1/8" to the optimum center height.

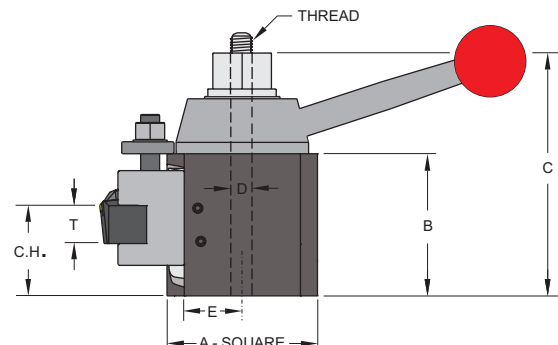

No. D1 Turning & Facing Tool holder

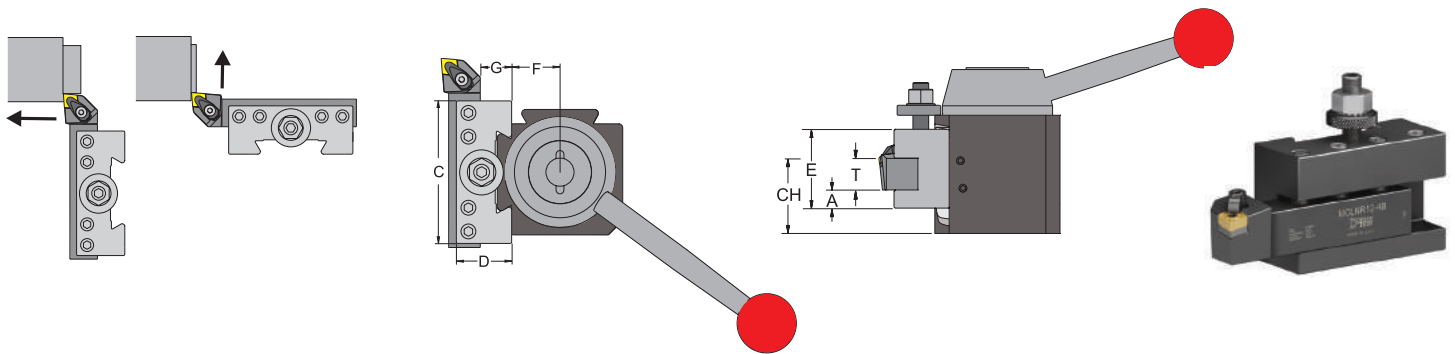

Description	UPC #	A	T	C	D	E	F	G
D25AXA-1	01100	0.375	0.750	2.750	1.250	1.750	0.880	.790
D30BXA-1	01250	0.437	1.000	3.250	1.500	2.250	1.115	.915
D35CXA-1	01400	0.500	1.000	3.750	1.750	2.500	1.199	1.040
D40CA-1	01550	0.562	1.250	4.500	2.000	3.000	1.530	1.040
D50DA-1	01700	0.750	1.500	6.000	2.500	3.500	1.900	1.290
D60EA-1	01850	1.000	1.500	7.000	3.000	4.000	2.207	1.540

No. D2 Turning, Facing & Boring Tool holder

The "V" groove makes this holder more versatile so that it can hold either square shank tool holders or boring bars. .

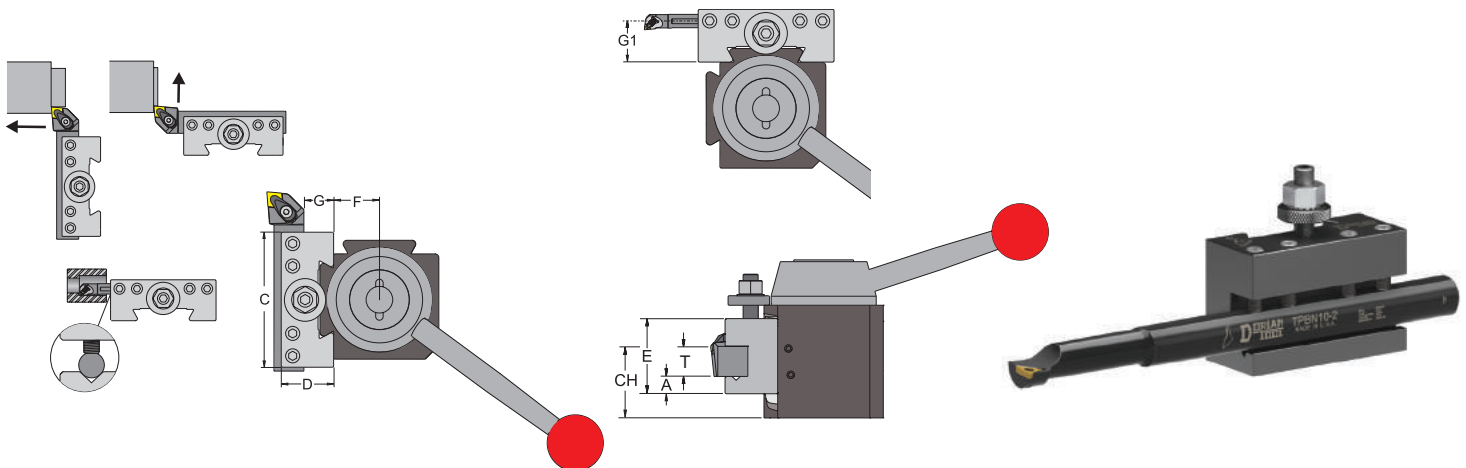

Description	UPC #	A	T	C	D	E	F	G	G1
D25AXA-2	01104	0.375	0.750	2.750	1.250	1.750	0.880	0.790	1.015
D30BXA-2	01254	0.437	1.000	3.250	1.500	2.250	1.115	0.915	1.205
D35CXA-2	01404	0.500	1.000	3.750	1.750	2.500	1.199	1.040	1.390
D40CA-2	01554	0.562	1.250	4.500	2.000	3.000	1.530	1.040	1.515
D50DA-2	01704	0.750	1.500	6.000	2.500	3.500	1.900	1.290	1.890
D60EA-2	01854	1.000	1.500	7.000	3.000	4.000	2.207	1.540	2.265

Dual Boring Bar Quick Change Holder with the Double Locking System

NEW

For Precise Set-up and Maximum Rigidity

- Boring Bar Center Line Set-up
- Set Screw Locking System
- 360° Collar Locking System
- Maximum Locking force
- No Boring Bar Damage
- Quick Release
- Quick Lock

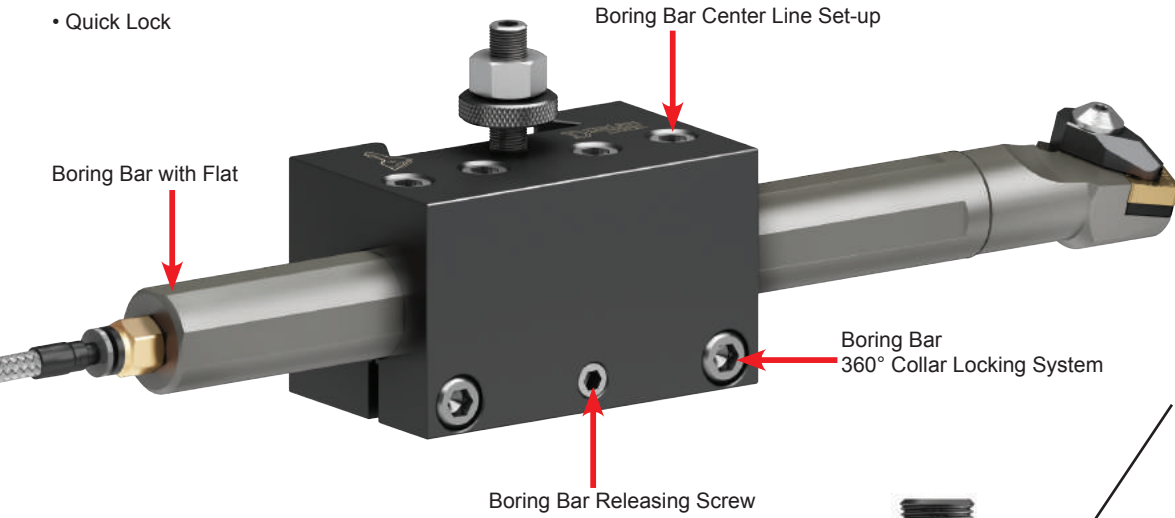

For boring Bars **with flats**
Use this screw to position
and lock center line

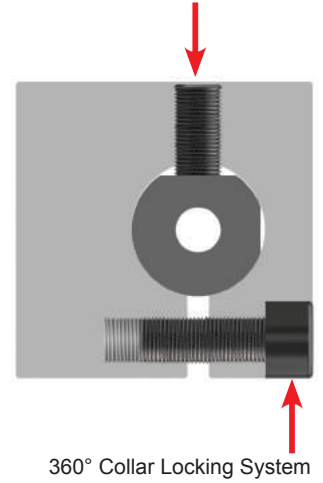

Boring Bar Releasing Screw



Ground flat screw, for precise insert center heights alignment and not to damage boring bar flats

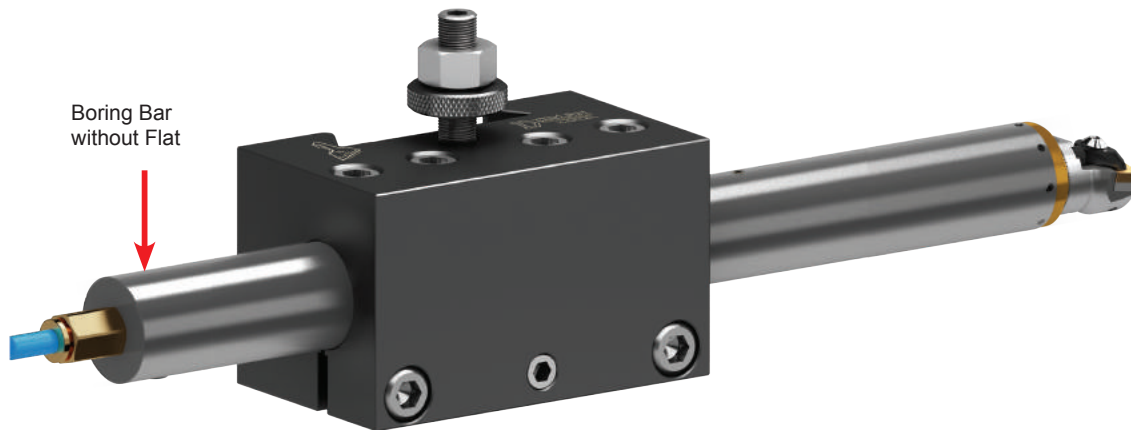

For Boring Bar with **no flats**
do not use this screw to
position or lock.

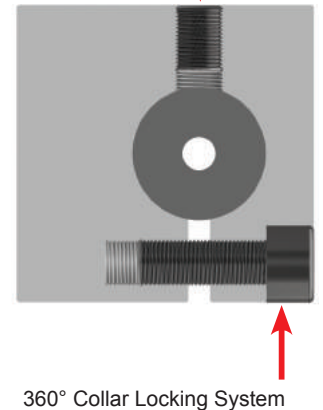

No. D4-DUAL Heavy Duty Boring Bar Tool holder

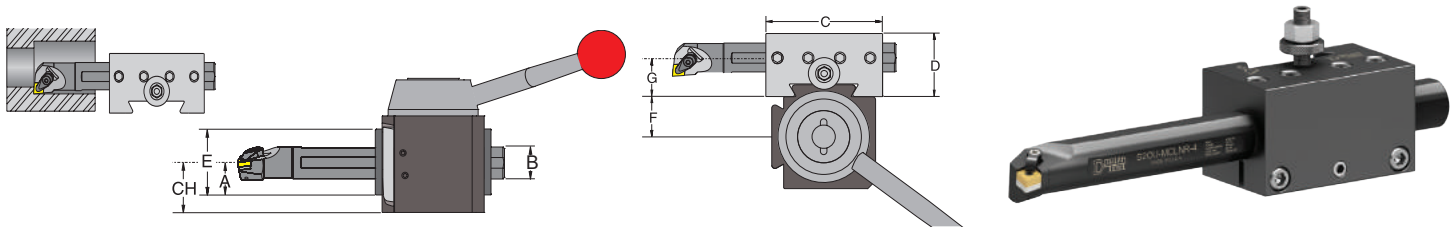

Description	UPC #	A	Boring Bar Capacity B	C	D	E	F	G
D25AXA-4-750-DUAL	01111	.745	.750	2.750	1.490	1.490	.880	.937
D30BXA-4-1000-DUAL	01261	.995	1.000	3.250	1.990	1.990	1.115	1.250
D35CXA-4-1000-DUAL	01411	1.120	1.000	3.750	2.240	2.240	1.199	1.375
D40CA-4-1250-DUAL	01559	1.245	1.250	4.500	2.490	2.490	1.530	1.500
D50DA-4-1500-DUAL	01709	1.495	1.500	5.500	2.990	2.990	1.900	2.000
D60EA-4-2000-DUAL	01859	1.995	2.000	6.500	3.990	3.990	2.207	2.500

No. D41-DUAL Extra Heavy Duty Boring Bar Tool holder

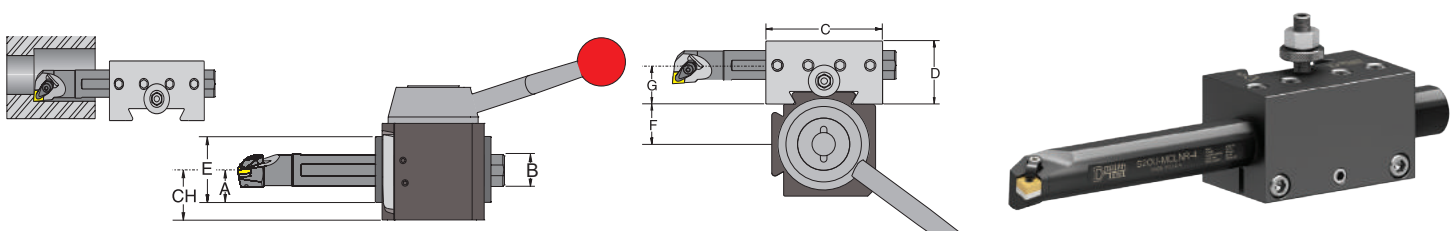

Description	UPC #	A	Boring Bar Capacity B	C	D	E	F	G
D25AXA-41-1000-DUAL	01113	.870	1.000	2.750	1.740	1.740	.880	1.062
D30BXA-41-1250-DUAL	01263	1.120	1.250	3.250	2.240	2.240	1.115	1.375
D35CXA-41-1250-DUAL	01413	1.120	1.250	3.750	2.240	2.240	1.199	1.375
D40CA-41-1500-DUAL	01563	1.245	1.500	4.500	2.490	2.490	1.530	1.500
D50DA-41-2000-DUAL	01713	1.745	2.000	5.500	3.490	3.490	1.900	2.250
D60EA-41-2500-DUAL	01863	1.995	2.500	6.500	3.990	3.990	2.207	2.375

No. DQ41S-DUAL Super Over Sized Boring Bar Tool holder

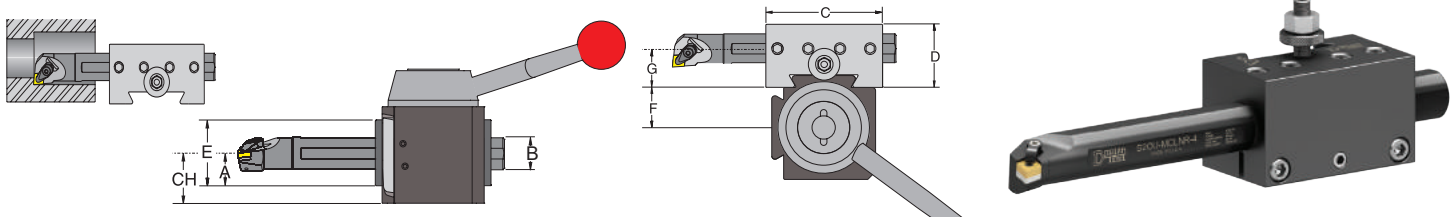

Description	UPC #	A	Boring Bar Capacity B	C	D	E	F	G
DQ35CXA-41S-1500-DUAL	00415	1.245	1.500	4.000	2.490	2.490	1.199	1.500
DQ40CA-41S-2000-DUAL	00565	1.495	2.000	4.500	2.990	2.990	1.530	1.750
DQ50DA-41S-2500-DUAL	00715	1.995	2.500	6.500	3.990	3.990	1.900	2.250
DQ60EA-41S-3000-DUAL	00865	2.245	3.000	7.000	4.490	4.490	2.207	2.625

No. D5 Morse Taper Tool holder

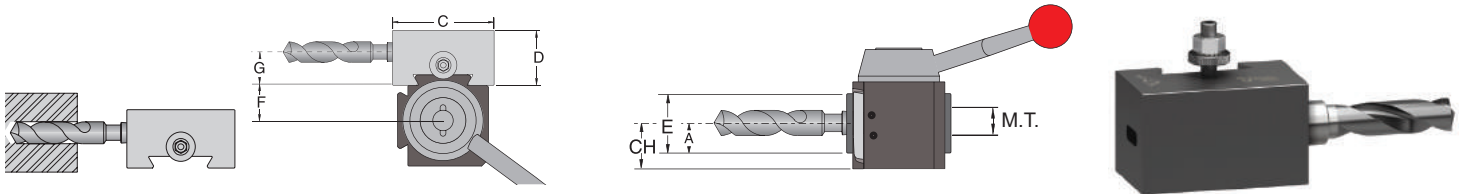

Description	UPC #	A	Morse Taper	C	D	E	F	G
D35CXA-5-4	01424	1.125	MT4	4.150	2.500	2.250	1.199	1.615
D40CA-5-4	01572	1.250	MT4	4.500	2.500	2.500	1.530	1.615
D50DA-5-5	01722	1.750	MT5	5.625	3.500	3.500	1.900	2.300
D60EA-5-5	01872	1.750	MT5	5.500	3.500	3.500	2.207	2.240

No. D7-71C Extra Heavy Duty Cut-Off Blade Tool holder

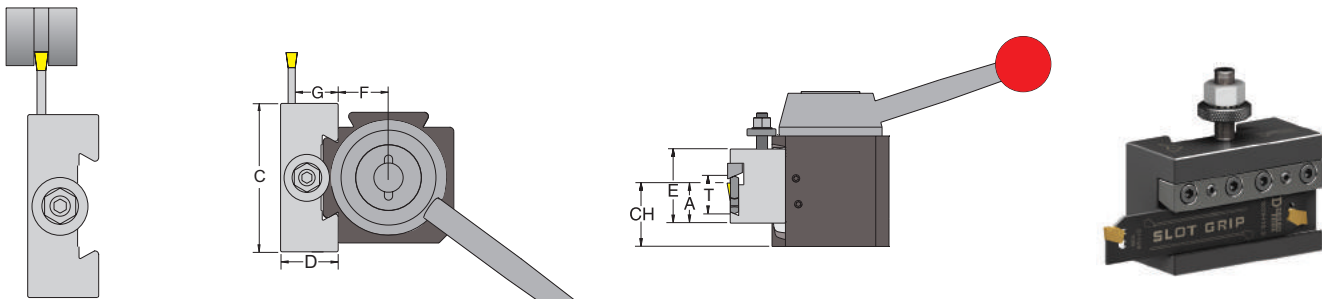

Description	UPC #	A	Slot Grip Blade T	C	D	E	F	G
D25AXA-7-71C	01126	0.933	SGIH-19-2	2.750	1.250	2.000	0.880	1.127
D30BXA-7-71C	01276	0.933	SGIH-19-2	3.250	1.250	2.000	1.115	1.127
D35CXA-7-71C	01428	1.255	SGIH-26-2 to 26-6	3.750	1.750	2.500	1.245	1.520
D40CA-7-71C	01576	1.255	SGIH-26-2 to 26-6	4.500	1.750	3.000	1.530	1.520
D50DA-7-71C	01726	1.483	SGIH-32-3 to 32-9	6.000	2.000	3.000	1.900	1.710
D60EA-7-71C	01876	2.050	SGIH-32-3 to 32-9	7.000	2.250	3.500	2.207	1.980

No. D35 Drill Chuck Tool holder

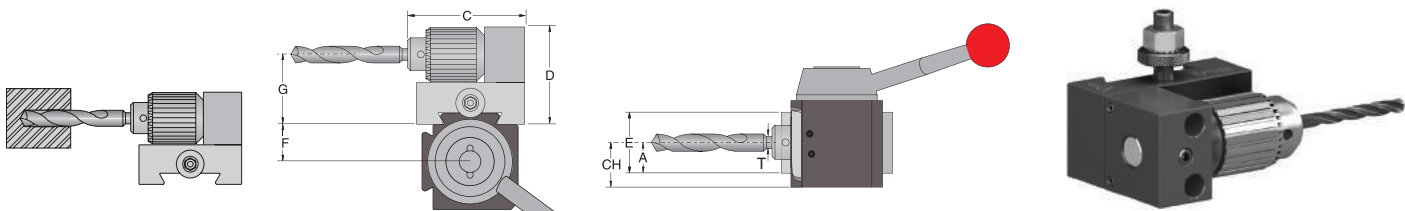

Description	UPC #	A	T Capacity	C	D	E	F	G
D25AXA-35	01140	1.000	0 - .500	4.175	3.101	2.000	0.880	2.063
D30BXA-35	01290	1.000	0 - .500	4.175	3.101	2.000	1.115	2.063
D35CXA-35	01442	1.125	0 - .500	4.673	3.726	2.250	1.199	2.625
D40CA-35	01590	1.125	0 - .500	4.673	3.726	2.250	1.530	2.625

No. D881 O.D. and I.D. Threading Toolholder

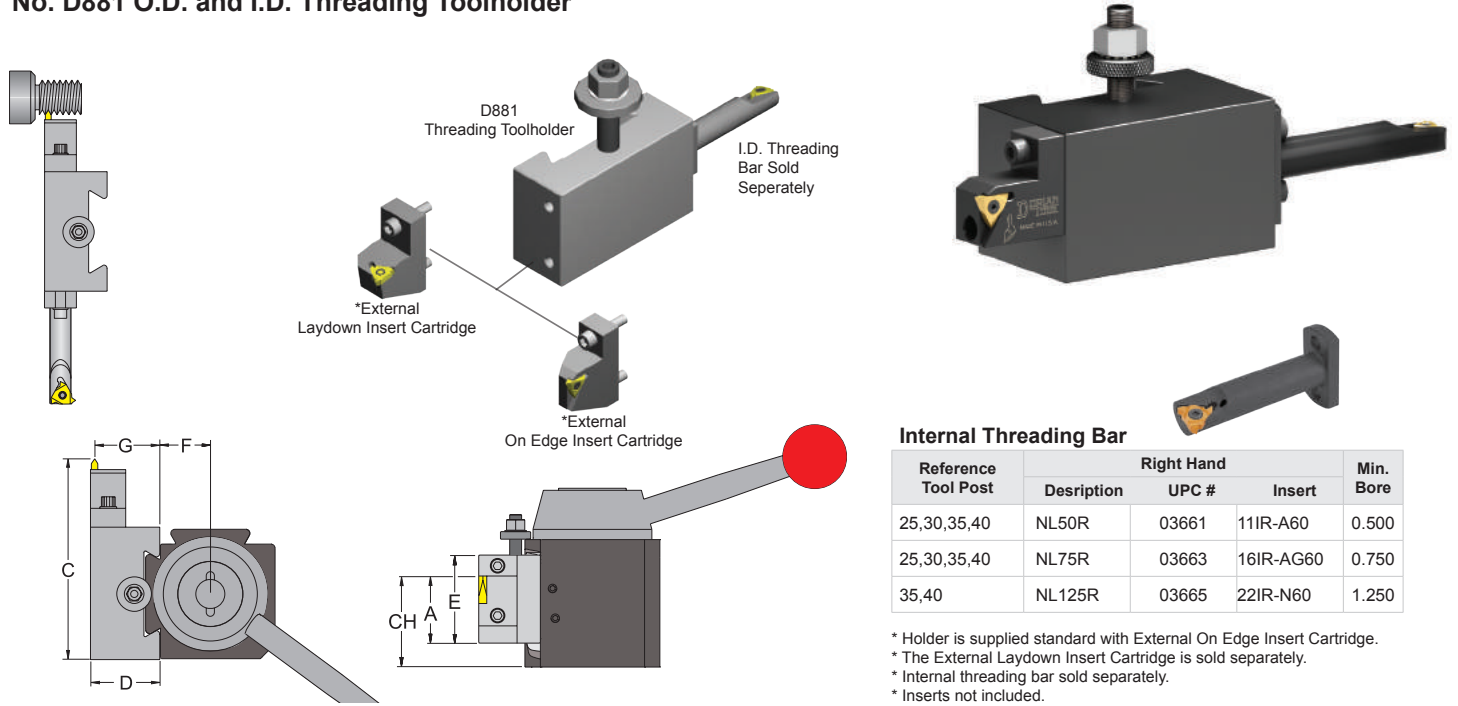

Description	UPC #	A	C	D	E	F	G	*External On Edge Insert Cartridge				*External Laydown Insert Cartridge					
								Description	UPC #	TNMC Insert	Torx Screw	Torx Key	Description	UPC #	Insert	Torx Screw	Torx Key
D25AXA-881-OE	01132	0.875	3.869	1.000	1.500	0.880	1.000	TIH253-32	03621	32	GTS-1M	T-10	NL253-3R	03635	16ER-AG60	TS-16	T-10
D30BXA-881-OE	01282	1.000	4.369	1.250	1.750	1.115	1.250	TIH354-32	03623	32	GTS-1M	T-10	NL354-3R	03637	16ER-AG60	TS-16	T-10
D35CXA-881-OE	01434	1.250	5.119	1.500	2.000	1.199	1.435										
D40CA-881-OE	01582	1.500	5.619	1.500	2.250	1.530	1.435										

No. D36 5C Collet Toolholder

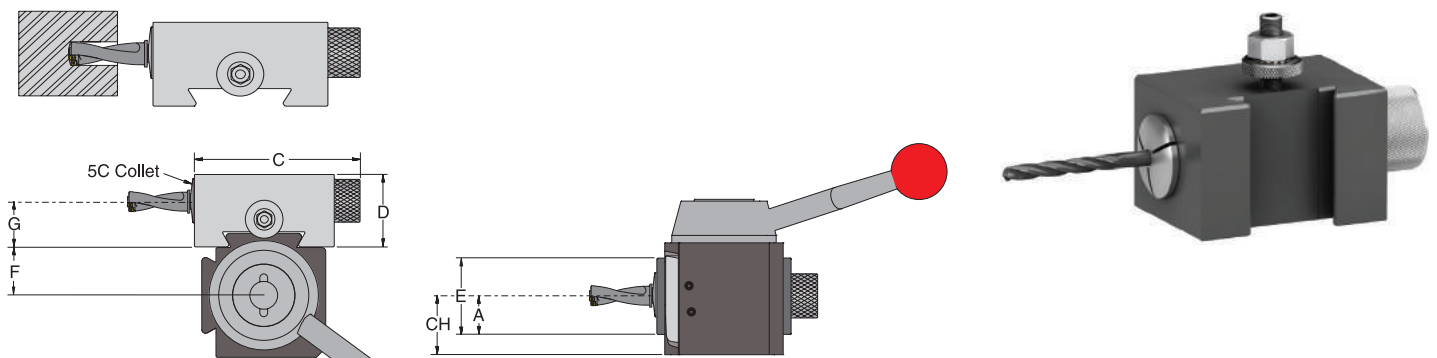

Description	UPC #	A	C	D	E	F	G
D25AXA-36	01142	1.125	4.250	2.500	2.250	0.880	1.500
D30BXA-36	01292	1.250	4.250	2.500	2.250	1.115	1.500
D35CXA-36	01444	1.375	4.500	2.750	2.750	1.199	1.625
D40CA-36	01592	1.375	5.000	2.750	2.750	1.530	1.625

Turning Set Includes

- (1) Tool Post
- (4) Holders

Tooling Not Included



UPC #	01014	01015	01016	01017	01018	01019
Description	SDN25AXA-TS	SDN30BXA-TS	SDN35CXA-TS	SDN40CA-TS	SDN50DA-TS	SDN60EA-TS
Set Includes						
(1) Tool Post	SDN25AXA	SDN30BXA	SDN35CXA	SDN40CA	SDN50DA	SDN60EA
(4) Holders	(2) D25AXA-1 (2) D25AXA-2	(2) D30BXA-1 (2) D30BXA-2	(2) D35CXA-1 (2) D35CXA-2	(2) D40CA-1 (2) D40CA-2	(2) D50DA-1 (2) D50DA-2	(2) D60EA-1 (2) D60EA-2

Standard Set Includes

- (1) Tool Post
- (4) Holders

Tooling Not Included

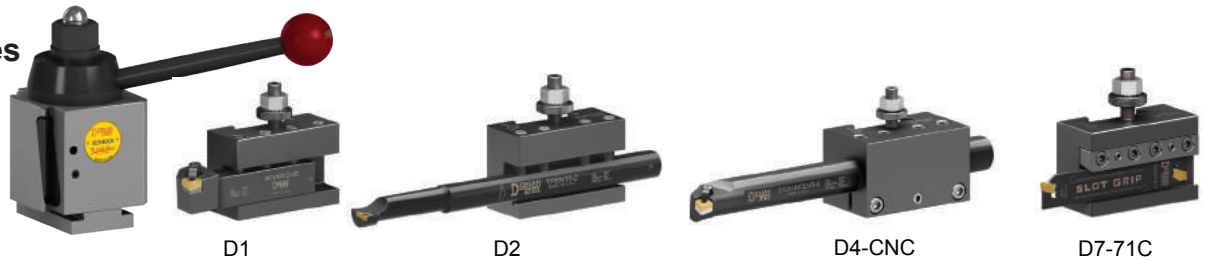

UPC #	01020	01021	01022	01023	01024	01025
Description	SDN25AXA-INSS	SDN30BXA-INSS	SDN35CXA-INSS	SDN40CA-INSS	SDN50DA-INSS	SDN60EA-INSS
Set Includes						
(1) Tool Post	SDN25AXA	SDN30BXA	SDN35CXA	SDN40CA	SDN50DA	SDN60EA
(4) Holders	(1) D25AXA-1 (1) D25AXA-2 (1) D25AXA-4-CNC (1) D25AXA-7-71C	(1) D30BXA-1 (1) D30BXA-2 (1) D30BXA-4-CNC (1) D30BXA-7-71C	(1) D35CXA-1 (1) D35CXA-2 (1) D35CXA-4-CNC (1) D35CXA-7-71C	(1) D40CA-1 (1) D40CA-2 (1) D40CA-4-CNC (1) D40CA-7-71C	(1) D50DA-1 (1) D50DA-2 (1) D50DA-4-CNC (1) D50DA-7-71C	(1) D60EA-1 (1) D60EA-2 (1) D60EA-4-CNC (1) D60EA-7-71C

SUPER Quick Change **First Time Buyer Set** Includes **FREE TOOLING**

Set Includes:

- (1) Tool Post
- (4) Holders
- (4) Toolholders **FREE**
- (5) Inserts **FREE**

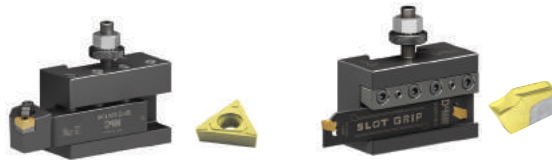

1ea. D1 + **Free** Toolholder &
1 **Free** TCMT Turning Insert

1ea. D7-71C + **Free** Blade &
1 **Free** Cut-off Insert



1ea. D2 + **Free** Boring Bar &
1 **Free** TCMT Turning Insert



1ea. D881 + **Free** ID Threading Bar
& 1 **Free** TNMC OnEdge & 1 **Free**
Laydown Threading Inserts

UPC #	01056	01058	01060	01062
Description	SDN25AXA-FTB	SDN30BXA-FTB	SDN35CXA-FTB	SDN40CA-FTB
Set Includes				
(1) Tool Post	SDN25AXA	SDN30BXA	SDN35CXA	SDN40CA
(4) Holders	D25AXA-1 D25AXA-2 D25AXA-7-71C D25AXA-881-OE	D30BXA-1 D30BXA-2 D30BXA-7-71C D30BXA-881-OE	D35CXA-1 D35CXA-2 D35CXA-7-71C D35CXA-881-OE	D40CA-1 D40CA-2 D40CA-7-71C D40CA-881-OE
Free Tooling				
(4) Toolholders	STNCR08-2J STCMB06-2 SGIH19-2 NL50R	STNCR10-2A STCMB08-2 SGIH19-2 NL50R	STNCR12-3B STCMB10-2 SGIH26-3 NL75R	STNCR64-3D STCMB12-3 SGIH26-3 NL75R
(5) Inserts	TCMT-21.51-PEM-DPC25UT TCMT-21.52-PEM-DPC25UT SGTN-2-DC656 TNMC-32NV-DVP656 11IR-A60-DVP656	TCMT-21.51-PEM-DPC25UT TCMT-21.52-PEM-DPC25UT SGTN-2-DC656 TNMC-32NV-DVP656 11IR-A60-DVP656	TCMT-21.51-PEM-DPC25UT TCMT-32.52-PEM-DPC25UT SGTN-3-DC656 TNMC-32NV-DVP656 16IR-A60-DVP656	TCMT-21.51-PEM-DPC25UT TCMT-32.52-PEM-DPC25UT SGTN-3-DC656 TNMC-32NV-DVP656 16IR-A60-DVP656

QUADRA INDEXING QUICK CHANGE

STRONG
RIGID, QUICK
&
PRECISE

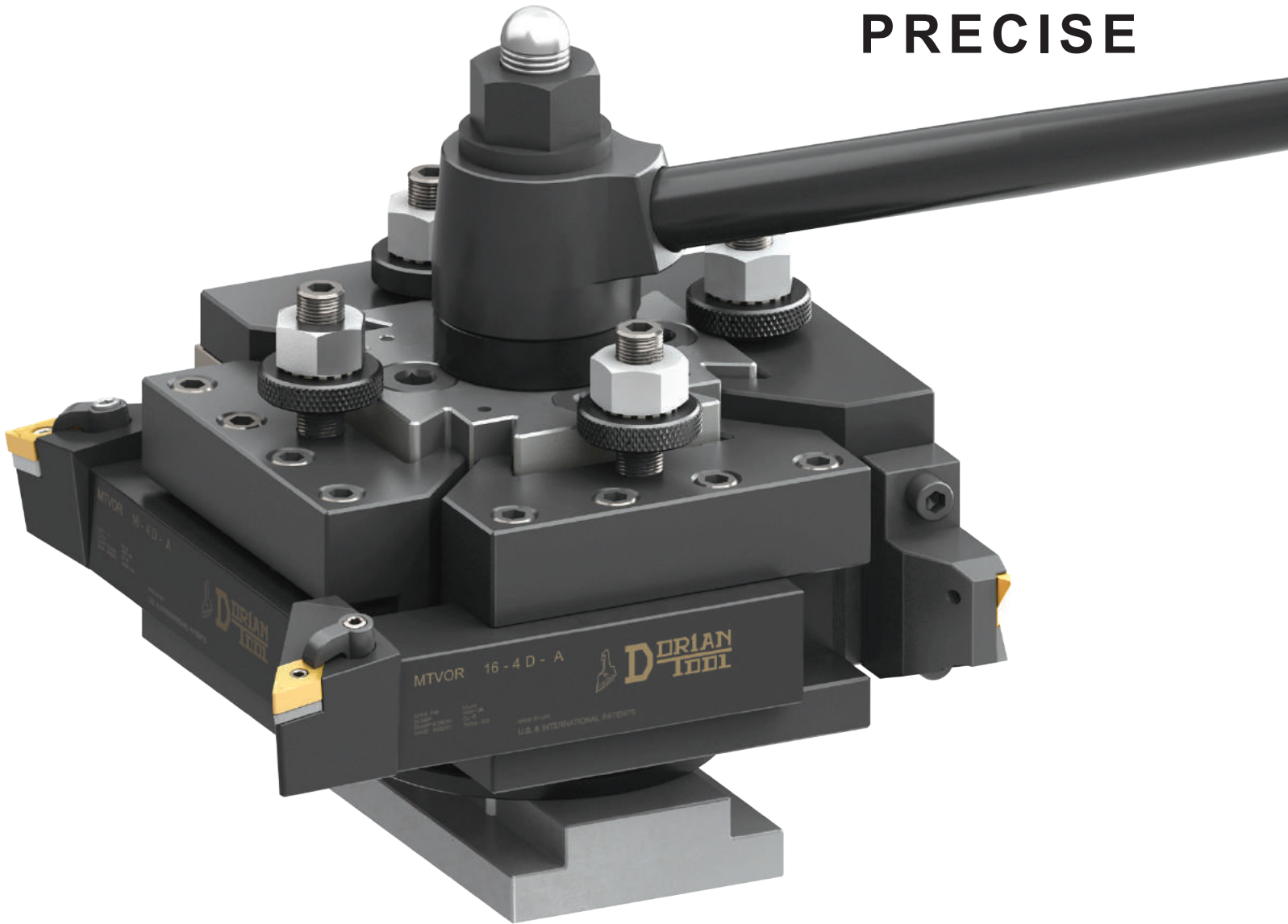

4 Toolholders Held Simultaneously!

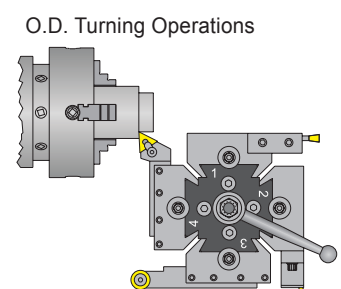
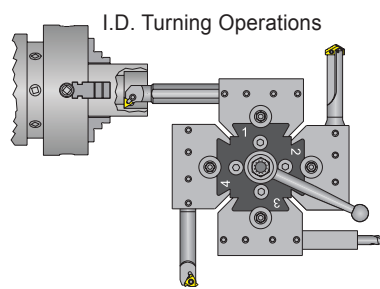
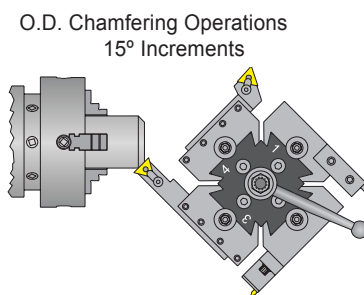
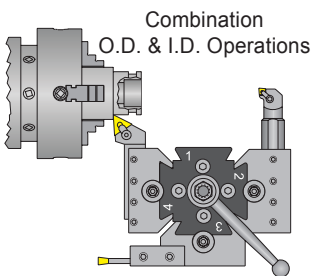

NEW LOCKING & INDEXABLE SYSTEM

with 24 SUPER PRECISE POSITIONING BALL BEARINGS & 2 PRE-LOADED INDEXING PINS

Tool Post Indexing

- Indexing Flexibility every 15°
- 24 Locking Positions
- Multi-position of the locking handle
- Instant Tool Repositioning
- From Prototypes to High Production

Quick Change Tool Holders

- 4 Tool Holders Locked Simultaneously
- 1 to 4 Tool Holders ready to be used
- Positive Lock with absolute zero backlash
- Tool holder repeatability within .0001"
- Indexing repeatability within .00005"

Tool Post Application

- 6 sizes of Tool Post available
- From tool room to oil country lathes
- Quick and versatile for finishing
- Strong for heavy-duty roughing
- Easy to install
- Maintenance free



Description	QITP25N	QITP30N	QITP35N	QITP40N	QITP50N	QITP60N
UPC #	00000	00002	00004	00006	00008	00010
Lathe Swing Over Bed	≤12"	13-15"	14-17"	16-20"	17-32"	≥25-XHD
A	2.500	3.000	3.500	4.000	5.000	6.000
B	2.570	3.205	3.460	4.070	5.230	5.615
C	5.210	5.720	6.415	7.525	9.135	9.855
D	0.500	0.500	0.625	0.750	1.000	1.125
E	0.880	1.115	1.245	1.530	1.897	2.207
T-Tool Capacity	1/2-3/4	5/8-1.0	3/4-1.0	1.0-1¼	1¼ - 1½	1 ½
Optimum Center Height*	1.422	1.747	1.835	2.202	2.995	3.440
Min.Center Height	0.995	1.213	1.445	1.757	2.245	2.750
Max.Center Height	1.849	2.282	2.225	2.646	3.744	4.129
Holding Post Thread	1/2-20	1/2-20	5/8-18	3/4-16	1.0-14	1½-12

*Optimum center height is calculated with the smaller tool System of the tool capacity.

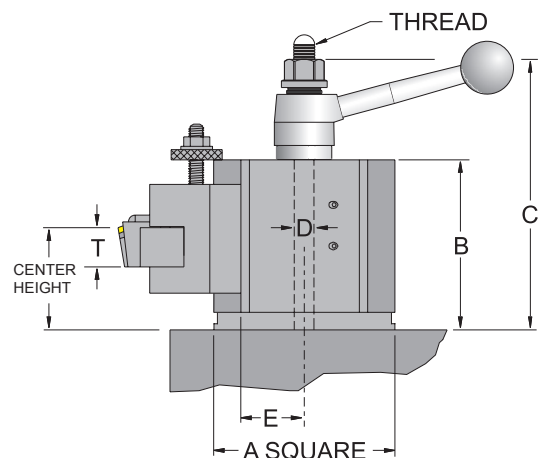

No. QITPN-1 Turning & Facing Tool holder

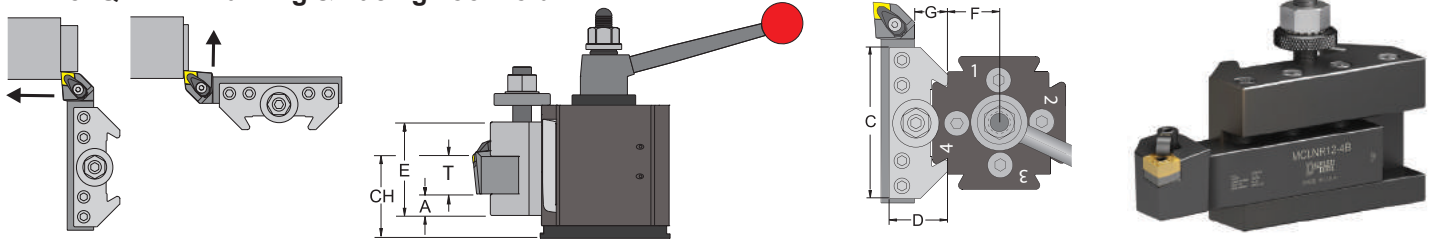

Description	UPC #	A	T	C	D	E	F	G
QITP25N-1	00100	0.375	0.750	2.750	1.240	1.740	0.880	0.770
QITP30N-1	00250	0.437	1.000	3.250	1.490	2.240	1.115	0.890
QITP35N-1	00400	0.500	1.000	3.750	1.740	2.490	1.245	1.010
QITP40N-1	00550	0.562	1.250	4.500	1.990	2.990	1.530	1.040
QITP50N-1	00700	0.750	1.500	6.000	2.490	3.490	1.900	1.290
QITP60N-1	00850	1.000	1.500	7.000	2.990	3.990	2.207	1.540

No. QITPN-2 Turning, Facing & Boring Tool holder

The "V" groove makes this holder more versatile so that it can hold either square shank tool holders or boring bars.

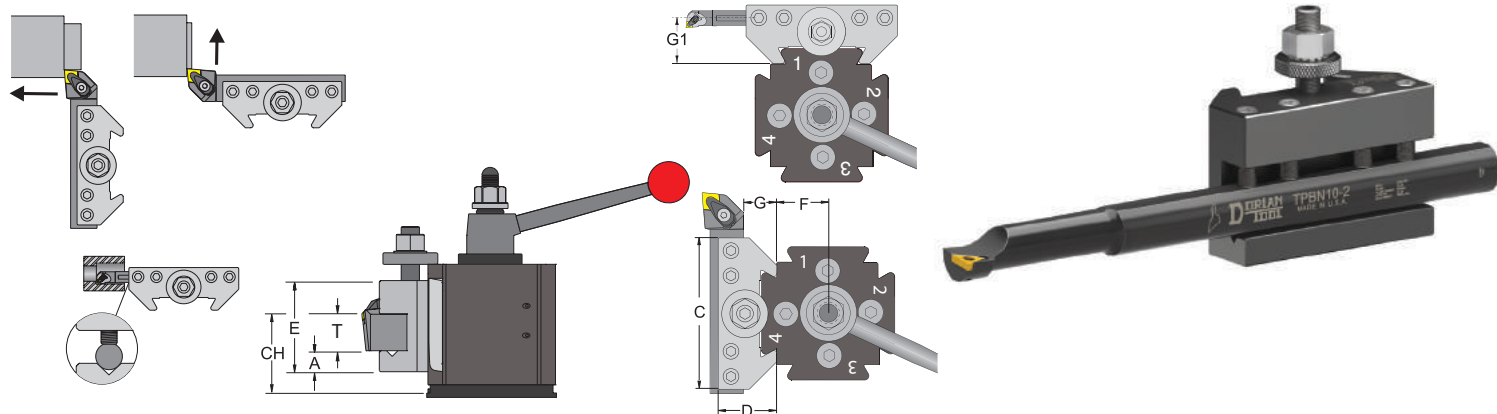

Description	UPC #	A	T	C	D	E	F	G	G1
QITP25N-2	00104	0.375	.750	2.750	1.240	1.740	0.880	0.770	1.030
QITP30N-2	00254	0.437	1.000	3.250	1.490	2.240	1.115	0.890	1.210
QITP35N-2	00404	0.500	1.000	3.750	1.740	2.490	1.245	1.010	1.410
QITP40N-2	00554	0.562	1.250	4.500	1.990	2.990	1.530	1.040	1.575
QITP50N-2	00704	0.750	1.500	6.000	2.490	3.490	1.900	1.290	1.950
QITP60N-2	00854	1.000	1.500	7.000	2.990	3.990	2.207	1.540	2.340

No. QITPN-7-71C Extra Heavy Duty Cut-Off Blade Tool holder

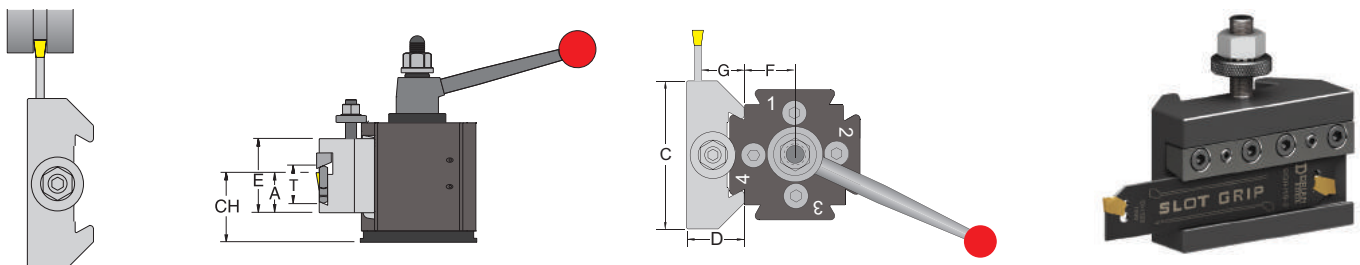

Description	UPC #	Slot Grip Blade		C	D	E	F	G
		A	T					
QITP25N-7-71C	00126	0.933	SGIH-19-2	2.750	1.250	2.000	0.880	1.127
QITP30N-7-71C	00276	0.933		3.250	1.250	2.000	1.115	1.127
QITP35N-7-71C	00428	1.255	SGIH-	3.750	1.750	2.500	1.245	1.520
QITP40N-7-71C	00576	1.255	26-2 to 26-6	4.500	1.750	3.000	1.530	1.520
QITP50N-7-71C	00726	1.483	SGIH-	6.000	2.000	3.000	1.900	1.710
QITP60N-7-71C	00876	2.050	32-3 to 32-9	7.000	2.250	3.500	2.207	2.150

No. QITPN-4-DUAL Heavy Duty Boring Bar Tool holder

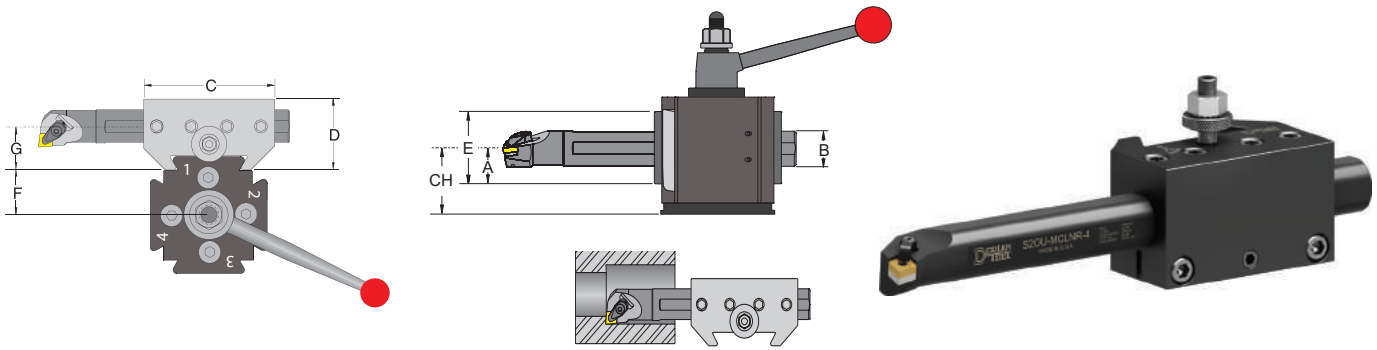

Description	UPC #	Boring Bar Capacity						
		A	B	C	D	E	F	G
QITP25N-4-750-DUAL	00111	0.745	0.750	2.750	1.490	1.490	0.880	0.937
QITP30N-4-1000-DUAL	00261	0.995	1.000	3.250	1.990	1.990	1.115	1.250
QITP35N-4-1000-DUAL	00411	1.120	1.000	3.750	2.240	2.240	1.245	1.375
QITP40N-4-1250-DUAL	00561	1.245	1.250	4.500	2.490	2.490	1.530	1.500
QITP50N-4-1500-DUAL	00711	1.495	1.500	5.500	2.990	2.990	1.900	2.000
QITP60N-4-2000-DUAL	00861	1.995	2.000	6.500	3.990	3.990	2.207	2.500

No. QITPN-41-DUAL Extra Heavy Duty Boring Bar Tool holder

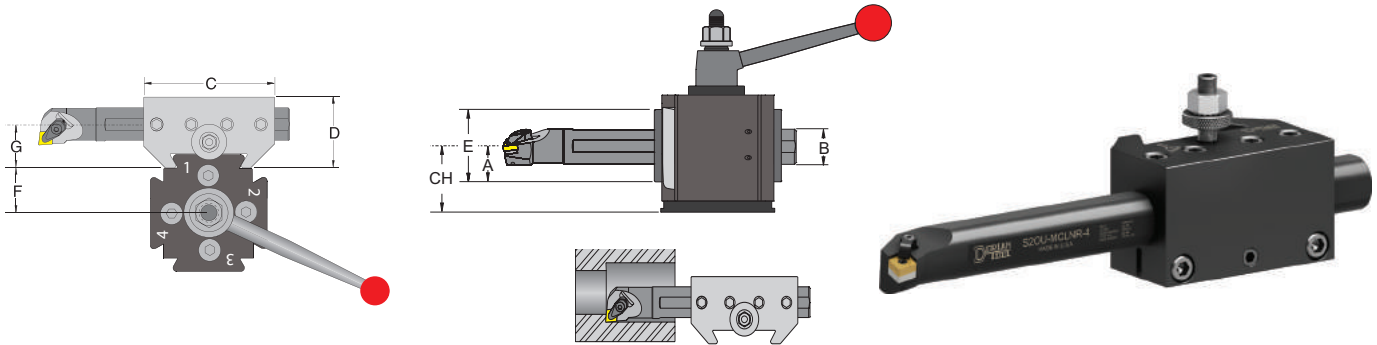

Description	UPC #	Boring Bar Capacity						
		A	B	C	D	E	F	G
QITP35N-41-1250-DUAL	00413	1.120	1.250	3.750	2.240	2.240	1.245	1.375
QITP40N-41-1500-DUAL	00563	1.370	1.500	4.500	2.740	2.740	1.530	1.625
QITP50N-41-2000-DUAL	00713	1.745	2.000	5.500	3.490	3.490	1.900	2.250
QITP60N-41-2500-DUAL	00863	2.245	2.500	6.500	4.490	4.490	2.207	2.750

No. DQ-41S-DUAL Super Over Sized Boring Bar Tool holder

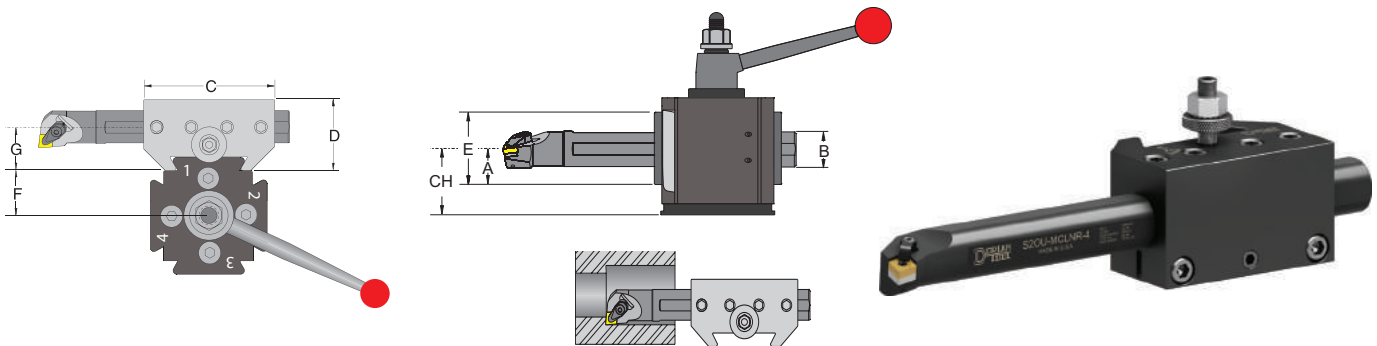

Description	UPC #	Boring Bar Capacity						
		A	B	C	D	E	F	G
DQ35CX-41S-1500-DUAL	00415	1.245	1.500	4.000	2.490	2.490	1.245	1.500
DQ40CA-41S-2000-DUAL	00565	1.495	2.000	4.500	2.990	2.990	1.530	1.750
DQ50DA-41S-2500-DUAL	00715	1.995	2.500	6.500	3.990	3.990	1.900	2.250
DQ60EA-41S-3000-DUAL	00865	2.245	3.000	7.000	4.490	4.490	2.207	2.625

No. QITPN-5 Morse Taper Tool holder

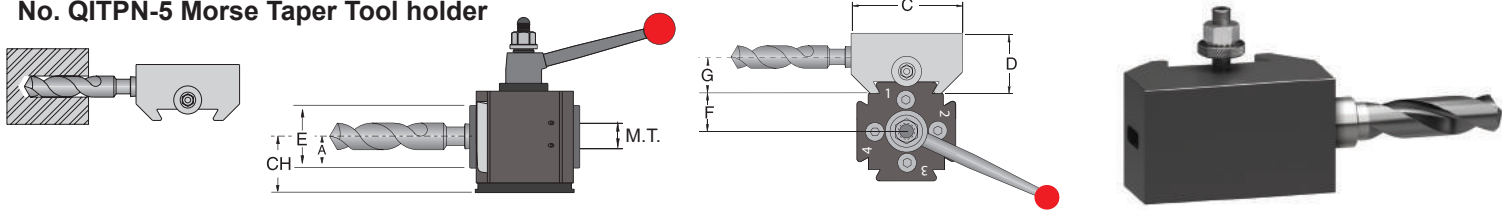

Description	UPC #	A	Morse Taper	C	D	E	F	G
QITP35N-5-4	00424	1.250	MT4	4.150	2.500	2.500	1.245	1.615
QITP40N-5-4	00572	1.250	MT4	4.500	2.500	2.500	1.530	1.615
QITP50N-5-5	00722	1.750	MT5	5.625	3.500	3.500	1.900	2.310
QITP60N-5-5	00872	1.750	MT5	5.625	3.500	3.500	2.207	2.310

No. QITPN-881 O.D. and I.D. Threading Toolholder

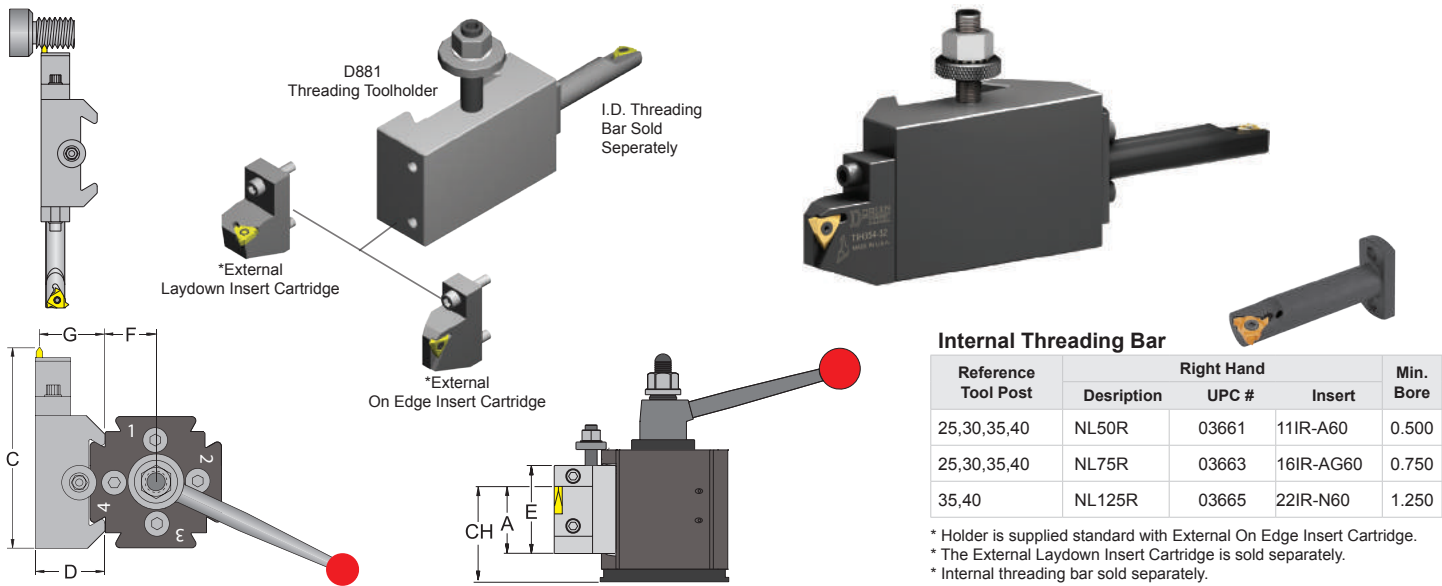

Internal Threading Bar

Reference Tool Post	Right Hand			Min. Bore
	Description	UPC #	Insert	
25,30,35,40	NL50R	03661	11IR-A60	0.500
25,30,35,40	NL75R	03663	16IR-AG60	0.750
35,40	NL125R	03665	22IR-N60	1.250

* Holder is supplied standard with External On Edge Insert Cartridge.
 * The External Laydown Insert Cartridge is sold separately.
 * Internal threading bar sold separately.
 * Inserts not included.

Description	UPC #	A	C	D	E	F	G	*External On Edge Insert Cartridge				*External Laydown Insert Cartridge						
								Description	UPC #	TNMC Insert	Torx Screw	Torx Key	Description	UPC #	Insert	Torx Screw	Torx Key	
QITP25N-881-OE	00132	0.875	4.130	1.250	1.750	0.880	1.000											
QITP30N-881-OE	00282	1.000	4.630	1.500	2.000	1.115	1.250	TIH253-32	03621	32	GTS-1M	T-10	NL253-3R	03635	16ER-AG60	TS-16	T-10	
QITP35N-881-OE	00434	1.250	5.630	1.750	2.500	1.245	1.435											
QITP40N-881-OE	00582	1.500	6.130	1.750	2.500	1.530	1.435	TIH354-32	03623	32	GTS-1M	T-10	NL354-3R	03637	16ER-AG60	TS-16	T-10	

No. QITPN-36 5C Collet Tool holder

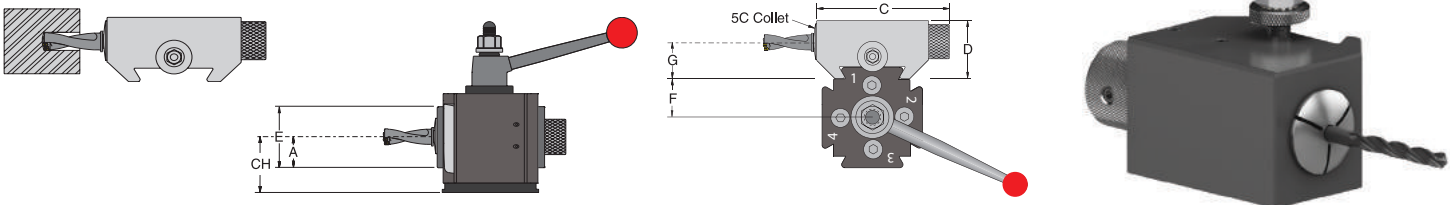

Description	UPC #	A	C	D	E	F	G
QITP25N-36	00142	1.125	4.250	2.500	2.250	0.880	1.500
QITP30N-36	00292	1.125	4.250	2.500	2.250	1.115	1.500
QITP35N-36	00444	1.375	4.500	2.750	2.750	1.245	1.625
QITP40N-36	00592	1.375	5.000	2.750	2.750	1.530	1.625

Quadra® Indexing Quick Change Tool Post Turning Set

Turning Set Includes

- (1) Tool Post
- (4) Holders

Tooling Not Included

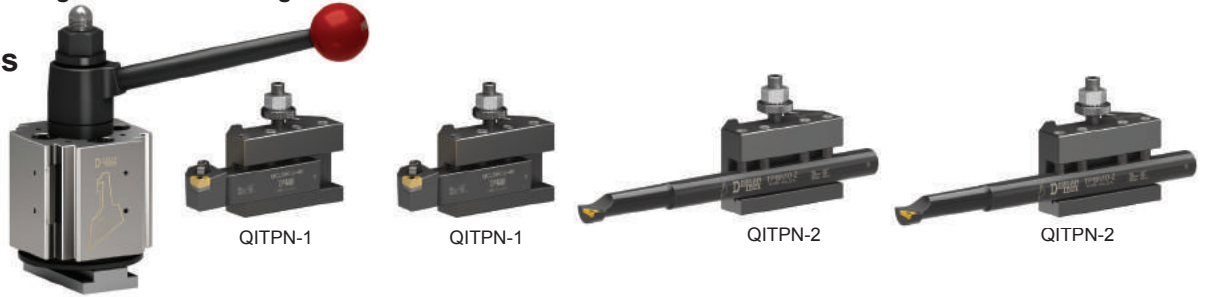

UPC #	00014	00015	00016	00017	00018	00019
Description	QITP25N-TS	QITP30N-TS	QITP35N-TS	QITP40N-TS	QITP50N-TS	QITP60N-TS
Set Includes						
(1) Tool Post	QITP25N	QITP30N	QITP35N	QITP40N	QITP50N	QITP60N
(4) Holders	(2) QITP25N-1 (2) QITP25N-2	(2) QITP30N-1 (2) QITP30N-2	(2) QITP35N-1 (2) QITP35N-2	(2) QITP40N-1 (2) QITP40N-2	(2) QITP50N-1 (2) QITP50N-2	(2) QITP60N-1 (2) QITP60N-2

Standard Set Includes

- (1) Tool Post
- (4) Holders

Tooling Not Included



UPC #	00020	00021	00022	00023	00024	00025
Description	QITP25N-INSS	QITP30N-INSS	QITP35N-INSS	QITP40N-INSS	QITP50N-INSS	QITP60N-INSS
Set Includes						
(1) Tool Post	QITP25N	QITP30N	QITP35N	QITP40N	QITP50N	QITP60N
(4) Holders	(1) QITP25N-1 (1) QITP25N-2 (1) QITP25N-4-CNC (1) QITP25N-7-71C	(1) QITP30N-1 (1) QITP30N-2 (1) QITP30N-4-CNC (1) QITP30N-7-71C	(1) QITP35N-1 (1) QITP35N-2 (1) QITP35N-4-CNC (1) QITP35N-7-71C	(1) QITP40N-1 (1) QITP40N-2 (1) QITP40N-4-CNC (1) QITP40N-7-71C	(1) QITP50N-1 (1) QITP50N-2 (1) QITP50N-4-CNC (1) QITP50N-7-71C	(1) QITP60N-1 (1) QITP60N-2 (1) QITP60N-4-CNC (1) QITP60N-7-71C

Quadra® First Time Buyer SET Includes FREE TOOLING

Set Includes:

- (1) Tool Post
- (4) Holders
- (4) Toolholders **FREE**
- (5) Inserts **FREE**



UPC #	00056	00058	00060	00062
Description	QITP25N-FTB	QITP30N-FTB	QITP35N-FTB	QITP40N-FTB
Set Includes				
(1) Tool Post	QITP25N	QITP30N	QITP35N	QITP40N
(4) Holders	QITP25N-1 QITP25N-2 QITP25N-7-71C QITP25N-881-OE	QITP30N-1 QITP30N-2 QITP30N-7-71C QITP30N-881-OE	QITP35N-1 QITP35N-2 QITP35N-7-71C QITP35N-881-OE	QITP40N-1 QITP40N-2 QITP40N-7-71C QITP40N-881-OE
Free Tooling				
(4) Toolholders	STNCR08-2J STCMB06-2 SGIH19-2 NL50R	STNCR10-2A STCMB08-2 SGIH19-2 NL50R	STNCR12-3B STCMB10-2 SGIH26-3 NL75R	STNCR64-3D STCMB12-3 SGIH26-3 NL75R
(5) Inserts	TCMT-21.51-PEM-DPC25UT TCMT-21.52-PEM-DPC25UT SGTN-2-DC656 TNMC-32NV-DVP656 11IR-A60-DVP656	TCMT-21.51-PEM-DPC25UT TCMT-21.52-PEM-DPC25UT SGTN-2-DC656 TNMC-32NV-DVP656 11IR-A60-DVP656	TCMT-21.51-PEM-DPC25UT TCMT-32.52-PEM-DPC25UT SGTN-3-DC656 TNMC-32NV-DVP656 16IR-A60-DVP656	TCMT-32.51-PEM-DPC25UT TCMT-32.52-PEM-DPC25UT SGTN-3-DC656 TNMC-32NV-DVP656 16IR-A60-DVP656



MODULAR CNC ADJUSTABLE ANGLE HEADS

Advanced design & State
of the Art Technology!

Choose from two styles (Universal and 90°)
and six models for any milling, drilling, tapping
and face milling operations.

PLCNC-AAH-ER25 - Pivoting Modular CNC Angle Head

- 4000 rpm max.
- ER25 Collet System
- 11 lb.ft. torque
- 1 to 1 Driving Ratio
- 5/8" max tool shank size
- 14.5 lb weight
- Automatic tool change capability
- Capable of machining in two axial positioning angles
- Designed to perform any CNC medium duty operations
- Interchangeable spindle taper holder for CAT, ISO & BT Spindles

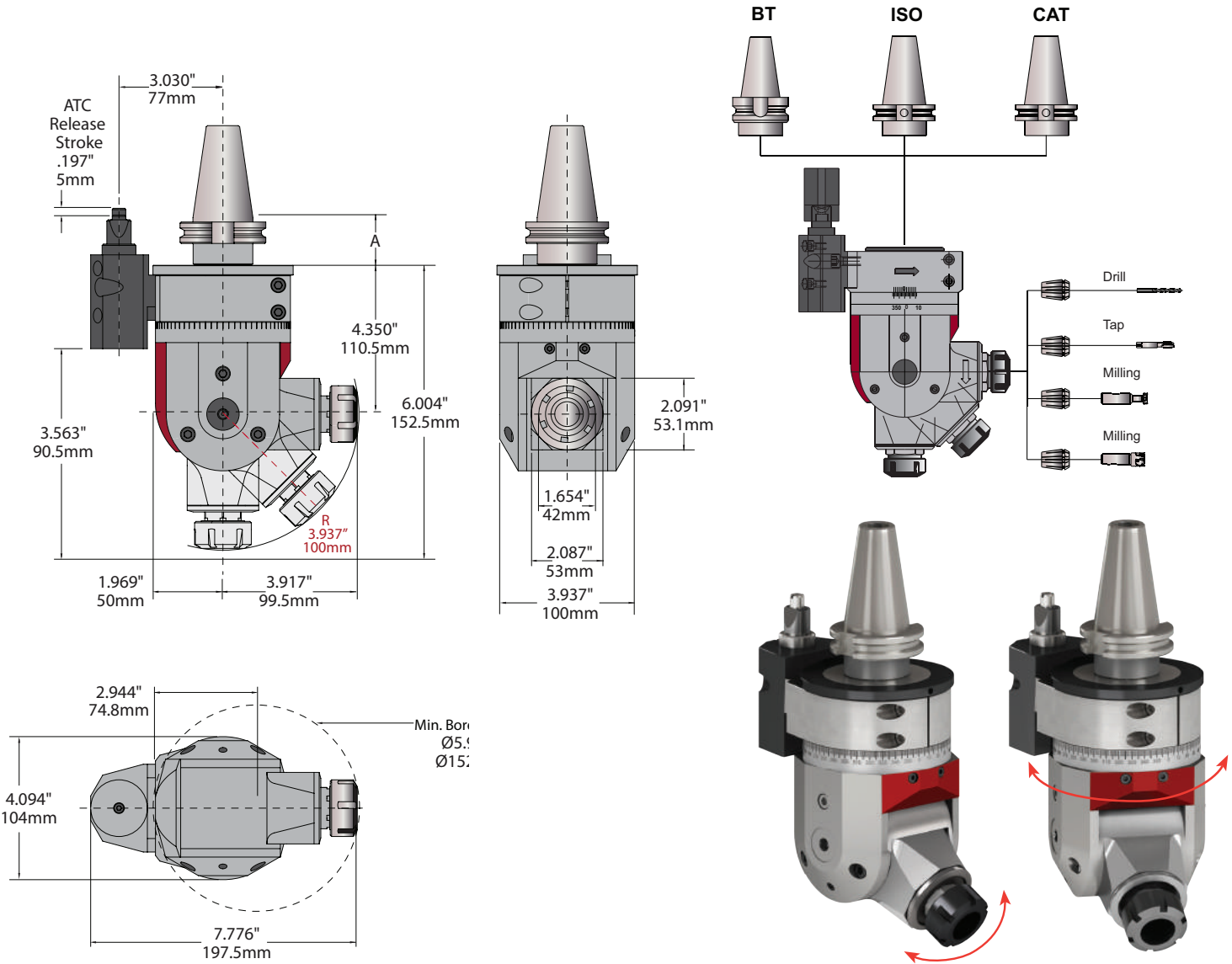

Shank Style	Description	UPC #	Torque		Driving Ratio	Max RPM	A Gage Line	Collet Size	Max. Tool Cap. Dia.	Max. Tap Size	*Max Slotting Cutter I.D.	**Weight
			Nm	lb.ft.								
ISO40-DIN69871	PLCNC-AAH-ER25-40DIN69871	45951	15	11	1 To 1	4000	0.520	ER25	0.625	0.625	1.250	14.3
BT40	PLCNC-AAH-ER25-BT40	45952					1.378					
CAT40	PLCNC-AAH-ER25-CAT40	45953					1.457					
ISO50-DIN69871	PLCNC-AAH-ER25-50DIN69871	45955					0.724					
BT50	PLCNC-AAH-ER25-BT50	45956					1.457					
CAT50	PLCNC-AAH-ER25-CAT50	45957					2.047					

** The weights of the angle heads do not include spindle taper holders.

PLCNC-AAH-ER32 - Pivoting Modular CNC Angle Head

- 3500 RPM max.
- ER32 Collet System
- 30 lb.ft. torque
- 1 to 1 Driving Ratio
- 3/4" max tool shank size
- 46 lb weight
- Automatic tool change capability
- Designed to perform any CNC heavy duty operations
- Capable of machining in two axial positioning angles
- Interchangeable spindle taper holder for CAT, ISO & BT Spindles

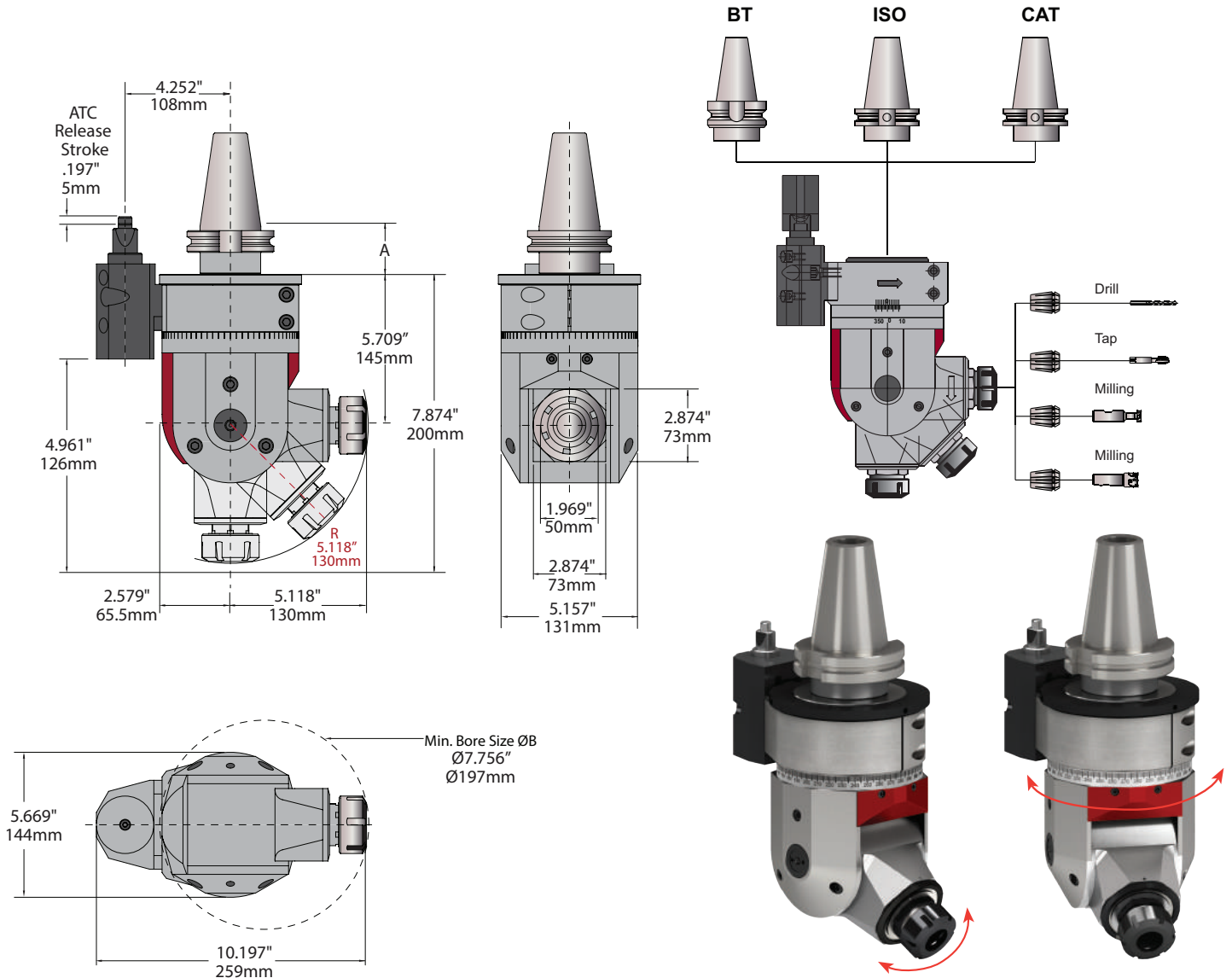

Shank Style	Description	UPC #	Torque Nm	lb.ft	Driving Ratio	Max RPM	A Gage Line	Collet Size	Max. Tool Cap. Dia.	Max. Tap Size	*Max Slotting Cutter I.D.	**Weight
ISO40-DIN69871	PLCNC-AAH-ER32-40DIN69871	45941	40	29.5	1 to 1	3500	0.520	ER32	0.750	0.812	1.500	46.2
BT40	PLCNC-AAH-ER32-BT40	45942					1.378					
CAT40	PLCNC-AAH-ER32-CAT40	45943					1.457					
ISO50-DIN69871	PLCNC-AAH-ER32-50DIN69871	45961					1.378					
BT50	PLCNC-AAH-ER32-BT50	45962					1.457					
CAT50	PLCNC-AAH-ER32-CAT50	45963					2.047					

** The weights of the angle heads do not include spindle taper holders.

90CNC-AAH-ER16- 90° Modular CNC Angle Head

- 4000 RPM max.
- ER16 Collet System
- 5 lb.ft. torque
- 1 to 1 Driving Ratio
- 3/8" max tool shank size
- 14.5 lb weight
- Automatic tool change capability
- Fixed 90° angle head with 0- 360° circular rotation
- Designed for precision machining for small to medium tool applications
- Interchangeable spindle taper holder for CAT, ISO & BT Spindles

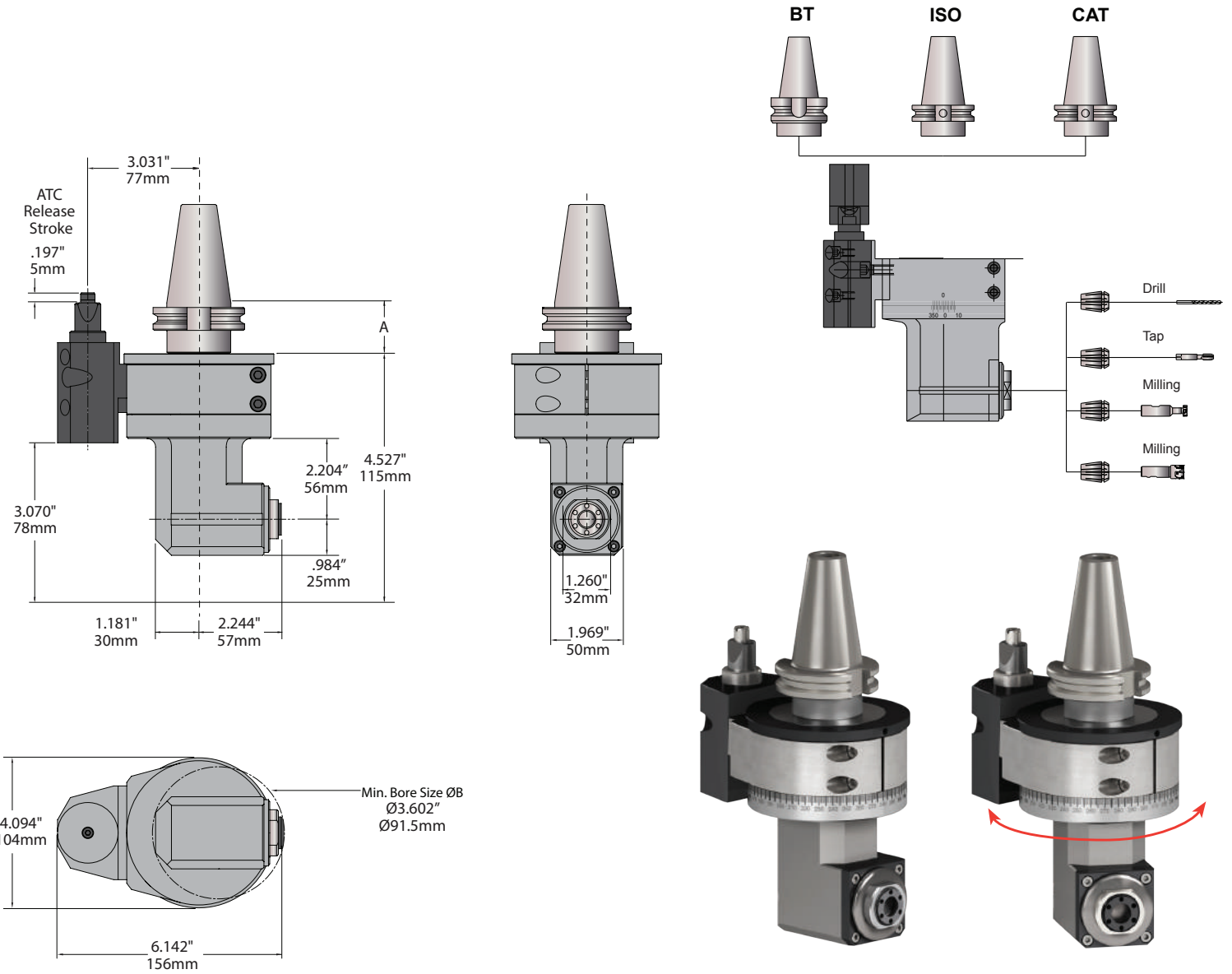

Shank Style	Description	UPC #	Torque Nm	Torque lb.ft	Driving Ratio	Max RPM	A Gage Line	Collet Size	Tool Cap. Dia.	Max. Tap Size	*Max Slotting Cutter I.D.	** Weight
ISO40-DIN69871	90CNC-AAH-ER16-40DIN69871	45966	6.5	4.8	1 to 1	4000	0.520	ER16	0.375	0.312	-	14.3
BT40	90CNC-AAH-ER16-BT40	45967					1.378					
CAT40	90CNC-AAH-ER16-CAT40	45968					1.457					
ISO50-DIN69871	90CNC-AAH-ER16-50DIN69871	45970					1.378					
BT50	90CNC-AAH-ER16-BT50	45971					1.457					
CAT50	90CNC-AAH-ER16-CAT50	45972					2.047					

** The weights of the angle heads do not include spindle taper holders.

90CNC-AAH-ER25 - 90° Modular CNC Angle Head

- 3500 RPM max.
- ER25 Collet System
- 15 lb.ft. torque
- 1 to 1 Driving Ratio
- 5/8" max tool shank size
- 14.5 lb weight
- Automatic tool change capability
- Designed to perform any CNC medium duty operations
- Fixed 90° angle head with 0-360° circular rotation
- Interchangeable spindle taper holder for CAT, ISO & BT Spindles

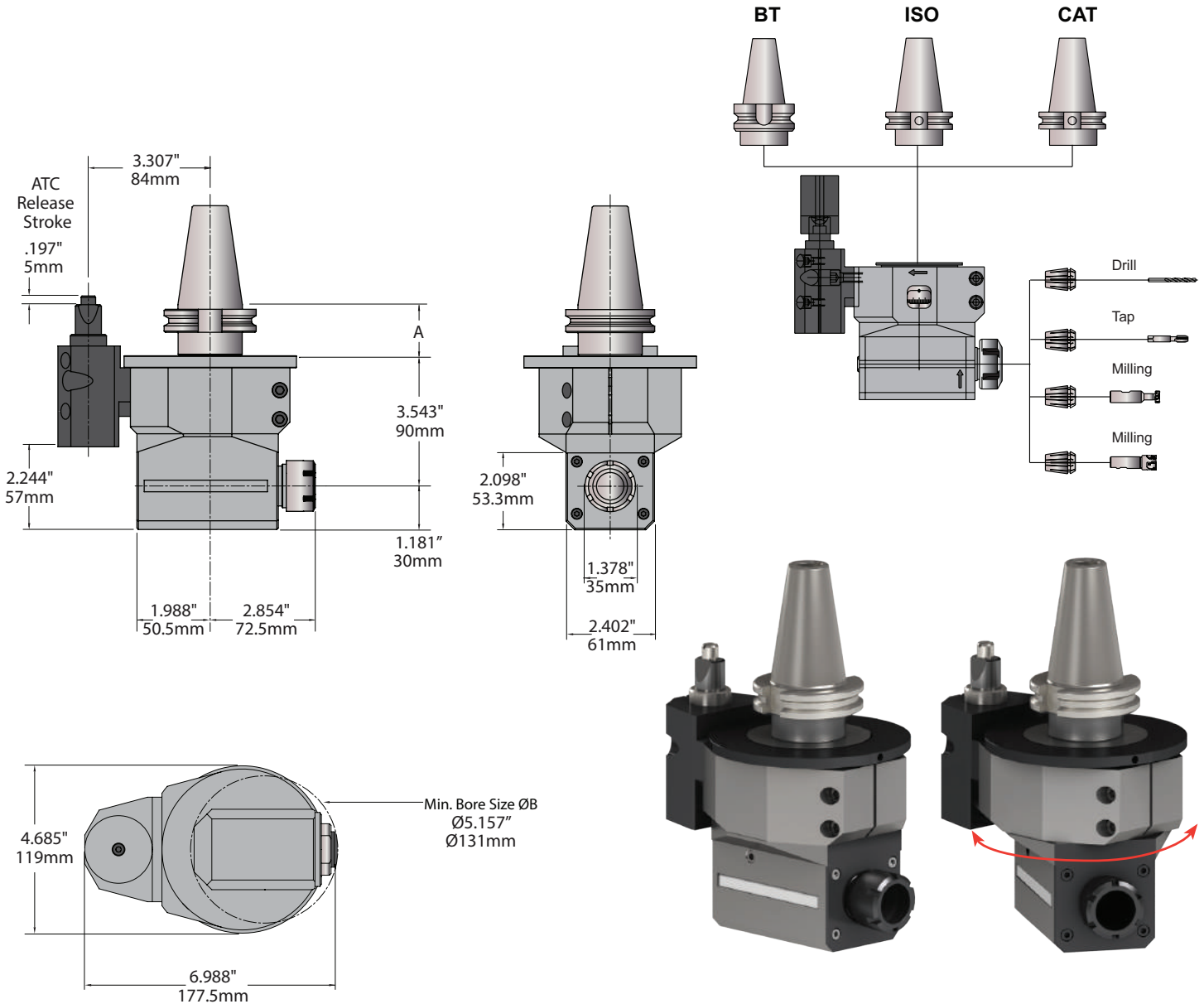

Shank Style	Description	UPC #	Torque Nm	Torque lb.ft	Driving Ratio	Max RPM	A Gage Line	Collet Size	Tool Cap. Dia.	Max. Tap Size	*Max Slotting Cutter I.D.	** Weight
ISO40-DIN69871	90CNC-AAH-ER25-40DIN69871	45975	20	14.7	1 to 1	3500	0.520	ER25	0.625	0.625	1.250	14.3
BT40	90CNC-AAH-ER25-BT40	45976					1.378					
CAT40	90CNC-AAH-ER25-CAT40	45977					1.457					
ISO50-DIN69871	90CNC-AAH-ER25-50DIN69871	45979					1.378					
BT50	90CNC-AAH-ER25-BT50	45980					1.457					
CAT50	90CNC-AAH-ER25-CAT50	45981					2.047					

** The weights of the angle heads do not include spindle taper holders.

90CNC-AAH-ER32 - 90° Modular CNC Angle Head

- 3500 RPM max.
- ER32 Collet System
- 30 lb.ft. torque
- 1 to 1 Driving Ratio
- 3/4" max tool shank size
- 44 lb weight
- Automatic tool change capability
- Designed for any fixed 90° heavy duty operations
- Fixed 90° angle head with 0-360° circular rotation
- Interchangeable spindle taper holder for CAT, ISO & BT Spindles

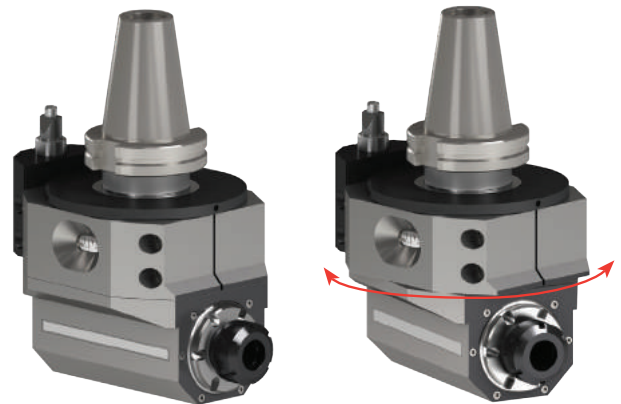
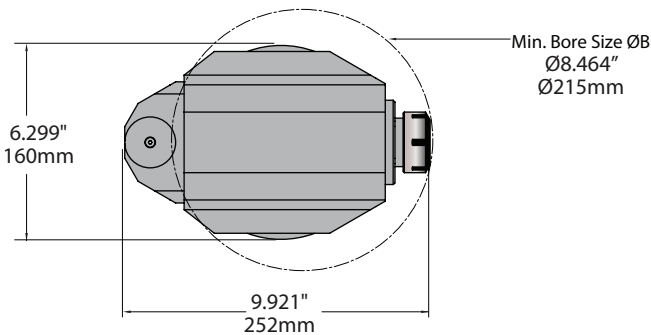
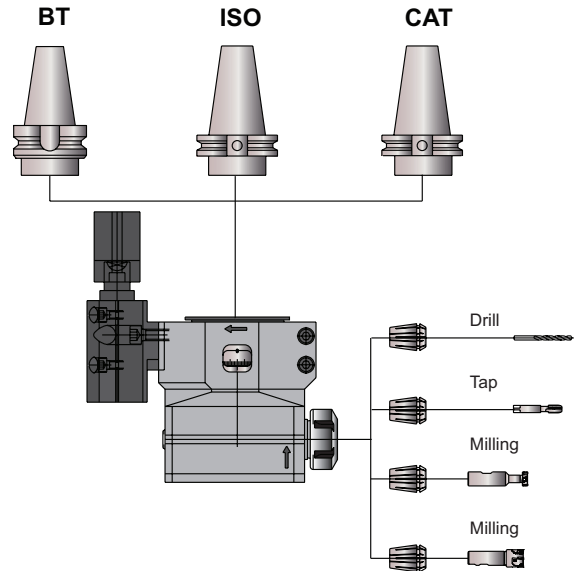
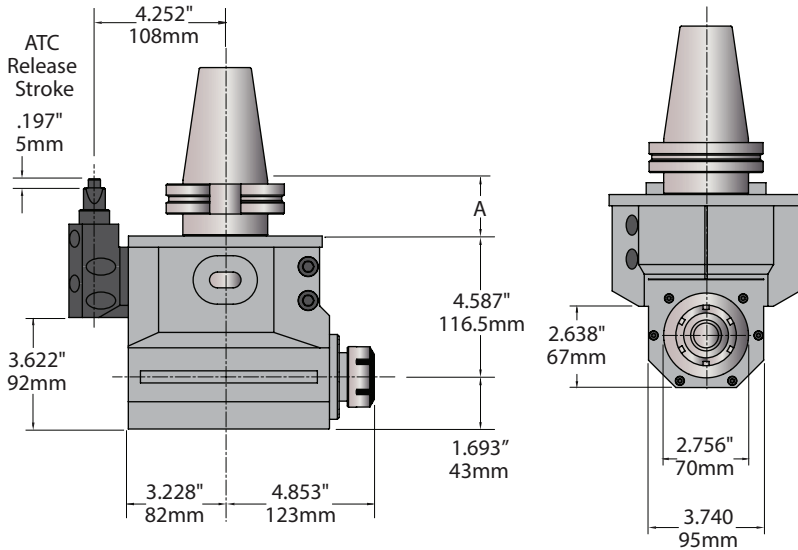

Shank Style	Description	UPC #	Torque		Driving Ratio	Max RPM	A Gage Line	Collet Size	Tool Cap. Dia.	Max. Tap Size	*Max Slotting Cutter I.D.	** Weight
			Nm	lb.ft.								
ISO40-DIN69871	90CNC-AAH-ER32-40DIN69871	45984	60	44	1 to 1	3500	0.520	ER32	0.750	0.812	1.500	44
BT40	90CNC-AAH-ER32-BT40	45985					1.378					
CAT40	90CNC-AAH-ER32-CAT40	45986					1.457					
ISO50-DIN69871	90CNC-AAH-ER32-50DIN69871	45988					1.378					
BT50	90CNC-AAH-ER32-BT50	45989					1.457					
CAT50	90CNC-AAH-ER32-CAT50	45990					2.047					

** The weights of the angle heads do not include spindle taper holders.

90CNC-AAH-TP40 - 90° Modular CNC Angle Head

- 2000 RPM max.
- 30 lb.ft. torque
- 1 to 1 Driving Ratio
- 3/4" max tool shank size
- 44 lb weight
- Automatic tool change capability
- Engineered to accept any CAT, ISO, or BT-40 taper holder
- Designed to perform any CNC heavy duty operations
- Fixed 90° angle head with 0-360° circular rotation
- Interchangeable spindle taper holder for CAT, ISO & BT Spindles

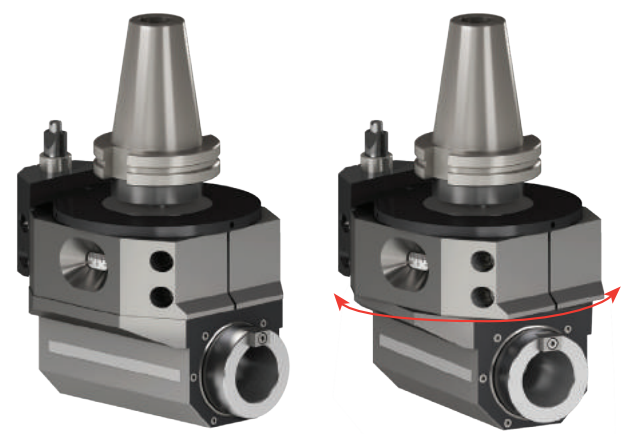
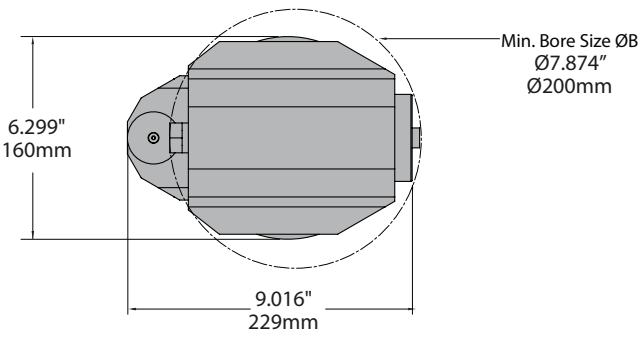
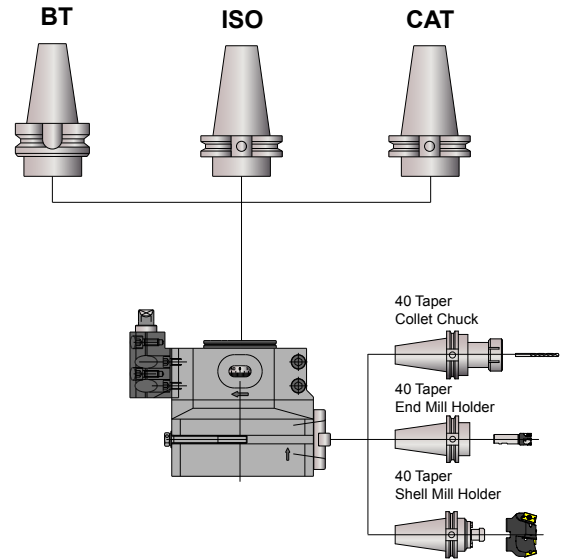
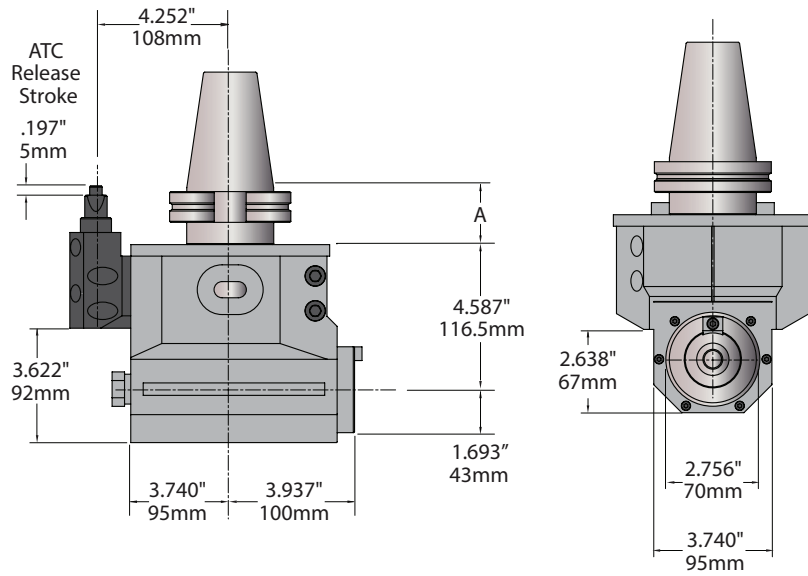

Shank Style	Description	UPC #	Torque		Driving Ratio	Max RPM	A Gage Line	Output	* Weight	
			Nm	lb.ft					Kg	Lb
ISO40-DIN69871	90CNC-AAH-TP40-40DIN69871	45934	40	29.5	1 to 1	2000	0.520	ISO40 CAT40 BT40	20	44
BT40	90CNC-AAH-TP40-BT40	45935					1.378			
CAT40	90CNC-AAH-TP40-CAT40	45936					1.457			
ISO50-DIN69871	90CNC-AAH-TP40-50DIN69871	45994					1.378			
BT50	90CNC-AAH-TP40-BT50	45995					1.457			
CAT50	90CNC-AAH-TP40-CAT50	45996					2.047			

* The weights of the angle heads do not include spindle taper holders.

Spindle Taper Holders CAT-BT-ISO 40/50

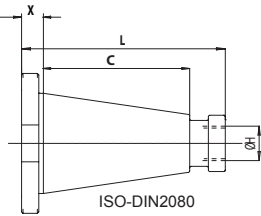

Style	ISO40-DIN2080	ISO50-DIN2080
Description	AHIS040-DIN2080	AHIS050-DIN2080
UPC #	46003	46004
C	2.512	3.882
H	M16	M24
L	4.134	5.591
X	.520	.724

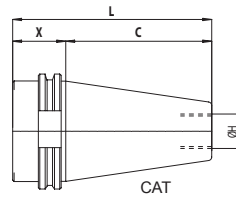

Style	CAT40	CAT50
Description	AHCAT40	AHCAT50
UPC #	46001	46002
C	2.693	4.006
H	5/8-11	1-8
L	4.071	5.463
X	1.378	1.457

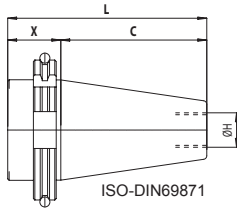

Style	ISO40-DIN69871	ISO50-DIN69871
Description	AHIS040-DIN69871	AHIS050-DIN69871
UPC #	46012	46021
C	2.693	4.006
H	M16	M24
L	4.071	5.463
X	1.378	1.457

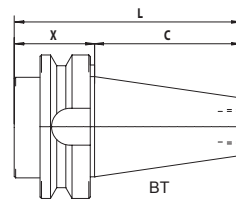

Style	BT40	BT50
Description	AHBT40	AHBT50
UPC #	46005	46006
C	2.575	4.008
H	M16	M24
L	4.032	6.055
X	1.457	2.047

ER 25 & ER 32 Wrench

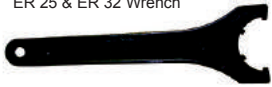

ER16 Wrench



ER 25 & ER 32 Collet Nut



ER16 Collet Nut



ER Standard Collet Nut Wrench

Style	Description	UPC #	Type
ER16	ER16STWR-AAH	45998	ER Standard Wrench
ER 25	ER25STWR	49996	ER Standard Wrench
ER 32	ER32STWR	49997	ER Standard Wrench

ER Standard Collet Nuts (Dimensions are in mm)

Style	Description	UPC #	Body Dia.	Length	Thread
ER 16	ER16NTS24-080	49771	24	8	M24X1.0
ER 25	ER25NTS32-200	49782	42	20	M32x1.5
ER 32	ER32NTS50-225	49783	50	22,5	M40x1.5

R8 Right Angle Milling Attachment for Vertical Milling Machines

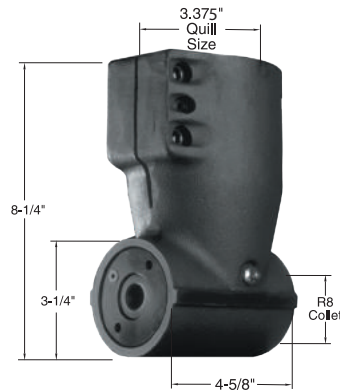
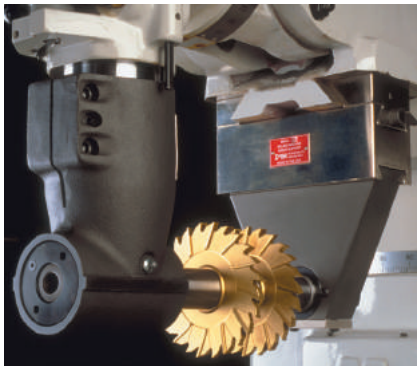

Features

- For Manual Machines
- Ductile Iron Body
- Precision Hardened & Ground Spiral Bevel Gears
- Sealed High Speed Bearings
- 1.33 to 1 Gear Ratio
- Grease Fitting
- Alignment Flats on 2 Sides
- R-8 Collet Spindle

Output	Shank	Description	UPC #
R8	3 3/8" Quill with R8 Taper	MMRAA-R8	04000

Draw Bar



Standard Draw Bars

Machine Type	Bar Length	Hex Length	Description	UPC #
1 J Head Bridgeport Step Pully	18.000	2.500	SDB-1J	04080
2 J Head Bridgeport Variable Speed	18.000	5.500	SDB-2J	04082
Alliant-Sharp	18.000	6.500	SDB-AS	04084
Index Lagun	18.000	8.500	SDB-IL	04086

Special Draw Bars to be used with R8 Milling Attachment

Machine Type	Bar Length	Hex Length	Description	UPC #
Bridgeport Kondia	18.000	8.500	BDBRA-2J800	04090
Index Lagun	18.000	11.500	ILBRA-110	04092
Alliant-Sharp	18.000	9.500	ADBRA-190	04094

V-FLANGE TOOLING



QUALITY, SPEED &
PERFORMANCE

Precision Balanced to 12,000 RPM
Each holder comes with a Certificate of Inspection

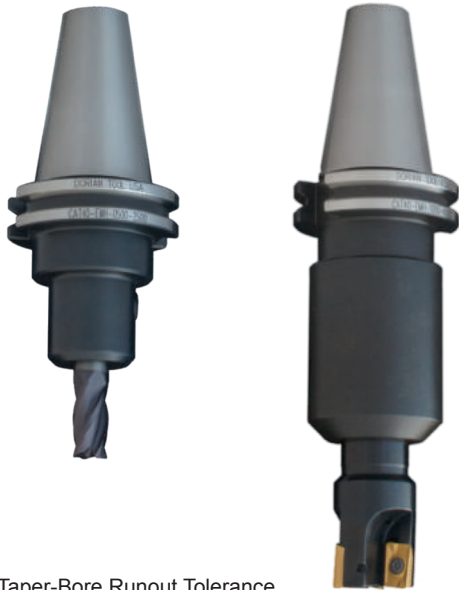

- .0001" Taper-Bore Runout Tolerance.
- Made of 8620 Alloy Steel with Case Hardness of 56-60 HRC and Core
- Tapers Ground to AT-3 Specifications or BETTER.
- H5 Bore Tolerance for air-tight fit provides maximum contact surface area.
- Thru Coolant Feature
- Made In Italy.

End Mill Holders

UPC #	Description	Hole Dia. (d) (in)	Gage Length (L) (in)	Body Dia. (D) (in)
45011	CAT40 EMH-0250-2500	1/4	2.50	0.88
45017	CAT40 EMH-0375-2500	3/8	2.50	1.00
45023	CAT40-EMH-0500-2500	1/2	2.50	1.25
45026	CAT40 EMH-0625-1750	5/8	1.75	1.75
45027	CAT40 EMH-0625-3000	5/8	3.00	1.50
45030	CAT40 EMH-0750-1750	3/4	1.75	1.75
45031	CAT40 EMH-0750-3000	3/4	3.00	1.75
45037	CAT40 EMH-1000-2000	1	2.00	1.75
45038	CAT40 EMH-1000-4000	1	4.00	2.00
45069	CAT50 EMH-0500-4000	1/2	4.00	1.25
45079	CAT50 EMH-0750-4000	3/4	4.00	1.75
45080	CAT50 EMH-0750-6000	3/4	6.00	1.75
45086	CAT50 EMH-1000-4000	1	4.00	2.00
45087	CAT50 EMH-1000-6000	1	6.00	2.00
45090	CAT50 EMH-1250-4000	1-1/4	4.00	2.50
45091	CAT50 EMH-1250-6000	1-1/4	6.00	2.50
45094	CAT50 EMH-1500-4500	1-1/2	4.50	2.75
45095	CAT50 EMH-1500-7000	1-1/2	7.00	2.75

Precision Balanced to 12,000 RPM
Each holder comes with a Certificate of Inspection

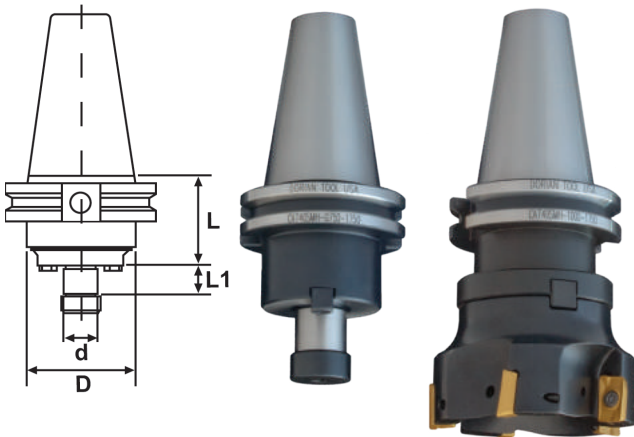

Shell Mill Holders

UPC #	Description	Arbor Dia (d) (in)	Arbor Length (L1) (in)	Gage Length (L) (in)	Body Dia (D) (in)	Arbor Thread (AT) (in)	Key Size (in)
45121	CAT40 SMH-0750-1750	3/4	0.67	1.75	1.75	3/8-24	5/16
45123	CAT40 SMH-1000-1750	1	0.67	1.75	2.25	1/2-20	3/8
45125	CAT40 SMH-1250-2000	1-1/4	0.67	2.00	2.88	5/8-18	1/2
45127	CAT40 SMH-1500-2000	1-1/2	0.93	2.00	3.75	3/4-16	5/8
45138	CAT50 SMH-0750-1750	3/4	0.68	1.75	2.75	3/8-24	5/16
45142	CAT50 SMH-1000-1750	1	0.68	1.75	2.75	1/2-20	3/8
45146	CAT50 SMH-1250-1750	1-1/4	0.68	1.75	2.75	5/8-18	1/2
45150	CAT50 SMH-1500-2000	1-1/2	0.94	2.00	3.75	3/4-16	5/8
45154	CAT50 SMH-2000-2000	2	0.94	2.00	4.88	1-14	5/8

- .0002" Taper-Arbor Runout Tolerance.
- Made of 8620 Alloy Steel with Case Hardness of 56-60 HRC and Core Hardness of 36-40 HRC.
- Tapers Ground to AT-3 Specifications or BETTER.
- H5 Arbor Tolerance.
- Made In Italy.

Precision Balanced to 12,000 RPM
 Each holder comes with a Certificate of Inspection

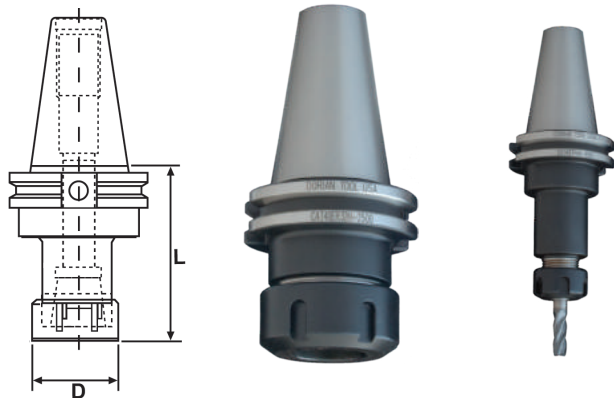

- .0001" Taper-Bore Runout Tolerance.
- Made of 8620 Alloy Steel with Case Hardness of 56-60 HRC and Core Hardness of 36-40 HRC.
- Tapers Ground to AT-3 Specifications or BETTER
- Thru Coolant Feature.
- Made In Italy.

ER Collet Holder

UPC #	Description	Collet Series	Collet Range (in)	Nose Dia. (D) (in)	Gage Length (L) (in)
45173	CAT40 ER11H-2500	ER11	.019-.275	0.63	2.50
45174	CAT40 ER11H-4000	ER11	.019-.275	0.63	4.00
45175	CAT40 ER11H-6000	ER11	.019-.275	0.63	6.00
45176	CAT40 ER16H-2500	ER16	.019-.406	1.26	2.50
45178	CAT40 ER16H-4000	ER16	.019-.406	1.26	4.00
45179	CAT40 ER16H-6000	ER16	.019-.406	1.26	6.00
45180	CAT40 ER20H-2500	ER20	.039-.511	1.38	2.50
45181	CAT40 ER20H-4000	ER20	.039-.511	1.38	4.00
45182	CAT40 ER20H-6000	ER20	.039-.511	1.38	6.00
45183	CAT40 ER25H-2500	ER25	.039-.629	1.65	2.50
45184	CAT40 ER25H-4000	ER25	.039-.629	1.65	4.00
45185	CAT40 ER25H-6000	ER25	.039-.629	1.65	6.00
45186	CAT40 ER32H-2500	ER32	.078-.787	1.97	2.50
45188	CAT40 ER32H-4000	ER32	.078-.787	1.97	4.00
45189	CAT40 ER32H-6000	ER32	.078-.787	1.97	6.00
45191	CAT40 ER40H-2500	ER40	.118-1.023	2.48	2.50
45193	CAT40 ER40H-4000	ER40	.118-1.023	2.48	4.00
45197	CAT50 ER16H-4120	ER16	.019" - .406"	1.26	4.12
45205	CAT50 ER25H-4000	ER25	.039" - .629"	1.65	4.00
45206	CAT50 ER25H-6000	ER25	.039" - .629"	1.65	6.00
45208	CAT50 ER32H-4000	ER32	.078" - .787"	1.97	4.00
45209	CAT50 ER32H-6000	ER32	.078" - .787"	1.97	6.00
45210	CAT50 ER32H-8000	ER32	.078" - .787"	1.97	8.00

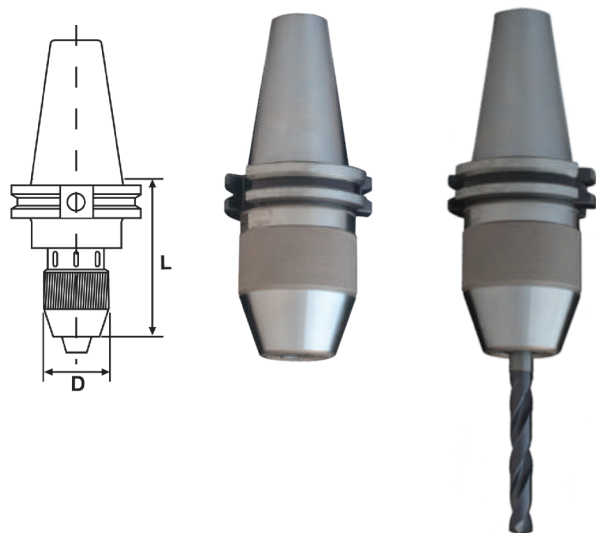

- Provides exceptionally high torque - up to three times the gripping strength of conventional drill chucks.
- Features a corrosion-resistant surface treatment to ensure durability.
- Chuck will not come off during operation.
- Replaceable chuck.

Integral Keyless Drill Chuck Holders

UPC #	Description	Capacity	Gage Length (L) (in)	Body Dia. (D) (in)
45307	CAT40-KDCH-13	1/32-1/2	3.50	2.00
45308	CAT40-KDCH-16	1/8-5/8	4.50	2.25

Spare Parts

ER Standard Nuts



Style	Description	UPC #	Thread	Height (mm)	Body Dia. (mm)
ER11	ER11NTM16	49773	M13 X .075	12	16
ER16	ER16NTS32	49780	M22 X 1,5	17	32
ER20	ER20NTS35	49781	M25 X 1,5	19	35
ER25	ER25NTS42	49782	M32 X 1,5	20	42
ER32	ER32NTS50	49783	M40 X 1,5	22,5	50
ER40	ER40NTS63	49784	M50 X 1,5	25,5	63

ER Standard Wrench



Style	Description	UPC #	Wrench Type
ER11	ER11MNWR	49987	ER Mini
ER16	ER16STWR	49994	ER Standard
ER20	ER20STWR	49995	ER Standard
ER25	ER25STWR	49996	ER Standard
ER32	ER32STWR	49997	ER Standard
ER40	ER40STWR	49998	ER Standard

RETENTION KNOBS

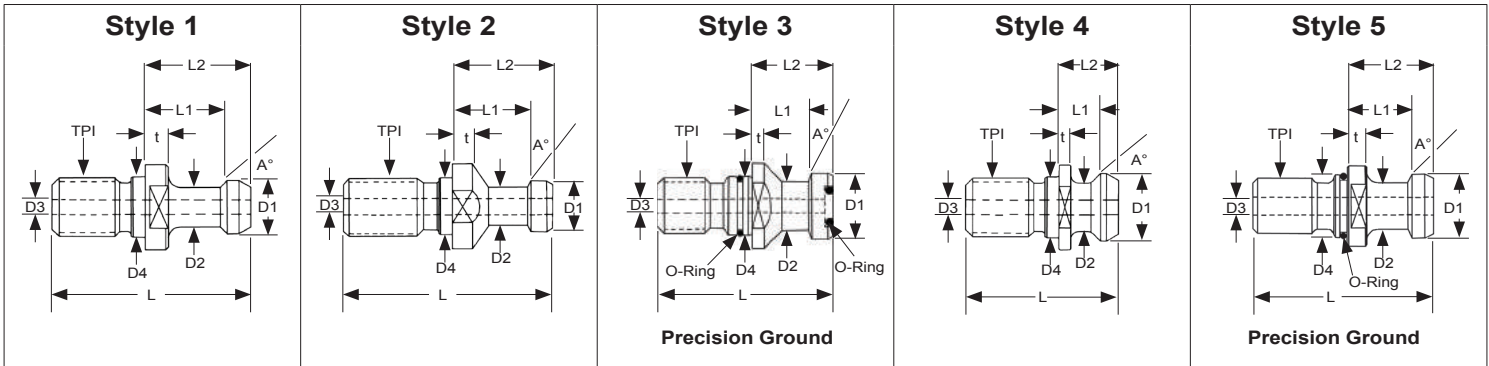

UPC #	CAT 40 Description	Machine Used on	Thru Coolant	Style	Threads TPI	A Angle	D1 Knob Dia.	D2 Neck Dia.	D3 Hole Dia.	D4 Pilot Dia.	Shoulder			
											L OAL	L1	t	L2
47287	RKCT40-4-0004	MAZAK, FADAL, DMG, HURCO	NA	4	5/8-11	45°	0.740	0.490	NA	0.636	1.620	0.440	0.120	0.640
47286	RKCT40-4-0003-C	FADAL, DMG, HURCO	Coolant	4	5/8-11	45°	0.740	0.490	0.281	0.636	1.620	0.440	0.120	0.640
47831	RKCT40-1-0103	MORI SEIKI, OKK, KIRA	NA	1	5/8-11	90°	0.589	0.392	NA	0.636	2.250	0.988	0.234	1.264
47305	RKCT40-1-0022	BRIDGEPORT, LEADWELL	NA	1	5/8-11	45°	0.589	0.392	NA	0.636	2.250	0.988	0.124	1.264
47304	RKCT40-1-0021	HAAS, CHEVALIER, FEELER, FRYER, JOHNFORD	NA	1	5/8-11	45°	0.589	0.392	NA	0.636	2.250	0.988	0.234	1.264
47313	RKCT40-1-0030-C	HAAS, CHEVALIER, FEELER, FRYER, JOHNFORD	Coolant	1	5/8-11	45°	0.589	0.392	0.200	0.636	2.250	0.988	0.234	1.264
47386	RKCT40-1-0121	MAKINO, MITSUBISHI, ENSHU, HITACHI, KIRA, OKUMA, MILLTRONICS	NA	1	5/8-11	60°	0.589	0.392	NA	0.636	2.250	0.988	0.234	1.264
47288	RKCT40-4-0005-C	MAZAK, FADAL, DMG, HURCO	Coolant	4	5/8-11	45°	0.740	0.490	0.280	0.641	1.620	0.440	0.120	0.640
47359	RKCT40-5-0076-C	MAKINO	Coolant	5	5/8-11	15°	0.746	0.549	0.236	0.641	2.008	0.792	0.276	1.028
47387	RKCT40-3-0122-C	MORI SEIKI	Coolant	3	5/8-11	15°	0.747	0.548	0.236	0.641	2.004	0.787	0.157	1.024
47343	RKCT40-2-0060-C	KITAMURA, DOOSAN, HYUNDAI, KIA	Coolant	2	5/8-11	15°	0.747	0.549	0.281	0.641	2.004	0.787	0.157	1.024

UPC #	CAT 50 Description	Machine Used on	Thru Coolant	Style	Threads TPI	A Angle	D1 Knob Dia.	D2 Neck Dia.	D3 Hole Dia.	D4 Pilot Dia.	Shoulder			
											L OAL	L1	t	L2
47292	RKCT50-4-0010	MAZAK, DMG, G&L, HURCO, FADAL, WALTER GRINDERS	NA	4	1-8	45°	1.140	0.820	NA	1.026	2.575	0.700	0.200	1.000
47291	RKCT50-4-0009-C	MAZAK, DMG, G&L, HURCO, FADAL	Coolant	4	1-8	45°	1.140	0.820	0.468	1.026	2.575	0.700	0.200	1.000
47320	RKCT50-1-0037-C	OKK	Coolant	1	1-8	90°	0.903	0.668	0.250	1.026	3.350	1.384	0.392	1.778
47319	RKCT50-1-0036-C	OKUMA, HITACHI, SNK, TOSHIBA	Coolant	1	1-8	60°	0.903	0.668	0.335	1.026	3.355	1.384	0.392	1.778
47306	RKCT50-1-0023	OKUMA, HITACHI, SNK, TOSHIBA	NA	1	1-8	60°	0.903	0.668	NA	1.026	3.355	1.384	0.392	1.778
47308	RKCT50-1-0025-C	HAAS, MILLTRONICS, VIPER, ENSHU, AWEA	Coolant	1	1-8	45°	0.903	0.668	0.312	1.026	3.355	1.384	0.392	1.778
47309	RKCT50-1-0026	HAAS, MILLTRONICS, VIPER, ENSHU, AWEA	NA	1	1-8	45°	0.903	0.668	NA	1.026	3.355	1.384	0.392	1.778
47317	RKCT50-1-0034-C	DOOSAN, HYUNDAI, KIA	Coolant	1	1-8	45°	0.903	0.668	0.390	1.026	3.355	1.384	0.392	1.778
47388	RKCT50-1-0123-C	TOYODA	Coolant	1	1-8	45°	0.903	0.668	0.236	1.030	3.353	1.384	0.400	1.778
47389	RKCT50-1-0124	MORI SEIKI, OKK, YANG	NA	1	1-8	90°	0.903	0.668	NA	1.026	3.350	1.384	0.392	1.778
47318	RKCT50-1-0035-C	MAKINO	Coolant	1	1-8	45°	0.903	0.668	0.236	1.026	3.353	1.384	0.392	1.778

MILLING DRILLING REAMING TAPPING

100% Inspection: Each and every collet is inspected to be precise within .0002" or better prior to shipping.

Maximum Contact Surface Area: Each Dorian ER Collet features 16 full length slits (instead of competition's 8), enabling the collet to collapse uniformly to provide a concentric and full 360° gripping surface.

Material: Premium Grade Special Alloy Steel with high a modulus of elasticity. Combined with the 16-slit design, this material provides full surface contact on the tool when collapsed.

Inch and Metric Sizes: Choice of Inch and Metric sizes optimizes contact surface area for ultra high precision applications.



Ultra Precision 0.0002" TIR

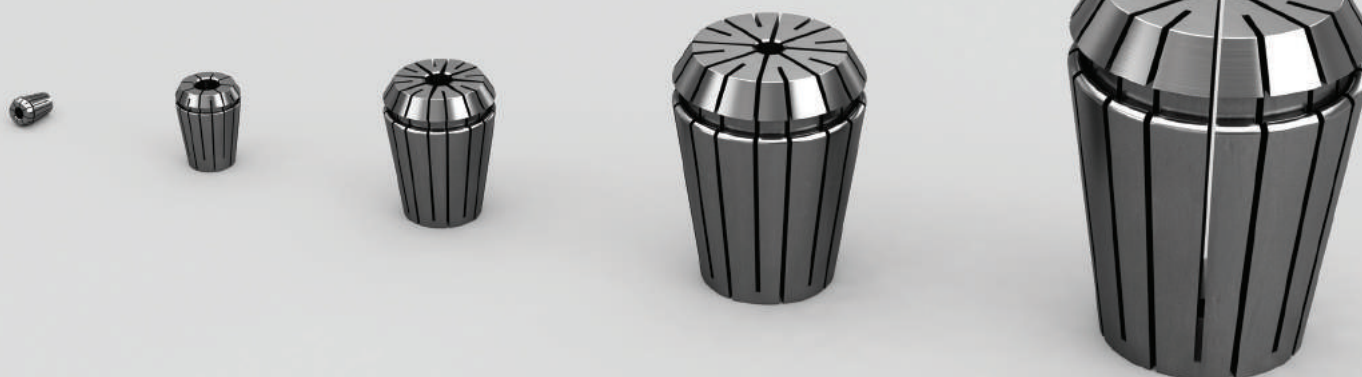

Ultra Precision ER 11 Collets

Description	UPC #	Holding Capacity	
ER11-STIMC-10	46236	0.020	0.039
ER11-STIMC-15	46237	0.039	0.059
ER11-STIMC-20	46238	0.059	0.079
ER11-STIMC-0937	46249	0.074	0.094
ER11-STIMC-25	46239	0.079	0.098
ER11-STIMC-30	46240	0.098	0.118
ER11-STIMC-0125	46250	0.105	0.125
ER11-STIMC-35	46241	0.118	0.138
ER11-STIMC-40	46242	0.138	0.157
ER11-STIMC-45	46243	0.157	0.177
ER11-STIMC-0187	46251	0.168	0.188
ER11-STIMC-50	46244	0.177	0.197
ER11-STIMC-55	46245	0.197	0.217
ER11-STIMC-60	46246	0.217	0.236
ER11-STIMC-0250	46252	0.230	0.250
ER11-STIMC-65	46247	0.236	0.256
ER11-STIMC-70	46248	0.256	0.276



Ultra Precision ER 16 Collets

Description	UPC #	Holding Capacity	
ER16-STIMC-10	46290	0.020	0.039
ER16-STIMC-15	46288	0.039	0.059
ER16-STIMC-20	46291	0.059	0.079
ER16-STIMC-0937	46275	0.074	0.094
ER16-STIMC-25	46289	0.079	0.098
ER16-STIMC-30	46292	0.079	0.118
ER16-STIMC-0125	46276	0.087	0.125
ER16-STIMC-40	46293	0.118	0.157
ER16-STIMC-0187	46278	0.150	0.188
ER16-STIMC-50	46294	0.157	0.197
ER16-STIMC-60	46295	0.197	0.236
ER16-STIMC-0250	46280	0.213	0.250
ER16-STIMC-70	46296	0.236	0.276
ER16-STIMC-80	46297	0.276	0.315
ER16-STIMC-90	46298	0.315	0.354
ER16-STIMC-0375	46284	0.335	0.375
ER16-STIMC-100	46299	0.354	0.394



Ultra Precision ER 20 Collets

Description	UPC #	Holding Capacity	
ER20-STIMC-10	46353	0.020	0.039
ER20-STIMC-15	46354	0.039	0.059
ER20-STIMC-20	46355	0.059	0.079
ER20-STIMC-30	46356	0.079	0.118
ER20-STIMC-0937	46386	0.075	0.094
ER20-STIMC-0125	46387	0.087	0.125
ER20-STIMC-40	46358	0.118	0.157
ER20-STIMC-0187	46388	0.150	0.188
ER20-STIMC-50	46359	0.157	0.197
ER20-STIMC-60	46360	0.197	0.236
ER20-STIMC-0250	46389	0.213	0.250
ER20-STIMC-70	46361	0.236	0.276
ER20-STIMC-80	46362	0.276	0.315
ER20-STIMC-90	46363	0.315	0.354
ER20-STIMC-375	46390	0.335	0.375
ER20-STIMC-100	46364	0.354	0.394
ER20-STIMC-110	46365	0.394	0.433
ER20-STIMC-120	46367	0.433	0.472
ER20-STIMC-0500	46391	0.461	0.500
ER20-STIMC-130	46368	0.472	0.512



Ultra Precision ER 25 Collets

Description	UPC #	Holding Capacity	
ER25-STIMC-10	46428	0.020	0.039
ER25-STIMC-15	46429	0.039	0.059
ER25-STIMC-20	46430	0.059	0.079
ER25-STIMC-0937	46499	0.075	0.094
ER25-STIMC-30	46431	0.079	0.118
ER25-STIMC-0125	46500	0.086	0.125
ER25-STIMC-40	46433	0.118	0.157
ER25-STIMC-0187	46501	0.148	0.188
ER25-STIMC-50	46434	0.157	0.197
ER25-STIMC-60	46435	0.197	0.236
ER25-STIMC-0250	46502	0.211	0.250
ER25-STIMC-70	46436	0.236	0.276
ER25-STIMC-80	46437	0.276	0.315
ER25-STIMC-90	46438	0.315	0.354
ER25-STIMC-0375	46503	0.336	0.375
ER25-STIMC-100	46439	0.354	0.394
ER25-STIMC-110	46440	0.394	0.433
ER25-STIMC-120	46442	0.433	0.472
ER25-STIMC-0500	46517	0.461	0.500
ER25-STIMC-130	46443	0.472	0.512
ER25-STIMC-140	46444	0.512	0.551
ER25-STIMC-150	46445	0.551	0.591
ER25-STIMC-0625	46518	0.586	0.625
ER25-STIMC-160	46446	0.591	0.630



Ultra Precision ER 32 Collets

Description	UPC #	Holding Capacity	
ER32-STIMC-20	46521	0.059	0.079
ER32-STIMC-0937	46543	0.075	0.094
ER32-STIMC-30	46522	0.079	0.118
ER32-STIMC-0125	46544	0.086	0.125
ER32-STIMC-40	46524	0.118	0.157
ER32-STIMC-0187	46545	0.148	0.188
ER32-STIMC-50	46525	0.157	0.197
ER32-STIMC-60	46526	0.197	0.236
ER32-STIMC-0250	46546	0.211	0.250
ER32-STIMC-70	46527	0.236	0.276
ER32-STIMC-80	46528	0.276	0.315
ER32-STIMC-90	46529	0.315	0.354
ER32-STIMC-0375	46547	0.336	0.375
ER32-STIMC-100	46530	0.354	0.394
ER32-STIMC-110	46531	0.394	0.433
ER32-STIMC-120	46533	0.433	0.472
ER32-STIMC-0500	46569	0.461	0.500
ER32-STIMC-130	46534	0.472	0.512
ER32-STIMC-140	46535	0.512	0.551
ER32-STIMC-150	46536	0.551	0.591
ER32-STIMC-0625	46570	0.586	0.625
ER32-STIMC-160	46537	0.591	0.630
ER32-STIMC-170	46538	0.630	0.669
ER32-STIMC-180	46539	0.669	0.709
ER32-STIMC-190	46540	0.709	0.748
ER32-STIMC-0750	46571	0.713	0.750
ER32-STIMC-200	46542	0.748	0.787



Ultra Precision ER 40 Collets

Description	UPC #	Holding Capacity	
ER40-STIMC-30	46623	0.079	0.118
ER40-STIMC-0125	46649	0.087	0.125
ER40-STIMC-40	46624	0.118	0.157
ER40-STIMC-0187	46650	0.150	0.188
ER40-STIMC-50	46625	0.157	0.197
ER40-STIMC-60	46626	0.197	0.236
ER40-STIMC-0250	46651	0.213	0.250
ER40-STIMC-70	46627	0.236	0.276
ER40-STIMC-80	46628	0.276	0.315
ER40-STIMC-90	46629	0.315	0.354
ER40-STIMC-0375	46652	0.335	0.375
ER40-STIMC-100	46630	0.354	0.394
ER40-STIMC-110	46631	0.394	0.433
ER40-STIMC-120	46633	0.433	0.472
ER40-STIMC-0500	46653	0.461	0.500
ER40-STIMC-130	46634	0.472	0.512
ER40-STIMC-140	46635	0.512	0.551
ER40-STIMC-150	46636	0.551	0.591
ER40-STIMC-0625	46683	0.587	0.625
ER40-STIMC-160	46637	0.591	0.630
ER40-STIMC-170	46638	0.630	0.669
ER40-STIMC-180	46639	0.669	0.709
ER40-STIMC-190	46640	0.709	0.748
ER40-STIMC-200	46642	0.748	0.787
ER40-STIMC-0750	46686	0.713	0.750
ER40-STIMC-210	46643	0.787	0.827
ER40-STIMC-220	46644	0.827	0.866
ER40-STIMC-0875	46684	0.835	0.875
ER40-STIMC-230	46645	0.866	0.906
ER40-STIMC-240	46646	0.906	0.945
ER40-STIMC-250	46647	0.945	0.984
ER40-STIMC-1000	46685	0.961	1.000
ER40-STIMC-260	46648	0.984	1.024



Ultra Precision ER Collets-Sets

Description	UPC #	Piece per set	Collet Size
ER11-MCS-13C	46768	13	1, 1.5, 2, 2.5, 3, 3.5, 4, 4.5, 5, 5.5, 6, 6.5, 7
ER16-MCS-10C	46769	10	1, 2, 3, 4, 5, 6, 7, 8, 9, 10
ER20-MCS-12C	46770	12	2, 3, 4, 5, 6, 7, 8, 9, 10, 11, 12, 13
ER25-MCS-15C	46771	15	2, 3, 4, 5, 6, 7, 8, 9, 10, 11, 12, 13, 14, 15, 16
ER32-MCS-18C	46772	18	3, 4, 5, 6, 7, 8, 9, 10, 11, 12, 13, 14, 15, 16, 17, 18, 19, 20
ER40-MCS-23C	46773	23	4, 5, 6, 7, 8, 9, 10, 11, 12, 13, 14, 15, 16, 17, 18, 19, 20, 21, 22, 23, 24, 25, 26



TOOL PRESETTER & TIGHTENING FIXTURES

PRECISION,
PERFORMANCE

&

EFFICIENCY



The QuiK-SET™ Tool Presetter

Is a precision instrument designed for speed and simplicity in manufacturing environments or tool cribs. This model has been carefully designed to meet the needs of the CNC machine operator. Its portability and ruggedness make this the best presetter for small machining cells. The pre-loaded recirculating ball bearing guide in the X-axis allows for accurate and smooth positioning to measure the tool's diameter, while the Z-axis display can be locked to preset tool lengths quickly and precisely.

UPC #	42001	42030	42032	42034
Quik-SET	Z300	Z400	XM	Z600
Accuracy	±.0005	±.0005	±.0005	±.0005
Height Capacity (Z)	12.0 in	15.8 in	12.0 in	23.6 in
Diameter Capacity (X)	10.0 in	10.0 in	15.8 in	23.6 in
Presetter Height (H)	23.6 in	27.6 in	23.6 in	36.2 in
Presetter Length (L)	15.8 in	15.8 in	19.7 in	23.2 in
Presetter Width (W)	5.7 in	5.7 in	7.7 in	7.7 in
Measuring Method	Contact Probe			
Power Input	AA Batteries			
Warranty	One Year*			

SUPPLIED STANDARD WITH CAT/BT40 TOOL SLEEVE

Quik-SET Optional Tool Sleeves

Style	ISO-20	ISO/BT-30	CAT/ISO/BT-40	ISO/CAT/BT-50	HSK-40A/50F	HSK-50A/63F	HSK63A-63C	HSK-100A
UPC #	42073	42066	42068	42070	42076	42077	42078	42080

Hardware

- All Heat Treated Components
- Recirculating Ball Bearing and Linear Guide
- Powered by AA Batteries
- Heavy Duty Steel Base
- CAT, BT, HSK, ISO and VDI Interchangeable Sleeves

Precision

- Resolution .0005in (0.10mm)
- Accuracy ± .0005in (0.10mm)
- Repeatability .0005in (0.10mm)
- Axis Squareness .0002in (.005mm) TIR

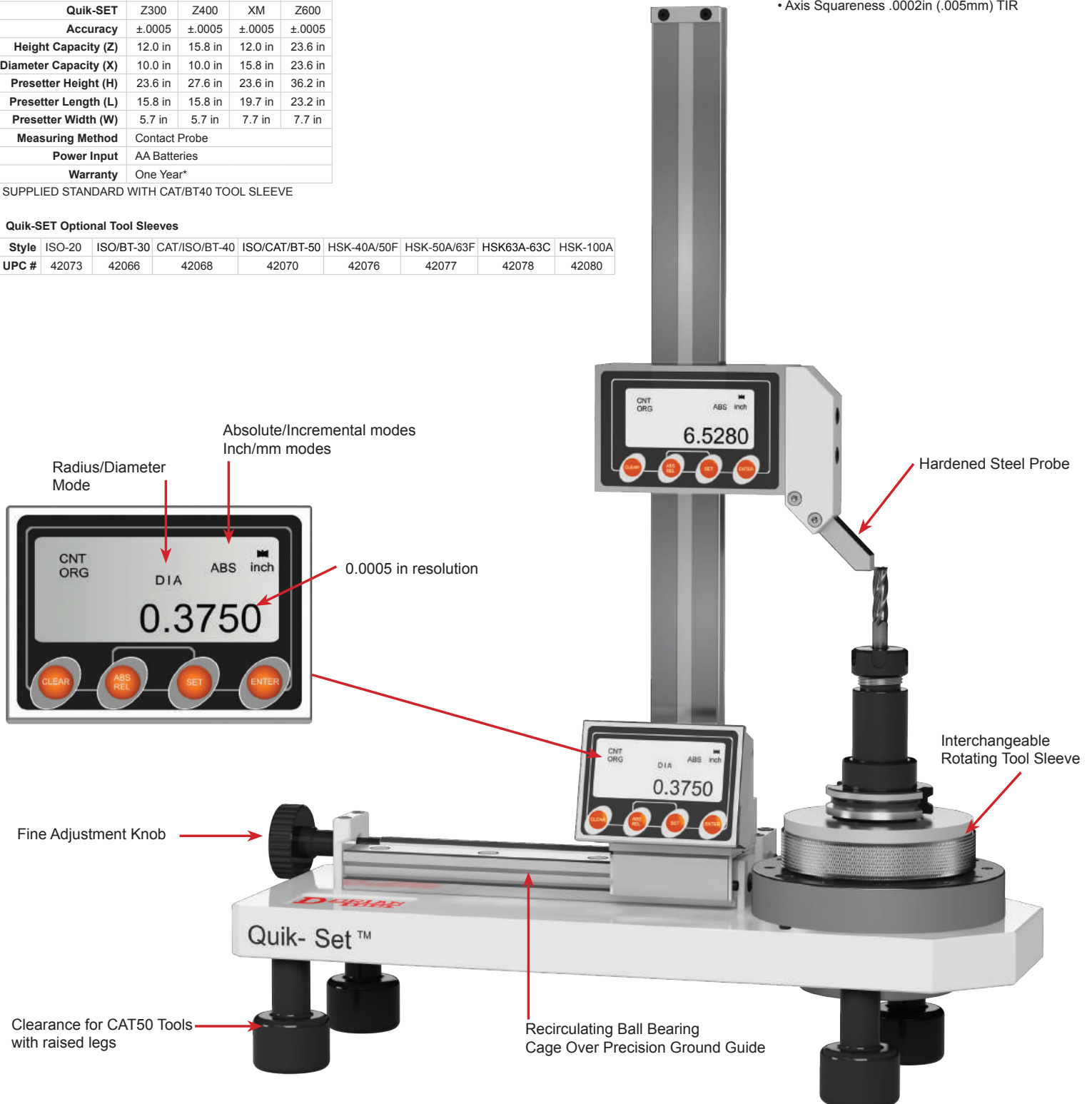

SMART TOOL-SETTERS™

& TIGHTENING FIXTURES

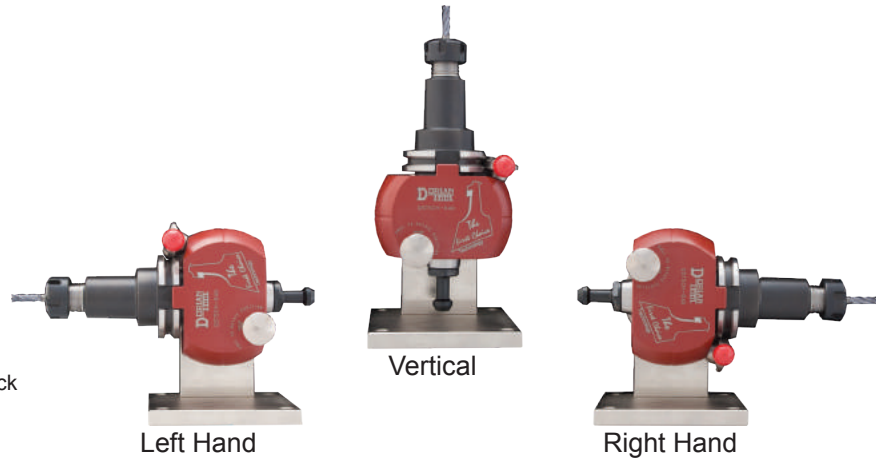

UPC #	Description	Tool Size
36000	DSTSCH-030	BT-30
36001	DSTSCH-040	BT-40 CAT-40
36002	DSTSCH-050	BT-50 CAT-50
36003	DSTSHSK-063	HSK-063
36004	DSTSHSK-100	HSK-100

Toolholder Taper Protected From Chips & Scratches

- Teflon Based Xylan Coating
- Quick Lock & Setting
- Multi-Position Setting
- Heavy Duty Construction
- Precise Quality & Workmanship
- Multi-Functional
- Holds CAT, BT or HSK Toolholders

Mounting

Mounting Holes



Mount the Smart Tool-Setter on a solid workbench. Use the 4 holes provided on the base to bolt down the Smart Tool-Setter.

Holder Loading



Put holder in while locking knob is in unlocked position. Rotate locking knob to locked position to lock holder on the inVin groove located on the diameter of the holder. Locking knob positively locks the tool in and does not allow tool to come out of place.

Application

The Smart Tool-Setter's precise and heavy duty construction make the tool-setter very rigid and able to endure extreme forces without causing any damage to tools or the Smart Tool-Setter. The multi-functioning and positioning of the Smart Tool-Setter allow the operator to switch quickly and easily from one operation to another without loss of time.

Small Tool Change



Endmills can be easily, quickly, and precisely set with the Smart Tool-Setter.

Large Tool Change



Large tools can be mounted or removed with the Smart Tool-Setter.

Positioning



Vertical



Horizontal Left Hand



Horizontal Right Hand

Pull the indexing knob to unlock, turn into a new position, and release the indexing to lock.

Pull Stud Change



Pull Studs can be quickly and easily changed using the Smart Tool-Setter.



Fontana Liri Italy



Inch Vol 6
TOOL GUIDE
FOR EVERYDAY MACHINING

MPR08 DT TG6

Dorian Tool International, Inc.
615 County Rd 219, East Bernard
TX 77435, USA
Phone: 979-282-2861
Toll free: 800-627-0266
Fax: 888-508-7055
sales@doriantool.com
www.doriantool.com



USA Warehouse Locations: • East Bernard, TX • Westfield, MA • Anaheim, CA • Birmingham, AL • Schiller Park, IL