



# DieMax XL<sup>®</sup> Maximum Life Springs



- ISO Inch
- ISO Metric
- JIS
- R-Series

# DieMax XL® – Maximum Life Springs

## Since 1923, Danly Delivers Quality Diemakers' Supplies

Danly is the leading manufacturer of die making supplies and components for industry in North America. Since 1923, Danly provides high quality products and services, innovative development, and custom products.

The Danly product set includes a wide range of guide posts, bushings, die springs, punches, wear plates and cams, and other diemakers' supplies. We also supply customized products to fit our customer specifications.

One of our goals at Danly is to lead the industry in providing products that help customers find solutions to improve their operations. The development of tapping tools provided the opportunity for gains in customer efficiency. These tools allow customers to eliminate the secondary operation of tapping products by allowing them to be tapped in the stamping operation.

To maintain our leadership and reputation, we have invested heavily in state-of-the-art manufacturing facilities.

Danly is the name for trusted solutions and innovation for the global parts forming industry.

### The Danly Story

Danly incorporated on August 20, 1923. Although the first "modern" die sets were used as long ago as the late 1800s, Danly revolutionized the industry with the guide post die set. This set, so named for the feature of the pin entering the bushing to guide the punch holder to the proper position, came into its own as a result of the tremendous increase in the use of stampings to meet the urgency of production in WWI. This is the type of die set which is generally used today. When Danly was founded, however, die sets were still being produced in the tool shops of the user, or on special order at job shops.

Danly brought a completely new concept into the manufacture of die sets. This was Danly's now famous "interchangeability" by which Danly die holders of the same center distance are made interchangeable. This method, for the first time, made it possible for the die designer to lay out his dies with absolute certainty that they would fit in the Danly die set specified.

Danly continues to set the standard for die and mold components.

### LEMME TELL YA' ALL ABOUT DANLY DIEMAKERS' SUPPLIES

Lemme tell ya' all about 'em . . . how they make die work quicker, easier and better, too . . . how they're precision-made for precision work. And, how complete the Danly line is . . . includes just the right item in just the right size for every kind of job. Bushings, guide posts, dowel pins, die springs, set screws, stripper bolts, toggle clamps, spring retainers, die stops, auto gages, even lubricant. No matter what it is, if a diemaker needs it, Danly makes it—and your Danly distributor has it.

Your salesman or distributor also has a copy of a new booklet for you. It's hot off the press and loaded with information telling you all about all the Danly Diemakers' Supplies. Ask him for a copy!

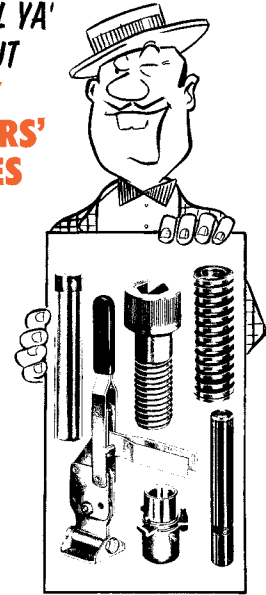

New 16-page booklet describing the complete line of Danly Diemakers' Supplies is available free from your distributor or salesman—or by writing to the Danly plant.



# DANLY

DANLY MACHINE SPECIALTIES, INC.

### Danly Products

- Surface Mount Ball Bearing Assemblies
- Plain Bearing Components
- Ball Bearing Guiding Systems: Inch and Metric
- Wear Products
- NAAMS Automotive Pins
- NAAMS Automotive Bushings
- NAAMS Automotive Wear Plates
- NAAMS Guide Blocks and Keeper Blocks
- Aerial & Die Mount Wide Cams
- Box Cams and Bump Cams
- DieMax XL Die Springs
- JIS Die Springs
- Formathane
- Accu-Bend™ & Posi-Bend™ Rotary Benders
- In-Die Tapping
- Die Accessories
- Special Products
- Bronze Plating Services



## Table of Contents



General Information . . . . .	4
Spring Selection Steps . . . . .	5
<b>ISO Inch Standard</b> . . . . .	6
Extra Light . . . . .	8
Light . . . . .	9
Medium . . . . .	10
Heavy . . . . .	11
Extra Heavy . . . . .	12
Ultra Heavy . . . . .	13
<b>ISO Metric Standard</b> . . . . .	14
Extra Light . . . . .	14
Light . . . . .	15
Medium . . . . .	16
Heavy . . . . .	17
Extra Heavy . . . . .	18
Ultra Heavy . . . . .	19
<b>Round Wire</b> . . . . .	20
<b>JIS</b> . . . . .	22
Extra Light . . . . .	24
Light . . . . .	26
Medium . . . . .	28
Heavy . . . . .	30
Extra Heavy . . . . .	32
<b>R Series Inch Standard</b> . . . . .	35
Medium . . . . .	36
Medium Heavy . . . . .	37
Heavy . . . . .	38
Extra Heavy . . . . .	39
<b>Spring Accessories</b> . . . . .	40
<b>Quote Sheet</b> . . . . .	43

# DieMax XL® – Maximum Life Springs

## DieMax XL® Maximum Life Springs – springs you can rely on.

A combination of enhanced raw material, optimal spring design, innovative manufacturing processes, and broad distribution channels allow the DieMax XL® spring to yield the best, most dependable performance and availability combination, time after time.

### Spring Wire

Danly springs are manufactured from premium spring quality steel. The high tensile strength and superior heat resistance wire characteristics contribute to the low-stress, long life spring design.

### Enhanced Design

Our spring starts with a modified trapezoidal cross section and changes to a “D” cross section after coiling. This wire cross section has significantly lower stress levels during compression compared to competitor designs. The “D” cross section also allows for more coils per spring while providing a greater amount of spring travel to solid when compared to competitor springs.

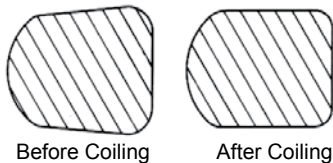

*Modified trapezoidal cross section of rectangular wire springs changes to a “D” cross section during coiling to achieve a low stress level that means longer spring life.*

### Physical Dimensions and Load Ratings

Computer controlled coiling and spring setting equipment allow tight control over the critical spring characteristics. Every manufactured lot of DieMax XL® springs is carefully inspected for hole/rod fit, free length, spring rate, solid height, squareness and physical appearance. All inspection results are recorded and analyzed to ensure compliance to quality standards. These tight tolerances and highly inspected attributes guarantee the springs will work freely over the rods or freely in the holes specified without binding. They also ensure that the free lengths, solid heights and spring loads are compatible from spring to spring and lot to lot for predictable, long-life performance.

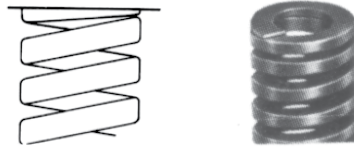

*Ends of each spring are closed and ground square to assure that the spring will stand on either end and provide a maximum bearing surface.*

### Manufacturing Processes

In addition to the optimal, low-stress spring design, the continual investment in the most advanced coiling and spring processing equipment allows Danly to offer a premium, long-life, mechanical spring solution. From the computer controlled spring coilers with in-line SPC data collection, the springs are routed through a series of steps including shot peening to reduce working stresses, and set removal which ensures the spring length and load will not relax in the tool.

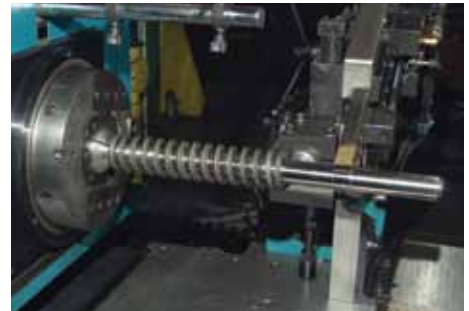

Using the latest in CNC coiling technology, springs are produced with much better predictability and consistency in performance, rates and lengths.

Operators use Statistical Process Control (SPC) software to ensure that every production process meets our high quality standards.

Spring testers track and verify consistency in spring dimensions and rates with custom spring testing software.

# Spring Selection Steps

If the diameter and length are known, turn directly to dimension tables beginning on page 8 to select springs with desired total load.

If diameter and length are not known, use the following seven spring selection steps and refer to the rate column of the dimension tables for spring selection.

In determining the length of a spring, it should be remembered that maximum delivered spring load is obtained by selecting longer springs. For best economy and saving of space, choose Light and Medium Load springs or the Heavy Load spring having a free length equal to six times the travel, or an Extra Heavy Load spring having a free length equal to eight times the travel. If ratios lower than these are used because of height limitations, the number of springs required will be substantially increased.

## Step 1

Estimate the level of production required of the die - short run, constant production, etc.

## Step 2

Determine compressed spring length "H" and operating travel "T" from the die layout.

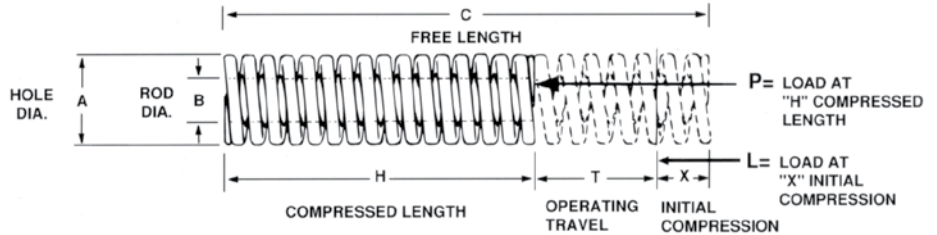
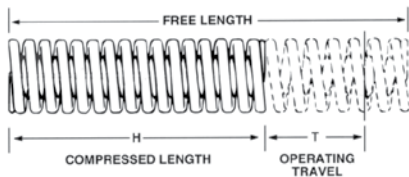

## Step 3

Determine free length "C" as follows: Decide which load classification the spring should be selected from: Light, Medium, Heavy, or Extra-Heavy Load. Then choose the figure nearest the compressed length "H" required by the die design from the appropriate charts on page 6. Read corresponding "C" (free length).

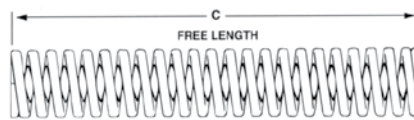

## Step 4

Estimate total initial spring load "L" required for all springs when springs are compressed "X" inches or millimeters.

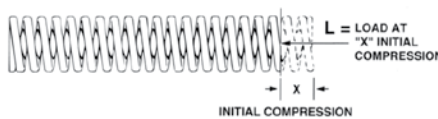

## Step 5

Determine "X" (initial compression) by using the following formula:

$$X = C - H - T$$

## Step 6

**Inch:** Determine "R" (total rate for all springs in pounds per 1/10 inch) by using the following formula:

$$R = \frac{L}{10 \times X}$$

**Metric:** Determine "R" (total rate for all springs in newtons per millimeter) by using the following formula:

$$R = \frac{L}{X}$$

## Step 7

Select springs as follows:

1. The free length "C" must comply with the length determined in Step 3.
2. Divide "R" in Step 6 by the number of springs to be used (if known) in order to get the rate per spring. Then refer to the following pages for the catalog number of springs having the desired rate. If the number of springs is not known, divide "R" from Step 6 by the rate of the spring you select for the correct number of springs.

# Spring Selection Steps

## INCH

This chart converts compressed lengths to free lengths.

C Free Length (in)	EXTRA LIGHT LOAD H-Compressed Length (in)			LIGHT LOAD H-Compressed Length (in)			MEDIUM LOAD H-Compressed Length (in)			HEAVY LOAD H-Compressed Length (in)			EXTRA HEAVY LOAD H-Compressed Length (in)			ULTRA HEAVY LOAD H-Compressed Length (in)		
	Long Life 30%	Average Life 40%	Maximum Deflection 50%	Long Life 25%	Average Life 30%	Maximum Deflection 40%	Long Life 25%	Average Life 30%	Maximum Deflection 37.5%	Long Life 20%	Average Life 25%	Maximum Deflection 30%	Long Life 17%	Average Life 20%	Maximum Deflection 25%	Long Life 10%	Average Life 12%	Maximum Deflection 15%
3/4	-	-	-	0.56	0.53	0.45	0.56	0.53	0.47	0.60	0.56	0.53	0.62	0.60	0.56	-	-	-
1	0.70	0.40	0.50	0.75	0.70	0.60	0.75	0.70	0.62	0.80	0.75	0.70	0.83	0.80	0.75	-	-	-
1 1/4	0.88	0.50	0.63	0.94	0.87	0.75	0.94	0.87	0.78	1.00	0.94	0.87	1.04	1.00	0.94	-	-	-
1 1/2	1.05	0.60	0.75	1.12	1.05	0.90	1.12	1.05	0.93	1.20	1.12	1.05	1.25	1.20	1.12	-	-	-
1 3/4	1.23	0.70	0.88	1.31	1.22	1.05	1.31	1.22	1.09	1.40	1.31	1.22	1.45	1.40	1.31	-	-	-
2	1.40	0.80	1.00	1.50	1.40	1.20	1.50	1.40	1.25	1.60	1.50	1.40	1.66	1.60	1.50	-	-	-
2 1/2	1.75	1.00	1.25	1.87	1.75	1.50	1.87	1.75	1.56	2.00	1.87	1.75	2.07	2.00	1.87	2.25	2.20	2.13
3	2.10	1.20	1.50	2.25	2.10	1.80	2.25	2.10	1.87	2.40	2.25	2.10	2.50	2.40	2.25	2.70	2.64	2.55
3 1/2	2.45	1.40	1.75	2.62	2.45	2.10	2.62	2.45	2.18	2.80	2.62	2.45	2.91	2.80	2.62	3.15	3.08	2.98
4	2.80	1.60	2.00	3.00	2.80	2.40	3.00	2.80	2.50	3.20	3.00	2.80	3.33	3.20	3.00	3.60	3.52	3.40
4 1/2	3.15	1.80	2.25	3.37	3.15	2.70	3.37	3.15	2.81	3.60	3.37	3.15	3.75	3.60	3.37	4.05	3.96	3.83
5	3.50	2.00	2.50	3.75	3.50	3.00	3.75	3.50	3.12	4.00	3.75	3.50	4.15	4.00	3.75	4.50	4.40	4.25
5 1/2	3.85	2.20	2.75	4.13	3.85	3.30	4.13	3.85	3.44	4.40	4.13	3.85	4.57	4.40	4.13	-	-	-
6	4.20	2.40	3.00	4.50	4.20	3.60	4.50	4.20	3.75	4.80	4.50	4.20	5.00	4.80	4.50	5.40	5.28	5.10
7	4.90	2.80	3.50	5.25	4.90	4.20	5.25	4.90	4.37	5.60	5.25	4.90	5.83	5.60	5.25	6.30	6.16	5.95
8	5.60	3.20	4.00	6.00	5.60	4.80	6.00	5.60	5.00	6.40	6.00	5.60	6.66	6.40	6.00	7.20	7.04	6.80
9	-	-	-	-	-	-	6.75	6.30	5.62	7.20	6.75	6.30	-	-	-	-	-	-
10	7.00	4.00	5.00	7.50	7.00	6.00	7.50	7.00	6.25	8.00	7.50	7.00	8.30	8.00	7.50	9.00	8.80	8.50
12	8.40	4.80	6.00	9.00	8.40	7.20	9.00	8.40	7.50	9.60	9.00	8.40	10.00	9.60	9.00	10.80	10.56	10.20

## METRIC

This chart converts compressed lengths to free lengths.

C Free Length (mm)	EXTRA LIGHT LOAD H-Compressed Length (mm)			LIGHT LOAD H-Compressed Length (mm)			MEDIUM LOAD H-Compressed Length (mm)			HEAVY LOAD H-Compressed Length (mm)			EXTRA HEAVY LOAD H-Compressed Length (mm)			ULTRA HEAVY LOAD H-Compressed Length (mm)		
	Long Life 30%	Average Life 40%	Maximum Deflection 50%	Long Life 25%	Average Life 30%	Maximum Deflection 40%	Long Life 25%	Average Life 30%	Maximum Deflection 37.5%	Long Life 20%	Average Life 25%	Maximum Deflection 30%	Long Life 17%	Average Life 20%	Maximum Deflection 25%	Long Life 10%	Average Life 12%	Maximum Deflection 15%
19	-	-	-	14	13	11	14	13	12	15	14	13	16	15	14	-	-	-
25	18	15	13	19	18	15	19	18	16	20	19	18	21	20	19	-	-	-
32	22	19	16	24	22	19	24	22	20	26	24	22	27	26	24	-	-	-
38	27	23	19	29	27	23	29	27	24	30	29	27	32	30	29	-	-	-
44	31	26	22	33	31	26	33	31	28	35	33	31	37	35	33	-	-	-
51	36	31	26	38	36	31	38	36	32	41	38	36	42	41	38	-	-	-
64	45	38	32	48	45	38	48	45	40	51	48	45	53	51	48	58	56	54
76	53	46	38	57	53	46	57	53	47	61	57	53	63	61	57	68	67	65
89	62	53	45	67	62	53	67	62	56	71	67	62	74	71	67	80	78	76
102	71	61	51	76	71	61	76	71	64	82	76	71	85	82	76	92	90	87
115	81	68	58	86	80	68	86	80	71	91	86	80	95	91	86	104	101	98
127	89	76	64	95	89	76	95	89	79	102	95	89	105	102	95	114	112	108
139	97	84	70	105	98	84	105	98	87	112	105	98	116	112	105	-	-	-
152	106	91	76	114	106	91	114	106	95	122	114	106	126	122	114	137	134	129
178	125	107	89	133	125	107	133	125	111	142	133	125	148	142	133	160	157	151
203	142	122	102	152	142	122	152	142	127	162	152	142	168	162	152	183	179	173
229	-	-	-	-	-	-	172	160	143	183	172	160	-	-	-	-	-	-
254	178	152	127	190	178	152	190	178	159	203	190	178	211	203	190	229	224	216
305	214	183	153	229	213	183	229	213	191	244	229	213	253	244	229	275	268	259

## Six load classifications – in standard ISO sizes for dies, jigs, fixtures, and general tool work.

Danly springs are offered in a range of lengths, diameters, and load classifications that conform to the ISO 10243 International Standard and the NAAMS (North American Automotive Metric Standard), including color coding for easy identification of load range.

### ISO 9001:2015 Registered Quality

All of our Danly die springs are manufactured to ISO 9001:2015 quality standards consistent with the Danly reputation for providing the stamping industry with the most carefully engineered diemakers'

supplies. Comparison testing of the operating life of Danly die springs and competitive products have shown that Danly springs offer significantly longer life.

The exceptional quality of Danly die springs has made them popular for a wide variety of applications. For example, Danly die springs are commonly used in general tool work, such as jigs and fixtures, as well as in industrial clutches and brakes and as components in farm machinery and aircraft mechanisms. Many manufacturers specify Danly

die springs because the quality and service life of these springs improves the reliability and performance of their products.

Whatever your application might be, you can be sure that the springs you select from this catalog will consistently provide rugged, dependable spring performance. They will live up to the Danly reputation for quality and value.

For help with your selection, or to order die springs, contact Danly or your authorized Danly distributor.



**EXTRA LIGHT  
LOAD**  
Light Green



**LIGHT  
LOAD**  
Green



**MEDIUM  
LOAD**  
Blue



**HEAVY  
LOAD**  
Red



**EXTRA HEAVY  
LOAD**  
Yellow



**ULTRA HEAVY  
LOAD**  
Silver

# DieMax XL® Extra Light Load Springs – Inch Standard

Hole Diam. (in) A	Rod Diam. (in) B	Free Length (in) C	CATALOG NUMBER	RATE Pounds Req'd. to deflect 1/10 in.	LOAD-DEFLECTION TABLE							
					Total Deflection for Long Life (30% of C)		Total Deflection for Avg. Life (40% of C)		Maximum Operating Deflection (50% of C)		Total Travel to Solid	
					Load lbs.	Defl. in.	Load lbs.	Defl. in.	Load lbs.	Defl. in.	Load lbs.	Defl. in.
3/4	3/8	1	9-1204-06	16.8	50	0.30	66	0.39	83	0.49	92	0.55
		1 1/4	9-1205-06	12.9	49	0.38	65	0.50	81	0.63	93	0.72
		1 1/2	9-1206-06	10.6	48	0.45	64	0.60	79	0.75	92	0.87
		1 3/4	9-1207-06	9.0	47	0.52	62	0.69	78	0.87	92	1.02
		2	9-1208-06	7.8	47	0.60	63	0.80	79	1.00	93	1.19
		2 1/2	9-1210-06	6.5	49	0.76	65	1.01	81	1.26	99	1.53
		3	9-1212-06	5.6	50	0.90	67	1.20	84	1.50	104	1.85
		3 1/2	9-1214-06	4.7	50	1.05	66	1.40	83	1.75	103	2.19
		4	9-1216-06	4.2	51	1.20	68	1.61	85	2.01	106	2.53
		4 1/2	9-1218-06	3.7	50	1.36	66	1.81	83	2.26	106	2.87
		5	9-1220-06	3.4	51	1.50	68	2.00	84	2.50	108	3.18
		5 1/2	9-1222-06	3.1	51	1.64	68	2.19	84	2.74	108	3.48
6	9-1224-06	2.8	50	1.80	67	2.39	84	2.99	107	3.81		
12	9-1248-06	1.4	52	3.60	69	4.80	86	6.00	108	7.73		
1	1/2	1	9-1604-06	30.8	91	0.30	121	0.39	152	0.49	157	0.51
		1 1/4	9-1605-06	24.1	91	0.38	122	0.50	152	0.63	164	0.68
		1 1/2	9-1606-06	20.5	92	0.45	122	0.60	153	0.75	166	0.81
		1 3/4	9-1607-06	17.9	93	0.52	124	0.69	155	0.87	172	0.96
		2	9-1608-06	15.4	93	0.60	124	0.80	155	1.00	172	1.12
		2 1/2	9-1610-06	12.3	93	0.76	124	1.01	155	1.26	177	1.44
		3	9-1612-06	10.3	93	0.90	124	1.20	155	1.50	178	1.73
		3 1/2	9-1614-06	8.7	91	1.05	122	1.40	152	1.75	176	2.02
		4	9-1616-06	7.5	91	1.20	121	1.61	151	2.01	175	2.33
		4 1/2	9-1618-06	6.7	92	1.36	122	1.81	153	2.26	178	2.65
		5	9-1620-06	6.1	91	1.50	121	2.00	151	2.50	179	2.93
		5 1/2	9-1622-06	5.5	90	1.64	120	2.19	150	2.74	177	3.21
6	9-1624-06	5.0	90	1.80	120	2.39	151	2.99	176	3.52		
7	9-1628-06	4.3	91	2.10	122	2.80	152	3.50	178	4.15		
8	9-1632-06	3.8	92	2.40	122	3.20	153	4.00	181	4.75		
12	9-1648-06	2.5	91	3.60	121	4.80	151	6.00	180	7.18		
1 1/4	5/8	1 1/2	9-2006-06	24.6	110	0.45	147	0.60	184	0.75	192	0.78
		1 3/4	9-2007-06	21.3	111	0.52	148	0.69	185	0.87	198	0.93
		2	9-2008-06	18.5	112	0.60	149	0.80	186	1.00	202	1.09
		2 1/2	9-2010-06	14.6	110	0.76	147	1.01	184	1.26	203	1.39
		3	9-2012-06	12.3	111	0.90	148	1.20	185	1.50	205	1.67
		3 1/2	9-2014-06	10.3	109	1.05	145	1.40	181	1.75	203	1.97
		4	9-2016-06	9.0	108	1.20	144	1.61	180	2.01	204	2.27
		4 1/2	9-2018-06	8.1	110	1.36	147	1.81	184	2.26	209	2.58
		5	9-2020-06	7.3	109	1.50	145	2.00	181	2.50	208	2.85
		5 1/2	9-2022-06	6.6	109	1.64	145	2.19	181	2.74	207	3.13
		6	9-2024-06	6.1	109	1.80	145	2.39	181	2.99	210	3.44
		7	9-2028-06	5.1	108	2.10	144	2.80	180	3.50	207	4.05
8	9-2032-06	4.5	107	2.40	142	3.20	178	4.00	208	4.63		
10	9-2040-06	3.7	110	3.00	146	4.00	183	5.00	216	5.83		
12	9-2048-06	3.0	109	3.60	146	4.80	182	6.00	211	7.02		

Hole Diam. (in) A	Rod Diam. (in) B	Free Length (in) C	CATALOG NUMBER	RATE Pounds Req'd. to deflect 1/10 in.	LOAD-DEFLECTION TABLE							
					Total Deflection for Long Life (30% of C)		Total Deflection for Avg. Life (40% of C)		Maximum Operating Deflection (50% of C)		Total Travel to Solid	
					Load lbs.	Defl. in.	Load lbs.	Defl. in.	Load lbs.	Defl. in.	Load lbs.	Defl. in.
1 1/2	3/4	2	9-2408-06	27.5	166	0.60	221	0.80	276	1.00	303	1.10
		2 1/2	9-2410-06	22.4	169	0.76	226	1.01	282	1.26	320	1.43
		3	9-2412-06	19.0	171	0.90	228	1.20	285	1.50	327	1.72
		3 1/2	9-2414-06	16.2	171	1.05	227	1.40	284	1.75	330	2.04
		4	9-2416-06	14.0	169	1.20	225	1.61	281	2.01	329	2.35
		4 1/2	9-2418-06	12.6	171	1.36	229	1.81	286	2.26	336	2.67
		5	9-2420-06	11.2	168	1.50	224	2.00	280	2.50	332	2.96
		5 1/2	9-2422-06	10.1	166	1.64	221	2.19	277	2.74	327	3.24
		6	9-2424-06	9.3	166	1.80	222	2.39	277	2.99	332	3.57
		7	9-2428-06	7.8	165	2.10	219	2.80	274	3.50	327	4.19
		8	9-2432-06	7.0	169	2.40	225	3.20	281	4.00	337	4.81
		10	9-2440-06	5.6	168	3.00	224	4.00	280	5.00	339	6.05
12	9-2448-06	4.7	171	3.60	228	4.80	285	6.00	343	7.30		
2	1	2 1/2	9-3210-06	49.3	373	0.76	497	1.01	621	1.26	680	1.38
		3	9-3212-06	40.3	362	0.90	483	1.20	604	1.50	669	1.66
		3 1/2	9-3214-06	34.2	359	1.05	479	1.40	599	1.75	677	1.98
		4	9-3216-06	29.7	358	1.20	477	1.61	597	2.01	683	2.30
		4 1/2	9-3218-06	26.3	358	1.36	477	1.81	596	2.26	684	2.60
		5	9-3220-06	24.1	362	1.50	482	2.00	603	2.50	701	2.91
		5 1/2	9-3222-06	21.8	358	1.64	478	2.19	597	2.74	695	3.19
		6	9-3224-06	19.6	352	1.80	469	2.39	587	2.99	686	3.50
		7	9-3228-06	16.8	353	2.10	471	2.80	589	3.50	697	4.15
		8	9-3232-06	14.6	349	2.40	466	3.20	582	4.00	694	4.75
		10	9-3240-06	11.8	353	3.00	471	4.00	589	5.00	707	5.99
		12	9-3248-06	9.8	354	3.60	472	4.80	590	6.00	709	7.23



## Product Features:

- ◆ Color – Light Green
- ◆ High tensile strength chrome silicon
- ◆ Optimal rectangular wire design
- ◆ Long life design



# DieMax XL® Light Load Springs – Inch ISO Standard

Hole Diam. (in) A	Rod Diam. (in) B	Free Length (in) C	CATALOG NUMBER	RATE Pounds Req'd. to deflect 1/10 in.	LOAD-DEFLECTION TABLE									
					Total Deflection for Long Life (25% of C)		Total Deflection for Avg. Life (30% of C)		Maximum Operating Deflection (40% of C)		Total Travel to Solid			
					Load lbs.	Defl. in.	Load lbs.	Defl. in.	Load lbs.	Defl. in.	Load lbs.	Defl. in.		
3/8	3/16	3/4	9-0603-11	9.0	17	0.19	20	0.23	27	0.30	34	0.38		
		1	9-0604-11	6.3	16	0.25	19	0.30	25	0.40	32	0.50		
		1 1/4	9-0605-11	5.0	16	0.31	19	0.38	25	0.50	32	0.63		
		1 1/2	9-0606-11	4.2	16	0.37	19	0.45	25	0.60	32	0.77		
		1 3/4	9-0607-11	3.6	16	0.43	19	0.52	25	0.69	32	0.89		
		2	9-0608-11	3.1	15	0.50	18	0.60	25	0.80	32	1.02		
		2 1/2	9-0610-11	2.6	16	0.63	19	0.76	26	1.01	34	1.30		
		3	9-0612-11	2.1	16	0.75	19	0.90	25	1.20	33	1.56		
		12	9-0648-11	0.5	15	3.00	18	3.60	24	4.80	31	6.24		
		1/2	9/32	3/4	9-0803-11	15.0	28	0.19	34	0.23	45	0.30	59	0.39
				1	9-0804-11	10.9	27	0.25	32	0.30	43	0.40	55	0.50
				1 1/4	9-0805-11	9.4	30	0.31	36	0.38	47	0.50	65	0.69
1 1/2	9-0806-11			7.8	29	0.37	35	0.45	47	0.60	68	0.87		
1 3/4	9-0807-11			6.6	29	0.43	34	0.52	46	0.69	67	1.02		
2	9-0808-11			5.8	29	0.50	35	0.60	47	0.80	67	1.15		
2 1/2	9-0810-11			4.7	29	0.63	35	0.76	47	1.01	69	1.46		
3	9-0812-11			3.6	27	0.75	32	0.90	43	1.20	61	1.70		
3 1/2	9-0814-11			3.1	27	0.88	32	1.05	43	1.40	62	2.00		
4	9-0816-11			2.7	27	1.00	32	1.20	43	1.60	61	2.26		
12	9-0848-11			0.8	25	3.00	30	3.60	40	4.80	50	6.30		
5/8	11/32			3/4	9-1003-11	24.0	46	0.19	55	0.23	72	0.30	86	0.36
		1	9-1004-11	18.0	44	0.25	53	0.30	71	0.40	90	0.50		
		1 1/4	9-1005-11	14.0	43	0.31	53	0.38	70	0.50	91	0.65		
		1 1/2	9-1006-11	12.0	45	0.37	54	0.45	72	0.60	97	0.81		
		1 3/4	9-1007-11	10.0	43	0.43	52	0.52	69	0.69	97	0.97		
		2	9-1008-11	9.3	47	0.50	56	0.60	75	0.80	107	1.16		
		2 1/2	9-1010-11	7.2	45	0.63	54	0.76	73	1.01	104	1.44		
		3	9-1012-11	5.9	44	0.75	53	0.90	71	1.20	103	1.74		
		3 1/2	9-1014-11	5.3	46	0.88	56	1.05	74	1.40	111	2.10		
		4	9-1016-11	4.7	47	1.00	57	1.20	75	1.61	114	2.42		
		4 1/2	9-1018-11	4.1	46	1.12	55	1.35	74	1.80	110	2.68		
		12	9-1048-11	1.5	45	3.00	54	3.60	72	4.80	109	7.26		
3/4	3/8	3/4	9-1203-11	42.5	80	0.19	96	0.23	128	0.30	153	0.36		
		1	9-1204-11	32.0	79	0.25	94	0.30	126	0.40	158	0.49		
		1 1/4	9-1205-11	24.4	77	0.31	92	0.38	123	0.50	152	0.63		
		1 1/2	9-1206-11	19.3	72	0.37	87	0.45	115	0.60	144	0.74		
		1 3/4	9-1207-11	16.2	70	0.43	84	0.52	112	0.69	142	0.87		
		2	9-1208-11	14.2	71	0.50	86	0.60	114	0.80	144	1.02		
		2 1/2	9-1210-11	11.0	69	0.63	83	0.76	111	1.01	139	1.27		
		3	9-1212-11	9.2	69	0.75	83	0.90	110	1.20	142	1.55		
		3 1/2	9-1214-11	7.7	67	0.88	81	1.05	108	1.40	137	1.79		
		4	9-1216-11	6.8	68	1.00	82	1.20	109	1.61	140	2.07		
		4 1/2	9-1218-11	6.0	67	1.12	81	1.35	108	1.80	140	2.34		
		5	9-1220-11	5.3	66	1.25	80	1.50	106	2.00	137	2.58		
5 1/2	9-1222-11	4.9	67	1.38	80	1.65	107	2.20	139	2.86				
6	9-1224-11	4.5	67	1.50	81	1.80	108	2.39	143	3.17				
12	9-1248-11	2.2	65	3.00	78	3.60	104	4.80	135	6.24				
1	1/2	1	9-1604-11	61.2	151	0.25	181	0.30	241	0.40	296	0.48		
		1 1/4	9-1605-11	46.2	146	0.31	175	0.38	233	0.50	284	0.62		
		1 1/2	9-1606-11	37.0	138	0.37	166	0.45	221	0.60	277	0.75		
		1 3/4	9-1607-11	30.6	133	0.43	159	0.52	212	0.69	268	0.87		
		2	9-1608-11	26.5	133	0.50	160	0.60	213	0.80	269	1.01		
		2 1/2	9-1610-11	20.4	129	0.63	154	0.76	206	1.01	258	1.25		
		3	9-1612-11	16.8	126	0.75	151	0.90	201	1.20	256	1.50		
		3 1/2	9-1614-11	14.1	124	0.88	148	1.05	198	1.40	251	1.75		
		4	9-1616-11	12.1	121	1.00	146	1.20	194	1.61	247	2.01		
		4 1/2	9-1618-11	10.7	120	1.12	144	1.35	192	1.80	244	2.25		
		5	9-1620-11	9.6	120	1.25	144	1.50	192	2.00	244	2.52		
		5 1/2	9-1622-11	8.7	120	1.38	144	1.65	192	2.20	247	2.80		
6	9-1624-11	8.0	120	1.50	144	1.80	191	2.39	250	3.10				
7	9-1628-11	6.9	121	1.75	145	2.10	193	2.80	252	3.63				
8	9-1632-11	6.0	120	2.00	144	2.40	192	3.20	253	4.17				
12	9-1648-11	4.0	120	3.00	144	3.60	192	4.80	254	6.22				

Hole Diam. (in) A	Rod Diam. (in) B	Free Length (in) C	CATALOG NUMBER	RATE Pounds Req'd. to deflect 1/10 in.	LOAD-DEFLECTION TABLE							
					Total Deflection for Long Life (25% of C)		Total Deflection for Avg. Life (30% of C)		Maximum Operating Deflection (40% of C)		Total Travel to Solid	
					Load lbs.	Defl. in.	Load lbs.	Defl. in.	Load lbs.	Defl. in.	Load lbs.	Defl. in.
1 1/4	5/8	1 1/2	9-2006-11	57.9	217	0.37	260	0.45	346	0.60	413	0.71
		1 3/4	9-2007-11	47.5	206	0.43	247	0.52	329	0.69	397	0.84
		2	9-2008-11	40.7	204	0.50	245	0.60	327	0.80	393	0.96
		2 1/2	9-2010-11	31.4	198	0.63	237	0.76	316	1.01	382	1.22
		3	9-2012-11	26.3	197	0.75	236	0.90	315	1.20	395	1.50
		3 1/2	9-2014-11	22.2	194	0.88	233	1.05	311	1.40	391	1.76
		4	9-2016-11	19.2	193	1.00	231	1.20	308	1.61	388	2.02
		4 1/2	9-2018-11	16.9	190	1.12	228	1.35	303	1.80	386	2.28
		5	9-2020-11	15.0	188	1.25	225	1.50	300	2.00	379	2.53
		5 1/2	9-2022-11	13.5	186	1.38	223	1.65	298	2.20	374	2.77
		6	9-2024-11	12.3	184	1.50	221	1.80	294	2.39	373	3.03
		7	9-2028-11	10.4	182	1.75	219	2.10	292	2.80	369	3.53
8	9-2032-11	9.1	182	2.00	218	2.40	291	3.20	366	4.04		
10	9-2040-11	7.2	180	2.50	216	3.00	288	4.00	360	5.03		
12	9-2048-11	5.9	177	3.00	213	3.60	283	4.80	357	6.03		
1 1/2	3/4	2	9-2408-11	60.3	303	0.50	363	0.60	484	0.80	584	0.97
		2 1/2	9-2410-11	45.8	289	0.63	346	0.76	462	1.01	558	1.22
		3	9-2412-11	37.5	281	0.75	337	0.90	449	1.20	558	1.49
		3 1/2	9-2414-11	31.8	279	0.88	334	1.05	446	1.40	559	1.76
		4	9-2416-11	27.3	274	1.00	329	1.20	439	1.61	547	2.01
		4 1/2	9-2418-11	24.1	270	1.12	324	1.35	433	1.80	549	2.28
		5	9-2420-11	21.6	270	1.25	324	1.50	432	2.00	551	2.55
		5 1/2	9-2422-11	19.4	267	1.38	321	1.65	428	2.20	543	2.80
		6	9-2424-11	17.6	263	1.50	316	1.80	421	2.39	537	3.05
		7	9-2428-11	15.0	263	1.75	315	2.10	420	2.80	534	3.57
		8	9-2432-11	12.9	258	2.00	309	2.40	412	3.20	526	4.07
		10	9-2440-11	10.3	258	2.50	309	3.00	412	4.00	524	5.11
12	9-2448-11	8.4	252	3.00	303	3.60	403	4.80	516	6.10		
2	1	2 1/2	9-3210-11	89.9	566	0.63	680	0.76	906	1.01	1096	1.22
		3	9-3212-11	72.0	539	0.75	646	0.90	862	1.20	1066	1.48
		3 1/2	9-3214-11	60.2	527	0.88	633	1.05	844	1.40	1046	1.74
		4	9-3216-11	51.2	514	1.00	617	1.20	822	1.61	1014	1.98
		4 1/2	9-3218-11	44.9	504	1.12	605	1.35	806	1.80	1006	2.24
		5	9-3220-11	40.0	500	1.25	600	1.50	800	2.00	1000	2.50
		5 1/2	9-3222-11	36.0	496	1.38	595	1.65	794	2.20	994	2.76
		6	9-3224-11	32.8	491	1.50	589	1.80	785	2.39	990	3.02
		7	9-3228-11	27.8	487	1.75	584	2.10	779	2.80	983	3.54

# DieMax XL® Medium Load Springs – Inch ISO Standard

Hole Diam. (in) A	Rod Diam. (in) B	Free Length (in) C	CATALOG NUMBER	RATE Pounds Req'd. to deflect 1/10 in.	LOAD-DEFLECTION TABLE									
					Total Deflection for Long Life (25% of C)		Total Deflection for Avg. Life (30% of C)		Maximum Operating Deflection (37.5% of C)		Total Travel to Solid			
					Load lbs.	Defl. in.	Load lbs.	Defl. in.	Load lbs.	Defl. in.	Load lbs.	Defl. in.		
3/8	3/16	3/4	9-0603-21	13.0	25	0.19	30	0.23	36	0.28	39	0.30		
		1	9-0604-21	9.6	24	0.25	29	0.30	36	0.37	41	0.43		
		1 1/4	9-0605-21	8.0	25	0.31	30	0.38	38	0.47	44	0.55		
		1 1/2	9-0606-21	6.7	25	0.37	30	0.45	38	0.56	44	0.66		
		1 3/4	9-0607-21	5.6	24	0.43	29	0.52	36	0.65	43	0.77		
		2	9-0608-21	4.9	25	0.50	30	0.60	37	0.75	43	0.88		
		2 1/2	9-0610-21	3.9	24	0.63	29	0.76	37	0.94	43	1.11		
		3	9-0612-21	3.3	24	0.75	29	0.90	36	1.12	46	1.38		
		12	9-0648-21	0.8	23	3.00	27	3.60	34	4.50	43	5.40		
		1/2	9/32	3/4	9-0803-21	21.0	39	0.19	47	0.23	59	0.28	63	0.30
				1	9-0804-21	16.5	41	0.25	49	0.30	61	0.37	82	0.50
				1 1/4	9-0805-21	12.9	41	0.31	49	0.38	61	0.47	82	0.63
1 1/2	9-0806-21			10.9	41	0.37	49	0.45	61	0.56	86	0.78		
1 3/4	9-0807-21			9.2	40	0.43	48	0.52	60	0.65	84	0.91		
2	9-0808-21			8.0	40	0.50	48	0.60	60	0.75	84	1.05		
2 1/2	9-0810-21			6.3	40	0.63	48	0.76	60	0.94	82	1.32		
3	9-0812-21			5.0	37	0.75	45	0.90	56	1.12	77	1.54		
3 1/2	9-0814-21			4.3	37	0.88	45	1.05	56	1.31	77	1.81		
4	9-0816-21			3.7	37	1.00	44	1.20	56	1.50	78	2.11		
12	9-0848-21			1.2	37	3.00	45	3.60	56	4.50	79	6.35		
5/8	11/32			3/4	9-1003-21	44.0	84	0.19	101	0.23	123	0.28	141	0.32
		1	9-1004-21	31.8	78	0.25	94	0.30	117	0.37	134	0.42		
		1 1/4	9-1005-21	24.0	74	0.31	91	0.38	113	0.47	127	0.53		
		1 1/2	9-1006-21	20.1	75	0.37	90	0.45	113	0.56	131	0.65		
		1 3/4	9-1007-21	17.4	75	0.43	90	0.52	113	0.65	141	0.81		
		2	9-1008-21	15.4	77	0.50	93	0.60	116	0.75	142	0.92		
		2 1/2	9-1010-21	12.0	76	0.63	91	0.76	113	0.94	143	1.19		
		3	9-1012-21	10.1	76	0.75	91	0.90	113	1.12	144	1.43		
		3 1/2	9-1014-21	8.7	76	0.88	91	1.05	114	1.31	151	1.73		
		4	9-1016-21	7.6	76	1.00	92	1.20	114	1.51	154	2.02		
		4 1/2	9-1018-21	6.7	75	1.12	90	1.35	113	1.69	151	2.26		
		12	9-1048-21	2.4	71	3.00	85	3.60	106	4.50	144	6.00		
3/4	3/8	3/4	9-1203-21	68.5	128	0.19	154	0.23	193	0.28	199	0.29		
		1	9-1204-21	51.5	127	0.25	152	0.30	190	0.37	208	0.40		
		1 1/4	9-1205-21	38.9	123	0.31	147	0.38	184	0.47	198	0.51		
		1 1/2	9-1206-21	31.3	117	0.37	140	0.45	176	0.56	192	0.61		
		1 3/4	9-1207-21	25.8	112	0.43	134	0.52	168	0.65	182	0.71		
		2	9-1208-21	22.2	111	0.50	134	0.60	167	0.75	180	0.81		
		2 1/2	9-1210-21	17.3	109	0.63	131	0.76	163	0.94	177	1.02		
		3	9-1212-21	14.1	105	0.75	127	0.90	158	1.12	173	1.22		
		3 1/2	9-1214-21	12.2	107	0.88	128	1.05	160	1.31	178	1.46		
		4	9-1216-21	10.6	106	1.00	128	1.20	160	1.51	179	1.68		
		4 1/2	9-1218-21	9.3	105	1.13	126	1.36	158	1.70	175	1.88		
		5	9-1220-21	8.3	104	1.25	125	1.50	156	1.88	175	2.09		
5 1/2	9-1222-21	7.5	103	1.37	123	1.64	154	2.05	174	2.30				
6	9-1224-21	6.9	103	1.50	124	1.80	155	2.24	173	2.52				
12	9-1248-21	3.5	104	3.00	125	3.60	156	4.50	180	5.21				

Hole Diam. (in) A	Rod Diam. (in) B	Free Length (in) C	CATALOG NUMBER	RATE Pounds Req'd. to deflect 1/10 in.	LOAD-DEFLECTION TABLE							
					Total Deflection for Long Life (25% of C)		Total Deflection for Avg. Life (30% of C)		Maximum Operating Deflection (37.5% of C)		Total Travel to Solid	
					Load lbs.	Defl. in.	Load lbs.	Defl. in.	Load lbs.	Defl. in.	Load lbs.	Defl. in.
1	1/2	1	9-1604-21	94.9	234	0.25	280	0.30	350	0.37	371	0.39
		1 1/4	9-1605-21	71.2	224	0.31	269	0.38	336	0.47	357	0.50
		1 1/2	9-1606-21	56.3	211	0.37	253	0.45	316	0.56	338	0.60
		1 3/4	9-1607-21	47.5	206	0.43	247	0.52	309	0.65	341	0.72
		2	9-1608-21	41.0	206	0.50	247	0.60	309	0.75	344	0.84
		2 1/2	9-1610-21	31.4	198	0.63	237	0.76	297	0.94	327	1.04
		3	9-1612-21	25.8	193	0.75	232	0.90	289	1.12	325	1.26
		3 1/2	9-1614-21	21.6	189	0.88	227	1.05	284	1.31	317	1.46
		4	9-1616-21	18.8	189	1.00	226	1.20	283	1.51	316	1.68
		4 1/2	9-1618-21	16.7	189	1.13	227	1.36	284	1.70	320	1.92
		5	9-1620-21	15.0	188	1.25	225	1.50	281	1.88	320	2.14
		5 1/2	9-1622-21	13.5	185	1.37	222	1.64	277	2.05	319	2.36
6	9-1624-21	12.4	186	1.50	223	1.80	278	2.24	319	2.58		
7	9-1628-21	10.5	184	1.75	221	2.10	276	2.63	314	3.00		
8	9-1632-21	9.1	182	2.00	218	2.40	273	3.00	312	3.42		
12	9-1648-21	6.0	180	3.00	216	3.60	270	4.50	305	5.11		
1 1/4	5/8	1 1/2	9-2006-21	94.8	355	0.37	425	0.45	532	0.56	569	0.60
		1 3/4	9-2007-21	77.9	337	0.43	405	0.52	506	0.65	550	0.71
		2	9-2008-21	66.3	333	0.50	399	0.60	499	0.75	539	0.81
		2 1/2	9-2010-21	50.1	316	0.63	379	0.76	473	0.94	503	1.00
		3	9-2012-21	40.5	303	0.75	364	0.90	454	1.12	490	1.21
		3 1/2	9-2014-21	34.2	300	0.88	360	1.05	449	1.31	486	1.42
		4	9-2016-21	29.6	297	1.00	357	1.20	446	1.51	484	1.63
		4 1/2	9-2018-21	26.3	298	1.13	357	1.36	447	1.70	491	1.87
		5	9-2020-21	23.7	296	1.25	356	1.50	444	1.88	498	2.10
		5 1/2	9-2022-21	21.4	293	1.37	351	1.64	439	2.05	495	2.31
		6	9-2024-21	19.5	292	1.50	350	1.80	438	2.24	493	2.53
		7	9-2028-21	16.6	291	1.75	349	2.10	436	2.63	489	2.95
8	9-2032-21	14.4	288	2.00	345	2.40	432	3.00	486	3.38		
10	9-2040-21	11.4	285	2.50	342	3.00	428	3.75	483	4.23		
12	9-2048-21	9.5	285	3.00	342	3.60	428	4.50	484	5.10		
1 1/2	3/4	2	9-2408-21	97.4	489	0.50	587	0.60	733	0.75	762	0.78
		2 1/2	9-2410-21	73.5	463	0.63	556	0.76	694	0.94	722	0.98
		3	9-2412-21	60.1	450	0.75	539	0.90	674	1.12	725	1.21
		3 1/2	9-2414-21	50.1	439	0.88	527	1.05	658	1.31	704	1.40
		4	9-2416-21	43.4	436	1.00	523	1.20	654	1.51	707	1.63
		4 1/2	9-2418-21	37.9	429	1.13	515	1.36	643	1.70	693	1.83
		5	9-2420-21	34.0	425	1.25	510	1.50	638	1.88	698	2.05
		5 1/2	9-2422-21	30.6	419	1.37	502	1.64	628	2.05	687	2.25
		6	9-2424-21	27.9	417	1.50	501	1.80	626	2.24	691	2.47
		7	9-2428-21	23.7	415	1.75	498	2.10	623	2.63	687	2.89
		8	9-2432-21	20.6	412	2.00	494	2.40	617	3.00	683	3.32
		10	9-2440-21	16.5	413	2.50	495	3.00	619	3.75	693	4.21
12	9-2448-21	13.6	408	3.00	490	3.60	612	4.50	682	5.03		
2	1	2 1/2	9-3210-21	121.0	762	0.63	915	0.76	1143	0.94	1193	0.99
		3	9-3212-21	95.6	715	0.75	858	0.90	1073	1.12	1130	1.18
		3 1/2	9-3214-21	79.8	699	0.88	839	1.05	1049	1.31	1109	1.39
		4	9-3216-21	69.6	699	1.00	838	1.20	1048	1.51	1131	1.63
		4 1/2	9-3218-21	61.2	693	1.13	831	1.36	1039	1.70	1134	1.85
		5	9-3220-21	54.0	675	1.25	810	1.50	1013	1.88	1105	2.05
		5 1/2	9-3222-21	48.8	668	1.37	801	1.64	1001	2.05	1110	2.27
		6	9-3224-21	44.5	666	1.50	799	1.80	999	2.24	1112	2.50
		7	9-3228-21	37.								

# DieMax XL® Heavy Load Springs – Inch ISO Standard

Hole Diam. (in) A	Rod Diam. (in) B	Free Length (in) C	CATALOG NUMBER	RATE Pounds Req'd. to deflect 1/10 in.	LOAD-DEFLECTION TABLE									
					Total Deflection for Long Life (20% of C)		Total Deflection for Avg. Life (25% of C)		Maximum Operating Deflection (30% of C)		Total Travel to Solid			
					Load lbs.	Defl. in.	Load lbs.	Defl. in.	Load lbs.	Defl. in.	Load lbs.	Defl. in.		
3/8	3/16	3/4	9-0603-26	16.5	25	0.15	31	0.19	37	0.23	41	0.25		
		1	9-0604-26	12.6	25	0.20	31	0.25	37	0.30	46	0.37		
		1 1/4	9-0605-26	10.0	25	0.25	31	0.31	38	0.38	47	0.47		
		1 1/2	9-0606-26	9.3	28	0.30	35	0.37	42	0.45	61	0.66		
		1 3/4	9-0607-26	8.0	28	0.35	35	0.43	42	0.52	62	0.78		
		2	9-0608-26	6.8	27	0.40	34	0.50	41	0.60	60	0.88		
		2 1/2	9-0610-26	5.5	28	0.50	35	0.63	42	0.76	62	1.13		
		3	9-0612-26	4.3	26	0.60	32	0.75	39	0.90	56	1.29		
		12	9-0648-26	1.1	26	2.40	32	3.00	39	3.60	56	5.27		
		1/2	9/32	3/4	9-0803-26	31.0	47	0.15	58	0.19	70	0.23	96	0.31
				1	9-0804-26	23.6	46	0.20	58	0.25	70	0.30	103	0.44
				1 1/4	9-0805-26	18.8	47	0.25	59	0.31	71	0.38	106	0.56
1 1/2	9-0806-26			15.5	46	0.30	58	0.37	70	0.45	107	0.69		
1 3/4	9-0807-26			13.3	46	0.35	58	0.43	69	0.52	109	0.82		
2	9-0808-26			11.4	46	0.40	57	0.50	69	0.60	107	0.94		
2 1/2	9-0810-26			8.7	44	0.50	55	0.63	66	0.76	99	1.14		
3	9-0812-26			7.7	46	0.60	58	0.75	69	0.90	114	1.47		
3 1/2	9-0814-26			6.2	43	0.70	54	0.88	65	1.05	102	1.64		
4	9-0816-26			5.1	41	0.80	51	1.00	61	1.20	94	1.85		
12	9-0848-26			1.8	43	2.40	53	3.00	64	3.60	101	5.71		
5/8	11/32			3/4	9-1003-26	58.0	87	0.15	110	0.19	133	0.23	157	0.27
		1	9-1004-26	43.1	85	0.20	106	0.25	127	0.30	160	0.37		
		1 1/4	9-1005-26	34.8	88	0.25	110	0.31	132	0.38	174	0.50		
		1 1/2	9-1006-26	27.8	83	0.30	104	0.37	125	0.45	167	0.60		
		1 3/4	9-1007-26	24.7	86	0.35	107	0.43	128	0.52	185	0.75		
		2	9-1008-26	20.5	82	0.40	103	0.50	123	0.60	170	0.83		
		2 1/2	9-1010-26	16.5	83	0.50	104	0.63	125	0.76	177	1.07		
		3	9-1012-26	14.0	84	0.60	105	0.75	126	0.90	187	1.33		
		3 1/2	9-1014-26	11.9	83	0.70	104	0.88	125	1.05	187	1.57		
		4	9-1016-26	10.4	84	0.80	104	1.00	125	1.20	187	1.80		
		12	9-1048-26	3.3	80	2.40	100	3.00	120	3.60	181	5.44		
		3/4	3/8	1	9-1204-26	137.0	270	0.20	337	0.25	405	0.30	422	0.31
1 1/4	9-1205-26			103.0	260	0.25	324	0.31	389	0.38	407	0.40		
1 1/2	9-1206-26			82.2	246	0.30	307	0.37	369	0.45	398	0.48		
1 3/4	9-1207-26			68.5	237	0.35	297	0.43	356	0.52	392	0.57		
2	9-1208-26			57.8	232	0.40	290	0.50	348	0.60	371	0.64		
2 1/2	9-1210-26			44.0	222	0.50	277	0.63	333	0.76	344	0.78		
3	9-1212-26			36.2	217	0.60	271	0.75	325	0.90	347	0.96		
3 1/2	9-1214-26			30.8	216	0.70	270	0.88	324	1.05	350	1.13		
4	9-1216-26			26.8	215	0.80	269	1.00	323	1.20	351	1.31		
4 1/2	9-1218-26			23.7	213	0.90	266	1.12	319	1.35	352	1.49		
5	9-1220-26			21.2	212	1.00	265	1.25	318	1.50	353	1.66		
5 1/2	9-1222-26			19.3	213	1.10	266	1.38	319	1.65	354	1.84		
6	9-1224-26	17.6	211	1.20	263	1.50	316	1.80	355	2.01				
12	9-1248-26	8.6	207	2.40	258	3.00	310	3.60	351	4.07				
1	1/2	1	9-1604-26	215.0	423	0.20	529	0.25	—	—	622	0.29		
		1 1/4	9-1605-26	163.0	411	0.25	513	0.31	616	0.38	648	0.40		
		1 1/2	9-1606-26	127.0	380	0.30	475	0.37	570	0.45	602	0.47		
		1 3/4	9-1607-26	109.0	378	0.35	472	0.43	566	0.52	646	0.60		
		2	9-1608-26	89.4	359	0.40	449	0.50	539	0.60	581	0.65		
		2 1/2	9-1610-26	69.1	348	0.50	435	0.63	522	0.76	571	0.83		
		3	9-1612-26	57.0	341	0.60	426	0.75	512	0.90	584	1.02		
		3 1/2	9-1614-26	48.0	336	0.70	420	0.88	505	1.05	575	1.20		
		4	9-1616-26	41.8	336	0.80	420	1.00	504	1.20	584	1.40		
		4 1/2	9-1618-26	37.1	333	0.90	416	1.12	500	1.35	591	1.59		
		5	9-1620-26	33.1	331	1.00	414	1.25	497	1.50	585	1.77		
		5 1/2	9-1622-26	30.0	331	1.10	413	1.38	496	1.65	590	1.97		
6	9-1624-26	27.5	329	1.20	411	1.50	494	1.80	595	2.16				
7	9-1628-26	23.5	329	1.40	412	1.75	494	2.10	602	2.56				
8	9-1632-26	20.5	328	1.60	410	2.00	492	2.40	599	2.93				
12	9-1648-26	13.8	331	2.40	414	3.00	497	3.60	638	4.62				

Hole Diam. (in) A	Rod Diam. (in) B	Free Length (in) C	CATALOG NUMBER	RATE Pounds Req'd. to deflect 1/10 in.	LOAD-DEFLECTION TABLE							
					Total Deflection for Long Life (20% of C)		Total Deflection for Avg. Life (25% of C)		Maximum Operating Deflection (30% of C)		Total Travel to Solid	
					Load lbs.	Defl. in.	Load lbs.	Defl. in.	Load lbs.	Defl. in.	Load lbs.	Defl. in.
1 1/4	5/8	1 1/2	9-2006-26	223.0	667	0.30	834	0.37	1001	0.45	1021	0.46
		1 3/4	9-2007-26	182.0	631	0.35	788	0.43	946	0.52	995	0.55
		2	9-2008-26	154.0	618	0.40	773	0.50	928	0.60	976	0.63
		2 1/2	9-2010-26	117.0	590	0.50	737	0.63	884	0.76	926	0.79
		3	9-2012-26	94.7	567	0.60	708	0.75	850	0.90	916	0.97
		3 1/2	9-2014-26	80.1	561	0.70	702	0.88	842	1.05	926	1.16
		4	9-2016-26	69.1	555	0.80	694	1.00	832	1.20	919	1.33
		4 1/2	9-2018-26	60.7	545	0.90	681	1.12	817	1.35	914	1.50
		5	9-2020-26	54.7	547	1.00	684	1.25	821	1.50	933	1.71
		5 1/2	9-2022-26	49.3	543	1.10	679	1.38	815	1.65	928	1.88
		6	9-2024-26	44.9	537	1.20	672	1.50	806	1.80	923	2.06
		7	9-2028-26	38.1	534	1.40	668	1.75	801	2.10	916	2.41
8	9-2032-26	33.0	527	1.60	659	2.00	791	2.40	910	2.75		
10	9-2040-26	26.4	528	2.00	660	2.50	792	3.00	925	3.51		
12	9-2048-26	21.8	524	2.40	654	3.00	785	3.60	916	4.20		
1 1/2	3/4	2	9-2408-26	208.0	835	0.50	1044	0.50	1253	0.60	1357	0.65
		2 1/2	9-2410-26	153.0	771	0.50	964	0.63	1157	0.76	1233	0.80
		3	9-2412-26	125.0	748	0.60	935	0.75	1122	0.90	1252	1.00
		3 1/2	9-2414-26	105.0	736	0.70	920	0.88	1104	1.05	1265	1.20
		4	9-2416-26	90.6	728	0.80	910	1.00	1091	1.20	1252	1.38
		4 1/2	9-2418-26	80.4	722	0.90	902	1.12	1083	1.35	1285	1.60
		5	9-2420-26	71.5	715	1.00	894	1.25	1073	1.50	1273	1.78
		5 1/2	9-2422-26	64.3	709	1.10	886	1.38	1063	1.65	1263	1.96
		6	9-2424-26	59.0	706	1.20	883	1.50	1059	1.80	1284	2.18
		7	9-2428-26	50.3	705	1.40	881	1.75	1057	2.10	1294	2.57
		8	9-2432-26	43.8	700	1.60	875	2.00	1050	2.40	1299	2.97
		10	9-2440-26	34.6	692	2.00	865	2.50	1038	3.00	1291	3.73
12	9-2448-26	28.7	689	2.40	862	3.00	1034	3.60	1300	4.53		
2	1	2 1/2	9-3210-26	242.0	1220	0.50	1524	0.63	1829	0.76	1904	0.79
		3	9-3212-26	193.0	1155	0.60	1444	0.75	1732	0.90	1860	0.96
		3 1/2	9-3214-26	160.0	1121	0.70	1402	0.88	1682	1.05	1831	1.14
		4	9-3216-26	140.0	1124	0.80	1406	1.00	1687	1.20	1891	1.35
		4 1/2	9-3218-26	123.0	1104	0.90	1380	1.12	1656	1.35	1901	1.55
		5	9-3220-26	108.0	1080	1.00	1350	1.25	1620	1.50	1840	1.71
		5 1/2	9-3222-26	96.4	1063	1.10	1328	1.38	1594	1.65	1797	1.86
		6	9-3224-26	86.0	1053	1.20	1317	1.50	1580	1.80	1812	2.06
		7	9-3228-26	75.0	1051	1.40	1314	1.75	1577	2.10	1836	2.45
		8	9-3232-26	65.3	1044	1.60						

# DieMax XL® Extra Heavy Load Springs – Inch ISO Standard

Hole Diam. (in) A	Rod Diam. (in) B	Free Length (in) C	CATALOG NUMBER	RATE Pounds Req'd. to deflect 1/10 in.	LOAD-DEFLECTION TABLE									
					Total Deflection for Long Life (17% of C)		Total Deflection for Avg. Life (20% of C)		Maximum Operating Deflection (25% of C)		Total Travel to Solid			
					Load lbs.	Defl. in.	Load lbs.	Defl. in.	Load lbs.	Defl. in.	Load lbs.	Defl. in.		
3/8	3/16	3/4	9-0603-36	25.2	32	0.13	38	0.15	47	0.19	53	0.21		
		1	9-0604-36	18.7	31	0.17	37	0.20	46	0.25	54	0.29		
		1 1/4	9-0605-36	14.6	31	0.21	37	0.25	46	0.31	53	0.37		
		1 1/2	9-0606-36	12.1	31	0.25	36	0.30	45	0.37	55	0.45		
		1 3/4	9-0607-36	10.1	30	0.29	35	0.35	44	0.43	52	0.51		
		2	9-0608-36	8.8	30	0.34	35	0.40	44	0.50	52	0.59		
		2 1/2	9-0610-36	7.0	30	0.43	35	0.50	44	0.63	52	0.75		
		3	9-0612-36	5.8	30	0.51	35	0.60	43	0.75	53	0.92		
		12	9-0648-36	1.4	29	2.04	34	2.40	42	3.00	50	3.60		
		1/2	9/32	3/4	9-0803-36	44.5	57	0.13	67	0.15	83	0.19	102	0.23
				1	9-0804-36	33.5	56	0.17	66	0.20	82	0.25	105	0.31
				1 1/4	9-0805-36	25.2	54	0.21	63	0.25	79	0.31	97	0.38
1 1/2	9-0806-36			20.7	53	0.25	62	0.30	77	0.37	97	0.47		
1 3/4	9-0807-36			17.5	52	0.29	61	0.35	76	0.43	98	0.56		
2	9-0808-36			15.4	53	0.34	62	0.40	77	0.50	103	0.67		
2 1/2	9-0810-36			12.4	53	0.43	62	0.50	78	0.63	102	0.82		
3	9-0812-36			10.1	51	0.51	60	0.60	76	0.75	100	0.99		
3 1/2	9-0814-36			8.6	51	0.60	60	0.70	75	0.88	100	1.16		
4	9-0816-36			7.4	50	0.68	59	0.80	74	1.00	96	1.30		
12	9-0848-36			2.4	49	2.04	58	2.40	72	3.00	96	4.02		
5/8	11/32			3/4	9-1003-36	97.0	124	0.13	146	0.15	182	0.19	213	0.22
		1	9-1004-36	72.7	122	0.17	143	0.20	179	0.25	225	0.31		
		1 1/4	9-1005-36	53.7	115	0.21	135	0.25	169	0.31	205	0.38		
		1 1/2	9-1006-36	43.3	110	0.25	130	0.30	162	0.37	201	0.46		
		1 3/4	9-1007-36	36.3	107	0.29	126	0.35	157	0.43	199	0.55		
		2	9-1008-36	31.7	108	0.34	127	0.40	159	0.50	205	0.65		
		2 1/2	9-1010-36	24.7	106	0.43	124	0.50	156	0.63	201	0.81		
		3	9-1012-36	20.3	103	0.51	121	0.60	152	0.75	199	0.98		
		3 1/2	9-1014-36	17.3	103	0.60	121	0.70	152	0.88	201	1.16		
		4	9-1016-36	15.1	103	0.68	121	0.80	152	1.00	203	1.35		
		12	9-1048-36	4.9	100	2.04	117	2.40	146	3.00	204	4.17		
		3/4	3/8	1	9-1204-36	183.0	306	0.17	360	0.20	450	0.25	476	0.26
1 1/4	9-1205-36			137.0	293	0.21	345	0.25	431	0.31	461	0.34		
1 1/2	9-1206-36			111.0	282	0.25	332	0.30	415	0.37	472	0.43		
1 3/4	9-1207-36			92.4	272	0.29	320	0.35	400	0.43	466	0.50		
2	9-1208-36			79.7	272	0.34	320	0.40	400	0.50	473	0.59		
2 1/2	9-1210-36			62.1	266	0.43	313	0.50	391	0.63	472	0.76		
3	9-1212-36			51.2	260	0.51	306	0.60	383	0.75	481	0.94		
3 1/2	9-1214-36			43.2	257	0.60	303	0.70	378	0.88	474	1.10		
4	9-1216-36			37.3	255	0.68	300	0.80	374	1.00	468	1.25		
4 1/2	9-1218-36			32.8	250	0.76	294	0.90	368	1.12	464	1.41		
5	9-1220-36			29.5	251	0.85	295	1.00	369	1.25	469	1.59		
5 1/2	9-1222-36			26.6	249	0.94	293	1.10	367	1.38	466	1.75		
6	9-1224-36	24.3	247	1.02	291	1.20	364	1.50	463	1.91				
12	9-1248-36	12.0	245	2.04	288	2.40	360	3.00	469	3.92				

Hole Diam. (in) A	Rod Diam. (in) B	Free Length (in) C	CATALOG NUMBER	RATE Pounds Req'd. to deflect 1/10 in.	LOAD-DEFLECTION TABLE								
					Total Deflection for Long Life (17% of C)		Total Deflection for Avg. Life (20% of C)		Maximum Operating Deflection (25% of C)		Total Travel to Solid		
					Load lbs.	Defl. in.	Load lbs.	Defl. in.	Load lbs.	Defl. in.	Load lbs.	Defl. in.	
1	1/2	1	9-1604-36	270.0	459	0.17	540	0.20	675	0.25	864	0.32	
		1 1/4	9-1605-36	202.0	433	0.21	509	0.25	636	0.31	709	0.35	
		1 1/2	9-1606-36	160.0	407	0.25	479	0.30	598	0.37	692	0.43	
		1 3/4	9-1607-36	132.0	389	0.29	457	0.35	572	0.43	686	0.52	
		2	9-1608-36	113.0	386	0.34	454	0.40	567	0.50	681	0.60	
		2 1/2	9-1610-36	87.8	376	0.43	442	0.50	553	0.63	684	0.78	
		3	9-1612-36	71.4	363	0.51	427	0.60	534	0.75	676	0.95	
		3 1/2	9-1614-36	60.2	359	0.60	422	0.70	527	0.88	671	1.11	
		4	9-1616-36	52.0	355	0.68	418	0.80	522	1.00	667	1.28	
		4 1/2	9-1618-36	46.2	353	0.76	415	0.90	518	1.12	681	1.47	
		5	9-1620-36	41.2	350	0.85	412	1.00	515	1.25	677	1.64	
		5 1/2	9-1622-36	37.5	351	0.94	413	1.10	516	1.38	686	1.83	
	6	9-1624-36	34.4	351	1.02	413	1.20	516	1.50	695	2.02		
	7	9-1628-36	29.3	349	1.19	410	1.40	513	1.75	697	2.38		
	8	9-1632-36	25.5	347	1.36	408	1.60	510	2.00	700	2.74		
	12	9-1648-36	16.9	345	2.04	406	2.40	507	3.00	676	4.00		
	1 1/4	5/8	1 1/2	9-2006-36	279.0	710	0.25	835	0.30	1044	0.37	1093	0.39
			1 3/4	9-2007-36	231.0	680	0.29	800	0.35	1000	0.43	1088	0.48
			2	9-2008-36	197.0	672	0.34	791	0.40	989	0.50	1119	0.57
			2 1/2	9-2010-36	152.0	651	0.43	766	0.50	957	0.63	1139	0.75
			3	9-2012-36	123.0	626	0.51	736	0.60	920	0.75	1121	0.91
			3 1/2	9-2014-36	104.0	619	0.60	729	0.70	911	0.88	1131	1.09
			4	9-2016-36	88.9	607	0.68	714	0.80	893	1.00	1100	1.24
			4 1/2	9-2018-36	77.5	591	0.76	696	0.90	870	1.12	1071	1.38
			5	9-2020-36	69.6	592	0.85	696	1.00	870	1.25	1090	1.57
			5 1/2	9-2022-36	63.6	596	0.94	701	1.10	876	1.38	1128	1.77
			6	9-2024-36	57.6	586	1.02	689	1.20	862	1.50	1108	1.92
			7	9-2028-36	48.9	583	1.19	685	1.40	857	1.75	1099	2.25
	8	9-2032-36	42.6	579	1.36	681	1.60	851	2.00	1111	2.61		
	10	9-2040-36	34.0	578	1.70	680	2.00	850	2.50	1128	3.32		
	12	9-2048-36	28.3	578	2.04	680	2.40	850	3.00	1139	4.03		
	1 1/2	3/4	2	9-2408-36	319.0	1089	0.34	1281	0.40	1601	0.50	1757	0.55
			2 1/2	9-2410-36	241.0	1032	0.43	1214	0.50	1518	0.63	1726	0.72
			3	9-2412-36	193.0	982	0.51	1155	0.60	1444	0.75	1698	0.88
			3 1/2	9-2414-36	160.0	953	0.60	1121	0.70	1402	0.88	1636	1.03
			4	9-2416-36	139.0	949	0.68	1116	0.80	1395	1.00	1710	1.23
4 1/2			9-2418-36	122.0	931	0.76	1095	0.90	1369	1.12	1700	1.39	
5			9-2420-36	108.0	918	0.85	1080	1.00	1350	1.25	1687	1.56	
5 1/2			9-2422-36	97.6	915	0.94	1076	1.10	1345	1.38	1681	1.72	
6			9-2424-36	88.7	902	1.02	1062	1.20	1327	1.50	1672	1.89	
7			9-2428-36	75.0	894	1.19	1051	1.40	1314	1.75	1662	2.22	
8			9-2432-36	65.0	883	1.36	1039	1.60	1299	2.00	1655	2.55	
10			9-2440-36	51.6	877	1.70	1032	2.00	1290	2.50	1675	3.24	
12	9-2448-36	42.8	874	2.04	1028	2.40	1285	3.00	1686	3.94			
2	1	2 1/2	9-3210-36	414.0	1773	0.43	2086	0.50	2608	0.63	2818	0.68	
		3	9-3212-36	327.0	1663	0.51	1957	0.60	2446	0.75	2743	0.84	
		3 1/2	9-3214-36	271.0	1614	0.60	1899	0.70	2374	0.88	2694	1.00	
		4	9-3216-36	231.0	1577	0.68	1855	0.80	2319	1.00	2659	1.15	
		4 1/2	9-3218-36	201.0	1534	0.76	1804	0.90	2255	1.12	2644	1.31	
		5	9-3220-36	179.0	1522	0.85	1790	1.00	2238	1.25	2623	1.47	
		5 1/2	9-3222-36	161.0	1509	0.94	1775	1.10	2219	1.38	2659	1.65	
		6	9-3224-36	145.0	1475	1.02	1735	1.20	2169	1.50	2593	1.78	
		7	9-3228-36	123.0	1465	1.19	1724	1.40	2155	1.75	2578	2.10	

# DieMax XL<sup>®</sup> Ultra Heavy Load Springs – Inch Standard

Hole Diam. (in) A	Rod Diam. (in) B	Free Length (in) C	CATALOG NUMBER	RATE Pounds Req'd. to deflect 1/10 in.	LOAD-DEFLECTION TABLE									
					Total Deflection for Long Life (10% of C)		Total Deflection for Avg. Life (12% of C)		Maximum Operating Deflection (15% of C)		Total Travel to Solid			
					Load lbs.	Defl. in.	Load lbs.	Defl. in.	Load lbs.	Defl. in.	Load lbs.	Defl. in.		
1	1/2	2 1/2	9-1610-51	368.0	927	0.25	1116	0.30	1391	0.38	1877	0.51		
		3	9-1612-51	317.8	951	0.30	1139	0.36	1426	0.45	2002	0.63		
		3 1/2	9-1614-51	264.0	925	0.35	1112	0.42	1388	0.53	2086	0.79		
		4	9-1616-51	222.9	895	0.40	1071	0.48	1343	0.60	2028	0.91		
		4 1/2	9-1618-51	205.7	932	0.45	1118	0.54	1397	0.68	2098	1.02		
		5	9-1620-51	186.3	932	0.50	1115	0.60	1397	0.75	2049	1.10		
		6	9-1624-51	145.7	872	0.60	1044	0.72	1308	0.90	1952	1.34		
		7	9-1628-51	131.4	921	0.70	1107	0.84	1382	1.05	2024	1.54		
		8	9-1632-51	115.4	923	0.80	1109	0.96	1384	1.20	2043	1.77		
		12	9-1648-51	77.7	933	1.20	1120	1.44	1400	1.80	1927	2.48		
		1 1/4	5/8	2 1/2	9-2010-51	615.5	1551	0.25	1861	0.30	2326	0.38	3139	0.51
				3	9-2012-51	499.5	1494	0.30	1793	0.36	2242	0.45	3147	0.63
3 1/2	9-2014-51			412.1	1444	0.35	1733	0.43	2166	0.53	3256	0.79		
4	9-2016-51			354.3	1423	0.39	1708	0.47	2134	0.60	3224	0.91		
4 1/2	9-2018-51			320.0	1449	0.47	1739	0.55	2174	0.68	3264	1.02		
5	9-2020-51			283.5	1417	0.51	1701	0.59	2126	0.75	3119	1.10		
6	9-2024-51			233.2	1395	0.59	1674	0.71	2093	0.90	3125	1.34		
7	9-2028-51			201.7	1413	0.71	1696	0.83	2120	1.05	3106	1.54		
8	9-2032-51			173.7	1388	0.79	1666	0.94	2083	1.20	3074	1.77		
10	9-2040-51			138.9	1390	0.98	1668	1.18	2085	1.50	3389	2.44		
12	9-2048-51			112.0	1345	1.22	1614	1.46	2018	1.80	3304	2.95		

Hole Diam. (in) A	Rod Diam. (in) B	Free Length (in) C	CATALOG NUMBER	RATE Pounds Req'd. to deflect 1/10 in.	LOAD-DEFLECTION TABLE									
					Total Deflection for Long Life (10% of C)		Total Deflection for Avg. Life (12% of C)		Maximum Operating Deflection (15% of C)		Total Travel to Solid			
					Load lbs.	Defl. in.	Load lbs.	Defl. in.	Load lbs.	Defl. in.	Load lbs.	Defl. in.		
1 1/2	3/4	3 1/2	9-2414-51	502.9	1762	0.35	2119	0.42	2643	0.53	3973	0.79		
		4	9-2416-51	435.5	1749	0.40	2092	0.48	2623	0.60	3963	0.91		
		4 1/2	9-2418-51	388.0	1757	0.45	2108	0.54	2635	0.68	3958	1.02		
		5	9-2420-51	355.5	1777	0.50	2127	0.60	2666	0.75	3911	1.10		
		6	9-2424-51	290.9	1741	0.90	2084	0.72	2611	0.90	4131	1.42		
		7	9-2428-51	245.2	1718	0.70	2066	0.84	2577	1.05	4144	1.69		
		8	9-2432-51	213.7	1708	0.80	2053	0.96	2562	1.20	4124	1.93		
		10	9-2440-51	169.2	1692	1.00	2031	1.20	2538	1.50	4128	2.44		
		12	9-2448-51	140.6	1694	1.20	2026	1.44	2532	1.80	4148	2.95		
		2	1	3 1/2	9-3214-51	805.8	2824	0.35	3395	0.42	4235	0.53	6044	0.75
				4	9-3216-51	694.4	2788	0.40	3335	0.48	4183	0.60	6041	0.87
				4 1/2	9-3218-51	614.9	2784	0.45	3341	0.54	4176	0.68	6026	0.98
5	9-3220-51			553.2	2766	0.50	3311	0.60	4149	0.75	6085	1.10		
6	9-3224-51			460.6	2756	0.60	3301	0.72	4135	0.90	6172	1.34		
7	9-3228-51			398.9	2795	0.70	3361	0.84	4193	1.05	6263	1.57		
8	9-3232-51			349.8	2795	0.80	3360	0.96	4193	1.20	6191	1.77		
10	9-3240-51			269.7	2698	1.00	3239	1.20	4046	1.50	6149	2.28		
12	9-3248-51	221.7	2663	1.20	3195	1.44	3994	1.80	6119	2.76				

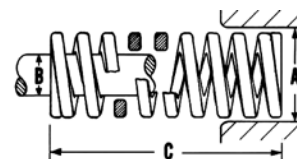

### Product Features:

- ◆ Color – Silver
- ◆ High tensile strength chrome silicon
- ◆ Optimal rectangular wire design
- ◆ Long life design

Note: All springs are available unpainted by adding the suffix "NP" to the end of the part number.

# DieMax XL<sup>®</sup> Extra Light Load Springs – Metric Standard

Hole Diam. (mm) A	Rod Diam. (mm) B	Free Length (mm) C	CATALOG NUMBER	RATE Newtons Req'd. to deflect 1 mm	LOAD-DEFLECTION TABLE							
					Total Deflection for Long Life (30% of C)		Total Deflection for Avg. Life (40% of C)		Maximum Operating Deflection (50% of C)		Total Travel to Solid	
					Load N	Defl. mm	Load N	Defl. mm	Load N	Defl. mm	Load N	Defl. mm
20	8	25	9-1204-06	29.4	221	7.5	294	10.0	368	12.5	409	13.9
		32	9-1205-06	22.6	217	9.6	289	12.8	362	16.0	411	18.2
		38	9-1206-06	18.6	212	11.4	283	15.2	353	19.0	409	22.0
		44	9-1207-06	15.7	207	13.2	276	17.6	345	22.0	405	25.8
		51	9-1208-06	13.7	210	15.3	279	20.4	349	25.5	415	30.3
		64	9-1210-06	11.3	217	19.2	289	25.6	362	32.0	440	38.9
		76	9-1212-06	9.8	223	22.8	298	30.4	372	38.0	461	47.0
		89	9-1214-06	8.3	222	26.7	295	35.6	369	44.5	462	55.7
		102	9-1216-06	7.4	226	30.6	302	40.8	377	51.0	475	64.2
		115	9-1218-06	6.4	221	34.5	294	46.0	368	57.5	467	72.9
		127	9-1220-06	5.9	225	38.1	300	50.8	375	63.5	476	80.7
		139	9-1222-06	5.4	225	41.7	300	55.6	375	69.5	477	88.4
		152	9-1224-06	4.9	223	45.6	298	60.8	372	76.0	474	96.7
		305	9-1248-06	2.5	229	91.5	305	122	381	153	490	196
		25	12.5	25	9-1604-06	53.9	404	7.5	539	10.0	674	12.5
32	9-1605-06			42.2	405	9.6	540	12.8	675	16.0	726	17.2
38	9-1606-06			35.8	408	11.4	544	15.2	680	19.0	741	20.7
44	9-1607-06			31.4	414	13.2	553	17.6	691	22.0	766	24.4
51	9-1608-06			27.0	413	15.3	551	20.4	689	25.5	770	28.5
64	9-1610-06			21.6	415	19.2	553	25.6	691	32.0	788	36.5
76	9-1612-06			18.1	413	22.8	550	30.4	688	38.0	795	43.9
89	9-1614-06			15.2	406	26.7	541	35.6	676	44.5	781	51.4
102	9-1616-06			13.2	404	30.6	539	40.8	673	51.0	783	59.3
115	9-1618-06			11.8	407	34.5	543	46.0	679	57.5	793	67.2
127	9-1620-06			10.6	404	38.1	538	50.8	673	63.5	789	74.4
139	9-1622-06			9.6	400	41.7	534	55.6	667	69.5	783	81.6
152	9-1624-06			8.8	401	45.6	535	60.8	669	76.0	788	89.5
178	9-1628-06			7.6	406	53.4	541	71.2	676	89.0	798	105
203	9-1632-06			6.7	408	60.9	544	81.2	680	102	811	121
305	9-1648-06	4.4	403	91.5	537	122	671	153	801	182		
32	16	38	9-2006-06	43.1	491	11.4	655	15.2	819	19.0	858	19.9
		44	9-2007-06	37.3	492	13.2	656	17.6	821	22.0	877	23.5
		51	9-2008-06	32.4	496	15.3	661	20.4	826	25.5	894	27.6
		64	9-2010-06	25.5	490	19.2	653	25.6	816	32.0	898	35.2
		76	9-2012-06	21.6	492	22.8	657	30.4	821	38.0	916	42.4
		89	9-2014-06	18.1	483	26.7	644	35.6	805	44.5	905	50.0
		102	9-2016-06	15.7	480	30.6	641	40.8	801	51.0	904	57.6
		115	9-2018-06	14.2	490	34.5	653	46.0	817	57.5	930	65.5
		127	9-2020-06	12.7	484	38.1	645	50.8	806	63.5	921	72.5
		139	9-2022-06	11.6	484	41.7	645	55.6	806	69.5	921	79.4
		152	9-2024-06	10.6	483	45.6	644	60.8	806	76.0	925	87.3
		178	9-2028-06	9.0	481	53.4	641	71.2	801	89.0	927	103
		203	9-2032-06	7.8	475	60.9	633	81.2	792	102	920	118
		254	9-2040-06	6.4	488	76.2	650	102	813	127	947	148
		305	9-2048-06	5.3	485	91.5	647	122	808	153	943	178

Hole Diam. (mm) A	Rod Diam. (mm) B	Free Length (mm) C	CATALOG NUMBER	RATE Newtons Req'd. to deflect 1 mm	LOAD-DEFLECTION TABLE									
					Total Deflection for Long Life (30% of C)		Total Deflection for Avg. Life (40% of C)		Maximum Operating Deflection (50% of C)		Total Travel to Solid			
					Load N	Defl. mm	Load N	Defl. mm	Load N	Defl. mm	Load N	Defl. mm		
40	20	51	9-2408-06	48.1	736	15.3	981	20.4	1227	25.5	1347	28.0		
		64	9-2410-06	39.2	753	19.2	1004	25.6	1254	32.0	1419	36.2		
		76	9-2412-06	33.3	759	22.8	1012	30.4	1265	38.0	1455	43.7		
		89	9-2414-06	28.4	758	26.7	1011	35.6	1264	44.5	1468	51.7		
		102	9-2416-06	24.5	750	30.6	1000	40.8	1250	51.0	1465	59.8		
		115	9-2418-06	22.1	762	34.5	1017	46.0	1271	57.5	1501	67.9		
		127	9-2420-06	19.6	747	38.1	996	50.8	1245	63.5	1474	75.2		
		139	9-2422-06	17.7	738	41.7	984	55.6	1230	69.5	1458	82.4		
		152	9-2424-06	16.2	739	45.6	985	60.8	1231	76.0	1468	90.6		
		178	9-2428-06	13.7	732	53.4	975	71.2	1219	89.0	1452	106		
		203	9-2432-06	12.3	749	60.9	999	81.2	1248	101	1501	122		
		254	9-2440-06	9.8	747	76.2	996	102	1245	127	1509	154		
		305	9-2448-06	8.3	759	91.5	1013	122	1266	152	1536	185		
		50	25	64	9-3210-06	86.3	1657	19.2	2209	25.6	2762	32.0	3029	35.1
				76	9-3212-06	70.6	1610	22.8	2146	30.4	2683	38.0	2979	42.2
89	9-3214-06			59.8	1597	26.7	2129	35.6	2661	44.5	3008	50.3		
102	9-3216-06			52.0	1591	30.6	2122	40.8	2652	51.0	3037	58.4		
115	9-3218-06			46.1	1590	34.5	2121	46.0	2651	57.5	3047	66.1		
127	9-3220-06			42.2	1608	38.1	2144	50.8	2680	63.5	3114	73.8		
139	9-3222-06			38.2	1593	41.7	2124	55.6	2655	69.5	3090	80.9		
152	9-3224-06			34.3	1564	45.6	2085	60.8	2607	76.0	3053	89.0		
178	9-3228-06			29.4	1570	53.4	2093	71.2	2617	89.0	3087	105		
203	9-3232-06			25.5	1553	60.9	2071	81.2	2588	101	3086	121		
254	9-3240-06			20.6	1570	76.2	2093	102	2616	127	3131	152		
305	9-3248-06			17.2	1574	91.5	2098	122	2623	152	3165	184		

\*Note: 1 Newton=0.10197 Kg (Force)



## Product Features:

- ◆ Color – Light Green
- ◆ High tensile strength chrome silicon
- ◆ Optimal rectangular wire design
- ◆ Long life design

# DieMax XL<sup>®</sup> Light Load Springs – Metric ISO Standard

Hole Diam. (mm) A	Rod Diam. (mm) B	Free Length (mm) C	CATALOG NUMBER	RATE Newtons Req. to deflect 1 mm	LOAD-DEFLECTION TABLE							
					Total Deflection for Long Life (25% of C)		Total Deflection for Avg. Life (30% of C)		Maximum Operating Deflection (40% of C)		Total Travel to Solid	
					Load N	Defl. mm	Load N	Defl. mm	Load N	Defl. mm	Load N	Defl. mm
10	5	19	9-0603-11	15.9	76	4.75	91	5.7	121	7.6	154	9.7
		25	9-0604-11	11.0	69	6.3	83	7.5	110	10.0	140	12.7
		32	9-0605-11	8.8	70	8.0	84	9.6	112	12.8	141	16.0
		38	9-0606-11	7.4	70	9.5	84	11.4	112	15.2	145	19.6
		44	9-0607-11	6.3	69	11.0	83	13.2	111	17.6	142	22.6
		51	9-0608-11	5.4	68	12.8	82	15.3	109	20.4	140	25.9
		64	9-0610-11	4.5	72	16.0	86	19.2	115	25.6	149	33.0
		76	9-0612-11	3.7	71	19.0	85	22.8	113	30.4	147	39.6
		305	9-0648-11	0.9	65	76.3	79	91.5	105	122.0	143	158.5
12.5	7	19	9-0803-11	26.3	125	4.75	150	5.7	200	7.6	263	10.0
		25	9-0804-11	19.1	119	6.3	143	7.5	191	10.0	246	12.7
		32	9-0805-11	16.5	132	8.0	158	9.6	211	12.8	289	17.5
		38	9-0806-11	13.7	130	9.5	156	11.4	208	15.2	301	22.0
		44	9-0807-11	11.6	127	11.0	153	13.2	203	17.6	300	25.9
		51	9-0808-11	10.2	130	12.8	155	15.3	207	20.4	298	29.2
		64	9-0810-11	8.2	131	16.0	157	19.2	209	25.6	304	37.1
		76	9-0812-11	6.2	118	19.0	142	22.8	190	30.4	268	43.2
		89	9-0814-11	5.3	119	22.3	143	26.7	190	35.6	269	50.8
		102	9-0816-11	4.7	118	25.2	144	30.6	192	40.8	270	57.4
305	9-0848-11	1.5	112	76.3	135	91.5	179	122.0	240	160.0		
16	8.5	19	9-1003-11	42.0	200	4.75	239	5.7	319	7.6	382	9.1
		25	9-1004-11	31.5	197	6.3	236	7.5	315	10.0	400	12.7
		32	9-1005-11	24.5	196	8.0	235	9.6	314	12.8	402	16.4
		38	9-1006-11	21.0	200	9.5	240	11.4	319	15.2	433	20.6
		44	9-1007-11	17.5	193	11.0	231	13.2	308	17.6	432	25.0
		51	9-1008-11	16.3	208	12.8	249	15.3	332	20.4	477	29.0
		64	9-1010-11	12.6	202	16.0	242	19.2	323	25.6	466	37.0
		76	9-1012-11	10.3	196	19.0	236	22.8	314	30.4	456	44.0
		89	9-1014-11	9.3	207	22.3	248	26.7	330	35.6	493	53.0
		102	9-1016-11	8.2	210	25.2	252	30.6	336	40.8	506	61.0
		115	9-1018-11	7.2	205	28.5	246	34.2	328	45.6	490	68.0
		305	9-1048-11	2.6	200	76.3	240	91.5	320	122.0	484	184.0
		20	10	19	9-1203-11	74.4	353	4.75	424	5.7	565	7.6
25	9-1204-11			56.0	350	6.3	420	7.5	560	10.0	703	12.6
32	9-1205-11			42.7	342	8.0	410	9.6	547	12.8	678	15.9
38	9-1206-11			33.8	321	9.5	385	11.4	514	15.2	640	18.9
44	9-1207-11			28.4	312	11.0	375	13.2	499	17.6	632	22.0
51	9-1208-11			24.9	317	12.8	380	15.3	507	20.4	641	26.0
64	9-1210-11			19.3	308	16.0	370	19.2	493	25.6	619	32.0
76	9-1212-11			16.1	306	19.0	367	22.8	490	30.4	633	39.0
89	9-1214-11			13.5	300	22.3	360	26.7	480	35.6	610	45.0
102	9-1216-11			11.9	304	25.2	364	30.6	486	40.8	622	53.0
115	9-1218-11			10.5	299	28.5	359	34.2	479	45.6	624	59.0
127	9-1220-11			9.3	295	31.8	354	38.1	472	50.8	609	66.0
139	9-1222-11			8.5	297	35.0	357	42.0	476	56.0	618	73.0
152	9-1224-11			7.9	299	38.0	359	45.6	479	60.8	634	80.0
305	9-1248-11			3.8	288	76.3	346	91.5	462	122.0	601	159.0
25	12.5	25	9-1604-11	107.2	670	6.3	804	7.5	1072	10.0	1315	12.3
		32	9-1605-11	80.9	647	8.0	777	9.6	1036	12.8	1265	15.6
		38	9-1606-11	64.8	616	9.5	739	11.4	985	15.2	1230	19.0
		44	9-1607-11	53.6	589	11.0	707	13.2	943	17.6	1190	22.0
		51	9-1608-11	46.4	592	12.8	710	15.3	947	20.4	1196	26.0
		64	9-1610-11	35.7	572	16.0	686	19.2	915	25.6	1148	32.0
		76	9-1612-11	29.4	559	19.0	671	22.8	894	30.4	1139	38.1
		89	9-1614-11	24.7	549	22.3	659	26.7	879	35.6	1115	44.5
		102	9-1616-11	21.2	540	25.2	648	30.6	865	40.8	1098	51.0
		115	9-1618-11	18.7	534	28.5	641	34.2	855	45.6	1085	57.2
		127	9-1620-11	16.8	534	31.8	641	38.1	854	50.8	1087	64.0
		139	9-1622-11	15.2	533	35.0	640	42.0	853	56.0	1100	71.1
		152	9-1624-11	14.0	532	38.0	639	45.6	852	60.8	1111	79.0
		178	9-1628-11	12.1	538	44.5	645	53.4	860	71.2	1119	92.2
		203	9-1632-11	10.5	533	50.8	640	60.9	853	81.2	1125	106.0
305	9-1648-11	7.0	534	76.3	641	91.5	855	122.0	1129	158.0		

Hole Diam. (mm) A	Rod Diam. (mm) B	Free Length (mm) C	CATALOG NUMBER	RATE Newtons Req. to deflect 1 mm	LOAD-DEFLECTION TABLE									
					Total Deflection for Long Life (25% of C)		Total Deflection for Avg. Life (30% of C)		Maximum Operating Deflection (40% of C)		Total Travel to Solid			
					Load N	Defl. mm	Load N	Defl. mm	Load N	Defl. mm	Load N	Defl. mm		
32	16	38	9-2006-11	101.4	963	9.5	1156	11.4	1541	15.2	1838	18.1		
		44	9-2007-11	83.2	915	11.0	1098	13.2	1464	17.6	1765	21.0		
		51	9-2008-11	71.3	909	12.8	1091	15.3	1454	20.4	1746	25.0		
		64	9-2010-11	55.0	880	16.0	1056	19.2	1408	25.6	1700	31.0		
		76	9-2012-11	46.1	875	19.0	1050	22.8	1400	30.4	1756	38.0		
		89	9-2014-11	38.9	865	22.3	1038	26.7	1384	35.6	1739	45.0		
		102	9-2016-11	33.6	857	25.5	1029	30.6	1372	40.8	1727	51.0		
		115	9-2018-11	29.6	844	28.8	1012	34.2	1350	45.6	1718	58.0		
		127	9-2020-11	26.3	834	31.8	1001	38.1	1335	50.8	1686	64.0		
		139	9-2022-11	23.6	827	35.0	993	42.0	1324	56.0	1661	70.0		
		152	9-2024-11	21.5	819	38.0	982	45.6	1310	60.8	1661	77.0		
		178	9-2028-11	18.2	811	44.5	973	53.4	1297	71.2	1642	90.0		
		203	9-2032-11	15.9	809	50.8	971	60.9	1294	81.2	1629	103.0		
		254	9-2040-11	12.6	801	63.5	961	76.2	1281	101.6	1599	128.0		
		305	9-2048-11	10.3	788	76.3	945	91.5	1261	122.0	1589	153.0		
		40	20	51	9-2408-11	105.6	1346	12.8	1616	15.3	2154	20.4	2596	25.0
				64	9-2410-11	80.2	1283	16.0	1540	19.2	2053	25.6	2481	31.0
				76	9-2412-11	65.7	1248	19.0	1497	22.8	1996	30.4	2482	38.0
89	9-2414-11			55.7	1239	22.3	1487	26.7	1983	35.6	2488	45.0		
102	9-2416-11			47.8	1219	25.5	1463	30.6	1951	40.8	2435	51.0		
115	9-2418-11			42.2	1203	28.5	1443	34.2	1925	45.6	2441	58.0		
127	9-2420-11			37.8	1201	31.8	1441	38.1	1922	50.8	2449	65.0		
139	9-2422-11			34.0	1189	35.0	1427	42.0	1903	56.0	2415	71.0		
152	9-2424-11			30.8	1171	38.0	1406	45.6	1874	60.8	2388	77.0		
178	9-2428-11			26.3	1169	44.5	1403	53.4	1870	71.2	2374	91.0		
203	9-2432-11			22.6	1147	50.8	1376	60.9	1834	81.2	2339	103.0		
254	9-2440-11			18.0	1145	63.5	1375	76.2	1833	101.6	2331	130.0		
305	9-2448-11			14.7	1122	76.3	1346	91.5	1795	122.0	2293	155.0		
50	25			64	9-3210-11	157.4	2519	16.0	3023	19.2	4031	25.6	4874	31.0
				76	9-3212-11	126.1	2396	19.0	2875	22.8	3833	30.4	4741	37.6
		89	9-3214-11	105.4	2346	22.3	2815	26.7	3753	35.6	4652	44.2		
		102	9-3216-11	89.7	2287	25.5	2744	30.6	3658	40.8	4575	51.0		
		115	9-3218-11	78.6	2241	28.5	2689	34.2	3586	45.6	4475	56.9		
		127	9-3220-11	70.1	2224	31.8	2669	38.1	3559	50.8	4449	64.0		
		139	9-3222-11	63.0	2207	35.0	2648	42.0	3531	56.0	4421	70.0		
		152	9-3224-11	57.4	2183	38.0	2619	45.6	3493	60.8	4404	77.0		
		178	9-3228-11	48.7	2167	44.5	2600	53.4	3466	71.2	4373	90.0		
		203	9-3232-11	41.7	2115	50.8	2538	60.9	3385	81.2	4231	102.0		
63	38	254	9-3240-11	32.9	2091	63.5	2509	76.2	3345	101.6	4224	128.0		
		305	9-3248-11	27.1	2070	76.3	2484	91.5	3312	122.0	4180	154.0		
		76	9-4012-11	192.6	3660	19.0	4392	22.8	5856	30.4	6976	36.0		
		89	9-4014-11	157.4	3503	22.3	4204	26.7	5605	35.6	6726	43.0		
		102	9-4016-11	133.5	3403	25.5	4084	30.6	5445	40.8	6552	49.0		
		115	9-4018-11	115.6	3294	28.5	3953	34.2	5271	45.6	6404	55.0		
		127	9-4020-11	103.0	3270	31.8	3923	38.1	5231	50.8	6412	62.0		
		152	9-4024-11	83.4	3168	38.0	3801	45.6	5068	60.8	6254	75.0		
		178	9-4028-11	70.1	3117	44.5	3741	53.4	4988	71.2				

# DieMax XL<sup>®</sup> Medium Load Springs – Metric ISO Standard

Hole Diam. (mm) A	Rod Diam. (mm) B	Free Length (mm) C	CATALOG NUMBER	RATE Newtons Req'd. to deflect 1 mm	LOAD-DEFLECTION TABLE							
					Total Deflection for Long Life (25% of C)		Total Deflection for Avg. Life (30% of C)		Maximum Operating Deflection (37.5% of C)		Total Travel to Solid	
					Load N	Defl. mm	Load N	Defl. mm	Load N	Defl. mm	Load N	Defl. mm
10	5	19	9-0603-21	22.8	108	4.75	130	5.7	163	7.13	173	7.6
		25	9-0604-21	16.8	106	6.3	126	7.5	158	9.4	183	10.9
		32	9-0605-21	14.0	112	8.0	135	9.6	168	12.0	196	14.0
		38	9-0606-21	11.7	111	9.5	134	11.4	167	14.3	195	16.7
		44	9-0607-21	9.8	108	11.0	129	13.2	162	16.5	192	19.6
		51	9-0608-21	8.6	110	12.8	132	15.3	165	19.1	193	22.4
		64	9-0610-21	6.8	108	16.0	130	19.2	163	24.0	192	28.2
		76	9-0612-21	5.7	108	19.0	130	22.8	162	28.5	200	35.1
		305	9-0648-21	1.3	101	76.3	122	91.5	152	114.4	178	137.2
12.5	7	19	9-0803-21	36.8	175	4.75	210	5.7	262	7.13	280	7.6
		25	9-0804-21	28.9	181	6.3	217	7.5	271	9.4	366	12.7
		32	9-0805-21	22.6	181	8.0	217	9.6	271	12.0	365	16.1
		38	9-0806-21	19.1	181	9.5	218	11.4	272	14.3	381	19.9
		44	9-0807-21	16.1	177	11.0	213	13.2	266	16.5	372	23.0
		51	9-0808-21	14.0	179	12.8	214	15.3	268	19.1	378	27.0
		64	9-0810-21	11.0	177	16.0	212	19.2	265	24.0	366	33.0
		76	9-0812-21	8.8	166	19.0	200	22.8	250	28.5	343	39.0
		89	9-0814-21	7.5	166	22.3	200	26.7	250	33.4	344	46.0
102	9-0816-21	6.5	166	25.5	199	30.6	249	38.3	348	53.6		
305	9-0848-21	2.2	166	76.3	199	91.5	248	114.4	349	161.0		
16	8.5	19	9-1003-21	77.1	366	4.75	439	5.7	550	7.13	625	8.1
		25	9-1004-21	55.7	348	6.3	418	7.5	522	9.4	596	10.7
		32	9-1005-21	42.0	336	8.0	403	9.6	504	12.0	571	13.6
		38	9-1006-21	35.2	334	9.5	401	11.4	502	14.3	581	16.5
		44	9-1007-21	30.5	335	11.0	402	13.2	503	16.5	628	20.6
		51	9-1008-21	27.0	344	12.8	413	15.3	516	19.1	632	23.4
		64	9-1010-21	21.0	336	16.0	404	19.2	504	24.0	634	30.2
		76	9-1012-21	17.7	336	19.0	403	22.8	504	28.5	643	36.3
		89	9-1014-21	15.2	339	22.3	407	26.7	509	33.4	667	43.9
102	9-1016-21	13.3	339	25.5	407	30.6	509	38.3	683	51.3		
115	9-1018-21	11.7	337	28.8	404	34.5	504	43.1	672	57.4		
305	9-1048-21	4.1	315	76.3	378	91.5	473	114.4	625	152.4		
20	10	19	9-1203-21	120.0	570	4.75	684	5.7	855	7.13	888	7.4
		25	9-1204-21	90.2	564	6.3	676	7.5	846	9.4	925	10.3
		32	9-1205-21	68.1	545	8.0	654	9.6	818	12.0	880	12.9
		38	9-1206-21	54.8	521	9.5	625	11.4	781	14.3	855	15.6
		44	9-1207-21	45.2	497	11.0	596	13.2	746	16.5	810	18.0
		51	9-1208-21	38.9	496	12.8	595	15.3	744	19.1	801	21.0
		64	9-1210-21	30.3	485	16.0	582	19.2	727	24.0	789	26.0
		76	9-1212-21	24.7	469	19.0	563	22.8	704	28.5	768	31.0
		89	9-1214-21	21.4	475	22.3	570	26.7	713	33.4	790	37.0
102	9-1216-21	18.6	473	25.5	568	30.6	710	38.3	795	43.0		
115	9-1218-21	16.3	468	28.8	562	34.5	702	43.1	780	48.0		
127	9-1220-21	14.5	462	31.8	554	38.1	692	47.6	777	53.0		
139	9-1222-21	13.1	456	34.8	548	41.7	685	52.1	774	59.0		
152	9-1224-21	12.1	459	38.0	551	45.6	689	57.0	772	64.0		
305	9-1248-21	6.1	462	76.3	554	91.5	693	114.4	802	132.0		

\*Note: 1 Newton=0.10197 Kg (Force)



## Product Features:

- ◆ ISO color – Blue
- ◆ High tensile strength chrome silicon
- ◆ Optimal rectangular wire design
- ◆ Long life design

Hole Diam. (mm) A	Rod Diam. (mm) B	Free Length (mm) C	CATALOG NUMBER	RATE Newtons Req'd. to deflect 1 mm	LOAD-DEFLECTION TABLE									
					Total Deflection for Long Life (25% of C)		Total Deflection for Avg. Life (30% of C)		Maximum Operating Deflection (37.5% of C)		Total Travel to Solid			
					Load N	Defl. mm	Load N	Defl. mm	Load N	Defl. mm	Load N	Defl. mm		
25	12.5	25	9-1604-21	166.2	1039	6.3	1246	7.5	1558	9.4	1649	9.9		
		32	9-1605-21	124.7	998	8.0	1197	9.6	1496	12.0	1586	12.7		
		38	9-1606-21	98.6	937	9.5	1124	11.4	1405	14.3	1505	15.3		
		44	9-1607-21	83.2	915	11.0	1098	13.2	1373	16.5	1519	18.3		
		51	9-1608-21	71.8	915	12.8	1099	15.3	1373	19.1	1528	21.0		
		64	9-1610-21	55.0	880	16.0	1056	19.2	1320	24.0	1455	26.0		
		76	9-1612-21	45.2	858	19.0	1030	22.8	1288	28.5	1445	32.0		
		89	9-1614-21	37.8	842	22.3	1010	26.7	1263	33.4	1408	37.0		
		102	9-1616-21	32.9	840	25.5	1007	30.6	1259	38.3	1405	43.0		
		115	9-1618-21	29.2	841	28.8	1009	34.5	1261	43.1	1425	49.0		
		127	9-1620-21	26.3	834	31.8	1001	38.1	1251	47.6	1422	54.0		
		139	9-1622-21	23.6	822	34.8	986	41.7	1232	52.1	1419	60.0		
		152	9-1624-21	21.7	825	38.0	990	45.6	1238	57.0	1417	65.0		
		178	9-1628-21	18.4	818	44.5	982	53.4	1227	66.8	1399	76.0		
		203	9-1632-21	15.9	809	50.8	971	60.9	1213	76.1	1386	87.0		
		305	9-1648-21	10.5	801	76.3	961	91.5	1202	114.4	1357	130.0		
		32	16	38	9-2006-21	166.0	1577	9.5	1893	11.4	2366	14.3	2532	15.2
				44	9-2007-21	136.4	1501	11.0	1801	13.2	2251	16.5	2447	17.9
51	9-2008-21			116.1	1480	12.8	1777	15.3	2221	19.1	2397	21.0		
64	9-2010-21			87.7	1404	16.0	1685	19.2	2106	24.0	2238	26.0		
76	9-2012-21			70.9	1348	19.0	1617	22.8	2021	28.5	2178	31.0		
89	9-2014-21			59.9	1333	22.3	1599	26.7	1999	33.4	2163	36.0		
102	9-2016-21			51.8	1322	25.5	1586	30.6	1983	38.3	2153	42.0		
115	9-2018-21			46.1	1324	28.8	1589	34.5	1986	43.1	2185	47.0		
127	9-2020-21			41.5	1318	31.8	1581	38.1	1977	47.6	2214	53.0		
139	9-2022-21			37.5	1302	34.8	1563	41.7	1954	52.1	2202	59.0		
152	9-2024-21			34.2	1298	38.0	1557	45.6	1947	57.0	2191	64.0		
178	9-2028-21			29.1	1294	44.5	1552	53.4	1941	66.8	2175	75.0		
203	9-2032-21			25.2	1280	50.8	1536	60.9	1920	76.1	2163	86.0		
254	9-2040-21			20.0	1268	63.5	1521	76.2	1902	95.3	2147	107.0		
305	9-2048-21			16.6	1269	76.3	1522	91.5	1903	114.4	2151	130.0		
40	20			51	9-2408-21	170.6	2175	12.8	2610	15.3	3262	19.1	3390	19.9
				64	9-2410-21	128.7	2060	16.0	2471	19.2	3089	24.0	3210	25.0
				76	9-2412-21	105.3	2000	19.0	2400	22.8	3000	28.5	3224	31.0
		89	9-2414-21	87.7	1952	22.3	2343	26.7	2928	33.4	3129	36.0		
		102	9-2416-21	76.0	1938	25.5	2326	30.6	2907	38.3	3143	41.0		
		115	9-2418-21	66.4	1908	28.8	2290	34.5	2862	43.1	3081	46.0		
		127	9-2420-21	59.5	1891	31.8	2269	38.1	2836	47.6	3102	52.0		
		139	9-2422-21	53.6	1862	34.8	2235	41.7	2793	52.1	3057	57.0		
		152	9-2424-21	48.9	1857	38.0	2228	45.6	2785	57.0	3072	63.0		
		178	9-2428-21	41.5	1847	44.5	2216	53.4	2771	66.8	3054	74.0		
		203	9-2432-21	36.1	1831	50.8	2197	60.9	2746	76.1	3038	84.0		
		254	9-2440-21	28.9	1835	63.5	2202	76.2	2752	95.3	3083	107.0		
		305	9-2448-21	23.8	1816	76.3	2179	91.5	2724	114.4	3033	128.0		
		50	25	64	9-3210-21	211.9	3391	16.0	4069	19.2	5086	24.0	5305	25.0
				76	9-3212-21	167.4	3181	19.0	3817	22.8	4772	28.5	5024	30.0
				89	9-3214-21	139.8	3110	22.3	3731	26.7	4664	33.4	4932	35.0
				102	9-3216-21	121.9	3108	25.5	3730	30.6	4662	38.3	5042	41.0
				115	9-3218-21	107.2	3081	28.8	3698	34.5	4622	43.1	5041	47.0
127	9-3220-21			94.6	3003	31.8	3603	38.1	4504	47.6	4914	52.0		
139	9-3222-21			85.5	2970	34.8	3564	41.7	4455	52.1	4935	58.0		
152	9-3224-21			77.9	2961	38.0	3554	45.6	4442	57.0	4945	63.0		
178	9-3228-21			66.4	2954	44.5	3544	53.4	4431	66.8	4966	75.0		
203	9-3232-21			57.4	2915	50.8	3498	60.9	4373	76.1	4905	85.0		
229	9-3236-21			51.0	2918	57.3	3501	68.7	4376	85.9	4926	97.0		
254	9-3240-21			45.7	2903	63.5	3483	76.2	4354	95.3	4943	108.0		
305	9-3248-21			37.7	2871	76.3	3445	91.5	4307	114.4	4913	130.0		
63	38			76	9-4012-21	304.7	5790	19.0	6948	22.8	8685	28.5	9398	31.0
				89	9-4014-21	250.4	5572	22.3	6687	26.7	8358	33.4	9143	37.0
				102	9-4016-21	211.								



# DieMax XL® Heavy Load Springs – Metric ISO Standard

Hole Diam. (mm) A	Rod Diam. (mm) B	Free Length (mm) C	CATALOG NUMBER	RATE Newtons Req. to deflect 1 mm	LOAD-DEFLECTION TABLE							
					Total Deflection for Long Life (20% of C)		Total Deflection for Avg. Life (25% of C)		Maximum Operating Deflection (30% of C)		Total Travel to Solid	
					Load N	Defl. mm	Load N	Defl. mm	Load N	Defl. mm	Load N	Defl. mm
10	5	19	9-0603-26	28.9	110	3.80	137	4.75	165	5.70	188	6.5
		25	9-0604-26	22.1	110	5.0	138	6.3	165	7.5	205	9.3
		32	9-0605-26	17.5	112	6.4	140	8.0	168	9.6	209	11.9
		38	9-0606-26	16.3	124	7.6	155	9.5	186	11.4	272	16.7
		44	9-0607-26	14.0	123	8.8	154	11.0	185	13.2	276	19.8
		51	9-0608-26	11.9	121	10.2	152	12.8	182	15.3	268	22.0
		64	9-0610-26	9.6	123	12.8	154	16.0	185	19.2	276	29.0
		76	9-0612-26	7.6	116	15.2	144	19.0	173	22.8	248	33.0
305	9-0648-26	1.9	114	61.0	143	76.3	171	91.5	250	134.0		
12.5	7	19	9-0803-26	54.3	206	3.80	258	4.75	310	5.70	429	7.9
		25	9-0804-26	41.3	207	5.0	258	6.3	310	7.5	457	11.1
		32	9-0805-26	32.9	211	6.4	263	8.0	316	9.6	472	14.3
		38	9-0806-26	27.1	206	7.6	258	9.5	309	11.4	477	17.6
		44	9-0807-26	23.3	205	8.8	256	11.0	307	13.2	485	21.0
		51	9-0808-26	20.0	204	10.2	255	12.8	305	15.3	476	24.0
		64	9-0810-26	15.2	195	12.8	244	16.0	293	19.2	441	29.0
		76	9-0812-26	13.5	205	15.2	256	19.0	307	22.8	507	37.0
89	9-0814-26	10.9	193	17.8	242	22.3	290	26.7	455	42.0		
102	9-0816-26	8.9	182	20.4	227	25.5	272	30.6	418	47.0		
305	9-0848-26	3.1	189	61.0	236	76.3	284	91.5	451	145.0		
16	8.5	19	9-1003-26	101.6	386	3.80	483	4.75	579	5.70	701	6.9
		25	9-1004-26	75.5	377	5.0	472	6.3	566	7.5	712	9.4
		32	9-1005-26	60.9	390	6.4	488	8.0	585	9.6	776	12.7
		38	9-1006-26	48.7	370	7.6	463	9.5	555	11.4	744	15.3
		44	9-1007-26	43.3	381	8.8	476	11.0	571	13.2	825	19.1
		51	9-1008-26	35.9	366	10.2	458	12.8	549	15.3	758	21.0
		64	9-1010-26	28.9	370	12.8	462	16.0	555	19.2	787	27.0
		76	9-1012-26	24.5	373	15.2	466	19.0	559	22.8	830	34.0
89	9-1014-26	20.8	371	17.8	464	22.3	556	26.7	833	40.0		
102	9-1016-26	18.2	372	20.4	464	25.5	557	30.6	833	46.0		
305	9-1048-26	5.8	356	61.0	445	76.3	534	91.5	806	138.0		
20	10	25	9-1204-26	239.9	1200	5.0	1500	6.3	1799	7.5	1879	7.8
		32	9-1205-26	180.4	1154	6.4	1443	8.0	1732	9.6	1811	10.1
		38	9-1206-26	144.0	1094	7.6	1368	9.5	1641	11.4	1770	12.3
		44	9-1207-26	120.0	1056	8.8	1320	11.0	1584	13.2	1743	14.5
		51	9-1208-26	101.2	1033	10.2	1291	12.8	1549	15.3	1651	16.3
		64	9-1210-26	77.1	986	12.8	1233	16.0	1480	19.2	1532	19.9
		76	9-1212-26	63.4	964	15.2	1205	19.0	1445	22.8	1545	24.0
		89	9-1214-26	53.9	960	17.8	1200	22.3	1440	26.7	1554	29.0
102	9-1216-26	46.9	957	20.4	1197	25.5	1436	30.6	1561	33.0		
115	9-1218-26	41.5	946	22.8	1183	28.5	1420	34.2	1567	38.0		
127	9-1220-26	37.1	943	25.4	1179	31.8	1415	38.1	1571	42.0		
139	9-1222-26	33.8	946	28.0	1183	35.0	1420	42.0	1574	47.0		
152	9-1224-26	30.8	937	30.4	1171	38.0	1406	45.6	1577	51.0		
305	9-1248-26	15.1	919	61.0	1148	76.3	1378	91.5	1560	103.0		
25	12.5	25	9-1604-26	376.5	1883	5.0	2353	6.3	—	—	2782	7.4
		32	9-1605-26	285.5	1827	6.4	2284	8.0	2740	9.6	2883	10.1
		38	9-1606-26	222.4	1690	7.6	2113	9.5	2536	11.4	2676	12.1
		44	9-1607-26	190.9	1680	8.8	2100	11.0	2520	13.2	2875	15.1
		51	9-1608-26	156.6	1597	10.2	1996	12.8	2395	15.3	2583	16.5
		64	9-1610-26	121.0	1549	12.8	1936	16.0	2324	19.2	2540	21.0
		76	9-1612-26	99.8	1517	15.2	1897	19.0	2276	22.8	2596	26.0
		89	9-1614-26	84.1	1496	17.8	1870	22.3	2244	26.7	2558	30.0
102	9-1616-26	73.2	1493	20.4	1867	25.5	2240	30.6	2597	35.0		
115	9-1618-26	65.0	1481	22.8	1852	28.5	2222	34.2	2626	40.0		
127	9-1620-26	58.0	1472	25.4	1840	31.8	2209	38.1	2601	45.0		
139	9-1622-26	52.5	1471	28.0	1839	35.0	2207	42.0	2625	50.0		
152	9-1624-26	48.2	1464	30.4	1830	38.0	2196	45.6	2645	55.0		
178	9-1628-26	41.2	1465	35.6	1831	44.5	2198	53.4	2676	65.0		
203	9-1632-26	35.9	1458	40.6	1822	50.8	2186	60.9	2666	74.0		
305	9-1648-26	24.2	1474	61.0	1843	76.3	2211	91.5	2839	117.0		

\*Note: 1 Newton=0.10197 Kg (Force)

Hole Diam. (mm) A	Rod Diam. (mm) B	Free Length (mm) C	CATALOG NUMBER	RATE Newtons Req. to deflect 1 mm	LOAD-DEFLECTION TABLE									
					Total Deflection for Long Life (20% of C)		Total Deflection for Avg. Life (25% of C)		Maximum Operating Deflection (30% of C)		Total Travel to Solid			
					Load N	Defl. mm	Load N	Defl. mm	Load N	Defl. mm	Load N	Defl. mm		
32	16	38	9-2006-26	390.5	2968	7.6	3710	9.5	4452	11.4	4542	11.6		
		44	9-2007-26	318.7	2805	8.8	3506	11.0	4207	13.2	4424	13.9		
		51	9-2008-26	269.7	2751	10.2	3439	12.8	4126	15.3	4342	16.1		
		64	9-2010-26	204.9	2623	12.8	3278	16.0	3934	19.2	4119	20.0		
		76	9-2012-26	165.8	2521	15.2	3151	19.0	3781	22.8	4076	25.0		
		89	9-2014-26	140.3	2497	17.8	3121	22.3	3745	26.7	4119	29.0		
		102	9-2016-26	121.0	2469	20.4	3086	25.5	3703	30.6	4087	34.0		
		115	9-2018-26	106.3	2424	22.8	3030	28.5	3636	34.2	4063	38.0		
		127	9-2020-26	95.8	2433	25.4	3042	31.8	3650	38.1	4151	43.0		
		139	9-2022-26	86.3	2418	28.0	3022	35.0	3626	42.0	4126	48.0		
		152	9-2024-26	78.6	2390	30.4	2988	38.0	3586	45.6	4104	52.0		
		178	9-2028-26	66.7	2375	35.6	2969	44.5	3563	53.4	4072	61.0		
		203	9-2032-26	57.8	2346	40.6	2933	50.8	3520	60.9	4048	70.0		
		254	9-2040-26	46.2	2349	50.8	2936	63.5	3523	76.2	4114	89.0		
		305	9-2048-26	38.2	2329	61.0	2911	76.3	3493	91.5	4075	107.0		
		40	20	51	9-2408-26	364.3	3716	10.2	4644	12.8	5573	15.3	6037	16.6
64	9-2410-26			268.0	3430	12.8	4287	16.0	5145	19.2	5483	23.0		
76	9-2412-26			218.9	3327	15.2	4159	19.0	4991	22.8	5568	25.0		
89	9-2414-26			183.9	3273	17.8	4092	22.3	4910	26.7	5627	30.0		
102	9-2416-26			158.7	3237	20.4	4046	25.5	4855	30.6	5570	35.0		
115	9-2418-26			140.8	3210	22.8	4013	28.5	4816	34.2	5717	41.0		
127	9-2420-26			125.2	3181	25.4	3976	31.8	4771	38.1	5662	45.0		
139	9-2422-26			112.6	3153	28.0	3941	35.0	4730	42.0	5618	50.0		
152	9-2424-26			103.3	3141	30.4	3926	38.0	4712	45.6	5711	55.0		
178	9-2428-26			88.1	3136	35.6	3920	44.5	4704	53.4	5755	65.0		
203	9-2432-26			76.7	3114	40.6	3893	50.8	4671	60.9	5779	75.0		
254	9-2440-26			60.6	3078	50.8	3848	63.5	4617	76.2	5742	95.0		
305	9-2448-26			50.3	3066	61.0	3833	76.3	4599	91.5	5782	115.0		
50	25			64	9-3210-26	423.8	5425	12.8	6781	16.0	8137	19.2	8467	20.0
				76	9-3212-26	338.0	5138	15.2	6422	19.0	7706	22.8	8273	25.0
				89	9-3214-26	280.2	4988	17.8	6235	22.3	7482	26.7	8144	29.0
		102	9-3216-26	245.2	5002	20.4	6252	25.5	7503	30.6	8412	34.0		
		115	9-3218-26	215.4	4911	22.8	6139	28.5	7367	34.2	8457	39.0		
		127	9-3220-26	189.1	4804	25.4	6005	31.8	7206	38.1	8184	43.0		
		139	9-3222-26	168.8	4727	28.0	5909	35.0	7091	42.0	7990	47.0		
		152	9-3224-26	154.1	4685	30.4	5856	38.0	7028	45.6	8059	52.0		
		178	9-3228-26	131.3	4676	35.6	5845	44.5	7014	53.4	8165	62.0		
		203	9-3232-26	114.4	4643	40.6	5804	50.8	6965	60.9	8245	72.0		
		254	9-3240-26	89.8	4564	50.8	5705	63.5	6846	76.2	8075	90.0		
		305	9-3248-26	74.6	4551	61.0	5689	76.3	6826	91.5	8193	110.0		
		63	38	76	9-4012-26	516.6	398	15.2	9841	19.0	11809	22.8	13253	25.7
				89	9-4014-26	422.1	379	17.8	9380	22.3	11256	26.7	13134	31.1
				102	9-4016-26	359.0	369	20.4	9118	25.5	10942	30.6	13131	36.6
				115	9-4018-26	311.7	360	22.8	8907	28.5	10689	34.2	13182	42.3
127	9-4020-26			274.9	353	25.4	8729	31.8	10475	38.1	13092	47.6		
152	9-4024-26			224.1	345	30.4	8540	38.0	10248	45.6	12807	57.2		
178	9-4028-26			189.1	340	35.6	8407	44.5	10088	53.4	12608	66.7		

# DieMax XL® Extra Heavy Load Springs – Metric ISO Standard

Hole Diam. (mm) A	Rod Diam. (mm) B	Free Length (mm) C	CATALOG NUMBER	RATE Newtons Req'd. to deflect 1 mm	LOAD-DEFLECTION TABLE							
					Total Deflection for Long Life (17% of C)		Total Deflection for Avg. Life (20% of C)		Maximum Operating Deflection (25% of C)		Total Travel to Solid	
					Load N	Defl. mm	Load N	Defl. mm	Load N	Defl. mm	Load N	Defl. mm
10	5	19	9-0603-36	44.1	142	3.23	168	3.80	209	4.75	234	5.30
		25	9-0604-36	32.7	139	4.3	164	5.0	205	6.3	241	7.3
		32	9-0605-36	25.6	139	5.4	164	6.4	205	8.0	238	9.3
		38	9-0606-36	21.2	137	6.5	161	7.6	201	9.5	243	11.5
		44	9-0607-36	17.7	132	7.5	156	8.8	195	11.0	230	13.0
		51	9-0608-36	15.4	134	8.7	157	10.2	196	12.8	230	15.0
		64	9-0610-36	12.3	133	10.9	157	12.8	196	16.0	233	19.1
		76	9-0612-36	10.2	131	12.9	154	15.2	193	19.0	236	23.0
		305	9-0648-36	2.5	127	51.9	150	61.0	187	76.3	229	91.4
		12.5	7	19	9-0803-36	77.9	252	3.23	296	3.80	370	4.75
25	9-0804-36			58.7	249	4.3	293	5.0	367	6.3	468	8.0
32	9-0805-36			44.1	240	5.4	282	6.4	353	8.0	431	9.8
38	9-0806-36			36.3	234	6.5	276	7.6	344	9.5	433	12.0
44	9-0807-36			30.6	229	7.5	270	8.8	337	11.0	434	14.2
51	9-0808-36			27.0	234	8.7	275	10.2	344	12.8	460	17.0
64	9-0810-36			21.7	236	10.9	278	12.8	347	16.0	451	20.8
76	9-0812-36			17.7	229	12.9	269	15.2	336	19.0	444	25.1
89	9-0814-36			15.1	228	15.1	268	17.8	335	22.3	445	29.5
102	9-0816-36			13.0	225	17.3	265	20.4	332	25.5	429	33.0
305	9-0848-36	4.2	219	51.9	257	61.0	322	76.3	429	102.1		
16	8.5	19	9-1003-36	169.9	549	3.23	646	3.80	807	4.75	968	5.7
		25	9-1004-36	127.3	541	4.3	637	5.0	796	6.3	1012	7.9
		32	9-1005-36	94.0	512	5.4	602	6.4	752	8.0	911	9.7
		38	9-1006-36	75.8	490	6.5	576	7.6	720	9.5	895	11.8
		44	9-1007-36	63.6	476	7.5	559	8.8	699	11.0	887	13.9
		51	9-1008-36	55.5	481	8.7	566	10.2	708	12.8	912	16.4
		64	9-1010-36	43.3	471	10.9	554	12.8	692	16.0	895	21.0
		76	9-1012-36	35.6	459	12.9	540	15.2	675	19.0	885	25.0
		89	9-1014-36	30.3	458	15.1	539	17.8	674	22.3	894	30.0
		102	9-1016-36	26.4	459	17.3	539	20.4	674	25.5	903	34.0
305	9-1048-36	8.5	443	51.9	521	61.0	652	76.3	907	106.0		
20	10	25	9-1204-36	320.5	1362	4.3	1602	5.0	2003	6.3	2115	6.6
		32	9-1205-36	239.9	1305	5.4	1536	6.4	1919	8.0	2050	8.5
		38	9-1206-36	194.4	1256	6.5	1477	7.6	1847	9.5	2099	10.8
		44	9-1207-36	161.8	1210	7.5	1424	8.8	1780	11.0	2073	12.8
		51	9-1208-36	139.6	1210	8.7	1424	10.2	1780	12.8	2105	15.1
		64	9-1210-36	108.8	1183	10.9	1392	12.8	1740	16.0	2101	19.3
		76	9-1212-36	89.7	1159	12.9	1363	15.2	1704	19.0	2137	24.0
		89	9-1214-36	75.7	1145	15.1	1347	17.8	1683	22.3	2106	28.0
		102	9-1216-36	65.3	1133	17.3	1333	20.4	1666	25.5	2080	32.0
		115	9-1218-36	57.4	1113	19.4	1310	22.8	1637	28.5	2063	36.0
127	9-1220-36	51.7	1115	21.6	1312	25.4	1640	31.8	2088	40.0		
139	9-1222-36	46.6	1109	23.8	1304	28.0	1630	35.0	2071	44.0		
152	9-1224-36	42.6	1100	25.8	1294	30.4	1617	38.0	2059	48.0		
305	9-1248-36	21.0	1090	51.9	1282	61.0	1602	76.3	2085	100.0		

\*Note: 1 Newton=0.10197 Kg (Force)

Hole Diam. (mm) A	Rod Diam. (mm) B	Free Length (mm) C	CATALOG NUMBER	RATE Newtons Req'd. to deflect 1 mm	LOAD-DEFLECTION TABLE									
					Total Deflection for Long Life (17% of C)		Total Deflection for Avg. Life (20% of C)		Maximum Operating Deflection (25% of C)		Total Travel to Solid			
					Load N	Defl. mm	Load N	Defl. mm	Load N	Defl. mm	Load N	Defl. mm		
25	12.5	25	9-1604-36	472.9	2033	4.3	2365	5.0	2979	6.3	3830	8.1		
		32	9-1605-36	353.8	1924	5.4	2264	6.4	2830	8.0	3153	8.9		
		38	9-1606-36	280.2	1810	6.5	2130	7.6	2662	9.5	3080	11.0		
		44	9-1607-36	231.2	1729	7.5	2034	8.8	2543	11.0	3049	13.2		
		51	9-1608-36	197.9	1716	8.7	2019	10.2	2523	12.8	3027	15.3		
		64	9-1610-36	153.8	1673	10.9	1968	12.8	2460	16.0	3044	19.8		
		76	9-1612-36	125.0	1616	12.9	1901	15.2	2376	19.0	3008	24.0		
		89	9-1614-36	105.4	1595	15.1	1877	17.8	2346	22.3	2983	28.0		
		102	9-1616-36	91.1	1579	17.3	1858	20.4	2322	25.5	2966	33.0		
		115	9-1618-36	80.9	1568	19.4	1845	22.8	2306	28.5	3029	37.0		
		127	9-1620-36	72.2	1558	21.6	1833	25.4	2291	31.8	3010	42.0		
		139	9-1622-36	65.6	1561	24.0	1837	28.0	2296	35.0	3053	47.0		
		152	9-1624-36	60.2	1557	25.8	1831	30.4	2289	38.0	3093	51.0		
		178	9-1628-36	51.3	1553	30.3	1827	35.6	2283	44.5	3102	61.0		
		203	9-1632-36	44.7	1541	34.5	1813	40.6	2266	50.8	3112	70.0		
		305	9-1648-36	29.6	1535	51.9	1805	61.0	2257	76.3	3007	101.6		
		32	16	38	9-2006-36	488.6	3156	6.5	3713	7.6	4642	9.5	4860	10.0
				44	9-2007-36	404.6	3026	7.5	3560	8.8	4450	11.0	4930	12.2
				51	9-2008-36	345.0	2991	8.7	3519	10.2	4399	12.8	4979	14.5
				64	9-2010-36	266.2	2896	10.9	3407	12.8	4259	16.0	5068	19.0
76	9-2012-36			215.4	2783	12.9	3274	15.2	4093	19.0	4987	23.0		
89	9-2014-36			182.1	2756	15.1	3242	17.8	4053	22.3	5030	28.0		
102	9-2016-36			155.7	2700	17.3	3176	20.4	3970	25.5	4892	31.0		
115	9-2018-36			135.7	2630	19.4	3095	22.8	3868	28.5	4764	35.0		
127	9-2020-36			121.9	2632	21.6	3096	25.4	3870	31.8	4849	40.0		
139	9-2022-36			111.0	2651	24.0	3119	28.0	3898	35.0	5018	45.0		
40	20	152	9-2024-36	100.9	2607	25.8	3067	30.4	3833	38.0	4929	49.0		
		178	9-2028-36	85.6	2591	30.3	3049	35.6	3811	44.5	4886	57.0		
		203	9-2032-36	74.6	2575	34.5	3029	40.6	3786	50.8	4941	66.0		
		254	9-2040-36	59.5	2571	43.2	3025	50.8	3781	63.5	5017	84.0		
		305	9-2048-36	49.6	2570	51.9	3023	61.0	3779	76.3	5068	102.0		
		50	25	64	9-3210-36	725.0	7888	10.9	9281	12.8	11601	16.0	12535	17.3
				76	9-3212-36	572.7	7399	12.9	8705	15.2	10881	19.0	12200	21.0
				89	9-3214-36	474.6	7181	15.1	8448	17.8	10560	22.3	11981	25.0
				102	9-3216-36	404.6	7015	17.3	8253	20.4	10316	25.5	11827	29.0
				115	9-3218-36	352.0	6822	19.4	8026	22.8	10032	28.5	11761	33.0
				127	9-3220-36	313.5	6768	21.6	7963	25.4	9953	31.8	11666	37.0
				139	9-3222-36	282.0	6722	23.8	7908	28.0	9885	35.0	11825	42.0
				152	9-3224-36	253.9	6562	25.8	7720	30.4	9650	38.0	11530	45.0
				178	9-3228-36	215.0	6503	30.3	7650	35.6	9563	44.5	11466	53.0
				203	9-3232-36	185.6	6406	34.5	7537	40.6	9421	50.8	11394	61.0
		50	25	254	9-3240-36	146.2	6314	43.2	7429	50.8	9286	63.5	11316	77.0
				305	9-3248-36	120.7	6257	51.9	7361	61.0	9201	76.3	11265	93.0

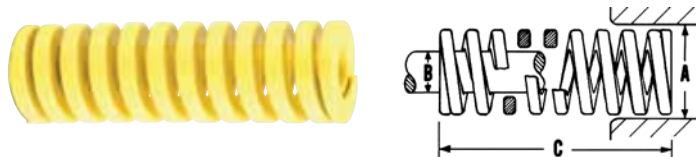

## Product Features:

- ◆ ISO color – Yellow
- ◆ High tensile strength chrome silicon
- ◆ Optimal rectangular wire design
- ◆ Long life design

# DieMax XL<sup>®</sup> Ultra Heavy Load Springs – Metric Standard

Hole Diam. (mm) A	Rod Diam. (mm) B	Free Length (mm) C	CATALOG NUMBER	RATE Newtons Req'd. to deflect 1 mm	LOAD-DEFLECTION TABLE							
					Total Deflection for Long Life (10% of C)		Total Deflection for Avg. Life (12% of C)		Maximum Operating Deflection (15% of C)		Total Travel to Solid	
					Load N	Defl. mm	Load N	Defl. mm	Load N	Defl. mm	Load N	Defl. mm
25	12.5	64	9-1610-51	644	4122	6.4	4959	7.7	6182	9.6	8372	13
		76	9-1612-51	556	4226	7.6	5060	9.1	6338	11.4	8896	16
		89	9-1614-51	462	4112	8.9	4943	10.7	6168	13.4	9240	20
		102	9-1616-51	390	3978	10.2	4758	12.2	5967	15.3	8970	23
		115	9-1618-51	360	4140	11.5	4968	13.8	6210	17.3	9360	26
		127	9-1620-51	326	4140	12.7	4955	15.2	6210	19.1	9128	28
		152	9-1624-51	255	3876	15.2	4641	18.2	5814	22.8	8670	34
		178	9-1628-51	230	4094	17.8	4922	21.4	6141	26.7	8970	39
		203	9-1632-51	202	4101	20.3	4929	24.4	6151	30.5	9090	45
		305	9-1648-51	136	4148	30.5	4978	36.6	6222	45.8	8568	63
32	16	64	9-2010-51	1077	6892	6.4	8270	7.7	10337	9.6	14001	13
		76	9-2012-51	874	6642	7.6	7971	9.1	9964	11.4	13984	16
		89	9-2014-51	721	6419	8.9	7702	10.7	9628	13.4	14420	20
		102	9-2016-51	620	6324	10.2	7589	12.2	9486	15.3	14260	23
		115	9-2018-51	560	6440	11.5	7728	13.8	9660	17.3	14560	26
		127	9-2020-51	496	6299	12.7	7559	15.2	9449	19.1	13888	28
		152	9-2024-51	408	6202	15.2	7442	18.2	9302	22.8	13872	34
		178	9-2028-51	353	6280	17.8	7536	21.4	9420	26.7	13767	39
		203	9-2032-51	304	6171	20.3	7405	24.4	9257	30.5	13680	45
		254	9-2040-51	243	6177	25.4	7413	30.5	9266	38.1	15066	62
305	9-2048-51	196	5978	30.5	7174	36.6	8967	45.8	14700	75		

Hole Diam. (mm) A	Rod Diam. (mm) B	Free Length (mm) C	CATALOG NUMBER	RATE Newtons Req'd. to deflect 1 mm	LOAD-DEFLECTION TABLE							
					Total Deflection for Long Life (10% of C)		Total Deflection for Avg. Life (12% of C)		Maximum Operating Deflection (15% of C)		Total Travel to Solid	
					Load N	Defl. mm	Load N	Defl. mm	Load N	Defl. mm	Load N	Defl. mm
40	20	89	9-2414-51	880	7832	8.9	9416	10.7	11748	13.4	17600	20
		102	9-2416-51	762	7772	10.2	9296	12.2	11659	15.3	17526	23
		115	9-2418-51	679	7809	11.5	9370	13.8	11713	17.3	17654	26
		127	9-2420-51	622	7899	12.7	9454	15.2	11849	19.1	17416	28
		152	9-2424-51	509	7737	15.2	9264	18.2	11605	22.8	18324	36
		178	9-2428-51	429	7636	17.8	9181	21.4	11454	26.7	18447	43
		203	9-2432-51	374	7592	20.3	9126	24.4	11388	30.5	18326	49
		254	9-2440-51	296	7518	25.4	9028	30.5	11278	38.1	18352	62
		305	9-2448-51	246	7530	30.5	9004	36.6	11255	45.8	18450	75
		50	25	89	9-3214-51	1410	12549	8.9	15087	10.7	18824	13.4
102	9-3216-51			1215	12393	10.2	14823	12.2	18590	15.3	26730	22
115	9-3218-51			1076	12374	11.5	14849	13.8	18561	17.3	26900	25
127	9-3220-51			968	12294	12.7	14714	15.2	18440	19.1	27104	28
152	9-3224-51			806	12251	15.2	14669	18.2	18377	22.8	27404	34
178	9-3228-51			698	12424	17.8	14937	21.4	18637	26.7	27920	40
203	9-3232-51			612	12424	20.3	14933	24.4	18635	30.5	27540	45
254	9-3240-51			472	11989	25.4	14396	30.5	17983	38.1	27376	58
305	9-3248-51			388	11834	30.5	14201	36.6	17751	45.8	27160	70

\*Note: 1 Newton=0.10197 Kg (Force)

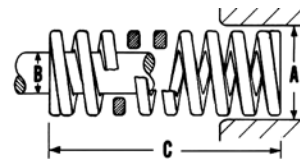

### Product Features:

- ◆ Color – Silver
- ◆ High tensile strength chrome silicon
- ◆ Optimal rectangular wire design
- ◆ Long life design

# DieMax XL® Light Load Springs – Inch Round Wire

Hole Diam. (in) A	Rod Diam. (in) B	Free Length (in) C	CATALOG NUMBER	RATE Pounds Reqd. to deflect 1/10 in.	LOAD-DEFLECTION TABLE							
					Total Deflection for Long Life (25% of C)		Total Deflection for Avg. Life (30% of C)		Maximum Operating Deflection (40% of C)		Total Travel to Solid	
					Load lbs.	Defl. in.	Load lbs.	Defl. in.	Load lbs.	Defl. in.	Load lbs.	Defl. in.
3/8	3/16	3/4	9-0603-119	3.35	6	0.19	8	0.23	10	0.30	13	0.39
		1	9-0604-119	2.52	6	0.25	8	0.30	10	0.40	13	0.52
		1 1/4	9-0605-119	1.96	6	0.31	7	0.38	10	0.50	13	0.65
		1 1/2	9-0606-119	1.59	6	0.38	7	0.45	10	0.60	12	0.78
		1 3/4	9-0607-119	1.35	6	0.44	7	0.53	9	0.70	12	0.91
		2	9-0608-119	1.19	6	0.50	7	0.60	9	0.80	13	1.06
		2 1/2	9-0610-119	0.93	6	0.63	7	0.75	9	1.00	12	1.31
		3	9-0612-119	0.76	6	0.75	7	0.90	9	1.20	12	1.56
1/2	9/32	12	9-0648-119	0.18	5	3.00	7	3.60	9	4.80	11	6.19
		3/4	9-0803-119	6.45	12	0.19	15	0.23	19	0.30	24	0.37
		1	9-0804-119	4.88	12	0.25	15	0.30	20	0.40	26	0.53
		1 1/4	9-0805-119	3.71	12	0.31	14	0.38	19	0.50	25	0.66
		1 1/2	9-0806-119	3.04	11	0.38	14	0.45	18	0.60	24	0.80
		1 3/4	9-0807-119	2.54	11	0.44	13	0.53	18	0.70	24	0.94
		2	9-0808-119	2.17	11	0.5	13	0.60	17	0.80	23	1.06
		2 1/2	9-0810-119	1.68	11	0.63	13	0.75	17	1.00	22	1.31
5/8	11/32	3	9-0812-119	1.43	11	0.75	13	0.90	17	1.20	23	1.62
		3 1/2	9-0814-119	1.22	11	0.88	13	1.05	17	1.40	23	1.90
		12	9-0848-119	0.34	10	3.00	12	3.60	16	4.80	21	6.41
		3/4	9-1003-119	13.50	25	0.19	30	0.23	41	0.30	58	0.43
		1	9-1004-119	10.2	25	0.25	31	0.30	41	0.40	59	0.58
		1 1/4	9-1005-119	7.7	24	0.31	29	0.38	38	0.50	56	0.73
		1 1/2	9-1006-119	6.0	23	0.38	27	0.45	36	0.60	53	0.88
		1 3/4	9-1007-119	5.0	22	0.44	26	0.53	35	0.70	51	1.02
5/8	11/32	2	9-1008-119	4.33	22	0.50	26	0.60	35	0.80	51	1.18
		2 1/2	9-1010-119	3.38	21	0.63	25	0.75	34	1.00	50	1.49
		3	9-1012-119	2.73	20	0.75	25	0.90	33	1.20	49	1.78
		3 1/2	9-1014-119	2.31	20	0.88	24	1.05	32	1.40	48	2.08
		4	9-1016-119	2.01	20	1.00	24	1.20	32	1.60	48	2.39
		12	9-1048-119	0.64	19	3.00	23	3.60	31	4.80	46	7.24

## Product Features:

- ◆ Manufactured with Chromium Alloy steel
- ◆ Uniform hole and rod sizes matched to conventional sizes
- ◆ SPC quality assurance
- ◆ Our quality means extra long life and reliable performance

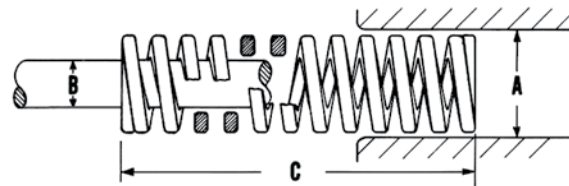

# DieMax XL® Medium Load Springs – Inch Round Wire

Hole Diam. (in) A	Rod Diam. (in) B	Free Length (in) C	CATALOG NUMBER	RATE Pounds Reqd. to deflect 1/10 in.	LOAD-DEFLECTION TABLE							
					Total Deflection for Long Life (25% of C)		Total Deflection for Avg. Life (30% of C)		Maximum Operating Deflection (37.5% of C)		Total Travel to Solid	
					Load lbs.	Defl. in.	Load lbs.	Defl. in.	Load lbs.	Defl. in.	Load lbs.	Defl. in.
3/8	3/16	3/4	9-0603-219	10.0	19	0.19	23	0.23	28	0.28	31	0.31
		1	9-0604-219	7.3	18	0.25	22	0.30	28	0.38	30	0.41
		1 1/4	9-0605-219	5.7	18	0.31	22	0.38	27	0.47	30	0.52
		1 1/2	9-0606-219	4.7	18	0.38	21	0.45	26	0.56	30	0.63
		1 3/4	9-0607-219	4.0	18	0.44	21	0.53	26	0.66	29	0.73
		2	9-0608-219	3.5	18	0.50	21	0.60	26	0.75	29	0.83
		2 1/2	9-0610-219	2.75	17	0.63	21	0.75	26	0.94	29	1.04
		3	9-0612-219	2.3	17	0.75	21	0.90	26	1.13	29	1.25
1/2	9/32	12	9-0648-219	0.57	17	3.00	21	3.60	26	4.50	29	5.06
		3/4	9-0803-219	16.5	31	0.19	37	0.23	46	0.28	53	0.32
		1	9-0804-219	12.4	31	0.25	37	0.30	47	0.38	54	0.44
		1 1/4	9-0805-219	9.6	30	0.31	36	0.38	45	0.47	53	0.55
		1 1/2	9-0806-219	7.9	30	0.38	36	0.45	45	0.56	54	0.68
		1 3/4	9-0807-219	6.6	29	0.44	35	0.53	43	0.66	51	0.78
		2	9-0808-219	5.7	29	0.5	34	0.60	43	0.75	52	0.90
		2 1/2	9-0810-219	4.45	28	0.63	33	0.75	42	0.94	50	1.12
5/8	11/32	3	9-0812-219	3.66	27	0.75	33	0.90	41	1.13	49	1.35
		3 1/2	9-0814-219	3.21	28	0.88	34	1.05	42	1.31	52	1.63
		12	9-0848-219	0.88	26	3.00	32	3.60	40	4.50	48	5.49
		3/4	9-1003-219	24.0	45	0.19	54	0.23	68	0.28	74	0.31
		1	9-1004-219	18.2	46	0.25	55	0.30	68	0.38	78	0.43
		1 1/4	9-1005-219	13.7	43	0.31	51	0.38	64	0.47	74	0.54
		1 1/2	9-1006-219	11.1	42	0.38	50	0.45	62	0.56	72	0.65
		1 3/4	9-1007-219	9.2	40	0.44	48	0.53	61	0.66	70	0.76
5/8	11/32	2	9-1008-219	7.90	40	0.50	47	0.60	59	0.75	69	0.87
		2 1/2	9-1010-219	6.10	38	0.63	46	0.75	58	0.94	66	1.08
		3	9-1012-219	5.00	38	0.75	45	0.90	57	1.13	65	1.30
		3 1/2	9-1014-219	4.28	37	0.88	45	1.05	56	1.31	65	1.52
		4	9-1016-219	3.73	37	1.00	45	1.20	56	1.50	65	1.75
		12	9-1048-219	1.19	36	3.00	43	3.60	54	4.50	63	5.26

# DieMax XL® Heavy Load Springs – Inch Round Wire

Hole Diam. (in) A	Rod Diam. (in) B	Free Length (in) C	CATALOG NUMBER	RATE Pounds Reqd. to deflect 1/10 in.	LOAD-DEFLECTION TABLE							
					Total Deflection for Long Life (20% of C)		Total Deflection for Avg. Life (25% of C)		Maximum Operating Deflection (30% of C)		Total Travel to Solid	
					Load lbs.	Defl. in.	Load lbs.	Defl. in.	Load lbs.	Defl. in.	Load lbs.	Defl. in.
3/8	3/16	3/4	9-0603-269	15.7	24	0.15	29	0.19	35	0.23	39	0.25
		1	9-0604-269	11.8	24	0.20	29	0.25	35	0.30	40	0.34
		1 1/4	9-0605-269	9.2	23	0.25	29	0.31	34	0.38	40	0.43
		1 1/2	9-0606-269	7.4	22	0.30	28	0.38	33	0.45	38	0.52
		1 3/4	9-0607-269	6.2	22	0.35	27	0.44	32	0.53	36	0.58
		2	9-0608-269	5.5	22	0.40	27	0.50	33	0.60	38	0.70
		2 1/2	9-0610-269	4.38	22	0.50	27	0.63	33	0.75	39	0.90
		3	9-0612-269	3.59	22	0.60	27	0.75	32	0.90	38	1.06
1/2	9/32	12	9-0648-269	0.87	21	2.40	26	3.00	31	3.60	38	4.32
		3/4	9-0803-269	28.5	43	0.15	53	0.19	64	0.23	71	0.25
		1	9-0804-269	21.4	43	0.20	54	0.25	64	0.30	75	0.35
		1 1/4	9-0805-269	16.5	41	0.25	52	0.31	62	0.38	73	0.44
		1 1/2	9-0806-269	13.4	40	0.30	50	0.38	60	0.45	72	0.54
		1 3/4	9-0807-269	11.2	39	0.35	49	0.44	59	0.53	70	0.62
		2	9-0808-269	9.9	39	0.40	49	0.50	59	0.60	73	0.74
		2 1/2	9-0810-269	7.7	39	0.50	48	0.63	58	0.75	72	0.93
5/8	11/32	3	9-0812-269	6.4	38	0.60	48	0.75	57	0.90	71	1.12
		3 1/2	9-0814-269	5.4	38	0.70	47	0.88	57	1.05	71	1.30
		12	9-0848-269	1.52	36	2.40	46	3.00	55	3.60	68	4.49
		3/4	9-1003-269	62.0	93	0.15	116	0.19	140	0.23	161	0.26
		1	9-1004-269	46.6	93	0.20	117	0.25	140	0.30	168	0.36
		1 1/4	9-1005-269	35.0	87	0.25	109	0.31	131	0.38	159	0.45
		1 1/2	9-1006-269	28.5	86	0.30	107	0.38	128	0.45	160	0.56
		1 3/4	9-1007-269	23.3	82	0.35	102	0.44	122	0.53	149	0.64
5/8	11/32	2	9-1008-269	20.3	81	0.40	101	0.50	122	0.60	151	0.74
		2 1/2	9-1010-269	15.9	79	0.50	99	0.63	119	0.75	149	0.94
		3	9-1012-269	13.0	78	0.60	98	0.75	117	0.90	149	1.14
		3 1/2	9-1014-269	11.2	78	0.70	98	0.88	117	1.05	151	1.35
		4	9-1016-269	9.7	77	0.80	97	1.00	116	1.20	150	1.55
		12	9-1048-269	3.09	74	2.40	93	3.00	111	3.60	145	4.68

Note: All springs are available unpainted by adding the suffix "NP" to the end of the part number.

# JIS Spring Selection Steps

## JIS

This chart converts compressed lengths to free lengths.

C Free Length (mm)	EXTRA LIGHT LOAD H-Compressed Length (mm)			LIGHT LOAD H-Compressed Length (mm)			MEDIUM LOAD H-Compressed Length (mm)			HEAVY LOAD H-Compressed Length (mm)			EXTRA HEAVY LOAD H-Compressed Length (mm)		
	Long Life 40%	Average Life 45%	Maximum Deflection 50%	Long Life 32%	Average Life 36%	Maximum Deflection 40%	Long Life 25.6%	Average Life 28.8%	Maximum Deflection 32%	Long Life 19.2%	Average Life 21.6%	Maximum Deflection 24%	Long Life 16%	Average Life 18%	Maximum Deflection 20%
20	12.0	11.0	10.0	13.6	12.8	12.0	14.9	14.2	13.6	16.2	15.7	15.2	16.8	16.4	16.0
25	15.0	13.8	12.5	17.0	16.0	15.0	18.6	17.8	17.0	20.2	19.6	19.0	21.0	20.5	20.0
30	18.0	16.5	15.0	20.4	19.2	18.0	22.3	21.4	20.4	24.2	23.5	22.8	25.2	24.6	24.0
35	21.0	19.3	17.5	23.8	22.4	21.0	26.0	24.9	23.8	28.3	27.4	26.6	29.4	28.7	28.0
40	24.0	22.0	20.0	27.2	25.6	24.0	29.8	28.5	27.2	32.3	31.4	30.4	33.6	32.8	32.0
45	27.0	24.8	22.5	30.6	28.8	27.0	33.5	32.0	30.6	36.4	35.3	34.2	37.8	36.9	36.0
50	30.0	27.5	25.0	34.0	32.0	30.0	37.2	35.6	34.0	40.4	39.2	38.0	42.0	41.0	40.0
55	33.0	30.3	27.5	37.4	35.2	33.0	40.9	39.2	37.4	44.4	43.1	41.8	46.2	45.1	44.0
60	36.0	33.0	30.0	40.8	38.4	36.0	44.6	42.7	40.8	48.5	47.0	45.6	50.4	49.2	48.0
65	39.0	35.8	32.5	44.2	41.6	39.0	48.4	46.3	44.2	52.5	51.0	49.4	54.6	53.3	52.0
70	42.0	38.5	35.0	47.6	44.8	42.0	52.1	49.8	47.6	56.6	54.9	53.2	58.8	57.4	56.0
75	45.0	41.3	37.5	51.0	48.0	45.0	55.8	53.4	51.0	60.6	58.8	57.0	63.0	61.5	60.0
80	48.0	44.0	40.0	54.4	51.2	48.0	59.5	57.0	54.4	64.6	62.7	60.8	67.2	65.6	64.0
85	51.0	46.8	42.5	57.8	54.4	51.0	63.2	60.5	57.8	68.7	66.6	64.6	71.4	69.7	68.0
90	54.0	49.5	45.0	61.2	57.6	54.0	67.0	64.1	61.2	72.7	70.6	68.4	75.6	73.8	72.0
100	60.0	55.0	50.0	68.0	64.0	60.0	74.4	71.2	68.0	80.8	78.4	76.0	84.0	82.0	80.0
125	75.0	68.8	62.5	85.0	80.0	75.0	93.0	89.0	85.0	101.0	98.0	95.0	105.0	102.5	100.0
150	90.0	82.5	75.0	102.0	96.0	90.0	111.6	106.8	102.0	121.2	117.6	114.0	126.0	123.0	120.0
175	105.0	96.3	87.5	119.0	112.0	105.0	130.2	124.6	119.0	141.4	137.2	133.0	147.0	143.5	140.0
200	120.0	110.0	100.0	136.0	128.0	120.0	148.8	142.4	136.0	161.6	156.8	152.0	168.0	164.0	160.0
250	150.0	137.5	125.0	170.0	160.0	150.0	186.0	178.0	170.0	202.0	196.0	190.0	210.0	205.0	200.0
300	180.0	165.0	150.0	204.0	192.0	180.0	223.2	213.6	204.0	242.4	235.2	228.0	252.0	246.0	240.0

## Metric springs conform to the Japanese Industrial Standards (JIS)

For years, we have manufactured high quality springs in all standard ISO sizes and a series of round wire springs, following ISO 9001:2015 quality standards – all in inch sizes. With the springs in this catalog, we are making available a line of true-metric springs, in all the standard JIS sizes and colors.

This extension of the spring line gives more options to customers with exacting requirements, and best of all, makes them available from the same reliable source as the inch springs. If you need help finding a specific heavy-duty compression spring, give us a call.



**EXTRA LIGHT LOAD**  
Yellow



**LIGHT LOAD**  
Blue



**MEDIUM LOAD**  
Red



**HEAVY LOAD**  
Green



**EXTRA HEAVY LOAD**  
Brown

# DieMax XL<sup>®</sup> Extra-Light Load Springs – JIS

Outer Dia. (mm) A	Inner Dia. (mm) B	Wire Size (mm)	Free Length (mm) C	Catalog Number	Spring *Rate kgf/mm	LOAD-DEFLECTION TABLE					
						0.3 million		0.5 million		1 million	
						Defl. mm	Load kgf (N)	Defl. mm	Load kgf (N)	Defl. mm	Load kgf (N)
10	5	2.1 x 0.8	20	91-1020	1.00	10.0	9.0	8.0	10 (98.1)	9 (88.3)	8 (78.5)
			25	91-1025	0.80	12.5	11.2	10.0			
			30	91-1030	0.67	15.0	13.5	12.0			
			35	91-1035	0.57	17.5	15.7	14.0			
			40	91-1040	0.50	20.0	18.0	16.0			
			45	91-1045	0.44	22.5	20.2	18.0			
			50	91-1050	0.40	25.0	22.5	20.0			
			55	91-1055	0.36	27.5	24.7	22.0			
			60	91-1060	0.33	30.0	27.0	24.0			
			65	91-1065	0.31	32.5	29.2	26.0			
			70	91-1070	0.29	35.0	31.5	28.0			
			75	91-1075	0.27	37.5	33.7	30.0			
80	91-1080	0.25	40.0	36.0	32.0						
12	6	2.5 x 1.2	20	91-1220	1.40	10.0	9.0	8.0	14 (137.3)	12.5 (122.6)	11 (107.9)
			25	91-1225	1.12	12.5	11.2	10.0			
			30	91-1230	0.93	15.0	13.5	12.0			
			35	91-1235	0.80	17.5	15.7	14.0			
			40	91-1240	0.70	20.0	18.0	16.0			
			45	91-1245	0.62	22.5	20.2	18.0			
			50	91-1250	0.56	25.0	22.5	20.0			
			55	91-1255	0.51	27.5	24.7	22.0			
			60	91-1260	0.47	30.0	27.0	24.0			
			65	91-1265	0.43	32.5	29.2	26.0			
			70	91-1270	0.40	35.0	31.5	28.0			
			75	91-1275	0.37	37.5	33.7	30.0			
80	91-1280	0.35	40.0	36.0	32.0						
14	7	3.1 x 1.2	25	91-1425	1.44	12.5	11.2	10.0	18 (176.5)	16 (156.9)	14.5 (142.2)
			30	91-1430	1.20	15.0	13.5	12.0			
			35	91-1435	1.03	17.5	15.7	14.0			
			40	91-1440	0.90	20.0	18.0	16.0			
			45	91-1445	0.80	22.5	20.2	18.0			
			50	91-1450	0.72	25.0	22.5	20.0			
			55	91-1455	0.65	27.5	24.7	22.0			
			60	91-1460	0.60	30.0	27.0	24.0			
			65	91-1465	0.55	32.5	29.2	26.0			
			70	91-1470	0.51	35.0	31.5	28.0			
			75	91-1475	0.48	37.5	33.7	30.0			
			80	91-1480	0.45	40.0	36.0	32.0			
90	91-1490	0.40	45.0	40.5	36.0						
16	8	3.5 x 1.4	25	91-1625	1.68	12.5	11.2	10.0	21 (206)	19 (186.3)	17 (166.7)
			30	91-1630	1.40	15.0	13.5	12.0			
			35	91-1635	1.20	17.5	15.7	14.0			
			40	91-1640	1.05	20.0	18.0	16.0			
			45	91-1645	0.94	22.5	20.0	18.0			
			50	91-1650	0.84	25.0	22.5	20.0			
			55	91-1655	0.77	27.5	24.7	22.0			
			60	91-1660	0.70	30.0	27.0	24.0			
			65	91-1665	0.65	32.5	29.2	26.0			
			70	91-1670	0.60	35.0	31.5	28.0			
			75	91-1675	0.56	37.5	33.7	30.0			
			80	91-1680	0.53	40.0	36.0	32.0			
90	91-1690	0.47	45.0	40.5	36.0						
100	91-16100	0.42	50.0	45.0	40.0						

Outer Dia. (mm) A	Inner Dia. (mm) B	Wire Size (mm)	Free Length (mm) C	Catalog Number	Spring *Rate kgf/mm	LOAD-DEFLECTION TABLE											
						0.3 million		0.5 million		1 million							
						Defl. mm	Load kgf (N)	Defl. mm	Load kgf (N)	Defl. mm	Load kgf (N)						
18	9	3.9 x 1.5	25	91-1825	2.08	12.5	11.2	10.0	26 (255)	23 (226)	21 (206)						
			30	91-1830	1.74	15.0	13.5	12.0									
			35	91-1835	1.49	17.5	15.7	14.0									
			40	91-1840	1.30	20.0	18.0	16.0									
			45	91-1845	1.16	22.5	20.2	18.0									
			50	91-1850	1.04	25.0	22.5	20.0									
			55	91-1855	0.95	27.5	24.7	22.0									
			60	91-1860	0.87	30.0	27.0	24.0									
			65	91-1865	0.80	32.5	29.2	26.0									
			70	91-1870	0.74	35.0	31.5	28.0									
			75	91-1875	0.70	37.5	33.7	30.0									
			80	91-1880	0.65	40.0	36.0	32.0									
			90	91-1890	0.58	45.0	40.5	36.0									
			100	91-18100	0.52	50.0	45.0	40.0									
			20	11	4.0 x 1.7	25	91-2025	2.56				12.5	11.2	10.0	32 (313.8)	29 (284.4)	26 (255.0)
						30	91-2030	2.13				15.0	13.5	12.0			
35	91-2035	1.83				17.5	15.7	14.0									
40	91-2040	1.60				20.0	18.0	16.0									
45	91-2045	1.42				22.5	20.2	18.0									
50	91-2050	1.28				25.0	22.5	20.0									
55	91-2055	1.16				27.5	24.7	22.0									
60	91-2060	1.07				30.0	27.0	24.0									
65	91-2065	0.98				32.5	29.2	26.0									
70	91-2070	0.91				35.0	31.5	28.0									
75	91-2075	0.85				37.5	33.7	30.0									
80	91-2080	0.80				40.0	36.0	32.0									
90	91-2090	0.71				45.0	40.5	36.0									
100	91-20100	0.64				50.0	45.0	40.0									
125	91-20125	0.51				62.5	56.2	50.0									
150	91-20150	0.43				75.0	67.5	60.0									
22	11	4.7 x 1.9	25	91-2225	3.20	12.5	11.2	10.0	40 (392)	36 (353)	32 (314)						
			30	91-2230	2.67	15.0	13.5	12.0									
			35	91-2235	2.29	17.5	15.7	14.0									
			40	91-2240	2.00	20.0	18.0	16.0									
			45	91-2245	1.78	22.5	20.2	18.0									
			50	91-2250	1.60	25.0	22.5	20.0									
			55	91-2255	1.46	27.5	24.7	22.0									
			60	91-2260	1.33	30.0	27.0	24.0									
			65	91-2265	1.23	32.5	29.2	26.0									
			70	91-2270	1.14	35.0	31.5	28.0									
			75	91-2275	1.07	37.5	33.7	30.0									
			80	91-2280	1.00	40.0	36.0	32.0									
			90	91-2290	0.89	45.0	40.5	36.0									
			100	91-22100	0.8	50.0	45.0	40.0									
			125	91-22125	0.64	62.5	56.2	50.0									
			150	91-22150	0.53	75.0	67.5	60.0									

\* 1 daN = 1.0197 Kg (Force)





# DieMax XL® Extra-Light Load Springs – JIS

Outer Dia. (mm) A	Inner Dia. (mm) B	Wire Size (mm)	Free Length (mm) C	Catalog Number	Spring *Rate kgf/mm	LOAD-DEFLECTION TABLE					
						0.3 million		0.5 million		1 million	
						Defl. mm	Load kgf (N)	Defl. mm	Load kgf (N)	Defl. mm	Load kgf (N)
25	13.5	5.6 x 2.2	25	91-2525	4.00	12.5	11.2	10.0	50 (490.3)	45 (441.3)	40 (392.3)
			30	91-2530	3.33	15.0	13.5	12.0			
			35	91-2535	2.85	17.5	15.7	14.0			
			40	91-2540	2.50	20.0	18.0	16.0			
			45	91-2545	2.22	22.5	20.2	18.0			
			50	91-2550	2.00	25.0	22.5	20.0			
			55	91-2555	1.82	27.5	24.7	22.0			
			60	91-2560	1.67	30.0	27.0	24.0			
			65	91-2565	1.54	32.5	29.2	26.0			
			70	91-2570	1.43	35.0	31.5	28.0			
			75	91-2575	1.33	37.5	33.7	30.0			
			80	91-2580	1.25	40.0	36.0	32.0			
			90	91-2590	1.11	45.0	40.5	36.0			
			100	91-25100	1.00	50.0	45.0	40.0			
			125	91-25125	0.80	62.5	56.2	50.0			
			150	91-25150	0.67	75.0	67.5	60.0			
			175	91-25175	0.57	87.5	78.7	70.0			
27	13.5	6.4 x 2.2	25	91-2725	4.80	12.5	11.2	10.0	60 (588)	54 (530)	48 (471)
			30	91-2730	4.00	15.0	13.5	12.0			
			35	91-2735	3.43	17.5	15.7	14.0			
			40	91-2740	3.00	20.0	18.0	16.0			
			45	91-2745	2.67	22.5	20.2	18.0			
			50	91-2750	2.40	25.0	22.5	20.0			
			55	91-2755	2.18	27.5	24.7	22.0			
			60	91-2760	2.00	30.0	27.0	24.0			
			65	91-2765	1.85	32.5	29.2	26.0			
			70	91-2770	1.71	35.0	31.5	28.0			
			75	91-2775	1.60	37.5	33.7	30.0			
			80	91-2780	1.50	40.0	36.0	32.0			
			90	91-2790	1.33	45.0	40.5	36.0			
			100	91-27100	1.20	50.0	45.0	40.0			
			125	91-27125	0.96	62.5	56.2	50.0			
			150	91-27150	0.80	75.0	67.5	60.0			
			175	91-27175	0.69	87.5	78.7	70.0			
30	16	6.0 x 2.7	25	91-3025	5.80	12.5	11.2	10.0	72 (706.1)	65 (637.4)	58 (568.8)
			30	91-3030	4.80	15.0	13.5	12.0			
			35	91-3035	4.13	17.5	15.7	14.0			
			40	91-3040	3.60	20.0	18.0	16.0			
			45	91-3045	3.21	22.5	20.2	18.0			
			50	91-3050	2.88	25.0	22.5	20.0			
			55	91-3055	2.63	27.5	24.7	22.0			
			60	91-3060	2.40	30.0	27.0	24.0			
			65	91-3065	2.22	32.5	29.2	26.0			
			70	91-3070	2.05	35.0	31.5	28.0			
			75	91-3075	1.93	37.5	33.7	30.0			
			80	91-3080	1.80	40.0	36.0	32.0			
			90	91-3090	1.60	45.0	40.5	36.0			
			100	91-30100	1.44	50.0	45.0	40.0			
			125	91-30125	1.15	62.5	56.2	50.0			
			150	91-30150	0.96	75.0	67.5	60.0			
			175	91-30175	0.82	87.5	78.7	70.0			
200	91-30200	0.72	100.0	90.0	80.0						

Outer Dia. (mm) A	Inner Dia. (mm) B	Wire Size (mm)	Free Length (mm) C	Catalog Number	Spring *Rate kgf/mm	LOAD-DEFLECTION TABLE											
						0.3 million		0.5 million		1 million							
						Defl. mm	Load kgf (N)	Defl. mm	Load kgf (N)	Defl. mm	Load kgf (N)						
35	19	7.4 x 2.8	40	91-3540	4.90	20.0	18.0	16.0	98 (961.1)	88 (863.0)	78 (764.9)						
			45	91-3545	4.36	22.5	20.2	18.0									
			50	91-3550	3.92	25.0	22.5	20.0									
			55	91-3555	3.56	27.5	24.7	22.0									
			60	91-3560	3.26	30.0	27.0	24.0									
			65	91-3565	3.02	32.5	29.2	26.0									
			70	91-3570	2.80	35.0	31.5	28.0									
			75	91-3575	2.61	37.5	33.7	30.0									
			80	91-3580	2.45	40.0	36.0	32.0									
			90	91-3590	2.17	45.0	40.5	36.0									
			100	91-35100	1.96	50.0	45.0	40.0									
			125	91-35125	1.57	62.5	56.2	50.0									
			150	91-35150	1.30	75.0	67.5	60.0									
			175	91-35175	1.12	87.5	78.7	70.0									
			200	91-35200	0.98	100.0	90.0	80.0									
			40	22	8.5 x 3.2	40	91-4040	6.38				20.0	18.0	16.0	128 (1255.3)	115 (1127.8)	102 (1000.3)
						50	91-4050	5.12				25.0	22.5	18.0			
60	91-4060	4.26				30.0	27.0	20.0									
70	91-4070	3.65				35.0	31.5	22.0									
80	91-4080	3.20				40.0	36.0	24.0									
90	91-4090	2.84				45.0	40.5	26.0									
100	91-40100	2.56				50.0	45.0	28.0									
125	91-40125	2.04				62.5	56.2	30.0									
150	91-40150	1.70				75.0	67.5	32.0									
175	91-40175	1.46				87.5	78.7	36.0									
200	91-40200	1.28				100.0	90.0	40.0									
250	91-40250	1.02				125.0	112.5	50.0									
50	27.5	10.6 x 4.0				50	91-5050	8.00	25.0	22.5	20.0	200 (1961.3)	180 (1765.2)	160 (1569.1)			
						60	91-5060	6.66	30.0	27.0	24.0						
						70	91-5070	5.71	35.0	31.5	28.0						
						80	91-5080	5.00	40.0	36.0	32.0						
						90	91-5090	4.44	45.0	40.5	36.0						
			100	91-50100	4.00	50.0	45.0	40.0									
			125	91-50125	3.20	62.5	56.2	50.0									
			150	91-50150	2.66	75.0	67.5	60.0									
			175	91-50175	2.28	87.5	78.7	70.0									
			200	91-50200	2.00	100.0	90.0	80.0									
			250	91-50250	1.60	125.0	112.5	100.0									
			300	91-50300	1.33	150.0	135.0	120.0									
			60	33	13.0 x 4.8	60	91-6060	9.59	30.0	27.0	24.0				288 (2824.3)	259 (2539.9)	230 (2255.5)
						70	91-6070	8.22	35.0	31.5	28.0						
						80	91-6080	7.19	40.0	36.0	32.0						
						90	91-6090	6.40	45.0	40.5	36.0						
						100	91-60100	5.76	50.0	45.0	40.0						
125	91-60125	4.60				62.5	56.2	50.0									
150	91-60150	3.84				75.0	67.5	60.0									
175	91-60175	3.29				87.5	78.7	70.0									
200	91-60200	2.88				100.0	90.0	80.0									
250	91-60250	2.30				125.0	112.5	100.0									
300	91-60300	1.92				150.0	135.0	120.0									

\* 1 daN = 1.0197 Kg (Force)

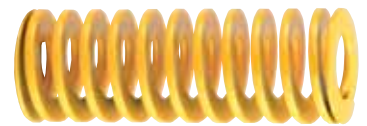
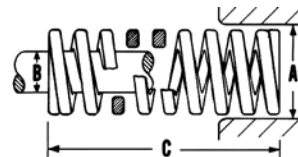

# DieMax XL® Light Load Springs – JIS

Outer Dia. (mm) A	Inner Dia. (mm) B	Wire Size (mm)	Free Length (mm) C	Catalog Number	Spring *Rate kgf/mm	LOAD-DEFLECTION TABLE					
						0.3 million		0.5 million		1 million	
						Defl. mm	Load kgf (N)	Defl. mm	Load kgf (N)	Defl. mm	Load kgf (N)
10	5	2.0 x 1.0	20	92-1020	1.81	8.0	7.2	6.4	14.5 (142.2)	13 (127.5)	11.5 (112.8)
			25	92-1025	1.45	10.0	9.0	8.0			
			30	92-1030	1.21	12.0	10.8	9.6			
			35	92-1035	1.03	14.0	12.6	11.2			
			40	92-1040	0.90	16.0	14.4	12.8			
			45	92-1045	0.80	18.0	16.2	14.4			
			50	92-1050	0.73	20.0	18.0	16.0			
			55	92-1055	0.66	22.0	19.8	17.6			
			60	92-1060	0.60	24.0	21.6	19.2			
			65	92-1065	0.55	26.0	23.4	20.8			
12	6	2.6 x 1.3	20	92-1220	2.63	8.0	7.2	6.4	21 (206)	19 (186.3)	17 (166.7)
			25	92-1225	2.10	10.0	9.0	8.0			
			30	92-1230	1.75	12.0	10.8	9.6			
			35	92-1235	1.50	14.0	12.6	11.2			
			40	92-1240	1.32	16.0	14.4	12.8			
			45	92-1245	1.17	18.0	16.2	14.4			
			50	92-1250	1.05	20.0	18.0	16.0			
			55	92-1255	0.96	22.0	19.8	17.6			
			60	92-1260	0.88	24.0	21.6	19.2			
			65	92-1265	0.81	26.0	23.4	20.8			
14	7	3.0 x 1.4	25	92-1425	2.80	10.0	9.0	8.0	28 (275)	25 (245)	22 (216)
			30	92-1430	2.34	12.0	10.8	9.6			
			35	92-1435	2.00	14.0	12.6	11.2			
			40	92-1440	1.75	16.0	14.4	12.8			
			45	92-1445	1.56	18.0	16.2	14.4			
			50	92-1450	1.40	20.0	18.0	16.0			
			55	92-1455	1.27	22.0	19.8	17.6			
			60	92-1460	1.17	24.0	21.6	19.2			
			65	92-1465	1.08	26.0	23.4	20.8			
			70	92-1470	1.00	28.0	25.2	22.4			
16	8	3.6 x 1.6	25	92-1625	3.50	10.0	9.0	8.0	35 (343)	32 (314)	28 (275)
			30	92-1630	2.92	12.0	10.8	9.6			
			35	92-1635	2.50	14.0	12.6	11.2			
			40	92-1640	2.19	16.0	14.4	12.8			
			45	92-1645	1.95	18.0	16.2	14.4			
			50	92-1650	1.75	20.0	18.0	16.0			
			55	92-1655	1.60	22.0	19.8	17.6			
			60	92-1660	1.46	24.0	21.6	19.2			
			65	92-1665	1.35	26.0	23.4	20.8			
			70	92-1670	1.25	28.0	25.2	22.4			

Outer Dia. (mm) A	Inner Dia. (mm) B	Wire Size (mm)	Free Length (mm) C	Catalog Number	Spring *Rate kgf/mm	LOAD-DEFLECTION TABLE					
						0.3 million		0.5 million		1 million	
						Defl. mm	Load kgf (N)	Defl. mm	Load kgf (N)	Defl. mm	Load kgf (N)
18	9	4.0 x 1.8	25	92-1825	4.30	10.0	9.0	8.0	43 (422)	39 (382)	34 (333)
			30	92-1830	3.58	12.0	10.8	9.6			
			35	92-1835	3.07	14.0	12.6	11.2			
			40	92-1840	2.69	16.0	14.4	12.8			
			45	92-1845	2.39	18.0	16.2	14.4			
			50	92-1850	2.15	20.0	18.0	16.0			
			55	92-1855	1.96	22.0	19.8	17.6			
			60	92-1860	1.79	24.0	21.6	19.2			
			65	92-1865	1.66	26.0	23.4	20.8			
			70	92-1870	1.54	28.0	25.2	22.4			
20	10	4.5 x 2.0	25	92-2025	5.40	10.0	9.0	8.0	54 (529.6)	49 (481)	43 (421.7)
			30	92-2030	4.50	12.0	10.8	9.6			
			35	92-2035	3.86	14.0	12.6	11.2			
			40	92-2040	3.38	16.0	14.4	12.8			
			45	92-2045	3.00	18.0	16.2	14.4			
			50	92-2050	2.70	20.0	18.0	16.0			
			55	92-2055	2.45	22.0	19.8	17.6			
			60	92-2060	2.25	24.0	21.6	19.2			
			65	92-2065	2.08	26.0	23.4	20.8			
			70	92-2070	1.93	28.0	25.2	22.4			
22	11	4.9 x 2.2	25	92-2225	6.70	10.0	9.0	8.0	67 (657)	60 (588)	54 (530)
			30	92-2230	5.60	12.0	10.8	9.6			
			35	92-2235	4.80	14.0	12.6	11.2			
			40	92-2240	4.20	16.0	14.4	12.8			
			45	92-2245	3.72	18.0	16.2	14.4			
			50	92-2250	3.35	20.0	18.0	16.0			
			55	92-2255	3.05	22.0	19.8	17.6			
			60	92-2260	2.80	24.0	21.6	19.2			
			65	92-2265	2.58	26.0	23.4	20.8			
			70	92-2270	2.40	28.0	25.2	22.4			

\* 1 daN = 1.0197 Kg (Force)

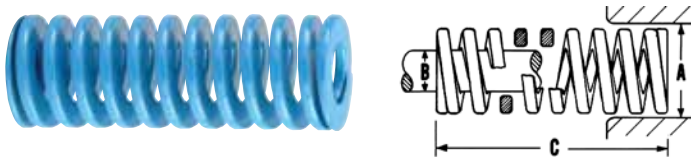

# DieMax XL® Light Load Springs – JIS

Outer Dia. (mm) A	Inner Dia. (mm) B	Wire Size (mm)	Free Length (mm) C	Catalog Number	Spring *Rate kgf/mm	LOAD-DEFLECTION TABLE					
						0.3 million		0.5 million		1 million	
						Defl. mm	Load kgf (N)	Defl. mm	Load kgf (N)	Defl. mm	Load kgf (N)
25	12.5	5.7 x 2.5	25	92-2525	8.40	10.0	9.0	8.0	84 (823.8)	76 (745)	67 (657.1)
			30	92-2530	7.00	12.0	10.8	9.6			
			35	92-2535	6.00	14.0	12.6	11.2			
			40	92-2540	5.25	16.0	14.4	12.8			
			45	92-2545	4.67	18.0	16.2	14.4			
			50	92-2550	4.20	20.0	18.0	16.0			
			55	92-2555	3.82	22.0	19.8	17.6			
			60	92-2560	3.50	24.0	21.6	19.2			
			65	92-2565	3.23	26.0	23.4	20.8			
			70	92-2570	3.00	28.0	25.2	22.4			
			75	92-2575	2.80	30.0	27.0	24.0			
			80	92-2580	2.63	32.0	28.8	25.6			
			90	92-2590	2.33	36.0	32.4	28.8			
			100	92-25100	2.10	40.0	36.0	32.0			
			125	92-25125	1.68	50.0	45.0	40.0			
			150	92-25150	1.40	60.0	54.0	48.0			
			175	92-25175	1.20	70.0	63.0	56.0			
27	13.5	6.3 x 2.7	25	92-2725	10.00	10.0	9.0	8.0	100 (981)	90 (883)	80 (785)
			30	92-2730	8.33	12.0	10.8	9.6			
			35	92-2735	7.14	14.0	12.6	11.2			
			40	92-2740	6.25	16.0	14.4	12.8			
			45	92-2745	5.56	18.0	16.2	14.4			
			50	92-2750	5.00	20.0	18.0	16.0			
			55	92-2755	4.55	22.0	19.8	17.6			
			60	92-2760	4.17	24.0	21.6	19.2			
			65	92-2765	3.85	26.0	23.4	20.8			
			70	92-2770	3.57	28.0	25.2	22.4			
			75	92-2775	3.33	30.0	27.0	24.0			
			80	92-2780	3.13	32.0	28.8	25.6			
			90	92-2790	2.78	36.0	32.4	28.8			
			100	92-27100	2.50	40.0	36.0	32.0			
			125	92-27125	2.00	50.0	45.0	40.0			
			150	92-27150	1.67	60.0	54.0	48.0			
			175	92-27175	1.43	70.0	63.0	56.0			
30	15	6.8 x 3.0	25	92-3025	12.11	10.0	9.0	8.0	121 (1186.6)	109 (1068.9)	97 (951.3)
			30	92-3030	10.08	12.0	10.8	9.6			
			35	92-3035	8.65	14.0	12.6	11.2			
			40	92-3040	7.56	16.0	14.4	12.8			
			45	92-3045	6.73	18.0	16.2	14.4			
			50	92-3050	6.05	20.0	18.0	16.0			
			55	92-3055	5.50	22.0	19.8	17.6			
			60	92-3060	5.04	24.0	21.6	19.2			
			65	92-3065	4.65	26.0	23.4	20.8			
			70	92-3070	4.32	28.0	25.2	22.4			
			75	92-3075	4.03	30.0	27.0	24.0			
			80	92-3080	3.78	32.0	28.8	25.6			
			90	92-3090	3.36	36.0	32.4	28.8			
			100	92-30100	3.02	40.0	36.0	32.0			
			125	92-30125	2.42	50.0	45.0	40.0			
			150	92-30150	2.01	60.0	54.0	48.0			
			175	92-30175	1.72	70.0	63.0	56.0			
200	92-30200	1.51	80.0	72.0	64.0						

Outer Dia. (mm) A	Inner Dia. (mm) B	Wire Size (mm)	Free Length (mm) C	Catalog Number	Spring *Rate kgf/mm	LOAD-DEFLECTION TABLE											
						0.3 million		0.5 million		1 million							
						Defl. mm	Load kgf (N)	Defl. mm	Load kgf (N)	Defl. mm	Load kgf (N)						
35	17.5	8.2 x 3.2	40	92-3540	10.31	16.0	14.4	12.8	165 (1618.1)	149 (1461.2)	132 (1294.5)						
			45	92-3545	9.17	18.0	16.2	14.4									
			50	92-3550	8.25	20.0	18.0	16.0									
			55	92-3555	7.50	22.0	19.8	17.6									
			60	92-3560	6.87	24.0	21.6	19.2									
			65	92-3565	6.35	26.0	23.4	20.8									
			70	92-3570	5.89	28.0	25.2	22.4									
			75	92-3575	5.50	30.0	27.0	24.0									
			80	92-3580	5.15	32.0	28.8	25.6									
			90	92-3590	4.58	36.0	32.4	28.8									
			100	92-35100	4.12	40.0	36.0	32.0									
			125	92-35125	3.30	50.0	45.0	40.0									
			150	92-35150	2.75	60.0	54.0	48.0									
			175	92-35175	2.35	70.0	63.0	56.0									
			200	92-35200	2.06	80.0	72.0	64.0									
			40	20	9.5 x 3.8	40	92-4040	13.50				16.0	14.4	12.8	216 (2118.2)	194 (1902.5)	173 (1696.6)
						50	92-4050	10.80				20.0	21.6	19.2			
60	92-4060	9.00				24.0	25.2	22.4									
70	92-4070	7.71				28.0	28.8	25.6									
80	92-4080	6.75				32.0	32.4	28.8									
90	92-4090	6.00				36.0	36.0	32.0									
100	92-40100	5.40				40.0	40.0	36.0									
125	92-40125	4.32				50.0	45.0	40.0									
150	92-40150	3.60				60.0	54.0	48.0									
175	92-40175	3.08				70.0	63.0	56.0									
200	92-40200	2.70				80.0	72.0	64.0									
50	25	12.1 x 4.8	50	92-5050	16.89	20.0	18.0	16.0	338 (3314.7)	304 (2981.2)	270 (2647.8)						
			60	92-5060	14.08	24.0	21.6	19.2									
			70	92-5070	12.07	28.0	25.2	22.4									
			80	92-5080	10.56	32.0	28.8	25.6									
			90	92-5090	9.38	36.0	32.4	28.8									
			100	92-50100	8.45	40.0	36.0	32.0									
			125	92-50125	6.76	50.0	45.0	40.0									
			150	92-50150	5.63	60.0	54.0	48.0									
			175	92-50175	4.82	70.0	63.0	56.0									
			200	92-50200	4.22	80.0	72.0	64.0									
			300	92-50300	2.81	120.0	108.0	96.0									
60	30	14.4 x 5.7	60	92-6060	20.25	24.0	21.6	19.2	486 (4766.0)	437 (4285.5)	389 (3814.8)						
			70	92-6070	17.35	28.0	25.2	22.4									
			80	92-6080	15.18	32.0	28.8	25.6									
			90	92-6090	13.50	36.0	32.4	28.8									
			100	92-60100	12.15	40.0	36.0	32.0									
			125	92-60125	9.72	50.0	45.0	40.0									
			150	92-60150	8.10	60.0	54.0	48.0									
			175	92-60175	6.94	70.0	63.0	56.0									
			200	92-60200	6.07	80.0	72.0	64.0									
			250	92-60250	4.86	100.0	90.0	80.0									
			300	92-60300	4.05	120.0	108.0	96.0									

\* 1 daN = 1.0197 Kg (Force)

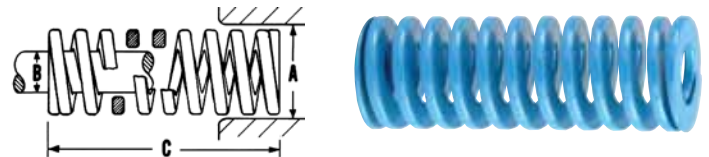

# DieMax XL® Medium Load Springs – JIS

Outer Dia. (mm) A	Inner Dia. (mm) B	Wire Size (mm)	Free Length (mm) C	Catalog Number	Spring *Rate kgf/mm	LOAD-DEFLECTION TABLE					
						0.3 million		0.5 million		1 million	
						Defl. mm	Load kgf (N)	Defl. mm	Load kgf (N)	Defl. mm	Load kgf (N)
10	5	2.0 x 1.4	20	93-1020	3.13	6.4	5.8	18	5.1	16	
			25	93-1025	2.50	8.0	7.2	18	6.4	16	
			30	93-1030	2.08	9.6	8.6	18	7.7	16	
			35	93-1035	1.78	11.2	10.1	18	9.0	16	
			40	93-1040	1.56	12.8	11.5	18	10.2	16	
			45	93-1045	1.38	14.4	13.0	18	11.5	16	
			50	93-1050	1.25	16.0	14.4	18	12.8	16	
			55	93-1055	1.13	17.6	15.8	18	14.1	16	
			60	93-1060	1.04	19.2	17.3	18	15.4	16	
			65	93-1065	0.96	20.8	18.7	18	16.6	16	
			70	93-1070	0.89	22.4	20.2	18	17.9	16	
			75	93-1075	0.83	24.0	21.6	18	19.2	16	
			80	93-1080	0.78	25.6	23.0	18	20.5	16	
12	6	2.5 x 1.5	20	93-1220	4.53	6.4	5.8	26	5.1	23	
			25	93-1225	3.62	8.0	7.2	26	6.4	23	
			30	93-1230	3.02	9.6	8.6	26	7.7	23	
			35	93-1235	2.58	11.2	10.1	26	9.0	23	
			40	93-1240	2.27	12.8	11.5	26	10.2	23	
			45	93-1245	2.01	14.4	13.0	26	11.5	23	
			50	93-1250	1.81	16.0	14.4	26	12.8	23	
			55	93-1255	1.64	17.6	15.8	26	14.1	23	
			60	93-1260	1.51	19.2	17.3	26	15.4	23	
			65	93-1265	1.39	20.8	18.7	26	16.6	23	
			70	93-1270	1.29	22.4	20.2	26	17.9	23	
			75	93-1275	1.20	24.0	21.6	26	19.2	23	
			80	93-1280	1.13	25.6	23.0	26	20.5	23	
14	7	3.0 x 1.8	25	93-1425	4.87	8.0	7.2	35	6.4	31	
			30	93-1430	4.06	9.6	8.6	35	7.7	31	
			35	93-1435	3.48	11.2	10.1	35	9.0	31	
			40	93-1440	3.04	12.8	11.5	35	10.2	31	
			45	93-1445	2.70	14.4	13.0	35	11.5	31	
			50	93-1450	2.43	16.0	14.4	35	12.8	31	
			55	93-1455	2.21	17.6	15.8	35	14.1	31	
			60	93-1460	2.03	19.2	17.3	35	15.4	31	
			65	93-1465	1.87	20.8	18.7	35	16.6	31	
			70	93-1470	1.74	22.4	20.2	35	17.9	31	
			75	93-1475	1.62	24.0	21.6	35	19.2	31	
			80	93-1480	1.52	25.6	23.0	35	20.5	31	
			90	93-1490	1.35	28.8	25.9	35	23.0	31	
16	8	3.5 x 2.1	25	93-1625	6.39	8.0	7.2	46	6.4	41	
			30	93-1630	5.32	9.6	8.6	46	7.7	41	
			35	93-1635	4.55	11.2	10.1	46	9.0	41	
			40	93-1640	3.98	12.8	11.5	46	10.2	41	
			45	93-1645	3.54	14.4	13.0	46	11.5	41	
			50	93-1650	3.18	16.0	14.4	46	12.8	41	
			55	93-1655	2.89	17.6	15.8	46	14.1	41	
			60	93-1660	2.65	19.2	17.3	46	15.4	41	
			65	93-1665	2.45	20.8	18.7	46	16.6	41	
			70	93-1670	2.27	22.4	20.2	46	17.9	41	
			75	93-1675	2.11	24.0	21.6	46	19.2	41	
			80	93-1680	1.99	25.6	23.0	46	20.5	41	
			90	93-1690	1.77	28.8	25.9	46	23.0	41	
100	93-16100	1.59	32.0	28.8	46	25.6	41				

Outer Dia. (mm) A	Inner Dia. (mm) B	Wire Size (mm)	Free Length (mm) C	Catalog Number	Spring *Rate kgf/mm	LOAD-DEFLECTION TABLE							
						0.3 million		0.5 million		1 million			
						Defl. mm	Load kgf (N)	Defl. mm	Load kgf (N)	Defl. mm	Load kgf (N)		
18	9	4.0 x 2.2	25	93-1825	8.12	8.0	7.2	65	6.4	52			
			30	93-1830	6.77	9.6	8.6	65	7.7	52			
			35	93-1835	5.80	11.2	10.1	65	9.0	52			
			40	93-1840	5.07	12.8	11.5	65	10.2	52			
			45	93-1845	4.51	14.4	13.0	65	11.5	52			
			50	93-1850	4.06	16.0	14.4	65	12.8	52			
			55	93-1855	3.69	17.6	15.8	65	14.1	52			
			60	93-1860	3.38	19.2	17.3	65	15.4	52			
			65	93-1865	3.12	20.8	18.7	65	16.6	52			
			70	93-1870	2.90	22.4	20.2	65	17.9	52			
			75	93-1875	2.70	24.0	21.6	65	19.2	52			
			80	93-1880	2.53	25.6	23.0	65	20.5	52			
			90	93-1890	2.25	28.8	25.9	65	23.0	52			
			100	93-18100	2.02	32.0	28.8	65	25.6	52			
			20	10	4.5 x 2.5	25	93-2025	10.00	8.0	7.2	80	6.4	64
						30	93-2030	8.33	9.6	8.6	80	7.7	64
						35	93-2035	7.14	11.2	10.1	80	9.0	64
40	93-2040	6.25				12.8	11.5	80	10.2	64			
45	93-2045	5.55				14.4	13.0	80	11.5	64			
50	93-2050	5.00				16.0	14.4	80	12.8	64			
55	93-2055	4.54				17.6	15.8	80	14.1	64			
60	93-2060	4.16				19.2	17.3	80	15.4	64			
65	93-2065	3.84				20.8	18.7	80	16.6	64			
70	93-2070	3.57				22.4	20.2	80	17.9	64			
75	93-2075	3.33				24.0	21.6	80	19.2	64			
80	93-2080	3.12				25.6	23.0	80	20.5	64			
90	93-2090	2.77				28.8	25.9	80	23.0	64			
100	93-20100	2.50				32.0	28.8	80	25.6	64			
125	93-20125	2.00				40.0	36.0	80	32.0	64			
150	93-20150	1.67				48.0	43.2	80	38.4	64			
22	11	5.0 x 2.8				25	93-2225	12.13	8.0	7.2	97	6.4	77
			30	93-2230	10.10	9.6	8.6	97	7.7	77			
			35	93-2235	8.65	11.2	10.1	97	9.0	77			
			40	93-2240	7.57	12.8	11.5	97	10.2	77			
			45	93-2245	6.74	14.4	13.0	97	11.5	77			
			50	93-2250	6.06	16.0	14.4	97	12.8	77			
			55	93-2255	5.50	17.6	15.8	97	14.1	77			
			60	93-2260	5.05	19.2	17.3	97	15.4	77			
			65	93-2265	4.66	20.8	18.7	97	16.6	77			
			70	93-2270	4.33	22.4	20.2	97	17.9	77			
			75	93-2275	4.04	24.0	21.6	97	19.2	77			
			80	93-2280	3.78	25.6	23.0	97	20.5	77			
			90	93-2290	3.36	28.8	25.9	97	23.0	77			
			100	93-22100	3.03	32.0	28.8	97	25.6	77			
			125	93-22125	2.42	40.0	36.0	97	32.0	77			
			150	93-22150	2.01	48.0	43.2	97	38.4	77			

\* 1 daN = 1.0197 Kg (Force)

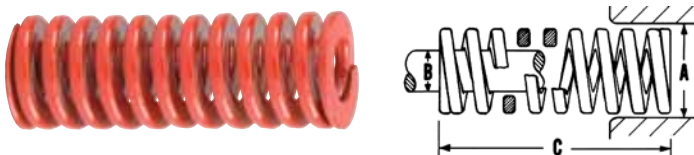

# DieMax XL<sup>®</sup> Medium Load Springs – JIS

Outer Dia. (mm) A	Inner Dia. (mm) B	Wire Size (mm)	Free Length (mm) C	Catalog Number	Spring *Rate kgf/mm	LOAD-DEFLECTION TABLE					
						0.3 million		0.5 million		1 million	
						Defl. mm	Load kgf (N)	Defl. mm	Load kgf (N)	Defl. mm	Load kgf (N)
25	12.5	5.7 x 3.1	25	93-2525	15.63	8.0	7.2	6.4	125 (1225.8)	112 (1098.3)	100 (980.7)
			30	93-2530	13.02	9.6	8.6	7.7			
			35	93-2535	11.20	11.2	10.1	9.0			
			40	93-2540	9.76	12.8	11.5	10.2			
			45	93-2545	8.68	14.4	13.0	11.5			
			50	93-2550	7.81	16.0	14.4	12.8			
			55	93-2555	7.10	17.6	15.8	14.1			
			60	93-2560	6.51	19.2	17.3	15.4			
			65	93-2565	6.00	20.8	18.7	16.6			
			70	93-2570	5.58	22.4	20.2	17.9			
			75	93-2575	5.21	24.0	21.6	19.2			
			80	93-2580	4.88	25.6	23.0	20.5			
			90	93-2590	4.34	28.8	25.9	23.0			
			100	93-25100	3.90	32.0	28.8	25.6			
			125	93-25125	3.12	40.0	36.0	32.0			
			150	93-25150	2.60	48.0	43.2	38.4			
			175	93-25175	2.23	56.0	50.4	44.8			
27	13.5	6.1 x 3.4	25	93-2725	18.25	8.0	7.2	6.4	146 (1431.8)	131 (1284.7)	117 (1147.4)
			30	93-2730	15.20	9.6	8.6	7.7			
			35	93-2735	13.04	11.2	10.1	9.0			
			40	93-2740	11.40	12.8	11.5	10.2			
			45	93-2745	10.14	14.4	13.0	11.5			
			50	93-2750	9.12	16.0	14.4	12.8			
			55	93-2755	8.30	17.6	15.8	14.1			
			60	93-2760	7.60	19.2	17.3	15.4			
			65	93-2765	7.00	20.8	18.7	16.6			
			70	93-2770	6.51	22.4	20.2	17.9			
			75	93-2775	6.08	24.0	21.6	19.2			
			80	93-2780	5.70	25.6	23.0	20.5			
			90	93-2790	5.06	28.8	25.9	23.0			
			100	93-27100	4.56	32.0	28.8	25.6			
			125	93-27125	3.65	40.0	36.0	32.0			
			150	93-27150	3.04	48.0	43.2	38.4			
			175	93-27175	2.61	56.0	50.4	44.8			
30	15	6.5 x 4.0	25	93-3025	22.50	8.0	7.2	6.4	180 (1765.2)	161 (1578.9)	144 (1412.2)
			30	93-3030	18.75	9.6	8.6	7.7			
			35	93-3035	16.10	11.2	10.1	9.0			
			40	93-3040	14.06	12.8	11.5	10.2			
			45	93-3045	12.50	14.4	13.0	11.5			
			50	93-3050	11.25	16.0	14.4	12.8			
			55	93-3055	10.23	17.6	15.8	14.1			
			60	93-3060	9.37	19.2	17.3	15.4			
			65	93-3065	8.65	20.8	18.7	16.6			
			70	93-3070	8.03	22.4	20.2	17.9			
			75	93-3075	7.50	24.0	21.6	19.2			
			80	93-3080	7.03	25.6	23.0	20.5			
			90	93-3090	6.25	28.8	25.9	23.0			
			100	93-30100	5.62	32.0	28.8	25.6			
			125	93-30125	4.50	40.0	36.0	32.0			
			150	93-30150	3.75	48.0	43.2	38.4			
			175	93-30175	3.21	56.0	50.4	44.8			
200	93-30200	2.81	64.0	57.6	51.2						

Outer Dia. (mm) A	Inner Dia. (mm) B	Wire Size (mm)	Free Length (mm) C	Catalog Number	Spring *Rate kgf/mm	LOAD-DEFLECTION TABLE											
						0.3 million		0.5 million		1 million							
						Defl. mm	Load kgf (N)	Defl. mm	Load kgf (N)	Defl. mm	Load kgf (N)						
35	17.5	7.7 x 4.3	40	93-3540	19.14	12.8	11.5	10.2	245 (2402.6)	220 (2157.4)	195 (1912.3)						
			45	93-3545	17.01	14.4	13.0	11.5									
			50	93-3550	15.31	16.0	14.4	12.8									
			55	93-3555	13.92	17.6	15.8	14.1									
			60	93-3560	12.76	19.2	17.3	15.4									
			65	93-3565	11.77	20.8	18.7	16.6									
			70	93-3570	10.93	22.4	20.2	17.9									
			75	93-3575	10.20	24.0	21.6	19.2									
			80	93-3580	9.57	25.6	23.0	20.5									
			90	93-3590	8.50	28.8	25.9	23.0									
			100	93-35100	7.65	32.0	28.8	25.6									
			125	93-35125	6.12	40.0	36.0	32.0									
			150	93-35150	5.10	48.0	43.2	38.4									
			175	93-35175	4.37	56.0	50.4	44.8									
			200	93-35200	3.82	64.0	57.6	51.2									
			40	20	9.4 x 4.8	40	93-4040	25.02				12.8	11.5	10.2	320 (3138.1)	288 (2824.3)	256 (2510.4)
						50	93-4050	20.00				16.0	14.4	12.8			
60	93-4060	16.60				19.2	17.3	15.4									
70	93-4070	14.28				22.4	20.2	17.9									
80	93-4080	12.50				25.6	23.0	20.5									
90	93-4090	11.11				28.8	25.9	23.0									
100	93-40100	10.00				32.0	28.8	25.6									
125	93-40125	8.00				40.0	36.0	32.0									
150	93-40150	6.66				48.0	43.2	38.4									
175	93-40175	5.71				56.0	50.4	44.8									
200	93-40200	5.00				64.0	57.6	51.2									
250	93-40250	4.00	80.0	72.0	64.0												
50	25	11.5 x 6.1	50	93-5050	31.25	16.0	14.4	12.8	500 (4903.3)	450 (4413.0)	400 (3922.4)						
			60	93-5060	26.04	19.2	17.3	15.4									
			70	93-5070	22.32	22.4	20.2	17.9									
			80	93-5080	19.53	25.6	23.0	20.5									
			90	93-5090	17.36	28.8	25.9	23.0									
			100	93-50100	15.62	32.0	28.8	25.6									
			125	93-50125	12.50	40.0	36.0	32.0									
			150	93-50150	10.41	48.0	43.2	38.4									
			175	93-50175	8.92	56.0	50.4	44.8									
			200	93-50200	7.81	64.0	57.6	51.2									
			250	93-50250	6.25	80.0	72.0	64.0									
300	93-50300	5.20	96.0	86.4	76.8												
60	30	13.6 x 7.6	60	93-6060	37.40	19.2	17.3	15.4	723 (7060.8)	648 (6354.7)	575 (5638.8)						
			70	93-6070	32.10	22.4	20.2	17.9									
			80	93-6080	28.12	25.6	23.0	20.5									
			90	93-6090	25.00	28.8	25.9	23.0									
			100	93-60100	22.50	32.0	28.8	25.6									
			125	93-60125	18.00	40.0	36.0	32.0									
			150	93-60150	15.00	48.0	43.2	38.4									
			175	93-60175	12.85	56.0	50.4	44.8									
			200	93-60200	11.25	64.0	57.6	51.2									
			250	93-60250	9.00	80.0	72.0	64.0									
			300	93-60300	7.50	96.0	86.4	76.8									

\* 1 daN = 1.0197 Kg (Force)

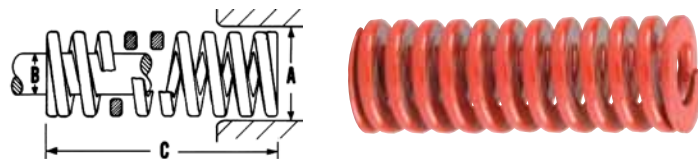

# DieMax XL® Heavy Load Springs – JIS

Outer Dia. (mm) A	Inner Dia. (mm) B	Wire Size (mm)	Free Length (mm) C	Catalog Number	Spring *Rate kgf/mm	LOAD-DEFLECTION TABLE					
						0.3 million		0.5 million		1 million	
						Defl. mm	Load kgf (N)	Defl. mm	Load kgf (N)	Defl. mm	Load kgf (N)
10	5	2.0 x 1.7	20	94-1020	6.25	4.8	4.3	3.8	30 (294.2)	27 (264.8)	24 (235.4)
			25	94-1025	5.00	6.0	5.4	4.8			
			30	94-1030	4.16	7.2	6.5	5.8			
			35	94-1035	3.57	8.4	7.5	6.7			
			40	94-1040	3.15	9.6	8.6	7.7			
			45	94-1045	2.77	10.8	9.7	8.6			
			50	94-1050	2.50	12.0	10.8	9.6			
			55	94-1055	2.27	13.2	11.8	10.6			
			60	94-1060	2.08	14.4	13.0	11.5			
			65	94-1065	1.92	15.6	14.0	12.5			
			70	94-1070	1.79	16.8	15.1	13.4			
			75	94-1075	1.67	18.0	16.2	14.4			
12	6	2.5 x 2.0	20	94-1220	8.90	4.8	4.3	3.8	43 (421.7)	38 (372.7)	34 (333.4)
			25	94-1225	7.10	6.0	5.4	4.8			
			30	94-1230	5.97	7.2	6.5	5.8			
			35	94-1235	5.11	8.4	7.5	6.7			
			40	94-1240	4.47	9.6	8.6	7.7			
			45	94-1245	3.98	10.8	9.7	8.6			
			50	94-1250	3.58	12.0	10.8	9.6			
			55	94-1255	3.25	13.2	11.8	10.6			
			60	94-1260	2.98	14.4	13.0	11.5			
			65	94-1265	2.74	15.6	14.0	12.5			
			70	94-1270	2.54	16.8	15.1	13.4			
			75	94-1275	2.37	18.0	16.2	14.4			
14	7	3.0 x 2.3	25	94-1425	9.83	6.0	5.4	4.8	59 (578.6)	53 (519.8)	47 (460.9)
			30	94-1430	8.19	7.2	6.5	5.8			
			35	94-1435	7.02	8.4	7.5	6.7			
			40	94-1440	6.14	9.6	8.6	7.7			
			45	94-1445	5.46	10.8	9.7	8.6			
			50	94-1450	4.91	12.0	10.8	9.6			
			55	94-1455	4.46	13.2	11.8	10.6			
			60	94-1460	4.09	14.4	13.0	11.5			
			65	94-1465	3.78	15.6	14.0	12.5			
			70	94-1470	3.51	16.8	15.1	13.4			
			75	94-1475	3.27	18.0	16.2	14.4			
			80	94-1480	3.07	19.2	17.3	15.4			
16	8	3.5 x 2.5	25	94-1625	18.83	6.0	5.4	4.8	77 (755)	69 (676.7)	62 (608.0)
			30	94-1630	10.69	7.2	6.5	5.8			
			35	94-1635	9.16	8.4	7.5	6.7			
			40	94-1640	8.02	9.6	8.6	7.7			
			45	94-1645	7.12	10.8	9.7	8.6			
			50	94-1650	6.41	12.0	10.8	9.6			
			55	94-1655	5.83	13.2	11.8	10.6			
			60	94-1660	5.34	14.4	13.0	11.5			
			65	94-1665	4.93	15.6	14.0	12.5			
			70	94-1670	4.58	16.8	15.1	13.4			
			75	94-1675	4.28	18.0	16.2	14.4			
			80	94-1680	4.01	19.2	17.3	15.4			

Outer Dia. (mm) A	Inner Dia. (mm) B	Wire Size (mm)	Free Length (mm) C	Catalog Number	Spring *Rate kgf/mm	LOAD-DEFLECTION TABLE					
						0.3 million		0.5 million		1 million	
						Defl. mm	Load kgf (N)	Defl. mm	Load kgf (N)	Defl. mm	Load kgf (N)
18	9	4.0 x 2.7	25	94-1825	16.16	6.0	5.4	4.8	97 (951.3)	87 (853.2)	78 (764.9)
			30	94-1830	13.47	7.2	6.5	5.8			
			35	94-1835	11.54	8.4	7.5	6.7			
			40	94-1840	10.10	9.6	8.6	7.7			
			45	94-1845	8.98	10.8	9.7	8.6			
			50	94-1850	8.08	12.0	10.8	9.6			
			55	94-1855	7.34	13.2	11.8	10.6			
			60	94-1860	6.73	14.4	13.0	11.5			
			65	94-1865	6.21	15.6	14.0	12.5			
			70	94-1870	5.77	16.8	15.1	13.4			
			75	94-1875	5.39	18.0	16.2	14.4			
			80	94-1880	5.05	19.2	17.3	15.4			
20	10	4.5 x 3.1	25	94-2025	20.00	6.0	5.4	4.8	120 (1176.8)	108 (1059.1)	96 (941.4)
			30	94-2030	16.66	7.2	6.5	5.8			
			35	94-2035	14.28	8.4	7.5	6.7			
			40	94-2040	12.50	9.6	8.6	7.7			
			45	94-2045	11.11	10.8	9.7	8.6			
			50	94-2050	10.00	12.0	10.8	9.6			
			55	94-2055	9.09	13.2	11.8	10.6			
			60	94-2060	8.33	14.4	13.0	11.5			
			65	94-2065	7.69	15.6	14.0	12.5			
			70	94-2070	7.14	16.8	15.1	13.4			
			75	94-2075	6.67	18.0	16.2	14.4			
			80	94-2080	6.25	19.2	17.3	15.4			
22	11	5.1 x 3.4	25	94-2225	24.16	6.0	5.4	4.8	145 (1422.0)	130 (1274.9)	116 (1137.6)
			30	94-2230	20.13	7.2	6.5	5.8			
			35	94-2235	17.30	8.4	7.5	6.7			
			40	94-2240	15.10	9.6	8.6	7.7			
			45	94-2245	13.40	10.8	9.7	8.6			
			50	94-2250	12.08	12.0	10.8	9.6			
			55	94-2255	10.94	13.2	11.8	10.6			
			60	94-2260	10.06	14.4	13.0	11.5			
			65	94-2265	9.28	15.6	14.0	12.5			
			70	94-2270	8.63	16.8	15.1	13.4			
			75	94-2275	8.04	18.0	16.2	14.4			
			80	94-2280	7.55	19.2	17.3	15.4			

\* 1 daN = 1.0197 Kg (Force)



# DieMax XL® Heavy Load Springs – JIS

Outer Dia. (mm) A	Inner Dia. (mm) B	Wire Size (mm)	Free Length (mm) C	Catalog Number	Spring *Rate kgf/mm	LOAD-DEFLECTION TABLE					
						0.3 million		0.5 million		1 million	
						Defl. mm	Load kgf (N)	Defl. mm	Load kgf (N)	Defl. mm	Load kgf (N)
25	12.5	5.8 x 3.9	25	94-2525	31.20	6.0	5.4	4.8	187 (1833.8)	169 (1657.0)	150 (1471.0)
			30	94-2530	25.97	7.2	6.5	5.8			
			35	94-2535	22.38	8.4	7.5	6.7			
			40	94-2540	19.47	9.6	8.6	7.7			
			45	94-2545	17.40	10.8	9.7	8.6			
			50	94-2550	15.58	12.0	10.8	9.6			
			55	94-2555	14.20	13.2	11.9	10.6			
			60	94-2560	12.98	14.4	13.0	11.5			
			65	94-2565	12.00	15.6	14.0	12.5			
			70	94-2570	11.13	16.8	15.1	13.4			
			75	94-2575	10.40	18.0	16.2	14.4			
			80	94-2580	9.73	19.2	17.3	15.4			
			90	94-2590	8.65	21.6	19.4	17.3			
			100	94-25100	7.79	24.0	21.6	19.2			
			125	94-25125	6.23	30.0	27.0	24.0			
			150	94-25150	5.20	36.0	32.4	28.8			
			175	94-25175	4.46	42.0	37.8	33.6			
27	13.5	6.3 x 4.2	25	94-2725	36.40	6.0	5.4	4.8	219 (2147.7)	197 (1931.9)	175 (1716.2)
			30	94-2730	30.41	7.2	6.5	5.8			
			35	94-2735	26.20	8.4	7.5	6.7			
			40	94-2740	22.81	9.6	8.6	7.7			
			45	94-2745	20.30	10.8	9.7	8.6			
			50	94-2750	18.25	12.0	10.8	9.6			
			55	94-2755	16.50	13.2	11.9	10.6			
			60	94-2760	15.20	14.4	13.0	11.5			
			65	94-2765	14.00	15.6	14.0	12.5			
			70	94-2770	13.03	16.8	15.1	13.4			
			75	94-2775	12.10	18.0	16.2	14.4			
			80	94-2780	11.40	19.2	17.3	15.4			
			90	94-2790	10.13	21.6	19.4	17.3			
			100	94-27100	9.12	24.0	21.6	19.2			
			125	94-27125	7.30	30.0	27.0	24.0			
			150	94-27150	6.08	36.0	32.4	28.8			
			175	94-27175	5.21	42.0	37.8	33.6			
30	15	7.1 x 4.4	25	94-3025	45.00	6.0	5.4	4.8	270 (2647.8)	243 (2382.4)	216 (2118.2)
			30	94-3030	37.50	7.2	6.5	5.8			
			35	94-3035	32.26	8.4	7.5	6.7			
			40	94-3040	28.12	9.6	8.6	7.7			
			45	94-3045	25.00	10.8	9.7	8.6			
			50	94-3050	22.50	12.0	10.8	9.6			
			55	94-3055	20.40	13.2	11.9	10.6			
			60	94-3060	18.75	14.4	13.0	11.5			
			65	94-3065	17.30	15.6	14.0	12.5			
			70	94-3070	16.07	16.8	15.1	13.4			
			75	94-3075	15.00	18.0	16.2	14.4			
			80	94-3080	14.06	19.2	17.3	15.4			
			90	94-3090	12.50	21.6	19.4	17.3			
			100	94-30100	11.25	24.0	21.6	19.2			
			125	94-30125	9.00	30.0	27.0	24.0			
			150	94-30150	7.50	36.0	32.4	28.8			
			175	94-30175	6.42	42.0	37.8	33.6			
200	94-30200	5.62	48.0	43.2	38.4						

Outer Dia. (mm) A	Inner Dia. (mm) B	Wire Size (mm)	Free Length (mm) C	Catalog Number	Spring *Rate kgf/mm	LOAD-DEFLECTION TABLE											
						0.3 million		0.5 million		1 million							
						Defl. mm	Load kgf (N)	Defl. mm	Load kgf (N)	Defl. mm	Load kgf (N)						
35	17.5	8.3 x 5.2	40	94-3540	38.22	9.6	8.6	7.7	367 (3599.0)	330 (3236.2)	293 (2873.4)						
			45	94-3545	33.98	10.8	9.7	8.6									
			50	94-3550	30.58	12.0	10.8	9.6									
			55	94-3555	27.80	13.2	11.9	10.5									
			60	94-3560	25.48	14.4	13.0	11.5									
			65	94-3565	23.53	15.6	14.0	12.5									
			70	94-3570	21.84	16.8	15.1	13.4									
			75	94-3575	20.39	18.0	16.2	14.4									
			80	94-3580	19.11	19.2	17.3	15.4									
			90	94-3590	16.99	21.6	19.4	17.3									
			100	94-35100	15.29	24.0	21.6	19.2									
			125	94-35125	12.23	30.0	27.0	24.0									
			150	94-35150	10.19	36.0	32.4	28.8									
			175	94-35175	8.73	42.0	37.8	33.6									
			200	94-35200	7.64	48.0	43.2	38.4									
			40	20	9.3 x 6.1	40	94-4040	50.00				9.6	8.6	7.7	480 (4707.2)	432 (4236.5)	384 (3765.8)
						50	94-4050	40.00				12.0	10.8	9.6			
60	94-4060	33.33				14.4	13.0	11.5									
70	94-4070	28.57				16.8	15.1	13.4									
80	94-4080	25.00				19.2	17.3	15.4									
90	94-4090	22.22				21.6	19.4	17.3									
100	94-40100	20.00				24.0	21.6	19.2									
125	94-40125	16.00				30.0	27.0	24.0									
150	94-40150	13.33				36.0	32.4	28.8									
175	94-40175	11.42				42.0	37.8	33.6									
50	25	11.8 x 7.8	50	94-5050	62.50	12.0	10.8	9.6	750 (7355.0)	675 (6619.5)	600 (5884.0)						
			60	94-5060	52.08	14.4	13.0	11.5									
			70	94-5070	44.64	16.8	15.1	13.4									
			80	94-5080	39.06	19.2	17.3	15.4									
			90	94-5090	34.72	21.6	19.4	17.3									
			100	94-50100	32.25	24.0	21.6	19.2									
			125	94-50125	25.00	30.0	27.0	24.0									
			150	94-50150	20.83	36.0	32.4	28.8									
			175	94-50175	17.85	42.0	37.8	33.6									
			200	94-50200	15.62	48.0	43.2	38.4									
60	30	14.5 x 9.3	250	94-50250	12.50	60.0	54.0	48.0	1080 (10591.2)	973 (9541.9)	864 (8473.0)						
			300	94-50300	10.41	72.0	64.8	57.6									
			60	94-6060	75.00	14.4	13.0	11.5									
			70	94-6070	64.28	16.8	15.1	13.4									
			80	94-6080	56.25	19.2	17.3	15.4									
			90	94-6090	50.00	21.6	19.4	17.3									
			100	94-60100	45.00	24.0	21.6	19.2									
			125	94-60125	36.00	30.0	27.0	24.0									
			150	94-60150	30.00	36.0	32.4	28.8									
			175	94-60175	25.71	42.0	37.8	33.6									
			200	94-60200	22.50	48.0	43.2	38.4									
			250	94-60250	18.00	60.0	54.0	48.0									
			300	94-60300	15.00	72.0	64.8	57.6									

\* 1 daN = 1.0197 Kg (Force)

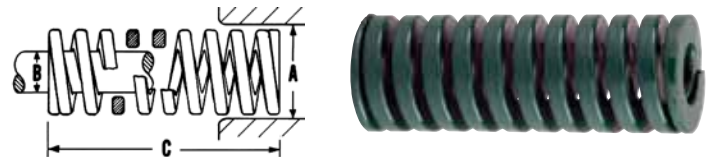

# DieMax XL<sup>®</sup> Extra-Heavy Load Springs – JIS

Outer Dia. (mm) A	Inner Dia. (mm) B	Wire Size (mm)	Free Length (mm) C	Catalog Number	Spring *Rate kgf/mm	LOAD-DEFLECTION TABLE							
						0.3 million		0.5 million		1 million			
						Defl. mm	Load kgf (N)	Defl. mm	Load kgf (N)	Defl. mm	Load kgf (N)		
10	5	2.1 x 2.1	20	95-1020	11.25	4.0	3.6	40.5	3.2	36			
			25	95-1025	9.00	5.0	4.5	39.7	4.0	36			
			30	95-1030	7.50	6.0	5.4	39.7	4.8	36			
			35	95-1035	6.43	7.0	6.3	39.7	5.6	36			
			40	95-1040	5.63	8.0	7.2	39.7	6.4	36			
			45	95-1045	5.00	9.0	8.1	39.7	7.2	36			
			50	95-1050	4.50	10.0	9.0	39.7	8.0	36			
			55	95-1055	4.09	11.0	9.9	39.7	8.8	36			
			60	95-1060	3.75	12.0	10.8	39.7	9.6	36			
			65	95-1065	3.47	13.0	11.7	39.7	10.4	36			
			70	95-1070	3.21	14.0	12.6	39.7	11.2	36			
			75	95-1075	3.00	15.0	13.5	39.7	12.0	36			
			80	95-1080	2.82	16.0	14.4	39.7	12.8	36			
			12	6	2.7 x 2.5	20	95-1220	14.50	4.0	3.6	52	3.2	46.4
						25	95-1225	11.60	5.0	4.5	50.9	4.0	46.4
30	95-1230	9.67				6.0	5.4	50.9	4.8	46.4			
35	95-1235	8.29				7.0	6.3	50.9	5.6	46.4			
40	95-1240	7.25				8.0	7.2	50.9	6.4	46.4			
45	95-1245	6.44				9.0	8.1	50.9	7.2	46.4			
50	95-1250	5.80				10.0	9.0	50.9	8.0	46.4			
55	95-1255	5.27				11.0	9.9	50.9	8.8	46.4			
60	95-1260	4.83				12.0	10.8	50.9	9.6	46.4			
65	95-1265	4.44				13.0	11.7	50.9	10.4	46.4			
70	95-1270	4.13				14.0	12.6	50.9	11.2	46.4			
75	95-1275	3.85				15.0	13.5	50.9	12.0	46.4			
80	95-1280	3.61				16.0	14.4	50.9	12.8	46.4			
14	7	3.3 x 2.8				25	95-1425	15.00	5.0	4.5	67.5	4.0	60
						30	95-1430	12.50	6.0	5.4	66.1	4.8	60
			35	95-1435	10.72	7.0	6.3	66.1	5.6	60			
			40	95-1440	9.38	8.0	7.2	66.1	6.4	60			
			45	95-1445	8.34	9.0	8.1	66.1	7.2	60			
			50	95-1450	7.50	10.0	9.0	66.1	8.0	60			
			55	95-1455	6.82	11.0	9.9	66.1	8.8	60			
			60	95-1460	6.25	12.0	10.8	66.1	9.6	60			
			65	95-1465	5.77	13.0	11.7	66.1	10.4	60			
			70	95-1470	5.36	14.0	12.6	66.1	11.2	60			
			75	95-1475	5.00	15.0	13.5	66.1	12.0	60			
			80	95-1480	4.69	16.0	14.4	66.1	12.8	60			
			90	95-1490	4.17	18.0	16.2	66.1	14.4	60			
			16	8	3.6 x 3.0	25	95-1625	20.00	5.0	4.5	90	4.0	80
						30	95-1630	16.67	6.0	5.4	88.3	4.8	80
35	95-1635	14.29				7.0	6.3	88.3	5.6	80			
40	95-1640	12.50				8.0	7.2	88.3	6.4	80			
45	95-1645	11.11				9.0	8.1	88.3	7.2	80			
50	95-1650	10.00				10.0	9.0	88.3	8.0	80			
55	95-1655	9.09				11.0	9.9	88.3	8.8	80			
60	95-1660	8.34				12.0	10.8	88.3	9.6	80			
65	95-1665	7.69				13.0	11.7	88.3	10.4	80			
70	95-1670	7.14				14.0	12.6	88.3	11.2	80			
75	95-1675	6.67				15.0	13.5	88.3	12.0	80			
80	95-1680	6.25				16.0	14.4	88.3	12.8	80			
90	95-1690	5.56				18.0	16.2	88.3	14.4	80			
100	95-16100	5.00				20.0	18.0	88.3	16.0	80			

Outer Dia. (mm) A	Inner Dia. (mm) B	Wire Size (mm)	Free Length (mm) C	Catalog Number	Spring *Rate kgf/mm	LOAD-DEFLECTION TABLE								
						0.3 million		0.5 million		1 million				
						Defl. mm	Load kgf (N)	Defl. mm	Load kgf (N)	Defl. mm	Load kgf (N)			
18	9	4.1 x 3.5	25	95-1825	25.00	5.0	5.0	125	4.5	113	4.0			
			30	95-1830	20.84	6.0	6.0	122.6	5.4	110.8	4.8			
			35	95-1835	17.86	7.0	6.3	122.6	6.3	110.8	5.6			
			40	95-1840	15.63	8.0	7.2	122.6	7.2	110.8	6.4			
			45	95-1845	13.89	9.0	8.1	122.6	8.1	110.8	7.2			
			50	95-1850	12.50	10.0	9.0	122.6	9.0	110.8	8.0			
			55	95-1855	11.37	11.0	9.9	122.6	9.9	110.8	8.8			
			60	95-1860	10.42	12.0	10.8	122.6	10.8	110.8	9.6			
			65	95-1865	9.62	13.0	11.7	122.6	11.7	110.8	10.4			
			70	95-1870	8.93	14.0	12.6	122.6	12.6	110.8	11.2			
			75	95-1875	8.34	15.0	13.5	122.6	13.5	110.8	12.0			
			80	95-1880	7.82	16.0	14.4	122.6	14.4	110.8	12.8			
			90	95-1890	6.95	18.0	16.2	122.6	16.2	110.8	14.4			
			100	95-18100	6.26	20.0	18.0	122.6	18.0	110.8	16.0			
			20	10	4.7 x 3.7	25	95-2025	32.00	5.0	5.0	160	4.5	144	4.0
						30	95-2030	26.67	6.0	6.0	156.9	5.4	141.2	4.8
						35	95-2035	22.86	7.0	6.3	156.9	6.3	141.2	5.6
						40	95-2040	20.00	8.0	7.2	156.9	7.2	141.2	6.4
						45	95-2045	17.78	9.0	8.1	156.9	8.1	141.2	7.2
						50	95-2050	16.00	10.0	9.0	156.9	9.0	141.2	8.0
55	95-2055	14.55				11.0	9.9	156.9	9.9	141.2	8.8			
60	95-2060	13.33				12.0	10.8	156.9	10.8	141.2	9.6			
65	95-2065	12.31				13.0	11.7	156.9	11.7	141.2	10.4			
70	95-2070	11.43				14.0	12.6	156.9	12.6	141.2	11.2			
75	95-2075	10.67				15.0	13.5	156.9	13.5	141.2	12.0			
80	95-2080	10.00				16.0	14.4	156.9	14.4	141.2	12.8			
90	95-2090	8.89				18.0	16.2	156.9	16.2	141.2	14.4			
100	95-20100	8.00				20.0	18.0	156.9	18.0	141.2	16.0			
125	95-20125	6.40				25.0	22.5	156.9	22.5	141.2	20.0			
150	95-20150	5.33				30.0	27.0	156.9	27.0	141.2	24.0			
22	11	5.2 x 4.2				25	95-2225	39.00	5.0	5.0	195	4.5	176	4.0
						30	95-2230	32.50	6.0	6.0	191.2	5.4	172.6	4.8
						35	95-2235	27.86	7.0	6.3	191.2	6.3	172.6	5.6
						40	95-2240	24.38	8.0	7.2	191.2	7.2	172.6	6.4
			45	95-2245	21.67	9.0	8.1	191.2	8.1	172.6	7.2			
			50	95-2250	19.50	10.0	9.0	191.2	9.0	172.6	8.0			
			55	95-2255	17.73	11.0	9.9	191.2	9.9	172.6	8.8			
			60	95-2260	16.25	12.0	10.8	191.2	10.8	172.6	9.6			
			65	95-2265	15.00	13.0	11.7	191.2	11.7	172.6	10.4			
			70	95-2270	13.93	14.0	12.6	191.2	12.6	172.6	11.2			
			75	95-2275	13.00	15.0	13.5	191.2	13.5	172.6	12.0			
			80	95-2280	12.19	16.0	14.4	191.2	14.4	172.6	12.8			
			90	95-2290	10.83	18.0	16.2	191.2	16.2	172.6	14.4			
			100	95-22100	9.75	20.0	18.0	191.2	18.0	172.6	16.0			
			125	95-22125	7.80	25.0	22.5	191.2	22.5	172.6	20.0			
			150	95-22150	6.50	30.0	27.0	191.2	27.0	172.6	24.0			

\* 1 daN = 1.0197 Kg (Force)





# DieMax XL® Extra-Heavy Load Springs – JIS

Outer Dia. (mm) A	Inner Dia. (mm) B	Wire Size (mm)	Free Length (mm) C	Catalog Number	Spring *Rate kgf/mm	LOAD-DEFLECTION TABLE					
						0.3 million		0.5 million		1 million	
						Defl. mm	Load kgf (N)	Defl. mm	Load kgf (N)	Defl. mm	Load kgf (N)
25	12.5	5.8 x 4.6	25	95-2525	49.00	5.0	4.5	4.0	245 (2402.6)	221 (2167.3)	196 (1922.1)
			30	95-2530	40.80	6.0	5.4	4.8			
			35	95-2535	35.00	7.0	6.3	5.6			
			40	95-2540	30.60	8.0	7.2	6.4			
			45	95-2545	27.20	9.0	8.1	7.2			
			50	95-2550	24.50	10.0	9.0	8.0			
			55	95-2555	22.30	11.0	9.9	8.8			
			60	95-2560	20.40	12.0	10.8	9.6			
			65	95-2565	18.80	13.0	11.7	10.4			
			70	95-2570	17.50	14.0	12.6	11.2			
			75	95-2575	16.30	15.0	13.5	12.0			
			80	95-2580	15.30	16.0	14.4	12.8			
			90	95-2590	13.60	18.0	16.2	14.4			
			100	95-25100	12.30	20.0	18.0	16.0			
			125	95-25125	9.80	25.0	22.5	20.0			
			150	95-25150	8.17	30.0	27.0	24.0			
			175	95-25175	7.00	35.0	31.5	28.0			
27	13.5	6.4 x 5.0	25	95-2725	58.00	5.0	4.5	4.0	290 (2844.0)	261 (2560.0)	232 (2275.0)
			30	95-2730	48.33	6.0	5.4	4.8			
			35	95-2735	41.43	7.0	6.3	5.6			
			40	95-2740	36.25	8.0	7.2	6.4			
			45	95-2745	32.22	9.0	8.1	7.2			
			50	95-2750	29.00	10.0	9.0	8.0			
			55	95-2755	26.36	11.0	9.9	8.8			
			60	95-2760	24.17	12.0	10.8	9.6			
			65	95-2765	22.31	13.0	11.7	10.4			
			70	95-2770	20.71	14.0	12.6	11.2			
			75	95-2775	19.33	15.0	13.5	12.0			
			80	95-2780	18.13	16.0	14.4	12.8			
			90	95-2790	16.11	18.0	16.2	14.4			
			100	95-27100	14.50	20.0	18.0	16.0			
			125	95-27125	11.60	25.0	22.5	20.0			
			150	95-27150	9.67	30.0	27.0	24.0			
			175	95-27175	8.28	35.0	31.5	28.0			
30	15	7.1 x 5.3	25	95-3025	72.00	5.0	4.5	4.0	360 (3530.4)	324 (3177.4)	288 (2824.3)
			30	95-3030	60.00	6.0	5.4	4.8			
			35	95-3035	51.43	7.0	6.3	5.6			
			40	95-3040	45.00	8.0	7.2	6.4			
			45	95-3045	40.00	9.0	8.1	7.2			
			50	95-3050	36.00	10.0	9.0	8.0			
			55	95-3055	32.72	11.0	9.9	8.8			
			60	95-3060	30.00	12.0	10.8	9.6			
			65	95-3065	27.69	13.0	11.7	10.4			
			70	95-3070	25.71	14.0	12.6	11.2			
			75	95-3075	24.00	15.0	13.5	12.0			
			80	95-3080	22.50	16.0	14.4	12.8			
			90	95-3090	20.00	18.0	16.2	14.4			
			100	95-30100	18.00	20.0	18.0	16.0			
			125	95-30125	14.40	25.0	22.5	20.0			
			150	95-30150	12.00	30.0	27.0	24.0			
			175	95-30175	10.28	35.0	31.5	28.0			
200	95-30200	9.00	40.0	36.0	32.0						

Outer Dia. (mm) A	Inner Dia. (mm) B	Wire Size (mm)	Free Length (mm) C	Catalog Number	Spring *Rate kgf/mm	LOAD-DEFLECTION TABLE											
						0.3 million		0.5 million		1 million							
						Defl. mm	Load kgf (N)	Defl. mm	Load kgf (N)	Defl. mm	Load kgf (N)						
35	17.5	8.3 x 6.6	40	95-3540	61.25	8.0	7.2	6.4	490 (4805.3)	441 (4324.7)	392 (3844.2)						
			45	95-3545	54.44	9.0	8.1	7.2									
			50	95-3550	49.00	10.0	9.0	8.0									
			55	95-3555	44.54	11.0	9.9	8.8									
			60	95-3560	40.83	12.0	10.8	9.6									
			65	95-3565	37.69	13.0	11.7	10.4									
			70	95-3570	35.00	14.0	12.6	11.2									
			75	95-3575	32.67	15.0	13.5	12.0									
			80	95-3580	30.62	16.0	14.4	12.8									
			90	95-3590	27.22	18.0	16.2	14.4									
			100	95-35100	24.50	20.0	18.0	16.0									
			125	95-35125	19.60	25.0	22.5	20.0									
			150	95-35150	16.33	30.0	27.0	24.0									
			175	95-35175	14.00	35.0	31.5	28.0									
			200	95-35200	12.25	40.0	36.0	32.0									
			40	20	9.8 x 7.5	40	95-4040	80.00				8.0	7.2	6.4	640 (6276.3)	576 (5648.6)	512 (5021.0)
						50	95-4050	64.00				10.0	9.0	8.0			
60	95-4060	53.33				12.0	10.8	9.6									
70	95-4070	45.71				14.0	12.6	11.2									
80	95-4080	40.00				16.0	14.4	12.8									
90	95-4090	35.55				18.0	16.2	14.4									
100	95-40100	32.00				20.0	18.0	16.0									
125	95-40125	25.60				25.0	22.5	20.0									
150	95-40150	21.33				30.0	27.0	24.0									
175	95-40175	18.28				35.0	31.5	28.0									
200	95-40200	16.00				40.0	36.0	32.0									
250	95-40250	12.80				50.0	45.0	40.0									
50	25	12.0 x 8.8				50	95-5050	100.00	10.0	9.0	8.0	1000 (9806.7)	900 (8826.0)	800 (7845.3)			
						60	95-5060	83.33	12.0	10.8	9.6						
						70	95-5070	71.42	14.0	12.6	11.2						
						80	95-5080	62.50	16.0	14.4	12.8						
						90	95-5090	55.55	18.0	16.2	14.4						
			100	95-50100	50.00	20.0	18.0	16.0									
			125	95-50125	40.00	25.0	22.5	20.0									
			150	95-50150	33.33	30.0	27.0	24.0									
			175	95-50175	28.57	35.0	31.5	28.0									
			200	95-50200	25.00	40.0	36.0	32.0									
			250	95-50250	20.00	50.0	45.0	40.0									
			300	95-50300	16.66	60.0	54.0	48.0									
			60	30	14.8 x 10.5	60	95-6060	120.00	12.0	10.8	9.6				1440 (14121.6)	1296 (12709.4)	1152 (11297.3)
						70	95-6070	102.86	14.0	12.6	11.2						
						80	95-6080	90.00	16.0	14.4	12.8						
						90	95-6090	80.00	18.0	16.2	14.4						
						100	95-60100	72.00	20.0	18.0	16.0						
125	95-60125	57.60				25.0	22.5	20.0									
150	95-60150	48.00				30.0	27.0	24.0									
175	95-60175	41.14				35.0	31.5	28.0									
200	95-60200	36.00				40.0	36.0	32.0									
250	95-60250	28.80				50.0	45.0	40.0									
300	95-60300	24.00				60.0	54.0	48.0									

\* 1 daN = 1.0197 Kg (Force)

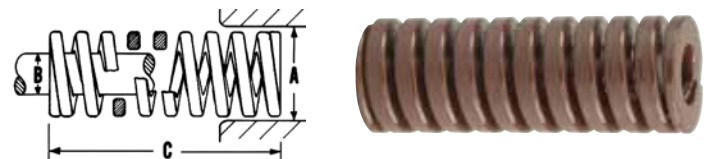

# Die Spring Basics

## Terminology and Concepts

A die spring is a highly engineered mechanical spring with specific wire designs that stores energy elastically by resisting movement when pressure is applied. The desired wire segment is selected to produce the maximum amount of force within a minimal amount of space.

### Altering Die Springs

Each die spring is carefully engineered to perform within specific applications. Under no circumstances should you alter a die spring. Altering a die spring will change its designed characteristics and allows additional stresses to occur causing early failure. Grinding on the die spring not only changes the spring's original properties, but the heat from grinding can change the temper of the material and negatively affect the spring's performance.

### Compressed Length

The sum of the preload travel and operating travel.

### Corrosion

Frequently, die spring failure can be traced to corrosive elements which affect the surface of the spring's material, causing premature failure. Be aware of conditions that may affect the spring's surface such as rust, lubricants, soaps, and chemicals. Clean, protected die springs provide the best performance.

### Cycle Rate

The more rapidly a spring is cycled, the greater the need to operate in the recommended long life deflections from the catalog.

### Die Spring Guidance

Make sure that the hole size and/or rod size match the die spring's operating dimensions.

### Duty Ranges

We offer various duty ranges to best suit your applications. Do not mix springs of different duties.

### Free Length

The length of the spring without any load or force applied.

### Hole Diameter

Die springs are designed to be used in a hole dimension as indicated in the catalog. The actual O.D. will be somewhat smaller to prevent interference.

### Material

In our case, the spring material is High Tensile Strength Chrome Silicon Material. We use an optimal rectangular wire design. The maximum rated service temperature is 425°F.

### Operating Travel

Operating travel is the deflection of the spring where it is operating between the preload and the total travel of the spring during operation. This is the area where the actual work is performed.

### Preload

The initial force which is applied to a die spring. Preload is recommended to compress the first coils at each end where additional stresses are present because of the turn-down of the end coils. Applying a preload will extend the life of the spring.

### Quality

Our die springs are manufactured in an ISO 9001:2015 facility.

### Rates

Die spring rates are normally listed as Pounds per Inch of deflection (i.e. 60 pounds load per inch.) As a die spring is deflected, the loads will increase for the amount of travel it is deflected. That is, a spring with a 60lb/inch rate will produce 60 lbs of resistance at 1" of travel, 120 lbs. at 2" of travel, etc. For purposes of simplification, the loads in our catalog are shown in pounds needed to deflect a spring 1/10th of an inch. Simply multiply the rates given by 10 to determine the actual spring rate.

### Rod Diameter

Die springs are designed to fit over a rod for guidance and the actual I.D. of the spring is actually somewhat larger to fit over a rod without interference.

### Solid Height

Solid height is the height of the spring when all of the coils are totally collapsed to solid. You never want to operate a die spring close to this condition.

## Industry Standard Die Springs

- Inch sizes manufactured to industry standard colors
- Yields reliable, trouble-free performance
- Manufactured in an ISO 9001:2015 certified facility
- Manufactured from premium spring quality high-tensile strength steel in accordance with ASTM A1000-99 specifications
- Optimal rectangular wire design



**MEDIUM DUTY**  
Blue Stripe



**MEDIUM HEAVY DUTY**  
Red Stripe



**HEAVY DUTY**  
Gold Stripe



**EXTRA HEAVY DUTY**  
Green Stripe

# DieMax XL® Medium Duty Springs – R-Series Inch

Hole Diam. (in) A	Rod Diam. (in) B	Free Length (in) C	Wire Size (in)	CATALOG NUMBER	RATE Pounds Req'd. to deflect 1/10 in.	Total deflection for Long Life (25% of C)		Total Deflection for Avg. Life (35% of C)		Maximum Operating Deflection (40% of C)		* Max. Comp. Length (in)			
						Load lbs.	Defl. in.	Load lbs.	Defl. in.	Load lbs.	Defl. in.				
3/8	3/16	1.00	0.040 x 0.070	M100L	6.0	15.0	0.25	21.0	0.35	24.0	0.40	0.20			
		1.25		M100AL	5.0	15.5	0.31	22.0	0.44	25.0	0.50	0.61			
		1.50		M101L	4.2	15.8	0.38	22.1	0.53	25.2	0.60	0.73			
		1.75		M101AL	3.7	16.3	0.44	22.6	0.61	25.9	0.70	0.85			
		2.00		M102L	3.1	15.5	0.50	21.7	0.70	24.8	0.80	1.00			
		2.50		M103L	2.6	16.4	0.63	22.3	0.88	26.0	1.00	1.18			
		3.00		M104L	2.1	15.8	0.75	22.1	1.05	25.2	1.20	1.40			
		12.00		M105L	0.6	18.0	3.00	25.2	4.20	28.8	4.80	5.11			
1/2	9/32	1.00	0.052 x 0.095	M110L	11.0	27.5	0.25	38.5	0.35	44.0	0.40	0.50			
		1.25		M110AL	8.2	25.6	0.31	36.1	0.44	41.0	0.50	0.63			
		1.50		M111L	6.8	25.5	0.38	35.7	0.53	40.8	0.60	0.73			
		1.75		M111AL	6.0	26.4	0.44	36.6	0.61	42.0	0.70	0.85			
		2.00		M112L	5.5	27.5	0.50	38.5	0.70	44.0	0.80	0.96			
		2.50		M113L	4.5	28.4	0.63	39.6	0.88	45.0	1.00	1.15			
		3.00		M114L	3.5	26.3	0.75	36.8	1.05	42.0	1.20	1.40			
		3.50		M115L	3.0	26.4	0.88	36.9	1.23	42.0	1.40	1.56			
		4.50		M115AL	2.3	26.0	1.13	36.3	1.58	41.4	1.80	2.05			
		5.50		M115BL	2.0	27.5	1.38	38.5	1.93	44.0	2.20	2.37			
		6.50		M115CL	1.4	22.8	1.63	31.9	2.28	36.4	2.60	3.25			
		7.50		M115DL	1.2	22.5	1.88	31.5	2.63	36.0	3.00	3.71			
12.00	M116L	0.7	21.0	3.00	29.4	4.20	33.6	4.80	6.00						
5/8	11/32	1.00	0.068 x 0.117	M120L	16.4	41.0	0.25	57.4	0.35	65.6	0.40	0.50			
		1.25		M120AL	12.4	38.4	0.31	54.6	0.44	62.0	0.50	0.62			
		1.50		M121L	10.8	41.0	0.38	57.2	0.53	64.8	0.60	0.74			
		1.75		M121AL	9.6	42.0	0.44	58.8	0.61	67.2	0.70	0.80			
		2.00		M122L	8.6	43.0	0.50	60.2	0.70	68.8	0.80	0.93			
		2.50		M123L	6.5	41.0	0.63	57.2	0.88	65.0	1.00	1.18			
		3.00		M124L	5.8	43.5	0.75	60.9	1.05	69.6	1.20	1.30			
		3.50		M125L	5.0	44.0	0.88	61.5	1.23	70.0	1.40	1.46			
		4.00		M126L	4.4	44.0	1.00	61.6	1.40	70.4	1.60	1.65			
		12.00		M127L	1.5	45.6	3.00	63.8	4.20	73.0	4.80	4.83			
		3/4		3/8	1.00	0.085 x 0.155	M1L	32.0	80.0	0.25	112.0	0.35	128.0	0.40	0.50
					1.25		M1AL	25.6	80.0	0.31	112.0	0.44	128.0	0.50	0.65
1.50	M2L		20.0		75.0		0.38	105.0	0.53	120.0	0.60	0.77			
1.75	M2AL		17.6		77.0		0.44	107.8	0.61	123.2	0.70	0.88			
2.00	M3L		15.0		75.0		0.50	105.0	0.70	120.0	0.80	1.03			
2.50	M4L		12.0		75.0		0.63	105.0	0.88	120.0	1.00	1.28			
3.00	M5L		10.1		75.8		0.75	106.0	1.05	121.2	1.20	1.49			
3.50	M6L		8.3		73.0		0.88	102.1	1.23	116.2	1.40	1.74			
4.00	M7L		7.5		73.0		1.00	105.0	1.40	120.0	1.60	1.99			
4.50	M8L		6.4		72.0		1.13	100.8	1.58	115.2	1.80	2.24			
5.00	M9L		6.0		75.0		1.25	105.0	1.75	120.0	2.00	2.48			
5.50	M10L		5.5		75.6		1.38	105.9	1.93	121.0	2.20	2.72			
6.00	M11L		5.0		75.0		1.50	105.0	2.10	120.0	2.40	2.97			
6.50	M11BL		4.7		76.6		1.63	107.2	2.28	122.2	2.60	3.20			
7.50	M11CL		3.8		71.3		1.88	99.8	2.63	114.0	3.00	3.75			
12.00	M11AL		2.4		72.0		3.00	100.8	4.20	115.2	4.80	5.90			



Hole Diam. (in) A	Rod Diam. (in) B	Free Length (in) C	Wire Size (in)	CATALOG NUMBER	RATE Pounds Req'd. to deflect 1/10 in.	Total deflection for Long Life (25% of C)		Total Deflection for Avg. Life (35% of C)		Maximum Operating Deflection (40% of C)		* Max. Comp. Length (in)			
						Load lbs.	Defl. in.	Load lbs.	Defl. in.	Load lbs.	Defl. in.				
1	1/2	1.00	0.105 x 0.212	M12L	55.0	137.5	0.25	192.5	0.35	220.0	0.40	0.51			
		1.25		M12AL	45.0	140.6	0.31	196.9	0.44	225.0	0.50	0.66			
		1.50		M13L	37.3	139.9	0.38	197.7	0.53	223.8	0.60	0.78			
		1.75		M13AL	32.0	140.0	0.44	195.2	0.61	224.0	0.70	0.90			
		2.00		M14L	26.8	134.0	0.50	187.6	0.70	214.4	0.80	1.00			
		2.50		M15L	20.9	130.6	0.63	182.9	0.88	209.0	1.00	1.25			
		3.00		M16L	17.1	128.3	0.75	179.6	1.05	205.2	1.20	1.50			
		3.50		M17L	14.5	126.9	0.88	178.4	1.23	203.0	1.40	1.72			
		4.00		M18L	12.5	125.0	1.00	175.0	1.40	200.0	1.60	1.97			
		4.50		M19L	11.0	123.4	1.13	173.8	1.58	198.0	1.80	2.23			
		5.00		M20L	9.6	120.0	1.25	168.0	1.75	192.0	2.00	2.46			
		5.50		M21L	8.8	121.0	1.38	169.4	1.93	193.6	2.20	2.73			
		6.00		M22L	8.0	120.0	1.50	168.0	2.10	192.0	2.40	2.93			
		7.00		M23L	7.2	126.0	1.75	176.4	2.45	201.6	2.80	3.40			
		8.00		M24L	6.0	120.0	2.00	168.0	2.80	192.0	3.20	3.86			
		12.00		M24AL	4.0	120.0	3.00	168.0	4.20	192.0	4.80	5.70			
1 1/4	5/8	1.50	0.125 x 0.270	M36L	49.6	186.0	0.38	262.9	0.53	297.6	0.60	0.75			
		1.75		M36AL	40.6	177.6	0.44	247.7	0.61	284.2	0.70	0.88			
		2.00		M37L	37.6	188.0	0.50	263.2	0.70	300.8	0.80	1.05			
		2.50		M38L	28.8	180.0	0.63	252.0	0.88	288.0	1.00	1.25			
		3.00		M39L	24.0	180.0	0.75	252.0	1.00	288.0	1.20	1.46			
		3.50		M40L	20.0	175.0	0.88	245.0	1.23	280.0	1.40	1.70			
		4.00		M41L	17.6	176.0	1.00	246.4	1.40	281.6	1.60	1.95			
		4.50		M42L	16.0	180.0	1.13	252.0	1.58	288.0	1.80	2.20			
		5.00		M43L	14.3	178.8	1.25	250.3	1.75	286.0	2.00	2.44			
		5.50		M44L	12.8	176.0	1.38	246.4	1.93	281.6	2.20	2.72			
		6.00		M45L	12.0	180.0	1.50	252.0	2.10	288.0	2.40	2.98			
		7.00		M46L	10.4	182.0	1.75	254.8	2.45	291.2	2.80	3.50			
		8.00		M47L	8.8	176.0	2.00	246.4	2.80	281.6	3.20	3.96			
		10.00		M48L	7.2	180.0	2.50	252.0	3.50	288.0	4.00	4.95			
		12.00		M48AL	6.0	180.0	3.00	252.0	4.20	288.0	4.80	5.85			
		1 1/2		3/4	2.00	0.158 x 0.315	M49L	53.0	265.0	0.50	371.0	0.70	424.0	0.80	1.03
2.50	M50L		42.7		266.9		0.63	373.6	0.88	427.0	1.00	1.27			
3.00	M51L		36.0		270.0		0.75	378.0	1.05	432.0	1.20	1.52			
3.50	M52L		30.0		262.5		0.88	367.5	1.23	420.0	1.40	1.74			
4.00	M53L		24.9		249.0		1.00	348.6	1.40	398.4	1.60	1.99			
4.50	M54L		23.0		258.8		1.13	362.3	1.58	414.0	1.80	2.22			
5.00	M55L		21.0		262.5		1.25	367.5	1.75	420.0	2.00	2.46			
5.50	M55AL		18.5		254.4		1.38	356.1	1.93	407.0	2.20	2.72			
6.00	M56L		17.0		255.0		1.50	357.0	2.10	408.0	2.40	2.96			
7.00	M56AL		15.3		267.8		1.75	374.9	2.45	428.4	2.80	3.40			
8.00	M57L		13.2		264.0		2.00	369.6	2.80	422.4	3.20	3.90			
10.00	M58L		10.6		265.0		2.50	371.0	3.50	424.0	4.00	4.86			
12.00	M58AL		8.5		255.0		3.00	357.0	4.20	408.0	4.80	5.86			
2	1		2.50		0.215 x 0.445		M70L	100.0	625.0	0.63	875.0	0.88	1000.0	1.00	1.32
			3.00				M71L	83.0	622.5	0.75	871.5	1.05	996.0	1.20	1.52
			3.50				M72L	67.7	592.4	0.88	829.3	1.23	947.8	1.40	1.77
		4.00	M73L	60.0		600.0	1.00	840.0	1.40	960.0	1.60	2.08			
		4.50	M74L	53.0		596.3	1.13	834.8	1.58	954.0	1.80	2.20			
		5.00	M75L	47.0		587.5	1.25	822.5	1.75	940.0	2.00	2.58			
		5.50	M76L	40.5		556.9	1.38	779.6	1.93	891.0	2.20	2.88			
		6.00	M77L	39.0		585.0	1.50	819.0	2.10	936.0	2.40	3.03			
		7.00	M79L	31.2		546.0	1.75	764.4	2.45	873.6	2.80	3.58			
		8.00	M80L	28.5		570.0	2.00	798.0	2.80	912.0	3.20	4.05			
		10.00	M82L	21.6		540.0	2.50	756.0	3.50	864.0	4.00	5.00			
		12.00	M83L	18.5		555.0	3.00	777.0	4.20	888.0	4.80	6.17			

\* For design purposes only. We do not recommend deflecting a spring to maximum deflection.

## Product Features:

# DieMax XL<sup>®</sup> Medium Heavy Duty Springs – R-Series Inch

Hole Diam. (in) A	Rod Diam. (in) B	Free Length (in) C	Wire Size (in)	CATALOG NUMBER	RATE Pounds Req'd. to deflect 1/10 in.	Total deflection for Long Life (20% of C)		Total Deflection for Avg. Life (25% of C)		Maximum Operating Deflection (35% of C)		* Max. Comp. Length (in)
						Load lbs.	Defl. in.	Load lbs.	Defl. in.	Load lbs.	Defl. in.	
3/8	3/16	1.00	0.045 x 0.070	MHC100L	8.4	16.8	0.20	21.0	0.25	29.4	0.35	0.62
		1.25		MHC100AL	7.3	18.3	0.25	22.8	0.31	31.9	0.44	0.75
		1.50		MHC101L	6.7	20.1	0.30	25.1	0.38	35.2	0.53	0.85
		1.75		MHC101AL	5.8	20.3	0.35	25.4	0.44	35.5	0.61	0.95
		2.00		MHC102L	5.0	20.0	0.40	25.0	0.50	35.0	0.70	1.09
		2.50		MHC103L	3.7	18.5	0.50	23.1	0.63	32.4	0.88	1.36
		3.00		MHC104L	3.0	18.0	0.60	22.5	0.75	31.5	1.05	1.69
		12.00		MHC106L	0.8	19.2	2.40	24.0	3.00	33.6	4.20	6.46
1/2	9/32	1.00	0.060 x 0.095	MHC110L	15.5	31.0	0.20	38.8	0.25	54.3	0.35	0.50
		1.25		MHC110AL	12.2	30.5	0.25	38.1	0.31	53.4	0.44	0.61
		1.50		MHC111L	9.8	29.4	0.30	36.8	0.38	51.5	0.53	0.75
		1.75		MHC111AL	8.5	29.8	0.35	37.2	0.44	52.1	0.61	0.84
		2.00		MHC112L	7.5	30.0	0.40	37.5	0.50	52.5	0.70	0.95
		2.50		MHC113L	6.0	30.0	0.50	37.5	0.63	52.5	0.88	1.18
		3.00		MHC114L	5.1	30.6	0.60	38.3	0.75	53.6	1.05	1.40
		3.50		MHC115L	4.0	28.0	0.70	35.0	0.88	49.0	1.23	1.68
12.00	MHC117L	1.1	26.4	2.40	33.0	3.00	16.2	4.20	5.68			
5/8	11/32	1.00	0.086 x 0.112	MHC120L	30.0	60.0	0.20	75.0	0.25	105.0	0.35	0.60
		1.25		MHC120AL	21.5	53.8	0.25	67.2	0.31	94.1	0.44	0.77
		1.50		MHC121L	19.0	57.0	0.30	71.3	0.38	99.8	0.53	0.88
		1.75		MHC121AL	16.8	58.8	0.35	73.5	0.44	102.9	0.61	1.00
		2.00		MHC122L	15.5	62.0	0.40	77.5	0.50	108.5	0.70	1.10
		2.50		MHC123L	11.5	57.5	0.50	71.9	0.63	100.6	0.88	1.38
		3.00		MHC124L	10.0	60.0	0.60	75.0	0.75	105.0	1.05	1.73
		3.50		MHC125L	8.5	59.5	0.70	74.4	0.88	104.1	1.23	1.80
		4.00		MHC126L	7.6	60.8	0.80	76.0	1.00	106.4	1.40	2.00
		12.00		MHC127L	2.6	62.4	2.40	78.0	3.00	109.2	4.20	5.70
3/4	3/8	1.00	0.100 x 0.155	MHC1L	50.0	100.0	0.20	125.0	0.25	175.0	0.35	0.60
		1.25		MHC1AL	38.0	95.0	0.25	118.8	0.31	166.3	0.44	0.77
		1.50		MHC2L	31.0	93.0	0.30	116.3	0.38	162.8	0.53	0.88
		1.75		MHC2AL	27.0	94.5	0.35	118.1	0.44	165.4	0.61	1.02
		2.00		MHC3L	24.0	96.0	0.40	120.0	0.50	168.0	0.70	1.16
		2.50		MHC4L	18.8	94.0	0.50	117.5	0.63	164.5	0.88	1.46
		3.00		MHC5L	14.9	89.4	0.60	111.8	0.75	156.5	1.05	1.74
		3.50		MHC6L	12.8	89.6	0.70	112.0	0.88	156.8	1.23	2.05
		4.00		MHC7L	11.0	88.0	0.80	110.0	1.00	154.0	1.40	2.31
		4.50		MHC8L	10.0	90.0	0.90	112.5	1.13	157.5	1.58	2.62
		5.00		MHC9L	9.0	90.0	1.00	112.5	1.25	157.5	1.75	2.95
		5.50		MHC10L	8.0	88.0	1.10	110.0	1.38	154.0	1.93	3.15
		6.00		MHC11L	7.5	90.0	1.20	112.5	1.50	157.5	2.10	3.45
12.00	MHC11AL	3.5	84.0	2.40	105.0	3.00	147.0	4.20	6.78			
1	1/2	1.00	0.125 x 0.214	MHC12L	82.7	165.4	0.20	206.8	0.25	289.5	0.35	0.63
		1.25		MHC12AL	65.3	163.3	0.25	204.1	0.31	285.7	0.44	0.78
		1.50		MHC13L	53.8	161.4	0.30	201.8	0.38	282.5	0.53	0.92
		1.75		MHC13AL	46.1	161.4	0.35	201.7	0.44	282.4	0.61	1.02
		2.00		MHC14L	40.0	160.0	0.40	200.0	0.50	280.0	0.70	1.15
		2.50		MHC15L	32.2	161.0	0.50	201.3	0.63	281.8	0.88	1.44
		3.00		MHC16L	26.7	160.2	0.60	200.3	0.75	280.4	1.05	1.73
		3.50		MHC17L	22.9	160.3	0.70	200.4	0.88	280.5	1.23	2.02
		4.00		MHC18L	20.2	161.6	0.80	202.0	1.00	282.2	1.40	2.30
		4.50		MHC19L	17.8	160.2	0.90	200.3	1.13	280.4	1.58	2.60
		5.00		MHC20L	15.7	157.0	1.00	196.3	1.25	274.8	1.75	2.88
		5.50		MHC21L	13.7	150.7	1.10	188.4	1.38	263.7	1.93	3.16
		6.00		MHC22L	12.5	150.0	1.20	187.5	1.50	262.5	2.10	3.45
		7.00		MHC23L	10.9	152.6	1.40	190.8	1.75	267.1	2.45	4.03
8.00	MHC24L	9.6	153.6	1.60	192.0	2.00	268.8	2.80	4.60			
12.00	MHC24AL	6.5	156.0	2.40	195.0	3.00	273.0	4.20	6.80			

Hole Diam. (in) A	Rod Diam. (in) B	Free Length (in) C	Wire Size (in)	CATALOG NUMBER	RATE Pounds Req'd. to deflect 1/10 in.	Total deflection for Long Life (20% of C)		Total Deflection for Avg. Life (25% of C)		Maximum Operating Deflection (35% of C)		* Max. Comp. Length (in)
						Load lbs.	Defl. in.	Load lbs.	Defl. in.	Load lbs.	Defl. in.	
1 1/4	5/8	1.50	0.165 X 0.270	MHC36L	114.4	343.2	0.30	429.0	0.38	600.6	0.53	0.92
		1.75		MHC36AL	100.8	352.8	0.35	441.0	0.44	617.4	0.61	1.07
		2.00		MHC37L	83.8	335.2	0.40	419.0	0.50	586.6	0.70	1.22
		2.50		MHC38L	62.4	312.0	0.50	390.0	0.63	546.0	0.88	1.55
		3.00		MHC39L	51.2	307.2	0.60	384.0	0.75	537.6	1.05	1.83
		3.50		MHC40L	44.0	308.0	0.70	385.0	0.88	539.0	1.23	2.12
		4.00		MHC41L	38.1	304.8	0.80	381.0	1.00	533.4	1.40	2.49
		4.50		MHC42L	32.9	296.1	0.90	370.1	1.13	518.2	1.58	2.75
		5.00		MHC43L	30.0	300.0	1.00	375.0	1.25	525.0	1.75	3.05
		5.50		MHC44L	26.4	290.4	1.10	363.0	1.38	508.2	1.93	3.30
		6.00		MHC45L	25.0	300.0	1.20	375.0	1.50	525.0	2.10	3.60
		7.00		MHC46L	21.0	294.0	1.40	367.5	1.75	514.5	2.45	4.20
8.00	MHC47L	18.4	294.4	1.60	368.0	2.00	515.2	2.80	4.90			
10.00	MHC48L	14.5	290.0	2.00	362.5	2.50	507.5	3.50	5.78			
12.00	MHC48AL	12.4	297.6	2.40	372.0	3.00	520.8	4.20	7.10			
1 1/2	3/4	2.00	0.191 X 0.320	MHC49L	103.0	412.0	0.40	515.0	0.50	721.0	0.70	1.21
		2.50		MHC50L	81.2	406.0	0.50	507.5	0.63	710.5	0.88	1.51
		3.00		MHC51L	62.4	374.4	0.60	468.0	0.75	655.2	1.05	1.85
		3.50		MHC52L	54.0	378.0	0.70	472.5	0.88	661.5	1.23	2.10
		4.00		MHC53L	46.5	372.0	0.80	465.0	1.00	651.0	1.40	2.31
		4.50		MHC54L	41.0	369.0	0.90	461.3	1.13	645.8	1.58	2.60
		5.00		MHC55L	36.8	368.0	1.00	460.0	1.25	644.0	1.75	2.84
		5.50		MHC55AL	33.0	363.0	1.10	453.8	1.38	635.3	1.93	3.10
		6.00		MHC56L	29.5	354.0	1.20	442.5	1.50	619.5	2.10	3.50
		7.00		MHC56AL	25.5	357.0	1.40	446.6	1.75	624.8	2.45	3.95
8.00	MHC57L	22.0	352.0	1.60	440.0	2.00	616.0	2.80	4.55			
10.00	MHC58L	17.6	352.0	2.00	440.0	2.50	616.0	3.50	5.55			
12.00	MHC58AL	14.4	345.6	2.40	432.0	3.00	604.8	4.20	6.85			
2	1	2.50	0.235 X 0.440	MHC70L	118.4	592.0	0.50	740.0	0.63	1036.0	0.88	1.53
		3.00		MHC71L	93.0	558.0	0.60	697.5	0.75	976.5	1.05	1.80
		3.50		MHC72L	78.2	547.4	0.70	684.3	0.88	958.0	1.23	2.10
		4.00		MHC73L	66.4	531.2	0.80	664.0	1.00	929.6	1.40	2.35
		4.50		MHC74L	60.0	540.0	0.90	675.0	1.13	945.0	1.58	2.65
		5.00		MHC75L	53.4	534.0	1.00	667.5	1.25	934.5	1.75	2.92
		5.50		MHC76L	49.0	539.0	1.10	673.8	1.38	943.3	1.93	3.18
		6.00		MHC77L	45.0	540.0	1.20	675.0	1.50	945.0	2.10	3.46
		7.00		MHC79L	37.4	523.6	1.40	654.5	1.75	916.3	2.45	4.05
		8.00		MHC80L	33.0	528.0	1.60	660.0	2.00	924.0	2.80	4.62
		10.00		MHC82L	26.0	520.0	2.00	650.0	2.50	910.0	3.50	5.75
		12.00		MHC83L	21.5	516.0	2.40	645.0	3.00	903.0	4.20	6.88

\* For design purposes only. We do not recommend deflecting a spring to maximum deflection.



### Product Features:

- ◆ Color – Red
- ◆ High tensile strength chrome silicon
- ◆ Optimal rectangular wire design
- ◆ Long life design

# DieMax XL<sup>®</sup> Heavy Duty Springs – R-Series Inch

Hole Diam. (in) A	Rod Diam. (in) B	Free Length (in) C	Wire Size (in)	CATALOG NUMBER	RATE Pounds Req'd. to deflect 1/10 in.	Total deflection for Long Life (15% of C)		Total Deflection for Avg. Life (20% of C)		Maximum Operating Deflection (28% of C)		* Max. Comp. Length (in)			
						Load lbs.	Defl. in.	Load lbs.	Defl. in.	Load lbs.	Defl. in.				
3/8	3/16	1.00	0.053 x 0.071	H100L	11.6	17.4	0.15	23.2	0.20	32.5	0.28	0.65			
		1.25		H100AL	9.8	18.4	0.19	24.5	0.25	34.3	0.35	0.79			
		1.50		H101L	8.0	18.0	0.23	24.0	0.30	33.6	0.42	0.87			
		1.75		H101AL	7.5	19.7	0.26	26.3	0.35	36.8	0.49	0.99			
		2.00		H102L	6.2	18.6	0.30	24.8	0.40	34.7	0.56	1.14			
		2.50		H103L	5.0	18.8	0.38	25.0	0.50	35.0	0.70	1.41			
		3.00		H104L	4.1	18.5	0.45	24.6	0.60	34.4	0.84	1.72			
		12.00		H105L	1.1	20.5	1.80	27.4	2.40	38.3	3.36	6.74			
		1/2		9/32	1.00	0.071 x 0.095	H110L	22.5	33.8	0.15	45.0	0.20	63.0	0.28	0.67
					1.25		H110AL	18.2	34.1	0.19	45.5	0.25	63.7	0.35	0.70
1.50	H111L		14.8		33.3		0.23	44.4	0.30	62.2	0.42	0.81			
1.75	H111AL		12.6		33.1		0.26	44.1	0.35	61.7	0.49	1.00			
2.00	H112L		11.0		33.0		0.30	44.0	0.40	61.6	0.56	1.05			
2.50	H113L		8.6		32.3		0.38	43.0	0.50	60.2	0.70	1.32			
3.00	H114L		7.4		33.3		0.45	44.4	0.60	62.2	0.84	1.54			
3.50	H115L		6.0		31.5		0.53	42.0	0.70	58.8	0.98	1.82			
12.00	H117L		1.7		30.6		1.80	40.8	2.40	57.1	3.36	6.28			
5/8	11/32		1.00		0.096 x 0.115		H120L	42.4	63.6	0.15	84.8	0.20	118.7	0.28	0.63
		1.25	H120AL	32.5		60.9	0.19	81.3	0.25	113.8	0.35	0.80			
		1.50	H121L	28.0		63.0	0.23	84.0	0.30	117.6	0.42	0.90			
		1.75	H121AL	24.0		63.0	0.26	84.0	0.35	117.6	0.49	1.03			
		2.00	H122L	20.8		62.4	0.30	83.2	0.40	116.5	0.56	1.18			
		2.50	H123L	17.0		63.8	0.38	85.0	0.50	119.0	0.70	1.44			
		3.00	H124L	14.0		63.0	0.45	84.0	0.60	117.6	0.84	1.70			
		3.50	H125L	12.2		64.1	0.53	85.4	0.70	119.6	0.98	1.97			
		4.00	H126L	10.8		64.8	0.60	86.4	0.80	121.0	1.12	2.28			
		12.00	H127L	3.0		54.0	1.80	72.0	2.40	100.8	3.36	6.95			
3/4	3/8	1.00	0.130 x 0.155	H1L	108.0	162.0	0.15	216.0	0.20	302.4	0.28	0.70			
		1.25		H1AL	88.0	165.0	0.19	220.0	0.25	308.0	0.35	0.86			
		1.50		H2L	69.0	155.3	0.23	210.0	0.30	289.8	0.42	1.02			
		1.75		H2AL	60.0	157.5	0.26	207.0	0.35	294.0	0.49	1.19			
		2.00		H3L	51.5	154.5	0.30	206.0	0.40	288.4	0.56	1.35			
		2.50		H4L	40.0	150.0	0.38	200.0	0.50	280.0	0.70	1.71			
		3.00		H5L	33.0	148.5	0.45	198.0	0.60	277.2	0.84	2.00			
		3.50		H6L	29.0	152.3	0.53	203.0	0.70	284.2	0.98	2.33			
		4.00		H7L	25.0	150.0	0.60	200.0	0.80	280.0	1.12	2.67			
		4.50		H8L	22.0	148.5	0.68	198.0	0.90	277.2	1.26	3.00			
		5.00		H9L	19.5	146.3	0.75	195.0	1.00	273.0	1.40	3.33			
		5.50		H10L	17.8	146.9	0.83	195.8	1.10	274.1	1.54	3.75			
6.00	H11L	16.0	144.0	0.90	192.0	1.20	268.8	1.68	3.99						
12.00	H11AL	8.0	144.0	1.80	192.0	2.40	268.8	3.36	7.90						

\* For design purposes only. We do not recommend deflecting a spring to maximum deflection.



## Product Features:

- ◆ Color – Gold
- ◆ High tensile strength chrome silicon
- ◆ Optimal rectangular wire design
- ◆ Long life design

Hole Diam. (in) A	Rod Diam. (in) B	Free Length (in) C	Wire Size (in)	CATALOG NUMBER	RATE Pounds Req'd. to deflect 1/10 in.	Total deflection for Long Life (15% of C)		Total Deflection for Avg. Life (20% of C)		Maximum Operating Deflection (28% of C)		* Max. Comp. Length (in)			
						Load lbs.	Defl. in.	Load lbs.	Defl. in.	Load lbs.	Defl. in.				
1	1/2	1.00	0.165 x 0.216	H12L	193.2	289.8	0.15	386.4	0.20	541.0	0.28	0.68			
		1.25		H12AL	146.5	274.7	0.19	366.3	0.25	512.8	0.35	0.86			
		1.50		H13L	120.0	270.0	0.23	360.0	0.30	504.0	0.42	1.03			
		1.75		H13AL	104.0	273.0	0.26	364.0	0.35	509.6	0.49	1.18			
		2.00		H14L	87.2	261.6	0.30	348.8	0.40	488.3	0.56	1.35			
		2.50		H15L	66.5	249.4	0.38	332.5	0.50	465.5	0.70	1.68			
		3.00		H16L	54.4	244.8	0.45	326.4	0.60	457.0	0.84	2.00			
		3.50		H17L	45.6	239.4	0.53	319.2	0.70	446.9	0.98	2.33			
		4.00		H18L	40.0	240.0	0.60	320.0	0.80	448.0	1.12	2.63			
		4.50		H19L	35.2	237.6	0.68	316.8	0.90	443.5	1.26	2.94			
		5.00		H20L	31.2	234.0	0.75	312.0	1.00	436.8	1.40	3.26			
		5.50		H20AL	28.8	237.6	0.83	316.8	1.10	443.5	1.54	3.55			
		6.00		H21L	25.6	230.4	0.90	307.2	1.20	430.1	1.68	3.87			
		7.00		H21AL	22.4	235.2	1.05	313.6	1.40	439.0	1.96	4.47			
		8.00		H22L	19.2	230.4	1.20	307.2	1.60	430.1	2.24	5.16			
		12.00		H22AL	12.8	230.4	1.80	307.2	2.40	430.1	3.36	7.80			
1 1/4	5/8	1.50	0.209 x 0.275	H36L	220.0	495.0	0.23	660.0	0.30	924.0	0.42	1.01			
		1.75		H36AL	181.6	476.7	0.26	635.6	0.35	889.8	0.49	1.17			
		2.00		H37L	149.6	448.8	0.30	598.4	0.40	837.8	0.56	1.34			
		2.50		H38L	117.6	441.0	0.38	588.0	0.50	823.2	0.70	1.68			
		3.00		H39L	95.2	428.4	0.45	571.2	0.60	799.7	0.84	2.02			
		3.50		H40L	78.0	409.5	0.53	546.0	0.70	764.4	0.98	2.30			
		4.00		H41L	66.4	398.4	0.60	531.2	0.80	743.7	1.12	2.66			
		4.50		H42L	58.4	394.2	0.68	525.6	0.90	735.8	1.26	2.99			
		5.00		H43L	53.0	397.5	0.75	530.0	1.00	742.0	1.40	3.30			
		5.50		H44L	47.2	389.4	0.83	519.2	1.10	726.9	1.54	3.62			
		6.00		H45L	45.0	405.0	0.90	540.0	1.20	756.0	1.68	3.95			
		7.00		H46L	36.8	386.4	1.05	515.2	1.40	721.3	1.96	4.60			
		8.00		H47L	32.8	393.6	1.20	524.8	1.60	734.7	2.24	5.25			
		10.00		H48L	25.6	384.0	1.50	512.0	2.00	716.8	2.80	6.40			
		12.00		H48AL	22.0	396.0	1.80	528.0	2.40	739.2	3.36	7.62			
		1 1/2		3/4	2.00	0.245 x 0.328	H49L	198.0	594.0	0.30	792.0	0.40	1108.8	0.56	1.34
2.50	H50L		155.0		581.3		0.38	775.0	0.50	1085.0	0.70	1.68			
3.00	H51L		130.0		585.0		0.45	780.0	0.60	1092.0	0.84	1.99			
3.50	H52L		106.4		558.6		0.53	744.8	0.70	1042.7	0.98	2.30			
4.00	H53L		91.2		547.2		0.60	729.6	0.80	1021.4	1.12	2.62			
4.50	H54L		81.6		550.8		0.68	734.4	0.90	1028.2	1.26	2.91			
5.00	H55L		73.0		547.5		0.75	730.0	1.00	1022.0	1.40	3.22			
5.50	H55AL		67.0		552.8		0.83	737.0	1.10	1031.8	1.54	3.54			
6.00	H56L		58.4		525.6		0.90	700.8	1.20	981.1	1.68	3.82			
7.00	H56AL		49.6		520.8		1.05	694.4	1.40	972.2	1.96	4.44			
8.00	H57L		43.2		518.4		1.20	691.2	1.60	967.7	2.24	5.02			
10.00	H58L		36.2		543.0		1.50	724.0	2.00	1013.6	2.80	6.26			
12.00	H58AL		30.0		540.0		1.80	720.0	2.40	1008.0	3.36	7.50			
2	1		2.50		0.305 x 0.450		H70L	251.2	942.0	0.38	1256.0	0.50	1758.4	0.70	1.71
			3.00				H71L	206.0	927.0	0.45	1236.0	0.60	1730.4	0.84	2.05
			3.50				H72L	170.0	892.5	0.53	1190.0	0.70	1666.0	0.98	2.37
		4.00	H73L	150.0		900.0	0.60	1200.0	0.80	1680.0	1.12	2.67			
		4.50	H74L	127.2		858.6	0.68	1144.8	0.90	1602.7	1.26	2.98			
		5.00	H75L	118.6		889.5	0.75	1186.0	1.00	1660.4	1.40	3.32			
		5.50	H76L	107.7		888.5	0.83	1184.7	1.10	1658.6	1.54	3.65			
		6.00	H77L	97.7		879.3	0.90	1172.4	1.20	1641.4	1.68	3.97			
		7.00	H79L	82.0		861.0	1.05	1148.0	1.40	1607.2	1.96	4.61			
		8.00	H80L	73.0		876.0	1.20	1168.0	1.60	1635.2	2.24	5.22			
		10.00	H82L	57.2		858.0	1.50	1144.0	2.00	1601.6	2.80	6.55			
		12.00	H83L	47.7		858.6	1.80	1144.8	2.40	1602.7	3.36	7.75			

Note: All springs are available unpainted by adding the suffix "NP" to the end of the part number.

# DieMax XL® Extra Heavy Duty Springs – R-Series Inch

Hole Diam. (in) A	Rod Diam. (in) B	Free Length (in) C	Wire Size (in)	CATALOG NUMBER	RATE Pounds Req'd. to deflect 1/10 in.	Total deflection for Long Life (15% of C)		Total Deflection for Avg. Life (17% of C)		Maximum Operating Deflection (20% of C)		* Max. Comp. Length (in)
						Load lbs.	Defl. in.	Load lbs.	Defl. in.	Load lbs.	Defl. in.	
3/8	3/16	1.00	0.063 x 0.073	XH100L	22.0	33.0	0.15	37.4	0.17	44.0	0.20	0.67
		1.25		XH100AL	14.6	27.4	0.19	31.0	0.21	36.5	0.25	0.86
		1.50		XH101L	12.5	28.1	0.23	31.9	0.26	37.5	0.30	1.05
		1.75		XH101AL	10.5	27.6	0.26	31.2	0.30	36.8	0.35	1.22
		2.00		XH102L	9.0	27.0	0.30	30.6	0.34	36.0	0.40	1.42
		2.50		XH103L	7.5	28.1	0.38	31.9	0.43	37.5	0.50	1.75
		3.00		XH104L	6.3	28.4	0.45	32.1	0.51	37.8	0.60	2.05
		12.00		XH105L	1.5	27.0	1.80	30.6	2.04	36.0	2.40	8.40
1/2	9/32	1.00	0.088 x 0.090	XH110L	31.0	46.5	0.15	52.7	0.17	62.0	0.20	0.69
		1.25		XH110AL	24.0	45.0	0.19	51.0	0.21	60.0	0.25	0.86
		1.50		XH111L	19.2	43.2	0.23	49.0	0.26	57.6	0.30	1.03
		1.75		XH111AL	17.0	44.6	0.26	50.6	0.30	59.5	0.35	1.20
		2.00		XH112L	14.0	42.0	0.30	47.6	0.34	56.0	0.40	1.36
		2.50		XH113L	11.5	43.1	0.38	48.9	0.43	57.5	0.50	1.65
		3.00		XH114L	9.4	42.3	0.45	47.9	0.51	56.4	0.60	1.99
		12.00		XH116L	2.4	43.2	1.80	49.0	2.04	57.6	2.40	7.82
5/8	11/32	1.00	0.115 x 0.120	XH120L	63.0	94.5	0.15	107.1	0.17	126.0	0.20	0.68
		1.25		XH120AL	43.8	82.1	0.19	93.1	0.21	109.5	0.25	0.85
		1.50		XH121L	37.0	83.3	0.23	94.4	0.26	111.0	0.30	1.03
		1.75		XH121AL	31.0	81.4	0.26	92.2	0.30	108.5	0.35	1.20
		2.00		XH122L	28.0	84.0	0.30	95.2	0.34	112.0	0.40	1.38
		2.50		XH123L	22.0	82.5	0.38	93.5	0.43	110.0	0.50	1.81
		3.00		XH124L	19.0	85.5	0.45	96.9	0.51	114.0	0.60	2.06
		12.00		XH127L	4.5	81.0	1.80	91.8	2.04	108.0	2.40	7.87
3/4	3/8	1.00	0.140 x 0.155	XH1L	140.0	210.0	0.15	238.0	0.17	280.0	0.20	0.71
		1.25		XH1AL	110.0	206.3	0.19	233.8	0.21	277.5	0.25	0.89
		1.50		XH2L	89.0	200.3	0.23	227.0	0.26	267.0	0.30	1.06
		1.75		XH2AL	75.0	196.9	0.26	223.1	0.30	262.5	0.35	1.24
		2.00		XH3L	66.0	198.0	0.30	224.4	0.34	264.0	0.40	1.42
		2.50		XH4L	50.0	187.5	0.38	212.5	0.43	250.0	0.50	1.76
		3.00		XH5L	40.5	182.3	0.45	206.6	0.51	243.0	0.60	2.07
		3.50		XH6L	34.5	181.1	0.53	205.3	0.60	241.5	0.70	2.41
		4.00		XH7L	30.0	180.0	0.60	204.0	0.68	240.0	0.80	2.76
		4.50		XH8L	26.5	178.9	0.68	202.7	0.77	238.5	0.90	3.10
		5.00		XH9L	23.5	176.3	0.75	199.8	0.85	235.0	1.00	3.42
		12.00		XH12L	9.5	171.0	1.80	193.8	2.04	228.0	2.40	8.10
1	1/2	1.50	0.182 x 0.215	XH13L	160.0	360.0	0.23	408.0	0.26	480.0	0.30	1.05
		2.00		XH14L	116.0	348.0	0.30	394.4	0.34	464.0	0.40	1.40
		2.50		XH15L	89.6	336.0	0.38	380.8	0.43	448.0	0.50	1.73
		3.00		XH16L	73.6	331.2	0.45	375.4	0.51	441.6	0.60	2.08
		3.50		XH17L	62.4	327.6	0.53	371.3	0.60	436.8	0.70	2.42
		4.00		XH18L	55.2	331.2	0.60	375.4	0.68	441.6	0.80	2.74
		4.50		XH19L	48.8	329.4	0.68	373.3	0.77	439.2	0.90	3.04
		12.00		XH22AL	17.6	316.8	1.80	359.0	2.04	422.4	2.40	7.86

Hole Diam. (in) A	Rod Diam. (in) B	Free Length (in) C	Wire Size (in)	CATALOG NUMBER	RATE Pounds Req'd. to deflect 1/10 in.	Total deflection for Long Life (15% of C)		Total Deflection for Avg. Life (17% of C)		Maximum Operating Deflection (20% of C)		* Max. Comp. Length (in)
						Load lbs.	Defl. in.	Load lbs.	Defl. in.	Load lbs.	Defl. in.	
1 1/4	5/8	2.00	0.226 x 0.280	XH37L	205.0	615.0	0.30	697.0	0.34	820.0	0.40	1.41
		2.50		XH38L	152.5	571.9	0.38	648.1	0.43	762.5	0.50	1.74
		3.00		XH39L	122.0	549.0	0.45	622.2	0.51	732.0	0.60	2.09
		3.50		XH40L	108.5	569.6	0.53	645.6	0.60	759.5	0.70	2.43
		4.00		XH41L	89.0	534.0	0.60	605.2	0.68	712.0	0.80	2.78
		4.50		XH42L	83.5	563.6	0.68	638.8	0.77	751.5	0.90	3.12
		5.00		XH43L	70.0	525.0	0.75	595.0	0.85	700.0	1.00	3.46
		6.00		XH45L	57.5	517.5	0.90	586.5	1.02	690.0	1.20	4.11
		8.00		XH47L	46.0	552.0	1.20	625.6	1.36	736.0	1.60	5.40
		10.00		XH48L	34.5	517.5	1.50	586.5	1.70	690.0	2.00	6.75
		12.00		XH48AL	27.0	486.0	1.80	550.8	2.04	648.0	2.40	7.99
		1 1/2		3/4	2.00	0.290 x 0.330	XH49L	408.5	1225.5	0.30	1388.9	0.34
2.50	XH50L		328.5		1231.9		0.38	1396.1	0.43	1642.5	0.50	1.80
3.00	XH51L		255.0		1147.5		0.45	1300.5	0.51	1530.0	0.60	2.16
3.50	XH52L		213.5		1120.9		0.53	1270.3	0.60	1494.5	0.70	2.51
4.00	XH53L		184.5		1107.0		0.60	1254.6	0.68	1476.0	0.80	2.90
4.50	XH54L		162.5		1096.9		0.68	1243.1	0.77	1462.5	0.90	3.22
5.00	XH55L		145.0		1087.5		0.75	1232.5	0.85	1450.0	1.00	3.58
6.00	XH56L		120.5		1084.5		0.90	1229.1	1.02	1446.0	1.20	4.30
8.00	XH57L		90.5		1086.0		1.20	1230.8	1.36	1448.0	1.60	5.72
10.00	XH58L		71.0		1065.0		1.50	1207.0	1.70	1420.0	2.00	7.12
12.00	XH58AL		55.0		990.0		1.80	1122.0	2.04	1320.0	2.40	8.52
2	1		2.50		0.350 x 0.452		XH70L	411.0	1541.3	0.38	1746.8	0.43
		3.00	XH71L	319.0		1435.5	0.45	1626.9	0.51	2340.0	0.60	2.16
		3.50	XH72L	276.4		1451.1	0.53	1644.6	0.60	2226.0	0.70	2.51
		4.00	XH73L	231.1		1386.6	0.60	1571.5	0.68	2200.0	0.80	2.86
		4.50	XH74L	188.8		1274.4	0.68	1444.3	0.77	2134.1	0.90	3.21
		5.00	XH75L	180.4		1353.0	0.75	1533.4	0.85	2160.0	1.00	3.56
		6.00	XH77L	147.3		1325.7	0.90	1502.5	1.02	2124.0	1.20	4.24
		8.00	XH80L	111.6		1339.2	1.20	1517.8	1.36	2030.0	1.60	5.64
		10.00	XH82L	88.4		1326.0	1.50	1502.8	1.70	2100.0	2.00	7.02
		12.00	XH83L	71.2		1281.6	1.80	1452.5	2.04	2100.0	2.40	8.35

\* For design purposes only. We do not recommend deflecting a spring to maximum deflection.

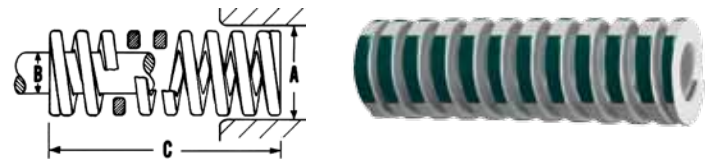

### Product Features:

- ◆ Color – Green
- ◆ High tensile strength chrome silicon
- ◆ Optimal rectangular wire design
- ◆ Long life design

# Spring Cages



- ◆ These spring cages enhance die spring life by providing a flat, hardened die pocket for spring operation.
- ◆ Cages are available for metric and inch spring diameters from 3/4" – 2 (20mm – 50mm).
- ◆ Accommodate standard metric and inch guiding rods and drill diameters.
- ◆ Material: 0.049" / 1.245mm cold rolled steel.
- ◆ Conforms to NAAMS standards.

Spring Diameter		Drill Diameter		Cage O. D.		Clearance for Rod (H)	
(in)	(mm)	(in)	(mm)	(in)	(mm)	(in)	(mm)
3/4	20	29/32	24	0.86	21.7	7/16	11
1	25	1-5/32	30	1.11	28.1	9/16	14
1-1/4	32	1-13/32	36	1.36	34.4	3/4	19
1-1/2	40	1-21/32	43	1.61	40.8	31/32	25
2	50	2-5/32	56	2.11	53.5	1-3/8	35

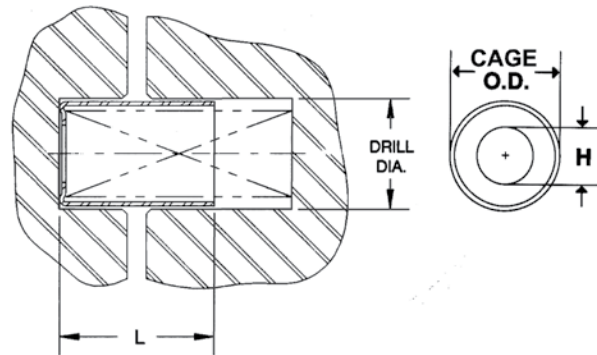

Length L		3/4 in. & 20mm Diameter Springs			1 in. & 25mm Diameter Springs			1-1/4 in. & 32mm Diameter Springs			1-1/2 in. & 40mm Diameter Springs			2 in. & 50mm Diameter Springs		
(in)	(mm)	Danly Part No.	NAAMS Code	Lamina Part No.	Danly Part No.	NAAMS Code	Lamina Part No.	Danly Part No.	NAAMS Code	Lamina Part No.	Danly Part No.	NAAMS Code	Lamina Part No.	Danly Part No.	NAAMS Code	Lamina Part No.
1	25	6-8	S212025	LSC0608	8-8	S212525	LSC0808	10-8	S213225	LSC1008	12-8	S214025	LSC1208	16-8	S215025	LSC1608
1-1/4	32	6-10	S212032	LSC0610	8-10	S212532	LSC0810	10-10	S213232	LSC1010	12-10	S214032	LSC1210	16-10	S215032	LSC1610
1-1/2	38	6-12	S212038	LSC0612	8-12	S212538	LSC0812	10-12	S213238	LSC1012	12-12	S214038	LSC1212	16-12	S215038	LSC1612
1-3/4	44	6-14	S212044	LSC0614	8-14	S212544	LSC0814	10-14	S213244	LSC1014	12-14	S214044	LSC1214	16-14	S215044	LSC1614
2	51	6-16	S212051	LSC0616	8-16	S212551	LSC0816	10-16	S213251	LSC1016	12-16	S214051	LSC1216	16-16	S215051	LSC1616
2-1/4	57	6-18	-	LSC0618	8-18	-	LSC0818	10-18	-	LSC1018	12-18	-	LSC1218	16-18	-	LSC1618
2-1/2	64	6-20	S212064	LSC0620	8-20	S212564	LSC0820	10-20	S213264	LSC1020	12-20	S214064	LSC1220	16-20	S215064	LSC1620
2-3/4	70	6-22	-	LSC0622	8-22	-	LSC0822	10-22	-	LSC1022	12-22	-	LSC1222	16-22	-	LSC1622
3	76	6-24	S212076	LSC0624	8-24	S212576	LSC0824	10-24	S213276	LSC1024	12-24	S214076	LSC1224	16-24	S215076	LSC1624
3-1/4	83	6-26	-	LSC0626	8-26	-	LSC0826	10-26	-	LSC1026	12-26	-	LSC1226	16-26	-	LSC1626
3-1/2	89	6-28	S212089	LSC0628	8-28	S212589	LSC0828	10-28	S213289	LSC1028	12-28	S214089	LSC1228	16-28	S215089	LSC1628
3-3/4	95	6-30	-	LSC0630	8-30	-	LSC0830	10-30	-	LSC1030	12-30	-	LSC1230	16-30	-	LSC1630
4	102	6-32	S212010	LSC0632	8-32	S212510	LSC0832	10-32	S213210	LSC1032	12-32	S214010	LSC1232	16-32	S215010	LSC1632
4-1/4	108	6-34	-	LSC0634	8-34	-	LSC0834	10-34	-	LSC1034	12-34	-	LSC1234	16-34	-	LSC1634
4-1/2	114	6-36	-	LSC0636	8-36	-	LSC0836	10-36	-	LSC1036	12-36	-	LSC1236	16-36	-	LSC1636
4-3/4	121	6-38	-	LSC0638	8-38	-	LSC0838	10-38	-	LSC1038	12-38	-	LSC1238	16-38	-	LSC1638
5	127	6-40	S212012	LSC0640	8-40	S212512	LSC0840	10-40	S213212	LSC1040	12-40	S214012	LSC1240	16-40	S215012	LSC1640
5-1/2	140	6-44	-	LSC0644	8-44	-	LSC0844	10-44	-	LSC1044	12-44	-	LSC1244	16-44	-	LSC1644
6	152	6-48	S212015	LSC0648	8-48	S212515	LSC0848	10-48	S213215	LSC1048	12-48	S214015	LSC1248	16-48	S215015	LSC1648
6-1/2	165	6-52	-	LSC0652	8-52	-	LSC0852	10-52	-	LSC1052	12-52	-	LSC1252	16-52	-	LSC1652
7	178	6-56	S212017	LSC0656	8-56	S212517	LSC0856	10-56	S213217	LSC1056	12-56	S214017	LSC1256	16-56	S215017	LSC1656
8	203	6-64	S212020	LSC0664	8-64	S212520	LSC0864	10-64	S213220	LSC1064	12-64	S214020	LSC1264	16-64	S215020	LSC1664
9	229	-	-	-	-	-	-	10-72	S213222	LSC1072	12-72	S214022	LSC1272	16-72	S215022	LSC1672
10	254	-	-	-	-	-	-	10-80	-	LSC1080	12-80	-	LSC1280	16-80	-	LSC1680
11	280	-	-	-	-	-	-	-	-	-	-	-	-	16-88	S215028	LSC1688
12	305	-	-	-	-	-	-	-	-	-	-	-	-	16-96	S215030	LSC1696



# Spring Retainers

- ◆ These spring retainers hold individual springs firmly in position while the die is being assembled or disassembled. Pre-loading the spring is easy since the springs can be set individually, which avoids working against the combined force of the springs.
- ◆ Available for springs 1-1/4" (32mm), 1-1/2" (38mm) and 2" (50mm) diameters and any free length where clearance permits.
- ◆ Material: Steel

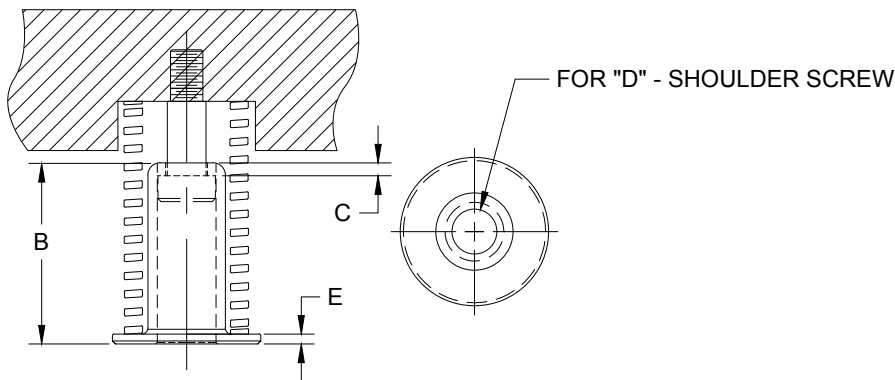

CATALOG NUMBER	Spring Diameter		Rod Diameter A		B		C		Shoulder Screw D		E	
	in	mm	in	mm	in	mm	in	mm	in	mm	in	mm
SR125150	1-1/4	32	5/8	16	1-11/16	43	0.19	4.8	5/16	-	0.19	4.8
SR125200					2-3/16	56	0.19	4.8	5/16	-	0.19	4.8
SR125250					2-11/16	68	0.19	4.8	5/16	-	0.19	4.8
SR150150	1-1/2	38	3/4	19	1-11/16	43	0.19	4.8	3/8	M8	0.19	4.8
9-0615-16					1-7/8	48	0.125	3.2	3/8	M8	0.096	2.4
SR150200					2-3/16	56	0.19	4.8	3/8	M8	0.19	4.8
SR150250					2-11/16	68	0.19	4.8	3/8	M8	0.19	4.8
SR200150	2	50	1	25	1-11/16	43	0.19	4.8	1/2	M13	0.19	4.8
9-0815-16					1-7/8	48	0.125	3.2	1/2	M13	0.125	3.2
SR200200					2-3/16	56	0.19	4.8	1/2	M13	0.19	4.8
SR200250					2-11/16	68	0.19	4.8	1/2	M13	0.19	4.8
9-0823-16					2-7/8	73	0.125	3.2	1/2	M13	0.125	3.2

# Spring Guards



- ◆ Spring guards hold individual springs firmly in position
- ◆ Available for springs 1-1/4" (32mm), 1-1/2" (38mm) and 2" (50mm) diameters and any free length where clearance permits
- ◆ Material: 0.049" / 1.24mm cold rolled steel with painted finish

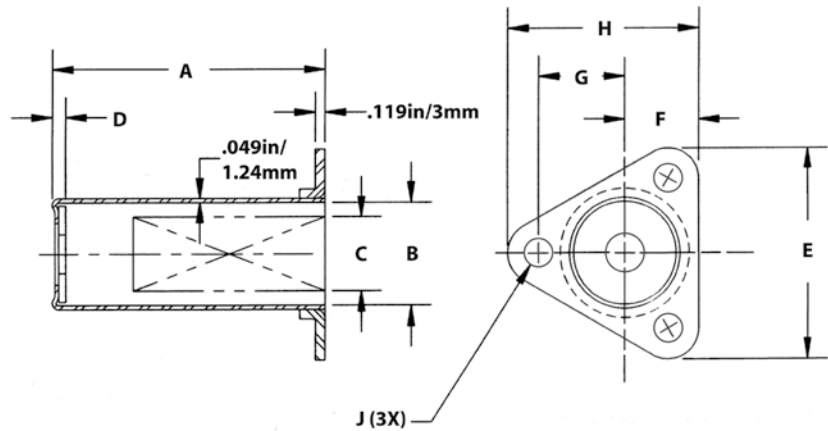

CATALOG NUMBER	A		Max Spring Dia B		Recommended Spring Dia C		D		E		F		G		H		J	
	(in)	(mm)	(in)	(mm)	(in)	(mm)	(in)	(mm)	(in)	(mm)	(in)	(mm)	(in)	(mm)	(in)	(mm)	(in)	(mm)
10-24G	3	76	1-1/4	32	1	25	3/16	5	2-19/32	66	29/32	23	1-1/16	27	2-11/32	60	11/32	9
10-32G	4	102																
10-40G	5	127																
10-48G	6	152																
10-56G	7	178																
12-24G	3	76	1-1/2	38	1-1/4	32	3/16	5	2-15/16	75	1	25	1-1/4	32	2-5/8	67	11/32	9
12-32G	4	102																
12-40G	5	127																
12-48G	6	152																
12-56G	7	178																
12-64G	8	203																
12-80G	10	254	2	51	1-1/2	38	1/4	6	3-11/16	94	1 1/4	32	1-5/8	41	3-11/32	85	7/16	11
16-32G	4	102																
16-40G	5	127																
16-48G	6	152																
16-56G	7	178																
16-64G	8	203																
16-68G	9	229																
16-80G	10	254																
16-96G	12	305																

# Compression Spring Special Requirement Quote Sheet

## Company Information

Company: \_\_\_\_\_  
Contact: \_\_\_\_\_ Title: \_\_\_\_\_  
Address: \_\_\_\_\_  
Address: \_\_\_\_\_  
City: \_\_\_\_\_ State: \_\_\_\_\_ Zip: \_\_\_\_\_  
Phone: \_\_\_\_\_ Fax: \_\_\_\_\_

## Sales Requirements

Estimated Annual Volume: \_\_\_\_\_ Order Quantity: \_\_\_\_\_  
Delivery Date Required: \_\_\_\_\_

## Compression Spring Specifications

Spring Material: \_\_\_\_\_ Wire Size: \_\_\_\_\_  
Outside Diameter: \_\_\_\_\_ Inside Diameter: \_\_\_\_\_  
Free Length: \_\_\_\_\_ Maximum Solid Height: \_\_\_\_\_  
Ends (Closed & Ground or Closed & Unground): \_\_\_\_\_

## Specify One of the Next Three Attributes

Total Coils: \_\_\_\_\_ Spring Rate: \_\_\_\_\_  
Load at a Given Rate: \_\_\_\_\_

## Application Explanation

\_\_\_\_\_  
\_\_\_\_\_  
\_\_\_\_\_  
\_\_\_\_\_

## Finish (Painted, Unpainted, Plating)

\_\_\_\_\_

## Critical Tolerances, Certifications or Inspections Required

\_\_\_\_\_  
\_\_\_\_\_  
\_\_\_\_\_  
\_\_\_\_\_

## Commitment to Quality & Customer Satisfaction

*Dayton Lamina is a leading manufacturer of tool, die and mold components for the metal-working and plastics industries. As a customer-focused, world-class supplier of choice, we provide the brands, product breadth, distribution network and technical support for all your metal forming needs.*

*Our goal is to give our customers the most innovative and value-added products and services.*



# DAYTON Lamina™

a MISUMI Group Company



Lamina® LEMPCO

\*Dayton Lamina's line of Danly products is available only to North America.

[www.daytonlamina.com](http://www.daytonlamina.com)