

Quick Coupling Selection Guide

- Determine the profile (shape) of the plug. Compare your plug shape with the profile chart below to identify the Dixon Quick Coupling pneumatic or hydraulic series.

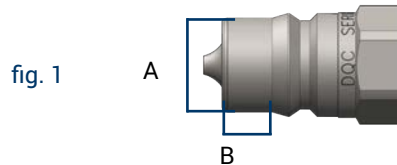



- Body size dimension charts can be found within each series section. Measure the **A** (diameter) and **B** (tip length) dimensions to determine the plug body size (figure 1).





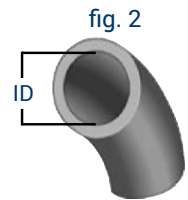





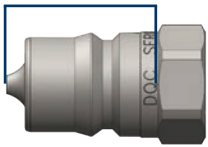





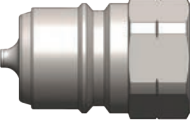





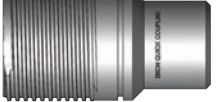
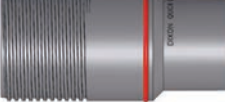

- Use the industry standard thread chart below (or diagram on page 6) to determine the end connection thread size. If you have a hose barb, the ID measurement of your hose will determine the barb size (figure 2).

Actual Thread OD or ID	3/8"	1/2"	5/8"	3/4"	1"	1-3/8"	1-5/8"	1-29/32"	2-3/8"
Nominal Thread Size	1/8"	1/4"	3/8"	1/2"	3/4"	1"	1-1/4"	1-1/2"	2"

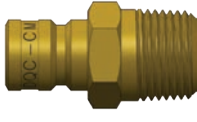

Pneumatic Profile Shape 		DF-Series steel • brass • 303 ss Industrial Interchange page 20	J-Series steel • brass Automotive page 30	M-Series steel • brass ARO 210-310 page 35
CJ-Series steel • brass High-Flow page 39	SHD-Series steel • aluminum Twist-Lock page 42	L-Series steel • brass Lincoln page 45	U-Series brass Universal Air page 47	N-Series steel • brass • 303 ss • 316 ss Bowes / Dix-Lock® page 49
P-Series steel • brass • 303 ss Thor / Dual-Lock page 57	NK-Series steel Japanese Industrial page 61	BR-Series brass 21 Series page 63	A-Series steel • brass Compact page 65	SCV-Series brass Safety Check Valve page 68

<p>Hydraulic Profile Shape</p> 	<p>H-Series steel • brass • 303 ss • 316 ss</p>  <p>ISO7241-B page 70</p>	<p>H-BOP-Series steel • 316 ss</p>  <p>ISO7241-B BOP page 80</p>	<p>HS-Series steel • brass • 303 ss</p>  <p>ISO7241-B Steam page 82</p>	<p>K-Series steel • 316 ss</p>  <p>ISO7241-A page 85</p>
<p>AG-Series steel</p>  <p>Agricultural page 91</p>	<p>V-Series steel • brass • 316 ss</p>  <p>MIL-C-51234 page 95</p>	<p>TR-Series steel</p>  <p>European page 112</p>	<p>HT-Series steel • 316 ss</p>  <p>Correct Connect® ISO16028 page 114</p>	<p>HTE-Series steel</p>  <p>ISO16028 Connect Under Pressure Plug pages 122</p>
<p>HTZ-Series steel</p>  <p>ISO16028 Connect Under Pressure Coupler page 125</p>	<p>HT-AG-Series steel</p>  <p>ISO16028 - AG ISO7241-A page 126</p>	<p>XK-Series steel</p>  <p>10K Flushface page 127</p>	<p>ST-Series steel • 316 ss</p>  <p>Heavy-Duty Flushface page 129</p>	<p>PD-Series steel</p>  <p>ISO15171-1 Test page 135</p>
<p>VEP-Series steel • 316 ss</p>  <p>Threaded Flushface page 137</p>	<p>VEP-BOP-Series steel</p>  <p>Threaded Flushface BOP page 142</p>	<p>W-Series steel • brass</p>  <p>Wingstyle page 144</p>	<p>WS-Series steel • 316 ss</p>  <p>Heavy-Duty Wingstyle page 149</p>	<p>WS-BOP-Series steel • 316 ss</p>  <p>Heavy-Duty Wingstyle BOP page 155</p>
<p>T-Series steel • 316 ss</p>  <p>10K Threaded page 157</p>	<p>CVV-Series steel</p>  <p>Euro-Threaded ISO14541 page 160</p>	<p>TD-Series 316 ss</p>  <p>15K and 20K Threaded page 164</p>	<p>E-Series steel • brass • 303 ss</p>  <p>Straight-Through page 166</p>	<p>EA-Series steel</p>  <p>Water Blast page 172</p>
<p>CM-Series brass</p>  <p>Mold Coolant page 174</p>				

Cross Reference Tool

Competitor Series or Standard	Manufacturer	Dixon Series	Page(s)
10000-Series	TEMA	TR-Series	112
1000-Series	Hansen	F-Series	20
10-Series	Parker	J-Series	30
1110-Series	Tomco	L-Series	45
13-Series	Rectus	NK-Series	61
20-Series	Parker	F-Series	20
210/310	Foster	M-Series	35
210/310	Hansen	M-Series	35
210/310	Milton	M-Series	35
21KA	Rectus	BR-Series	63
223-Series	CEJN	BR-Series	63
25KA	Rectus	CJ-Series	39
26KA	Rectus	CJ-Series	39
27KA	Rectus	CJ-Series	39
3000-Series	Hansen	D-Series	20
3000-Series	Parker/Pioneer	T-Series	157
30-Series	Parker	D-Series	20
315-Series	CEJN	NK-Series	61
320-Series	CEJN	CJ-Series	39
3800-Series	TEMA	TR-Series	112
3FFH-Series	Faster	HTE-Series	122
3-Series	Foster	DF-Series	20
4000 Series	Parker/Pioneer	AG-Series	91
4000-Series	Hansen	D-Series	20
400-Series	Hansen	F-Series	20
410-Series	CEJN	CJ-Series	39
4-Series	Foster	DF-Series	20
5000-Series	Hansen	D-Series	20
5000-Series	TEMA	TR-Series	112
500-Series	Hansen	F-Series	20
50-Series	Parker	M-Series	35
51000-Series	Bowes	N-Series	49
5100-Series	Eaton/Aeroquip	W-Series	144
525-Series	CEJN	TR-Series	112
55KM	Rectus	J-Series	30
56-Series	Snap-Tite	EA-Series	172
5-Series	Foster	DF-Series	20
5TV/6TV-Series	Hydraulics Inc	WS-Series	149
6000-Series	Hansen	D-Series	20
60-Series	Parker	H-Series	70

Competitor Series or Standard	Manufacturer	Dixon Series	Page(s)
60-Series	Snap-Tite	AG-Series	91
60-Series Steam	Parker	HS-Series	82
6100-Series	Foster	W-Series	144
6100-Series	Parker	W-Series	144
61-Series	Snap-Tite	K-Series	85
6600-Series	Parker	K-Series	85
6-Series	Foster	DF-Series	20
70-Series	Parker	L-Series	45
71-Series	DNP	ST-Series	129
71-Series	Snap-Tite	ST-Series	129
72-Series	Snap-Tite	H-Series	70
74-Series	Snap-Tite	HT-Series	114
7500-Series	TEMA	TR-Series	112
75-Series	Snap-Tite	WS-Series/ WS-BOP- Series	149 and 155
76-Series	Snap-Tite	T-Series	157
78-Series	Snap-Tite	W-Series	144
A2100/PT400	Tomco	J-Series	30
A-A-50431A	U.S. Government	N-Series	49
A-A-59439	U.S. Government	DF-Series	20
ANV-Series	DNP	K-Series	85
ANV-Series	Faster	K-Series	85
APM-Series	Stucchi	HTE-Series	122
ARO	Interchange	M-Series	35
A-Series	National	P-Series	57
A-Series	Stucchi	HT-Series	114
Auto-Flo 23	Hansen	U-Series	47
Automotive	Interchange	J-Series	30
BIR-Series	Stucchi	K-Series	85
Bowes	Interchange	N-Series	49
B-Series	National	N-Series	49
C604	Enerpac	T-Series	157
Correct Connect®	Trademark	HT-Series	114
CQD-Series	Spir Star	TD-Series	164
CRS-Series	DNP	TD-Series	164
CS-Series	Nycoil	SHD-Series	42
CVV-Series	Faster	CVV-Series	162
Dixlock	Trademark	N-Series	49
Double Lock	Campbell	P-Series	57

Competitor Series or Standard	Manufacturer	Dixon Series	Page(s)
D-Series	DNP	PD-Series	135
Dual-Lock	Trademark	P-Series	57
European Screw-Together	Interchange	CVV-Series	162
European	Nycoil	CJ-Series	39
European High-Flow	Interchange	CJ-Series	39
FB-Series	Faster	W-Series	144
FD45	Eaton/Aeroquip	H-Series	70
FD56 (5600) Series	Eaton/Aeroquip	K-Series	85
FD69-Series	Eaton/Aeroquip	EA-Series	172
FD85-Series	Eaton/Aeroquip	WS-Series	149
FD89-Series	Eaton/Aeroquip	HT-Series	114
FD90-Series	Eaton/Aeroquip	PD-Series	135
FD96-Series	Eaton/Aeroquip	VEP-Series	137
FEC-Series	Parker	HTE-Series	122
FEM-Series	Parker	HT-Series	114
FET-Series	Parker	VEP-Series	137
FF49-Series	Safeway	HT-Series	114
FFEC49-Series	Safeway	HTE-Series	122
FF-GP Series	DNP	HT-Series	114
FFK-Series	DNP	HTE-Series	122
FFN/FFI/2FFN/2FFI	Faster	HT-Series	114
FF-Series	Hansen	HT-Series	114
FF-Series	Parker	HT-Series 3/8" only	114
FHK-Series	Foster	H-Series	70
FH-Series	Voswinkel	HTE-Series	122
FIH/FH	Foster	V-Series	95
FIRG	Stucchi	HT-Series	114
FJT-Series	Foster	CM-Series	174
Flo-Temp	Hansen	CM-Series	174
FSI-BOP-Series	DNP	VEP-BOP-Series	142
FS-Series	Hansen	SCV-Series	68
FST-Series	Foster	E-Series	166
FT-Series	Voswinkel	VEP-Series	137
FVEP-Series	Foster	VEP-Series	137
H/IH-Series	Snap-Tite	V-Series	95
HA15000	Hansen	K-Series	85
HCP-Series	Holmbury	HTE-Series	122
HFB-Series	Holmbury	E-Series	166

Competitor Series or Standard	Manufacturer	Dixon Series	Page(s)
HFT-Series	Holmbury	VEP-Series	137
High Pressure Screw-Together	Interchange	T-Series	157
HKFR-Series	Eaton/Hansen	H-BOP-Series	80
HK-Series	Hansen	H-Series	70
HNV-BOP-Series	DNP	H-BOP-Series	80
HNVFR-Series	Faster	H-BOP-Series	80
HNV-Series	DNP	H-Series	70
HNV-Series	Faster	H-Series	70
HQ-Series	Holmbury	HT-Series	114
HSS-Series	Holmbury	HT-Series	114
HTN-Series	Holmbury	V-Series	95
IA/IAZ-Series	Holmbury	K-Series	85
IA-Series	Voswinkel	K-Series	85
IB/IBZ-Series	Holmbury	H-Series	70
IB-Series	Voswinkel	H-Series	70
Industrial	Interchange	DF-Series	20
IRB/IRBO/IRBX Series	Stucchi	H-Series	70
IRC-Series	Stucchi	TR-Series	112
IR-Series	Stucchi	AG-Series	91
ISO14540	ISO Standard	T-Series	157
ISO14541	ISO Standard	CVV-Series	160
ISO15171-1	ISO Standard	PD-Series	135
ISO16028	ISO Standard	HT-Series	114
ISO5675	ISO Standard	AG-Series	91
ISO6150B	ISO Standard	DF-Series	20
ISO7241-A	ISO Standard	K-Series	85
ISO7241-B	ISO Standard	H-Series	70
IVHP-Series	Stucchi	T-Series	157
Japanese Industrial	Interchange	NK-Series	61
JS-Series	DME	CM-Series	174
LC-Series	Holmbury	WS-Series	149
Lincoln	Interchange	L-Series	45
MC-Series	Tomco	CM-Series	174
Megaflow	Coilhose	CJ-Series	39
MIL-C-3486	Military Spec	N-Series	49
MIL-C-4109F	Military Spec	DF-Series	20
Mil-C-51234	Military Spec	V-Series	95

Cross Reference Tool

Competitor Series or Standard	Manufacturer	Dixon Series	Page(s)
Mold Coolant	Interchange	CM-Series	174
Moldmate	Parker	CM-Series	174
MPX-Series	Staubli	HT-Series	114
MQS-A Series	Manuli	K-Series	85
MQS-B Series	Manuli	H-Series	70
MQS-D Series	Manuli	PD-Series	135
MQS-F Series	Manuli	HT-Series	114
MQS-FP Series	Manuli	HTE-Series	122
MQS-SC Series	Manuli	T-Series	157
Ni-Cupla	Nitto Kohki	NK-Series	61
NS-Series	DNP	AG-Series	91
NS-Series	Faster	AG-Series	91
NS-Series/Jiffy-Tite	DME	CM-Series	174
NV-Series	Faster	AG-Series	91
OGF-Series	Faster	ST-Series	129
OGVFR-Series	Faster	WS-BOP-Series	155
OGV-Series	Faster	WS-Series	149
PD-Series	Parker	PD-Series	135
PHC-Series	Thor	P-Series	57
Pioneer Agricultural	Interchange	AG-Series	91
PSB/PSP-Series	Holmbury	T-Series	157
PST4/FSI Series	DNP	VEP-Series	137
PVM-Series	DNP	T-Series	157
PVV3-Series	DNP	CVV-Series	160
PVV3-Series	DNP	CVV-Series	160
PVVM/PVSM-Series	Faster	T-Series	157
Quick-Action	MacDonald	N-Series	49
S10-Series	Safeway	H-Series	70
S20-Series	Safeway	AG-Series	91
S30-Series	Safeway	T-Series	157
S51-Series	Safeway	W-Series	144
S56-Series	Safeway	K-Series	85
Schrader	Interchange	SHD-Series	42
Screw Type	Jet Stream	TD-Series	164
SC-Series	Tomco	BR-Series	63
SHD-Series	Foster	SHD-Series	42
SH-Series	Stucchi	V-Series	95
Single Lock	Campbell	N-Series	49
STG-Series	Inteva	CVV-Series	160

Competitor Series or Standard	Manufacturer	Dixon Series	Page(s)
Straight-Through	Interchange	E-Series	166
ST-Series	DNP	E-Series	166
ST-Series	Hansen	E-Series	166
ST-Series	Parker	E-Series	166
ST-Series	Tomco	E-Series	166
TEMA European	Interchange	TR-Series	112
TF-Series	Foster	J-Series	30
Thor	Interchange	P-Series	57
TL-Series	Parker	SHD-Series	42
TL-Series	Tomco	SHD-Series	42
TNL-Series	Faster	V-Series	95
TNV-Series	DNP	V-Series	95
TNV-Series	Faster	V-Series	95
Tru-Flate	Eaton/Hansen	J-Series	30
Tru-Flate	Hoffmann	J-Series	30
Twist-Lock	Schrader	SHD-Series	42
Type B	Amflo	M-Series	35
Type-17	Coilhose	L-Series	45
Type-HS	Voswinkel	CVV-Series	162
UC-Series	Coilhose	U-Series	47
UC-Series	Parker	U-Series	47
VD-Series	Stucchi	CVV-Series	162
VEP-HD Series	Stucchi	VEP-Series/ VEP-BOP-Series	137 and 142
VEP-P Series	Stucchi	VEP-Series/ VEP-BOP-Series	137 and 142
VFF-HD BOP-Series	DNP	WS-BOP-Series	155
VFF-HD Series	DNP	WS-Series	149
VFF-Series	DNP	W-Series	144
VOF-Series	Stucchi	WS-Series	149
Water-Blast	Interchange	EA-Series	172
WB-Series	DNP	EA-Series	172
WB-Series	Parker	EA-Series	172
Wing Style	Stucchi	W-Series	144
WS56000	Hansen	T-Series	157
WSC-Series	Holmbury	W-Series	144
X64-Series	CEJN	HTE-Series	122
X65/X66-Series	CEJN	HT-Series	114

Male / Female Pipe (NPTF) Thread Identification

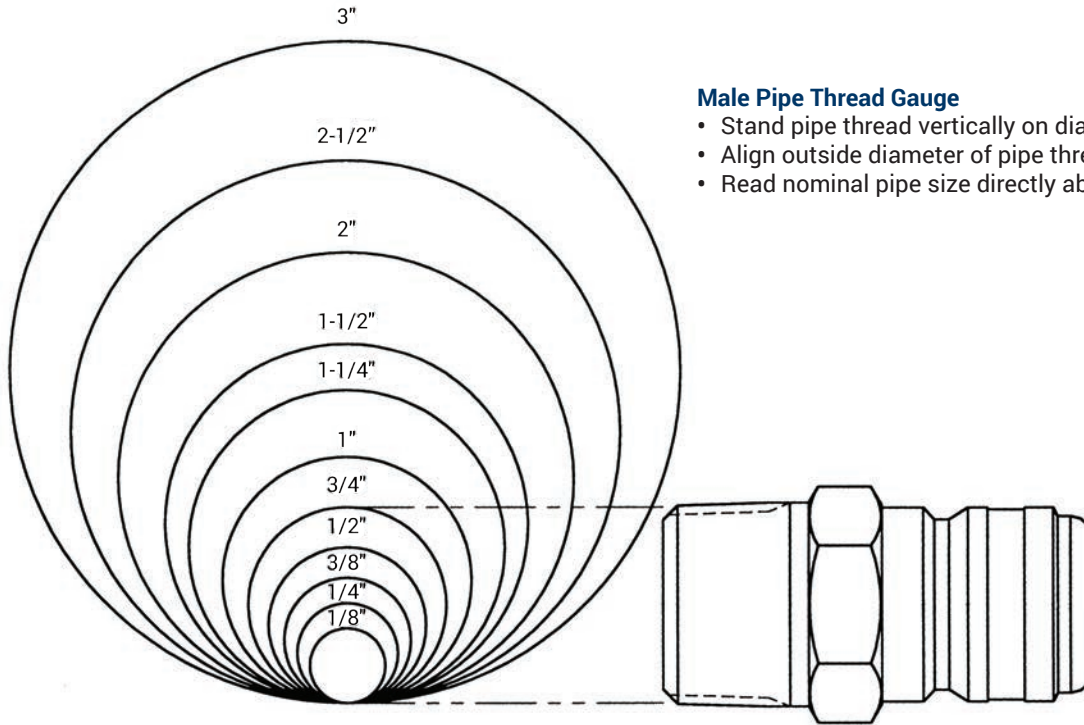

Male Pipe Thread Gauge

- Stand pipe thread vertically on diagram
- Align outside diameter of pipe thread with matching circle
- Read nominal pipe size directly above circle

Example: 3/4" male pipe
(Dixon end size = 6)

Female Pipe Thread Gauge

- Hold pipe thread against scale on edge of page
- Align one side of pipe thread with illustration base line
- Read nominal pipe size directly from scale

Nominal Pipe Size (inches)	Dixon End Size	Nominal Thread Size (inches)	Nominal Pipe Size (inches)
1/8	1	1/8 - 27	0.41
1/4	2	1/4 - 18	0.54
3/8	3	3/8 - 18	0.68
1/2	4	1/2 - 14	0.84
3/4	6	3/4 - 14	1.05
1	8	1-11 - 1/2	1.32
1-1/4	10	1-1/4 - 11-1/2	1.66
1-1/2	12	1-1/2 - 11-1/2	1.90
2	16	2 - 11-1/2	2.38
2-1/2	20	2-1/2 - 8	2.88
3	24	3 - 8	3.50

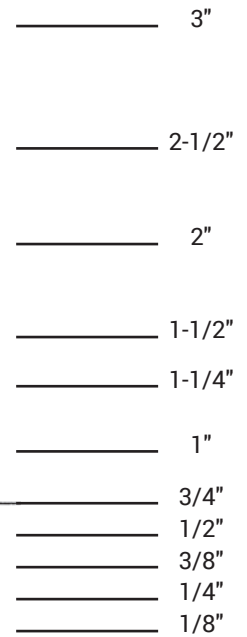

Example: 3/4" female pipe
(Dixon end size = 6)

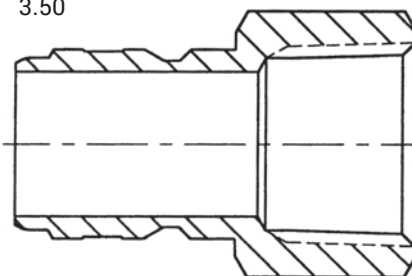

Base line for all sizes

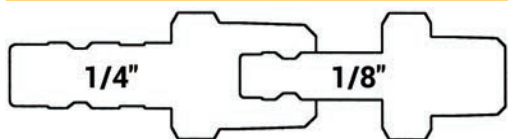

A-Series



BR-Series

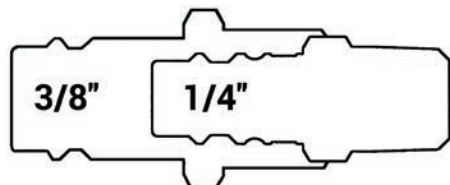

CJ-Series

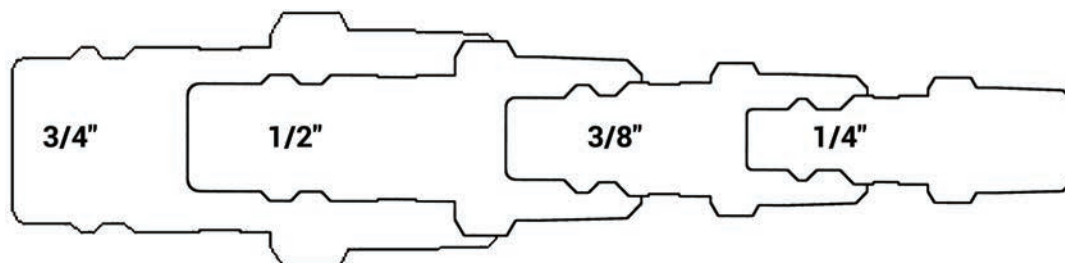

DF-Series

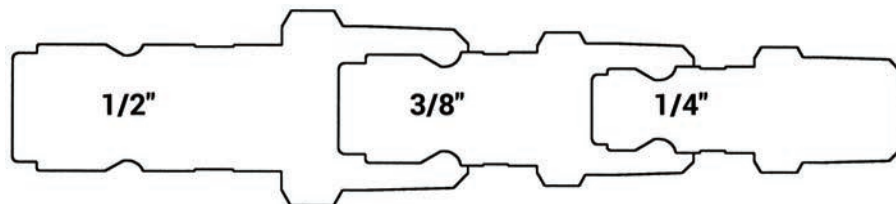

J-Series

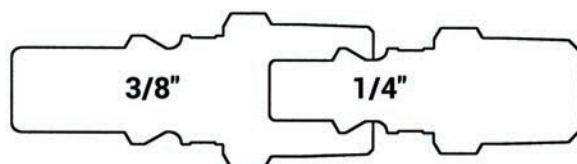

M-Series



L-Series

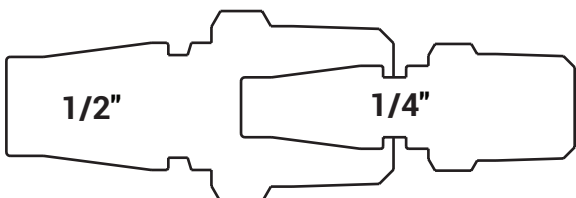

SHD-Series

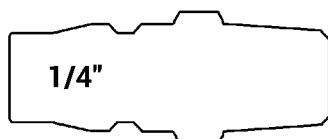

NK-Series

K-Series

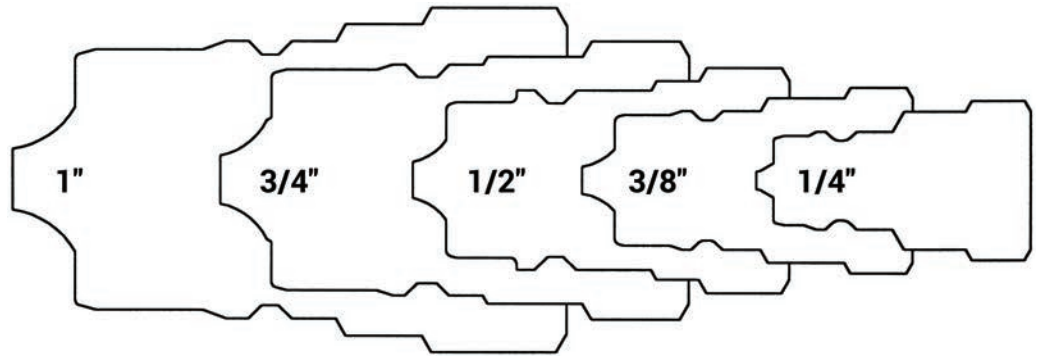

Large K-Series

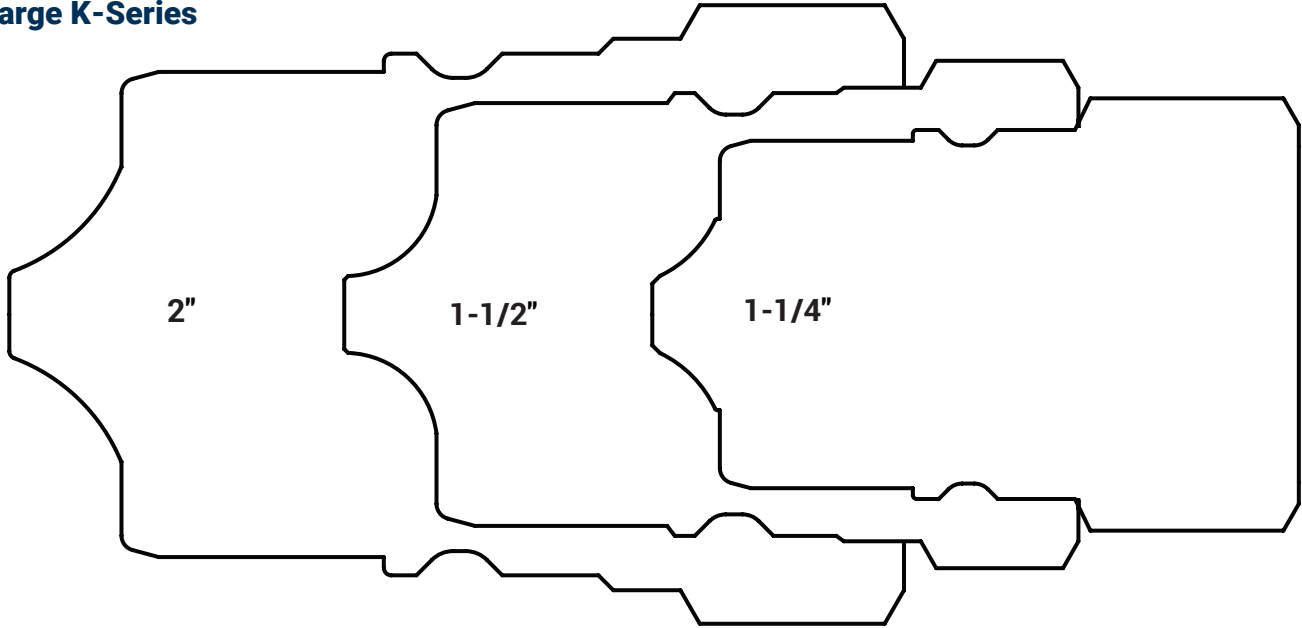

AG-Series

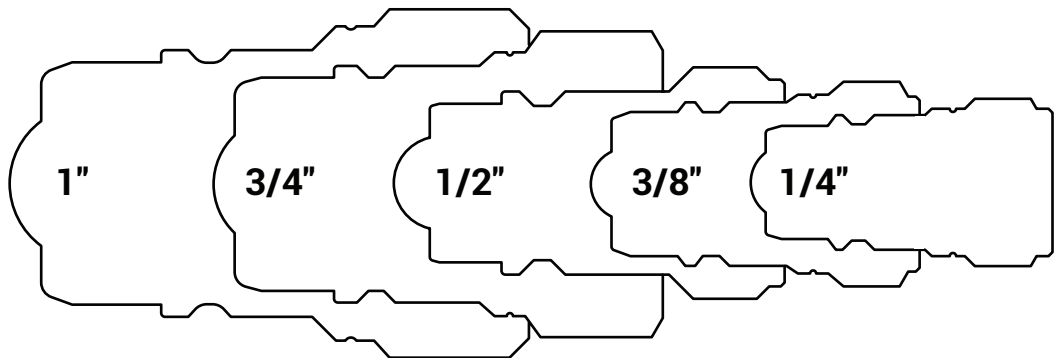

TR-Series

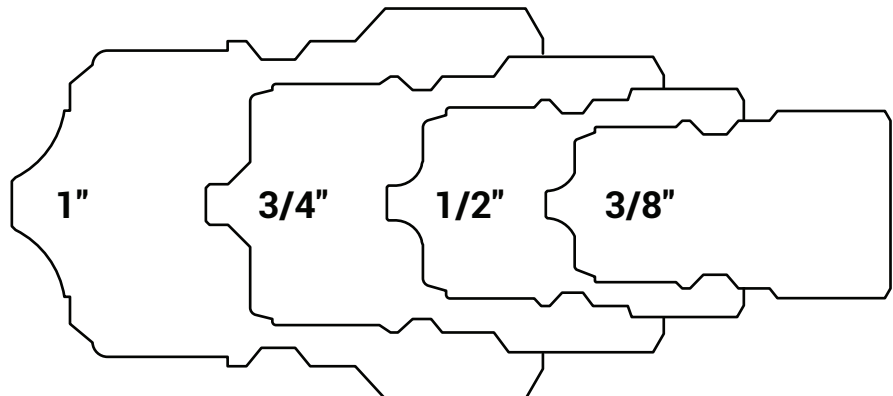

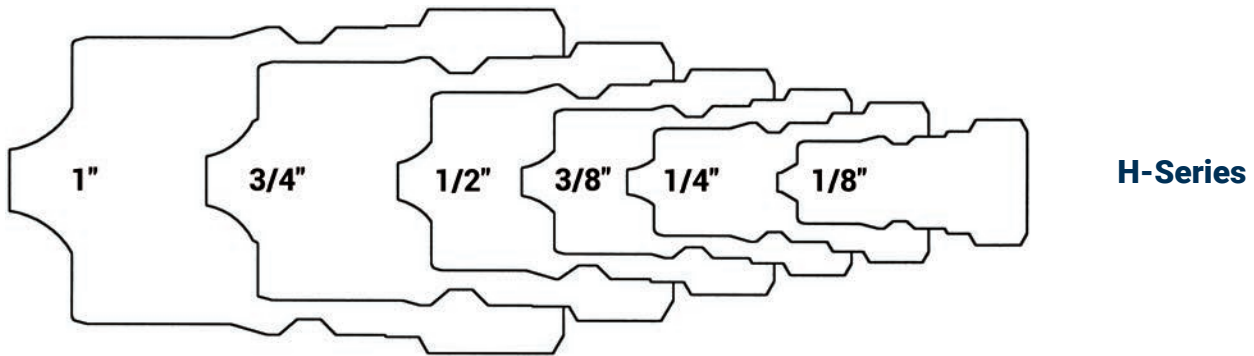

H-Series

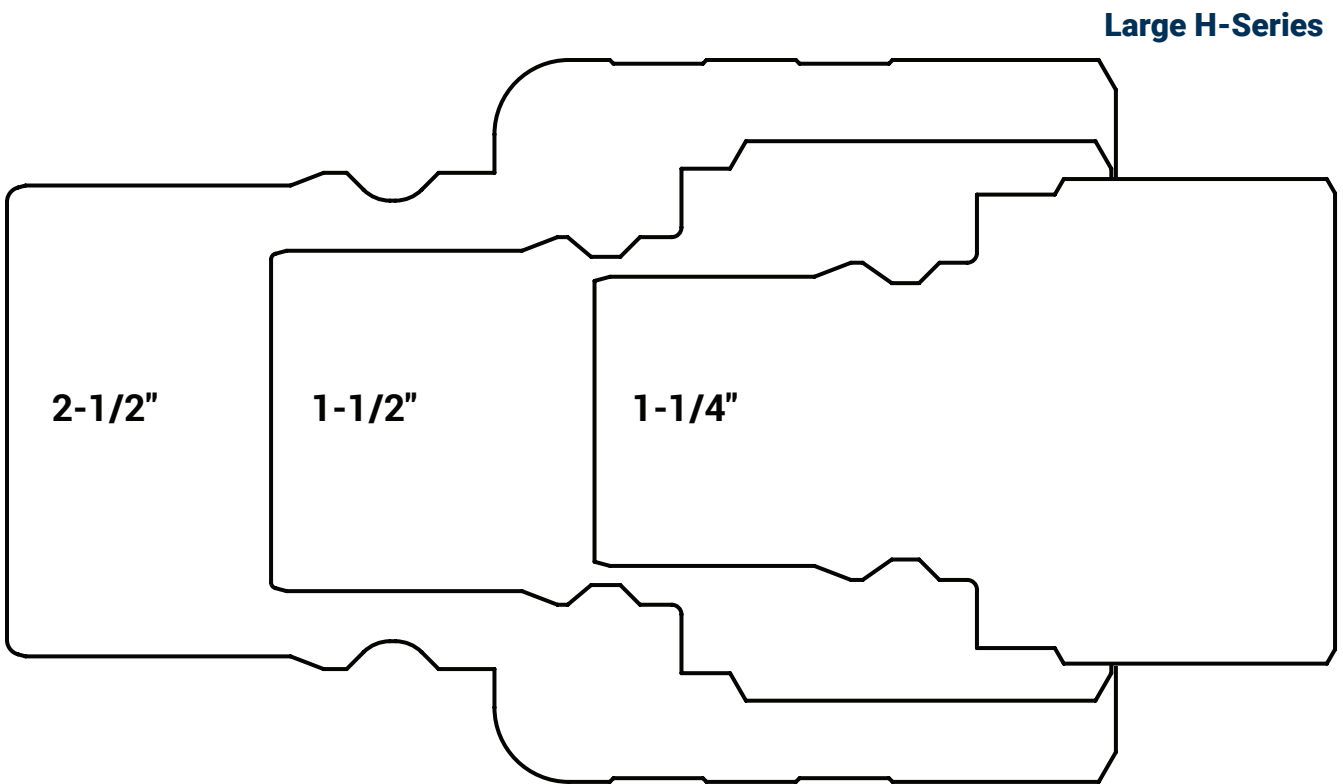

Large H-Series

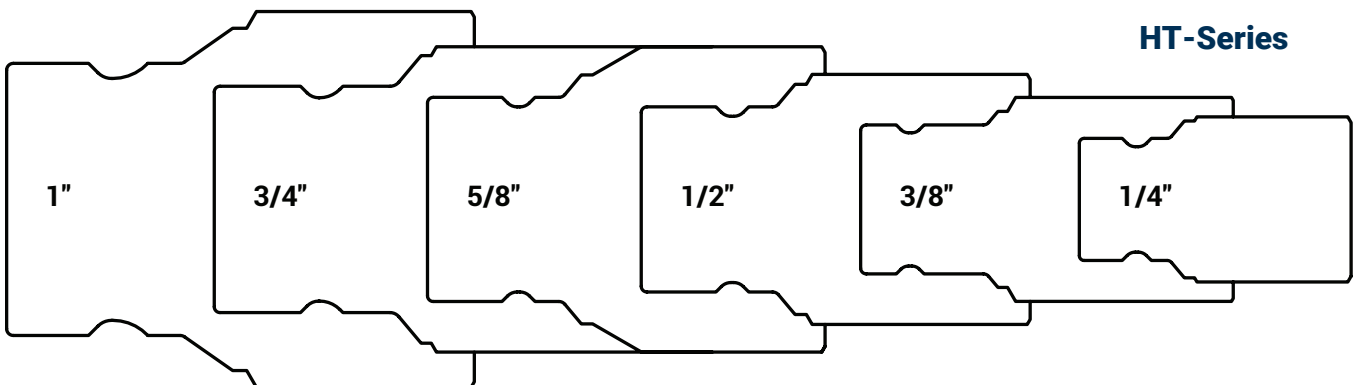

HT-Series

V-Series

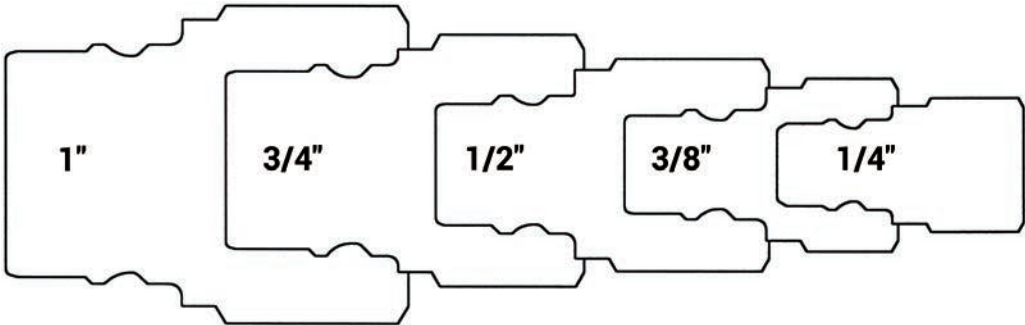

Large V-Series

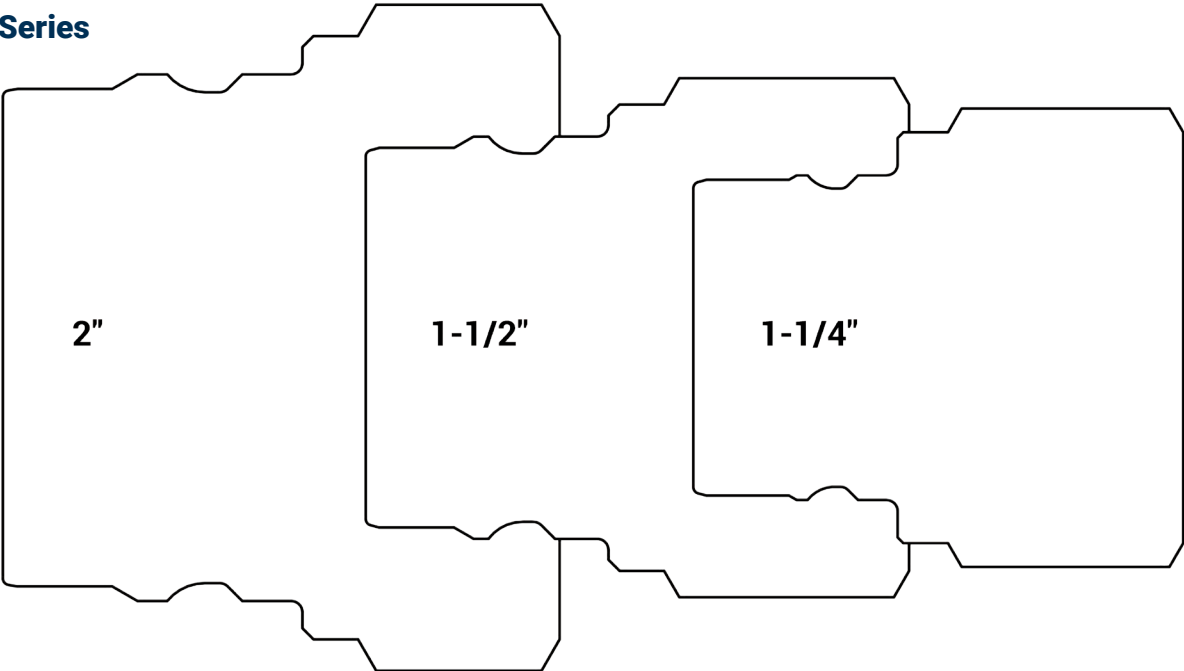

W-Series

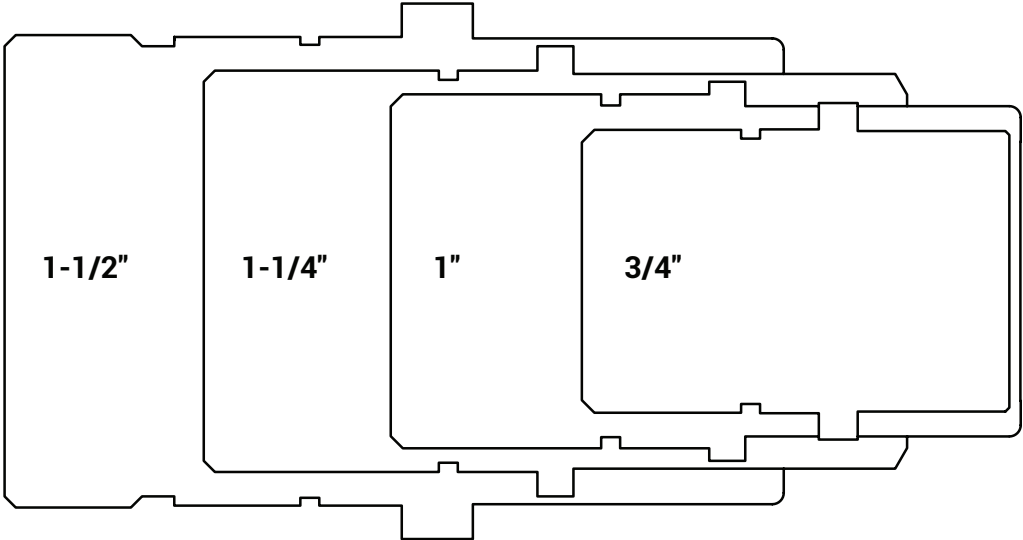

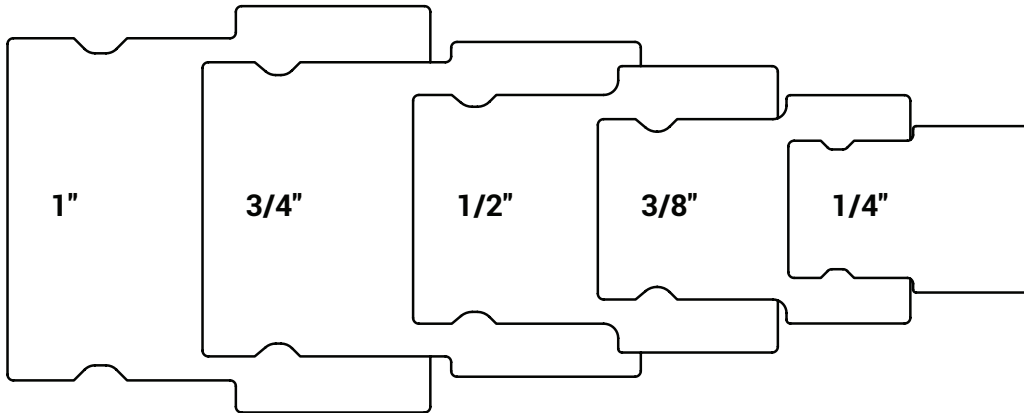

ST-Series

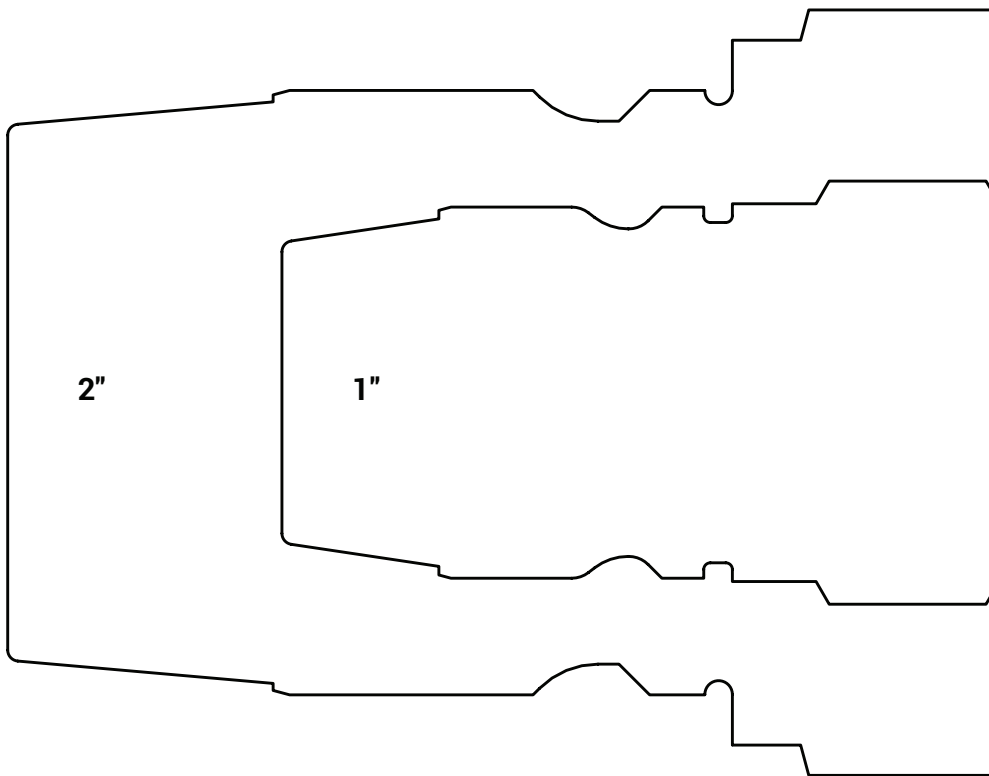

Large ST-Series

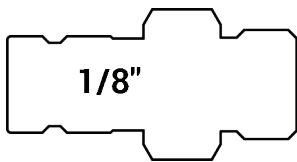

PD-Series

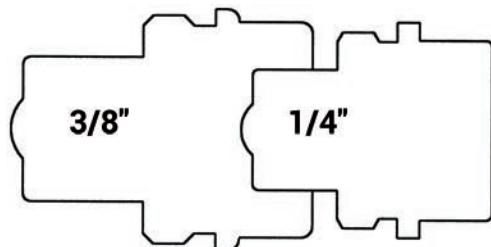

T-Series

E-Series

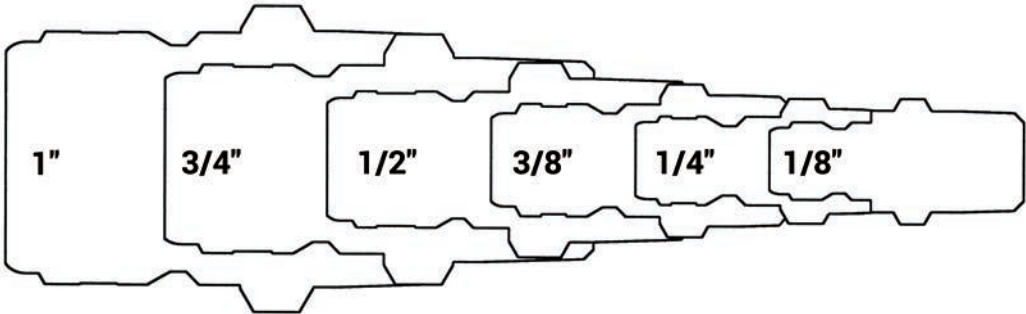

Large E-Series

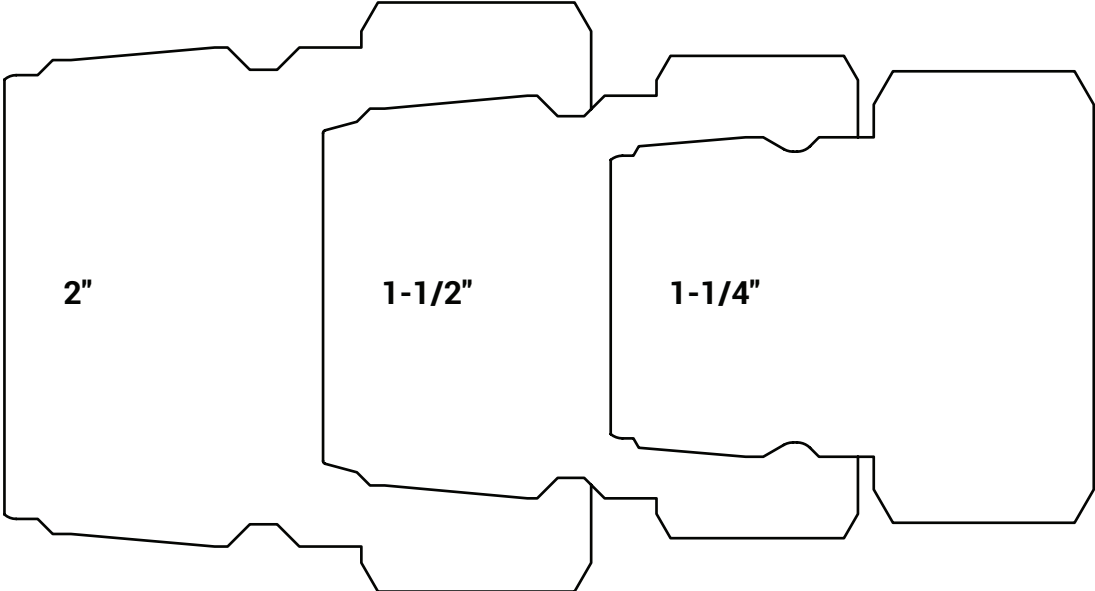

EA-Series

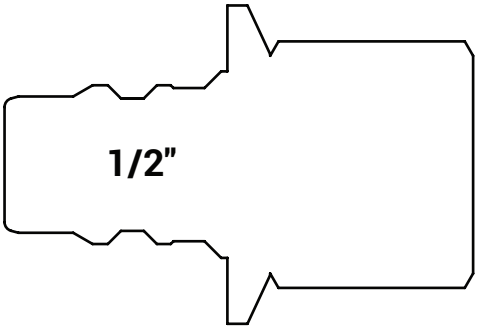

CM-Series

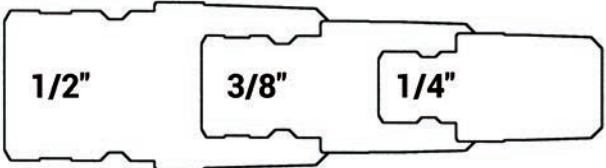

Be Safe When Selecting Quick Couplings

 All quick disconnect couplings should be viewed as potential hazards that can cause property damage, personal injury or even death if used or installed improperly. Improper use includes selecting a product unsuitable for your application, installing or using the product incorrectly, and/or ignoring signs of imminent failure or misuse. Failure may result in explosive propulsion of components, rapid expulsion of hazardous media, and failure or unintentional movement of a fluid-powered component.

Proper Selection of Quick Disconnect Couplings

The very properties that make a compressed media useful in almost every area of modern life can also make it dangerous when mishandled. Dixon quick disconnect couplings have been carefully engineered to meet specific industry requirements while maintaining abundant safety margins. If quick disconnect couplings are not used in the correct applications or are incorrectly applied, accidents and downtime can result. It is up to the end user to inform the distributor of the application and pressures involved when ordering quick disconnect couplings, and it is up to the distributor to supply the right coupling for the application.

The use of S.T.A.M.P.E.D. will help in the proper selection of quick disconnect coupling products. When in doubt, Dixon will provide information, including test results (if available), coupling recommendations, and other data to help resolve quick disconnect coupling related issues.

S.T.A.M.P.E.D. Questions and Selection Process

Size	<p>Couplings should be selected to handle the flow and pressure requirements of the system. Excessive pressure drop will result in restricted flow, slower actuation, higher fluid velocity, heat generation, and eventually a breakdown of fluids, seals, and components.</p> <ol style="list-style-type: none"> 1. What size coupler is required? 2. What is the maximum allowable pressure drop for the application? 3. Are there any size restrictions due to a 'tight-spot' installation?
Temperature	<p>Media and ambient temperatures must be limited to the specific operating parameters of the selected sealing materials. Excessive cold will reduce sealing capability, while excessive heat can cause the premature breakdown of body and valve seals.</p> <ol style="list-style-type: none"> 1. What is the media/fluid temperature? 2. What is the ambient temperature? 3. Are there any 'flash' heat or fire sources near the connection?
Application	<p>Quick coupling interchangeability needs to be closely reviewed. There are several instances where non-interchangeable couplers and plugs may connect. This is very dangerous and these couplings should never be pressurized. Be sure to match like series couplers and plugs.</p> <ol style="list-style-type: none"> 1. Is an industry interchange coupler required? 2. What are the functional requirements of the coupling? 3. Have there been any problems with other couplings in this application?
Media	<p>Quick disconnect couplings are available with a variety of body materials and seal options. Exposure to harsh and corrosive operating environments may reduce service life. Several quick couplings spill fluid upon disconnection, which may be a safety concern.</p> <ol style="list-style-type: none"> 1. Which seal and body materials are compatible with the system fluid? 2. Is air inclusion, system contamination, or fluid loss a concern? 3. Is this fluid dangerous to the operator?
Pressure	<p>During the selection process, the published working pressure of the coupling must be equal to or greater than the maximum system pressure. Surge pressures in a fluid power system, higher than the rated pressure, will shorten the service life of the coupling.</p> <ol style="list-style-type: none"> 1. Is the pressure 'static' or 'dynamic'? 2. What is the maximum operating pressure required for the application? 3. Are there any pressure spikes in the system?
Ends	<p>Many end configurations are available and each one has specific operating parameters. For example, the working pressure of couplings utilizing hose barb or collar hose barb end connections may be dramatically reduced. If in doubt, test under controlled conditions for suitability to the application.</p> <ol style="list-style-type: none"> 1. What end configuration and size is required? (male threaded, female threaded, or hose barb) 2. Does the chosen end configuration support the application parameters and system pressure? 3. What is the ideal valving configuration? (single shut-off, double shut-off, or unvalved)
Details	<p>Forgotten or missed application details can cause a failure if not properly addressed. Be meticulous in the assessment of your application to ensure that all parameters are considered in the selection of the proper quick disconnect coupling.</p> <ol style="list-style-type: none"> 1. Are there any side-load, vibration, or swivelling problems associated with the application? 2. Does the coupling require a safety sleeve-lock mechanism? 3. Are there any environmental concerns that need to be addressed?

! Quick disconnect couplings can fail without warning. Prior to the operation of quick coupling products, be sure to inspect and replace worn out fittings and safety devices. If a leak is detected during operation, release the pressure from the circuit before investigating the cause of the fluid leak. Do not use your fingers or skin to check for leaks. High-pressure leaks of fluids can easily penetrate the skin and can cause serious injury or death.

Safe Quick Coupling Practices

1. Always wipe the coupling cavities and faces clean before connecting a coupling.
2. Connect coupling before installation to ensure that it works properly.
3. Always check the body seals before connecting a coupling.
4. Shut off power source before connecting a coupling.
5. Always install a safety check valve on a pneumatic line and/or compressor.
6. Always use a safety cable on large air lines (1/2" lines and larger).
7. Always use a whip hose on hydraulic or air tools.
8. Use dust caps or plugs when couplings are not in use.
9. If the locking sleeve is inoperable, check the safety lock.
10. Wear eye protection while connecting or disconnecting a coupling.

Unsafe Quick Coupling Practices

1. Never hit coupling valves to release trapped pressure.
2. Never leave couplings in the path of moving equipment.
3. Never use couplings near a welder, flash heat, or fire/flare sources.
4. Never use API modified sealants or over-apply PTFE tape during installation.
5. Use care if you must install quick couplings onto black iron pipe.
6. Never hit a coupling sleeve with a hammer or blunt object.
7. Never overtighten a coupling connection.
8. Never rotate a quick disconnect coupling under pressure.
9. Do not over-pressurize quick disconnect couplings.
10. Never use a hose with a quick disconnect coupling to lift a tool.

OSHA Regulations Ensure Operator Safety



Safety King Cable®



Safety Check Valves

Standard - 29 CFR, 1926.302 (partial):

(b)(1) Pneumatic power tools shall be secured to the hose or whip by some positive means to prevent the tool from becoming accidentally disconnected.

(b)(2) Safety Clips or retainers shall be securely installed and maintained on pneumatic impact (percussion) tools to prevent attachments from being accidentally expelled.

(b)(4) Compressed air shall not be used for cleaning purposes except where reduced to **30 PSI** and then only with effective chip guarding and personal protective equipment which meets the requirements of Subpart E of this part. The **30 PSI** requirement does not apply for concrete form, mill scale, and similar cleaning purposes.

(b)(5) The manufacturer's safe operating pressure for hoses, pipes, valves, filters and other fittings shall not be exceeded.

(b)(6) The use of hoses for hoisting or lowering tools shall not be permitted.

(b)(7) All hoses exceeding 1/2" inside diameter shall have a safety device at the source of supply or branch line to reduce pressure in case of hose failure.

Standard - 29 CFR, 1926.603 (partial):

(a)(9) Steam hose leading to a steam hammer or jet pipe shall be securely attached to the hammer with an adequate length of at least 1/4" diameter chain or cable to prevent whipping in the event the joint at the hammer is broken. Air hammer hoses shall be provided with the same protection as required for steam lines.

(a)(10) Safety chains, or equivalent means, shall be provided for each hose connection to prevent the line from thrashing around in case the coupling becomes disconnected.

The regulations may be viewed in full on the OSHA website, osha.gov. Please check the website for updates.

Be Safe When Installing Quick Couplings

! All quick disconnect couplings should be viewed as potential hazards that can cause property damage, personal injury, or even death if used or installed improperly.

Couplings should be installed in a location that will allow easy operation of the coupling and accessibility for all necessary installation tools. Care should be given to consider operator safety, especially if spillage upon disconnection could result in fluid ignition or skin and eye irritation.

Only apply wrenches to the hex or machined wrench flats that are provided for assembly purposes, nowhere else. Never clamp on the sleeve of the coupler or the nose of the plug as this will cause distortion and/or damage.

Finally, always test quick coupling installations before putting into operation by pressurizing the unit to 150% of the working pressure in an enclosed/protective environment.

Installation of Tapered Thread Connections (NPTF)

The seal for NPTF threads is created by the metal-to-metal contact between the roots and crests of the male and female threads. Using too much PTFE tape or pairing liquid sealant with PTFE tape may cause distortion, poor thread engagement, or cracking of the coupling during assembly.

The total number of tapered threads engaged should be between 3-1/2 to 6. Any number of threads outside this range may indicate either under-or over-tightening of the joint or out-of-tolerance threads. After assembly of an NPTF thread connection, always proof-test the connection before operating the system. If the joint proves to be inadequately tightened during proof-pressure testing, tighten it further in 1/8 turn increments until a reliable seal is attained. (Do not exceed 3 turns from finger tight (TFFT))



Apply 1-1/2 to 2 wraps of PTFE tape, starting one or two threads from the lead edge, in a clockwise direction. For 316 stainless steel, be sure to use stainless grade tape.



Check threads to make sure there is no obvious damage on either half and that tape is properly installed. Align male and female threaded connections and carefully begin threading the two halves together.



Finger tighten the connection and create a reference mark on the hex of the hose end/adaptor and the coupling. This mark will help identify the number of revolutions during the next step in the procedure.



With even and smooth force applied, wrench tighten according to the TFFT values listed below. **DO NOT OVERTIGHTEN.**

SAE Size	NPTF Thread Size	TFFT
-4	1/4" - 18	2
-6	3/8" - 18	2
-8	1/2" - 14	2
-12	3/4" - 14	1.5
-16	1" - 11-1/2	1.5

Be Safe When Installing Quick Couplings

Installation of O-ring Boss (ORB) Connections



Lightly lubricate the O-ring on the adapter and thread it into the coupling. Hand-tighten, ensuring that the O-ring is not pinched during installation.



Wrench tighten the connection to the appropriate torque specification, as shown in the chart below.

SAE Size	Thread Size	Torque (Nm)	Torque (lb-ft)
-4	7/16" - 20	18 - 20	13 - 15
-6	9/16" - 18	29 - 33	22 - 24
-8	3/4" - 16	49 - 53	40 - 43
-10	7/8" - 14	59 - 64	43 - 48
-12	1-1/16" - 12	93 - 102	68 - 75
-16	1-5/16" - 12	151 - 166	112 - 123
-20	1-5/8" - 12	198 - 218	146 - 161
-24	1-7/8" - 12	209 - 231	154 - 170

Installation of 37° Flare (JIC) Connections



Lightly lubricate the flare on the adapter and thread it into the coupling. Hand-tighten, ensuring that the flare is seated correctly during installation.



Wrench tighten the connection to the appropriate torque specification, as shown in the chart below.

SAE Size	Thread Size	Torque (Nm)	Torque (lb-ft)
-4	7/16" - 20	15 - 16	11 - 12
-6	9/16" - 18	24 - 28	18 - 20
-8	3/4" - 16	49 - 53	36 - 39
-10	7/8" - 14	77 - 85	57 - 63
-12	1-1/16" - 12	107 - 119	79 - 88
-16	1-5/16" - 12	147 - 154	108 - 113
-20	1-5/8" - 12	172 - 181	127 - 133
-24	1-7/8" - 12	215 - 226	158 - 167

Be Safe When Installing Quick Couplings

Installation of Reusable Hose Couplings

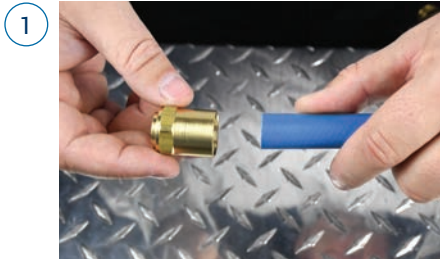

Trim the end of the hose as square as possible.



Install ferrule by slipping it onto the end of the hose and twisting it counter-clockwise.

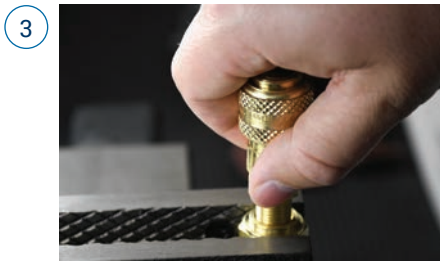

Apply lubricant sparingly to the reusable barbs before inserting it into the ferrule.



Turn the reusable fitting into the ferrule until coupling is seated against ferrule.

Installation of Push-Loc Hose Connections

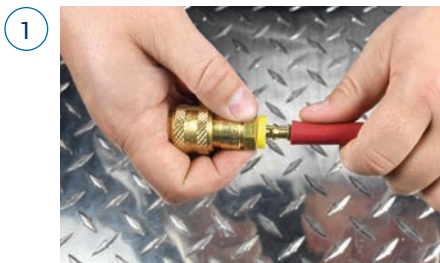

Trim hose end squarely and lubricate the Push-Loc barbs and hose. Insert Push-Loc barbs into the hose until first barbs are inside the hose.



Place the end of the fitting against a flat object and grip the hose one inch from end. Push with a steady force until the end of hose is covered by the yellow plastic cap.

Be Safe When Installing Quick Couplings

Installation of N and P Series Ferruled Hose Barbs

Note that the charts below are to be used only as a guide and not as a steadfast rule for every coupling application. In some instances, alternative dies and crimped dimensions must be employed. Hoses, as well as couplings, react differently during crimping. This is due to the fact that there are variances in hose constructions for hose with similar dimensions. Some variables are: textile braid versus wire braid, hardwall versus softwall, presence or lack of internal spiral wire as well as differences in hose covers. In addition, the outer diameter of the hose tends to fluctuate from end to end and production lot to production lot. With this in mind, we suggest that you measure the hose OD and maintain accurate records for each coupling application.

Hose ID	Fractional Hose OD	Decimal Hose OD	'N' Crimp Length	'N' Crimp OD ±.005	'P' Crimp Length	'P' Crimp OD ±.005
1/2"	54/64"	0.844	1-1/8"	0.917	1-1/4"	0.917
	55/64"	0.859	1-1/8"	0.929	1-1/4"	0.929
	56/64"	0.875	1-1/8"	0.942	1-1/4"	0.942
	57/64"	0.891	1-1/8"	0.954	1-1/4"	0.954
	58/64"	0.906	1-1/8"	0.967	1-1/4"	0.967
	59/64"	0.922	1-1/8"	0.980	1-1/4"	0.980
	60/64"	0.938	1-1/8"	0.992	1-1/4"	0.992
	61/64"	0.953	1-1/8"	1.005	1-1/4"	1.005
	62/64"	0.969	1-1/8"	1.018	1-1/4"	1.018
	63/64"	0.984	1-1/8"	1.030	1-1/4"	1.030
	1"	1.000	1-1/8"	1.043	1-1/4"	1.043
	1-1/64"	1.016	1-1/8"	1.056	1-1/4"	1.056
1-2/64"	1.031	1-1/8"	1.068	1-1/4"	1.068	
3/4"	1-10/64"	1.156	1-1/4"	1.220	1-1/4"	1.220
	1-11/64"	1.171	1-1/4"	1.235	1-1/4"	1.235
	1-12/64"	1.187	1-1/4"	1.244	1-1/4"	1.244
	1-13/64"	1.203	1-1/4"	1.260	1-1/4"	1.260
	1-14/64"	1.218	1-1/4"	1.270	1-1/4"	1.270
	1-15/64"	1.234	1-1/4"	1.285	1-1/4"	1.285
	1-16/64"	1.250	1-1/4"	1.295	1-1/4"	1.295
	1-17/64"	1.265	1-1/4"	1.310	1-1/4"	1.310
	1-18/64"	1.281	1-1/4"	1.320	1-1/4"	1.320
	1-19/64"	1.296	1-1/4"	1.335	1-1/4"	1.335
	1-20/64"	1.312	1-1/4"	1.345	1-1/4"	1.345
	1-21/64"	1.328	1-1/4"	1.360	1-1/4"	1.360
	1-22/64"	1.343	1-1/4"	1.370	1-1/4"	1.370

Installation of Light-Duty Ferrules

Hose ID	Fractional Hose OD	Decimal Hose OD	Dixon Part #	Ferrule Thickness	SMOD	% Compression	Crimp Diameter
1/2"	54/64"	0.8438	CCF0906	0.024	0.513	15	0.853
	55/64"	0.8594	CCF0906	0.024	0.513	15	0.866
	56/64"	0.8750	CCF0906	0.024	0.513	15	0.880
3/4"	1-5/64"	1.0781	CCF1120	0.030	0.763	20	1.086
	1-6/64"	1.0938	CCF1120	0.030	0.763	20	1.098
	1-7/64"	1.1094	CCF1149	0.030	0.763	20	1.111
	1-8/64"	1.1250	CCF1149	0.030	0.763	20	1.123
	1-9/64"	1.1406	CCF1190	0.025	0.763	20	1.126
	1-10/64"	1.1563	CCF1190	0.025	0.763	20	1.138
	1-11/64"	1.1719	CCF1218	0.025	0.763	20	1.151
	1-12/64"	1.1875	CCF1218	0.025	0.763	20	1.163
	1-13/64"	1.2031	CCF1246	0.030	0.763	20	1.186
	1-14/64"	1.2188	CCF1246	0.030	0.763	20	1.198
	1-15/64"	1.2344	CCF1277	0.030	0.763	20	1.211
	1-16/64"	1.2500	CCF1277	0.030	0.763	20	1.223
1"	1-25/64"	1.3906	CCF1438	0.030	1.007	20	1.380
	1-26/64"	1.4063	CCF1438	0.030	1.007	20	1.392
	1-27/64"	1.4219	CCF1469	0.030	1.007	20	1.405
	1-28/64"	1.4375	CCF1469	0.030	1.007	20	1.417
	1-29/64"	1.4531	CCF1500	0.030	1.007	20	1.430
	1-30/64"	1.4688	CCF1500	0.030	1.007	20	1.442
	1-31/64"	1.4844	CCF1531	0.030	1.007	20	1.455
	1-32/64"	1.5000	CCF1531	0.030	1.007	20	1.467

Fluid Compatibility Guide

! The following chart is intended only as a guide in selecting various elastomers and metals for use with fluids to be conveyed through Dixon quick disconnect couplings. This list does not guarantee suitability for a particular application. Final selection is dependent upon operating pressure, fluid and ambient temperature, concentration of media, duration of exposure, environmental conditions, and frequency of connection and disconnection.

Material	Prefix Code	Trade Name	Availability	Range °F	Range °C
Buna-N	Standard	Nitrile	Stock	-40°F to 250°F	-40°C to 121°C
Buna-N (MIL-H-5606 Fluids)	M-	Nitrile	1-2 weeks	-65°F to 275°F	-54°C to 135°C
Buna-N (Hydrocarbon Fuels)	JF-	Nitrile	1-2 weeks	-65°F to 160°F	-54°C to 71°C
Fluorocarbon Rubber	F-	FKM	1-2 weeks	-20°F to 400°F	-29°C to 204°C
Ethyl Propylene Diene Monomer	P-	EPDM	1-2 weeks	-65°F to 300°F	-54°C to 149°C
Neoprene	E-	Neoprene	1-2 weeks	-45°F to 300°F	-43°C to 149°C
Silicone	S-	Silicone	1-2 weeks	-100°F to 350°F	-73°C to 177°C
Fluorosilicone (FVMQ)	FS-	Silastic®	1-2 weeks	-76°F to 376°F	-60°C to 180°C
Urethane	U-	Urethane	3-4 weeks	-40°F to 180°F	-40°C to 82°C
Polyurethane	UP-	Polyurethane	3-4 weeks	-65°F to 212°F	-54°C to 100°C
PTFE Encapsulated Silicone	TS-	TES	3-4 weeks	-100°F to 400°F	-73°C to 204°C
PTFE Encapsulated Fluorocarbon	TF-	TEF	3-4 weeks	-100°F to 400°F	-73°C to 204°C
Perfluoroelastomer (Compound 1)	K4-	Kalrez® 4079	6-8 weeks	-4°F to 600°F	-20°C to 316°C
Perfluoroelastomer (Compound 2)	K6-	Kalrez® 6375	6-8 weeks	-4°F to 525°F	-20°C to 275°C
Perfluoroelastomer (Compound 3)	K7-	Kalrez® 7075	6-8 weeks	-4°F to 620°F	-20°C to 327°C
Fluoroelastomer	H-	Aflas®	3-4 weeks	23°F to 400°F	-5°C to 204°C

Media Name	Suggested Seal	Media Name	Suggested Seal	Media Name	Suggested Seal
Acetic Anhydride	P-	Freon, General	E-	Mineral Spirits	Standard
Acetone	P-	Ferric Hydroxide	Standard	Nickel Acetate	P-
Acetylene	Standard	Formaldehyde (50%)	P-	Nickel Sulphate	P-
Air (To 200°F)	Standard	Fuel Oils, General	Standard	Nitrogen, Gas	Standard
Air (Above 200°F)	F-	Gasoline	Standard	Nitrous Oxide	Standard
Alcohol, Ethyl	P-	Glycerine (Glycerol)	Standard	Octane	F-
Alcohol, Methyl	Standard	Glycols	P-	Oleum Spirits	Standard
Alkalis, General	Standard	Helium	Standard	OS45 and OS45-1	F-
Ammonia, Aqueous	P-	Heptane	Standard	Oxygen, Non-Breathing	F-
Ammonia, Gas	P-	Hexane	Standard	Paint Thinner	F-
Ammonia, Anhydrous	P-	Hydraulic Oil, Aircraft	Standard	Paraffin	Standard
Ammonia, Hydroxide	P-	Hydraulic Oil, Petroleum	Standard	Peanut Oil	Standard
Aroclor	F-	Hydraulic Oil, Phosphate	P-	Pentane	Standard
Benzene (Benzol)	F-	Hydrogen Gas	Standard	Perchloroethylene	F-
Bleach Solutions	P-	Hydrolube	Standard	Phosphoric Acid (100%)	P-
Brake Fluid, Non-Petro	P-	Isobutyl Alcohol	P-	Photographic Solutions	P-
Bromine Gas	F-	Isopropyl Alcohol	F-	Potassium Acetate	P-
Butyl Alcohol	Standard	Jet Fuel (to 160°F)	JF-	Propylene	F-
Carbon Dioxide, Dry	Standard	Jet Fuel (above 160°F)	F-	Propylene Glycol	Standard
Carbon Dioxide, Wet	Standard	Kerosene	Standard	Silicone Oil	Nitrile
Carbon Monoxide	Standard	Lindol	P-	Steam, General Service	H-
Carbon Tetrachloride	F-	Magnesium Hydroxide	F-	Stoddard Solvent	Standard
Cellulube	P-	Methane	Standard	Sulphuric Acid (100%)	F-
Creosote	F-	Methanol	Standard	Toluene	F-
Crude Oil	F-	Methyl Bromide	F-	Transmission Fluid (A)	Standard
Cutting Oil	Standard	Methyl Ethyl Ketone (MEK)	P-	Trichloroethylene	F-
Diesel Fuel	Standard	MIL-F-81912 (JP-9)	P-	Turpentine	Standard
Diester Lubricants	F-	MIL-H-5606	M1-	Vegetable Oil	Standard
Ethane	Standard	MIL-H-5806	Standard	Water	Standard
Ethanol	P-	MIL-H-6083	Standard	Water, Distilled	Standard
Ethyl Chloride	Standard	MIL-H-7083	Standard	Water, Dionized	Standard
Ethylene Glycol	P-	Mineral Oils	Standard	Water, Sea	P-

Pneumatic Couplings: DF-Series

Interchange Data

- Parker 20-series manual interchange (F-series)
- Parker 30-series automatic interchange (D-series)
- Foster 3, 4, 5, and 6 series
- Hansen 1000, 400, 500 (F-series)
- Hansen 3000, 4000, 5000, 6000 (D-series)

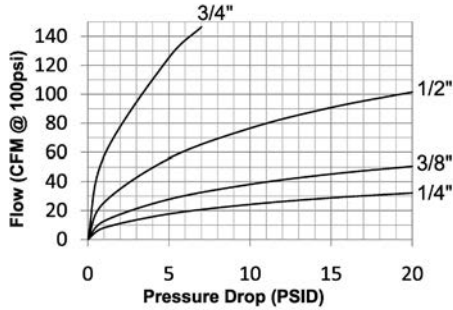

Materials

- Machined components are manufactured using solid steel, brass, or 303 stainless steel bar stock
- Stainless steel balls, retaining rings, and springs maximize corrosion resistance and extend service life
- Steel componentry is plated using ROHS-compliant trivalent chrome
- Automatic couplers constructed of brass with steel tubular valve as standard (3/8" to 3/4" couplers have steel prong valves)
- 1/4" manual couplers constructed of brass with steel sleeve and steel tubular valve as standard
- 3/8" and 1/2" manual couplers constructed of steel as standard with steel tubular valve

Seal Components

- Nitrile (Buna-N) seals are standard, providing a temperature range of -40°F to 250°F (-40°C to 121°C)

Rated Pressure Charts

Body Size	D-Series Automatic Industrial Interchange (Connected)															
	Brass Coupler/Steel Plug				Brass Coupler/Plug				Steel Coupler/Plug				303 Stainless Coupler/Plug			
	Max. Working		Burst		Max. Working		Burst		Max. Working		Burst		Max. Working		Burst	
	PSI	Bar	PSI	Bar	PSI	Bar	PSI	Bar	PSI	Bar	PSI	Bar	PSI	Bar	PSI	Bar
1/4"	500	35	16,000	1,100	300	20	16,000	1,100	-	-	-	-	500	35	26,000	1,795
3/8"	500	35	15,500	1,070	300	20	14,500	1,000	-	-	-	-	500	35	25,500	1,760
1/2"	500	35	14,000	965	300	20	10,500	725	-	-	-	-	500	35	20,500	1,415
3/4"	500	35	10,000	670	-	-	-	-	-	-	-	-	-	-	-	-

Body Size	F-Series Manual Industrial Interchange (Connected)															
	Brass Coupler/Steel Plug				Brass Coupler/Plug				Steel Coupler/Plug				303 Stainless Coupler/Plug			
	Max. Working		Burst		Max. Working		Burst		Max. Working		Burst		Max. Working		Burst	
	PSI	Bar	PSI	Bar	PSI	Bar	PSI	Bar	PSI	Bar	PSI	Bar	PSI	Bar	PSI	Bar
1/4"	500	35	9,000	620	300	20	8,500	586	500	35	6,500	448	500	35	11,500	795
3/8"	500	35	11,500	790	300	20	10,000	690	500	35	19,500	1,345	500	35	20,500	1,415
1/2"	-	-	-	-	-	-	-	-	500	35	15,500	1,070	500	35	15,000	1,035

Technical Specifications

Body Size	Interchange Standards				Functional Parameters				
	U.S. Military	U.S. Government	International Standards	ANSI/NFPA Standards	Locking Ball Quantity	Air Inclusion	Fluid Loss	Vacuum Rating	Flow ΔP=15 PSI
1/4"	MIL-C-4109F	A-A-59439	ISO6150B	T3.20.14-1990	6	N/A	N/A	N/R	27 CFM
3/8"	-	-	ISO6150B	T3.20.14-1990	6	N/A	N/A	N/R	45 CFM
1/2"	MIL-C-4109F	A-A-59439	ISO6150B	T3.20.14-1990	6	N/A	N/A	N/R	91 CFM
3/4"	-	-	-	T3.20.14-1990	9	N/A	N/A	N/R	200 CFM

Available Options

Body Size	Seal Options		Valve Options			Sleeve Options				Treatments
	FKM	EPDM	Unvalved	Brass	303 SS	Flanged	Sleeve-Lock	Brass	303 SS	Oxy-Clean
	Pre	Pre	Suf	Suf	Suf	Suf	Suf	Suf	Suf	Suf
1/4"	F-	P-	-E	-BV	-SV	N/A	-LS	-BS	-XS	-C1
3/8"	F-	N/A	-E	-BV	-SV	N/A	-LS	N/A	-XS	-C1
1/2"	F-	N/A	-E	-BV	-SV	N/A	-LS	N/A	-XS	-C1
3/4"	N/A-	N/A	-E	N/A	N/A	N/A	-LS	-BS	N/A	-C1

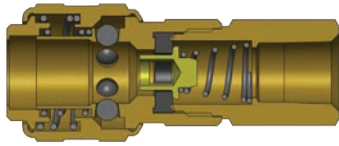

Body Size	D-Series Automatic Industrial Interchange Coupler (Female Threads)							
	Part Detail			Length		Maximum OD		Hex Inch
	Part #	Threads	Material	inch	mm	inch	mm	
1/4"	2DF1-B	1/8" - 27 NPTF	brass	2.19	55.6	0.99	25.1	11/16"
	2DF2-B	1/4" - 18 NPTF	brass	2.38	60.5	0.99	25.1	11/16"
	2DF2-S	1/4" - 18 NPTF	303 stainless	2.38	60.5	0.99	25.1	11/16"
	2DBF2-B	1/4" - 19 BSPP	brass	2.38	60.5	0.99	25.1	11/16"
	2DF3-B	3/8" - 18 NPTF	brass	2.38	60.5	0.99	25.1	11/16"
	2DF3-S	3/8" - 18 NPTF	303 stainless	2.38	60.5	0.99	25.1	13/16"
3/8"	2DBF3-B	3/8" - 19 BSPP	brass	2.38	60.5	0.99	25.1	13/16"
	3DF2-B	1/4" - 18 NPTF	brass	2.50	63.5	1.26	32.0	7/8"
	3DF3-B	3/8" - 18 NPTF	brass	2.60	66.0	1.26	32.0	7/8"
	3DF3-S	3/8" - 18 NPTF	303 stainless	2.60	66.0	1.26	32.0	7/8"
	3DBF3-B	3/8" - 19 BSPP	brass	2.60	66.0	1.26	32.0	7/8"
1/2"	3DF4-B	1/2" - 14 NPTF	brass	2.80	71.1	1.26	32.0	1"
	4DF3-B	3/8" - 18 NPTF	brass	3.10	78.7	1.38	35.1	1-1/16"
	4DF4-B	1/2" - 14 NPTF	brass	3.30	83.8	1.38	35.1	1-1/16"
	4DF4-S	1/2" - 14 NPTF	303 stainless	3.30	83.8	1.38	35.1	1-1/16"
	4DBF4-B	1/2" - 14 BSPP	brass	3.30	83.8	1.38	35.1	1-1/16"
	4DF6-B	3/4" - 14 NPTF	brass	3.40	86.4	1.38	35.1	1-3/16"
3/4"	6DF4-B	1/2" - 14 NPTF	brass	2.95	74.9	1.73	43.9	1-5/16"
	6DF6-B	3/4" - 14 NPTF	brass	2.99	75.9	1.73	43.9	1-5/16"
	6DF8-B	1" - 11-1/2 NPTF	brass	3.18	80.8	1.73	43.9	1-1/2"

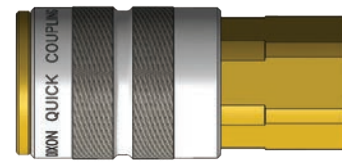
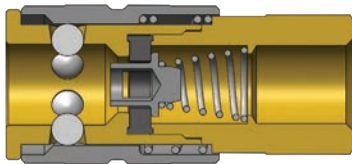

Body Size	F-Series Manual Industrial Interchange Coupler (Female Threads)							
	Part Detail			Length		Maximum OD		Hex Inch
	Part #	Threads	Material	Inch	mm	Inch	mm	
1/4"	2FF1-B	1/8" - 27 NPTF	brass	1.91	48.6	0.93	23.5	3/4"
	2FBF1-B	1/8" - 28 BSPP	brass	1.91	48.6	0.93	23.5	3/4"
	2FF2	1/4" - 18 NPTF	steel	2.07	52.6	0.93	23.5	3/4"
	2FF2-B	1/4" - 18 NPTF	brass	2.07	52.6	0.93	23.5	3/4"
	2FF2-S	1/4" - 18 NPTF	303 stainless	2.07	52.6	0.93	23.5	3/4"
	2FBF2-B	1/4" - 19 BSPP	brass	2.07	52.6	0.93	23.5	3/4"
	2FF3-B	3/8" - 18 NPTF	brass	2.10	53.4	0.93	23.5	13/16"
	2FF3-S	3/8" - 18 NPTF	303 stainless	2.10	53.4	0.93	23.5	13/16"
3/8"	2FBF3-B	3/8" - 19 BSPP	brass	2.13	54.2	0.93	23.5	13/16"
	3FF2	1/4" - 18 NPTF	steel	2.41	61.2	1.13	28.6	7/8"
	3FF3	3/8" - 18 NPTF	steel	2.41	61.2	1.13	28.6	7/8"
	3FF3-S	3/8" - 18 NPTF	303 stainless	2.41	61.2	1.13	28.6	7/8"
	3FBF3	3/8" - 19 BSPP	steel	2.42	61.5	1.13	28.6	7/8"
1/2"	3FF4	1/2" - 14 NPTF	steel	2.63	66.9	1.13	28.6	1"
	4FF3	3/8" - 18 NPTF	steel	2.85	72.5	1.24	31.4	1"
	4FF4	1/2" - 14 NPTF	steel	3.06	77.8	1.24	31.4	1"
	4FF4-S	1/2" - 14 NPTF	303 stainless	3.06	77.8	1.24	31.4	1"
	4FBF4	1/2" - 14 BSPP	steel	3.09	78.4	1.24	31.4	1"
	4FF6	3/4" - 14 NPTF	steel	3.15	79.9	1.24	31.4	1-3/16"

Pneumatic Couplings: DF-Series

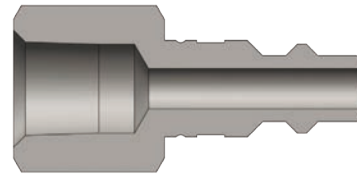

Body Size	DF-Series Industrial Interchange Plug (Female Threads)							
	Part Detail			Length		Maximum OD		Hex Inch
	Part #	Threads	Material	inch	mm	inch	mm	
1/4"	D2F1	1/8" - 27 NPTF	steel	1.44	36.6	0.65	16.5	9/16"
	D2F2	1/4" - 18 NPTF	steel	1.66	42.2	0.79	20.1	11/16"
	D2F2-B	1/4" - 18 NPTF	brass	1.66	42.2	0.79	20.1	11/16"
	D2F2-S	1/4" - 18 NPTF	303 stainless	1.66	42.2	0.79	20.1	11/16"
	D2BF2	1/4" - 19 BSPP	steel	1.66	42.2	0.79	20.1	11/16"
	D2F3	3/8" - 18 NPTF	steel	1.66	42.2	1.01	25.7	7/8"
	D2F3-B	3/8" - 18 NPTF	brass	1.66	42.2	1.01	25.7	7/8"
	D2F3-S	3/8" - 18 NPTF	303 stainless	1.66	42.2	1.01	25.7	7/8"
3/8"	D3F2	1/4" - 18 NPTF	steel	1.78	45.2	0.79	20.1	11/16"
	D3F3	3/8" - 18 NPTF	steel	1.78	45.2	1.01	25.7	7/8"
	D3F3-B	3/8" - 18 NPTF	brass	1.78	45.2	1.01	25.7	7/8"
	D3F3-S	3/8" - 18 NPTF	303 stainless	1.78	45.2	1.01	25.7	7/8"
	D3BF3	3/8" - 19 BSPP	steel	1.78	45.2	1.01	25.7	7/8"
	D3F4	1/2" - 14 NPTF	steel	1.94	49.3	1.16	29.5	1"
1/2"	D4F3	3/8" - 18 NPTF	steel	2.10	53.3	1.01	25.7	7/8"
	D4F4	1/2" - 14 NPTF	steel	2.27	57.7	1.16	29.5	1"
	D4F4-B	1/2" - 14 NPTF	brass	2.27	57.7	1.16	29.5	1"
	D4F4-S	1/2" - 14 NPTF	303 stainless	2.27	57.7	1.16	29.5	1"
	D4BF4	1/2" - 14 BSPP	steel	2.27	57.7	1.16	29.5	1"
	D4F6	3/4" - 14 NPTF	steel	2.30	58.4	1.37	34.8	1-3/16"
3/4"	D6F4	1/2" - 14 NPTF	steel	2.22	56.4	1.52	38.6	1-5/16"
	D6F6	3/4" - 14 NPTF	steel	2.22	56.4	1.52	38.6	1-5/16"
	D6F8	1" - 11-1/2 NPTF	steel	2.41	61.2	1.80	45.7	1-9/16"

DF Series Pneumatic Profile

Body Size	A	B
1/4"	0.32	0.21
3/8"	0.43	0.30
1/2"	0.56	0.38
3/4"	0.80	0.28

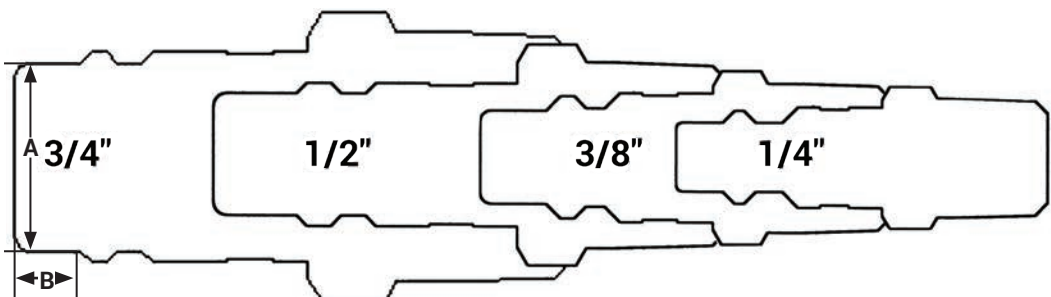

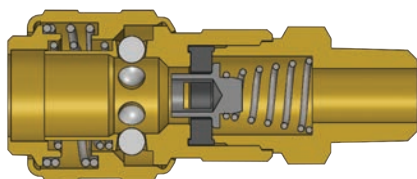

Body Size	D-Series Automatic Industrial Interchange Coupler (Male Threads)							
	Part Detail			Length		Maximum OD		Hex Inch
	Part #	Threads	Material	inch	mm	inch	mm	
1/4"	2DM1-B	1/8" - 27 NPTF	brass	2.21	56.1	0.98	24.9	11/16"
	2DM2-B	1/4" - 18 NPTF	brass	2.34	59.4	0.98	24.9	11/16"
	2DM2-S	1/4" - 18 NPTF	303 stainless	2.34	59.4	0.98	24.9	11/16"
	2DBM2-B	1/4" - 19 BSPT	brass	2.34	59.4	0.98	24.9	11/16"
	2DM3-B	3/8" - 18 NPTF	brass	2.36	59.9	0.98	24.9	11/16"
	2DM3-S	3/8" - 18 NPTF	303 stainless	2.36	59.9	0.98	24.9	11/16"
	2DBM3-B	3/8" - 19 BSPT	brass	2.36	59.9	0.98	24.9	11/16"
3/8"	3DM2-B	1/4" - 18 NPTF	brass	2.59	65.8	1.18	30.0	7/8"
	3DM3-B	3/8" - 18 NPTF	brass	2.73	69.3	1.18	30.0	7/8"
	3DM3-S	3/8" - 18 NPTF	303 stainless	2.73	69.3	1.18	30.0	7/8"
	3DBM3-B	3/8" - 19 BSPT	brass	2.73	69.3	1.18	30.0	7/8"
	3DM4-B	1/2" - 14 NPTF	brass	2.94	74.7	1.18	30.0	7/8"
1/2"	4DM3-B	3/8" - 18 NPTF	brass	3.13	79.5	1.34	34.0	1-1/16"
	4DM4-B	1/2" - 14 NPTF	brass	3.17	80.5	1.34	34.0	1-1/16"
	4DM4-S	1/2" - 14 NPTF	303 stainless	3.17	80.5	1.34	34.0	1-1/16"
	4DBM4-B	1/2" - 14 BSPT	brass	3.17	80.5	1.34	34.0	1-1/16"
	4DM6-B	3/4" - 14 NPTF	brass	3.23	82.0	1.34	34.0	1-1/16"
3/4"	6DM4-B	1/2" - 14 NPTF	brass	2.95	74.9	1.90	48.3	1-3/16"
	6DM6-B	3/4" - 14 NPTF	brass	2.95	74.9	1.90	48.3	1-5/16"
	6DM8-B	1" - 11-1/2 NPTF	brass	3.12	79.2	1.90	48.3	1-9/16"

! It is important to be safe when installing quick disconnect couplings into a pneumatic circuit. Never install a pneumatic coupling directly into an air tool. Use a piece of hose that is at least 18" long between the tool and the coupling to prevent damage to the coupling. To protect the operator, safety devices such as a safety check valve and safety cable should be installed in case there is a hose or coupling failure.

Pneumatic Couplings: DF-Series

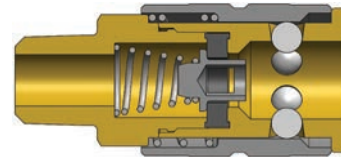
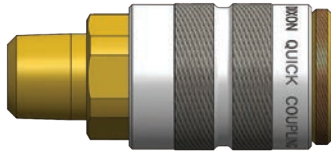

Body Size	F-Series Manual Industrial Interchange Coupler (Male Threads)							
	Part Detail			Length		Maximum OD		Hex Inch
	Part #	Threads	Material	inch	mm	inch	mm	
1/4"	2FM1-B	1/8" - 27 NPTF	brass	1.97	50.0	0.88	22.4	3/4"
	2FM1-S	1/8" - 27 NPTF	303 stainless	1.97	50.0	0.88	22.4	3/4"
	2FBM1-B	1/8" - 28 BSPT	brass	1.97	50.0	0.88	22.4	3/4"
	2FM2	1/4" - 18 NPTF	steel	2.04	51.8	0.88	22.4	3/4"
	2FM2-B	1/4" - 18 NPTF	brass	2.04	51.8	0.88	22.4	3/4"
	2FM2-S	1/4" - 18 NPTF	303 stainless	2.04	51.8	0.88	22.4	3/4"
	2FBM2-B	1/4" - 19 BSPT	brass	2.04	51.8	0.88	22.4	3/4"
	2FM3-B	3/8" - 18 NPTF	brass	2.08	52.8	0.88	22.4	3/4"
	2FM3-S	3/8" - 18 NPTF	303 stainless	2.08	52.8	0.88	22.4	3/4"
	2FBM3-B	3/8" - 19 BSPT	brass	2.08	52.8	0.88	22.4	3/4"
3/8"	3FM2	1/4" - 18 NPTF	steel	2.45	62.2	1.06	26.9	7/8"
	3FM3	3/8" - 18 NPTF	steel	2.46	62.5	1.06	26.9	7/8"
	3FM3-S	3/8" - 18 NPTF	303 stainless	2.46	62.5	1.06	26.9	7/8"
	3FBM3	3/8" - 19 BSPT	steel	2.46	62.5	1.06	26.9	7/8"
	3FM4	1/2" - 14 NPTF	steel	2.55	64.8	1.06	26.9	7/8"
1/2"	4FM3	3/8" - 18 NPTF	steel	2.97	75.4	1.19	30.2	1"
	4FM4	1/2" - 14 NPTF	steel	3.07	78.0	1.19	30.2	1"
	4FM4-S	1/2" - 14 NPTF	303 stainless	3.07	78.0	1.19	30.2	1"
	4FBM4	1/2" - 14 BSPT	steel	3.07	78.0	1.19	30.2	1"
	4FM6	3/4" - 14 NPTF	steel	3.12	79.2	1.19	30.2	1-1/16"

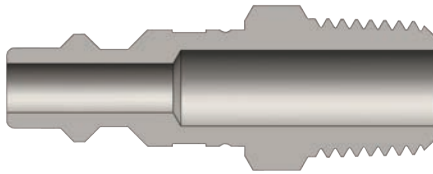

Body Size	DF-Series Industrial Interchange Plug (Male Threads)							
	Part Detail			Length		Maximum OD		Hex Inch
	Part #	Threads	Material	inch	mm	inch	mm	
1/4"	D2M1	1/8" - 27 NPTF	steel	1.57	39.9	0.58	14.7	1/2"
	D2M1-B	1/8" - 27 NPTF	brass	1.57	39.9	0.58	14.7	1/2"
	D2M1-S	1/8" - 27 NPTF	303 stainless	1.57	39.9	0.58	14.7	1/2"
	D2M2	1/4" - 18 NPTF	steel	1.69	42.9	0.65	16.5	9/16"
	D2M2-B	1/4" - 18 NPTF	brass	1.69	42.9	0.65	16.5	9/16"
	D2M2-S	1/4" - 18 NPTF	303 stainless	1.69	42.9	0.65	16.5	9/16"
	D2BM2	1/4" - 19 BSPT	steel	1.69	42.9	0.65	16.5	9/16"
	D2M3	3/8" - 18 NPTF	steel	1.75	44.5	0.87	22.1	3/4"
	D2M3-B	3/8" - 18 NPTF	brass	1.75	44.5	0.87	22.1	3/4"
	D2M3-S	3/8" - 18 NPTF	303 stainless	1.75	44.5	0.87	22.1	3/4"
3/8"	D3M2	1/4" - 18 NPTF	steel	1.81	46.0	0.79	20.1	11/16"
	D3M3	3/8" - 18 NPTF	steel	1.87	47.5	0.87	22.1	3/4"
	D3M3-B	3/8" - 18 NPTF	brass	1.87	47.5	0.87	22.1	3/4"
	D3M3-S	3/8" - 18 NPTF	303 stainless	1.87	47.5	0.87	22.1	3/4"
	D3BM3	3/8" - 19 BSPT	steel	1.87	47.5	0.87	22.1	11/16"
	D3M4	1/2" - 14 NPTF	steel	2.03	51.6	1.01	25.7	7/8"
1/2"	D4M2	1/4" - 18 NPTF	steel	2.13	54.1	0.75	19.1	11/16"
	D4M3	3/8" - 18 NPTF	steel	2.19	55.6	0.87	22.1	3/4"
	D4M4	1/2" - 14 NPTF	steel	2.34	59.4	1.01	25.7	7/8"
	D4M4-B	1/2" - 14 NPTF	brass	2.34	59.4	1.01	25.7	7/8"
	D4M4-S	1/2" - 14 NPTF	303 stainless	2.34	59.4	1.01	25.7	7/8"
	D4BM4	1/2" - 14 BSPT	steel	2.34	59.4	1.01	25.7	7/8"
	D4M6	3/4" - 14 NPTF	steel	2.50	63.5	1.23	31.2	1-1/16"
3/4"	D6M4	1/2" - 14 NPTF	steel	2.38	60.5	1.52	38.6	1-5/16"
	D6M6	3/4" - 14 NPTF	steel	2.38	60.5	1.52	38.6	1-5/16"
	D6M8	1" - 11-1/2 NPTF	steel	2.56	65.0	1.80	45.7	1-9/16"

Pneumatic Couplings: DF-Series

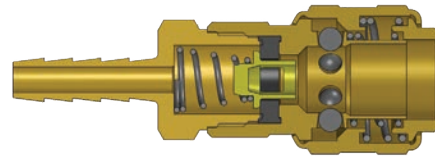

Body Size	D-Series Automatic Industrial Interchange Coupler (Standard Hose Barb)							
	Part Detail			Length		Maximum OD		Hex Inch
	Part #	Hose ID	Material	inch	mm	inch	mm	
1/4"	2DS2-B	1/4"	brass	2.90	73.7	0.98	24.9	11/16"
	2DS2-S	1/4"	303 stainless	2.90	73.7	0.98	24.9	11/16"
	2DS3-B	3/8"	brass	2.90	73.7	0.98	24.9	11/16"
	2DS3-S	3/8"	303 stainless	2.90	73.7	0.98	24.9	11/16"
3/8"	3DS2-B	1/4"	brass	3.00	76.2	1.18	30.0	7/8"
	3DS3-B	3/8"	brass	3.00	76.2	1.18	30.0	7/8"
	3DS3-S	3/8"	303 stainless	3.00	76.2	1.18	30.0	7/8"
	3DS4-B	1/2"	brass	3.00	76.2	1.18	30.0	7/8"
1/2"	4DS3-B	3/8"	brass	3.51	89.2	1.34	34.0	1-1/16"
	4DS4-B	1/2"	brass	3.51	89.2	1.34	34.0	1-1/16"
	4DS4-S	1/2"	303 stainless	3.51	89.2	1.34	34.0	1-1/16"
	4DS6-B	3/4"	brass	3.51	89.2	1.34	34.0	1-1/16"
3/4"	6DS4-B	1/2"	brass	3.00	76.2	1.73	43.9	1-5/16"
	6DS6-B	3/4"	brass	3.00	76.2	1.73	43.9	1-5/16"
	6DS8-B	1"	brass	3.24	82.3	1.73	43.9	1-5/16"

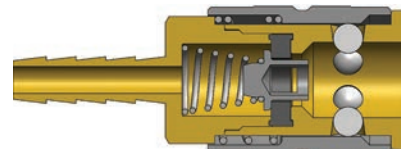
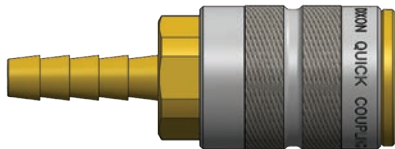

Body Size	F-Series Manual Industrial Interchange Coupler (Standard Hose Barb)							
	Part Detail			Length		Maximum OD		Hex Inch
	Part #	Hose ID	Material	inch	mm	inch	mm	
1/4"	2FS2	1/4"	steel	2.53	64.3	0.88	22.4	3/4"
	2FS2-B	1/4"	brass	2.53	64.3	0.88	22.4	3/4"
	2FS2-S	1/4"	303 stainless	2.53	64.3	0.88	22.4	3/4"
	2FS2.5-B	5/16"	brass	2.53	64.3	0.88	22.4	3/4"
	2FS3-B	3/8"	brass	2.53	64.3	0.88	22.4	3/4"
	2FS3-S	3/8"	303 stainless	2.53	64.3	0.88	22.4	3/4"
3/8"	3FS2	1/4"	steel	2.86	72.6	1.06	26.9	7/8"
	3FS3	3/8"	steel	2.86	72.6	1.06	26.9	7/8"
	3FS3-S	3/8"	303 stainless	2.86	72.6	1.06	26.9	7/8"
	3FS4	1/2"	steel	2.86	72.6	1.06	26.9	7/8"
1/2"	4FS3	3/8"	steel	3.49	88.6	1.19	30.2	1"
	4FS4	1/2"	steel	3.49	88.6	1.19	30.2	1"
	4FS4-S	1/2"	303 stainless	3.49	88.6	1.19	30.2	1"
	4FS6	3/4"	steel	3.49	88.6	1.19	30.2	1"

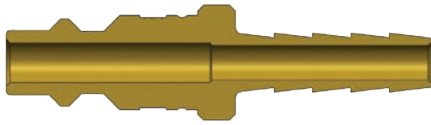

Body Size	DF-Series Industrial Interchange Plug (Standard Hose Barb)							
	Part Detail			Length		Maximum OD		Hex Inch
	Part #	Hose ID	Material	inch	mm	inch	mm	
1/4"	D2S2	1/4"	steel	2.09	53.1	0.56	14.2	-
	D2S2-B	1/4"	brass	2.09	53.1	0.56	14.2	-
	D2S2-S	1/4"	303 stainless	2.09	53.1	0.56	14.2	-
	D2S2.5	5/16"	steel	2.09	53.1	0.56	14.2	-
	D2S3	3/8"	steel	2.09	53.1	0.56	14.2	-
	D2S3-B	3/8"	brass	2.09	53.1	0.56	14.2	-
	D2S3-S	3/8"	303 stainless	2.09	53.1	0.56	14.2	-
3/8"	D3S2	1/4"	steel	2.21	56.1	0.75	19.1	-
	D3S3	3/8"	steel	2.21	56.1	0.75	19.1	-
	D3S3-B	3/8"	brass	2.21	56.1	0.75	19.1	-
	D3S3-S	3/8"	303 stainless	2.21	56.1	0.75	19.1	-
	D3S4	1/2"	steel	2.21	56.1	0.75	19.1	-
1/2"	D4S3	3/8"	steel	2.53	64.3	0.75	19.1	-
	D4S3-B	3/8"	brass	2.53	64.3	0.75	19.1	-
	D4S4	1/2"	steel	2.53	64.3	0.75	19.1	-
	D4S4-B	1/2"	brass	2.53	64.3	0.75	19.1	-
	D4S4-S	1/2"	303 stainless	2.53	64.3	0.75	19.1	-
	D4S6	3/4"	steel	2.53	64.3	0.94	23.9	-
	D4S6-B	3/4"	brass	2.53	64.3	0.94	23.9	-
3/4"	D6S4	1/2"	steel	3.49	88.7	1.52	38.6	-
	D6S6	3/4"	steel	3.49	88.7	1.52	38.6	-
	D6S8	1"	steel	3.49	88.7	1.52	38.6	-

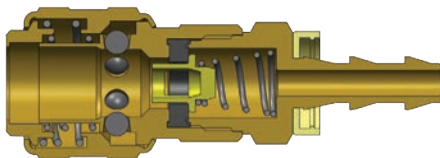

Body Size	D-Series Automatic Industrial Interchange Coupler (Push-Loc Barb)							
	Part Detail			Length		Maximum OD		Hex Inch
	Part #	Hose ID	Material	inch	mm	inch	mm	
1/4"	2DB2-B	1/4"	brass	2.76	70.1	0.98	24.9	11/16"
	2DB3-B	3/8"	brass	2.77	70.4	0.98	24.9	11/16"
3/8"	3DB3-B	3/8"	brass	2.82	71.7	1.18	30.0	7/8"
1/2"	4DB4-B	1/2"	brass	3.31	84.1	1.34	34.0	1-1/16"

Pneumatic Couplings: DF-Series

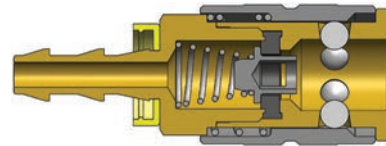
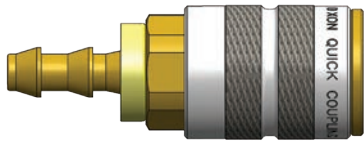

Body Size	F-Series Manual Industrial Interchange Coupler (Push-Loc Barb)							
	Part Detail			Length		Maximum OD		Hex Inch
	Part #	Hose ID	Material	inch	mm	inch	mm	
1/4"	2FB2-B	1/4"	brass	2.49	63.2	0.88	22.4	3/4"
	2FB3-B	3/8"	brass	2.49	63.2	0.88	22.4	3/4"
3/8"	3FB2	1/4"	steel	2.80	71.1	1.06	26.9	7/8"
	3FB3	3/8"	steel	2.80	71.1	1.06	26.9	7/8"
	3FB4	1/2"	steel	2.80	71.1	1.06	26.9	7/8"
1/2"	4FB3	3/8"	steel	3.40	86.4	1.19	30.2	1"
	4FB4	1/2"	steel	3.40	86.4	1.19	30.2	1"

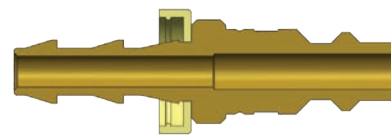

Body Size	DF-Series Industrial Interchange Plug (Push-Loc Barb)							
	Part Detail			Length		Maximum OD		Hex Inch
	Part #	Hose ID	Material	inch	mm	inch	mm	
1/4"	D2B2	1/4"	steel	2.09	53.1	0.69	17.5	-
	D2B2-B	1/4"	brass	2.09	53.1	0.69	17.5	-
	D2B3	3/8"	steel	2.09	53.1	0.86	21.8	-
3/8"	D3B2	1/4"	steel	2.21	56.1	0.75	19.1	-
	D3B3	3/8"	steel	2.21	56.1	0.75	19.1	-
	D3B4	1/2"	steel	2.35	59.7	0.75	19.1	-
1/2"	D4B4	1/2"	steel	2.67	67.8	0.75	19.1	-
3/4"	D6B6	3/4"	steel	2.99	75.9	1.00	25.4	-

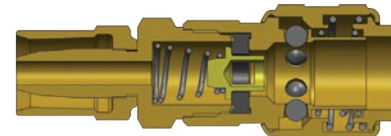

Body Size	D-Series Automatic Industrial Interchange Coupler (Reusable Barb)							
	Part Detail			Length		Maximum OD		Hex Inch
	Part #	Hose ID x OD	Material	inch	mm	inch	mm	
1/4"	2DE2-B	1/4" x 1/2"	brass	2.69	68.3	0.98	24.9	11/16"
	2DH2-B	1/4" x 5/8"	brass	2.79	70.9	0.98	24.9	11/16"
	2DK3-B	3/8" x 11/16"	brass	2.79	70.9	0.98	24.9	11/16"
	2DL3-B	3/8" x 3/4"	brass	2.85	72.4	0.98	24.9	11/16"

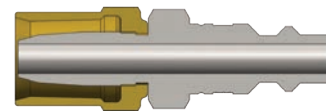
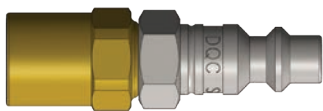

Body Size	DF-Series Industrial Interchange Plug (Reusable Barb)							
	Part Detail			Length		Maximum OD		Hex Inch
	Part #	Hose ID x OD	Material	inch	mm	inch	mm	
1/4"	D2E2	1/4" x 1/2"	steel	2.07	52.6	0.69	17.5	9/16"
	D2H2	1/4" x 5/8"	steel	2.16	54.9	0.81	20.6	9/16"
	D2K3	3/8" x 11/16"	steel	2.16	54.9	0.81	20.6	9/16"
	D2L3	3/8" x 3/4"	steel	2.18	55.4	0.95	24.1	9/16"

Automatic Coupler Operation

The D-Series automatic coupling has been performing reliably and safely for more than 50 years. This amazing coupler is an inexpensive solution for automatically connecting pressurized air lines.

How To Disconnect

Push sleeve toward plug tip.
Do not pull sleeve back.

Push sleeve toward plug.

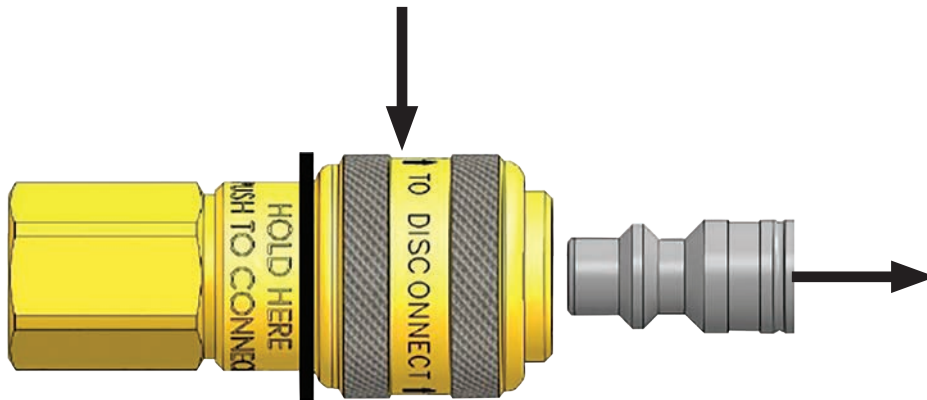

How To Connect

Firmly push plug into socket until you hear a click.
Sleeve does not need to be pulled back.

Hold here.
Do not hold forward of black line.

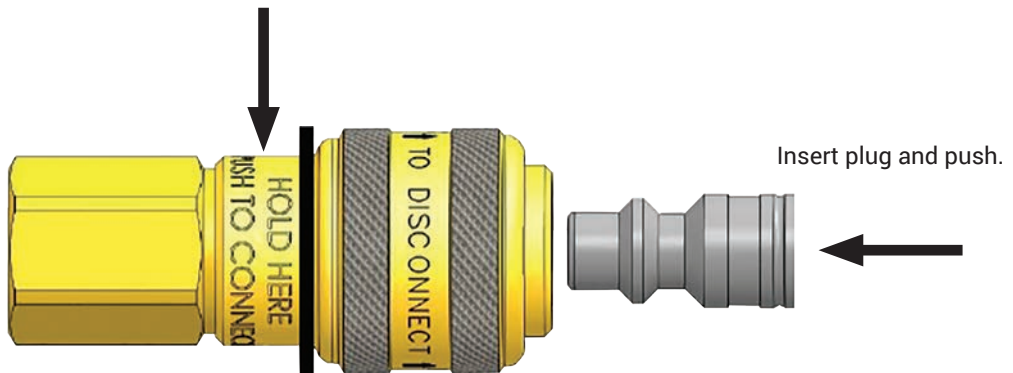

Pneumatic Couplings: J-Series

Interchange Data

- Tru-Flate automotive interchange style
- Parker 10-Series
- Rectus 55KM and Parker 10-Series
- Amflo T-Series

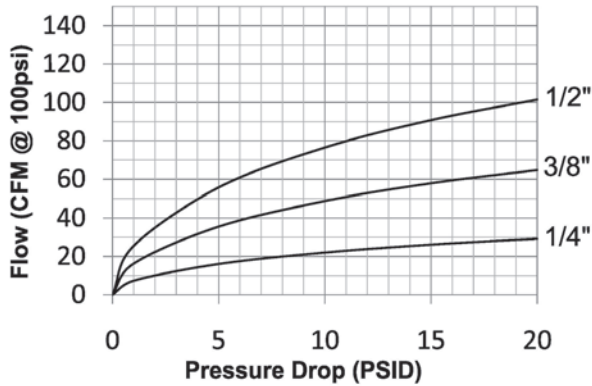

Rated Pressure Chart

Materials

- Machined components are manufactured using solid steel or brass bar stock
- Stainless steel balls, retaining rings, and springs maximize corrosion resistance and extend service life
- Steel componentry is plated using ROHS-compliant trivalent chrome
- 1/4" couplers constructed of brass with steel sleeve and steel tubular valve as standard
- 3/8" and 1/2" couplers constructed of steel as standard with steel tubular valves

Seal Components

- Nitrile (Buna-N) seals are standard, providing a temperature range of -40°F to 250°F (-40°C to 121°C)

Body Size	J-Series Automotive Interchange (Connected)															
	Brass Coupler/Steel Plug				Brass Coupler/Plug				Steel Coupler/Plug				303 Stainless Coupler/Plug			
	Max. Working		Burst		Max. Working		Burst		Max. Working		Burst		Max. Working		Burst	
	PSI	Bar	PSI	Bar	PSI	Bar	PSI	Bar	PSI	Bar	PSI	Bar	PSI	Bar	PSI	Bar
1/4"	500	35	11,500	793	300	20	10,500	724	-	-	-	-	-	-	-	-
3/8"	-	-	-	-	-	-	-	-	500	35	18,000	1,241	-	-	-	-
1/2"	-	-	-	-	-	-	-	-	500	35	10,000	690	-	-	-	-

Technical Specifications

Body Size	Interchange Standards				Functional Parameters				
	U.S. Military	U.S. Government	International Standards	ANSI/NFPA Standards	Locking Ball Quantity	Air Inclusion	Fluid Loss	Vacuum Rating	Flow ΔP = 15 PSI
1/4"	-	-	-	-	6	N/A	N/A	N/R	26 CFM
3/8"	-	-	-	-	6	N/A	N/A	N/R	58 CFM
1/2"	-	-	-	-	6	N/A	N/A	N/A	91 CFM

Available Options

Body Size	Seal Options		Valve Options			Sleeve Options				Treatments
	FKM	EPDM	Unvalved	Brass	303 SS	Flanged	Sleeve-Lock	Brass	303 SS	Oxy-Clean
	Pre	Pre	Suf	Suf	Suf	Suf	Suf	Suf	Suf	Suf
1/4"	F-	P-	-E	-BV	-SV	-FS	-LS	-BS	-XS	-C1
3/8"	F-	N/A	-E	-BV	-SV	N/A	-LS	N/A	-XS	-C1
1/2"	F-	N/A	-E	-BV	-SV	N/A	-LS	N/A	-XS	-C1

! Operating pressure for couplings utilizing hose barb end connections may be dramatically reduced to that of the hose rating and/or hose end connection combination. Consult hose manufacturer's catalog for hose end connection ratings. If in doubt, test under controlled conditions for suitability to application. Dixon Quick Coupling cannot assume liability for misapplication of production resulting in equipment down-time, lost production, and/or personal injury including death.

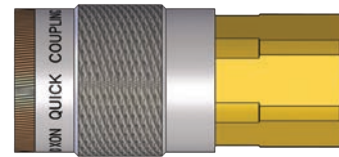
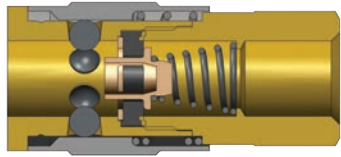

Body Size	J-Series Automotive Interchange Coupler (Female Threads)							
	Part Detail			Length		Maximum OD		Hex Inch
	Part #	Threads	Material	inch	mm	inch	mm	
1/4"	2JF1-B	1/8" - 27 NPTF	brass	1.83	46.5	0.88	22.4	3/4"
	2JF2-B	1/4" - 18 NPTF	brass	2.04	51.8	0.88	22.4	3/4"
	2JF3-B	3/8" - 18 NPTF	brass	2.14	54.4	0.88	22.4	13/16"
3/8"	3JF2	1/4" - 18 NPTF	steel	2.25	57.2	1.06	26.9	7/8"
	3JF3	3/8" - 18 NPTF	steel	2.48	63.0	1.06	26.9	7/8"
	3JF4	1/2" - 14 NPTF	steel	2.61	66.3	1.06	26.9	1"
1/2"	4FF3	3/8" - 18 NPTF	steel	2.85	72.5	1.24	31.4	1"
	4FF4	1/2" - 14 NPTF	steel	3.06	77.8	1.24	31.4	1"
	4FF6	3/4" - 14 NPTF	steel	3.15	79.9	1.24	31.4	1-3/16"

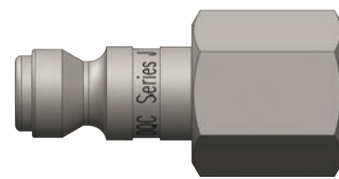
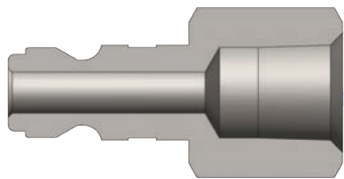

Body Size	J-Series Automotive Interchange Plug (Female Threads)							
	Part Detail			Length		Maximum OD		Hex Inch
	Part #	Threads	Material	inch	mm	inch	mm	
1/4"	J2F1	1/8" - 27 NPTF	steel	1.34	34.0	0.65	16.5	9/16"
	J2F2	1/4" - 18 NPTF	steel	1.56	39.6	0.79	20.1	11/16"
	J2F2-B	1/4" - 18 NPTF	brass	1.56	39.6	0.79	20.1	11/16"
	J2F3	3/8" - 18 NPTF	steel	1.56	39.6	1.01	25.7	7/8"
3/8"	J3F2	1/4" - 18 NPTF	steel	1.75	44.5	0.79	20.1	11/16"
	J3F3	3/8" - 18 NPTF	steel	1.75	44.5	1.01	25.7	7/8"
	J3F4	1/2" - 14 NPTF	steel	1.91	48.5	1.16	29.5	1"
1/2"	J4F3	3/8" - 18 NPTF	steel	2.11	53.6	1.01	25.7	7/8"
	J4F4	1/2" - 14 NPTF	steel	2.26	57.4	1.16	29.5	1"
	J4F6	3/4" - 14 NPTF	steel	2.31	58.7	1.37	34.8	1-3/16"

Pneumatic Couplings: J-Series

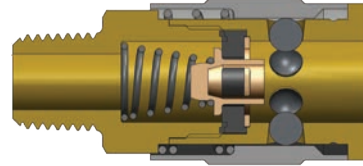
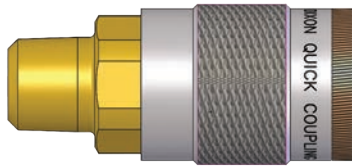

Body Size	J-Series Automotive Interchange Coupler (Male Threads)							
	Part Detail			Length		Maximum OD		Hex Inch
	Part #	Threads	Material	inch	mm	inch	mm	
1/4"	2JM1-B	1/8" - 27 NPTF	brass	1.88	47.8	0.88	22.4	3/4"
	2JM2-B	1/4" - 18 NPTF	brass	2.05	52.0	0.88	22.4	3/4"
	2JM3-B	3/8" - 18 NPTF	brass	2.08	52.8	0.88	22.4	3/4"
3/8"	3JM2	1/4" - 18 NPTF	steel	2.45	62.2	1.06	26.9	7/8"
	3JM3	3/8" - 18 NPTF	steel	2.46	62.5	1.06	26.9	7/8"
	3JM4	1/2" - 14 NPTF	steel	2.55	64.8	1.06	26.9	7/8"
1/2"	4FM3	3/8" - 18 NPTF	steel	2.97	75.4	1.19	30.2	1"
	4FM4	1/2" - 14 NPTF	steel	3.07	78.0	1.19	30.2	1"
	4FM6	3/4" - 14 NPTF	steel	3.12	79.2	1.19	30.2	1-1/16"

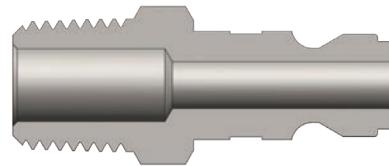

Body Size	J-Series Automotive Interchange Plug (Male Threads)							
	Part Detail			Length		Maximum OD		Hex Inch
	Part #	Threads	Material	inch	mm	inch	mm	
1/4"	J2M1	1/8" - 27 NPTF	steel	1.47	37.3	0.58	14.7	1/2"
	J2M2	1/4" - 18 NPTF	steel	1.59	40.4	0.65	16.5	9/16"
	J2M2-B	1/4" - 18 NPTF	brass	1.59	40.4	0.65	16.5	9/16"
	J2M3	3/8" - 18 NPTF	steel	1.65	41.9	0.79	20.1	3/4"
3/8"	J3M2	1/4" - 18 NPTF	steel	1.78	45.2	0.79	20.1	11/16"
	J3M3	3/8" - 18 NPTF	steel	1.84	46.7	0.79	20.1	3/4"
	J3M4	1/2" - 14 NPTF	steel	2.00	50.8	1.01	25.7	7/8"
1/2"	J4M3	3/8" - 18 NPTF	steel	2.20	55.9	0.79	20.1	11/16"
	J4M4	1/2" - 14 NPTF	steel	2.35	59.7	1.01	25.7	7/8"
	J4M6	3/4" - 14 NPTF	steel	2.51	63.8	1.23	31.2	1-1/16"

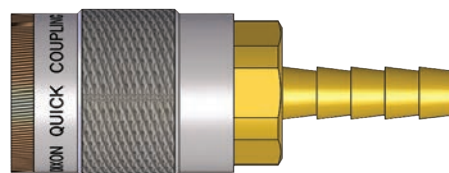
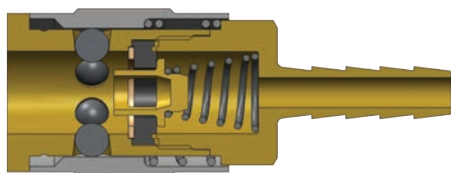

Body Size	J-Series Automotive Interchange Coupler (Standard Hose Barb)							
	Part Detail			Length		Maximum OD		Hex Inch
	Part #	Hose ID	Material	inch	mm	inch	mm	
1/4"	2JS2-B	1/4"	brass	2.53	64.3	0.88	22.4	3/4"
	2JS3-B	3/8"	brass	2.53	64.3	0.88	22.4	3/4"
3/8"	3JS2	1/4"	steel	2.86	72.6	1.06	26.9	7/8"
	3JS3	3/8"	steel	2.86	72.6	1.06	26.9	7/8"
	3JS4	1/2"	steel	2.86	72.6	1.06	26.9	7/8"
1/2"	4FS3	3/8"	steel	3.49	88.6	1.19	30.2	1"
	4FS4	1/2"	steel	3.49	88.6	1.19	30.2	1"
	4FS6	3/4"	steel	3.49	88.6	1.19	30.2	1"

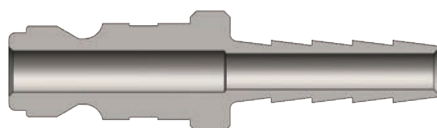

Body Size	J-Series Automotive Interchange Plug (Standard Hose Barb)							
	Part Detail			Length		Maximum OD		Hex Inch
	Part #	Hose ID	Material	inch	mm	inch	mm	
1/4"	J2S2	1/4"	steel	1.99	50.5	0.56	14.2	-
	J2S3	3/8"	steel	1.99	50.5	0.56	14.2	-
3/8"	J3S2	1/4"	steel	2.18	55.4	0.75	19.1	-
	J3S3	3/8"	steel	2.18	55.4	0.75	19.1	-
	J3S4	1/2"	steel	2.18	55.4	0.75	19.1	-
1/2"	J4S3	3/8"	steel	2.54	64.5	0.75	19.1	-
	J4S4	1/2"	steel	2.54	64.5	0.75	19.1	-
	J4S6	3/4"	steel	2.54	64.5	0.94	23.9	-

Pneumatic Couplings: J-Series

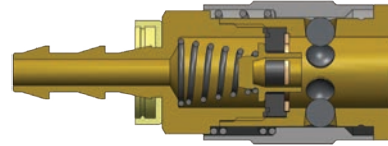
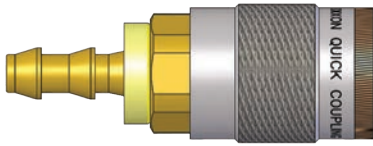

Body Size	J-Series Automotive Interchange Coupler (Push-Loc Barb)							
	Part Detail			Length		Maximum OD		Hex Inch
	Part #	Hose ID	Material	inch	mm	inch	mm	
1/4"	2JB2-B	1/4"	brass	2.37	60.2	0.88	22.4	3/4"
	2JB3-B	3/8"	brass	2.49	63.2	0.88	22.4	3/4"
3/8"	3JB2	1/4"	steel	2.80	71.1	1.06	26.9	7/8"
	3JB3	3/8"	steel	2.80	71.1	1.06	26.9	7/8"
	3JB4	1/2"	steel	2.80	71.1	1.06	26.9	7/8"
1/2"	4FB3	3/8"	steel	3.40	86.4	1.19	30.2	1"
	4FB4	1/2"	steel	3.40	86.4	1.19	30.2	1"

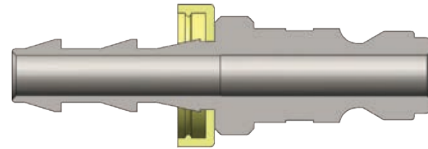
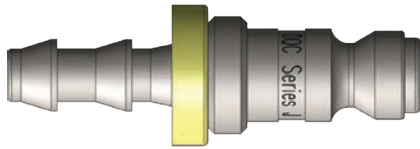

Body Size	J-Series Automotive Interchange Plug (Push-Loc Barb)							
	Part Detail			Length		Maximum OD		Hex Inch
	Part #	Hose ID	Material	inch	mm	inch	mm	
1/4"	J2B2	1/4"	steel	2.09	53.1	0.69	17.5	-
	J2B3	3/8"	steel	2.09	53.1	0.86	21.8	-
3/8"	J3B3	3/8"	steel	2.21	56.1	0.75	19.1	-
1/2"	J4B4	1/2"	steel	2.67	67.8	0.75	19.1	-

J Series Profiles

Body Size	A	B
1/4"	0.42	0.06
3/8"	0.56	0.13
1/2"	0.65	0.13

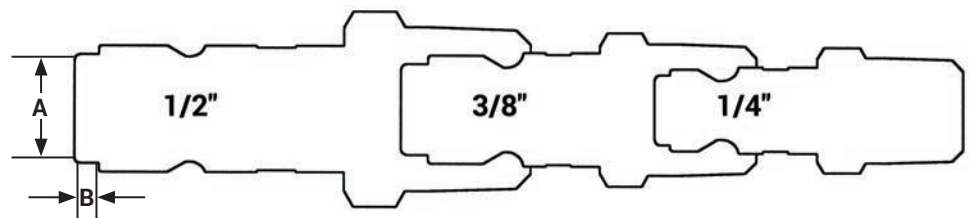

Pneumatic Couplings: M-Series

Interchange Data

- ARO 210 (1/4") and ARO 310 (3/8") interchange
- Automatic couplings interchange with ARO 210/310 and Hansen Series 210/310
- Manual couplings interchange with Parker 50-Series and Amflo type B

Materials

- Machined components are manufactured using solid steel or brass bar stock.
- Stainless steel springs; carbon steel balls, retaining rings, and pins
- Steel componentry is plated using ROHS-compliant trivalent chrome
- Automatic couplers constructed of steel
- Manual couplers constructed of brass

Seal Components

- Nitrile (Buna-N) seals are standard, providing a temperature range of -40°F to 250°F (-40°C to 121°C)

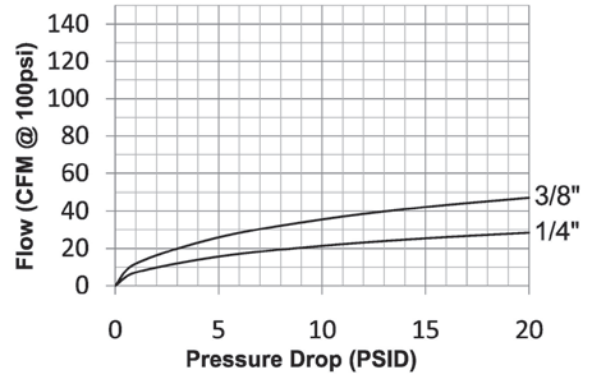

Rated Pressure Chart

Body Size	M-Series ARO Interchange (Connected)															
	Auto Coupler/Steel Plug				Auto Coupler/Brass Plug				Manual Coupler/Steel Plug				Manual Coupler/Brass Plug			
	Max. Working		Burst		Max. Working		Burst		Max. Working		Burst		Max. Working		Burst	
	PSI	Bar	PSI	Bar	PSI	Bar	PSI	Bar	PSI	Bar	PSI	Bar	PSI	Bar	PSI	Bar
1/4"	300	20	2,600	179	300	20	5,000	345	300	20	12,400	855	300	20	12,700	876
3/8"	300	20	3,300	228	-	-	-	-	-	-	-	-	-	-	-	-

Technical Specifications

Body Size	Interchange Standards				Functional Parameters					
	U.S. Military	U.S. Government	International Standards	ANSI/NFPA Standards	Locking Mechanism	Air Inclusion	Fluid Loss	Vacuum Rating	Flow ΔP = 15 PSI	
1/4"	-	-	-	-	Manual - 4 Ball	N/A	N/A	N/R	25 CFM	
	-	-	-	-	Auto - Pins	N/A	N/A	N/R	22 CFM	
3/8"	-	-	-	-	Auto - Pins	N/A	N/A	N/R	42 CFM	

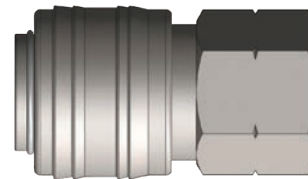
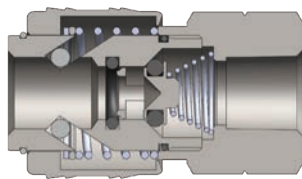

Body Size	M-Series Automatic ARO Interchange Coupler (Female Threads)							
	Part Detail			Length		Maximum OD		Hex Inch
	Part #	Threads	Material	inch	mm	inch	mm	
1/4"	2MF2-PL	1/4" - 18 NPT	steel/brass	1.72	43.6	1.06	27.0	13/16"
	2MF3-PL	3/8" - 18 NPT	steel/brass	1.72	43.6	1.06	27.0	13/16"
3/8"	3MF3-PL	3/8" - 18 NPT	steel/brass	1.93	49.0	1.26	32.0	1-1/16"

Pneumatic Couplings: M-Series

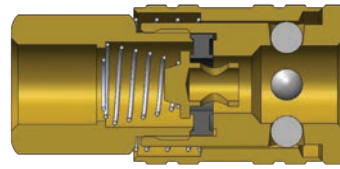
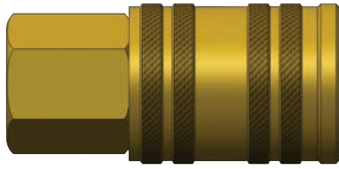

M-Series Manual ARO Interchange Coupler (Female Threads)

Body Size	M-Series Manual ARO Interchange Coupler (Female Threads)							
	Part Detail			Length		Maximum OD		Hex Inch
	Part #	Threads	Material	inch	mm	inch	mm	
1/4"	2MF2-B	1/4" - 18 NPT	brass	1.97	50.0	0.87	22.0	3/4"
	2MF3-B	3/8" - 18 NPT	brass	2.05	52.0	0.87	22.0	13/16"

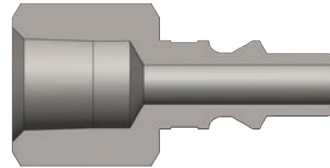

M-Series ARO Interchange Plug (Female Threads)

Body Size	M-Series ARO Interchange Plug (Female Threads)							
	Part Detail			Length		Maximum OD		Hex Inch
	Part #	Threads	Material	inch	mm	inch	mm	
1/4"	M2F2	1/4" - 18 NPTF	steel	1.57	39.9	0.79	20.1	11/16"
	M2F2-B	1/4" - 18 NPTF	brass	1.57	39.9	0.79	20.1	11/16"
	M2F3	3/8" - 18 NPTF	steel	1.57	39.9	1.01	25.7	7/8"
3/8"	M3F3	3/8" - 18 NPTF	steel	1.82	46.2	1.01	25.7	7/8"

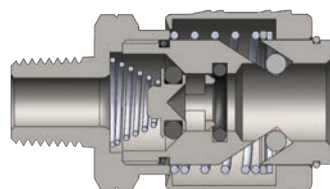
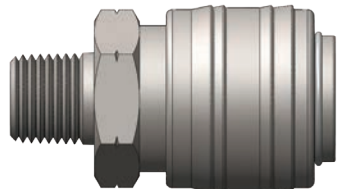

M-Series Automatic ARO Interchange Coupler (Male Threads)

Body Size	M-Series Automatic ARO Interchange Coupler (Male Threads)							
	Part Detail			Length		Maximum OD		
	Part #	Threads	Material	inch	mm	inch	mm	
1/4"	2MM2-PL	1/4" - 18 NPT	steel/brass	1.70	43.2	1.06	27.0	
	2MM3-PL	3/8" - 18 NPT	steel/brass	1.80	45.6	1.06	27.0	
3/8"	3MM3-PL	3/8" - 18 NPT	steel/brass	1.89	48.0	1.26	32.0	
	3MM4-PL	1/2" - 14 NPTF	steel/brass	1.89	48.0	1.26	32.0	

M Series Profiles

Body Size	A	B
1/4"	0.31	0.33
3/8"	0.43	0.59

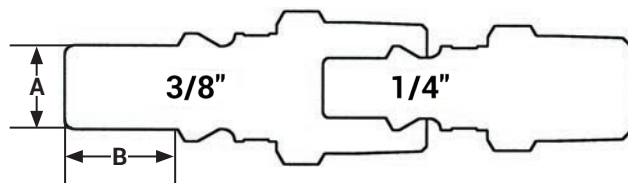

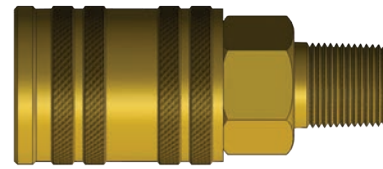
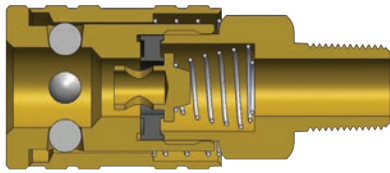

Body Size	M-Series Manual ARO Interchange Coupler (Male Threads)							
	Part Detail			Length		Maximum OD		Hex Inch
	Part #	Threads	Material	inch	mm	inch	mm	
1/4"	2MM2-B	1/4" - 18 NPT	brass	2.13	54.0	0.87	22.0	3/4"
	2MM3-B	3/8" - 18 NPT	brass	2.13	54.0	0.87	22.0	13/16"

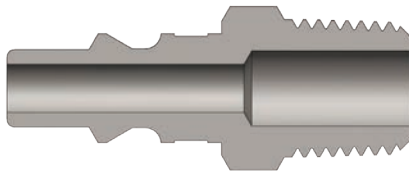

Body Size	M-Series ARO Interchange Plug (Male Threads)							
	Part Detail			Length		Maximum OD		Hex Inch
	Part #	Threads	Material	inch	mm	inch	mm	
1/4"	M2M1	1/8" - 27 NPTF	steel	1.48	37.6	0.58	14.7	1/2"
	M2M2	1/4" - 18 NPTF	steel	1.60	40.6	0.65	16.5	9/16"
	M2M2-B	1/4" - 18 NPTF	brass	1.60	40.6	0.65	16.5	9/16"
	M2M3	3/8" - 18 NPTF	steel	1.80	45.7	0.79	20.1	3/4"
3/8"	M3M3	3/8" - 18 NPTF	steel	1.91	48.5	0.79	20.1	3/4"

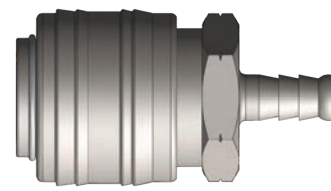
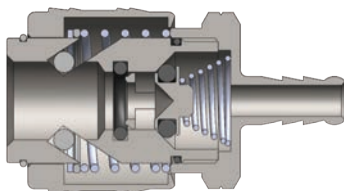

Body Size	M-Series Automatic ARO Interchange Coupler (Standard Hose Barb)							
	Part Detail			Length		Maximum OD		Hex Inch
	Part #	Hose ID	Material	inch	mm	inch	mm	
1/4"	2MS2-PL	1/4"	steel/brass	1.91	48.6	1.06	27.0	13/16"
	2MS2.5-PL	5/16"	steel/brass	2.33	59.1	1.06	27.0	13/16"
	2MS3-PL	3/8"	steel/brass	2.50	63.6	1.06	27.0	13/16"
3/8"	3MS3-PL	3/8"	steel/brass	2.60	66.0	1.26	32.0	1-1/16"

Pneumatic Couplings: M-Series

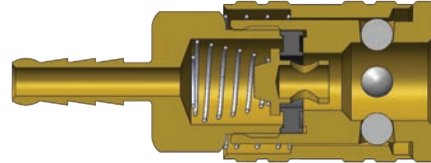
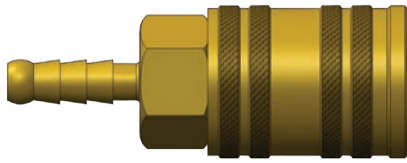

Body Size	M-Series Manual ARO Interchange Coupler (Standard Hose Barb)							
	Part Detail			Length		Maximum OD		Hex Inch
	Part #	Hose ID	Material	Inch	mm	Inch	mm	
1/4"	2MS2-B	1/4"	brass	2.36	60.0	0.87	22.0	3/4"
	2MS3-B	3/8"	brass	2.76	70.0	0.87	22.0	13/16"

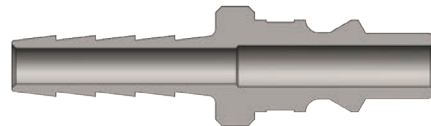
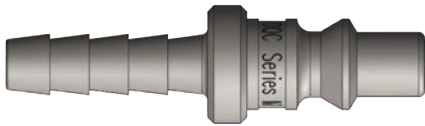

Body Size	M-Series ARO Interchange Plug (Standard Hose Barb)							
	Part Detail			Length		Maximum OD		Hex Inch
	Part #	Hose ID	Material	Inch	mm	Inch	mm	
1/4"	M2S2	1/4"	steel	2.00	50.8	0.56	14.2	-
	M2S3	3/8"	steel	2.00	50.8	0.56	14.2	-
3/8"	M3S3	3/8"	steel	2.25	57.2	0.88	22.4	-

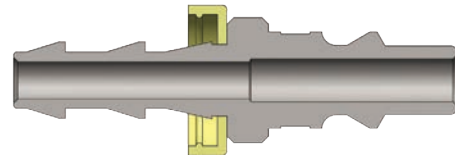
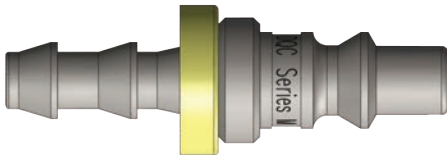

Body Size	M-Series ARO Interchange Plug (Push-Loc Barb)							
	Part Detail			Length		Maximum OD		Hex Inch
	Part #	Hose ID	Material	Inch	mm	Inch	mm	
1/4"	M2B2	1/4"	steel	2.09	53.1	0.69	17.5	-

! It is important to be safe when installing quick disconnect couplings into a pneumatic circuit. Never install a pneumatic coupling directly into an air tool. Use a piece of hose that is at least 18" long between the tool and the coupling to prevent damage to the coupling. To protect the operator, safety devices such as a safety check valve and safety cable should be installed in case there is a hose or coupling failure.

Pneumatic Couplings: CJ-Series

Interchange Data

- European High-flow Interchange
- 1/4" interchanges with Coilhose Megaflow, CEJN 320, and Rectus 25KA/26KA
- 3/8" interchanges with Rectus 27KA and CEJN 410

Materials

- Machined components are manufactured using solid steel or brass bar stock
- Stainless steel springs, carbon steel balls and retaining rings
- Steel componentry is plated using ROHS-compliant trivalent chrome

Seal Components

- Nitrile (Buna-N) pneumatically energized seals are standard, providing a temperature range of **-40°F to 250°F** (-40°C to 121°C)

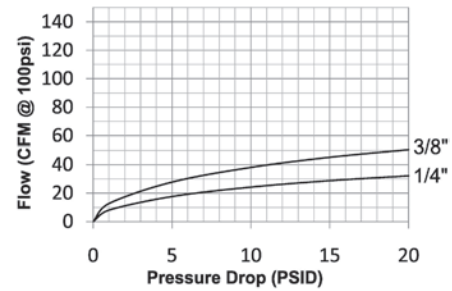

Rated Pressure Chart

Body Size	CJ-Series European High-Flow Interchange (Connected)							
	Brass Coupler/Steel Plug				Brass Coupler/Plug			
	Maximum Working		Burst		Maximum Working		Burst	
	PSI	Bar	PSI	Bar	PSI	Bar	PSI	Bar
1/4"	300	20	9,500	655	300	20	7,200	500
3/8"	300	20	8,000	552	300	20	4,400	300

Technical Specifications

Body Size	Interchange Standards				Functional Parameters				
	U.S. Military	U.S. Government	International Standards	ANSI/NFPA Standards	Locking Ball Quantity	Air Inclusion	Fluid Loss	Vacuum Rating	Flow ΔP = 15 PSI
1/4"	-	-	-	-	6	N/A	N/A	N/R	37 CFM
3/8"	-	-	-	-	6	N/A	N/A	N/R	67 CFM

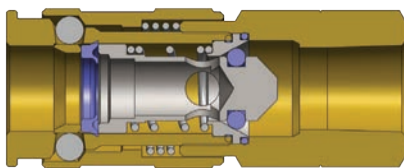

Body Size	CJ-Series European Interchange Coupler (Female Threads)							
	Part Detail			Length		Maximum OD		Hex Inch
	Part #	Threads	Material	Inch	mm	Inch	mm	
1/4"	2CJF2-B	1/4" - 18 NPT	brass	2.32	59.0	0.92	23.4	3/4"
	2CJBF2-B	1/4" - 19 BSPP	brass	2.32	59.0	0.92	23.4	3/4"
	2CJF3-B	3/8" - 18 NPT	brass	2.32	59.0	0.92	23.4	3/4"
	2CJBF3-B	3/8" - 19 BSPP	brass	2.32	59.0	0.92	23.4	3/4"
3/8"	3CJF3-B	3/8" - 18 NPT	brass	2.54	64.5	1.09	27.7	15/16"
	3CJBF3-B	3/8" - 19 BSPP	brass	2.54	64.5	1.09	27.7	15/16"
	3CJF4-B	1/2" - 14 NPT	brass	2.68	68.0	1.09	27.7	15/16"
	3CJBF4-B	1/2" - 14 BSPP	brass	2.68	68.0	1.09	27.7	15/16"

Pneumatic Couplings: CJ-Series

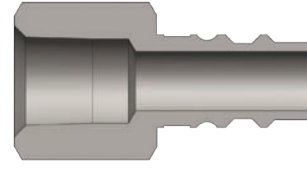
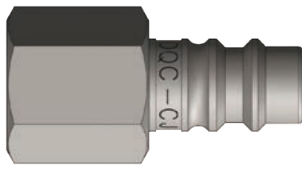

CJ-Series European Interchange Plug (Female Threads)

Body Size	Part Detail			Length		Maximum OD		Hex Inch
	Part #	Threads	Material	inch	mm	inch	mm	
1/4"	CJ2F2-LG	1/4" - 18 NPT	steel	1.42	36.0	0.79	20.1	11/16"
	CJ2F2-B	1/4" - 18 NPT	brass	1.42	36.0	0.79	20.1	11/16"
	CJ2BF2-LG	1/4" - 19 BSPP	steel	1.42	36.0	0.79	20.1	11/16"
	CJ2BF2-B	1/4" - 19 BSPP	brass	1.42	36.0	0.79	20.1	11/16"
	CJ2F3-LG	3/8" - 18 NPT	steel	1.48	37.5	1.01	25.7	7/8"
	CJ2F3-B	3/8" - 18 NPT	brass	1.48	37.5	1.01	25.7	7/8"
	CJ2BF3-LG	3/8" - 19 BSPP	steel	1.48	37.5	1.01	25.7	7/8"
	CJ2BF3-B	3/8" - 19 BSPP	brass	1.48	37.5	1.01	25.7	7/8"
3/8"	CJ3F3	3/8" - 18 NPT	steel	1.50	38.0	1.01	25.7	7/8"
	CJ3F3-B	3/8" - 18 NPT	brass	1.50	38.0	1.01	25.7	7/8"
	CJ3BF3	3/8" - 19 BSPP	steel	1.50	38.0	1.01	25.7	7/8"
	CJ3BF3-B	3/8" - 19 BSPP	brass	1.50	38.0	1.01	25.7	7/8"
	CJ3F4	1/2" - 14 NPT	steel	1.71	43.5	1.16	29.5	1"
	CJ3F4-B	1/2" - 14 NPT	brass	1.71	43.5	1.16	29.5	1"
	CJ3BF4	1/2" - 14 BSPP	steel	1.71	43.5	1.16	29.5	1"
	CJ3BF4-B	1/2" - 14 BSPP	brass	1.71	43.5	1.16	29.5	1"

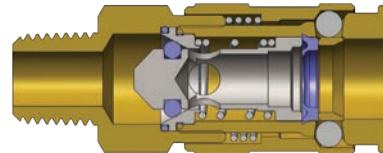
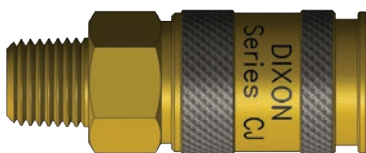

CJ-Series European Interchange Coupler (Male Threads)

Body Size	Part Detail			Length		Maximum OD		Hex Inch
	Part #	Threads	Material	inch	mm	inch	mm	
1/4"	2CJM2-B	1/4" - 18 NPT	brass	2.44	62.0	0.92	23.4	3/4"
	2CJBM2-B	1/4" - 19 BSPT	brass	2.44	62.0	0.92	23.4	3/4"
	2CJM3-B	3/8" - 18 NPT	brass	2.44	62.0	0.92	23.4	3/4"
	2CJBM3-B	3/8" - 19 BSPT	brass	2.44	62.0	0.92	23.4	3/4"
3/8"	3CJM3-B	3/8" - 18 NPT	brass	2.64	67.0	1.09	27.7	15/16"
	3CJBM3-B	3/8" - 19 BSPT	brass	2.64	67.0	1.09	27.7	15/16"
	3CJM4-B	1/2" - 14 NPT	brass	2.76	70.0	1.09	27.7	15/16"
	3CJBM4-B	1/2" - 14 BSPT	brass	2.76	70.0	1.09	27.7	15/16"

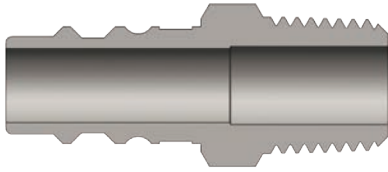

Body Size	CJ-Series European Interchange Plug (Male Threads)							
	Part Detail			Length		Maximum OD		Hex Inch
	Part #	Threads	Material	inch	mm	inch	mm	
1/4"	CJ2M2-LG	1/4" - 18 NPT	steel	1.48	37.5	0.65	16.5	9/16"
	CJ2M2-B	1/4" - 18 NPT	brass	1.48	37.5	0.65	16.5	9/16"
	CJ2BM2-LG	1/4" - 19 BSPT	steel	1.48	37.5	0.65	16.5	9/16"
	CJ2BM2-B	1/4" - 19 BSPT	brass	1.48	37.5	0.65	16.5	9/16"
	CJ2M3-LG	3/8" - 18 NPT	steel	1.56	39.5	0.79	20.1	11/16"
	CJ2M3-B	3/8" - 18 NPT	brass	1.56	39.5	0.79	20.1	11/16"
	CJ2BM3-LG	3/8" - 19 BSPT	steel	1.56	39.5	0.79	20.1	11/16"
	CJ2BM3-B	3/8" - 19 BSPT	brass	1.56	39.5	0.79	20.1	11/16"
3/8"	CJ3M3	3/8" - 18 NPT	steel	1.57	40.0	0.79	20.1	11/16"
	CJ3M3-B	3/8" - 18 NPT	brass	1.57	40.0	0.79	20.1	11/16"
	CJ3BM3	3/8" - 19 BSPT	steel	1.57	40.0	0.79	20.1	11/16"
	CJ3BM3-B	3/8" - 19 BSPT	brass	1.57	40.0	0.79	20.1	11/16"
	CJ3M4	1/2" - 14 NPT	steel	1.81	46.0	1.01	25.7	7/8"
	CJ3M4-B	1/2" - 14 NPT	brass	1.81	46.0	1.01	25.7	7/8"
	CJ3BM4	1/2" - 14 BSPT	steel	1.81	46.0	1.01	25.7	7/8"
	CJ3BM4-B	1/2" - 14 BSPT	brass	1.81	46.0	1.01	25.7	7/8"

CJ Series Profiles

Body Size	A	B
1/4"	0.39	0.19
3/8"	0.51	0.81

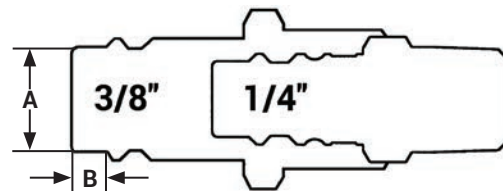

Pneumatic Couplings: SHD-Series

Interchange Data

- Schrader Twist-Lock Interchange
- Parker Twist-Lock, Foster SHD

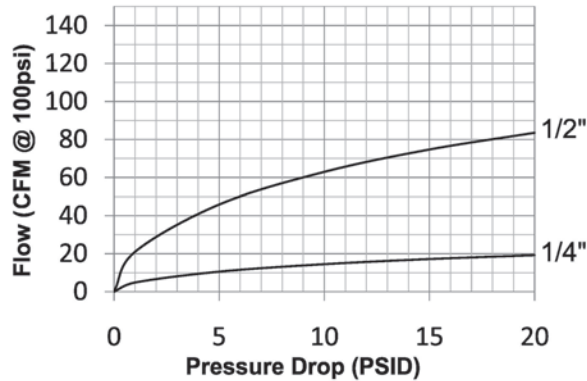

Materials

- Machined components are manufactured using solid steel, brass, or aluminum bar stock
- Stainless steel toggle-pawls and springs. Carbon steel retaining rings
- Steel componentry is plated using ROHS-compliant trivalent chrome
- Adapter components are constructed of brass
- Sleeves are constructed of steel

Seal Components

- Nitrile (Buna-N) seals are standard providing a temperature range of -40°F to 250°F (-40°C to 121°C)

Rated Pressure Chart

Body Size	SHD-Series Twist-Lock Interchange (Connected)			
	Coupler/Steel Plug			
	Maximum Working		Burst	
	PSI	Bar	PSI	Bar
1/4"	300	20	6,500	448
1/2"	300	20	13,400	924

Technical Specifications

Body Size	Interchange Standards				Functional Parameters				
	U.S. Military	U.S. Government	International Standards	ANSI/NFPA Standards	Locking Mechanism	Air Inclusion	Fluid Loss	Vacuum Rating	Flow ΔP = 15 PSI
1/4"	-	-	-	-	toggle-pawls	N/A	N/A	N/R	17 CFM
1/2"	-	-	-	-	toggle-pawls	N/A	N/A	N/R	75 CFM

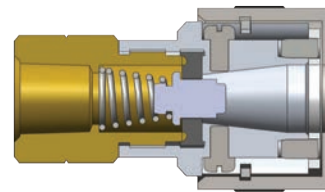

Body Size	SHD-Series Twist-Lock Interchange Coupler (Female Threads)							
	Part Detail			Length		Maximum OD		Hex Inch
	Part #	Threads	Material	inch	mm	inch	mm	
1/4"	2SHDF2	1/4" - 18 NPT	aluminum	2.10	53.3	1.12	28.4	11/16"
	2SHDF3	3/8" - 18 NPT	aluminum	2.18	55.4	1.12	28.4	11/16"
1/2"	4SHDF3	3/8" - 18 NPT	aluminum	2.59	65.8	1.50	38.1	1-1/8"
	4SHDF4	1/2" - 14 NPT	aluminum	2.66	67.6	1.50	38.1	1-1/8"
	4SHDF6	3/4" - 14 NPT	aluminum	2.81	71.4	1.50	38.1	1-1/8"



Body Size	SHD-Series Twist-Lock Interchange Plug (Female Threads)							
	Part Detail			Length		Maximum OD		Hex Inch
	Part #	Threads	Material	inch	mm	inch	mm	
1/4"	SHD2F1	1/8" - 27 NPT	steel	1.49	37.9	0.79	20.1	11/16"
	SHD2F2	1/4" - 18 NPT	steel	1.62	41.2	0.79	20.1	11/16"
1/2"	SHD4F3	3/8" - 18 NPT	steel	1.79	45.5	1.01	25.7	7/8"



Body Size	SHD-Series Twist-Lock Interchange Coupler (Male Threads)							
	Part Detail			Length		Maximum OD		Hex Inch
	Part #	Threads	Material	inch	mm	inch	mm	
1/4"	2SHDM2	1/4" - 18 NPT	aluminum	2.22	56.4	1.12	28.4	11/16"
	2SHDM3	3/8" - 18 NPT	aluminum	2.28	57.9	1.12	28.4	11/16"
1/2"	4SHDM3	3/8" - 18 NPT	aluminum	2.55	64.8	1.50	38.1	1-1/8"
	4SHDM4	1/2" - 14 NPT	aluminum	2.61	66.3	1.50	38.1	1-1/8"



Body Size	SHD-Series Twist-Lock Interchange Plug (Male Threads)							
	Part Detail			Length		Maximum OD		Hex Inch
	Part #	Threads	Material	inch	mm	inch	mm	
1/4"	SHD2M1	1/8" - 27 NPT	steel	1.54	39.1	0.79	20.1	11/16"
	SHD2M2	1/4" - 18 NPT	steel	1.72	43.7	0.79	20.1	11/16"
1/2"	SHD4M3	3/8" - 18 NPT	steel	1.81	46.0	1.01	25.7	7/8"
	SHD4M4	1/2" - 14 NPT	steel	1.87	47.5	1.01	25.7	7/8"

Pneumatic Couplings: SHD-Series



Body Size	SHD-Series Twist-Lock Interchange Coupler (Standard Hose Barb)							
	Part Detail			Length		Maximum OD		Hex Inch
	Part #	Hose ID	Material	Inch	mm	Inch	mm	
1/4"	2SHDS2	1/4"	aluminum	2.54	64.5	1.12	28.4	11/16"
	2SHDS3	3/8"	aluminum	2.67	67.8	1.12	28.4	11/16"
1/2"	4SHDS3	3/8"	aluminum	2.99	76.0	1.50	38.1	1-1/8"
	4SHDS4	1/2"	aluminum	4.23	107.4	1.50	38.1	1-1/8"



Body Size	SHD-Series Twist-Lock Interchange Plug (Standard Hose Barb)							
	Part Detail			Length		Maximum OD		Hex Inch
	Part #	Hose ID	Material	Inch	mm	Inch	mm	
1/4"	SHD2S2	1/4"	steel	2.03	51.6	0.65	16.5	-
	SHD2S3	3/8"	steel	2.22	56.4	0.65	16.5	-
1/2"	SHD4S3	3/8"	steel	2.34	59.4	0.80	20.3	-
	SHD4S4	1/2"	steel	2.53	64.3	0.80	20.3	-

SHD Series Profiles

Body Size	A	B
1/4"	0.32	0.75
3/8"	0.50	0.75

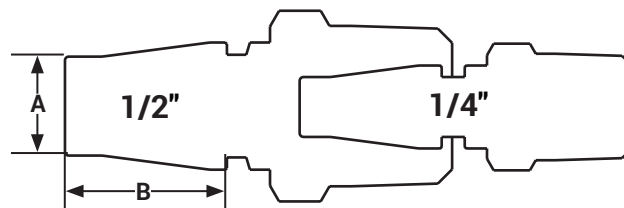

! Operating pressure for couplings utilizing hose barb end connections may be dramatically reduced to that of the hose rating and/or hose end connection combination. Consult hose manufacturer's catalog for hose end connection ratings. If in doubt, test under controlled conditions for suitability to application. Dixon Quick Coupling cannot assume liability for misapplication of production resulting in equipment down-time, lost production, and/or personal injury including death.

Interchange Data

- Lincoln Long-nose Automotive Interchange
- Parker 70-Series, Coilhose Type-17

Materials

- Machined components are manufactured using solid brass or steel bar stock.
- Stainless steel springs, carbon steel balls and retaining rings
- Steel componentry is plated using ROHS-compliant trivalent chrome

Seal Components

- Nitrile (Buna-N) seals are standard, providing a temperature range of -40°F to 250°F (-40°C to 121°C)

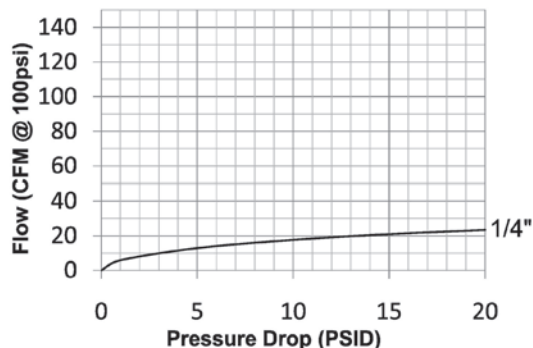

Rated Pressure Chart

Body Size	L-Series Lincoln Interchange (Connected)			
	Brass Coupler/Steel Plug			
	Maximum Working		Burst	
	PSI	Bar	PSI	Bar
1/4"	300	21	5,000	345

Technical Specifications

Body Size	Interchange Standards				Functional Parameters				
	U.S. Military	U.S. Government	International Standards	ANSI/NFPA Standards	Locking Ball Quantity	Air Inclusion	Fluid Loss	Vacuum Rating	Flow ΔP = 15 PSI
1/4"	-	-	-	-	4	N/A	N/A	N/R	21 CFM

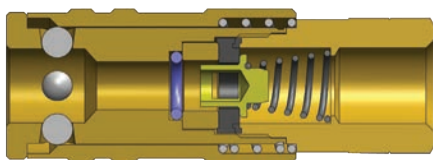

Body Size	L-Series Lincoln Interchange Coupler (Female Threads)							
	Part Detail			Length		Maximum OD		Hex Inch
	Part #	Threads	Material	Inch	mm	Inch	mm	
1/4"	2LF2-B	1/4" - 18 NPT	brass	2.40	61.0	0.90	22.9	3/4"

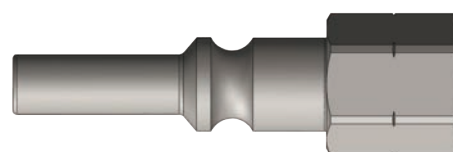
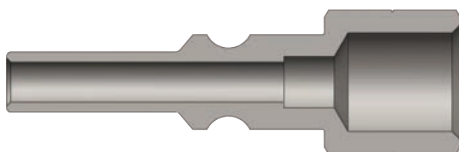

Body Size	L-Series Lincoln Interchange Plug (Female Threads)							
	Part Detail			Length		Maximum OD		Hex Inch
	Part #	Threads	Material	Inch	mm	Inch	mm	
1/4"	L2F2	1/4" - 18 NPT	steel	2.10	53.3	0.72	18.3	5/8"

Pneumatic Couplings: L-Series

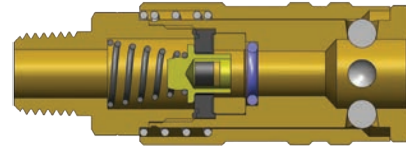

Body Size	L-Series Lincoln Interchange Coupler (Male Threads)							
	Part Detail			Length		Maximum OD		Hex Inch
	Part #	Threads	Material	Inch	mm	Inch	mm	
1/4"	2LM2-B	1/4" - 18 NPT	brass	2.62	66.5	0.90	22.9	3/4"

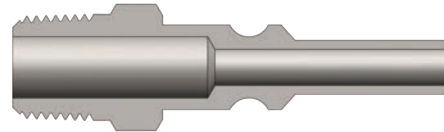
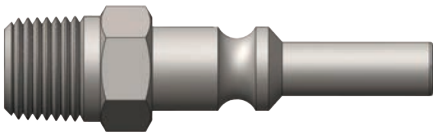

Body Size	L-Series Lincoln Interchange Plug (Male Threads)							
	Part Detail			Length		Maximum OD		Hex Inch
	Part #	Threads	Material	Inch	mm	Inch	mm	
1/4"	L2M2	1/4" - 18 NPT	steel	2.25	57.2	0.65	16.5	9/16"

L Series Profile

Body Size	A	B
3/8"	0.28	0.79

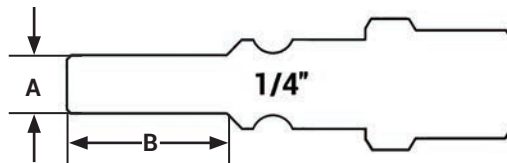

! It is important to be safe when installing quick disconnect couplings into a pneumatic circuit. Never install a pneumatic coupling directly into an air tool. Use a piece of hose that is at least 18" long between the tool and the coupling to prevent damage to the coupling. To protect the operator, safety devices such as a safety check valve and safety cable should be installed in case there is a hose or coupling failure.

Interchange Data

- 2U-Series 6-in-1 (ARO 210, Industrial, Tru-Flate, Lincoln, Italian, and CEJN 320)
- 3U-Series 4-in-1 (ARO 310, Industrial, Tru-Flate, and CEJN 410)
- Parker UC-Series, Hansen Auto-Flo 23, and Coilhose Series UC

Materials

- Machined components are manufactured using solid brass bar stock
- Stainless steel springs, carbon steel balls and retaining rings
- Valve components are machined from solid brass bar stock

Seal Components

- Nitrile (Buna-N) pneumatically energized seals are standard, providing a temperature range of **-40°F to 250°F** (**-40°C to 121°C**)

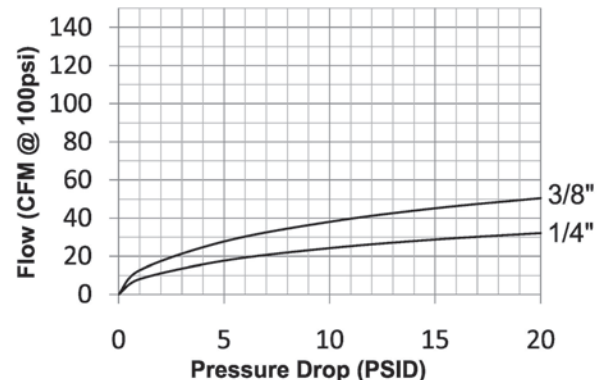

Rated Pressure Chart

Body Size	U-Series Automatic Universal Coupler Connected															
	Coupler/Steel DF Plug				Coupler/Steel CJ Plug				Coupler/Steel J Plug				Coupler/Steel M Plug			
	Max. Working		Burst		Max. Working		Burst		Max. Working		Burst		Max. Working		Burst	
	PSI	Bar	PSI	Bar	PSI	Bar	PSI	Bar	PSI	Bar	PSI	Bar	PSI	Bar	PSI	Bar
1/4"	300	20	2,800	193	300	20	9,500	655	300	20	6,400	441	300	20	4,300	297
3/8"	300	20	2,000	138	300	20	8,000	552	300	20	4,000	276	300	20	2,000	138

Technical Specifications

Body Size	Interchange Standards				Functional Parameters				
	U.S. Military	U.S. Government	International Standards	ANSI/NFPA Standards	Locking Ball Quantity	Air Inclusion	Fluid Loss	Vacuum Rating	Flow ΔP = 15 PSI
1/4"	-	-	-	-	6	N/A	N/A	N/R	37 SCFM
3/8"	-	-	-	-	6	N/A	N/A	N/R	67 SCFM

! Many competitive universal couplings are unable to match the performance capabilities of the Dixon U-Series. Each of the competitive universal couplers only accepts three pneumatic plug styles. Although the universal coupler permits multiple series plugs to mate with one coupler, it is recommended to match like series couplers and plugs. When using a universal coupler, the lower performance rating between the coupler and plug must take precedence.

! Dry air: Some pneumatic applications require the pressurized air to be 'dried' to ensure proper operation of equipment and/or application of product (eg. auto body shops). It is best to match like series couplers and plugs in these applications. If it is necessary to use a universal coupler, lube the seal and valve area regularly to ensure reliable service.

Pneumatic Couplings: U-Series

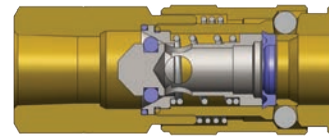

U-Series Automatic Universal Coupler (Female Threads)

Body Size	Part Detail			Length		Maximum OD		Hex Inch
	Part #	Threads	Material	Inch	mm	Inch	mm	
	1/4"	2UF2-B	1/4" - 18 NPT	brass	2.32	59.0	0.92	
2UBF2-B		1/4"-19 BSPP	brass	2.32	59.0	0.92	23.4	3/4"
2UF3-B		3/8" - 18 NPT	brass	2.32	59.0	0.92	23.4	3/4"
2UBF3-B		3/8"-19 BSPP	brass	2.32	59.0	0.92	23.4	3/4"
3/8"	3UF3-B	3/8" - 18 NPT	brass	2.54	64.5	1.09	27.7	15/16"
	3UBF3-B	3/8"-19 BSPP	brass	2.54	64.5	1.09	27.7	15/16"

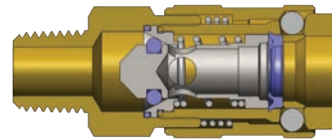

U-Series Automatic Universal Coupler (Male Threads)

Body Size	Part Detail			Length		Maximum OD		Hex Inch
	Part #	Threads	Material	Inch	mm	Inch	mm	
	1/4"	2UM2-B	1/4" - 18 NPT	brass	2.44	62.0	0.92	
2UBM2-B		1/4"-19 BSPP	brass	2.44"	62.0	0.92"	23.4	3/4"
2UM3-B		3/8" - 18 NPT	brass	2.44	62.0	0.92	23.4	3/4"
2UBM3-B		3/8"-19 BSPP	brass	2.44"	62.0	0.92"	23.4	3/4"
3/8"	3UM3-B	3/8" - 18 NPT	brass	2.64	67.0	1.09	27.7	15/16"
	3UBM3-B	3/8"-19 BSPP	brass	2.64"	67.0	1.09"	27.7	15/16"

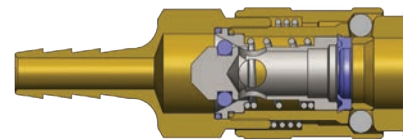
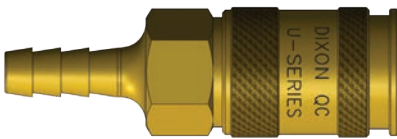

U-Series Automatic Universal Coupler (Standard Hose Barb)

Body Size	Part Detail			Length		Maximum OD		Hex Inch
	Part #	Hose ID	Material	Inch	mm	Inch	mm	
	1/4"	2US2-B	1/4"	brass	2.64	67.0	0.92	
2US3-B		3/8"	brass	2.76	70.0	0.92	23.4	3/4"
3/8"	3US3-B	3/8"	brass	2.99	76.0	1.09	27.7	15/16"

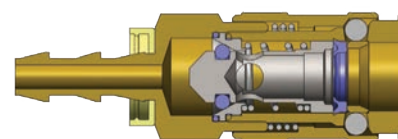
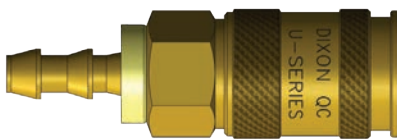

U-Series Automatic Universal Coupler (Push-Loc Barb)

Body Size	Part Detail			Length		Maximum OD		Hex Inch
	Part #	Hose ID	Material	Inch	mm	Inch	mm	
	1/4"	2UB2-B	1/4"	brass	2.52	64.0	0.92	
2UB3-B		3/8"	brass	2.64	67.0	0.92	23.4	3/4"

Interchange Data

- Bowes Interchange Bayonet Style
- Interchangeable with Bowes 51000-Series, National Series B, Dix-Lock®, MacDonald Quick-Action, and Campbell Single Lock

Materials

- Machined components are manufactured using solid steel, brass, or 303 stainless steel bar stock. 316 stainless steel available in some versions upon request
- Stainless steel retaining ring and spring maximize corrosion resistance and extend service life
- Steel componentry is plated using ROHS-compliant trivalent chrome
- Dust cap with steel cable lanyard
- Steel plugs have a cast zinc sleeve
- Steel and brass locking version have an aluminum lock ring while the stainless locking version has a stainless lock ring

Seal Components

- Nitrile (Buna-N) pneumatically energized seals are standard, providing a temperature range of -40°F to 250°F (-40°C to 121°C)

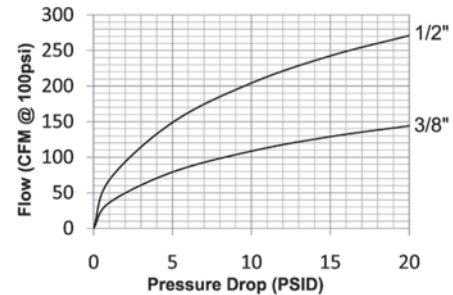

Rated Pressure Chart

Body Size	Dix-Lock N-Series (Connected)											
	Steel Coupler/Plug				Brass Coupler/Plug				303 Stainless Steel Coupler/Plug			
	Max. Working		Burst		Max. Working		Burst		Max. Working		Burst	
	PSI	Bar	PSI	Bar	PSI	Bar	PSI	Bar	PSI	Bar	PSI	Bar
3/8"	500	35	7,000	480	-	-	-	-	-	-	-	-
1/2"	500	35	11,000	755	300	20	8,200	565	500	35	12,600	865

Technical Specifications

Body Size	Interchange Standards				Functional Parameters				
	U.S. Military	U.S. Government	International Standards	ANSI/NFPA Standards	Locking Mechanism	Air Inclusion	Fluid Loss	Vacuum Rating	Flow ΔP = 10 PSI
3/8"	-	-	-	-	latch tabs	N/A	N/A	N/R	108 CFM
1/2"	MIL-C-3486	A-A-50431A	-	-	latch tabs	N/A	N/A	N/R	204 CFM

Available Options

Body Size	Seals	Staked Ferrule Option		
	FKM	1/2" Barb	3/4" Barb	3/4" Stainless Barb
	Prefix	Suffix	Suffix	Suffix
3/8"	F-	-WF	-WF	-WF
1/2"	F-	-WF	-WF	-WF

! It is important to be safe when installing quick disconnect couplings into a pneumatic circuit. Never install a pneumatic coupling directly into an air tool. Use a piece of hose that is at least 18" long between the tool and the coupling to prevent damage to the coupling. To protect the operator, safety devices such as a safety check valve and safety cable should be installed in case there is a hose or coupling failure.

Pneumatic Couplings: Dix-Lock® N-Series

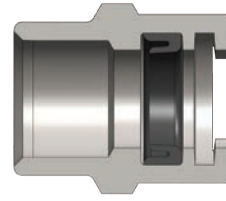
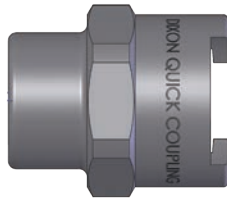

Body Size	Dix-Lock N-Series Coupler (Female Threads)							
	Part Detail			Length		Maximum OD		Hex Inch
	Part #	Threads	Material	Inch	mm	Inch	mm	
1/2"	4NBF3	3/8" - 19 BSPP	steel	1.63	41.4	1.54	39.1	1-3/8"
	4NBF4	1/2" - 14 BSPP	steel	1.63	41.4	1.54	39.1	1-3/8"
	4NBF4-B	1/2" - 14 BSPP	brass	1.63	41.4	1.54	39.1	1-3/8"
	4NBF6	3/4" - 14 BSPP	steel	1.63	41.4	1.54	39.1	1-3/8"
	4NBF6-B	3/4" - 14 BSPP	brass	1.63	41.4	1.54	39.1	1-3/8"
	4NBF8	1" - 11 BSPP	steel	1.68	42.6	1.73	43.9	1-1/2"
	4NBF8-B	1" - 11 BSPP	brass	1.68	42.6	1.73	43.9	1-1/2"
	4NF3	3/8" - 18 NPTF	steel	1.63	41.4	1.54	39.1	1-3/8"
	4NF3-B	3/8" - 18 NPTF	brass	1.63	41.4	1.54	39.1	1-3/8"
	4NF4	1/2" - 14 NPTF	steel	1.63	41.4	1.54	39.1	1-3/8"
	4NF4-B	1/2" - 14 NPTF	brass	1.63	41.4	1.54	39.1	1-3/8"
	4NF6	3/4" - 14 NPTF	steel	1.63	41.4	1.54	39.1	1-3/8"
	4NF6-B	3/4" - 14 NPTF	brass	1.63	41.4	1.54	39.1	1-3/8"
	4NF6-S	3/4" - 14 NPTF	303 stainless	1.63	41.4	1.54	39.1	1-3/8"
	4NF6-SS	3/4" - 14 NPTF	316 stainless	1.63	41.4	1.54	39.1	1-3/8"
	4NF8	1" - 11-1/2 NPTF	steel	1.68	42.6	1.73	43.9	1-1/2"
	4NF8-B	1" - 11-1/2 NPTF	brass	1.68	42.6	1.73	43.9	1-1/2"
	4NF8-SS	1" - 11-1/2 NPTF	316 stainless	1.68	42.6	1.73	43.9	1-1/2"

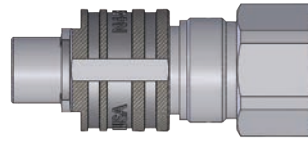
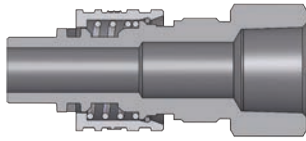

Body Size	Dix-Lock N-Series Plug (Female Threads)							
	Part Detail			Length		Maximum OD		Hex Inch
	Part #	Threads	Material	Inch	mm	Inch	mm	
1/2"	N4BF3	3/8" - 19 BSPP	steel	2.92	74.0	1.31	33.3	1-3/16"
	N4BF4	1/2" - 14 BSPP	steel	2.92	74.0	1.31	33.3	1-3/16"
	N4BF4-B	1/2" - 14 BSPP	brass	2.92	74.0	1.31	33.3	1-3/16"
	N4BF6	3/4" - 14 BSPP	steel	3.42	86.7	1.50	38.1	1-3/8"
	N4BF6-B	3/4" - 14 BSPP	brass	3.42	86.7	1.50	38.1	1-3/8"
	N4BF8	1" - 11 BSPP	steel	3.59	91.2	1.79	45.3	1-5/8"
	N4BF8-B	1" - 11 BSPP	brass	3.59	91.2	1.79	45.3	1-5/8"
	N4F3	3/8" - 18 NPTF	steel	2.92	74.0	1.31	33.3	1-3/16"
	N4F3-B	3/8" - 18 NPTF	brass	2.92	74.0	1.31	33.3	1-3/16"
	N4F4	1/2" - 14 NPTF	steel	2.92	74.0	1.31	33.3	1-3/16"
	N4F4-B	1/2" - 14 NPTF	brass	2.92	74.0	1.31	33.3	1-3/16"
	N4F6	3/4" - 14 NPTF	steel	3.42	86.7	1.50	38.1	1-3/8"
	N4F6-B	3/4" - 14 NPTF	brass	3.42	86.7	1.50	38.1	1-3/8"
	N4F6-S	3/4" - 14 NPTF	303 stainless	3.42	86.7	1.50	38.1	1-3/8"
	N4F6-SS	3/4" - 14 NPTF	316 stainless	3.42	86.7	1.50	38.1	1-3/8"
	N4F8	1" - 11-1/2 NPTF	steel	3.59	91.2	1.79	45.3	1-5/8"
N4F8-B	1" - 11-1/2 NPTF	brass	3.59	91.2	1.79	45.3	1-5/8"	
N4F8-SS	1" - 11-1/2 NPTF	316 stainless	3.59	91.2	1.79	45.3	1-5/8"	

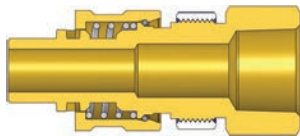

Body Size	Dix-Lock N-Series Plug with Locking Sleeve (Female Threads)							
	Part Detail			Length		Maximum OD		Hex Inch
	Part #	Threads	Material	Inch	mm	Inch	mm	
1/2"	N4F4-B-LS	1/2" - 14 NPTF	brass	2.92	74.0	1.31	33.3	1-3/16"
	N4F6-B-LS	3/4" - 14 NPTF	brass	3.42	86.7	1.50	38.1	1-3/8"
	N4F6-LS	3/4" - 14 NPTF	steel	3.42	86.70	1.50	38.10	1-3/8"

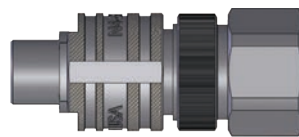
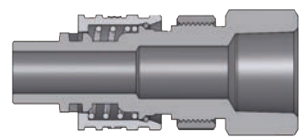

Body Size	Dix-Lock N-Series Plug with Steel Locking Sleeve (Female Threads)							
	Part Detail			Length		Maximum OD		Hex Inch
	Part #	Threads	Material	Inch	mm	Inch	mm	
1/2"	N4F6-ZLS	3/4" - 14 NPTF	steel	1.63	41.40	1.54	39.10	1-3/8"

Pneumatic Couplings: Dix-Lock® N-Series

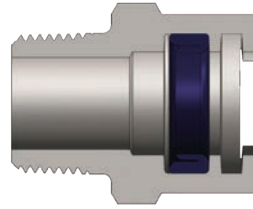

Body Size	Dix-Lock N-Series Coupler (Male Threads)							
	Part Detail			Length		Maximum OD		Hex Inch
	Part #	Threads	Material	Inch	mm	Inch	mm	
3/8"	3NBM4	1/2" - 14 BSPT	steel	1.73	43.8	1.1	27.9	1"
	3NM4	1/2" - 14 NPTF	steel	1.8	45.7	1.1	27.9	1"
1/2"	4NBM3	3/8" - 19 BSPT	steel	1.66	42.2	1.5	38.1	1-3/8"
	4NBM4	1/2" - 14 BSPT	steel	1.75	44.5	1.5	38.1	1-3/8"
	4NBM4-B	1/2" - 14 BSPT	brass	1.75	44.5	1.5	38.1	1-3/8"
	4NBM6	3/4" - 14 BSPT	steel	1.85	47	1.5	38.1	1-3/8"
	4NBM6-B	3/4" - 14 BSPT	brass	1.85	47	1.5	38.1	1-3/8"
	4NBM8	1" - 11 BSPT	steel	1.95	49.5	1.5	38.1	1-1/2"
	4NBM8-B	1" - 11 BSPT	brass	1.95	49.5	1.5	38.1	1-1/2"
	4NM3	3/8" - 18 NPTF	steel	1.66	42.2	1.5	38.1	1-3/8"
	4NM3-B	3/8" - 18 NPTF	brass	1.66	42.2	1.5	38.1	1-3/8"
	4NM4	1/2" - 14 NPTF	steel	1.85	47	1.5	38.1	1-3/8"
	4NM4-B	1/2" - 14 NPTF	brass	1.85	47	1.5	38.1	1-3/8"
	4NM6	3/4" - 14 NPTF	steel	1.85	47	1.5	38.1	1-3/8"
	4NM6-B	3/4" - 14 NPTF	brass	1.85	47	1.5	38.1	1-3/8"
	4NM6-S	3/4" - 14 NPTF	303 stainless	1.85	47	1.5	38.1	1-3/8"
	4NM6-SS	3/4" - 14 NPTF	316 stainless	1.85	47	1.5	38.1	1-3/8"
	4NM8	1" - 11-1/2 NPTF	steel	1.95	49.5	1.5	38.1	1-1/2"
	4NM8-B	1" - 11-1/2 NPTF	brass	1.95	49.5	1.5	38.1	1-1/2"
	4NM8-SS	1" - 11-1/2 NPTF	316 stainless	1.95	49.5	1.5	38.1	1-1/2"

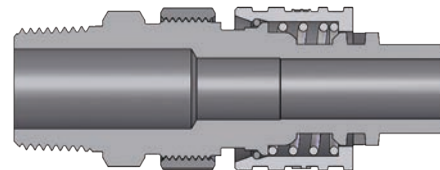
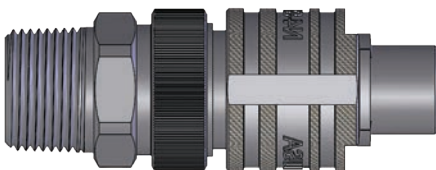

Body Size	Dix-Lock N-Series Interchange Plug with Steel Locking Sleeve (Male Threads)							
	Part Detail			Length		Maximum OD		Hex Inch
	Part #	Threads	Material	Inch	mm	Inch	mm	
1/2"	N4M6-ZLS	3/4" - 14 NPTF	steel	3.65	92.70	1.31	33.30	1-3/16"

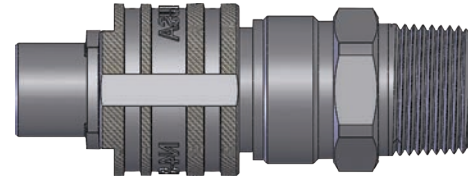
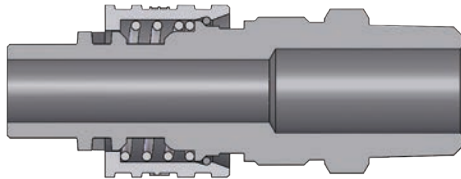

Body Size	Dix-Lock N-Series Plug (Male Threads)							
	Part Detail			Length		Maximum OD		Hex Inch
	Part #	Threads	Material	Inch	mm	Inch	mm	
3/8"	N3BM4	1/2" - 14 BSPT	steel	3.36	85.3	1.13	28.6	1"
	N3M4	1/2" - 14 NPTF	steel	3.36	85.3	1.13	28.6	1"
1/2"	N4BM3	3/8" - 19 BSPT	steel	3.46	87.9	1.31	33.3	1-3/16"
	N4BM4	1/2" - 14 BSPT	steel	3.65	92.7	1.31	33.3	1-3/16"
	N4BM4-B	1/2" - 14 BSPT	brass	3.65	92.7	1.31	33.3	1-3/16"
	N4BM6	3/4" - 14 BSPT	steel	3.65	92.7	1.31	33.3	1-3/16"
	N4BM6-B	3/4" - 14 BSPT	brass	3.64	92.7	1.31	33.3	1-3/16"
	N4BM8	1" - 11 BSPT	steel	3.89	98.8	1.51	38.4	1-3/8"
	N4BM8-B	1" - 11 BSPT	brass	3.89	98.8	1.51	38.4	1-3/8"
	N4M3	3/8" - 18 NPTF	steel	3.46	87.9	1.31	33.3	1-3/16"
	N4M3-B	3/8" - 18 NPTF	brass	3.46	87.9	1.31	33.3	1-3/16"
	N4M4	1/2" - 14 NPTF	steel	3.65	92.7	1.31	33.3	1-3/16"
	N4M4-B	1/2" - 14 NPTF	brass	3.65	92.7	1.31	33.3	1-3/16"
	N4M6	3/4" - 14 NPTF	steel	3.65	92.7	1.31	33.3	1-3/16"
	N4M6-B	3/4" - 14 NPTF	brass	3.65	92.7	1.31	33.3	1-3/16"
	N4M6-S	3/4" - 14 NPTF	303 stainless	3.65	92.7	1.31	33.3	1-3/16"
	N4M6-SS	3/4" - 14 NPTF	316 stainless	3.65	92.7	1.31	33.30	1-3/16"
	N4M8	1" - 11-1/2 NPTF	steel	3.89	98.8	1.51	38.4	1-3/8"
	N4M8-B	1" - 11-1/2 NPTF	brass	3.89	98.8	1.51	38.4	1-3/8"
	N4M8-SS	1" - 11-1/2 NPTF	316 stainless	3.89	98.8	1.51	38.40	1-3/8"

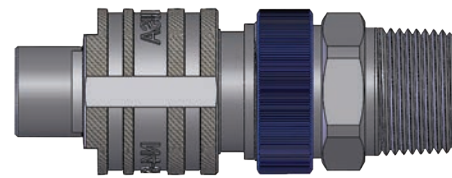
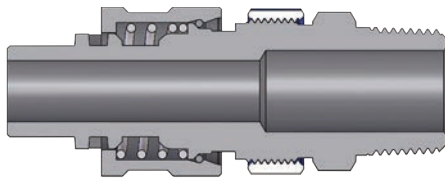

Body Size	Dix-Lock N-Series Plug with Locking Sleeve (Male Threads)							
	Part Detail			Length		Maximum OD		Hex Inch
	Part #	Threads	Material	Inch	mm	Inch	mm	
1/2"	N4BM4-LS	1/2" - 14 BSPT	steel	3.65	92.7	1.31	33.3	1-3/16"
	N4BM6-LS	3/4" - 14 BSPT	steel	3.65	92.7	1.31	33.3	1-3/16"
	N4M4-B-LS	1/2" - 14 NPTF	brass	3.65	92.7	1.31	33.3	1-3/16"
	N4M4-LS	1/2" - 14 NPTF	steel	3.65	92.7	1.31	33.3	1-3/16"
	N4M6-B-LS	3/4" - 14 NPTF	brass	3.65	92.7	1.31	33.3	1-3/16"
	N4M6-LS	3/4" - 14 NPTF	steel	3.65	92.7	1.31	33.3	1-3/16"
	N4M6-S-LS	3/4" - 14 NPTF	303 stainless	3.65	92.7	1.31	33.3	1-3/16"

Pneumatic Couplings: Dix-Lock® N-Series

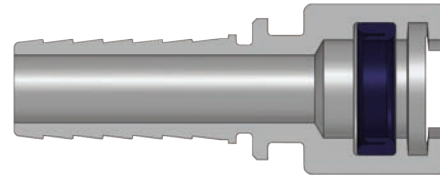
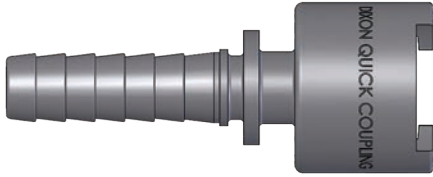

Body Size	Dix-Lock N-Series Coupler (Hose Barb)						
	Part Detail			Length		Maximum OD	
	Part #	Hose ID	Material	Inch	mm	Inch	mm
3/8"	3NCS4	1/2"	steel	4.74	120.4	0.99	25.1
	4NS3	3/8"	steel	4.54	115.3	1.4	35.6
	4NS3-B	3/8"	brass	4.54	115.3	1.4	35.6
	4NS4	1/2"	steel	4.95	125.7	1.4	35.6
	4NS4-B	1/2"	brass	4.95	125.7	1.4	35.6
1/2"	4NS6	3/4"	steel	4.95	125.7	1.4	35.6
	4NS6-B	3/4"	brass	4.95	125.7	1.4	35.6
	4NS6-S	3/4"	303 stainless	4.95	125.7	1.4	35.6
	4NS6-SS	3/4"	316 stainless	4.95	125.7	1.4	35.6
	4NS8	1"	steel	5.77	146.4	1.4	35.6
	4NS8-B	1"	brass	5.77	146.4	1.4	35.6
	4NS8-S	1"	303 stainless	5.77	146.4	1.4	35.6
	4NS8-SS	1"	316 stainless	5.77	146.4	1.4	35.6

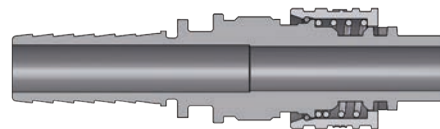

Body Size	Dix-Lock N-Series Plug (Hose Barb)						
	Part Detail			Length		Maximum OD	
	Part #	Hose ID	Material	Inch	mm	Inch	mm
3/8"	N3CS4	1/2"	steel	3.73	94.8	1.13	28.6
	N4S3	3/8"	steel	4.36	110.7	1.4	35.6
	N4S3-B	3/8"	brass	4.36	110.7	1.4	35.6
	N4S4	1/2"	steel	4.63	117.6	1.4	35.6
	N4S4-B	1/2"	brass	4.63	117.6	1.4	35.6
1/2"	N4S6	3/4"	steel	4.77	121.2	1.4	35.6
	N4S6-B	3/4"	brass	4.77	121.2	1.4	35.6
	N4S6-S	3/4"	303 stainless	4.77	121.2	1.4	35.6
	N4S6-SS	3/4"	316 stainless	4.77	121.2	1.4	35.6
	N4S8	1"	steel	4.77	121.2	1.4	35.6
	N4S8-B	1"	brass	4.77	121.2	1.4	35.6
	N4S8-S	1"	303 stainless	4.77	121.2	1.4	35.6
	N4S8-SS	1"	316 stainless	4.77	121.2	1.4	35.6

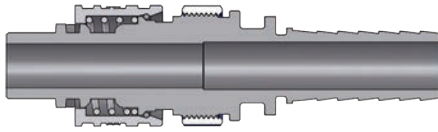

Body Size	Dix-Lock N-Series Plug with Locking Sleeve (Hose Barb)							
	Part Detail			Length		Maximum OD		Hex Inch
	Part #	Hose ID	Material	Inch	mm	Inch	mm	
1/2"	N4S4-LS	1/2"	steel	4.95	125.7	1.40	35.6	-
	N4S4-B-LS	1/2"	brass	4.95	125.7	1.40	35.6	-
	N4S6-LS	3/4"	steel	4.95	125.7	1.40	35.6	-
	N4S6-B-LS	3/4"	brass	4.95	125.7	1.40	35.6	-
	N4S6-S-LS	3/4"	303 stainless	4.95	125.7	1.40	35.6	-

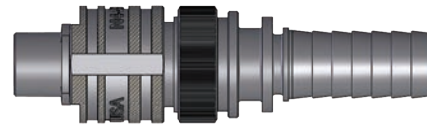
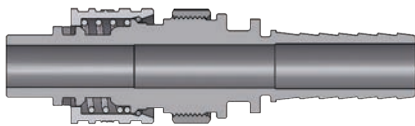

Body Size	Dix-Lock N-Series Interchange Plug with Steel Locking Sleeve (Hose Barb)							
	Part Detail			Length		Maximum OD		Hex Inch
	Part #	Threads	Material	Inch	mm	Inch	mm	
1/2"	N4S6-ZLS	3/4" barb	steel	4.77	121.20	1.40	35.60	-

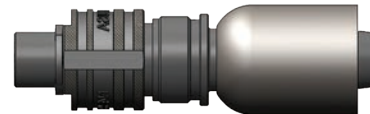
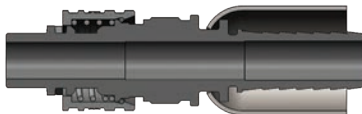

Body Size	Dix-Lock N-Series Coupler with Ferrule (Hose Barb)								
	Part Detail			Hose OD		Length		Maximum OD	
	Part #	Hose ID	Material	From	To	Inch	mm	Inch	mm
1/2"	N4S4-WF	1/2" barb	steel	5/16"	1-2/16"	4.95	125.70	1.40	35.60
	N4S6-WF	3/4" barb	steel	1-10/16"	1-22/16"	4.95	125.70	1.40	35.60
	N4S4-B-WF	1/2" barb	brass	5/16"	1-2/16"	4.95	125.70	1.40	35.60
	N4S6-B-WF	3/4" barb	brass	1-10/16"	1-22/16"	4.95	125.70	1.40	35.60
	N4S6-S-WF	3/4" barb	303 stainless	1-10/16"	1-22/16"	4.95	125.70	1.40	35.60

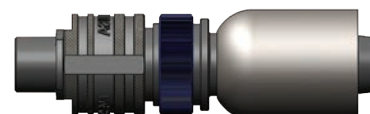
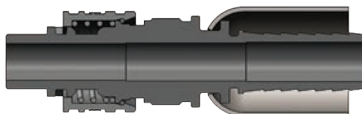

Body Size	Dix-Lock N-Series Plug with Locking Sleeve and Ferrule (Hose Barb)								
	Part Detail			Hose OD		Length		Maximum OD	
	Part #	Hose ID	Material	From	To	Inch	mm	Inch	mm
1/2"	N4S4-B-LS-WF	1/2" barb	brass	5/16"	1-2/16"	4.95	125.70	1.40	35.60
	N4S6-B-LS-WF	3/4" barb	brass	1-10/16"	1-22/16"	4.95	125.70	1.40	35.60
	N4S4-LS-WF	1/2" barb	steel	5/16"	1-2/16"	4.95	125.70	1.40	35.60
	N4S6-LS-WF	3/4" barb	steel	1-10/16"	1-22/16"	4.95	125.70	1.40	35.60

Pneumatic Couplings: Dix-Lock® N-Series

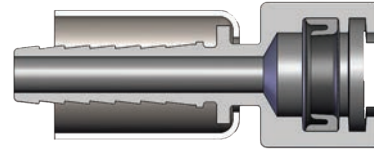
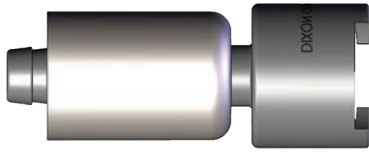

Body Size	Dix-Lock N-Series Coupler with Ferrule (Hose Barb)								
	Part Detail			Hose OD		Length		Maximum OD	
	Part #	Hose ID	Material	From	To	Inch	mm	Inch	mm
1/2"	4NS4-WF	1/2" barb	steel	5/4"	1-2/64"	4.95	125.70	1.40	35.60
	4NS4-B-WF	1/2" barb	brass	5/4"	1-2/64"	4.95	125.70	1.40	35.60
	4NS6-WF	3/4" barb	steel	1-10/64"	1-22/64"	4.95	125.70	1.40	35.60
	4NS6-B-WF	3/4" barb	brass	1-10/64"	1-22/64"	4.95	125.70	1.40	35.60

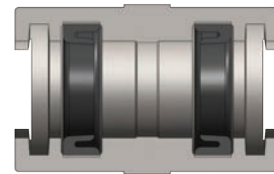
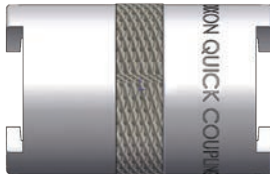

Body Size	Dix-Lock N-Series Gender-Change Union							
	Part Detail			Length		Maximum OD		Hex Inch
	Part #	Configuration	Material	Inch	mm	Inch	mm	
1/2"	4N4N	coupler to coupler	steel	3.26	82.8	1.33	33.8	-

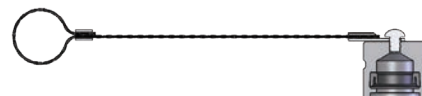
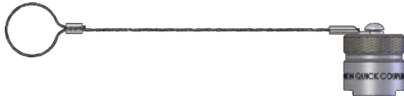

Body Size	Dix-Lock N-Series Protective Plug Cap							
	Part Detail			Length		Maximum OD		Hex Inch
	Part #	Cap Lanyard	Material	Inch	mm	Inch	mm	
1/2"	N4DC	steel cable	steel	1.50	38.1	1.33	33.8	-
	N4DC-B	steel cable	brass	1.50	38.1	1.33	33.8	-

Body Size	Dix-Lock N-Series Replacement Seals				
	Part Detail			Seal Kit Contents	
	Part #	Coupler Style	Seal Material		
3/8"	3N-SKIT	all	Nitrile	Pneumatically Energized Seal	
1/2"	4N-SKIT	all	Nitrile		
	F-4N-SKIT	all	FKM		

Interchange Data

- Thor Finger-Lock Interchange
- Interchanges with Thor PHC-Series, National Series A, Dual-Lock, and Campbell Double Lock

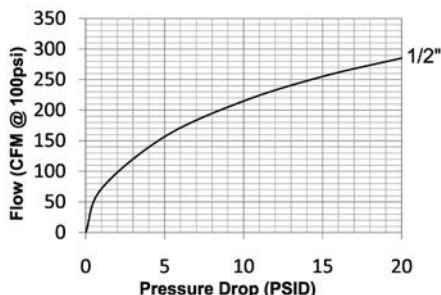

Materials

- Machined components are manufactured using solid steel, brass, or 303 stainless steel bar stock
- Stainless steel retaining ring and spring maximize corrosion resistance and extend service life on the 1-piece sleeve; 2-piece sleeve has a phosphor bronze spring
- Steel componentry is plated using ROHS-compliant trivalent chrome
- Steel couplings have a cast zinc sleeve

Seal Components

- Nitrile (Buna-N) seals are standard, providing a temperature range of -40°F to 250°F (-40°C to 121°C)

Rated Pressure Chart

Body Size	Dual-Lock P-Series Thor Interchange (Connected)											
	Steel Coupler/Plug				Brass Coupler/Plug				303 Stainless Steel Coupler/Plug			
	Max. Working		Burst		Max. Working		Burst		Max. Working		Burst	
	PSI	Bar	PSI	Bar	PSI	Bar	PSI	Bar	PSI	Bar	PSI	Bar
1/2"	300	20	2,600	180	300	20	3,500	240	300	20	4,500	310

Technical Specifications

Body Size	Interchange Standards				Functional Parameters					
	U.S. Military	U.S. Government	International Standards	ANSI/NFPA Standards	Locking Mechanism	Air Inclusion	Fluid Loss	Vacuum Rating	Flow ΔP = 15 PSI	
1/2"	-	-	-	-	Latch Fingers	N/A	N/A	N/R	255 CFM	

Available Options

Body Size	Seals	Sleeve Options			Staked Ferrule Option		
	FKM	Flanged	Lock Clip	1/2" Barb	3/4" Barb	3/4" Stainless Barb	
	Prefix	Suffix	Part #	Suffix	Suffix	Suffix	
1/2"	F-	-FS	4P-CLIP	-WF	-WF	-WF	

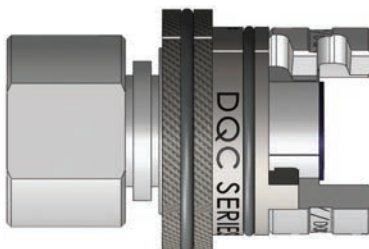

Dual-Lock P Series Coupler with -FS Flanged Sleeve Option

Pneumatic Couplings: Dual-Lock P-Series

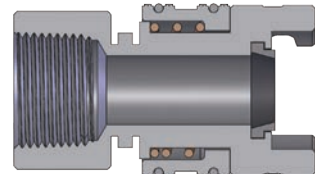
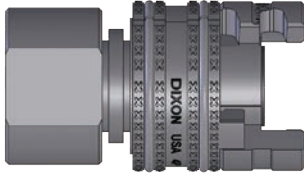

Dual-Lock P-Series Coupler (Female Threads)

Body Size	Dual-Lock P-Series Coupler (Female Threads)							
	Part Detail			Length		Maximum OD		Wrench Flats
	Part #	Threads	Material	Inch	mm	Inch	mm	
1/2"	4PF4	1/2" - 14 NPTF	steel	2.75	69.9	1.55	39.4	1-1/4"
	4PF6	3/4" - 14 NPTF	steel	2.75	69.9	1.55	39.4	1-1/4"
	4PF6-B	3/4" - 14 NPTF	brass	2.75	69.9	1.55	39.4	1-1/4"
	4PF6-S	3/4" - 14 NPTF	303 stainless	2.75	69.9	1.55	39.4	1-1/4"

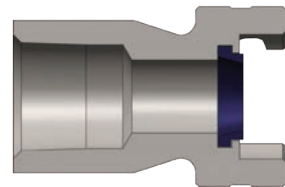
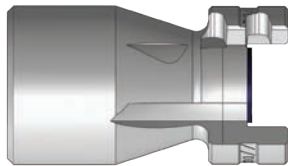

Dual-Lock P-Series Plug (Female Threads)

Body Size	Dual-Lock P-Series Plug (Female Threads)							
	Part Detail			Length		Maximum OD		Wrench Flats
	Part #	Threads	Material	Inch	mm	Inch	mm	
1/2"	P4F3	3/8" - 18 NPTF	steel	1.79	45.5	1.55	39.4	7/8"
	P4F4	1/2" - 14 NPTF	steel	2.25	57.2	1.55	39.4	1-5/16"
	P4F4-B	1/2" - 14 NPTF	brass	2.25	57.2	1.55	39.4	1-5/16"
	P4F6	3/4" - 14 NPTF	steel	2.34	59.4	1.55	39.4	1-5/16"
	P4F6-9	3/4" - 14 NPTF	steel/PTFE coat	2.34	59.4	1.55	39.4	1-5/16"
	P4F6-B	3/4" - 14 NPTF	brass	2.34	59.4	1.55	39.4	1-5/16"
	P4F6-S	3/4" - 14 NPTF	303 stainless	2.34	59.4	1.55	39.4	1-5/16"
	P4F8	1" - 11-1/2 NPTF	steel	2.76	70.1	1.55	39.4	1-7/16"
	P4F8-B	1" - 11-1/2 NPTF	brass	2.76	70.1	1.55	39.4	1-7/16"

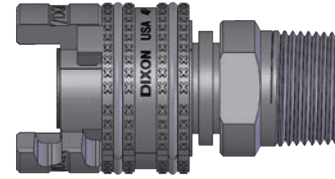
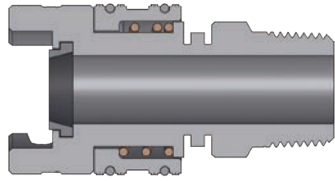

Body Size	Dual-Lock P-Series Coupler (Male Threads)							
	Part Detail			Length		Maximum OD		Wrench Flats
	Part #	Threads	Material	Inch	mm	Inch	mm	
1/2"	4PM3	3/8" - 18 NPTF	steel	2.93	74.4	1.55	39.4	7/8"
	4PM4	1/2" - 14 NPTF	steel	2.94	74.7	1.55	39.4	7/8"
	4PM6	3/4" - 14 NPTF	steel	2.98	75.7	1.55	39.4	1-1/16"
	4PM6-9	3/4" - 14 NPTF	steel/PTFE coat	2.98	75.7	1.55	39.4	1-1/16"
	4PM6-S	3/4" - 14 NPTF	303 stainless	2.98	75.7	1.55	39.4	1-1/16"
	4PM8	1" - 11-1/2 NPTF	steel	3.11	79.0	1.55	39.4	1-3/8"

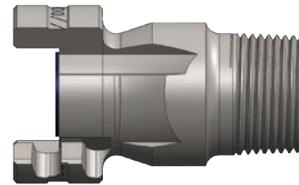
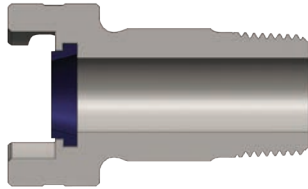

Body Size	Dual-Lock P-Series Plug (Male Threads)							
	Part Detail			Length		Maximum OD		Wrench Flats
	Part #	Threads	Material	Inch	mm	Inch	mm	
1/2"	P4M3	3/8" - 18 NPTF	steel	2.00	50.8	1.55	39.4	7/8"
	P4M4	1/2" - 14 NPTF	steel	2.25	57.2	1.55	39.4	15/16"
	P4M4-B	1/2" - 14 NPTF	brass	2.25	57.2	1.55	39.4	15/16"
	P4M6	3/4" - 14 NPTF	steel	2.55	64.8	1.55	39.4	1-1/8"
	P4M6-9	3/4" - 14 NPTF	steel/PTFE coat	2.55	64.8	1.55	39.4	1-1/8"
	P4M6-B	3/4" - 14 NPTF	brass	2.55	64.8	1.55	39.4	1-1/8"
	P4M6-S	3/4" - 14 NPTF	303 stainless	2.55	64.8	1.55	39.4	1-1/8"
	P4M8	1" - 11-1/2 NPTF	steel	3.25	82.6	1.55	39.4	1-3/8"
	P4M8-B	1" - 11-1/2 NPTF	brass	3.25	82.6	1.55	39.4	1-3/8"

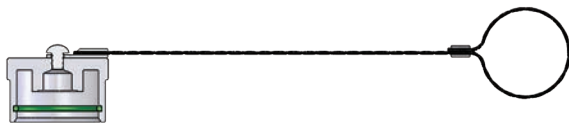

Body Size	Dual-Lock P-Series Cap		
	Part Detail		
	Part #	Cap Lanyard	Material
1/2"	4PDC-A	steel	aluminum

Pneumatic Couplings: Dual-Lock P-Series

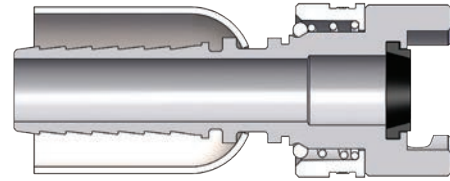
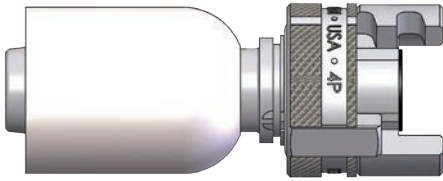

Dual-Lock P-Series Coupler with Ferrule (Hose Barb)

Body Size	Dual-Lock P-Series Coupler with Ferrule (Hose Barb)								
	Part Detail			Hose OD		Length		Maximum OD	
	Part #	Hose ID	Material	From	To	Inch	mm	Inch	mm
1/2"	4PS4-WF	1/2" barb	steel	54/64"	1-2/64"	3.95	100.30	1.55	39.40
	4PS4-B-WF	1/2" barb	brass	54/64"	1-2/64"	3.95	100.30	1.55	39.40
	4PS6-WF	3/4" barb	steel	1-10/64"	1-22/64"	3.95	100.30	1.55	39.40
	4PS6-B-WF	3/4" barb	brass	1-10/64"	1-22/64"	3.95	100.30	1.55	39.40
	4PS6-S-WF	3/4" barb	303 stainless	1-10/64"	1-22/64"	3.95	100.30	1.55	39.40

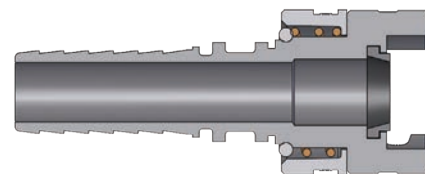

Dual-Lock P-Series Coupler (Hose Barb)

Body Size	Dual-Lock P-Series Coupler (Hose Barb)							
	Part Detail			Length		Maximum OD		Hex Inch
	Part #	Hose ID	Material	Inch	mm	Inch	mm	
1/2"	4PS3	3/8"	steel	3.53	89.7	1.55	39.4	-
	4PS4	1/2"	steel	3.95	100.3	1.55	39.4	-
	4PS4-B	1/2"	brass	3.95	100.3	1.55	39.4	-
	4PS6	3/4"	steel	3.95	100.3	1.55	39.4	-
	4PS6-9	3/4"	steel/PTFE coat	3.95	100.3	1.55	39.4	-
	4PS6-B	3/4"	brass	3.95	100.3	1.55	39.4	-
	4PS6-S	3/4"	303 stainless	3.95	100.3	1.55	39.4	-
	4PS8	1"	steel	6.06	153.9	1.55	39.4	-
	4PS8-B	1"	brass	6.06	153.9	1.55	39.4	-

Dual-Lock P-Series Replacement Seals

Body Size	Part Detail			Seal Kit Contents
	Part #	Coupler Style	Material	
	1/2"	4P-SKIT	all	Nitrile
F-4P-SKIT		all	FKM	sealing gasket

Interchange Data

- Japanese Industrial Interchange Pneumatic Coupling
- Nitto Kohki Hi-Cupla 200, Rectus Series 13, and CEJN Series 315

Materials

- Machined components are manufactured using solid steel bar stock
- Stainless steel springs; carbon steel balls and retaining rings
- Steel componentry is plated using chrome-over-nickel plating

Seal Components

- Nitrile (Buna-N) seals are standard, providing a temperature range of **-40°F to 250°F (-40°C to 121°C)**

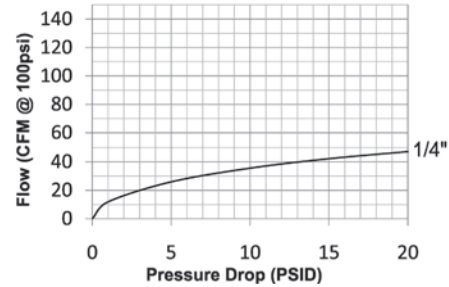

Rated Pressure Chart

Body Size	NK-Series Japanese Industrial Interchange (Connected)			
	Coupler/Plug			
	Maximum Working		Burst	
	PSI	Bar	PSI	Bar
1/4"	300	20	13,500	931

Technical Specifications

Body Size	Interchange Standards				Functional Parameters				
	U.S. Military	U.S. Government	International Standards	ANSI/NFPA Standards	Locking Ball Quantity	Air Inclusion	Fluid Loss	Vacuum Rating	Flow ΔP = 15 PSI
1/4"	-	-	-	-	4	N/A	N/A	N/R	42 CFM

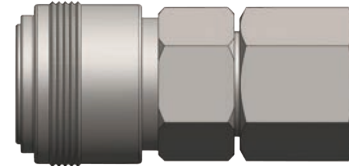
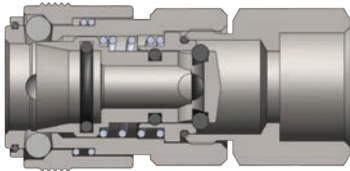

Body Size	NK-Series Japanese Industrial Interchange Coupler (Female Threads)							
	Part Detail			Length		Maximum OD		Hex Inch
	Part #	Threads	Material	Inch	mm	Inch	mm	
1/4"	2NKF2	1/4" - 18 NPT	steel	1.97	50.0	1.02	26.0	3/4"
	2NKBF2	1/4" - 19 BSPP	steel	1.97	50.0	1.02	26.0	3/4"

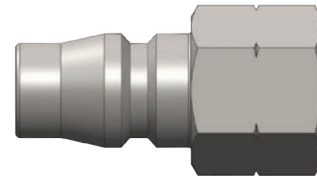
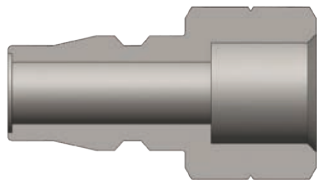

Body Size	NK-Series Japanese Industrial Interchange Plug (Female Threads)							
	Part Detail			Length		Maximum OD		Hex Inch
	Part #	Threads	Material	Inch	mm	Inch	mm	
1/4"	NK2F2	1/4" - 18 NPT	steel	1.39	35.2	0.52	13.1	5/8"
	NK2BF2	1/4" - 19 BSPP	steel	1.39	35.2	0.52	13.1	5/8"

Pneumatic Couplings: NK-Series

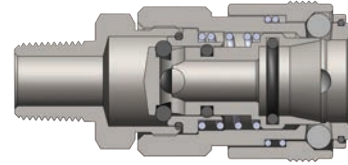
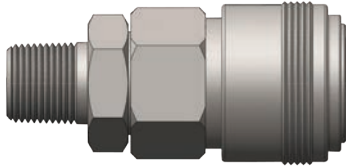

NK-Series Japanese Industrial Interchange Coupler (Male Threads)

Body Size	Part Detail			Length		Maximum OD		Hex Inch
	Part #	Threads	Material	Inch	mm	Inch	mm	
	1/4"	2NKM2	1/4" - 18 NPT	steel	2.12	54.0	1.02	
	2NKBM2	1/4" - 19 BSPT	steel	2.12	54.0	1.02	26.0	3/4"

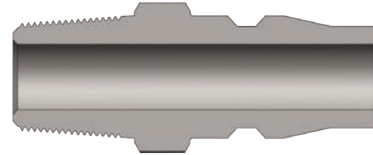
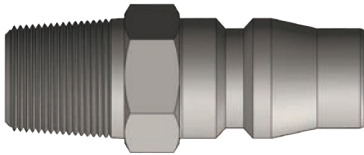

NK-Series Japanese Industrial Interchange Plug (Male Threads)

Body Size	Part Detail			Length		Maximum OD		Hex Inch
	Part #	Threads	Material	Inch	mm	Inch	mm	
	1/4"	NK2M2	1/4" - 18 NPT	steel	1.54	39.2	0.52	
	NK2BM2	1/4" - 19 BSPT	steel	1.54	39.2	0.52	13.1	5/8"

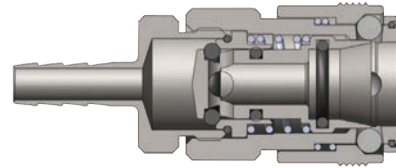
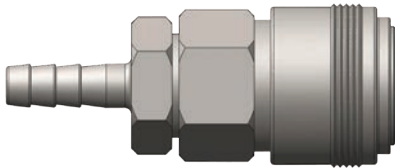

NK-Series Japanese Industrial Interchange Coupler (Hose Barb)

Body Size	Part Detail			Length		Maximum OD		Hex Inch
	Part #	Hose ID	Material	Inch	mm	Inch	mm	
	1/4"	2NKS2	1/4"	steel	2.40	61.0	1.02	

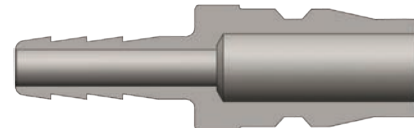
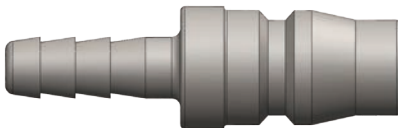

NK-Series Japanese Industrial Interchange Plug (Hose Barb)

Body Size	Part Detail			Length		Maximum OD		Hex Inch
	Part #	Hose ID	Material	Inch	mm	Inch	mm	
	1/4"	NK2S2	1/4"	steel	1.78	45.2	0.44	

Interchange Data

- Rectus 21KA, CEJN Series 223

Materials

- Machined components are manufactured using solid brass bar stock
- Stainless steel springs; carbon steel balls and retaining rings
- Machined components are plated with chrome-over-nickel plating

Seal Components

- Nitrile (Buna-N) seals are standard, providing a temperature range of -40°F to 250°F (-40°C to 121°C)

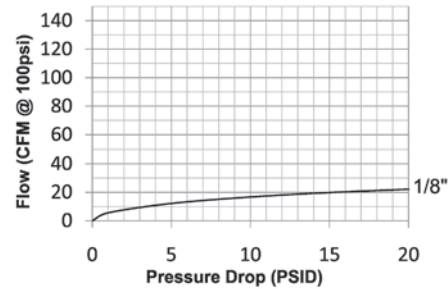

Rated Pressure Chart

Body Size	BR-Series 21-Series Interchange (Connected)			
	Coupler/Plug			
	Maximum Working		Burst	
	PSI	Bar	PSI	Bar
1/8"	300	20	7,000	483

Technical Specifications

Body Size	Interchange Standards				Functional Parameters				
	U.S. Military	U.S. Government	International Standards	ANSI/NFPA Standards	Locking Ball Quantity	Air Inclusion	Fluid Loss	Vacuum Rating	Flow $\Delta P = 15$ PSI
1/4"	-	-	-	-	6	N/A	N/A	N/R	20 CFM

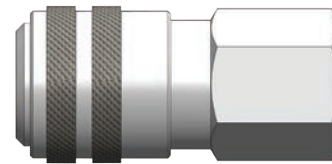
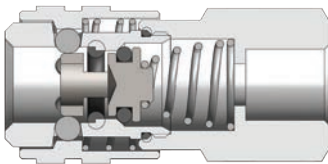

Body Size	BR-Series 21-Series Interchange Coupler (Female Threads)							
	Part Detail			Length		Maximum OD		Hex Inch
	Part #	Threads	Material	Inch	mm	Inch	mm	
1/8"	1BRF1-B-7	1/8" - 27 NPT	brass	1.55	39.4	0.65	16.5	9/16"
	1BRBF1-B-7	1/8" - 28 BSPP	brass	1.55	39.4	0.65	16.5	9/16"
	1BRF2-B-7	1/4" - 18 NPT	brass	1.77	45.0	0.72	18.3	5/8"
	1BRBF2-B-7	1/4" - 19 BSPP	brass	1.77	45.0	0.72	18.3	5/8"

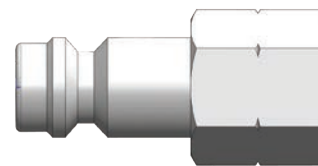
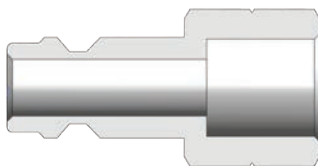

Body Size	BR-Series 21-Series Interchange Plug (Female Threads)							
	Part Detail			Length		Maximum OD		Hex Inch
	Part #	Threads	Material	Inch	mm	Inch	mm	
1/8"	BR1F1-B-E-7	1/8" - 27 NPT	brass	1.14	29.0	0.65	16.5	9/16"
	BR1BF1-B-E-7	1/8" - 28 BSPP	brass	1.14	29.0	0.65	16.5	9/16"
	BR1F2-B-E-7	1/4" - 18 NPT	brass	1.33	33.8	0.72	18.3	5/8"
	BR1BF2-B-E-7	1/4" - 19 BSPP	brass	1.33	33.8	0.72	18.3	5/8"

Pneumatic Couplings: BR-Series

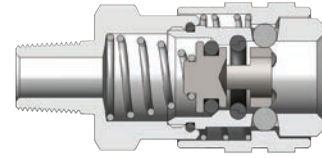
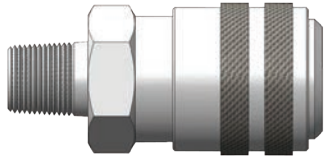

Body Size	BR-Series 21-Series Interchange Coupler (Male Threads)							
	Part Detail			Length		Maximum OD		Hex Inch
	Part #	Threads	Material	Inch	mm	Inch	mm	
1/8"	1BRM1-B-7	1/8" - 27 NPT	brass	1.49	37.8	0.65	16.5	9/16"
	1BRGM1-B-7	1/8" - 28 BSPP	brass	1.49	37.8	0.65	16.5	9/16"
	1BRM2-B-7	1/4" - 18 NPT	brass	1.61	40.9	0.72	18.3	5/8"
	1BRGM2-B-7	1/4" - 19 BSPP	brass	1.61	40.9	0.72	18.3	5/8"

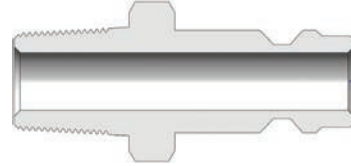
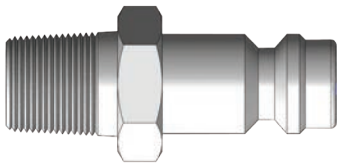

Body Size	BR-Series 21-Series Interchange Plug (Male Threads)							
	Part Detail			Length		Maximum OD		Hex Inch
	Part #	Threads	Material	Inch	mm	Inch	mm	
1/8"	BR1M1-B-E-7	1/8" - 27 NPT	brass	1.06	26.9	0.65	16.5	9/16"
	BR1GM1-B-E-7	1/8" - 28 BSPP	brass	1.06	26.9	0.65	16.5	9/16"
	BR1M2-B-E-7	1/4" - 18 NPT	brass	1.20	30.5	0.72	18.3	5/8"
	BR1GM2-B-E-7	1/4" - 19 BSPP	brass	1.20	30.5	0.72	18.3	5/8"

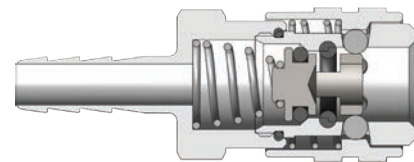
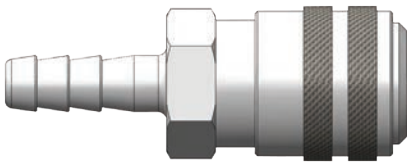

Body Size	BR-Series 21-Series Interchange Coupler (Hose Barb)							
	Part Detail			Length		Maximum OD		Hex Inch
	Part #	Hose ID	Material	Inch	mm	Inch	mm	
1/8"	1BRS1.25-B-7	4mm	brass	1.26	32.0	0.35	8.9	9/16"
	1BRS1.86-B-7	6mm	brass	1.26	32.0	0.35	8.9	9/16"
	1BRS2.83-B-7	9mm	brass	1.26	32.0	0.35	8.9	9/16"

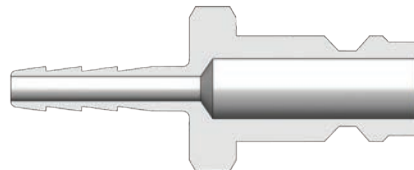
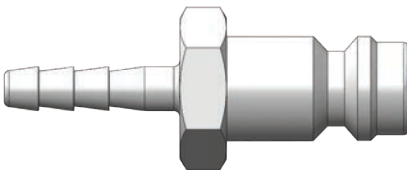

Body Size	BR-Series 21-Series Interchange Plug (Hose Barb)							
	Part Detail			Length		Maximum OD		Hex Inch
	Part #	Hose ID	Material	Inch	mm	Inch	mm	
1/8"	BR1S1.25-B-E-7	4mm	brass	1.26	32.0	0.35	8.9	9/16"
	BR1S1.86-B-E-7	6mm	brass	1.26	32.0	0.35	8.9	9/16"
	BR1S2.83-B-E-7	9mm	brass	1.26	32.0	0.35	8.9	9/16"

Interchange Data

- Dixon Quick Coupling proprietary astronautics compact series

Materials

- Machined components are manufactured using solid steel or brass bar stock
- Stainless steel balls, retaining rings, and springs maximize corrosion resistance and extend service life
- Steel componentry is plated using ROHS-compliant trivalent chrome
- Couplers are constructed of brass with steel valve as standard

Seal Components

- Nitrile (Buna-N) seals are standard, providing a temperature range of -40°F to 250°F (-40°C to 121°C)

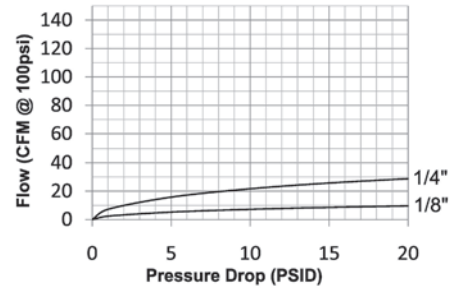

Rated Pressure Chart

Body Size	A-Series Compact (Connected)							
	Brass Coupler/Steel Plug				Brass Coupler/Plug			
	Maximum Working		Burst		Maximum Working		Burst	
	PSI	Bar	PSI	Bar	PSI	Bar	PSI	Bar
1/8"	1,000	70	18,500	1,275	500	35	15,500	1,070
1/4"	1,000	70	8,000	550	500	35	6,500	450

Technical Specifications

Body Size	Interchange Standards				Functional Parameters				
	U.S. Military	U.S. Government	International Standards	ANSI/NFPA Standards	Locking Ball Quantity	Air Inclusion	Fluid Loss	Vacuum Rating	Flow ΔP = 15 PSI
1/8"	-	-	-	-	3	N/A	N/A	N/R	8.6 CFM
1/4"	-	-	-	-	3	N/A	N/A	N/R	26 CFM

Available Options

Body Size	Seal Options		Valve Options			Sleeve Options		Treatments
	FKM	EPDM	Unvalved	Brass	303 SS	Flanged	Sleeve-Lock	Oxy-Clean
	Pre	Pre	Suf	Suf	Suf	Suf	Suf	Suf
1/8"	N/A	N/A	-E	-BV	-SV	N/A	-LS	-C1
1/4"	F-	P-	-E	N/A	N/A	N/A	-LS	-C1

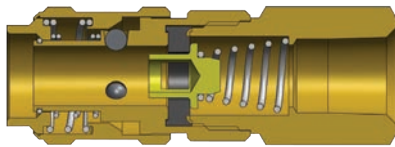

A-Series Compact Coupler (Female Threads)

Body Size	Part Detail							
	Part #	Threads	Material	Length		Maximum OD		Hex Inch
				Inch	mm	Inch	mm	
1/8"	1AF1-B	1/8" - 27 NPTF	brass	1.68	42.7	0.64	16.3	1/2"
1/4"	2AF1-B	1/8" - 27 NPTF	brass	2.41	61.2	0.77	19.6	1/2"
	2AF2-B	1/4" - 18 NPTF	brass	2.70	68.6	0.77	19.6	11/16"

Pneumatic Couplings: A-Series

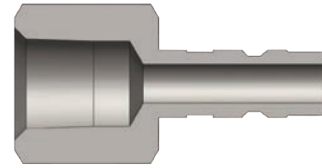
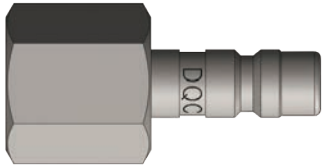

A-Series Compact Plug (Female Threads)

Body Size	A-Series Compact Plug (Female Threads)							
	Part Detail			Length		Maximum OD		Hex Inch
	Part #	Threads	Material	Inch	mm	Inch	mm	
1/8"	A1F1-B	1/8" - 27 NPTF	brass	1.26	32.0	0.58	14.7	1/2"
	A2F1-B	1/8" - 27 NPTF	brass	1.34	34.0	0.65	16.5	9/16"
1/4"	A2F2	1/4" - 18 NPTF	steel	1.56	39.6	0.79	20.1	11/16"
	A2F2-B	1/4" - 18 NPTF	brass	1.56	39.6	0.79	20.1	11/16"

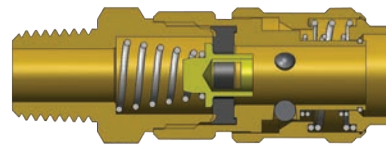
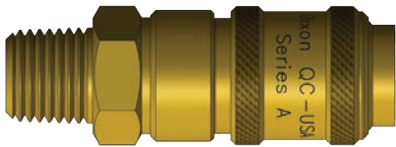

A-Series Compact Coupler (Male Threads)

Body Size	A-Series Compact Coupler (Male Threads)							
	Part Detail			Length		Maximum OD		Hex Inch
	Part #	Threads	Material	Inch	mm	Inch	mm	
1/8"	1AM1-B	1/8" - 27 NPTF	brass	1.75	44.5	0.64	16.3	1/2"
1/4"	2AM1-B	1/8" - 27 NPTF	brass	2.12	53.8	0.77	19.6	11/16"
	2AM2-B	1/4" - 18 NPTF	brass	2.23	56.6	0.77	19.6	11/16"

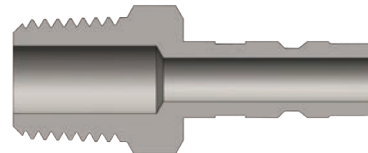
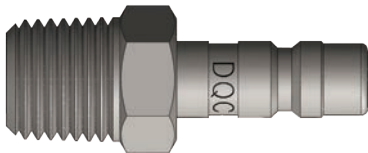

A-Series Compact Plug (Male Threads)

Body Size	A-Series Compact Plug (Male Threads)							
	Part Detail			Length		Maximum OD		Hex Inch
	Part #	Threads	Material	Inch	mm	Inch	mm	
1/8"	A1M1-B	1/8" - 27 NPTF	brass	1.30	33.0	0.51	13.0	7/16"
1/4"	A2M2	1/4" - 18 NPTF	steel	1.59	40.4	0.65	16.5	9/16"
	A2M2-B	1/4" - 18 NPTF	brass	1.59	40.4	0.65	16.5	9/16"

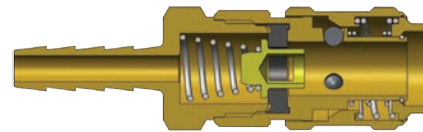
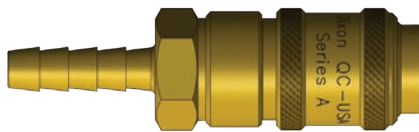

A-Series Compact Coupler (Hose Barb)

Body Size	A-Series Compact Coupler (Hose Barb)							
	Part Detail			Length		Maximum OD		Hex Inch
	Part #	Hose ID	Material	Inch	mm	Inch	mm	
1/8"	1AS1-B	1/8"	brass	1.98	50.3	0.64	16.3	1/2"
1/4"	2AS2-B	1/4"	brass	2.70	68.6	0.77	19.6	11/16"

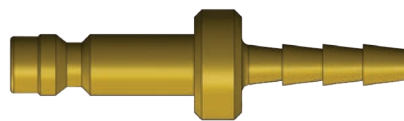
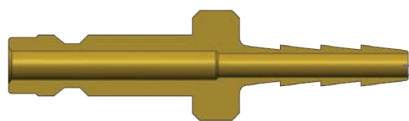

Body Size	A-Series Compact Plug (Hose Barb)							
	Part Detail			Length		Maximum OD		Hex Inch
	Part #	Hose ID	Material	Inch	mm	Inch	mm	
1/8"	A1S1-B	1/8"	brass	1.50	38.1	0.44	11.2	-
1/4"	A2S2	1/4"	steel	1.99	50.5	1.01	25.7	-

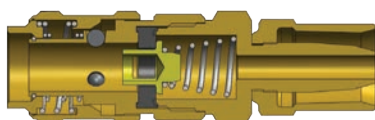

Body Size	A-Series Compact Coupler (Reusable Barb)							
	Part Detail			Length		Maximum OD		Hex Inch
	Part #	Hose ID x OD	Material	Inch	mm	Inch	mm	
1/4"	2AE2-B	1/4" x 1/2"	brass	2.62	66.5	0.77	19.6	11/16"

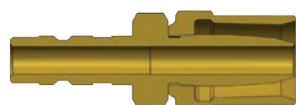

Body Size	A-Series Compact Plug (Reusable Barb)							
	Part Detail			Length		Maximum OD		Hex Inch
	Part #	Hose ID x OD	Material	Inch	mm	Inch	mm	
1/4"	A2E2	1/4" x 1/2"	steel	1.97	50.0	0.68	17.3	9/16"
	A2E2-B	1/4" x 1/2"	brass	1.97	50.0	0.68	17.3	9/16"

A Series Profiles

Body Size	A	B
1/8"	0.22	0.11
1/4"	0.32	0.20

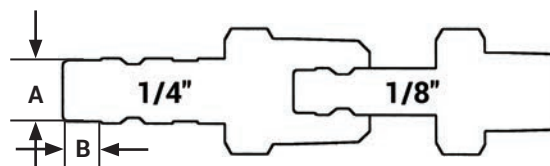

! Operating pressure for couplings utilizing hose barb end connections may be dramatically reduced to that of the hose rating and/or hose end connection combination. Consult hose manufacturer's catalog for hose end connection ratings. If in doubt, test under controlled conditions for suitability to application. Dixon Quick Coupling cannot assume liability for misapplication of production resulting in equipment down-time, lost production, and/or personal injury including death.

Interchange Data

- Hansen FS-Series

Materials

- Machined components are manufactured using solid brass bar stock
- Stainless steel springs and roll-pins maximize corrosion resistance and extend service life

Seal Components

- Nitrile (Buna-N) seals are standard, providing a temperature range of **-40°F to 250°F (-40°C to 121°C)**

Features

- Does not prevent backflow
- High flow design results in maximum flow with minimal pressure drop
- Automatically and instantly protects the operator against hose whip in the event of a damaged hose or coupling
- In the event of a hose rupture or coupling failure, the valve will automatically reset after the problem is fixed
- SCV-Series is available in a large selection of sizes ranging from 1/4" to 3", NPTF (BSPP/BSPT threads on request)
- Valve operation is fully compliant with OSHA Safety Regulation 1926.302(b)(7), as shown on page 11

 Not recommended for applications requiring 100% of the available air supply. These applications include, but are not limited to, sand blast equipment, pile driving rigs, and expansion joint blow down pipes. It is recommended to install auxiliary safety devices, including safety cables, to ensure optimum safety for the operator in the event of a coupling failure or hose rupture.

Use

- Safety check valves operate by using the pressure differential across the valve to operate the valve and spring assembly. The pressure differential is directly related to the flow of air (SCFM) through the valve.
- When the pressure differential is within the operating limits - below the cutoff flow - of the unit, the force on the valve exerted by the spring is greater than that caused by the pressure differential (see "open position" graphic on next page). The valve remains open and normal operation continues.
- When the pressure differential is above the cutoff limit, the force on the valve exerted by the pressure differential is greater than the force exerted by the spring, and the valve closes (see "closed position" graphic on next page).
- After the repair is made, normal operation is automatically enabled when pressure across the valve equalizes through the bleeder hole.
- The valve spring size can be specified by determining the air flow during normal operation and by estimating the air flow if a failure or rupture occurs.

Technical Specifications

Performance Specifications	Maximum Operating Pressure - Bar (PSI)	Minimum Burst Pressure - Bar (PSI)	Air Flow ¹ 30.5m (100')
1/4"	24 (350)	138 (2,000)	17 SCFM
3/8"	24 (350)	138 (2,000)	41 SCFM
1/2"	24 (350)	138 (2,000)	77 SCFM
3/4"	24 (350)	138 (2,000)	178 SCFM
1"	24 (350)	138 (2,000)	340 SCFM
1-1/4"	24 (350)	138 (2,000)	620 SCFM
1-1/2"	24 (350)	138 (2,000)	940 SCFM
2"	24 (350)	138 (2,000)	1,760 SCFM
2-1/2"	24 (350)	138 (1,500)	2,800 SCFM
3"	24 (350)	138 (1,200)	4,200 SCFM

¹Air flow rating is based upon calculated values using unobstructed air flow for the applicable hose size.

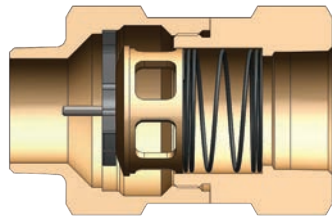

Open

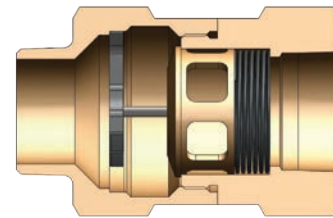

Closed

Body Size	SCV-Series Excessive Flow Sensor (Male to Female Threads)			
	Part Detail			Cutoff Flow - SCFM ¹ (90 PSI Inlet Pressure)
	Part #	Threads	Material	
1/4"	SCVL2	1/4" - 18 NPTF	brass	23-29
3/8"	SCVL3	3/8" - 18 NPTF	brass	30-36
	SCVM3	3/8" - 18 NPTF	brass	39-47
1/2"	SCVS3	3/8" - 18 NPTF	brass	52-65
	SCVM4	1/2" - 14 NPTF	brass	70-78
3/4"	SCVS4	1/2" - 14 NPTF	brass	80-96
	SCVL6	3/4" - 14 NPTF	brass	72-88
	SCVM6	3/4" - 14 NPTF	brass	92-108
	SCVR6	3/4" - 14 NPTF	brass	112-128
	SCVJ6	3/4" - 14 NPTF	brass	132-148
	SCVS6	3/4" - 14 NPTF	brass	160-180
1"	SCVH6	3/4" - 14 NPTF	brass	180-200
	SCVL8	1" - 11-1/2 NPTF	brass	165-195
	SCVM8	1" - 11-1/2 NPTF	brass	220-260
	SCVS8	1" - 11-1/2 NPTF	brass	280-320
1-1/4"	SCVH8	1" - 11-1/2 NPTF	brass	310-340
	SCVL10	1-1/4" - 11-1/2 NPTF	brass	260-290
	SCVM10	1-1/4" - 11-1/2 NPTF	brass	300-340
	SCVS10	1-1/4" - 11-1/2 NPTF	brass	440-500
1-1/2"	SCVH10	1-1/4" - 11-1/2 NPTF	brass	570-630
	SCVL12	1-1/2" - 11-1/2 NPTF	brass	300-360
	SCVM12	1-1/2" - 11-1/2 NPTF	brass	470-530
	SCVX12	1-1/2" - 11-1/2 NPTF	brass	564-602
2"	SCVS12	1-1/2" - 11-1/2 NPTF	brass	640-720
	SCVH12	1-1/2" - 11-1/2 NPTF	brass	750-830
	SCVL16	2" - 11-1/2 NPTF	brass	510-590
	SCVM16	2" - 11-1/2 NPTF	brass	725-825
3"	SCVS16	2" - 11-1/2 NPTF	brass	900-1050
	SCVH16	2" - 11-1/2 NPTF	brass	1100-1200
	SCVL24	3" - 11-1/2 NPTF	brass	1200-1400
3"	SCVS24	3" - 11-1/2 NPTF	brass	2400-2700
	SCVH24	3" - 11-1/2 NPTF	brass	2850-3050

¹Contact Dixon for cutoff flow values at other inlet pressures.

Hydraulic Couplings: H-Series

Interchange Data

- Interchangeable to ISO7241 Series B
- Parker 60-Series, Snap-Tite 72-Series, Hansen HK-Series, Faster Series 'HNV' Eaton/Aeroquip FD45, Stucchi Series IRB/IRBO/IRBX

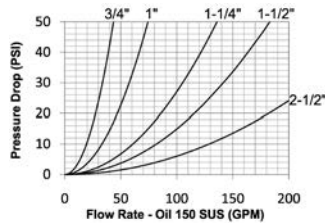
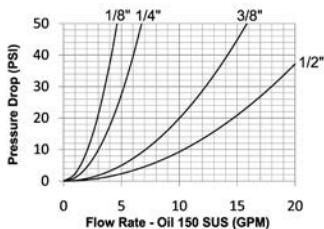

Materials

- Machined components are manufactured using solid steel, brass, 303 stainless steel, or 316 stainless steel bar stock
- Stainless steel balls, retaining rings, and springs maximize corrosion resistance and extend service life
- Steel componentry is plated using ROHS-compliant trivalent chrome
- Steel coupler sleeves are hardened to resist deformation and maximize service life
- Steel plugs are hardened to provide heavy-duty performance and resist brinelling

Seal Components

- Nitrile (Buna-N) seals are standard, providing a temperature range of -40°F to 250°F (-40°C to 121°C)
- 1/8" to 1" couplers have a redundant O-ring sealing system with PTFE backup ring. 1-1/4" to 2-1/2" have a Hytrel backup ring
- 1/4" to 1" valve seals are crimped in place to maintain integrity during excessive flow conditions and pressurized connection

Rated Pressure Chart

Body Size	H-Series ISO-B Interchange (Connected)															
	Steel Coupler/Plug				Brass Coupler/Plug				303 Stainless Coupler/Plug				316 Stainless Coupler/Plug			
	Max. Working		Burst		Max. Working		Burst		Max. Working		Burst		Max. Working		Burst	
	PSI	Bar	PSI	Bar	PSI	Bar	PSI	Bar	PSI	Bar	PSI	Bar	PSI	Bar	PSI	Bar
1/8"	4,000	275	14,500	1,000	3,000	200	16,500	1,100	3,625	250	29,500	2,000	3,625	250	29,500	2,000
1/4"	5,000	345	22,500	1,550	3,000	200	15,000	1,000	3,625	250	31,500	2,150	3,625	250	33,000	2,200
3/8"	4,000	275	16,500	1,150	3,000	200	12,000	800	3,625	250	26,500	1,800	3,625	250	28,000	1,900
1/2"	4,000	275	16,000	1,100	2,500	175	11,500	750	3,625	250	27,500	1,900	3,625	250	22,000	1,500
3/4"	4,000	275	16,500	1,150	2,000	138	12,000	800	3,000	200	16,000	1,100	3,000	200	21,500	1,450
1"	4,000	275	16,000	1,100	1,500	100	8,500	600	2,000	138	15,000	1,000	2,000	138	15,000	1,000
1-1/4"	2,500	170	10,000	700	1,000	70	6,500	450	2,000	138	10,000	700	1,000	70	8,500	580
1-1/2"	2,500	170	12,500	850	1,000	70	6,500	450	1,500	100	8,500	580	1,000	70	7,000	480
2-1/2"	1,500	100	6,000	400	700	50	5,500	380	1,000	70	6,500	450	900	62	6,000	400

Technical Specifications

Body Size	Interchange Standards				Functional Parameters				
	U.S. Military	U.S. Government	International Standards	ANSI/NFPA Standards	Locking Ball Quantity	Air Inclusion	Fluid Loss	Vacuum Inch HG	Flow ΔP = 22 PSI
1/8"	-	-	ISO7241 B	-	8	0.6cc	0.3cc	27.4	3.1 GPM
1/4"	-	-	ISO7241 B	-	8	1.1cc	0.9cc	27.4	4.5 GPM
3/8"	-	-	ISO7241 B	-	9	2.6cc	1.8cc	27.4	12 GPM
1/2"	-	-	ISO7241 B	-	9	3.8cc	2.9cc	27.4	18 GPM
3/4"	-	-	ISO7241 B	-	12	10.8cc	9.7cc	27.4	29 GPM
1"	-	-	ISO7241 B	-	12	15.9cc	15.3cc	27.4	50 GPM
1-1/4"	-	-	ISO7241 B	-	12	30.0cc	45.0cc	N/R	90 GPM
1-1/2"	-	-	ISO7241 B	-	12	60.0cc	75.0cc	N/R	120 GPM
2-1/2"	-	-	ISO7241 B	-	15	N/A	N/A	N/R	195 GPM

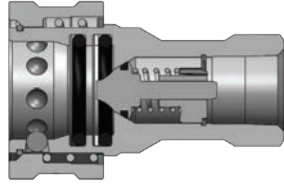

Body Size	H-Series ISO-B Interchange Coupler (Female Threads)							
	Part Detail			Length		Maximum OD		Hex Inch
	Part #	Threads	Material	Inch	mm	Inch	mm	
1/8"	1HF1	1/8" - 27 NPTF	steel	1.90	48.3	0.93	23.6	9/16"
	1HF1-B	1/8" - 27 NPTF	brass	1.90	48.3	0.93	23.6	9/16"
	1HF1-S	1/8" - 27 NPTF	303 stainless	1.90	48.3	0.93	23.6	9/16"
	1HF1-SS	1/8" - 27 NPTF	316 stainless	1.90	48.3	0.93	23.6	9/16"
	1HOF2	7/16" - 20 ORB	steel	1.90	48.3	0.93	23.6	9/16"
1/4"	2HF2	1/4" - 18 NPTF	steel	2.26	57.4	1.12	28.4	7/8"
	2HF2-B	1/4" - 18 NPTF	brass	2.26	57.4	1.12	28.4	7/8"
	2HF2-S	1/4" - 18 NPTF	303 stainless	2.26	57.4	1.12	28.4	7/8"
	2HF2-SS	1/4" - 18 NPTF	316 stainless	2.26	57.4	1.12	28.4	3/4"
	2HBF2	1/4" - 19 BSPP	steel	2.26	57.4	1.12	28.4	7/8"
	2HBF2-B	1/4" - 19 BSPP	brass	2.26	57.4	1.12	28.4	7/8"
	2HBF2-S	1/4" - 19 BSPP	303 stainless	2.26	57.4	1.12	28.4	7/8"
	2HBF2-SS	1/4" - 19 BSPP	316 stainless	2.26	57.4	1.12	28.4	3/4"
	2HOF3	9/16" - 18 ORB	steel	2.29	58.2	1.12	28.4	13/16"
3/8"	3HF3	3/8" - 18 NPTF	steel	2.51	63.8	1.42	36.1	1-1/16"
	3HF3-B	3/8" - 18 NPTF	brass	2.51	63.8	1.42	36.1	1-1/16"
	3HF3-S	3/8" - 18 NPTF	303 stainless	2.51	63.8	1.42	36.1	1-1/16"
	3HF3-SS	3/8" - 18 NPTF	316 stainless	2.51	63.8	1.42	36.1	7/8"
	3HBF3	3/8" - 19 BSPP	steel	2.51	63.8	1.42	36.1	1-1/16"
	3HBF3-B	3/8" - 19 BSPP	brass	2.51	63.8	1.42	36.1	1-1/16"
	3HBF3-S	3/8" - 19 BSPP	303 stainless	2.51	63.8	1.42	36.1	1-1/16"
	3HBF3-SS	3/8" - 19 BSPP	316 stainless	2.51	63.8	1.42	36.1	7/8"
	3HOF4	3/4" - 16 ORB	steel	2.62	66.5	1.42	36.1	1"
1/2"	4HF4	1/2" - 14 NPTF	steel	2.86	72.6	1.86	47.2	1-5/16"
	4HF4-B	1/2" - 14 NPTF	brass	2.86	72.6	1.86	47.2	1-5/16"
	4HF4-S	1/2" - 14 NPTF	303 stainless	2.86	72.6	1.86	47.2	1-5/16"
	4HF4-SS	1/2" - 14 NPTF	316 stainless	2.86	72.6	1.86	47.2	1-1/16"
	4HBF4	1/2" - 14 BSPP	steel	2.86	72.6	1.86	47.2	1-5/16"
	4HBF4-B	1/2" - 14 BSPP	brass	2.86	72.6	1.86	47.2	1-5/16"
	4HBF4-S	1/2" - 14 BSPP	303 stainless	2.86	72.6	1.86	47.2	1-5/16"
	4HBF4-SS	1/2" - 14 BSPP	316 stainless	2.86	72.6	1.86	47.2	1-1/16"
	4HOF5	7/8" - 14 ORB	steel	2.90	73.7	1.86	47.2	1-1/8"
3/4"	6HF6	3/4" - 14 NPTF	steel	3.55	90.2	2.22	56.4	1-5/16"
	6HF6-B	3/4" - 14 NPTF	brass	3.55	90.2	2.22	56.4	1-5/16"
	6HF6-S	3/4" - 14 NPTF	303 stainless	3.55	90.2	2.22	56.4	1-5/16"
	6HF6-SS	3/4" - 14 NPTF	316 stainless	3.55	90.2	2.22	56.4	1-5/16"
	6HBF6	3/4" - 14 BSPP	steel	3.55	90.2	2.22	56.4	1-5/16"
	6HBF6-B	3/4" - 14 BSPP	brass	3.55	90.2	2.22	56.4	1-5/16"
	6HBF6-S	3/4" - 14 BSPP	303 stainless	3.55	90.2	2.22	56.4	1-5/16"
	6HBF6-SS	3/4" - 14 BSPP	316 stainless	3.55	90.2	2.22	56.4	1-5/16"
	6HOF6	1-1/16" - 12 ORB	steel	3.69	93.7	2.22	56.4	1-5/16"
1"	8HF8	1" - 11-1/2 NPTF	steel	4.13	104.9	2.49	63.2	1-5/8"
	8HF8-B	1" - 11-1/2 NPTF	brass	4.13	104.9	2.49	63.2	1-5/8"
	8HF8-S	1" - 11-1/2 NPTF	303 stainless	4.13	104.9	2.49	63.2	1-5/8"
	8HF8-SS	1" - 11-1/2 NPTF	316 stainless	4.13	104.9	2.49	63.2	1-5/8"
	8HBF8	1" - 11 BSPP	steel	4.13	104.9	2.49	63.2	1-5/8"
	8HBF8-B	1" - 11 BSPP	brass	4.13	104.9	2.49	63.2	1-5/8"
	8HBF8-S	1" - 11 BSPP	303 stainless	4.13	104.9	2.49	63.2	1-5/8"
	8HBF8-SS	1" - 11 BSPP	316 stainless	4.13	104.9	2.49	63.2	1-5/8"
	8HOF8	1-5/16" - 12 ORB	steel	4.19	106.3	2.49	63.2	1-5/8"

Hydraulic Couplings: H-Series

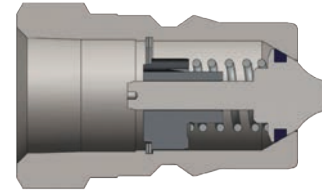

H-Series ISO-B Interchange Plug (Female Threads)

Body Size	H-Series ISO-B Interchange Plug (Female Threads)							
	Part Detail			Length		Maximum OD		Hex Inch
	Part #	Threads	Material	Inch	mm	Inch	mm	
1/8"	H1F1	1/8" - 27 NPTF	steel	1.28	32.5	0.65	16.5	9/16"
	H1F1-B	1/8" - 27 NPTF	brass	1.28	32.5	0.65	16.5	9/16"
	H1F1-S	1/8" - 27 NPTF	303 stainless	1.28	32.5	0.65	16.5	9/16"
	H1F1-SS	1/8" - 27 NPTF	316 stainless	1.28	32.5	0.65	16.5	9/16"
	H1OF2	7/16" - 20 ORB	steel	1.28	32.5	0.65	16.5	9/16"
1/4"	H2F2	1/4" - 18 NPTF	steel	1.55	39.4	0.83	21.1	3/4"
	H2F2-B	1/4" - 18 NPTF	brass	1.55	39.4	0.83	21.1	3/4"
	H2F2-S	1/4" - 18 NPTF	303 stainless	1.55	39.4	0.83	21.1	3/4"
	H2F2-SS	1/4" - 18 NPTF	316 stainless	1.55	39.4	0.83	21.1	3/4"
	H2BF2	1/4" - 19 BSPP	steel	1.55	39.4	0.83	21.1	3/4"
	H2BF2-B	1/4" - 19 BSPP	brass	1.55	39.4	0.83	21.1	3/4"
	H2BF2-S	1/4" - 19 BSPP	303 stainless	1.55	39.4	0.83	21.1	3/4"
	H2BF2-SS	1/4" - 19 BSPP	316 stainless	1.55	39.4	0.83	21.1	3/4"
	H2OF3	9/16" - 18 ORB	steel	1.61	40.9	0.90	22.9	13/16"
3/8"	H3F3	3/8" - 18 NPTF	steel	1.70	43.2	0.97	24.6	7/8"
	H3F3-B	3/8" - 18 NPTF	brass	1.70	43.2	0.97	24.6	7/8"
	H3F3-S	3/8" - 18 NPTF	303 stainless	1.70	43.2	0.97	24.6	7/8"
	H3F3-SS	3/8" - 18 NPTF	316 stainless	1.70	43.2	0.97	24.6	7/8"
	H3BF3	3/8" - 19 BSPP	steel	1.70	43.2	0.97	24.6	7/8"
	H3BF3-B	3/8" - 19 BSPP	brass	1.70	43.2	0.97	24.6	7/8"
	H3BF3-S	3/8" - 19 BSPP	303 stainless	1.70	43.2	0.97	24.6	7/8"
1/2"	H4F4	1/2" - 14 NPTF	steel	1.94	49.3	1.17	29.7	1-1/16"
	H4F4-B	1/2" - 14 NPTF	brass	1.94	49.3	1.17	29.7	1-1/16"
	H4F4-S	1/2" - 14 NPTF	303 stainless	1.94	49.3	1.17	29.7	1-1/16"
	H4F4-SS	1/2" - 14 NPTF	316 stainless	1.94	49.3	1.17	29.7	1-1/16"
	H4BF4	1/2" - 14 BSPP	steel	1.94	49.3	1.17	29.7	1-1/16"
	H4BF4-B	1/2" - 14 BSPP	brass	1.94	49.3	1.17	29.7	1-1/16"
	H4BF4-S	1/2" - 14 BSPP	303 stainless	1.94	49.3	1.17	29.7	1-1/16"
	H4BF4-SS	1/2" - 14 BSPP	316 stainless	1.94	49.3	1.17	29.7	1-1/16"
	H4OF5	7/8" - 14 ORB	steel	1.94	49.3	1.24	31.5	1-1/8"
	3/4"	H6F6	3/4" - 14 NPTF	steel	2.44	61.2	1.50	36.6
H6F6-B		3/4" - 14 NPTF	brass	2.44	61.2	1.50	36.6	1-3/8"
H6F6-S		3/4" - 14 NPTF	303 stainless	2.44	61.2	1.50	36.6	1-3/8"
H6F6-SS		3/4" - 14 NPTF	316 stainless	2.44	61.2	1.50	36.6	1-3/8"
H6BF6		3/4" - 14 BSPP	steel	2.44	61.2	1.50	36.6	1-3/8"
H6BF6-B		3/4" - 14 BSPP	brass	2.44	61.2	1.50	36.6	1-3/8"
H6BF6-S		3/4" - 14 BSPP	303 stainless	2.44	61.2	1.50	36.6	1-3/8"
H6BF6-SS		3/4" - 14 BSPP	316 stainless	2.44	61.2	1.50	36.6	1-3/8"
H6OF6		1-1/16" - 12 ORB	steel	2.58	61.2	1.50	36.6	1-3/8"
1"		H8F8	1" - 11-1/2 NPTF	steel	2.87	72.9	1.79	45.5
	H8F8-B	1" - 11-1/2 NPTF	brass	2.87	72.9	1.79	45.5	1-5/8"
	H8F8-S	1" - 11-1/2 NPTF	303 stainless	2.87	72.9	1.79	45.5	1-5/8"
	H8F8-SS	1" - 11-1/2 NPTF	316 stainless	2.87	72.9	1.79	45.5	1-5/8"
	H8BF8	1" - 11 BSPP	steel	2.87	72.9	1.79	45.5	1-5/8"
	H8BF8-B	1" - 11 BSPP	brass	2.87	72.9	1.79	45.5	1-5/8"
	H8BF8-S	1" - 11 BSPP	303 stainless	2.87	72.9	1.79	45.5	1-5/8"
	H8BF8-SS	1" - 11 BSPP	316 stainless	2.87	72.9	1.79	45.5	1-5/8"
	H8OF8	1-5/16" - 12 ORB	steel	2.87	72.9	1.79	45.5	1-5/8"

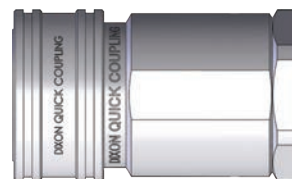
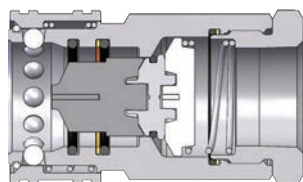

Body Size	H-Series ISO-B High Volume Interchange Coupler (Female Threads)							
	Part Detail			Length		Maximum OD		Hex Inch
	Part #	Threads	Material	Inch	mm	Inch	mm	
1-1/4"	10HF10	1-1/4" - 11-1/2 NPTF	steel	4.43	112.5	2.60	66.0	2-3/8"
	10HF10-B	1-1/4" - 11-1/2 NPTF	brass	4.43	112.5	2.60	66.0	2-3/8"
	10HF10-S	1-1/4" - 11-1/2 NPTF	303 stainless	4.43	112.5	2.60	66.0	2-3/8"
	10HF10-SS	1-1/4" - 11-1/2 NPTF	316 stainless	4.43	112.5	2.60	66.0	2-3/8"
	10HBF10	1-1/4" - 11 BSPP	steel	4.43	112.5	2.60	66.0	2-3/8"
	10HBF10-B	1-1/4" - 11 BSPP	brass	4.43	112.5	2.60	66.0	2-3/8"
	10HBF10-S	1-1/4" - 11 BSPP	303 stainless	4.43	112.5	2.60	66.0	2-3/8"
	10HBF10-SS	1-1/4" - 11 BSPP	316 stainless	4.43	112.5	2.60	66.0	2-3/8"
1-1/2"	12HF10	1-1/4" - 11-1/2 NPTF	steel	4.81	122.2	3.00	76.2	2-5/8"
	12HF10-B	1-1/4" - 11-1/2 NPTF	brass	4.81	122.2	3.00	76.2	2-5/8"
	12HF10-S	1-1/4" - 11-1/2 NPTF	303 stainless	4.81	122.2	3.00	76.2	2-5/8"
	12HF10-SS	1-1/4" - 11-1/2 NPTF	316 stainless	4.81	122.2	3.00	76.2	2-5/8"
	12HOF10	1-5/8" - 12 ORB	steel	4.81	122.2	3.00	76.2	2-5/8"
	12HF12	1-1/2" - 11-1/2 NPTF	steel	4.81	122.2	3.00	76.2	2-5/8"
	12HF12-B	1-1/2" - 11-1/2 NPTF	brass	4.81	122.2	3.00	76.2	2-5/8"
	12HF12-S	1-1/2" - 11-1/2 NPTF	303 stainless	4.81	122.2	3.00	76.2	2-5/8"
	12HF12-SS	1-1/2" - 11-1/2 NPTF	316 stainless	4.81	122.2	3.00	76.2	2-5/8"
	12HBF12	1-1/2" - 11 BSPP	steel	4.81	122.2	3.00	76.2	2-5/8"
	12HBF12-B	1-1/2" - 11 BSPP	brass	4.81	122.2	3.00	76.2	2-5/8"
	12HBF12-S	1-1/2" - 11 BSPP	303 stainless	4.81	122.2	3.00	76.2	2-5/8"
	12HBF12-SS	1-1/2" - 11 BSPP	316 stainless	4.81	122.2	3.00	76.2	2-5/8"
	12HOF12	1-7/8" - 12 ORB	steel	4.81	122.2	3.00	76.2	2-5/8"
2-1/2"	20HF16	2" - 11-1/2 NPTF	steel	5.57	141.5	4.10	104.1	3-3/4"
	20HF16-B	2" - 11-1/2 NPTF	brass	5.57	141.5	4.10	104.1	3-3/4"
	20HF20	2-1/2" - 8 NPTF	steel	6.04	153.4	4.10	104.1	3-3/4"
	20HF24	3" - 8 NPTF	steel	6.96	176.8	4.35	110.5	4"

Hydraulic Couplings: H-Series

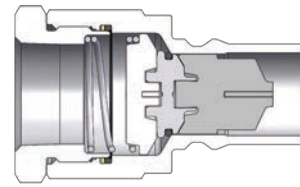

Body Size	H-Series ISO-B High Volume Interchange Plug (Female Threads)							
	Part Detail			Length		Maximum OD		Hex Inch
	Part #	Threads	Material	Inch	mm	Inch	mm	
1-1/4"	H10F10	1-1/4" - 11-1/2 NPTF	steel	4.25	108.0	2.60	66.0	2-3/8"
	H10F10-B	1-1/4" - 11-1/2 NPTF	brass	4.25	108.0	2.60	66.0	2-3/8"
	H10F10-S	1-1/4" - 11-1/2 NPTF	303 stainless	4.25	108.0	2.60	66.0	2-3/8"
	H10F10-SS	1-1/4" - 11-1/2 NPTF	316 stainless	4.25	108.0	2.60	66.0	2-3/8"
	H10BF10	1-1/4" - 11-BSPP	steel	4.25	108.0	2.60	66.0	2-3/8"
	H10BF10-B	1-1/4" - 11-BSPP	brass	4.25	108.0	2.60	66.0	2-3/8"
	H10BF10-S	1-1/4" - 11-BSPP	303 stainless	4.25	108.0	2.60	66.0	2-3/8"
	H10BF10-SS	1-1/4" - 11-BSPP	316 stainless	4.25	108.0	2.60	66.0	2-3/8"
1-1/2"	H12F10	1-1/4" - 11-1/2 NPTF	steel	4.76	120.9	2.88	73.2	2-5/8"
	H12F10-B	1-1/4" - 11-1/2 NPTF	brass	4.76	120.9	2.88	73.2	2-5/8"
	H12F10-S	1-1/4" - 11-1/2 NPTF	303 stainless	4.76	120.9	2.88	73.2	2-5/8"
	H12F10-SS	1-1/4" - 11-1/2 NPTF	316 stainless	4.76	120.9	2.88	73.2	2-5/8"
	H120F10	1-5/8" - 12 ORB	steel	4.76	120.9	2.88	73.2	2-5/8"
	H12F12	1-1/2" - 11-1/2 NPTF	steel	4.76	120.9	2.88	73.2	2-5/8"
	H12F12-B	1-1/2" - 11-1/2 NPTF	brass	4.76	120.9	2.88	73.2	2-5/8"
	H12F12-S	1-1/2" - 11-1/2 NPTF	303 stainless	4.76	120.9	2.88	73.2	2-5/8"
	H12F12-SS	1-1/2" - 11-1/2 NPTF	316 stainless	4.76	120.9	2.88	73.2	2-5/8"
	H12BF12	1-1/2" - 11 BSPP	steel	4.76	120.9	2.88	73.2	2-5/8"
	H12BF12-B	1-1/2" - 11 BSPP	brass	4.76	120.9	2.88	73.2	2-5/8"
	H12BF12-S	1-1/2" - 11 BSPP	303 stainless	4.76	120.9	2.88	73.2	2-5/8"
	H12BF12-SS	1-1/2" - 11 BSPP	316 stainless	4.76	120.9	2.88	73.2	2-5/8"
	H120F12	1-7/8" - 12 ORB	steel	4.76	120.9	2.88	73.2	2-5/8"
2-1/2"	H20F16	2" - 11-1/2 NPTF	steel	5.48	139.2	4.10	104.1	3-3/4"
	H20F16-B	2" - 11-1/2 NPTF	brass	5.48	139.2	4.10	104.1	3-3/4"
	H20F20	2-1/2" - 8 NPTF	steel	5.95	151.1	4.10	104.1	3-3/4"
	H20F24	3" - 8 NPTF	steel	6.87	174.5	4.35	110.5	4"

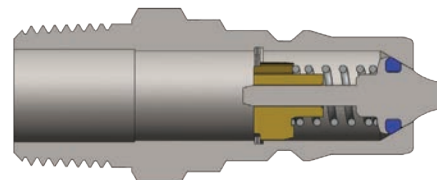

Body Size	H-Series ISO-B Interchange Plug (Male Threads)							
	Part Detail			Length		Maximum OD		Hex Inch
	Part #	Threads	Material	Inch	mm	Inch	mm	
1/4"	H2M3	3/8" - 18 NPTF	steel	2.03	51.6	0.83	21.1	3/4"
1/2"	H4M6-S	3/4" - 14 NPTF	303 stainless	2.13	58.7	1.17	29.7	1-1/16"

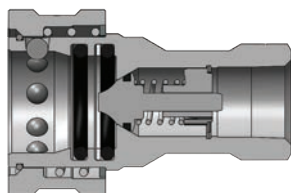

Body Size	H-Series ISO-B Steel Mill 'Slide Gate' Coupler (Female Threads)							
	Part Detail			Length		Maximum OD		Hex Inch
	Part #	Threads	Material	Inch	mm	Inch	mm	
1/2"	4HF4-HV	1/2" - 14 NPTF	steel	2.86	72.6	1.86	47.2	1-1/16"
	F-4HF4-HV	1/2" - 14 NPTF	steel	2.86	72.60	1.86	47.20	1-1/16"

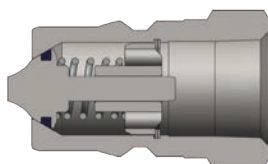

Body Size	H-Series ISO-B Steel Mill 'Slide Gate' Plug (Female Threads)							
	Part Detail			Length		Maximum OD		Hex Inch
	Part #	Threads	Material	Inch	mm	Inch	mm	
1/2"	H4F4-HV	1/2" - 14 NPTF	steel	1.94	49.3	1.17	29.7	1-1/16"
	F-H4F4-HV	1/2" - 14 NPTF	steel	1.94	49.30	1.17	29.70	1-1/16"

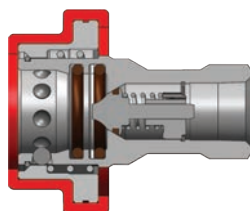

Body Size	H-Series ISO-B Fry Oil Silicone Flanged Coupler (Female Threads)							
	Part Detail			Length		Maximum OD		Hex Inch
	Part #	Threads	Material	Inch	mm	Inch	mm	
1/2"	D-4HF4-S-FSB	1/2" - 14 NPTF	303 stainless	2.86	72.6	2.52	64.0	1-1/16"
	D-4HF4-SS-FSB	1/2" - 14 NPTF	316 stainless	2.86	72.6	2.52	64.0	1-1/16"

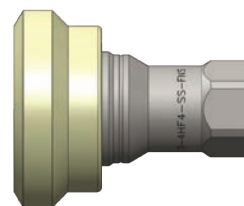
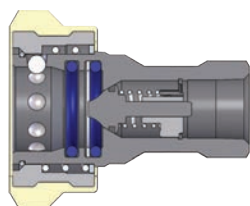

Body Size	H-Series ISO-B Fry Oil Nylon Flanged Coupler (Female Threads)							
	Part Detail			Length		Maximum OD		Hex Inch
	Part #	Threads	Material	Inch	mm	Inch	mm	
1/2"	D-4HF4-S-FNS	1/2" - 14 NPTF	303 stainless	2.86	72.6	2.38	60.5	1-1/16"
	D-4HF4-SS-FNS	1/2" - 14 NPTF	316 stainless	2.86	72.6	2.38	60.5	1-1/16"

Hydraulic Couplings: H-Series

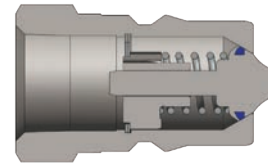

Body Size	H-Series ISO-B Fry Oil Plug (Female Threads)							
	Part Detail			Length		Maximum OD		Hex Inch
	Part #	Threads	Material	Inch	mm	Inch	mm	
1/2"	D-H4F4-SV-8	1/2" - 14 NPTF	steel	1.94	49.3	1.17	29.7	1-1/16"
	D-H4F4-S	1/2" - 14 NPTF	303 stainless	1.94	49.3	1.17	29.7	1-1/16"
	D-H4F4-SS	1/2" - 14 NPTF	316 stainless	1.94	49.3	1.17	29.7	1-1/16"

Available Options

Body Size	Standard Seal Options								Kalrez® Seal Options		
	FKM	EPDM	Steam-EP	FDA FKM	Mil-Nitrile	Fuel Nitrile	PTFE	Silicone	4079	6375	7075
1/8"	F-	P-	N/A	N/A	N/A	N/A	N/A	N/A	K4-	K6-	K7-
1/4"	F-	P-	PS-	D-	M-	JF-	TS-	S-	K4-	K6-	K7-
3/8"	F-	P-	PS-	D-	M-	JF-	TS-	S-	K4-	K6-	K7-
1/2"	F-	P-	PS-	D-	M-	JF-	TS-	S-	K4-	K6-	K7-
3/4"	F-	P-	PS-	D-	M-	JF-	TS-	S-	K4-	K6-	K7-
1"	F-	P-	PS-	D-	M-	JF-	TS-	S-	K4-	K6-	K7-
1-1/4"	F-	P-	PS-	D-	M-	JF-	N/A	S-	K4-	K6-	K7-
1-1/2"	F-	P-	PS-	D-	M-	JF-	N/A	S-	K4-	K6-	K7-
2-1/2"	N/A	N/A	N/A	N/A	N/A	N/A	N/A	N/A	N/A	N/A	N/A

Body Size	Valve Options						Sleeve Options			Treatments
	Unvalved	Actuator ¹	Steel	Brass	303 SS	316 SS	Sleeve-Lock	Flanged	Sil-Flange	Oxy-Clean
1/8"	-E	N/A	-ZV	-BV	N/A	N/A	-LS	N/A	N/A	-C1
1/4"	-E	-VA	-ZV	-BV	-SV	SSV	-LS	-FS	N/A	-C1
3/8"	-E	-VA	-ZV	-BV	-SV	SSV	-LS	-FS	N/A	-C1
1/2"	-E	-VA	-ZV	-BV	-SV	SSV	-LS	-FS	FSB	-C1
3/4"	-E	-VA	-ZV	-BV	-SV	SSV	-LS	-FS	N/A	-C1
1"	-E	-VA	-ZV	-BV	-SV	SSV	-LS	-FS	N/A	-C1
1-1/4"	-E	N/A	-ZV	-BV	-SV	SSV	-LS	N/A	N/A	-C1
1-1/2"	-E	N/A	-ZV	-BV	-SV	SSV	-LS	N/A	N/A	-C1
2-1/2"	N/A	N/A	N/A	N/A	N/A	N/A	N/A	N/A	N/A	N/A

¹ brass valve actuator

H Series Profiles

Body Size	A	B
1/8"	0.43	0.32
1/4"	0.56	0.39
3/8"	0.48	0.50
1/2"	0.92	0.49
3/4"	1.24	0.75
1"	1.49	0.82
1-1/4"	1.49	1.13
1-1/2"	1.75	1.29
2-1/2"	2.50	1.50

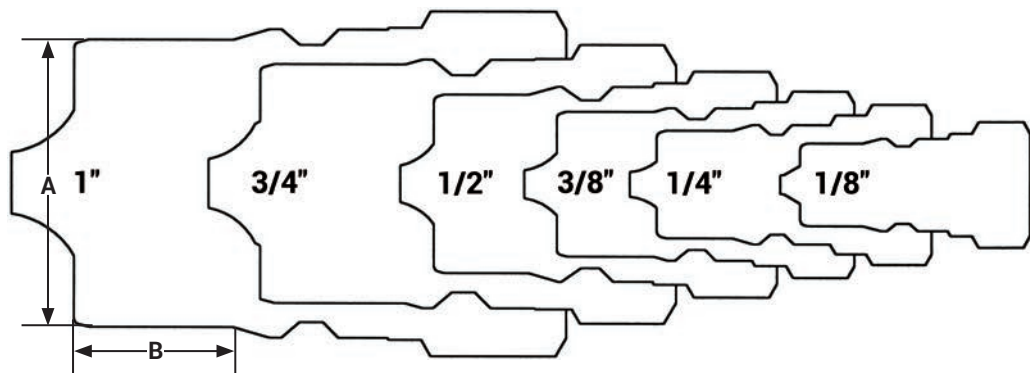



Body Size	H-Series ISO-B Interchange Dust Caps and Plugs		
	Part Detail		
	Coupler Dust Plug	Plug Dust Cap	Material
1/8"	1HDP	H1DC	nitrile
1/4"	2HDP-H2DC combo plug/cap		nitrile
3/8"	3HDP-H3DC combo plug/cap		nitrile
1/2"	4HDP-H4DC combo plug/cap		nitrile
3/4"	6HDP-H6DC combo plug/cap		nitrile
1"	8HDP-H8DC combo plug/cap ¹		nitrile

¹8HDP-H8DC fits both 1" and 1-1/4" body sizes



Body Size	H-Series ISO-B Interchange Coupler Rigid Dust Plug		
	Part Detail		
	Part #	Lanyard	Body
1/4"	2HDP-A	steel cable	aluminum
3/8"	3HDP-A	steel cable	aluminum
1/2"	4HDP-A	steel cable	aluminum
3/4"	6HDP-A	steel cable	aluminum
1"	8HDP-A	steel cable	aluminum
1-1/2"	12HDP-A	steel cable	aluminum
2-1/2"	20HDP-A	steel cable	aluminum

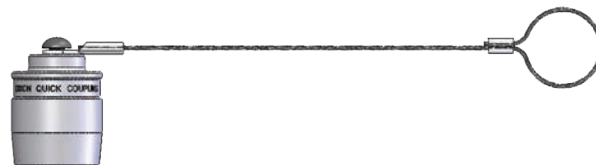

Body Size	H-Series ISO-B Interchange Plug Rigid Dust Cap				
	Part Detail			Package Qty	
	Part #	Lanyard	Body	Bag	Box
1/4"	H2DC-A	steel cable	aluminum	10	50
3/8"	H3DC-A	steel cable	aluminum	10	50
1/2"	H4DC-A	steel cable	aluminum	10	50
3/4"	H6DC-A	steel cable	aluminum	5	25
1"	H8DC-A	steel cable	aluminum	5	25
1-1/2"	H12DC-A	steel cable	aluminum	-	10
2-1/2"	H20DC-A	steel cable	aluminum	-	5

Body Size	H-Series ISO-B Coupler Seal Kits			
	Part Detail			Seal Kit Contents
	Part #	Coupler Style	Seal Material	
1/8"	1H-SKIT	steel, 303 SS, 316 SS, brass	nitrile	two O-rings and one PTFE anti-extrusion ring
	F-1H-SKIT	steel, 303 SS, 316 SS, brass	FKM	two O-rings and one PTFE anti-extrusion ring
	P-1H-SKIT	steel, 303 SS, 316 SS, brass	EPDM	two O-rings and one PTFE anti-extrusion ring
1/4"	2H-SKIT	steel, 303 SS, 316 SS, brass	nitrile	two O-rings and one PTFE anti-extrusion ring
	F-2H-SKIT	steel, 303 SS, 316 SS, brass	FKM	two O-rings and one PTFE anti-extrusion ring
	P-2H-SKIT	steel, 303 SS, 316 SS, brass	EPDM	two O-rings and one PTFE anti-extrusion ring
3/8"	3H-SKIT	steel, 303 SS, 316 SS, brass	nitrile	two O-rings and one PTFE anti-extrusion ring
	F-3H-SKIT	steel, 303 SS, 316 SS, brass	FKM	two O-rings and one PTFE anti-extrusion ring
	P-3H-SKIT	steel, 303 SS, 316 SS, brass	EPDM	two O-rings and one PTFE anti-extrusion ring
1/2"	4H-SKIT	steel, 303 SS, 316 SS, brass	nitrile	two O-rings and one PTFE anti-extrusion ring
	F-4H-SKIT	steel, 303 SS, 316 SS, brass	FKM	two O-rings and one PTFE anti-extrusion ring
	P-4H-SKIT	steel, 303 SS, 316 SS, brass	EPDM	two O-rings and one PTFE anti-extrusion ring
3/4"	6H-SKIT	steel, 303 SS, 316 SS, brass	nitrile	two O-rings and one PTFE anti-extrusion ring
	F-6H-SKIT	steel, 303 SS, 316 SS, brass	FKM	two O-rings and one PTFE anti-extrusion ring
	P-6H-SKIT	steel, 303 SS, 316 SS, brass	EPDM	two O-rings and one PTFE anti-extrusion ring
1"	8H-SKIT	steel, 303 SS, 316 SS, brass	nitrile	two O-rings and one PTFE anti-extrusion ring
	F-8H-SKIT	steel, 303 SS, 316 SS, brass	FKM	two O-rings and one PTFE anti-extrusion ring
	P-8H-SKIT	steel, 303 SS, 316 SS, brass	EPDM	two O-rings and one PTFE anti-extrusion ring
1-1/4"	10H-SKIT	steel, 303 SS, 316 SS, brass	nitrile	adapter/valve O-ring and two body O-rings
	F-10-SKIT	steel, 303 SS, 316 SS, brass	FKM	adapter/valve O-ring and two body O-rings
	P-10-SKIT	steel, 303 SS, 316 SS, brass	EPDM	adapter/valve O-ring and two body O-rings
1-1/2"	12H-SKIT	steel, 303 SS, 316 SS, brass	nitrile	adapter/valve O-ring and two body O-rings
	F-12H-SKIT	steel, 303 SS, 316 SS, brass	FKM	adapter/valve O-ring and two body O-rings
	P-12H-SKIT	steel, 303 SS, 316 SS, brass	EPDM	adapter/valve O-ring and two body O-rings

Body Size	H-Series ISO-B Repair Kits			
	Part Detail			Repair Kit Contents (for one coupler or plug)
	Part #	Coupler Style	Seal Material	
1/4"	2H-RKIT	steel	nitrile	steel valve assembly and retaining ring
	2H-BRKIT	brass	nitrile	brass valve assembly and retaining ring
	2H-SRKIT	303 stainless	nitrile	303 SS valve assembly and retaining ring
	2H-SSRKIT	316 stainless	nitrile	316 SS valve assembly and retaining ring
3/8"	3H-RKIT	steel	nitrile	steel valve assembly and retaining ring
	3H-BRKIT	brass	nitrile	brass valve assembly and retaining ring
	3H-SRKIT	303 stainless	nitrile	303 SS valve assembly and retaining ring
	3H-SSRKIT	316 stainless	nitrile	316 SS valve assembly and retaining ring
1/2"	4H-RKIT	steel	nitrile	steel valve assembly and retaining ring
	4H-BRKIT	brass	nitrile	brass valve assembly and retaining ring
	4H-SRKIT	303 stainless	nitrile	303 SS valve assembly and retaining ring
	4H-SSRKIT	316 stainless	nitrile	316 SS valve assembly and retaining ring
3/4"	6H-RKIT	steel	nitrile	steel valve assembly and retaining ring
	6H-BRKIT	brass	nitrile	brass valve assembly and retaining ring
	6H-SRKIT	303 stainless	nitrile	303 SS valve assembly and retaining ring
	6H-SSRKIT	316 stainless	nitrile	316 SS valve assembly and retaining ring
1"	8H-RKIT	steel	nitrile	steel valve assembly and retaining ring
	8H-BRKIT	brass	nitrile	brass valve assembly and retaining ring
	8H-SRKIT	303 stainless	nitrile	303 SS valve assembly and retaining ring
	8H-SSRKIT	316 stainless	nitrile	316 SS valve assembly and retaining ring
1-1/4"	10H-RKIT	steel	nitrile	steel valve assembly and adapter O-ring
	10H-BRKIT	brass	nitrile	brass valve assembly and adapter O-ring
	10H-SRKIT	303 stainless	nitrile	303 SS valve assembly and adapter O-ring
	10H-SSRKIT	316 stainless	nitrile	316 SS valve assembly and adapter O-ring
1-1/2"	12H-RKIT	steel	nitrile	steel valve assembly and adapter O-ring
	12H-BRKIT	brass	nitrile	brass valve assembly and adapter O-ring
	12H-SRKIT	303 stainless	nitrile	303 SS valve assembly and adapter O-ring
	12H-SSRKIT	316 stainless	nitrile	316 SS valve assembly and adapter O-ring

Hydraulic Couplings: H-BOP-Series

Interchange Data

- Interchangeable to ISO7241 Series B
- Eaton/Hansen HKFR-Series, DNP HNV-BOP-Series

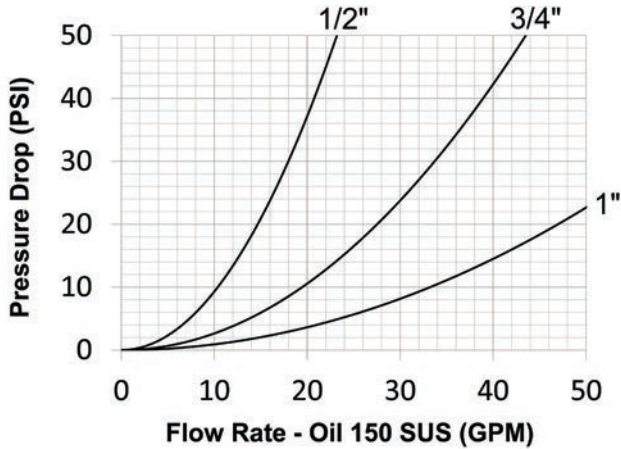

Seal Components

- Blow-out preventer (BOP) couplings contain severe service FKM seals
- PTFE anti-extrusion ring protects main coupling body seal from dynamic impulse pressure damage
- Coupler has redundant O-ring sealing system
- Valve seals are crimped in place to maintain integrity during excessive flow conditions and pressurized connection

Materials

- Machined components are manufactured using solid steel or 316 stainless steel bar stock
- Stainless steel balls, retaining rings, and springs maximize corrosion resistance and extend service life
- Steel componentry is plated using ROHS-compliant zinc-nickel
- Steel coupler sleeves are hardened to resist deformation and maximize service life
- Steel plugs are hardened to provide heavy-duty performance and resist brinelling
- Red powder coated coupler sleeve and plug hex for easy BOP service identification
- Locking sleeve is standard

- BOP couplings have been fire tested and Lloyd's certified to 1300°F (700°C) in accordance with API 16D. Certificate available upon request.
- Use H-Series dust caps and dust plugs found on page 77

Rated Pressure Chart

Body Size	H-BOP-Series Blowout Preventer Safety Interchange									
	Steel Coupler/Plug				316 SS Coupler/Plug				Lloyd's Test Pressure	Flow ΔP = 22 PSI
	Maximum Working		Burst		Maximum Working		Burst			
	PSI	Bar	PSI	Bar	PSI	Bar	PSI	Bar		
3/8"	5,000	345	16,500	1,150	5,000	345	21,500	1,450	5,000	12 GPM
1/2"	5,000	345	16,000	1,100	5,000	345	22,000	1,500	5,000	15 GPM
3/4"	5,000	345	16,500	1,150	5,000	345	21,500	1,450	5,000	29 GPM
1"	5,000	345	16,000	1,100	5,000	345	15,000	1,000	5,000	50 GPM

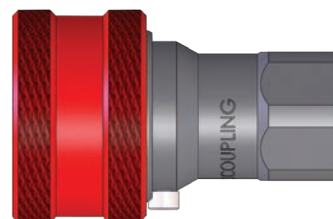
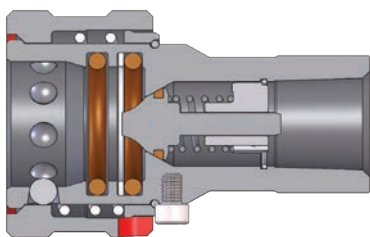

Body Size	H-BOP-Series Blowout Preventer Safety Coupler (Female Threads)							
	Part Detail			Length		Maximum OD		Hex mm
	Part #	Threads	Material	Inch	mm	Inch	mm	
3/8"	3HF3-BOP	3/8" - 18 NPTF	steel	2.50	63.5	1.41	35.8	7/8"
	3HF3-SS-BOP	3/8" - 18 NPTF	316 stainless	2.50	63.5	1.41	35.8	7/8"
1/2"	4HF4-BOP	1/2" - 14 NPTF	steel	2.86	72.6	1.86	47.2	1-5/16"
	4HF4-SS-BOP	1/2" - 14 NPTF	316 stainless	2.86	72.6	1.86	47.2	1-5/16"
3/4"	6HF6-BOP	3/4" - 14 NPTF	steel	3.55	90.2	2.22	56.4	1-5/16"
	6HF6-SS-BOP	3/4" - 14 NPTF	316 stainless	3.55	90.2	2.22	56.4	1-5/16"
1"	8HF8-BOP	1" - 11-1/2 NPTF	steel	4.13	104.9	2.49	63.2	1-5/8"
	8HF8-SS-BOP	1" - 11-1/2 NPTF	316 stainless	4.13	104.9	2.49	63.2	1-5/8"

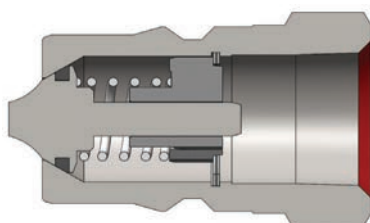

Body Size	H-BOP-Series Blowout Preventer Safety Plug (Female Threads)							
	Part Detail			Length		Maximum OD		Hex mm
	Part #	Threads	Material	Inch	mm	Inch	mm	
3/8"	H3F3-BOP	3/8" - 18 NPTF	steel	1.53	38.9	0.96	24.4	7/8"
	H3F3-SS-BOP	3/8" - 18 NPTF	316 stainless	1.53	38.9	0.96	24.4	7/8"
1/2"	H4F4-BOP	1/2" - 14 NPTF	steel	1.94	49.3	1.17	29.7	1-1/16"
	H4F4-SS-BOP	1/2" - 14 NPTF	316 stainless	1.94	49.3	1.17	29.7	1-1/16"
3/4"	H6F6-BOP	3/4" - 14 NPTF	steel	2.41	61.2	1.44	36.6	1-5/16"
	H6F6-SS-BOP	3/4" - 14 NPTF	316 stainless	2.41	61.2	1.44	36.6	1-5/16"
1"	H8F8-BOP	1" - 11-1/2 NPTF	steel	2.87	72.9	1.79	45.5	1-5/8"
	H8F8-SS-BOP	1" - 11-1/2 NPTF	316 stainless	2.87	72.9	1.79	45.5	1-5/8"

Interchange Data

- Interchangeable to ISO7241 Series B
- Parker 60-Series steam couplings

Materials

- Machined components are manufactured using solid steel, brass, or 303 stainless steel bar stock
- Stainless steel balls, retaining rings, and springs maximize corrosion resistance and extend service life
- Steel componentry is plated using ROHS-compliant trivalent chrome
- Steel plugs are hardened to provide heavy-duty performance and resist brinelling
- All couplers have a steel steam-sleeve as standard

Seal Components

- EPDM steam-grade seals are standard, providing a temperature range of **-70°F to 400°F (-57°C to 204°C)**
- Couplers have a redundant O-ring sealing system (Dual O-rings with PTFE back-up)
- Valve seals are crimped in place to maintain integrity during excessive flow conditions

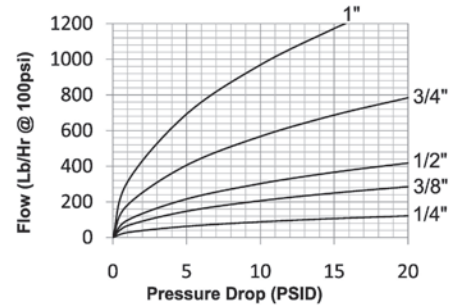

Rated Pressure Chart

Body Size	HS-Series ISO-B Steam Interchange (Connected)															
	Brass Coupler/Plug				Brass Coupler/Steel Plug				Brass Coupler/303 SS Plug				303 SS Coupler/Plug			
	Max. Working		Burst		Max. Working		Burst		Max. Working		Burst		Max. Working		Burst	
	PSI	Bar	PSI	Bar	PSI	Bar	PSI	Bar	PSI	Bar	PSI	Bar	PSI	Bar	PSI	Bar
1/4"	200	14	14,500	1,000	200	14	14,500	1,000	200	14	14,500	1,000	200	14	31,500	2,150
3/8"	200	14	12,000	800	200	14	14,500	1,000	200	14	14,500	1,000	200	14	26,500	1,800
1/2"	200	14	11,500	750	200	14	14,500	1,000	200	14	14,500	1,000	200	14	27,500	1,900
3/4"	200	14	9,280	640	200	14	9,280	640	200	14	9,280	640	200	14	16,000	1,100
1"	200	14	5,800	400	200	14	5,800	400	200	14	5,800	400	200	14	15,000	1,000

Technical Specifications

Body Size	Interchange Standards				Functional Parameters				
	U.S. Military	U.S. Government	International Standards	ANSI/NFPA Standards	Locking Ball Quantity	Air Inclusion	Fluid Loss	Vacuum Inch HG	Flow ΔP = 10 PSI
1/4"	-	-	ISO7241 B	B93.113M-B	8	1.1cc	0.9cc	27.4	88Lbs/Hr
3/8"	-	-	ISO7241 B	B93.113M-B	9	2.6cc	1.8cc	27.4	206Lbs/Hr
1/2"	-	-	ISO7241 B	B93.113M-B	9	3.8cc	2.9cc	27.4	302Lbs/Hr
3/4"	-	-	ISO7241 B	B93.113M-B	12	10.8cc	9.7cc	27.4	567Lbs/Hr
1"	-	-	ISO7241 B	B93.113M-B	12	15.9cc	15.3cc	27.4	968Lbs/Hr

! NOTE: Maximum working pressure has been calculated using saturated steam at **382°F (194°C)** for general purpose continuous steam service. For advanced operating pressure or super-heated steam applications, contact Dixon Quick Coupling for further information.

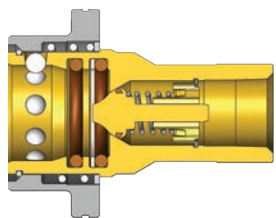

Body Size	H-Series ISO-B Steam Interchange Coupler (Female Threads)							
	Part Detail			Length		Maximum OD		Hex Inch
	Part #	Threads	Material	Inch	mm	Inch	mm	
1/4"	2HSF2-B	1/4" - 18 NPTF	brass	2.26	57.4	1.42	36.1	3/4"
	2HSF2-S	1/4" - 18 NPTF	303 stainless	2.26	57.4	1.42	36.1	3/4"
	2HSBF2-B	1/4" - 19 BSPP	brass	2.26	57.4	1.42	36.1	3/4"
	2HSBF2-S	1/4" - 19 BSPP	303 stainless	2.26	57.4	1.42	36.1	3/4"
3/8"	3HSF3-B	3/8" - 18 NPTF	brass	2.51	63.8	1.73	43.9	7/8"
	3HSF3-S	3/8" - 18 NPTF	303 stainless	2.51	63.8	1.73	43.9	7/8"
	3HSBF3-B	3/8" - 19 BSPP	brass	2.51	63.8	1.73	43.9	7/8"
	3HSBF3-S	3/8" - 19 BSPP	303 stainless	2.51	63.8	1.73	43.9	7/8"
1/2"	4HSF4-B	1/2" - 14 NPTF	brass	2.86	72.6	2.29	58.2	1-1/16"
	4HSF4-S	1/2" - 14 NPTF	303 stainless	2.86	72.6	2.29	58.2	1-1/16"
	4HSBF4-B	1/2" - 14 BSPP	brass	2.86	72.6	2.29	58.2	1-1/16"
	4HSBF4-S	1/2" - 14 BSPP	303 stainless	2.86	72.6	2.29	58.2	1-1/16"
3/4"	6HSF6-B	3/4" - 14 NPTF	brass	3.55	90.2	2.61	66.3	1-5/16"
	6HSF6-S	3/4" - 14 NPTF	303 stainless	3.55	90.2	2.61	66.3	1-5/16"
	6HSBF6-B	3/4" - 14 BSPP	brass	3.55	90.2	2.61	66.3	1-5/16"
	6HSBF6-S	3/4" - 14 BSPP	303 stainless	3.55	90.2	2.61	66.3	1-5/16"
1"	8HSF8-B	1" - 11-1/2 NPTF	brass	4.13	104.9	2.98	75.7	1-5/8"
	8HSF8-S	1" - 11-1/2 NPTF	303 stainless	4.13	104.9	2.98	75.7	1-5/8"
	8HSBF8-B	1" - 11 BSPP	brass	4.13	104.9	2.98	75.7	1-5/8"
	8HSBF8-S	1" - 11 BSPP	303 stainless	4.13	104.9	2.98	75.7	1-5/8"

! Do not disconnect steam couplings while under pressure. Maximum operating temperature for steam service couplings is **382°F (194°C)**, with an intermittent maximum temperature of **400°F (204°C)**. Be sure to use safety chains, or equivalent means, to prevent the line from thrashing around in a case where the coupling becomes disconnected.

Hydraulic Couplings: HS-Series

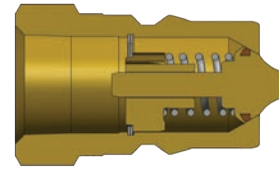

Body Size	H-Series ISO-B Steam Interchange Plug (Female Threads)							
	Part Detail			Length		Maximum OD		Hex Inch
	Part #	Threads	Material	Inch	mm	Inch	mm	
1/4"	HS2F2	1/4" - 18 NPTF	steel	1.55	39.4	0.83	21.1	3/4"
	HS2F2-B	1/4" - 18 NPTF	brass	1.55	39.4	0.83	21.1	3/4"
	HS2F2-S	1/4" - 18 NPTF	303 stainless	1.55	39.4	0.83	21.1	3/4"
	HS2BF2	1/4" - 19 BSPP	steel	1.55	39.4	0.83	21.1	3/4"
	HS2BF2-B	1/4" - 19 BSPP	brass	1.55	39.4	0.83	21.1	3/4"
	HS2BF2-S	1/4" - 19 BSPP	303 stainless	1.55	39.4	0.83	21.1	3/4"
3/8"	HS3F3	3/8" - 18 NPTF	steel	1.70	43.2	0.97	24.6	7/8"
	HS3F3-B	3/8" - 18 NPTF	brass	1.70	43.2	0.97	24.6	7/8"
	HS3F3-S	3/8" - 18 NPTF	303 stainless	1.70	43.2	0.97	24.6	7/8"
	HS3BF3	3/8" - 19 BSPP	steel	1.70	43.2	0.97	24.6	7/8"
	HS3BF3-B	3/8" - 19 BSPP	brass	1.70	43.2	0.97	24.6	7/8"
	HS3BF3-S	3/8" - 19 BSPP	303 stainless	1.70	43.2	0.97	24.6	7/8"
1/2"	HS4F4	1/2" - 14 NPTF	steel	1.94	49.3	1.17	29.7	1-1/16"
	HS4F4-B	1/2" - 14 NPTF	brass	1.94	49.3	1.17	29.7	1-1/16"
	HS4F4-S	1/2" - 14 NPTF	303 stainless	1.94	49.3	1.17	29.7	1-1/16"
	HS4BF4	1/2" - 14 BSPP	steel	1.94	49.3	1.17	29.7	1-1/16"
	HS4BF4-B	1/2" - 14 BSPP	brass	1.94	49.3	1.17	29.7	1-1/16"
	HS4BF4-S	1/2" - 14 BSPP	303 stainless	1.94	49.3	1.17	29.7	1-1/16"
3/4"	HS6F6	3/4" - 14 NPTF	steel	2.41	61.2	1.44	36.6	1-5/16"
	HS6F6-B	3/4" - 14 NPTF	brass	2.41	61.2	1.44	36.6	1-5/16"
	HS6F6-S	3/4" - 14 NPTF	303 stainless	2.41	61.2	1.44	36.6	1-5/16"
	HS6BF6	3/4" - 14 BSPP	steel	2.41	61.2	1.44	36.6	1-5/16"
	HS6BF6-B	3/4" - 14 BSPP	brass	2.41	61.2	1.44	36.6	1-5/16"
	HS6BF6-S	3/4" - 14 BSPP	303 stainless	2.41	61.2	1.44	36.6	1-5/16"
1"	HS8F8	1" - 11-1/2 NPTF	steel	2.87	72.9	1.79	45.5	1-5/8"
	HS8F8-B	1" - 11-1/2 NPTF	brass	2.87	72.9	1.79	45.5	1-5/8"
	HS8F8-S	1" - 11-1/2 NPTF	303 stainless	2.87	72.9	1.79	45.5	1-5/8"
	HS8BF8	1" - 11 BSPP	steel	2.87	72.9	1.79	45.5	1-5/8"
	HS8BF8-B	1" - 11 BSPP	brass	2.87	72.9	1.79	45.5	1-5/8"
	HS8BF8-S	1" - 11 BSPP	303 stainless	2.87	72.9	1.79	45.5	1-5/8"

Hydraulic Couplings: K-Series

Interchange Data

- Interchangeable to ISO7241 Series A
- Parker 6600-Series and Eaton/Aeroquip FD56 (5600)
- Faster ANV and Safeway S56-Series

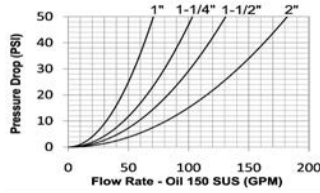
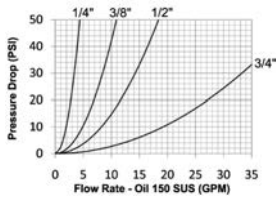

Materials

- Machined components are manufactured using solid steel bar stock or 316 stainless steel bar stock
- Stainless steel balls, retaining rings, and springs maximize corrosion resistance and extend service life
- Steel componentry is plated using ROHS-compliant trivalent chrome
- Steel coupler sleeves are hardened to resist deformation and maximize service life
- Steel plugs are hardened to provide heavy-duty performance and resist brinelling

Seal Components

- Nitrile (Buna-N) seals are standard, providing a temperature range of **-40°F to 250°F (-40°C to 121°C)**
- Couplers have a PTFE anti-extrusion ring
- Valve seals are crimped in place to maintain integrity during excessive flow conditions and pressurized connection

Rated Pressure Chart

Body Size	K-Series ISO-A Interchange (Connected)							
	Steel Coupler/Plug							
	Maximum Working				Burst			
	Steel PSI	Steel Bar	316 Stainless Steel PSI	316 Stainless Steel Bar	Steel PSI	Steel Bar	316 Stainless Steel PSI	316 Stainless Steel Bar
1/4"	5,000	345	4,500	300	18,270	1,200	30,500	2,100
3/8"	4,000	275	3,750	250	16,000	1,100	16,000	1,100
1/2"	4,000	275	3,750	250	16,500	1,100	18,000	1,200
3/4"	4,000	275	3,000	200	14,800	1,000	12,000	800
1"	4,000	275	3,000	200	12,400	850	12,000	800
1-1/4"	3,000	200	-	-	12,600	850	-	-
1-1/2"	3,000	200	-	-	12,600	850	-	-
2"	1,450	100	-	-	5,800	400	-	-

Technical Specifications

Body Size	Interchange Standards				Functional Parameters				
	U.S. Military	U.S. Government	International Standards	ANSI/NFPA Standards	Locking Ball Quantity	Air Inclusion	Fluid Loss	Vacuum Inch HG	Flow ΔP = 22 PSI
1/4"	-	-	ISO7241 A	-	6	0.6cc	0.3cc	26.5	2.9 GPM
3/8"	-	-	ISO7241 A	-	9	2.6cc	1.8cc	26.5	7 GPM
1/2"	-	-	ISO7241 A	-	9	3.8cc	2.9cc	26.5	12 GPM
3/4"	-	-	ISO7241 A	-	12	10.8cc	9.7cc	26.5	28 GPM
1"	-	-	ISO7241 A	-	15	15.9cc	15.3cc	26.5	50 GPM
1-1/4"	-	-	ISO7241 A	-	16	31.7cc	29.1cc	26.5	70 GPM
1-1/2"	-	-	ISO7241 A	-	16	56.4cc	52.2cc	26.5	90 GPM
2"	-	-	ISO7241 A	-	15	N/A	N/A	26.5	120 GPM

Available Options

Body Size	Standard Seal Options						Kalrez® Seal Options		
	FKM	EPDM	FDA FKM	Mil-Nitrile	Fuel Nitrile	Silicone	4079	6375	7075
1/4"	F-	P-	D-	M-	JF-	S-	K4-	K6-	K7-
3/8"	F-	P-	D-	M-	JF-	S-	K4-	K6-	K7-
1/2"	F-	P-	D-	M-	JF-	S-	K4-	K6-	K7-
3/4"	F-	P-	D-	M-	JF-	S-	K4-	K6-	K7-
1"	F-	P-	D-	M-	JF-	S-	K4-	K6-	K7-
1-1/4"	N/A	N/A	N/A	N/A	N/A	N/A	N/A	N/A	N/A
1-1/2"	N/A	N/A	N/A	N/A	N/A	N/A	N/A	N/A	N/A
2"	N/A	N/A	N/A	N/A	N/A	N/A	N/A	N/A	N/A

Body Size	Valve Options						Sleeve	Treatments
	Unvalved	Actuator ¹	Steel	Brass	303 SS	316 SS	Locking	Oxy-Clean
1/4"	-E	N/A	-ZV	-BV	N/A	N/A	-LS	-C1
3/8"	-E	-VA	-ZV	-BV	-SV	SSV	-LS	-C1
1/2"	-E	-VA	-ZV	-BV	-SV	SSV	-LS	-C1
3/4"	-E	-VA	-ZV	-BV	-SV	SSV	-LS	-C1
1"	-E	-VA	-ZV	-BV	-SV	SSV	-LS	-C1
1-1/4"	N/A	N/A	-ZV	N/A	N/A	N/A	N/A	N/A
1-1/2"	N/A	N/A	-ZV	N/A	N/A	N/A	N/A	N/A
2"	N/A	N/A	-ZV	N/A	N/A	N/A	N/A	N/A

¹Brass valve actuator

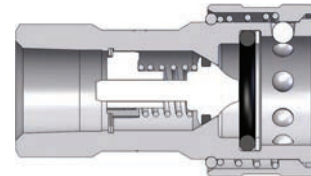
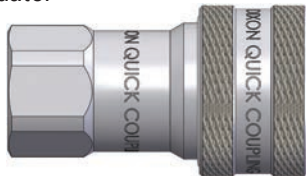

Body Size	K-Series ISO-A Interchange Coupler (Female Threads)							
	Part Detail			Length		Maximum OD		Hex Inch
	Part #	Threads	Material	Inch	mm	Inch	mm	
1/4"	2KF1	1/8" - 27 NPTF	steel	1.89	47.9	1.00	25.4	3/4"
	2KF2	1/4" - 18 NPTF	steel	1.89	47.9	1.00	25.4	3/4"
	2KF2-SS	1/4" - 18 NPTF	316 stainless	1.89	47.9	1.00	25.4	3/4"
	2KBF2	1/4" - 19 BSPP	steel	1.89	47.9	1.00	25.4	3/4"
	2KBF2-SS	1/4" - 19 BSPP	316 stainless	1.89	47.9	1.00	25.4	3/4"
	2KOF2	7/16" - 20 ORB	steel	1.89	47.9	1.00	25.4	3/4"
3/8"	3KF3	3/8" - 18 NPTF	steel	2.23	56.5	1.19	30.2	7/8"
	3KF3-SS	3/8" - 18 NPTF	316 stainless	2.23	56.5	1.19	30.2	7/8"
	3KBF3	3/8" - 19 BSPP	steel	2.23	56.6	1.19	30.2	7/8"
	3KBF3-SS	3/8" - 19 BSPP	316 stainless	2.23	56.6	1.19	30.2	7/8"
	3KOF3	9/16" - 18 ORB	steel	2.23	56.6	1.19	30.2	7/8"
1/2"	4KF4	1/2" - 14 NPTF	steel	2.62	66.5	1.49	37.8	1-1/16"
	4KF4-SS	1/2" - 14 NPTF	316 stainless	2.62	66.5	1.49	37.8	1-1/16"
	4KBF4	1/2" - 14 BSPP	steel	2.62	66.5	1.49	37.8	1-1/16"
	4KBF4-SS	1/2" - 14 BSPP	316 stainless	2.62	66.5	1.49	37.8	1-1/16"
	4KOF4	3/4" - 16 ORB	steel	2.62	66.5	1.49	37.8	1-1/16"
	4KOF5	7/8" - 14 ORB	steel	2.66	67.6	1.49	37.8	1-3/32"
	4KF6	3/4" - 14 NPTF	steel	2.64	66.9	1.49	37.8	1-5/16"

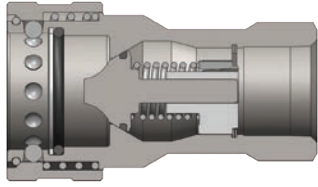

Body Size	K-Series ISO-A Interchange Coupler (Female Threads)							
	Part Detail			Length		Maximum OD		Hex Inch
	Part #	Threads	Material	Inch	mm	Inch	mm	
3/4"	6KF6	3/4" - 14 NPTF	steel	3.23	82.0	1.86	47.2	1-5/16"
	6KF6-SS	3/4" - 14 NPTF	316 stainless	3.23	82.0	1.86	47.2	1-5/16"
	6KBF6	3/4" - 14 BSPP	steel	3.23	82.0	1.86	47.2	1-5/16"
	6KBF6-SS	3/4" - 14 BSPP	316 stainless	3.23	82.0	1.86	47.2	1-5/16"
	6KOF6	1-1/16" - 12 ORB	steel	3.23	82.0	1.86	47.2	1-5/16"
1"	8KF8	1" - 11-1/2 NPTF	steel	3.88	98.6	2.10	53.3	1-5/8"
	8KF8-SS	1" - 11-1/2 NPTF	316 stainless	3.88	98.6	2.10	53.3	1-5/8"
	8KBF8	1" - 11 BSPP	steel	3.88	98.6	2.10	53.3	1-5/8"
	8KBF8-SS	1" - 11 BSPP	316 stainless	3.88	98.6	2.10	53.3	1-5/8"
	8KOF8	1-5/16" - 12 ORB	steel	3.88	98.6	2.10	53.3	1-5/8"

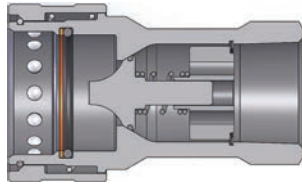

Body Size	K-Series ISO-A Interchange Coupler (Female Threads)							
	Part Detail			Length		Maximum OD		Hex Inch
	Part #	Threads	Material	Inch	mm	Inch	mm	
1-1/4"	10KF10	1-1/4" - 11-1/2 NPT	steel	4.61	117.0	2.76	70.0	2"
	10KBF10	1-1/4" - 11 BSPP	steel	4.61	117.0	2.76	70.0	2"
1-1/2"	12KF12	1-1/2" - 11-1/2 NPT	steel	5.24	133.0	3.33	84.5	2-3/8"
	12KBF12	1-1/2" - 11 BSPP	steel	5.24	133.0	3.33	84.5	2-3/8"
2"	16KF16	2" - 11-1/2 NPT	steel	6.50	165.0	3.94	100.0	3"
	16KBF16	2" - 11 BSPP	steel	6.50	165.0	3.94	100.0	3"

Body Size	A	B
1/4"	0.46	0.17
3/8"	0.68	0.29
1/2"	0.81	0.37
3/4"	1.14	0.55
1"	1.35	0.66
1-1/4"	1.77	0.98
1-1/2"	2.16	1.21
2"	2.56	1.38

K Profiles

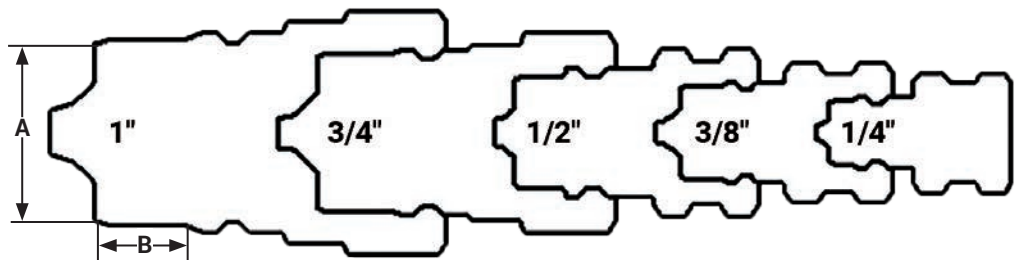

Hydraulic Couplings: K-Series

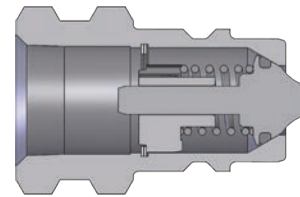
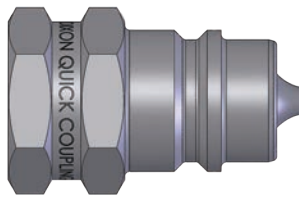

Body Size	K-Series ISO-A Interchange Plug (Female Threads)							
	Part Detail			Length		Maximum OD		Hex Inch
	Part #	Threads	Material	Inch	mm	Inch	mm	
1/4"	K2F1	1/8" - 27 NPTF	steel	1.22	31.0	0.87	22.1	3/4"
	K2F2	1/4" - 18 NPTF	steel	1.22	31.0	0.87	22.1	3/4"
	K2F2-SS	1/4" - 18 NPTF	316 stainless	1.22	31.0	0.87	22.1	3/4"
	K2BF2	1/4" - 19 BSPP	steel	1.22	31.0	0.87	22.1	3/4"
	K2BF2-SS	1/4" - 19 BSPP	316 stainless	1.22	31.0	0.87	22.1	3/4"
	K2OF2	7/16" - 20 ORB	steel	1.22	31.0	0.87	22.1	3/4"
3/8"	K3F3	3/8" - 18 NPTF	steel	1.70	43.2	0.97	24.6	7/8"
	K3F3-SS	3/8" - 18 NPTF	316 stainless	1.70	43.2	0.97	24.6	7/8"
	K3BF3	3/8" - 19 BSPP	steel	1.70	43.2	0.97	24.6	7/8"
	K3BF3-SS	3/8" - 19 BSPP	316 stainless	1.70	43.2	0.97	24.6	7/8"
	K3OF3	9/16" - 18 ORB	steel	1.70	43.2	0.97	24.6	7/8"
1/2"	K4F4	1/2" - 14 NPTF	steel	1.77	45.0	1.23	31.2	1-1/16"
	K4F4-SS	1/2" - 14 NPTF	316 stainless	1.77	45.0	1.23	31.2	1-1/16"
	K4BF4	1/2" - 14 BSPP	steel	1.77	45.0	1.23	31.2	1-1/16"
	K4BF4-SS	1/2" - 14 BSPP	316 stainless	1.77	45.0	1.23	31.2	1-1/16"
	K4OF4	3/4" - 16 ORB	steel	1.77	45.0	1.23	31.2	1-1/16"
	K4OF5	7/8" - 14 ORB	steel	1.77	45.0	1.23	31.2	1-1/16"
	K4F6	3/4" - 14 NPTF	steel	1.77	45.0	1.37	34.8	1-3/16"

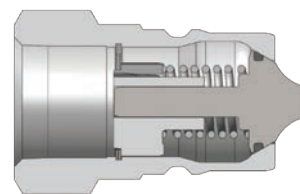
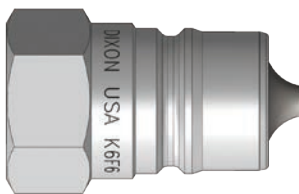

Body Size	K-Series ISO-A Interchange Plug (Female Threads)							
	Part Detail			Length		Maximum OD		Hex Inch
	Part #	Threads	Material	Inch	mm	Inch	mm	
3/4"	K6F6	3/4" - 14 NPTF	steel	2.43	61.7	1.44	36.6	1-5/16"
	K6F6-SS	3/4" - 14 NPTF	316 stainless	2.43	61.7	1.44	36.6	1-5/16"
	K6BF6	3/4" - 14 BSPP	steel	2.43	61.7	1.44	36.6	1-5/16"
	K6BF6-SS	3/4" - 14 BSPP	316 stainless	2.43	61.7	1.44	36.6	1-5/16"
	K6OF6	1-1/16" - 12 ORB	steel	2.43	61.7	1.44	36.6	1-5/16"
1"	K8F8	1" - 11-1/2 NPTF	steel	2.87	72.9	1.79	45.5	1-5/8"
	K8F8-SS	1" - 11-1/2 NPTF	316 stainless	2.87	72.9	1.79	45.5	1-5/8"
	K8BF8	1" - 11 BSPP	steel	2.87	72.9	1.79	45.5	1-5/8"
	K8BF8-SS	1" - 11 BSPP	316 stainless	2.87	72.9	1.79	45.5	1-5/8"
	K8OF8	1-5/16" - 12 ORB	steel	2.87	72.9	1.79	45.5	1-5/8"
1-1/4"	K10F10	1-1/4" - 11-1/2 NPT	steel	2.95	75.0	2.31	58.7	2"
	K10BF10	1-1/4" - 11 BSPP	steel	2.95	75.0	2.31	58.7	2"
1-1/2"	K12F12	1-1/2" - 11-1/2 NPT	steel	3.29	83.5	2.74	69.6	2-3/8"
	K12BF12	1-1/2" - 11 BSPP	steel	3.29	83.5	2.74	69.6	2-3/8"
2"	K16F16	2" - 11-1/2 NPT	steel	4.13	105.0	3.46	87.9	3"
	K16BF16	2" - 11 BSPP	steel	4.13	105.0	3.46	87.9	3"



Body Size	K-Series ISO-A Interchange Combination Dust Cap and Plug		
	Part Detail		
	Combination dust plug and cap		Material
1/4"	2KDP-K2DC		nitrile
3/8"	3KDP-K3DC		nitrile
1/2"	see below		
3/4"	6KDP-K6DC		nitrile
1"	8KDP-K8DC		nitrile



Body Size	K-Series ISO-A Interchange Color-Coded Dust Plug		
	Part Detail		
	Part #	Color	Material
1/2"	4KDP	black	nitrile
	4K-R-DP	red	nitrile
	4K-O-DP	orange	nitrile
	4K-Y-DP	yellow	nitrile
	4K-G-DP	green	nitrile
	4K-B-DP	blue	nitrile



Body Size	K-Series ISO-A Interchange Color-Coded Dust Cap		
	Part Detail		
	Part #	Color	Material
1/2"	K4DC	black	nitrile
	K4-R-DC	red	nitrile
	K4-O-DC	orange	nitrile
	K4-Y-DC	yellow	nitrile
	K4-G-DC	green	nitrile
	K4-B-DC	blue	nitrile

Hydraulic Couplings: K-Series

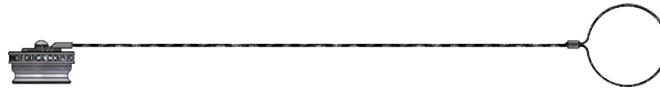

Body Size	K-Series ISO-A-Series Dust Plug		
	Part Detail		
	Part #	Lanyard	Body
1-1/4"	10KDP-A	steel cable	aluminum
1-1/2"	12KDP-A	steel cable	aluminum
2"	16KDP-A	steel cable	aluminum

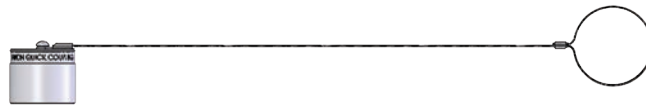

Body Size	K-Series ISO-A-Series Dust Cap		
	Part Detail		
	Part #	Lanyard	Body
1-1/4"	K10DC-A	steel cable	aluminum
1-1/2"	K12DC-A	steel cable	aluminum
2"	K16DC-A	steel cable	aluminum

Body Size	K-Series ISO-A Coupler Seal Kits			
	Part Detail			Seal Kit Contents
	Part #	Coupler Style	Seal Material	
1/4"	2K-SKIT	all	Nitrile	O-ring and PTFE anti-extrusion ring
3/8"	3K-SKIT	all	Nitrile	O-ring and PTFE anti-extrusion ring
1/2"	4K-SKIT	all	Nitrile	O-ring and PTFE anti-extrusion ring
3/4"	6K-SKIT	all	Nitrile	O-ring and PTFE anti-extrusion ring
1"	8K-SKIT	all	Nitrile	O-ring and PTFE anti-extrusion ring
1-1/4"	10K-SKIT	all	Nitrile	O-ring and PTFE anti-extrusion ring
1-1/2"	12K-SKIT	all	Nitrile	O-ring and PTFE anti-extrusion ring
2"	16K-SKIT	all	Nitrile	O-ring and PTFE anti-extrusion ring

Interchange Data

- Agricultural Interchange
- Parker/Pioneer 4000 Series and Faster NS/NV-Series
- Safeway Series-S20 and Stucchi IR-Series

Materials

- Machined components are manufactured using solid steel bar stock
- Stainless steel balls, retaining rings, and springs maximize corrosion resistance and extend service life
- Steel componentry is plated using ROHS-compliant trivalent chrome
- Steel coupler sleeves are hardened to resist deformation and maximize service life
- Steel plugs are hardened to provide heavy-duty performance and resist brinelling

Seal Components

- Nitrile (Buna-N) seals are standard, providing a temperature range of **-40°F to 250°F (-40°C to 121°C)**
- Couplers have a PTFE anti-extrusion ring
- Poppet valve seals are crimped in place to maintain integrity during excessive flow conditions and pressurized connection

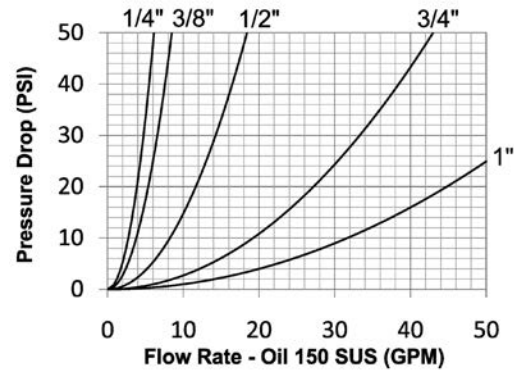

Rated Pressure Chart

Body Size	AG-Series Agricultural Interchange (Connected)							
	Ball Steel Coupler/Plug				Poppet Steel Coupler/Plug			
	Maximum Working		Burst		Maximum Working		Burst	
	PSI	Bar	PSI	Bar	PSI	Bar	PSI	Bar
1/4"	4,000	275	24,400	1,700	4,000	275	21,000	1,500
3/8"	4,000	275	25,000	1,700	4,000	275	16,100	1,100
1/2"	4,000	275	16,500	1,100	4,000	275	16,500	1,100
3/4"	3,000	200	15,800	1,050	3,000	200	10,300	700
1"	3,000	200	13,500	900	3,000	200	13,000	900

Technical Specifications

Body Size	Interchange Standards				Functional Parameters				
	U.S. Military	U.S. Government	International Standards	ANSI/NFPA Standards	Locking Ball Quantity	Air Inclusion	Fluid Loss	Vacuum Inch HG	Flow $\Delta P = 22$ PSI
1/4"	-	-	-	-	8	1.1cc	0.9cc	26.5	4 GPM
3/8"	-	-	-	-	9	2.6cc	1.8cc	26.5	6 GPM
1/2"	-	-	ISO7241 A	-	9	3.8cc	2.9cc	26.5	12 GPM
3/4"	-	-	ISO5675	-	12	10.8cc	9.7cc	26.5	28 GPM
1"	-	-	-	-	12	15.9cc	15.3cc	26.5	48 GPM

AG Series Profiles

Body Size	A	B
1/4"	0.56	0.31
3/8"	0.74	0.35
1/2"	0.81	0.37
3/4"	1.06	0.50
1"	1.23	0.62

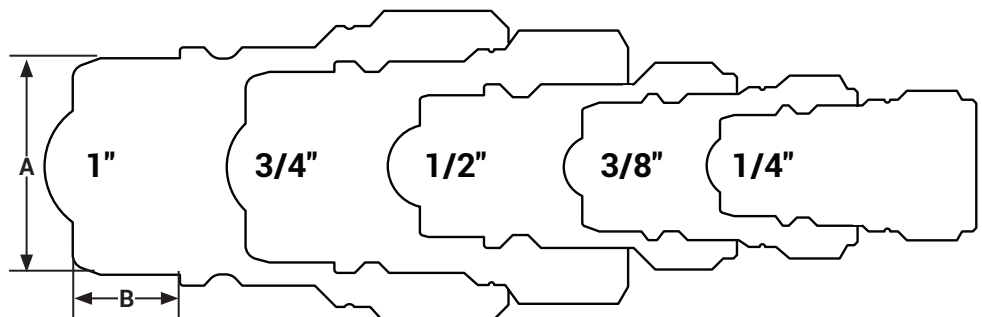

Hydraulic Couplings: AG-Series

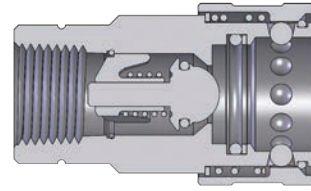
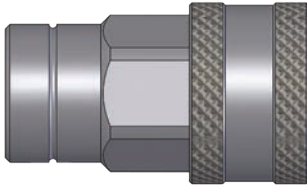

Body Size	AG-Series Agricultural Interchange Ball Valve Coupler (Female Threads)							
	Part Detail			Length		Maximum OD		Hex Inch
	Part #	Threads	Material	Inch	mm	Inch	mm	
1/4"	2AGF2	1/4" - 18 NPTF	steel	2.06	52.3	1.12	28.4	7/8"
3/8"	3AGF3	3/8" - 18 NPTF	steel	2.31	58.6	1.42	36.0	7/8"
1/2"	4AGF4	1/2" - 14 NPTF	steel	2.62	66.5	1.50	38.1	1-1/16"
	4AGBF4	1/2" - 14 BSPP	steel	2.62	66.5	1.50	38.1	1-1/16"
	4AGOF4	3/4" - 16 ORB	steel	2.62	66.5	1.50	38.1	1-1/16"
	4AGOF5	7/8" - 14 ORB	steel	2.66	67.5	1.50	38.1	1-3/32"
	4AGF6	3/4" - 14 NPTF	steel	2.64	67.0	1.50	38.1	1-5/16"
3/4"	6AGF6	3/4" - 14 NPTF	steel	3.23	82.0	1.88	47.7	1-5/16"
1"	8AGF8	1" - 11-1/2 NPTF	steel	3.79	96.2	2.12	53.8	1-5/8"

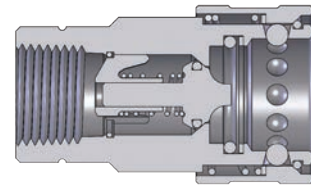
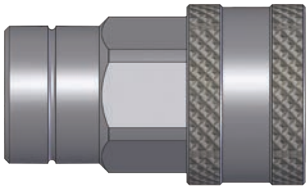

Body Size	AG-Series Agricultural Interchange Poppet Valve Coupler (Female Threads)							
	Part Detail			Length		Maximum OD		Hex Inch
	Part #	Threads	Material	Inch	mm	Inch	mm	
1/4"	2AGF2-PV	1/4" - 18 NPTF	steel	2.06	52.3	1.12	27.0	7/8"
3/8"	3AGF3-PV	3/8" - 18 NPTF	steel	2.31	58.6	1.42	34.0	7/8"
1/2"	4AGF4-PV	1/2" - 14 NPTF	steel	2.62	66.5	1.50	37.8	1-1/16"
	4AGBF4-PV	1/2" - 14 BSPP	steel	2.62	66.5	1.50	37.8	1-1/16"
	4AGOF4-PV	3/4" - 16 ORB	steel	2.62	66.5	1.50	37.8	1-1/16"
	4AGOF5-PV	7/8" - 14 ORB	steel	2.66	67.5	1.50	37.8	1-3/32"
	4AGF6-PV	3/4" - 14 NPTF	steel	2.64	67.0	1.50	37.8	1-5/16"
3/4"	6AGF6-PV	3/4" - 14 NPTF	steel	3.23	82.0	1.88	48.0	1-5/16"
1"	8AGF8-PV	1" - 11-1/2 NPTF	steel	3.79	96.2	2.12	55.0	1-5/8"

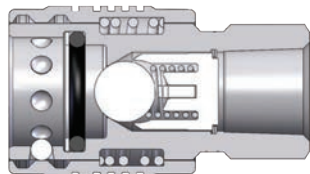

Body Size	AG-Series Agricultural Interchange Push-Pull Ball Valve Coupler (Female Threads)							
	Part Detail			Length		Maximum OD		Hex Inch
	Part #	Threads	Material	Inch	mm	Inch	mm	
3/8"	3AGF3-PS	3/8" - 18 NPTF	steel	2.31	58.6	1.42	36.07	7/8"
1/2"	4AGF4-PS	1/2" - 14 NPTF	steel	2.62	66.5	1.49	37.8	1-1/16"
	4AGOF4-PS	3/4" - 16 ORB	steel	2.62	66.5	1.48	37.8	1-1/16"
	4AGOF5-PS	7/8" - 14 ORB	steel	2.66	67.5	1.48	37.8	1-1/16"
3/4"	4AGF6-PS	3/4" - 14 NPTF	steel	2.74	69.6	1.48	37.8	1-3/16"
	6AGF6-PS	3/4" - 14 NPTF	steel	3.23	82.0	1.86	47.2	1-3/16"

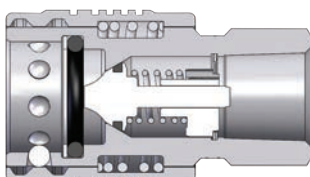

Body Size	AG-Series Agricultural Interchange Push-Pull Poppet Valve Coupler (Female Threads)							
	Part Detail			Length		Maximum OD		Hex Inch
	Part #	Threads	Material	Inch	mm	Inch	mm	
3/8"	3AGF3-PV-PS	3/8" - 18 NPTF	steel	2.31	58.6	1.42	36.0	7/8"
1/2"	4AGF4-PV-PS	1/2" - 14 NPTF	steel	2.62	66.5	1.49	37.8	1-1/16"
	4AGOF4-PV-PS	3/4" - 16 ORB	steel	2.62	66.5	1.49	37.8	1-1/16"
	4AGOF5-PV-PS	7/8" - 14 ORB	steel	2.66	66.5	1.49	37.8	1-1/16"
	4AGF6-PV-PS	3/4" - 14 NPTF	steel	2.74	69.6	1.49	37.8	1-3/16"
	6AGF6-PV-PS	3/4" - 14 NPTF	steel	3.23	82.0	1.86	47.2	1-3/16"

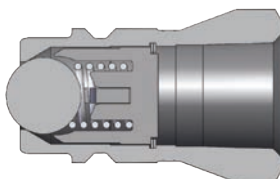

Body Size	AG-Series Agricultural Interchange Ball Valve Plug (Female Threads)							
	Part Detail			Length		Maximum OD		Hex Inch
	Part #	Threads	Material	Inch	mm	Inch	mm	
1/4"	AG2F2	1/4" - 18 NPTF	steel	1.42	36.0	0.84	21.3	3/4"
3/8"	AG3F3	3/8" - 18 NPTF	steel	1.61	40.8	1.05	26.6	15/16"
1/2"	AG4F4	1/2" - 14 NPTF	steel	1.95	49.5	1.21	30.7	1-1/16"
	AG4BF4	1/2" - 14 BSPP	steel	1.95	49.5	1.21	30.7	1-1/16"
	AG4OF4	3/4" - 16 ORB	steel	2.10	53.3	1.26	30.7	1-1/16"
	AG4OF5	7/8" - 14 ORB	steel	2.10	53.3	1.26	32.0	1-1/4"
	AG4F6	3/4" - 14 NPTF	steel	2.30	58.4	1.32	33.5	1-3/16"
3/4"	AG6F6	3/4" - 14 NPTF	steel	2.30	58.4	1.51	38.3	1-3/8"
1"	AG8F8	1" - 11-1/2 NPTF	steel	2.57	65.2	1.74	44.7	1-5/8"

Hydraulic Couplings: AG-Series

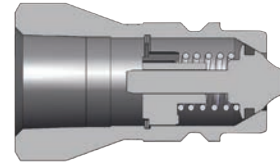

Body Size	AG-Series Agricultural Interchange Poppet Valve Plug (Female Threads)							
	Part Detail			Length		Maximum OD		Hex Inch
	Part #	Threads	Material	Inch	mm	Inch	mm	
1/4"	AG2F2-PV	1/4" - 18 NPTF	steel	1.42	36.0	0.84	21.3	3/4"
3/8"	AG3F3-PV	3/8" - 18 NPTF	steel	1.61	40.8	1.05	26.6	15/16"
1/2"	AG4F4-PV	1/2" - 14 NPTF	steel	2.08	52.8	1.21	30.7	1-1/16"
	AG4BF4-PV	1/2" - 14 BSPP	steel	2.08	52.8	1.21	30.7	1-1/16"
	AG4OF4-PV	3/4" - 16 ORB	steel	2.08	52.8	1.21	30.7	1-1/16"
	AG4OF5-PV	7/8" - 14 ORB	steel	2.13	54.1	1.26	32.0	1-1/16"
3/4"	AG4F6-PV	3/4" - 14 NPTF	steel	2.30	58.4	1.32	33.5	1-3/16"
1"	AG6F6-PV	3/4" - 14 NPTF	steel	2.30	58.4	1.51	38.3	1-3/8"
	AG8F8-PV	1" - 11-1/2 NPTF	steel	2.71	68.8	1.76	44.7	1-5/8"

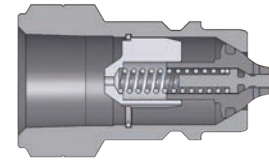
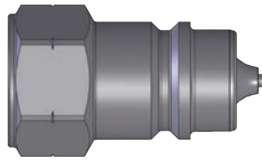

Body Size	AG-Series Agricultural Interchange Connect Under Residual Pressure Plug (Female Threads)							
	Part Detail			Length		Maximum OD		Hex Inch
	Part #	Threads	Material	Inch	mm	Inch	mm	
1/2"	AGE4F4-PV	1/2" - 14 NPTF	steel	2.03	51.56	1.20	30.48	1-1/16"
1/2"	AGE4OF4-PV	3/4" - 16 ORB	steel	2.03	51.56	1.20	30.48	1-1/16"



Body Size	AG-Series Agricultural Interchange Coupler Dust Plug		
	Part Detail		
	Part #	Lanyard	Body
1/4"	2AGDP	elastomer	elastomer
3/8"	3AGDP	elastomer	elastomer
1/2"	For 1/2" please refer to the color-coded K-Series dust caps on pg. 89		
3/4"	6AGDP	elastomer	elastomer
1"	8AGDP	elastomer	elastomer



Body Size	AG-Series Agricultural Interchange Plug Dust Cap		
	Part Detail		
	Part #	Lanyard	Body
1/4"	AG2DC	elastomer	elastomer
3/8"	AG3DC	elastomer	elastomer
1/2"	For 1/2" please refer to the color-coded K-Series dust caps on pg. 89		
3/4"	AG6DC	elastomer	elastomer
1"	AG8DC	elastomer	elastomer

Interchange Data

- Interchangeable to MIL-C-51234
- Parker/Snap-Tite H/IH and Faster TNV/TNL

Materials

- Machined components are manufactured using solid steel, brass, or 316 stainless steel bar stock
- Stainless steel balls, retaining rings, and springs maximize corrosion resistance and extend service life
- Steel componentry is plated using ROHS-compliant trivalent chrome
- Steel coupler sleeves are hardened to resist deformation and maximize service life
- Steel plugs are machined from high-strength steel and induction hardened
- Tubular TV valves are constructed from steel bar stock and are designed for optimum performance in pneumatic applications

Seal Components

- Nitrile (Buna-N) seals are standard, providing a temperature range of -40°F to 250°F (-40°C to 121°C)
- All couplers incorporate a PTFE anti-extrusion ring to protect the seal components from dynamic impulse damage
- 1/4" to 1" valve seals are crimped in place to maintain integrity during excessive flow conditions and pressurized connection
- 1-1/4" to 2" valve O-rings are retained by a unique seal-groove profile and are field replaceable

NOTE: Air flow data is presented using a coupler with a TV valve and unvalved plug. This configuration provides the optimal performance for pneumatic applications.

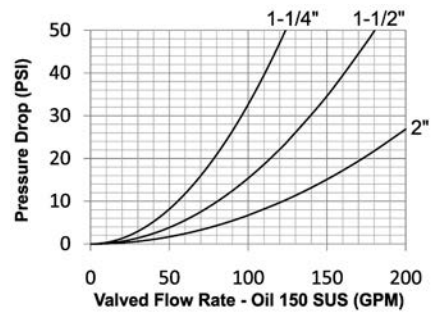
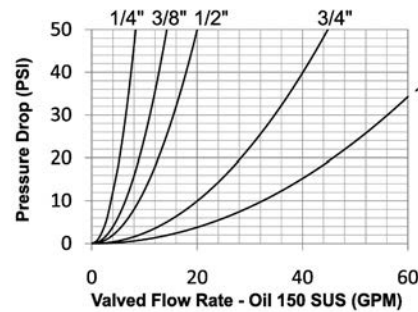
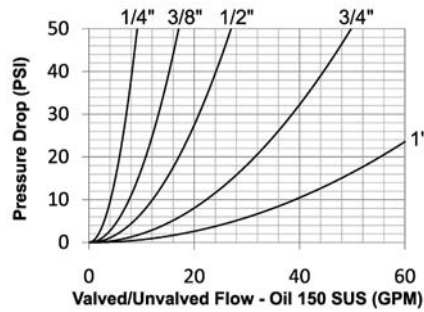
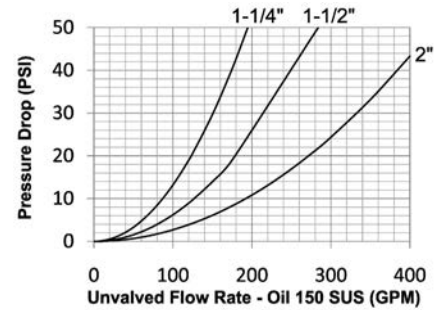
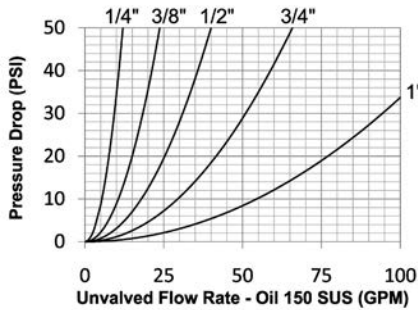
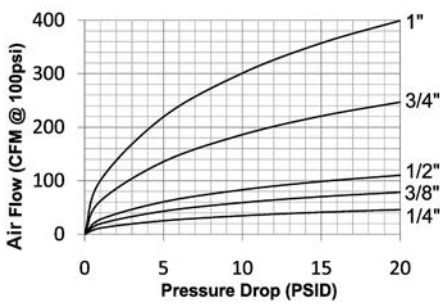

V Series Profiles

Body Size	A	B
1/4"	0.43	0.23
3/8"	0.51	0.29
1/2"	0.63	0.29
3/4"	0.92	0.43
1"	1.17	0.41

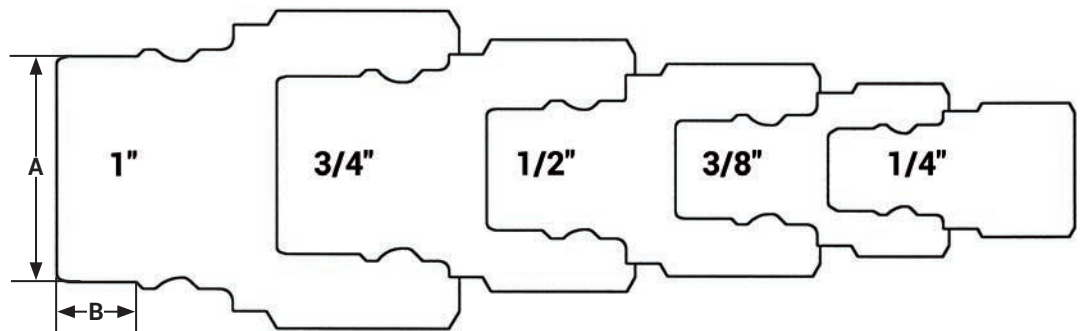

Rated Pressure Chart

Body Size	V-Series MIL-C-51234 (Valved Connected)											
	Steel Coupler/Plug				Brass Coupler/Plug				316 Stainless Coupler/Plug			
	Maximum Working		Burst		Maximum Working		Burst		Maximum Working		Burst	
	PSI	Bar	PSI	Bar	PSI	Bar	PSI	Bar	PSI	Bar	PSI	Bar
1/4"	6,500	450	12,700	876	2,250	150	5,000	345	5,000	345	10,000	700
3/8"	4,500	310	10,500	700	2,250	150	5,300	350	4,000	275	8,000	550
1/2"	4,000	275	9,600	650	2,000	130	5,700	390	3,750	260	7,500	500
3/4"	3,500	240	9,100	600	2,000	130	5,300	350	2,000	130	7,500	500
1"	2,000	130	9,500	650	1,750	120	5,000	345	2,000	130	5,000	345
1-1/4"	1,750	120	5,000	345	350	24	1,000	70	1,500	100	3,000	200
1-1/2"	1,500	100	5,000	345	350	24	1,200	80	1,500	100	3,000	200
2"	1,500	100	4,000	275	400	28	1,000	70	500	34	1,000	70

Body Size	V-Series MIL-C-51234 (Unvalved Connected)											
	Steel Coupler/Plug				Brass Coupler/Plug				316 SS Coupler/Plug			
	Maximum Working		Burst		Maximum Working		Burst		Maximum Working		Burst	
	PSI	Bar	PSI	Bar	PSI	Bar	PSI	Bar	PSI	Bar	PSI	Bar
1/4"	11,000	760	29,500	2,000	4,000	275	14,200	980	10,000	670	29,200	2,000
3/8"	11,000	760	29,900	2,000	4,000	275	14,500	1,000	8,000	550	27,900	1,900
1/2"	11,000	760	29,300	2,000	4,000	275	14,500	1,000	8,000	550	24,600	1,700
3/4"	9,000	620	19,300	1,300	3,500	250	11,100	750	7,000	480	22,600	1,500
1"	6,000	400	15,900	1,100	3,000	200	8,200	560	4,000	275	15,500	1,000
1-1/4"	5,000	345	10,000	700	1,000	70	4,000	275	3,000	200	10,000	700
1-1/2"	5,000	345	10,000	700	1,000	70	4,000	275	3,000	200	10,000	700
2"	4,000	275	8,000	550	750	50	2,800	190	1,000	70	6,000	400

Technical Specifications

Body Size	Interchange Standards			Functional Parameters				
	U.S. Military	International Standards	ANSI/NFPA Standards	Locking Ball Quantity	Air Inclusion	Fluid Loss	Vacuum inch HG	Flow ΔP = 22 PSI
1/4"	MIL-C-51234	-	-	6	2.0cc	0.2cc	26.7	5.5 GPM
3/8"	MIL-C-51234	-	-	6	3.5cc	3.2cc	26.7	9.5 GPM
1/2"	MIL-C-51234	-	-	9	4.0cc	4.0cc	26.7	13.0 GPM
3/4"	MIL-C-51234	-	-	9	14.0cc	14.0cc	26.7	30.0 GPM
1"	MIL-C-51234	-	-	12	21.0cc	20.0cc	26.7	48.0 GPM
1-1/4"	MIL-C-51234	-	-	12	45.0cc	45.0cc	N/R	82.0 GPM
1-1/2"	MIL-C-51234	-	-	12	80.0cc	80.0cc	N/R	120.0 GPM
2"	MIL-C-51234	-	-	12	150.0cc	150.0cc	N/R	185.0 GPM

Available Options

Body Size	Standard Seal Options							Kalrez® Seal Options		
	FKM	EPDM	Steam-EP	FDA FKM	Mil-Nitrile	Fuel Nitrile	Silicone	4079	6375	7075
1/4"	F-	P-	PS-	D-	M-	JF-	S-	K4-	K6-	K7-
3/8"	F-	P-	PS-	D-	M-	JF-	S-	K4-	K6-	K7-
1/2"	F-	P-	PS-	D-	M-	JF-	S-	K4-	K6-	K7-
3/4"	F-	P-	PS-	D-	M-	JF-	S-	K4-	K6-	K7-
1"	F-	P-	PS-	D-	M-	JF-	S-	K4-	K6-	K7-
1-1/4"	F-	P-	PS-	D-	M-	JF-	S-	K4-	K6-	K7-
1-1/2"	F-	P-	PS-	D-	M-	JF-	S-	K4-	K6-	K7-
2"	F-	P-	PS-	D-	M-	JF-	S-	K4-	K6-	K7-

Body Size	Valve Options					Sleeve Options			Treatments
	Unvalved	Tubular	Steel	Brass	316 SS	Sleeve-Lock	Flanged	Sil-Flange	Oxy-Clean
1/4"	-E	-TV	-ZV	-BV	SSV	-LS	N/A	N/A	-C1
3/8"	-E	-TV	-ZV	-BV	SSV	-LS	N/A	N/A	-C1
1/2"	-E	-TV	-ZV	-BV	SSV	-LS	N/A	N/A	-C1
3/4"	-E	-TV	-ZV	-BV	SSV	-LS	N/A	N/A	-C1
1"	-E	-TV	-ZV	-BV	SSV	-LS	N/A	N/A	-C1
1-1/4"	-E		-ZV	-BV	SSV	-LS	N/A	N/A	-C1
1-1/2"	-E		-ZV	-BV	SSV	-LS	N/A	N/A	-C1
2"	-E		-ZV	-BV	SSV	-LS	N/A	N/A	-C1

Large V Series Profiles

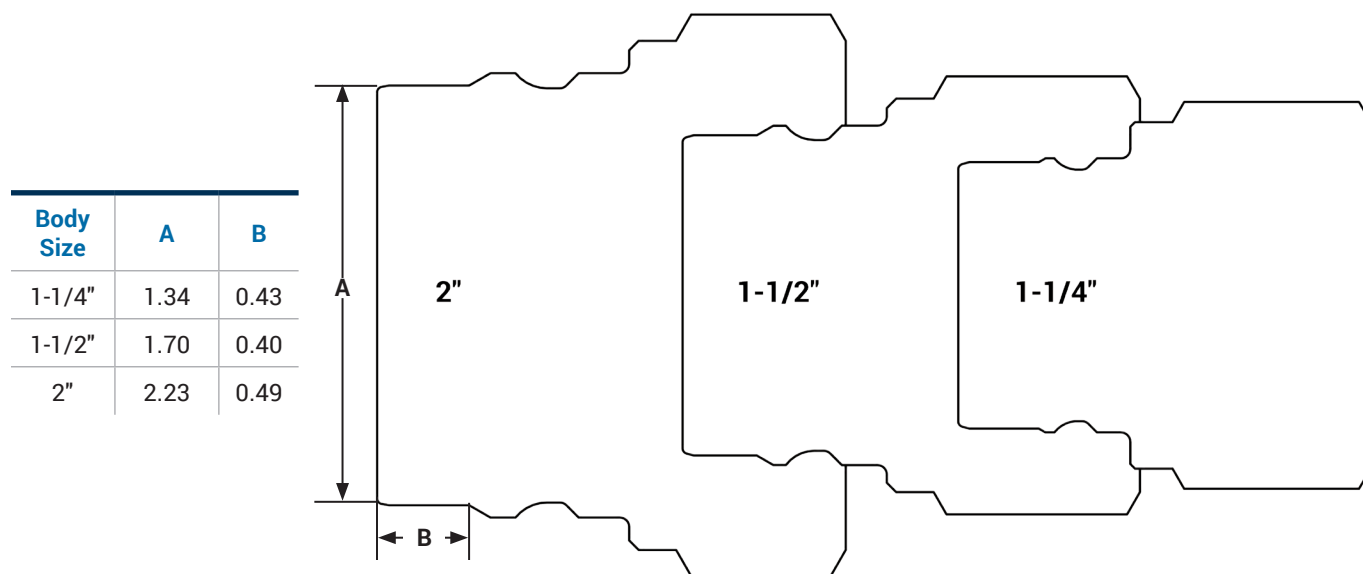

Hydraulic Couplings: V-Series

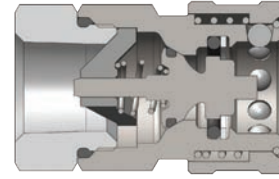
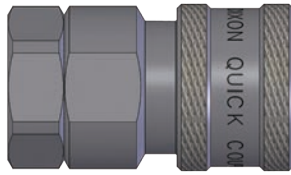

Body Size	V-Series MIL-C-51234 Valved Coupler (Female Threads)							
	Part Detail			Length		Maximum OD		Hex inch
	Part #	Threads	Material	inch	mm	inch	mm	
1/4"	2VF1	1/8" - 27 NPTF	steel	1.68	42.7	0.99	25.1	7/8"
	2VF2	1/4" - 18 NPTF	steel	1.68	42.7	0.99	25.1	7/8"
	2VF2-B	1/4" - 18 NPTF	brass	1.68	42.7	0.99	25.1	7/8"
	2VF2-SS	1/4" - 18 NPTF	316 stainless	1.68	42.7	0.99	25.1	7/8"
	2VBF2	1/4" - 19 BSPP	steel	1.81	46.0	0.99	25.1	7/8"
	2VBF2-B	1/4" - 19 BSPP	brass	1.81	46.0	0.99	25.1	7/8"
	2VBF2-SS	1/4" - 19 BSPP	316 stainless	1.81	46.0	0.99	25.1	7/8"
	2VOF2	7/16" - 20 ORB	steel	1.81	46.0	0.99	25.1	7/8"
3/8"	3VF3	3/8" - 18 NPTF	steel	1.94	49.3	1.18	30.0	1"
	3VF3-B	3/8" - 18 NPTF	brass	1.94	49.3	1.18	30.0	1"
	3VF3-SS	3/8" - 18 NPTF	316 stainless	1.94	49.3	1.18	30.0	1"
	3VBF3	3/8" - 19 BSPP	steel	2.01	51.1	1.18	30.0	1"
	3VBF3-B	3/8" - 19 BSPP	brass	2.01	51.1	1.18	30.0	1"
	3VBF3-SS	3/8" - 19 BSPP	316 stainless	2.01	51.1	1.18	30.0	1"
		3VOF3	9/16" - 18 ORB	steel	2.01	51.1	1.18	30.0
	3VF4	1/2" - 14 NPTF	steel	2.01	51.1	1.18	30.0	1"
1/2"	4VF4	1/2" - 14 NPTF	steel	2.13	54.1	1.36	34.5	1-3/16"
	4VF4-B	1/2" - 14 NPTF	brass	2.13	54.1	1.36	34.5	1-3/16"
	4VF4-SS	1/2" - 14 NPTF	316 stainless	2.13	54.1	1.36	34.5	1-3/16"
	4VBF4	1/2" - 14 BSPP	steel	2.13	54.1	1.36	34.5	1-3/16"
	4VBF4-B	1/2" - 14 BSPP	brass	2.13	54.1	1.36	34.5	1-3/16"
	4VBF4-SS	1/2" - 14 BSPP	316 stainless	2.13	54.1	1.36	34.5	1-3/16"
		4VOF4	3/4" - 16 ORB	steel	2.13	54.1	1.36	34.5
3/4"	4VF6	3/4" - 14 NPTF	steel	2.13	54.1	1.36	34.5	1-3/16"
	6VF6	3/4" - 14 NPTF	steel	2.47	62.7	1.67	42.4	1-1/2"
	6VF6-B	3/4" - 14 NPTF	brass	2.47	62.7	1.67	42.4	1-1/2"
	6VF6-SS	3/4" - 14 NPTF	316 stainless	2.47	62.7	1.67	42.4	1-1/2"
	6VBF6	3/4" - 14 BSPP	steel	2.96	75.2	1.67	42.4	1-1/2"
	6VBF6-B	3/4" - 14 BSPP	brass	2.96	75.2	1.67	42.4	1-1/2"
	6VBF6-SS	3/4" - 14 BSPP	316 stainless	2.96	75.2	1.67	42.4	1-1/2"
	6VOF6	1-1/16" - 12 ORB	steel	2.96	75.2	1.67	42.4	1-1/2"
1"	8VF8	1" - 11-1/2 NPTF	steel	2.70	68.6	2.06	52.3	1-7/8"
	8VF8-B	1" - 11-1/2 NPTF	brass	2.70	68.6	2.06	52.3	1-7/8"
	8VF8-SS	1" - 11-1/2 NPTF	316 stainless	2.70	68.6	2.06	52.3	1-7/8"
	8VBF8	1" - 11 BSPP	steel	2.97	75.4	2.06	52.3	1-7/8"
	8VBF8-B	1" - 11 BSPP	brass	2.97	75.4	2.06	52.3	1-7/8"
	8VBF8-SS	1" - 11 BSPP	316 stainless	2.97	75.4	2.06	52.3	1-7/8"
		8VOF8	1-5/16" - 12 ORB	steel	2.97	75.4	2.06	52.3

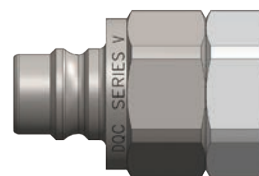
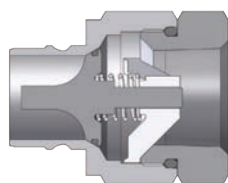

Body Size	V-Series MIL-C-51234 Valved Plug (Female Threads)							
	Part Detail			Length		Maximum OD		Hex inch
	Part #	Threads	Material	inch	mm	inch	mm	
1/4"	V2F1	1/8" - 27 NPTF	steel	1.62	41.1	0.97	24.6	7/8"
	V2F2	1/4" - 18 NPTF	steel	1.62	41.1	0.97	24.6	7/8"
	V2F2-B	1/4" - 18 NPTF	brass	1.62	41.1	0.97	24.6	7/8"
	V2F2-SS	1/4" - 18 NPTF	316 stainless	1.62	41.1	0.97	24.6	7/8"
	V2BF2	1/4" - 19 BSPP	steel	1.75	44.5	0.97	24.6	7/8"
	V2BF2-B	1/4" - 19 BSPP	brass	1.75	44.5	0.97	24.6	7/8"
	V2BF2-SS	1/4" - 19 BSPP	316 stainless	1.75	44.5	0.97	24.6	7/8"
	V2OF2	7/16" - 20 ORB	steel	1.75	44.5	0.97	24.6	7/8"
3/8"	V3F3	3/8" - 18 NPTF	steel	1.87	47.5	1.10	27.9	1"
	V3F3-B	3/8" - 18 NPTF	brass	1.87	47.5	1.10	27.9	1"
	V3F3-SS	3/8" - 18 NPTF	316 stainless	1.87	47.5	1.10	27.9	1"
	V3BF3	3/8" - 19 BSPP	steel	1.94	49.3	1.10	27.9	1"
	V3BF3-B	3/8" - 19 BSPP	brass	1.94	49.3	1.10	27.9	1"
	V3BF3-SS	3/8" - 19 BSPP	316 stainless	1.94	49.3	1.10	27.9	1"
	V3OF3	9/16" - 18 ORB	steel	1.94	49.3	1.10	27.9	1"
	V3F4	1/2" - 14 NPTF	steel	1.94	49.3	1.10	27.9	1"
1/2"	V4F4	1/2" - 14 NPTF	steel	1.99	50.5	1.31	33.3	1-3/16"
	V4F4-B	1/2" - 14 NPTF	brass	1.99	50.5	1.31	33.3	1-3/16"
	V4F4-SS	1/2" - 14 NPTF	316 stainless	1.99	50.5	1.31	33.3	1-3/16"
	V4BF4	1/2" - 14 BSPP	steel	1.99	50.5	1.31	33.3	1-3/16"
	V4BF4-B	1/2" - 14 BSPP	brass	1.99	50.5	1.31	33.3	1-3/16"
	V4BF4-SS	1/2" - 14 BSPP	316 stainless	1.99	50.5	1.31	33.3	1-3/16"
	V4OF4	3/4" - 16 ORB	steel	1.99	50.5	1.31	33.3	1-3/16"
	V4F6	3/4" - 14 NPTF	steel	1.99	50.5	1.31	33.3	1-3/16"
3/4"	V6F6	3/4" - 14 NPTF	steel	2.31	58.7	1.65	41.9	1-1/2"
	V6F6-B	3/4" - 14 NPTF	brass	2.31	58.7	1.65	41.9	1-1/2"
	V6F6-SS	3/4" - 14 NPTF	316 stainless	2.31	58.7	1.65	41.9	1-1/2"
	V6BF6	3/4" - 14 BSPP	steel	2.80	71.1	1.65	41.9	1-1/2"
	V6BF6-B	3/4" - 14 BSPP	brass	2.80	71.1	1.65	41.9	1-1/2"
	V6BF6-SS	3/4" - 14 BSPP	316 stainless	2.80	71.1	1.65	41.9	1-1/2"
	V6OF6	1-1/16" - 12 ORB	steel	2.80	71.1	1.65	41.9	1-1/2"
	V8F8	1" - 11-1/2 NPTF	steel	2.60	66.0	2.06	52.3	1-7/8"
1"	V8F8-B	1" - 11-1/2 NPTF	brass	2.60	66.0	2.06	52.3	1-7/8"
	V8F8-SS	1" - 11-1/2 NPTF	316 stainless	2.60	66.0	2.06	52.3	1-7/8"
	V8BF8	1" - 11 BSPP	steel	2.87	72.9	2.06	52.3	1-7/8"
	V8BF8-B	1" - 11 BSPP	brass	2.87	72.9	2.06	52.3	1-7/8"
	V8BF8-SS	1" - 11 BSPP	316 stainless	2.87	72.9	2.06	52.3	1-7/8"
	V8OF8	1-5/16" - 12 ORB	steel	2.85	72.6	2.06	52.3	1-7/8"

Hydraulic Couplings: V-Series

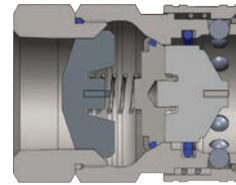
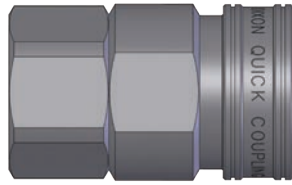

Body Size	V-Series MIL-C-51234 Valved Coupler (Female Threads)							
	Part Detail			Length		Maximum OD		Hex inch
	Part #	Threads	Material	inch	mm	inch	mm	
1-1/4"	10VF10	1-1/4" - 11-1/2 NPTF	steel	3.54	89.9	2.19	55.6	2"
	10VF10-B	1-1/4" - 11-1/2 NPTF	brass	3.54	89.9	2.19	55.6	2"
	10VF10-SS	1-1/4" - 11-1/2 NPTF	316 stainless	3.54	89.9	2.19	55.6	2"
	10VBF10	1-1/4" - 11 BSPP	steel	3.54	89.9	2.19	55.6	2"
	10VBF10-B	1-1/4" - 11 BSPP	brass	3.54	89.9	2.19	55.6	2"
	10VBF10-SS	1-1/4" - 11 BSPP	316 stainless	3.54	89.9	2.19	55.6	2"
	10VOF10	1-5/8" - 12 ORB	steel	3.54	89.9	2.19	55.6	2"
1-1/2"	12VF12	1-1/2" - 11-1/2 NPTF	steel	3.27	83.1	2.74	69.6	2-1/2"
	12VF12-B	1-1/2" - 11-1/2 NPTF	brass	3.27	83.1	2.74	69.6	2-1/2"
	12VF12-SS	1-1/2" - 11-1/2 NPTF	316 stainless	3.27	83.1	2.74	69.6	2-1/2"
	12VBF12	1-1/2" - 11 BSPP	steel	3.27	83.1	2.74	69.6	2-1/2"
	12VBF12-B	1-1/2" - 11 BSPP	brass	3.27	83.1	2.74	69.6	2-1/2"
	12VBF12-SS	1-1/2" - 11 BSPP	316 stainless	3.27	83.1	2.74	69.6	2-1/2"
	12VOF12	1-7/8" - 12 ORB	steel	3.27	83.1	2.74	69.6	2-1/2"
2"	16VF16	2" - 11-1/2 NPTF	steel	3.92	99.6	3.83	97.3	3-1/2"
	16VF16-B	2" - 11-1/2 NPTF	brass	3.92	99.6	3.83	97.3	3-1/2"
	16VF16-SS	2" - 11-1/2 NPTF	316 stainless	3.92	99.6	3.83	97.3	3-1/2"
	16VBF16	2" - 11 BSPP	steel	3.92	99.6	3.83	97.3	3-1/2"
	16VBF16-B	2" - 11 BSPP	brass	3.92	99.6	3.83	97.3	3-1/2"
	16VBF16-SS	2" - 11 BSPP	316 stainless	3.92	99.6	3.83	97.3	3-1/2"

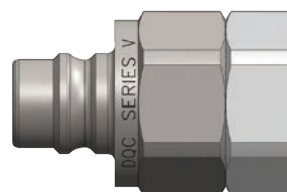
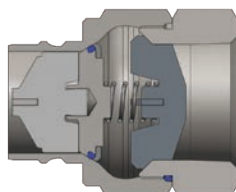

Body Size	V-Series MIL-C-51234 Valved Plug (Female Threads)							
	Part Detail			Length		Maximum OD		Hex inch
	Part #	Threads	Material	inch	mm	inch	mm	
1-1/4"	V10F10	1-1/4" - 11-1/2 NPTF	steel	3.41	86.6	2.19	55.6	2"
	V10F10-B	1-1/4" - 11-1/2 NPTF	brass	3.41	86.6	2.19	55.6	2"
	V10F10-SS	1-1/4" - 11-1/2 NPTF	316 stainless	3.41	86.6	2.19	55.6	2"
	V10BF10	1-1/4" - 11 BSPP	steel	3.41	86.6	2.19	55.6	2"
	V10BF10-B	1-1/4" - 11 BSPP	brass	3.41	86.6	2.19	55.6	2"
	V10BF10-SS	1-1/4" - 11 BSPP	316 stainless	3.41	86.6	2.19	55.6	2"
	V100F10	1-5/8" - 12 ORB	steel	3.41	86.6	2.19	55.6	2"
1-1/2"	V12F12	1-1/2" - 11-1/2 NPTF	steel	3.35	79.0	2.74	69.6	2-1/2"
	V12F12-B	1-1/2" - 11-1/2 NPTF	brass	3.35	79.0	2.74	69.6	2-1/2"
	V12F12-SS	1-1/2" - 11-1/2 NPTF	316 stainless	3.35	79.0	2.74	69.6	2-1/2"
	V12BF12	1-1/2" - 11 BSPP	steel	3.35	79.0	2.74	69.6	2-1/2"
	V12BF12-B	1-1/2" - 11 BSPP	brass	3.35	79.0	2.74	69.6	2-1/2"
	V12BF12-SS	1-1/2" - 11 BSPP	316 stainless	3.35	79.0	2.74	69.6	2-1/2"
	V120F12	1-7/8" - 12 ORB	steel	3.35	79.0	2.74	69.6	2-1/2"
2"	V16F16	2" - 11-1/2 NPTF	steel	3.72	94.5	3.83	97.3	3-1/2"
	V16F16-B	2" - 11-1/2 NPTF	brass	3.72	94.5	3.83	97.3	3-1/2"
	V16F16-SS	2" - 11-1/2 NPTF	316 stainless	3.72	94.5	3.83	97.3	3-1/2"
	V16BF16	2" - 11 BSPP	steel	3.72	94.5	3.83	97.3	3-1/2"
	V16BF16-B	2" - 11 BSPP	brass	3.72	94.5	3.83	97.3	3-1/2"
	V16BF16-SS	2" - 11 BSPP	316 stainless	3.72	94.5	3.83	97.3	3-1/2"

Hydraulic Couplings: V-Series

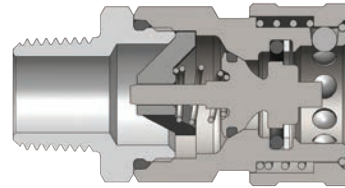
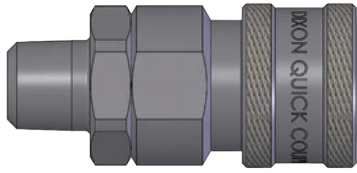

V-Series MIL-C-51234 Valved Coupler (Male Threads)

Body Size	V-Series MIL-C-51234 Valved Coupler (Male Threads)							
	Part Detail			Length		Maximum OD		Hex inch
	Part #	Threads	Material	inch	mm	inch	mm	
1/4"	2VM1	1/8" - 27 NPTF	steel	2.12	53.8	0.99	25.1	7/8"
	2VM2	1/4" - 18 NPTF	steel	2.12	53.8	0.99	25.1	7/8"
	2VM2-B	1/4" - 18 NPTF	brass	2.12	53.8	0.99	25.1	7/8"
	2VM2-SS	1/4" - 18 NPTF	316 stainless	2.12	53.8	0.99	25.1	7/8"
3/8"	3VM3	3/8" - 18 NPTF	steel	2.32	58.9	1.18	30.0	1"
	3VM3-B	3/8" - 18 NPTF	brass	2.32	58.9	1.18	30.0	1"
	3VM3-SS	3/8" - 18 NPTF	316 stainless	2.32	58.9	1.18	30.0	1"
1/2"	4VM4	1/2" - 14 NPTF	steel	2.54	64.5	1.36	34.5	1-3/16"
	4VM4-B	1/2" - 14 NPTF	brass	2.54	64.5	1.36	34.5	1-3/16"
	4VM4-SS	1/2" - 14 NPTF	316 stainless	2.54	64.5	1.36	34.5	1-3/16"
3/4"	6VM6	3/4" - 14 NPTF	steel	3.07	78.0	1.67	42.4	1-1/2"
	6VM6-B	3/4" - 14 NPTF	brass	3.07	78.0	1.67	42.4	1-1/2"
	6VM6-SS	3/4" - 14 NPTF	316 stainless	3.07	78.0	1.67	42.4	1-1/2"
1"	8VM8	1" - 11-1/2 NPTF	steel	3.32	84.3	2.06	52.3	1-7/8"
	8VM8-B	1" - 11-1/2 NPTF	brass	3.32	84.3	2.06	52.3	1-7/8"
	8VM8-SS	1" - 11-1/2 NPTF	316 stainless	3.32	84.3	2.06	52.3	1-7/8"
1-1/4"	10VM10	1-1/4" - 11-1/2 NPTF	steel	3.59	91.2	2.19	55.6	2"
	10VM10-B	1-1/4" - 11-1/2 NPTF	brass	3.59	91.2	2.19	55.6	2"
	10VM10-SS	1-1/4" - 11-1/2 NPTF	316 stainless	3.59	91.2	2.19	55.6	2"
1-1/2"	12VM12	1-1/2" - 11-1/2 NPTF	steel	4.01	101.9	2.74	69.6	2-1/2"
	12VM12-B	1-1/2" - 11-1/2 NPTF	brass	4.01	101.9	2.74	69.6	2-1/2"
	12VM12-SS	1-1/2" - 11-1/2 NPTF	316 stainless	4.01	101.9	2.74	69.6	2-1/2"
2"	16VM16	2" - 11-1/2 NPTF	steel	4.54	115.3	3.83	97.3	3-1/2"
	16VM16-B	2" - 11-1/2 NPTF	brass	4.54	115.3	3.83	97.3	3-1/2"
	16VM16-SS	2" - 11-1/2 NPTF	316 stainless	4.54	115.3	3.83	97.3	3-1/2"

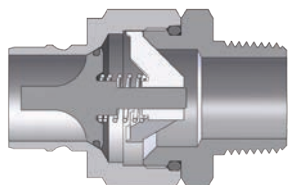

Body Size	V-Series MIL-C-51234 Valved Plug (Male Threads)							
	Part Detail			Length		Maximum OD		Hex inch
	Part #	Threads	Material	inch	mm	inch	mm	
1/4"	V2M1	1/8" - 27 NPTF	steel	2.06	52.3	0.97	24.6	7/8"
	V2M2	1/4" - 18 NPTF	steel	2.06	52.3	0.97	24.6	7/8"
	V2M2-B	1/4" - 18 NPTF	brass	2.06	52.3	0.97	24.6	7/8"
	V2M2-SS	1/4" - 18 NPTF	316 stainless	2.06	52.3	0.97	24.6	7/8"
3/8"	V3M3	3/8" - 18 NPTF	steel	2.25	57.2	1.10	27.9	1"
	V3M3-B	3/8" - 18 NPTF	brass	2.25	57.2	1.10	27.9	1"
	V3M3-SS	3/8" - 18 NPTF	316 stainless	2.25	57.2	1.10	27.9	1"
1/2"	V4M4	1/2" - 14 NPTF	steel	2.40	61.0	1.31	33.3	1-3/16"
	V4M4-B	1/2" - 14 NPTF	brass	2.40	61.0	1.31	33.3	1-3/16"
	V4M4-SS	1/2" - 14 NPTF	316 stainless	2.40	61.0	1.31	33.3	1-3/16"
3/4"	V6M6	3/4" - 14 NPTF	steel	2.91	73.9	1.65	41.9	1-1/2"
	V6M6-B	3/4" - 14 NPTF	brass	2.91	73.9	1.65	41.9	1-1/2"
	V6M6-SS	3/4" - 14 NPTF	316 stainless	2.91	73.9	1.65	41.9	1-1/2"
1"	V8M8	1" - 11-1/2 NPTF	steel	3.22	81.8	2.06	52.3	1-7/8"
	V8M8-B	1" - 11-1/2 NPTF	brass	3.22	81.8	2.06	52.3	1-7/8"
	V8M8-SS	1" - 11-1/2 NPTF	316 stainless	3.22	81.8	2.06	52.3	1-7/8"
1-1/4"	V10M10	1-1/4" - 11-1/2 NPTF	steel	3.46	87.9	2.19	55.6	2"
	V10M10-B	1-1/4" - 11-1/2 NPTF	brass	3.46	87.9	2.19	55.6	2"
	V10M10-SS	1-1/4" - 11-1/2 NPTF	316 stainless	3.46	87.9	2.19	55.6	2"
1-1/2"	V12M12	1-1/2" - 11-1/2 NPTF	steel	3.85	97.8	2.74	69.6	2-1/2"
	V12M12-B	1-1/2" - 11-1/2 NPTF	brass	3.85	97.8	2.74	69.6	2-1/2"
	V12M12-SS	1-1/2" - 11-1/2 NPTF	316 stainless	3.85	97.8	2.74	69.6	2-1/2"
2"	V16M16	2" - 11-1/2 NPTF	steel	4.34	110.2	3.83	97.3	3-1/2"
	V16M16-B	2" - 11-1/2 NPTF	brass	4.34	110.2	3.83	97.3	3-1/2"
	V16M16-SS	2" - 11-1/2 NPTF	316 stainless	4.34	110.2	3.83	97.3	3-1/2"

Hydraulic Couplings: V-Series

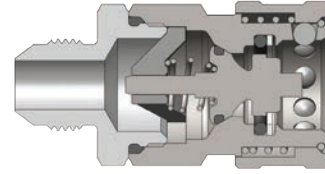
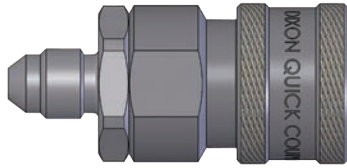

V-Series MIL-C-51234 Valved Coupler (JIC Male Threads)

Body Size	V-Series MIL-C-51234 Valved Coupler (JIC Male Threads)							
	Part Detail			Length		Maximum OD		Hex inch
	Part #	Threads	Material	inch	mm	inch	mm	
1/4"	2VJM2	7/16" - 20 JIC	steel	2.12	53.8	0.99	25.1	7/8"
3/8"	3VJM3	9/16" - 18 JIC	steel	2.32	58.9	1.18	30.0	1"
1/2"	4VJM4	3/4" - 16 JIC	steel	2.54	64.5	1.36	34.5	1-3/16"
3/4"	6VJM6	1-1/16" - 12 JIC	steel	3.07	78.0	1.67	42.4	1-1/2"
1"	8VJM8	1-5/16" - 12 JIC	steel	3.32	84.3	2.06	52.3	1-7/8"
1-1/4"	10VJM10	1-5/8" - 12 JIC	steel	3.59	91.2	2.19	55.6	2"

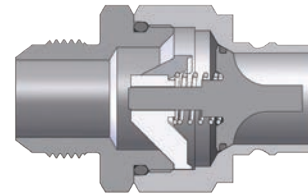
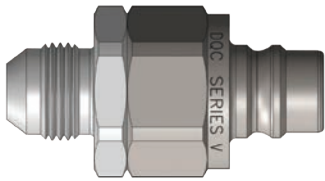

V-Series MIL-C-51234 Valved Plug (JIC Male Threads)

Body Size	V-Series MIL-C-51234 Valved Plug (JIC Male Threads)							
	Part Detail			Length		Maximum OD		Hex inch
	Part #	Threads	Material	inch	mm	inch	mm	
1/4"	V2JM2	7/16" - 20 JIC	steel	2.06	52.3	0.97	24.6	7/8"
3/8"	V3JM3	9/16" - 18 JIC	steel	2.25	57.2	1.1	27.9	1"
1/2"	V4JM4	3/4" - 16 JIC	steel	2.40	61.0	1.31	33.3	1-3/16"
3/4"	V6JM6	1-1/16" - 12 JIC	steel	2.91	73.9	1.65	41.9	1-1/2"
1"	V8JM8	1-5/16" - 12 JIC	steel	3.22	81.8	2.06	52.3	1-7/8"
1-1/4"	V10JM10	1-5/8" - 12 JIC	steel	3.46	87.9	2.19	55.6	2"

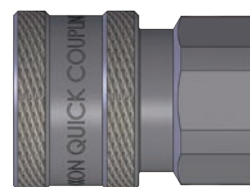
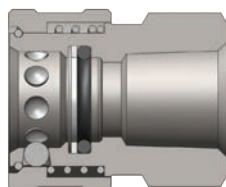

Body Size	V-Series MIL-C-51234 Unvalved Coupler (Female Threads)							
	Part Detail			Length		Maximum OD		Hex inch
	Part #	Threads	Material	inch	mm	inch	mm	
1/4"	2VF2-E	1/4" - 18 NPTF	steel	1.36	34.5	0.99	25.1	7/8"
	2VF2-B-E	1/4" - 18 NPTF	brass	1.36	34.5	0.99	25.1	7/8"
	2VF2-SS-E	1/4" - 18 NPTF	316 stainless	1.36	34.5	0.99	25.1	7/8"
	2VBF2-E	1/4" - 19 BSPP	steel	1.36	34.5	0.99	25.1	7/8"
	2VBF2-B-E	1/4" - 19 BSPP	brass	1.36	34.5	0.99	25.1	7/8"
	2VBF2-SS-E	1/4" - 19 BSPP	316 stainless	1.36	34.5	0.99	25.1	7/8"
3/8"	3VF3-E	3/8" - 18 NPTF	steel	1.50	38.1	1.18	30.0	7/8"
	3VF3-B-E	3/8" - 18 NPTF	brass	1.50	38.1	1.18	30.0	7/8"
	3VF3-SS-E	3/8" - 18 NPTF	316 stainless	1.50	38.1	1.18	30.0	7/8"
	3VBF3-E	3/8" - 19 BSPP	steel	1.50	38.1	1.18	30.0	7/8"
	3VBF3-B-E	3/8" - 19 BSPP	brass	1.50	38.1	1.18	30.0	7/8"
	3VBF3-SS-E	3/8" - 19 BSPP	316 stainless	1.50	38.1	1.18	30.0	7/8"
1/2"	4VF4-E	1/2" - 14 NPTF	steel	1.64	41.7	1.37	34.8	1-3/16"
	4VF4-B-E	1/2" - 14 NPTF	brass	1.64	41.7	1.37	34.8	1-3/16"
	4VF4-SS-E	1/2" - 14 NPTF	316 stainless	1.64	41.7	1.37	34.8	1-3/16"
	4VBF4-E	1/2" - 14 BSPP	steel	1.64	41.7	1.37	34.8	1-3/16"
	4VBF4-B-E	1/2" - 14 BSPP	brass	1.64	41.7	1.37	34.8	1-3/16"
	4VBF4-SS-E	1/2" - 14 BSPP	316 stainless	1.64	41.7	1.37	34.8	1-3/16"
3/4"	6VF6-E	3/4" - 14 NPTF	steel	1.96	49.8	1.67	42.4	1-1/2"
	6VF6-B-E	3/4" - 14 NPTF	brass	1.96	49.8	1.67	42.4	1-1/2"
	6VF6-SS-E	3/4" - 14 NPTF	316 stainless	1.96	49.8	1.67	42.4	1-1/2"
	6VBF6-E	3/4" - 14 BSPP	steel	1.96	49.8	1.67	42.4	1-1/2"
	6VBF6-B-E	3/4" - 14 BSPP	brass	1.96	49.8	1.67	42.4	1-1/2"
	6VBF6-SS-E	3/4" - 14 BSPP	316 stainless	1.96	49.8	1.67	42.4	1-1/2"
1"	8VF8-E	1" - 11-1/2 NPTF	steel	2.10	53.3	1.99	50.5	1-13/16"
	8VF8-B-E	1" - 11-1/2 NPTF	brass	2.10	53.3	1.99	50.5	1-13/16"
	8VF8-SS-E	1" - 11-1/2 NPTF	316 stainless	2.10	53.3	1.99	50.5	1-13/16"
	8VBF8-E	1" - 11 BSPP	steel	2.10	53.3	1.99	50.5	1-13/16"
	8VBF8-B-E	1" - 11 BSPP	brass	2.10	53.3	1.99	50.5	1-13/16"
	8VBF8-SS-E	1" - 11 BSPP	316 stainless	2.10	53.3	1.99	50.5	1-13/16"
1-1/4"	10VF10-E	1-1/4" - 11-1/2 NPTF	steel	2.28	57.9	2.19	55.6	2"
	10VF10-B-E	1-1/4" - 11-1/2 NPTF	brass	2.28	57.9	2.19	55.6	2"
	10VF10-SS-E	1-1/4" - 11-1/2 NPTF	316 stainless	2.28	57.9	2.19	55.6	2"
	10VBF10-E	1-1/4" - 11 BSPP	steel	2.28	57.9	2.19	55.6	2"
	10VBF10-B-E	1-1/4" - 11 BSPP	brass	2.28	57.9	2.19	55.6	2"
	10VBF10-SS-E	1-1/4" - 11 BSPP	316 stainless	2.28	57.9	2.19	55.6	2"
1-1/2"	12VF12-E	1-1/2" - 11-1/2 NPTF	steel	2.57	65.3	2.74	69.6	2-1/2"
	12VF12-B-E	1-1/2" - 11-1/2 NPTF	brass	2.57	65.3	2.74	69.6	2-1/2"
	12VF12-SS-E	1-1/2" - 11-1/2 NPTF	316 stainless	2.57	65.3	2.74	69.6	2-1/2"
2"	16VF16-E	2" - 11-1/2 NPTF	steel	2.48	63.0	3.56	90.4	3-1/4"
	16VF16-B-E	2" - 11-1/2 NPTF	brass	2.48	63.0	3.56	90.4	3-1/4"
	16VF16-SS-E	2" - 11-1/2 NPTF	316 stainless	2.48	63.0	3.56	90.4	3-1/4"

Hydraulic Couplings: V-Series

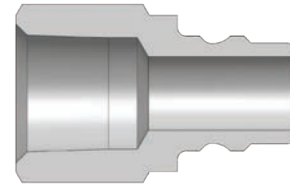
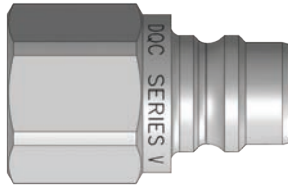

Body Size	V-Series MIL-C-51234 Unvalved Plug (Female Threads)							
	Part Detail			Length		Maximum OD		Hex inch
	Part #	Threads	Material	inch	mm	inch	mm	
1/4"	V2F2-E	1/4" - 18 NPTF	steel	1.27	32.3	0.69	17.5	5/8"
	V2F2-B-E	1/4" - 18 NPTF	brass	1.27	32.3	0.69	17.5	5/8"
	V2F2-SS-E	1/4" - 18 NPTF	316 stainless	1.27	32.3	0.69	17.5	5/8"
	V2BF2-E	1/4" - 19 BSPP	steel	1.27	32.3	0.69	17.5	5/8"
	V2BF2-B-E	1/4" - 19 BSPP	brass	1.27	32.3	0.69	17.5	5/8"
	V2BF2-SS-E	1/4" - 19 BSPP	316 stainless	1.27	32.3	0.69	17.5	5/8"
3/8"	V3F3-E	3/8" - 18 NPTF	steel	1.41	35.8	0.90	22.9	13/16"
	V3F3-B-E	3/8" - 18 NPTF	brass	1.41	35.8	0.90	22.9	13/16"
	V3F3-SS-E	3/8" - 18 NPTF	316 stainless	1.41	35.8	0.90	22.9	13/16"
	V3BF3-E	3/8" - 19 BSPP	steel	1.41	35.8	0.90	22.9	13/16"
	V3BF3-B-E	3/8" - 19 BSPP	brass	1.41	35.8	0.90	22.9	13/16"
1/2"	V4F4-E	1/2" - 14 NPTF	steel	1.72	43.7	1.10	27.9	1"
	V4F4-B-E	1/2" - 14 NPTF	brass	1.72	43.7	1.10	27.9	1"
	V4F4-SS-E	1/2" - 14 NPTF	316 stainless	1.72	43.7	1.10	27.9	1"
	V4BF4-E	1/2" - 14 BSPP	steel	1.72	43.7	1.10	27.9	1"
	V4BF4-B-E	1/2" - 14 BSPP	brass	1.72	43.7	1.10	27.9	1"
	V4BF4-SS-E	1/2" - 14 BSPP	316 stainless	1.72	43.7	1.10	27.9	1"
3/4"	V6F6-E	3/4" - 14 NPTF	steel	1.86	47.2	1.31	33.3	1-3/16"
	V6F6-B-E	3/4" - 14 NPTF	brass	1.86	47.2	1.31	33.3	1-3/16"
	V6F6-SS-E	3/4" - 14 NPTF	316 stainless	1.86	47.2	1.31	33.3	1-3/16"
	V6BF6-E	3/4" - 14 BSPP	steel	1.86	47.2	1.31	33.3	1-3/16"
	V6BF6-B-E	3/4" - 14 BSPP	brass	1.86	47.2	1.31	33.3	1-3/16"
1"	V8F8-E	1" - 11-1/2 NPTF	steel	2.08	52.8	1.65	41.9	1-1/2"
	V8F8-B-E	1" - 11-1/2 NPTF	brass	2.08	52.8	1.65	41.9	1-1/2"
	V8F8-SS-E	1" - 11-1/2 NPTF	316 stainless	2.08	52.8	1.65	41.9	1-1/2"
	V8BF8-E	1" - 11 BSPP	steel	2.08	52.8	1.65	41.9	1-1/2"
	V8BF8-B-E	1" - 11 BSPP	brass	2.08	52.8	1.65	41.9	1-1/2"
	V8BF8-SS-E	1" - 11 BSPP	316 stainless	2.08	52.8	1.65	41.9	1-1/2"
1-1/4"	V10F10-E	1-1/4" - 11-1/2 NPTF	steel	2.22	56.4	2.06	52.3	1-7/8"
	V10F10-B-E	1-1/4" - 11-1/2 NPTF	brass	2.22	56.4	2.06	52.3	1-7/8"
	V10F10-SS-E	1-1/4" - 11-1/2 NPTF	316 stainless	2.22	56.4	2.06	52.3	1-7/8"
	V10BF10-E	1-1/4" - 11 BSPP	steel	2.22	56.4	2.06	52.3	1-7/8"
	V10BF10-B-E	1-1/4" - 11 BSPP	brass	2.22	56.4	2.06	52.3	1-7/8"
1-1/2"	V12F12-E	1-1/2" - 11-1/2 NPTF	steel	2.44	62.0	2.33	59.2	2-1/8"
	V12F12-B-E	1-1/2" - 11-1/2 NPTF	brass	2.44	62.0	2.33	59.2	2-1/8"
	V12F12-SS-E	1-1/2" - 11-1/2 NPTF	316 stainless	2.44	62.0	2.33	59.2	2-1/8"
2"	V16F16-E	2" - 11-1/2 NPTF	steel	2.60	66.0	3.01	76.5	2-3/4"
	V16F16-B-E	2" - 11-1/2 NPTF	brass	2.60	66.0	3.01	76.5	2-3/4"
	V16F16-SS-E	2" - 11-1/2 NPTF	316 stainless	2.60	66.0	3.01	76.5	2-3/4"

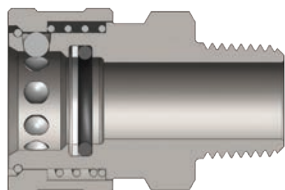

Body Size	V-Series MIL-C-51234 Unvalved Coupler (Male Threads)							
	Part Detail			Length		Maximum OD		Hex inch
	Part #	Threads	Material	inch	mm	inch	mm	
1/4"	2VM2-E	1/4" - 18 NPTF	steel	1.82	46.2	0.99	25.1	5/8"
	2VM2-B-E	1/4" - 18 NPTF	brass	1.82	46.2	0.99	25.1	5/8"
	2VM2-SS-E	1/4" - 18 NPTF	316 stainless	1.82	46.2	0.99	25.1	5/8"
3/8"	3VM3-E	3/8" - 18 NPTF	steel	1.76	44.7	1.18	30.0	13/16"
	3VM3-B-E	3/8" - 18 NPTF	brass	1.76	44.7	1.18	30.0	13/16"
	3VM3-SS-E	3/8" - 18 NPTF	316 stainless	1.76	44.7	1.18	30.0	13/16"
1/2"	4VM4-E	1/2" - 14 NPTF	steel	2.03	51.6	1.37	34.8	1"
	4VM4-B-E	1/2" - 14 NPTF	brass	2.03	51.6	1.37	34.8	1"
	4VM4-SS-E	1/2" - 14 NPTF	316 stainless	2.03	51.6	1.37	34.8	1"
3/4"	6VM6-E	3/4" - 14 NPTF	steel	2.29	58.2	1.67	42.4	1-3/16"
	6VM6-B-E	3/4" - 14 NPTF	brass	2.29	58.2	1.67	42.4	1-3/16"
	6VM6-SS-E	3/4" - 14 NPTF	316 stainless	2.29	58.2	1.67	42.4	1-3/16"
1"	8VM8-E	1" - 11-1/2 NPTF	steel	2.39	60.7	1.99	50.5	1-1/2"
	8VM8-B-E	1" - 11-1/2 NPTF	brass	2.39	60.7	1.99	50.5	1-1/2"
	8VM8-SS-E	1" - 11-1/2 NPTF	316 stainless	2.39	60.7	1.99	50.5	1-1/2"
1-1/4"	10VM10-E	1-1/4" - 11-1/2 NPTF	steel	2.78	70.6	2.19	55.6	1-7/8"
	10VM10-SS-E	1-1/4" - 11-1/2 NPTF	316 stainless	2.78	70.6	2.19	55.6	1-7/8"
1-1/2"	12VM12-E	1-1/2" - 11-1/2 NPTF	steel	3.08	78.2	2.74	69.6	2-1/8"
	12VM12-SS-E	1-1/2" - 11-1/2 NPTF	316 stainless	3.08	78.2	2.74	69.6	2-1/8"
2"	16VM16-E	2" - 11-1/2 NPTF	steel	3.10	78.7	3.56	90.4	2-1/2"
	16VM16-SS-E	2" - 11-1/2 NPTF	316 stainless	3.10	78.7	3.56	90.4	2-1/2"

Hydraulic Couplings: V-Series

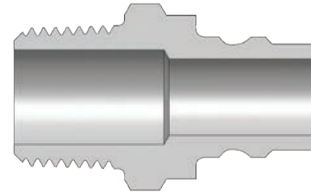
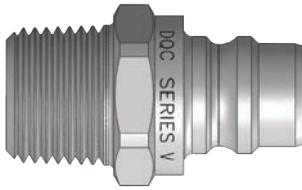

Body Size	V-Series MIL-C-51234 Unvalved Plug (Male Threads)							
	Part Detail			Length		Maximum OD		Hex inch
	Part #	Threads	Material	inch	mm	inch	mm	
1/4"	V2M2-E	1/4" - 18 NPTF	steel	1.52	38.6	0.69	17.5	5/8"
	V2M2-B-E	1/4" - 18 NPTF	brass	1.52	38.6	0.69	17.5	5/8"
	V2M2-SS-E	1/4" - 18 NPTF	316 stainless	1.52	38.6	0.69	17.5	5/8"
3/8"	V3M3-E	3/8" - 18 NPTF	steel	1.72	43.7	0.90	22.9	13-16"
	V3M3-B-E	3/8" - 18 NPTF	brass	1.72	43.7	0.90	22.9	13/16"
	V3M3-SS-E	3/8" - 18 NPTF	316 stainless	1.72	43.7	0.90	22.9	13/16"
1/2"	V4M4-E	1/2" - 14 NPTF	steel	1.80	45.7	1.10	27.9	1"
	V4M4-B-E	1/2" - 14 NPTF	brass	1.80	45.7	1.10	27.9	1"
	V4M4-SS-E	1/2" - 14 NPTF	316 stainless	1.80	45.7	1.10	27.9	1"
3/4"	V6M6-E	3/4" - 14 NPTF	steel	2.19	55.6	1.31	33.3	1-3/16"
	V6M6-B-E	3/4" - 14 NPTF	brass	2.19	55.6	1.31	33.3	1-3/16"
	V6M6-SS-E	3/4" - 14 NPTF	316 stainless	2.19	55.6	1.31	33.3	1-3/16"
1"	V8M8-E	1" - 11-1/2 NPTF	steel	2.31	58.7	1.65	41.9	1-1/2"
	V8M8-B-E	1" - 11-1/2 NPTF	brass	2.31	58.7	1.65	41.9	1-1/2"
	V8M8-SS-E	1" - 11-1/2 NPTF	316 stainless	2.31	58.7	1.65	41.9	1-1/2"
1-1/4"	V10M10-E	1-1/4" - 11-1/2 NPTF	steel	2.14	54.4	2.06	52.3	1-7/8"
	V10M10-SS-E	1-1/4" - 11-1/2 NPTF	316 stainless	2.14	54.4	2.06	52.3	1-7/8"
1-1/2"	V12M12-E	1-1/2" - 11-1/2 NPTF	steel	2.34	59.4	2.33	59.2	2-1/8"
	V12M12-SS-E	1-1/2" - 11-1/2 NPTF	316 stainless	2.34	59.4	2.33	59.2	2-1/8"
2"	V16M16-E	2" - 11-1/2 NPTF	steel	3.06	77.7	2.74	69.6	2-1/2"
	V16M16-SS-E	2" - 11-1/2 NPTF	316 stainless	3.06	77.7	2.74	69.6	2-1/2"



Body Size	V-Series Dust Caps and Dust Plugs		
	Part Detail		
	Coupler Dust Plug	Plug Dust Cap	Material
1/4"	1HDP	V2DC	nitrile
3/8"	3VDP-V3DC combination dust cap/plug		nitrile
1/2"	3KDP-K3DC combination dust cap/plug		nitrile
3/4"	6VDP-V6DC combination dust cap/plug		nitrile
1"	8VDP-V8DC combination dust cap/plug		nitrile



Body Size	V-Series Coupler Rigid Dust Plug		
	Part Detail		
	Part #	Lanyard	Body
1/4"	2VDP-A	steel cable	aluminum
3/8"	3VDP-A	steel cable	aluminum
1/2"	4VDP-A	steel cable	aluminum
3/4"	6VDP-A	steel cable	aluminum
1"	8VDP-A	steel cable	aluminum
1-1/4"	10VDP-A	steel cable	aluminum
1-1/2"	12VDP-A	steel cable	aluminum
2"	16VDP-A	steel cable	aluminum



Body Size	V-Series Plug Rigid Dust Cap		
	Part Detail		
	Part #	Lanyard	Body
1/4"	V2DC-A	steel cable	aluminum
3/8"	V3DC-A	steel cable	aluminum
1/2"	V4DC-A	steel cable	aluminum
3/4"	V6DC-A	steel cable	aluminum
1"	V8DC-A	steel cable	aluminum
1-1/4"	V10DC-A	steel cable	aluminum
1-1/2"	V12DC-A	steel cable	aluminum
2"	V16DC-A	steel cable	aluminum

Body Size	V-Series MIL-C-51234 Coupler Seal Kits			
	Part Detail			Seal Kit Contents
	Part #	Coupler Style	Seal Material	
1/4"	2V-SKIT	all	Nitrile	Body/adapter O-rings and PTFE back-up
	F-2V-SKIT	all	FKM	Body/adapter O-rings and PTFE back-up
	P-2V-SKIT	all	EPDM	Body/adapter O-rings and PTFE back-up
3/8"	3V-SKIT	all	Nitrile	Body/adapter O-rings and PTFE back-up
	F-3V-SKIT	all	FKM	Body/adapter O-rings and PTFE back-up
	P-3V-SKIT	all	EPDM	Body/adapter O-rings and PTFE back-up
1/2"	4V-SKIT	all	Nitrile	Body/adapter O-rings and PTFE back-up
	F-4V-SKIT	all	FKM	Body/adapter O-rings and PTFE back-up
	P-4V-SKIT	all	EPDM	Body/adapter O-rings and PTFE back-up
3/4"	6V-SKIT	all	Nitrile	Body/adapter O-rings and PTFE back-up
	F-6V-SKIT	all	FKM	Body/adapter O-rings and PTFE back-up
	P-6V-SKIT	all	EPDM	Body/adapter O-rings and PTFE back-up
1"	8V-SKIT	all	Nitrile	Body/adapter O-rings and PTFE back-up
	F-8V-SKIT	all	FKM	Body/adapter O-rings and PTFE back-up
	P-8V-SKIT	all	EPDM	Body/adapter O-rings and PTFE back-up
1-1/4"	10V-SKIT	all	Nitrile	Body/adapter/valve O-rings and back-up
	F-10V-SKIT	all	FKM	Body/adapter/valve O-rings and back-up
	P-10V-SKIT	all	EPDM	Body/adapter/valve O-rings and back-up
1-1/2"	12V-SKIT	all	Nitrile	Body/adapter/valve O-rings and back-up
	F-12V-SKIT	all	FKM	Body/adapter/valve O-rings and back-up
	P-12V-SKIT	all	EPDM	Body/adapter/valve O-rings and back-up
2"	16V-SKIT	all	Nitrile	Body/adapter/valve O-rings and back-up
	F-16V-SKIT	all	FKM	Body/adapter/valve O-rings and back-up
	P-16V-SKIT	all	EPDM	Body/adapter/valve O-rings and back-up

Body Size	V-Series MIL-C-51234 Coupler Repair Kits			
	Part Detail			Repair Kit Contents (for one coupler)
	Part #	Coupler Material	Seal Material	
1/4"	2V-RKIT	steel	nitrile	steel valve assembly and adapter O-ring
	2V-BRKIT	brass	nitrile	brass valve assembly and adapter O-ring
	2V-SSRKIT	316 stainless	nitrile	316 SS valve assembly and adapter O-ring
3/8"	3V-RKIT	steel	nitrile	steel valve assembly and adapter O-ring
	3V-BRKIT	brass	nitrile	brass valve assembly and adapter O-ring
	3V-SSRKIT	316 stainless	nitrile	316 SS valve assembly and adapter O-ring
1/2"	4V-RKIT	steel	nitrile	steel valve assembly and adapter O-ring
	4V-BRKIT	brass	nitrile	brass valve assembly and adapter O-ring
	4V-SSRKIT	316 stainless	nitrile	316 SS valve assembly and adapter O-ring
3/4"	6V-RKIT	steel	nitrile	steel valve assembly and adapter O-ring
	6V-BRKIT	brass	nitrile	brass valve assembly and adapter O-ring
	6V-SSRKIT	316 stainless	nitrile	316 SS valve assembly and adapter O-ring
1"	8V-RKIT	steel	nitrile	steel valve assembly and adapter O-ring
	8V-BRKIT	brass	nitrile	brass valve assembly and adapter O-ring
	8V-SSRKIT	316 stainless	nitrile	316 SS valve assembly and adapter O-ring
1-1/4"	140030-10	steel	nitrile	steel valve assembly and adapter O-ring
	140032-10	316 stainless	nitrile	316 SS valve assembly and adapter O-ring
1-1/2"	140030-12	steel	nitrile	steel valve assembly and adapter O-ring
	140032-12	316 stainless	nitrile	316 SS valve assembly and adapter O-ring
2"	140030-16	steel	nitrile	steel valve assembly and adapter O-ring
	140032-16	316 stainless	nitrile	316 SS valve assembly and adapter O-ring

Body Size	V-Series MIL-C-51234 Plug Repair Kits			
	Part Detail			Repair Kit Contents (for one plug)
	Part #	Coupler Material	Seal Material	
1/4"	V2-RKIT	steel	nitrile	steel valve assembly and adapter O-ring
	V2-BRKIT	brass	nitrile	brass valve assembly and adapter O-ring
	V2-SSRKIT	316 stainless	nitrile	316 SS valve assembly and adapter O-ring
3/8"	V3-RKIT	steel	nitrile	steel valve assembly and adapter O-ring
	V3-BRKIT	brass	nitrile	brass valve assembly and adapter O-ring
	V3-SSRKIT	316 stainless	nitrile	316 SS valve assembly and adapter O-ring
1/2"	V4-RKIT	steel	nitrile	steel valve assembly and adapter O-ring
	V4-BRKIT	brass	nitrile	brass valve assembly and adapter O-ring
	V4-SSRKIT	316 stainless	nitrile	316 SS valve assembly and adapter O-ring
3/4"	V6-RKIT	steel	nitrile	steel valve assembly and adapter O-ring
	V6-BRKIT	brass	nitrile	brass valve assembly and adapter O-ring
	V6-SSRKIT	316 stainless	nitrile	316 SS valve assembly and adapter O-ring
1"	V8-RKIT	steel	nitrile	steel valve assembly and adapter O-ring
	V8-BRKIT	brass	nitrile	brass valve assembly and adapter O-ring
	V8-SSRKIT	316 stainless	nitrile	316 SS valve assembly and adapter O-ring
1-1/4"	140030-10	steel	nitrile	steel valve assembly and adapter O-ring
	140032-10	316 stainless	nitrile	316 SS valve assembly and adapter O-ring
1-1/2"	140030-12	steel	nitrile	steel valve assembly and adapter O-ring
	140032-12	316 stainless	nitrile	316 SS valve assembly and adapter O-ring
2"	140030-16	steel	nitrile	steel valve assembly and adapter O-ring
	140032-16	316 stainless	nitrile	316 SS valve assembly and adapter O-ring

Hydraulic Couplings: TR-Series

Interchange Data

- European interchange
- TEMA 3800, 5000, 7500, 10000 Series
- CEJN Series 525

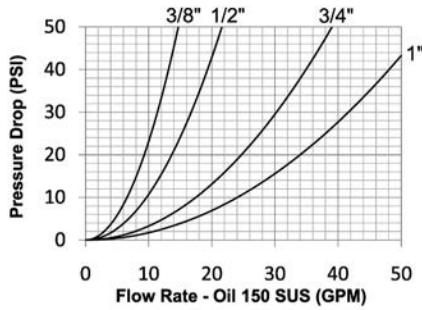

Materials

- Machined components are manufactured using solid steel bar stock
- Stainless steel balls, retaining rings, and springs maximize corrosion resistance and extend service life.
- Steel componentry is plated using ROHS-compliant trivalent chrome
- Steel coupler sleeves are hardened to resist deformation and maximize service life
- Steel plugs are hardened to provide heavy-duty performance

Seal Components

- Nitrile (Buna-N) seals are standard, providing a temperature range of -40°F to 250°F (-40°C to 121°C)
- Couplers have a redundant O-ring sealing system (dual O-rings with inner PTFE back-up ring)
- Valve seals are crimped in place to maintain integrity during excessive flow conditions and pressurized connection

Rated Pressure Chart

Body Size	TR-Series European Interchange (Connected)			
	Steel Coupler/Plug			
	Maximum Working		Burst	
	PSI	Bar	PSI	Bar
3/8"	5,000	345	20,000	1,400
1/2"	4,000	275	16,500	1,100
3/4"	4,000	275	15,400	1,000
1"	3,200	220	12,800	900

Technical Specifications

Body Size	Interchange Standards				Functional Parameters				
	U.S. Military	U.S. Government	International Standards	ANSI/NFPA Standards	Locking Ball Quantity	Air Inclusion	Fluid Loss	Vacuum inch HG	Flow ΔP = 22 PSI
3/8"	-	-	-	-	9	2.8cc	1.9cc	28	10 GPM
1/2"	-	-	-	-	9	3.9cc	3.1cc	28	15 GPM
3/4"	-	-	-	-	9	10.5cc	10.1cc	28	26 GPM
1"	-	-	-	-	9	14.7cc	14.2cc	28	36 GPM

TR Interchange Profiles

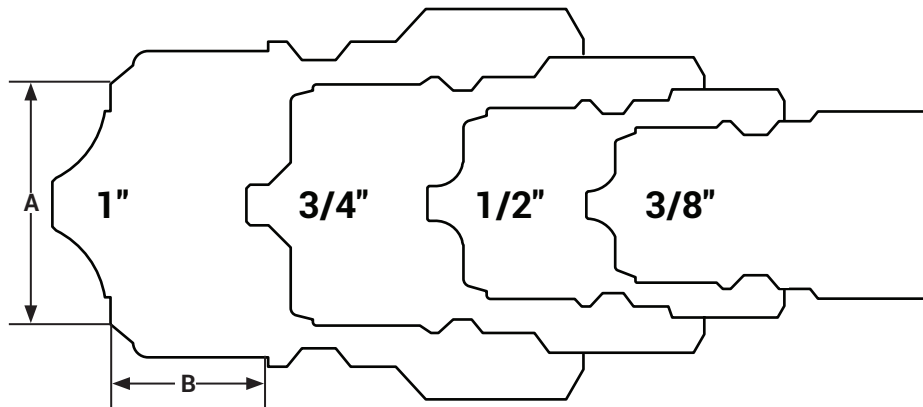

Body Size	A	B
3/8"	0.78	0.53
1/2"	0.97	0.60
3/4"	1.29	0.75
1"	1.61	0.85

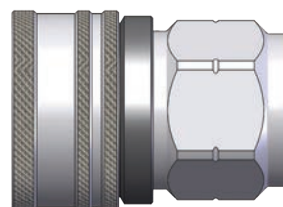
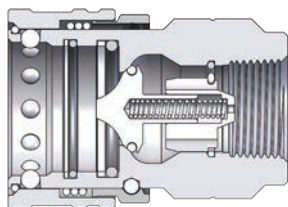

Body Size	TR-Series European Interchange Coupler (Female Threads)							
	Part Detail			Length		Maximum OD		Hex mm
	Part #	Threads	Material	inch	mm	inch	mm	
3/8"	3TRF3	3/8" - 18 NPTF	steel	2.52	64.0	1.38	35.0	30
	3TRBF3	3/8" - 19 BSPP	steel	2.52	64.0	1.38	35.0	30
1/2"	4TRF4	1/2" - 14 NPTF	steel	2.62	66.5	1.57	40.0	36
	4TRBF4	1/2" - 14 BSPP	steel	2.62	66.5	1.57	40.0	36
3/4"	6TRF6	3/4" - 14 NPTF	steel	3.35	85.0	2.05	52.0	41
	6TRBF6	3/4" - 14 BSPP	steel	3.35	85.0	2.05	52.0	41
1"	8TRF8	1" - 11-1/2 NPTF	steel	3.90	99.0	2.56	65.0	55
	8TRBF8	1" - 11 BSPP	steel	3.90	99.0	2.56	65.0	55

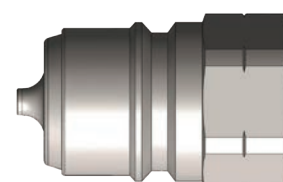
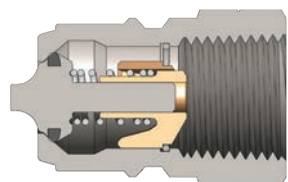

Body Size	TR-Series European Interchange Plug (Female Threads)							
	Part Detail			Length		Maximum OD		Hex mm
	Part #	Threads	Material	inch	mm	inch	mm	
3/8"	TR3F3	3/8" - 18 NPTF	steel	1.59	40.5	1.00	25.4	22
	TR3BF3	3/8" - 19 BSPP	steel	1.59	40.5	1.00	25.4	22
1/2"	TR4F4	1/2" - 14 NPTF	steel	1.63	41.5	1.23	31.1	27
	TR4BF4	1/2" - 14 BSPP	steel	1.63	41.5	1.23	31.1	27
3/4"	TR6F6	3/4" - 14 NPTF	steel	2.20	56.0	1.63	41.5	36
	TR6BF6	3/4" - 14 BSPP	steel	2.20	56.0	1.63	41.5	36
1"	TR8F8	1" - 11-1/2 NPTF	steel	2.48	63.0	2.09	53.0	46
	TR8BF8	1" - 11 BSPP	steel	2.48	63.0	2.09	53.0	46

Body Size	TR-Series European Coupler Seal Kits			
	Part Detail			Seal Kit Contents
	Part #	Coupler Style	Seal Material	
3/8"	3TR-SKIT	all	nitrile	two O-rings and two PTFE back-up ring
1/2"	4TR-SKIT	all	nitrile	two O-rings and two PTFE back-up ring
3/4"	6TR-SKIT	all	nitrile	two O-rings and two PTFE back-up ring
1"	8TR-SKIT	all	nitrile	two O-rings and one PTFE back-up ring

Please contact Dixon for dust caps and dust plugs.

Interchange Data

- Interchangeable to ISO16028
- Parker FEM-Series, Holmbury HQ-Series, Hansen FF, Eaton/Aeroquip FD89, Stucchi FIRG/Series A, Faster FFH/FFN/FFI/2FFN/2FFI, Safeway FF49-Series

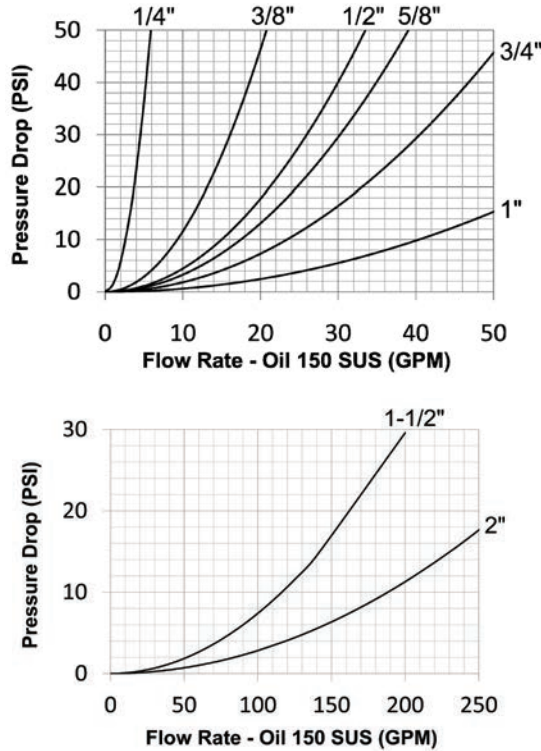

Materials

- Machined components are manufactured using solid steel or 316 stainless steel bar stock
- Stainless steel balls, retaining rings, and springs maximize corrosion resistance and extend service life
- Steel componentry is plated using ROHS compliant zinc nickel for corrosion resistance
- Steel coupler sleeves are hardened to resist deformation and maximize service life
- Steel plugs are hardened to provide resistance to brinelling during impulse service

Seal Components

- 1/4", 3/8", 1/2", 3/4", and 1" plugs have molded polyurethane valve seals, with a temperature range of -65°F to 212°F (-54°C to 100°C)
- 5/8" and 2" plugs have nitrile-energized PTFE valve seals, with a temperature range of -40°F to 250°F (-40°C to 121°C)
- Couplers have a polyurethane valve stem O-ring, with a temperature range of -65°F to 212°F (-54°C to 100°C)
- Ancillary coupler and plug seals are nitrile (buna-N), with a temperature range of -40°F to 250°F (-40°C to 121°C)
- PTFE or TPC-ET anti-extrusion ring protects main coupling valve seal from dynamic impulse pressure damage

HT-Series Correct Connect®

- Blue bands standard, color bands sold separately
- Contact Dixon for additional color band builds
- No special tools required
- Polyurethane color bands

Rated Pressure Chart

Body Size	HT-Series ISO16028 Flushface															
	Steel Coupler/Plug Coupled				316 SS Coupler/Plug Coupled				Steel Coupler Uncoupled				Steel Plug Uncoupled			
	Max. Working		Burst		Max. Working		Burst		Max. Working		Burst		Max. Working		Burst	
	PSI	Bar	PSI	Bar	PSI	Bar	PSI	Bar	PSI	Bar	PSI	Bar	PSI	Bar	PSI	Bar
1/4"	5,000	345	20,000	1,379	-	-	-	-	5,000	345	20,000	1,379	5,000	345	20,000	1,379
3/8"	5,000	345	20,000	1,379	3,500	241	17,500	1,207	5,000	345	20,000	1,379	5,000	345	20,000	1,379
1/2"	5,000	345	20,000	1,379	3,400	234	17,000	1,172	5,000	345	20,000	1,379	5,000	345	20,000	1,379
5/8"	5,000	345	20,000	1,379	2,920	201	14,600	1,007	5,000	345	20,000	1,379	5,000	345	20,000	1,379
3/4"	5,000	345	20,000	1,379	2,920	201	14,600	1,007	5,000	345	20,000	1,379	5,000	345	20,000	1,379
1"	5,000	345	20,000	1,379	2,920	201	14,600	1,007	5,000	345	20,000	1,379	5,000	345	20,000	1,379
1-1/2"	3,000	207	12,000	828	-	-	-	-	3,000	207	12,000	828	3,000	207	12,000	828
2"	3,000	207	12,000	828	-	-	-	-	3,000	207	12,000	828	3,000	207	12,000	828

Technical Specifications

Body Size	Interchange Standards				Functional Parameters					
	U.S. Military	U.S. Government	International Standards	ANSI/NFPA Standards	Locking Ball Quantity	Air Inclusion	Fluid Loss	Vacuum inch HG	Flow ΔP = 15 PSI	
1/4"	-	-	ISO16028	-	12	n/a	0.010cc	N/R	3.2 GPM	
3/8"	-	-	ISO16028	T3.20.15	12	n/a	0.010cc	N/R	11.0 GPM	
1/2"	-	-	ISO16028	-	12	n/a	0.010cc	N/R	18.0 GPM	
5/8"	-	-	ISO16028	-	12	n/a	0.020cc	N/R	21.0 GPM	
3/4"	-	-	ISO16028	-	12	n/a	0.030cc	N/R	28.0 GPM	
1"	-	-	ISO16028	-	12	n/a	0.030cc	N/R	50.0 GPM	
1-1/2"	-	-	-	-	18	n/a	0.050cc	N/R	140.0 GPM	
2"	-	-	-	-	20	n/a	0.070cc	N/R	225.0 GPM	



Color Bands Part # Guide

Body Size	Description	Blue Part #	Orange Part #	Green Part #	Yellow Part #	Red Part #
1/4"	coupler band	2HTBAND-B	2HTBAND-O	2HTBAND-G	2HTBAND-Y	2HTBAND-R
1/4"	plug band	HT2BAND-B	HT2BAND-O	HT2BAND-G	HT2BAND-Y	HT2BAND-R
3/8"	coupler band	3HTBAND-B	3HTBAND-O	3HTBAND-G	3HTBAND-Y	3HTBAND-R
3/8"	plug band	HT3BAND-B	HT3BAND-O	HT3BAND-G	HT3BAND-Y	HT3BAND-R
1/2"	coupler band	4HTBAND-B	4HTBAND-O	4HTBAND-G	4HTBAND-Y	4HTBAND-R
1/2"	plug band	HT4BAND-B	HT4BAND-O	HT4BAND-G	HT4BAND-Y	HT4BAND-R
5/8"	coupler band	5HTBAND-B	5HTBAND-O	5HTBAND-G	5HTBAND-Y	5HTBAND-R
5/8"	plug band	HT5BAND-B	HT5BAND-O	HT5BAND-G	HT5BAND-Y	HT5BAND-R
3/4"	coupler band	6HTBAND-B	6HTBAND-O	6HTBAND-G	6HTBAND-Y	6HTBAND-R
3/4"	plug band	HT6BAND-B	HT6BAND-O	HT6BAND-G	HT6BAND-Y	HT6BAND-R
1"	coupler band	8HTBAND-B	8HTBAND-O	8HTBAND-G	8HTBAND-Y	8HTBAND-R
1"	plug band	HT8BAND-B	HT8BAND-O	HT8BAND-G	HT8BAND-Y	HT8BAND-R

Available Options

Body Size	Standard Seal Options						Kalrez® Seal Options			Treatments
	FKM	EPDM	FDA FKM	Mil-Nitrile	Fuel Nitrile	Silicone	4079	6375	7075	Oxy-Clean
1/4"	F-	P-	D-	M-	JF-	S-	K4-	K6-	K7-	-C1
3/8"	F-	P-	D-	M-	JF-	S-	K4-	K6-	K7-	-C1
1/2"	F-	P-	D-	M-	JF-	S-	K4-	K6-	K7-	-C1
5/8"	F-	P-	D-	M-	JF-	S-	K4-	K6-	K7-	-C1
3/4"	F-	P-	D-	M-	JF-	S-	K4-	K6-	K7-	-C1
1"	F-	P-	D-	M-	JF-	S-	K4-	K6-	K7-	-C1
1-1/2"	F-	P-	D-	M-	JF-	S-	K4-	K6-	K7-	-C1
2"	F-	P-	D-	M-	JF-	S-	K4-	K6-	K7-	-C1

HT Series Profile

Body Size	A	B
1/4"	0.64	0.22
3/8"	0.78	0.19
1/2"	0.97	0.39
5/8"	1.06	0.39
3/4"	1.18	0.45
1"	1.42	0.43

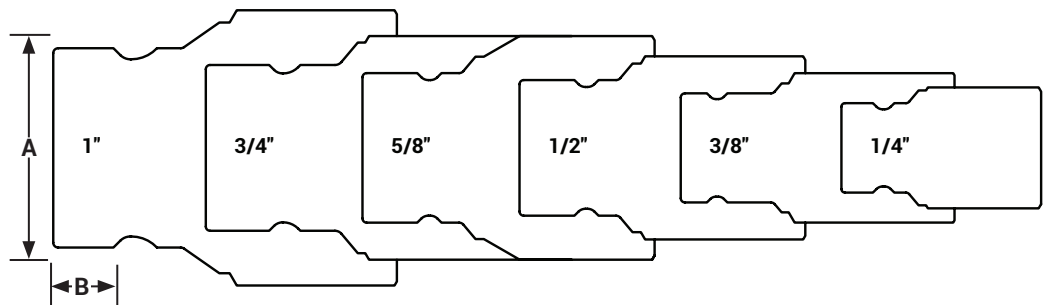

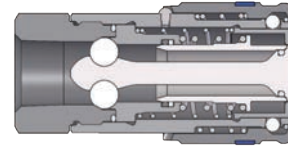

Body Size	HT-Series ISO16028 Flushface Interchange Coupler (Female Threads)							
	Part Detail			Length		Maximum OD		Hex inch
	Part #	Threads	Material	inch	mm	inch	mm	
1/4"	2HTF2	1/4" - 18 NPTF	steel	1.98	50.3	1.11	28.3	7/8"
	2HTBF2	1/4" - 19 BSPP	steel	1.98	50.3	1.11	28.3	7/8"
	2HTOF3	9/16" - 18 ORB	steel	1.98	50.3	1.11	28.3	7/8"
3/8"	3HTF3	3/8" - 18 NPTF	steel	2.50	63.5	1.24	31.5	1"
	3HTF3-SS	3/8" - 18 NPTF	316 stainless	2.50	63.5	1.24	31.5	1"
	3HTBF3	3/8" - 19 BSPP	steel	2.50	63.5	1.24	31.5	1"
	3HTBF3-SS	3/8" - 19 BSPP	316 stainless	2.50	63.5	1.24	31.5	1"
	3HTOF3	9/16" - 18 ORB	steel	2.50	63.5	1.24	31.5	1"
	3HTF4	1/2" - 14 NPTF	steel	2.72	69.1	1.24	31.5	1-1/8"
	3HTF4-SS	1/2" - 14 NPTF	316 stainless	2.72	69.1	1.24	31.5	1-1/8"
	3HTBF4	1/2" - 14 BSPP	steel	2.72	69.1	1.24	31.5	1-1/8"
	3HTBF4-SS	1/2" - 14 BSPP	316 stainless	2.72	69.1	1.24	31.5	1-1/8"
1/2"	3HTOF4	3/4" - 16 ORB	steel	2.72	69.1	1.24	31.5	1-1/8"
	4HTF4	1/2" - 14 NPTF	steel	3.02	76.7	1.54	39.1	1-3/16"
	4HTF4-SS	1/2" - 14 NPTF	316 stainless	3.02	76.7	1.54	39.1	1-3/16"
	4HTBF4	1/2" - 14 BSPP	steel	3.02	76.7	1.54	39.1	1-3/16"
	4HTBF4-SS	1/2" - 14 BSPP	316 stainless	3.02	76.7	1.54	39.1	1-3/16"
	4HTOF4	3/4" - 16 ORB	steel	3.02	76.7	1.54	39.1	1-3/16"
	4HTF6	3/4" - 14 NPTF	steel	3.22	81.8	1.54	39.1	1-5/16"
	4HTF6-SS	3/4" - 14 NPTF	316 stainless	3.22	81.8	1.54	39.1	1-5/16"
	4HTBF6	3/4" - 14 BSPP	steel	3.22	81.8	1.54	39.1	1-5/16"
	4HTBF6-SS	3/4" - 14 BSPP	316 stainless	3.22	81.8	1.54	39.1	1-5/16"
	4HTOF6	1-1/16" - 12 ORB	steel	3.42	86.9	1.54	39.1	1-5/16"
	5/8"	5HTOF5	7/8" - 14 ORB	steel	3.32	84.3	1.67	42.4
5HTF6		3/4" - 14 NPTF	steel	3.32	84.3	1.67	42.4	1-1/2"
5HTF6-SS		3/4" - 14 NPTF	316 stainless	3.32	84.3	1.67	42.4	1-1/2"
5HTBF6		3/4" - 14 BSPP	steel	3.32	84.3	1.67	42.4	1-1/2"
5HTBF6-SS		3/4" - 14 BSPP	316 stainless	3.32	84.3	1.67	42.4	1-1/2"
5HTOF6		1-1/16" - 12 ORB	steel	3.32	84.3	1.67	42.4	1-1/2"
3/4"	6HTOF5	7/8" - 14 ORB	steel	3.70	94.0	1.85	47.0	1-1/2"
	6HTF6	3/4" - 14 NPTF	steel	3.70	94.0	1.85	47.0	1-1/2"
	6HTF6-SS	3/4" - 14 NPTF	316 stainless	3.70	94.0	1.85	47.0	1-1/2"
	6HTBF6	3/4" - 14 BSPP	steel	3.70	94.0	1.85	47.0	1-1/2"
	6HTBF6-SS	3/4" - 14 BSPP	316 stainless	3.70	94.0	1.85	47.0	1-1/2"
	6HTOF6	1-1/16" - 12 ORB	steel	3.70	94.0	1.85	47.0	1-1/2"
	6HTF8	1" - 11-1/2 NPTF	steel	3.82	97.0	1.92	48.8	1-3/4"
	6HTF8-SS	1" - 11-1/2 NPTF	316 stainless	3.82	97.0	1.92	48.8	1-3/4"
	6HTBF8	1" - 11 BSPP	steel	3.82	97.0	1.92	48.8	1-3/4"
	6HTBF8-SS	1" - 11 BSPP	316 stainless	3.82	97.0	1.92	48.8	1-3/4"
1"	6HTOF8	1-5/16" - 12 ORB	steel	3.82	97.0	1.92	48.8	1-3/4"
	8HTF8	1" - 11-1/2 NPTF	steel	4.24	107.7	2.29	58.2	1-3/4"
	8HTF8-SS	1" - 11-1/2 NPTF	316 stainless	4.24	107.7	2.29	58.2	1-3/4"
	8HTBF8	1" - 11 BSPP	steel	4.24	107.7	2.29	58.2	1-3/4"
	8HTBF8-SS	1" - 11 BSPP	316 stainless	4.24	107.7	2.29	58.2	1-3/4"
	8HTOF8	1-5/16" - 12 ORB	steel	4.24	107.7	2.29	58.2	1-3/4"
	8HTF10	1-1/4" - 11-1/2 NPTF	steel	4.34	110.2	2.29	58.2	2"
	8HTF10-SS	1-1/4" - 11-1/2 NPTF	316 stainless	4.34	110.2	2.29	58.2	2"
	8HTBF10	1-1/4" - 11 BSPP	steel	4.29	109.0	2.29	58.2	2"
	8HTBF10-SS	1-1/4" - 11 BSPP	316 stainless	4.29	109.0	2.29	58.2	2"
	8HTOF10	1-5/8" - 12 ORB	steel	4.24	107.7	2.29	58.2	2"

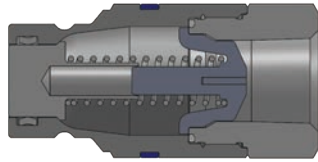

Body Size	HT-Series ISO16028 Flushface Interchange Plug (Female Threads)							
	Part Detail			Length		Maximum OD		Hex inch
	Part #	Threads	Material	inch	mm	inch	mm	
1/4"	HT2F2	1/4" - 18 NPTF	steel	1.89	48.0	0.97	24.6	7/8"
	HT2BF2	1/4" - 19 BSPP	steel	1.89	48.0	0.97	24.6	7/8"
	HT2OF3	9/16" - 18 ORB	steel	1.89	48.0	0.97	24.6	7/8"
3/8"	HT3F3	3/8" - 18 NPTF	steel	2.48	63.0	1.10	27.9	1"
	HT3F3-SS	3/8" - 18 NPTF	316 stainless	2.48	63.0	1.10	27.9	1"
	HT3BF3	3/8" - 19 BSPP	steel	2.48	63.0	1.10	27.9	1"
	HT3BF3-SS	3/8" - 19 BSPP	316 stainless	2.48	63.0	1.10	27.9	1"
	HT3OF3	9/16" - 18 ORB	steel	2.48	63.0	1.10	27.9	1"
	HT3F4	1/2" - 14 NPTF	steel	2.70	68.6	1.24	31.5	1-1/8"
	HT3F4-SS	1/2" - 14 NPTF	316 stainless	2.70	68.6	1.24	31.5	1-1/8"
	HT3BF4	1/2" - 14 BSPP	steel	2.70	68.6	1.24	31.5	1-1/8"
	HT3BF4-SS	1/2" - 14 BSPP	316 stainless	2.70	68.6	1.24	31.5	1-1/8"
1/2"	HT4F4	3/4" - 16 ORB	steel	2.70	68.6	1.24	31.5	1-1/8"
	HT4F4-SS	3/4" - 16 ORB	316 stainless	2.70	68.6	1.24	31.5	1-1/8"
	HT4BF4	1/2" - 14 NPTF	steel	2.63	66.8	1.31	33.3	1-3/16"
	HT4BF4-SS	1/2" - 14 NPTF	316 stainless	2.63	66.8	1.31	33.3	1-3/16"
	HT4BF4	1/2" - 14 BSPP	steel	2.63	66.8	1.31	33.3	1-3/16"
	HT4BF4-SS	1/2" - 14 BSPP	316 stainless	2.63	66.8	1.31	33.3	1-3/16"
	HT4OF4	3/4" - 16 ORB	steel	2.63	66.8	1.31	33.3	1-3/16"
	HT4OF5	7/8" - 14 ORB	steel	2.63	69.3	1.31	33.3	1-5/16"
	HT4F6	3/4" - 14 NPTF	steel	2.73	71.9	1.44	36.6	1-5/16"
5/8"	HT4F6-SS	3/4" - 14 NPTF	316 stainless	2.83	71.9	1.44	36.6	1-5/16"
	HT4BF6	3/4" - 14 BSPP	steel	2.83	71.9	1.44	36.6	1-5/16"
	HT4BF6-SS	3/4" - 14 BSPP	316 stainless	2.83	71.9	1.44	36.6	1-5/16"
	HT4OF6	1-1/16" - 12 ORB	steel	3.03	77.0	1.44	36.6	1-5/16"
	HT5OF5	7/8" - 14 ORB	steel	2.88	73.2	1.65	41.9	1-1/2"
	HT5F6	3/4" - 14 NPTF	steel	2.88	73.2	1.65	41.9	1-1/2"
	HT5F6-SS	3/4" - 14 NPTF	316 stainless	2.88	73.2	1.65	41.9	1-1/2"
	HT5BF6	3/4" - 14 BSPP	steel	2.88	73.2	1.65	41.9	1-1/2"
	HT5BF6-SS	3/4" - 14 BSPP	316 stainless	2.88	73.2	1.65	41.9	1-1/2"
3/4"	HT5OF6	1-1/16" - 12 ORB	steel	2.88	73.2	1.65	41.9	1-1/2"
	HT6OF5	7/8" - 14 ORB	steel	3.42	86.9	1.65	41.9	1-1/2"
	HT6F6	3/4" - 14 NPTF	steel	3.42	86.9	1.65	41.9	1-1/2"
	HT6F6-SS	3/4" - 14 NPTF	316 stainless	3.42	86.9	1.65	41.9	1-1/2"
	HT6BF6	3/4" - 14 BSPP	steel	3.42	86.9	1.65	41.9	1-1/2"
	HT6BF6-SS	3/4" - 14 BSPP	316 stainless	3.42	86.9	1.65	41.9	1-1/2"
	HT6OF6	1-1/16" - 12 ORB	steel	3.42	86.9	1.65	41.9	1-1/2"
	HT6F8	1" - 11-1/2 NPTF	steel	3.54	89.9	1.92	48.8	1-3/4"
	HT6F8-SS	1" - 11-1/2 NPTF	316 stainless	3.54	89.9	1.92	48.8	1-3/4"
1"	HT6BF8	1" - 11 BSPP	steel	3.54	89.9	1.92	48.8	1-3/4"
	HT6BF8-SS	1" - 11 BSPP	316 stainless	3.54	89.9	1.92	48.8	1-3/4"
	HT6OF8	1-5/16" - 12 ORB	steel	3.54	89.9	1.92	48.8	1-3/4"
	HT8F8	1" - 11-1/2 NPTF	steel	3.50	88.9	1.96	49.8	1-3/4"
	HT8F8-SS	1" - 11-1/2 NPTF	316 stainless	3.50	88.9	1.96	49.8	1-3/4"
	HT8BF8	1" - 11 BSPP	steel	3.50	88.9	1.96	49.8	1-3/4"
	HT8BF8-SS	1" - 11 BSPP	316 stainless	3.50	88.9	1.96	49.8	1-3/4"
	HT8OF8	1-5/16" - 12 ORB	steel	3.50	88.9	1.96	49.8	1-3/4"
	HT8F10	1-1/4" - 11-1/2 NPTF	steel	3.61	91.7	2.19	55.6	2"
1"	HT8F10-SS	1-1/4" - 11-1/2 NPTF	316 stainless	3.61	91.7	2.19	55.6	2"
	HT8BF10	1-1/4" - 11 BSPP	steel	3.55	90.2	2.19	55.6	2"
	HT8BF10-SS	1-1/4" - 11 BSPP	316 stainless	3.55	90.2	2.19	55.6	2"
	HT8OF10	1-5/8" - 12 ORB	steel	3.51	89.2	2.19	55.6	2"

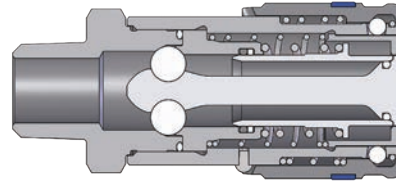

HT-Series ISO16028 Flushface Interchange Coupler (Male Threads)

Body Size	Part Detail			Length		Maximum OD		Hex inch
	Part #	Threads	Material	inch	mm	inch	mm	
	3/8"	3HTM3	3/8" - 18 NPTF	steel	2.88	73.2	1.24	
	3HTM4	1/2" - 14 NPTF	steel	2.97	75.4	1.24	31.5	1-1/8"
1/2"	4HTM4	1/2" - 14 NPTF	steel	3.42	86.9	1.54	39.1	1-5/16"

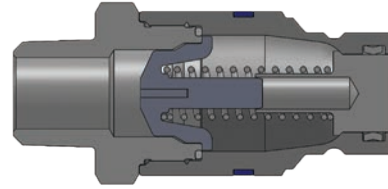
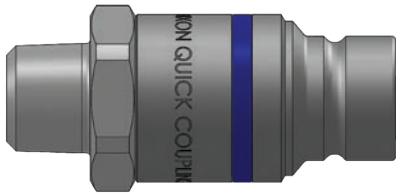

HT-Series ISO16028 Flushface Interchange Plug (Male Threads)

Body Size	Part Detail			Length		Maximum OD		Hex inch
	Part #	Threads	Material	inch	mm	inch	mm	
	3/8"	HT3M3	3/8" - 18 NPTF	steel	2.87	72.9	1.24	
	HT3M4	1/2" - 14 NPTF	steel	2.96	75.2	1.24	31.5	1-1/8"
1/2"	HT4M4	1/2" - 14 NPTF	steel	3.03	77.0	1.44	36.6	1-5/16"

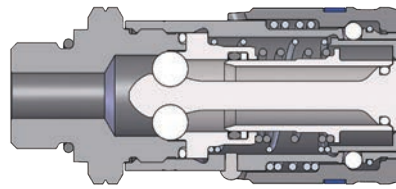

HT-Series ISO16028 Flushface Interchange Coupler (Male ORB Threads)

Body Size	Part Detail			Length		Maximum OD		Hex inch
	Part #	Threads	Material	inch	mm	inch	mm	
	3/8"	3HTOM3	9/16" - 18 ORB	steel	2.75	69.9	1.24	
	3HTOM4	3/4" - 16 ORB	steel	2.75	69.9	1.24	31.5	1-1/8"

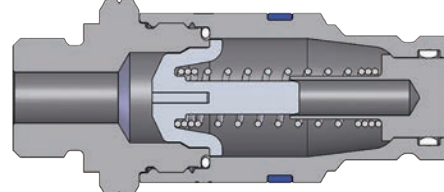

HT-Series ISO16028 Flushface Interchange Plug (Male ORB Threads)

Body Size	Part Detail			Length		Maximum OD		Hex inch
	Part #	Threads	Material	inch	mm	inch	mm	
	3/8"	HT30M3	9/16" - 18 ORB	steel	2.73	69.3	1.17	
	HT30M4	3/4" - 16 ORB	steel	2.73	69.3	1.17	29.7	1-1/8"

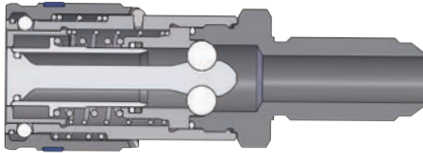

Body Size	HT-Series ISO16028 Flushface Interchange Coupler (Male Bulkhead Threads)							
	Part Detail			Length		Maximum OD		Hex inch
	Part #	Threads	Material	inch	mm	inch	mm	
1/2"	4HTRB4	13/16"-16 ORFS BH	steel	4.19	106.4	1.54	39.1	1-5/16"
	4HTJB5	7/8" - 14 JIC BH	steel	4.38	111.3	1.54	39.1	1-5/16"
	4HTRB5	1" - 14 ORFS BH	steel	4.37	111.0	1.54	39.1	1-5/16"
	4HTRB6	1-3/16"-12 ORFS BH	steel	4.40	111.7	1.54	39.1	1-5/16"
	4HTJB6	1-1/16" - 12 JIC BH	steel	4.55	115.6	1.54	39.1	1-5/16"

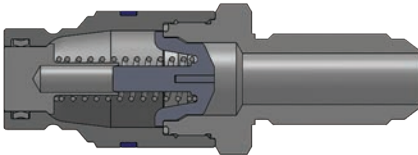

Body Size	HT-Series ISO16028 Flushface Interchange Plug (Male Bulkhead Threads)							
	Part Detail			Length		Maximum OD		Hex inch
	Part #	Threads	Material	inch	mm	inch	mm	
1/2"	HT4RB4	13/16"-16 ORFS BH	steel	3.83	97.2	1.44	36.5	1-5/16"
	HT4JB5	7/8" - 14 JIC BH	steel	3.99	101.3	1.44	36.6	1-5/16"
	HT4RB5	1" - 14 ORFS BH	steel	3.98	101.1	1.44	36.6	1-5/16"
	HT4RB6	1-3/16"-12 ORFS BH	steel	4.00	101.6	1.44	36.5	1-5/16"
	HT4JB6	1-1/16" - 12 JIC BH	steel	4.16	115.6	1.44	36.6	1-5/16"

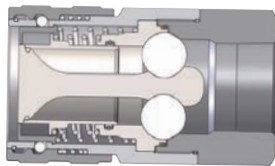

Body Size	HT-Series ISO16028 Flushface Interchange Coupler (Female Threads)							
	Part Detail			Length		Maximum OD		Hex inch
	Part #	Threads	Material	inch	mm	inch	mm	
1-1/2"	12HTF12	1-1/2" - 11-1/2 NPT	steel	5.23	132.7	3.37	85.5	2-1/2"
	12HTBF12	1-1/2 - 11 BSPP	steel	5.23	132.7	3.37	85.5	2-1/2"
	12HTOF12	1-7/8" - 12 ORB	steel	5.23	132.7	3.37	85.5	2-1/2"
2"	16HTF16	2" - 11-1/2 NPTF	steel	6.75	171.3	3.95	100.3	3-1/2"
	16HTBF16	2" - 11 BSPP	steel	6.75	171.3	3.95	100.3	3-1/2"
	16HTOF16	2-1/2" - 12 ORB	steel	6.75	171.3	3.95	100.3	3-1/2"

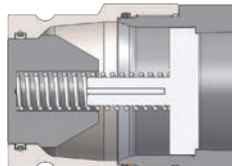

Body Size	HT-Series ISO16028 Flushface Interchange Plug (Female Threads)							
	Part Detail			Length		Maximum OD		Hex inch
	Part #	Threads	Material	inch	mm	inch	mm	
1-1/2"	HT12F12	1-1/2" - 11-1/2 NPT	steel	4.25	107.9	2.75	69.8	2-1/2"
	HT12BF12	1-1/2 - 11 BSPP	steel	4.25	107.9	2.75	69.8	2-1/2"
	HT12OF12	1-7/8" - 12 ORB	steel	4.25	107.9	2.75	69.8	2-1/2"
2"	HT16F16	2" - 11-1/2 NPTF	steel	4.62	117.3	3.29	83.5	3"
	HT16BF16	2" - 11 BSPP	steel	4.62	117.3	3.29	83.5	3"
	HT16OF16	2-1/2" - 12 ORB	steel	4.62	117.3	3.29	83.5	3"

Hydraulic Couplings: HT-Series Correct Connect®

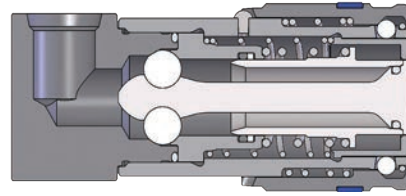

Body Size	HT-Series Flushface 90° Female Threaded Coupler							
	Part Detail			Length		Maximum OD		Hex inch
	Part #	Threads	Material	inch	mm	inch	mm	
1/2"	4HT90F3	9/16"-18 ORB	steel	3.30	83.82	1.53	38.86	1-3/8"
	4HT90F4	3/4"-16 ORB	steel	3.42	86.87	1.68	42.55	1-1/2"

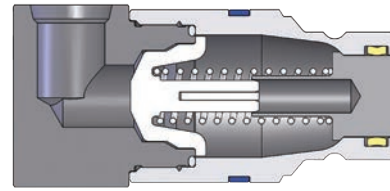

Body Size	HT-Series Flushface 90° Female Threaded Plug							
	Part Detail			Length		Maximum OD		Hex inch
	Part #	Threads	Material	inch	mm	inch	mm	
1/2"	HT490F3	9/16"-18 ORB	steel	2.90	73.66	1.53	38.86	1-3/8"
	HT490F4	3/4"-16 ORB	steel	3.03	76.96	1.68	42.67	1-1/2"

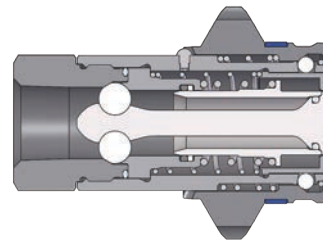
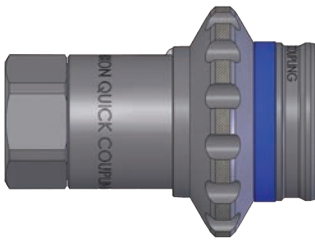

Body Size	HT-Series ISO16028 Flushface Interchange Coupler with Flange Sleeve							
	Part Detail			Length		Maximum OD		Hex inch
	Part #	Threads	Material	inch	mm	inch	mm	
1/4"	2HTF2-FS	1/4" - 18 NPTF	steel	1.98	50.3	1.50	38.1	7/8"
3/8"	3HTF3-FS	3/8" - 18 NPTF	steel	2.50	63.5	1.75	44.45	1"
1/2"	4HTF4-FS	1/2" - 14 NPTF	steel	3.02	76.7	2.25	57.15	1-3/16"
3/4"	6HTF6-FS	3/4" - 14 NPTF	steel	3.70	94	2.50	63.5	1-1/2"
1"	8HTF8-FS	1" - 11-1/2 NPTF	steel	4.24	107.7	2.50	63.5	1-3/4"



Body Size	HT-Series ISO16028 Flushface Plug Dust Cap		
	Part Detail		
	Part #		Body
1/4"	2HTDP		nitrile
3/8"	3HTDP		nitrile
1/2"	4HTDP		nitrile
5/8"	5HTDP		nitrile
3/4"	6HTDP		nitrile
1"	8HTDP		nitrile



Body Size	HT-Series ISO16028 Flushface Plug Dust Cap		
	Part Detail		
	Part #		Body
1/4"	HT2DC		nitrile
3/8"	HT3DC		nitrile
1/2"	HT4DC		nitrile
5/8"	HT5DC		nitrile
3/4"	HT6DC		nitrile
1"	HT8DC		nitrile

Body Size	HT-Series ISO16028 Flushface Interchange Coupler Seal Kits			
	Part Detail			Seal Kit Contents
	Part #	Coupler Style	Seal Material	
1/4"	2HT-SKIT	all	nitrile	stem/adaptor/gland O-ring, gland B.U.
3/8"	3HT-SKIT	all	nitrile	stem/adaptor/gland O-ring, gland B.U.
1/2"	4HT-SKIT	all	nitrile	stem/adaptor/gland O-ring, gland B.U.
5/8"	5HT-SKIT	all	nitrile	stem/adaptor/gland O-ring, gland B.U.
3/4"	6HT-SKIT	all	nitrile	stem/adaptor/gland O-ring, gland B.U.
1"	8HT-SKIT	all	nitrile	stem/adaptor/gland O-ring, gland B.U.

Body Size	HT-Series ISO16028 Flushface Interchange Plug Seal Kits			
	Part Detail			Seal Kit Contents
	Part #	Plug Style	Seal Material	
1/4"	HT2-SKIT-V2	all	nitrile	main valve seal and adapter O-ring
3/8"	HT3-SKIT-V2	all	nitrile	main valve seal and adapter O-ring
1/2"	HT4-SKIT-V2	all	nitrile	main valve seal and adapter O-ring
5/8"	HT5-SKIT-V2	all	nitrile	main valve seal and adapter O-ring
3/4"	HT6-SKIT-V2	all	nitrile	main valve seal and adapter O-ring
1"	HT8-SKIT-V2	all	nitrile	main valve seal and adapter O-ring

Hydraulic Couplings: HTE-Series

Interchange Data

- Parker FEC-Series, Stucchi APM-Series, Faster 3FFH-Series

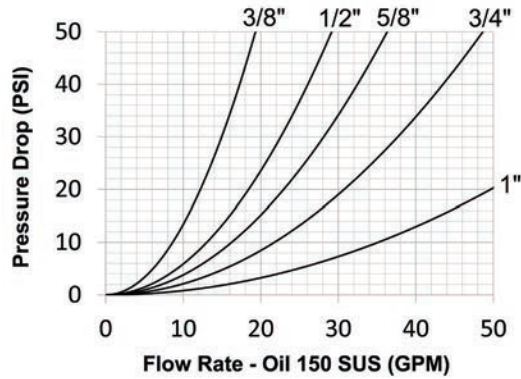

Materials

- Machined components are manufactured using solid steel bar stock
- Steel componentry is plated using a ROHS compliant zinc-nickel process providing corrosion resistance
- Stainless steel retaining rings and springs maximize corrosion resistance and extend service life
- Plugs are hardened to provide resistance to brinelling during impulse service

Seal Components

- 3/8", 1/2", 3/4", and 1" plugs have molded polyurethane valve seals, with a temperature range of -65°F to 212°F (-54°C to 100°C)
- 5/8" plugs have nitrile-energized PTFE valve seals, with a temperature range of -40°F to 250°F (-40°C to 121°C)
- Ancillary plug seals are nitrile (buna-N), with a temperature range of -40°F to 250°F (-40°C to 121°C)
- Backup rings for all sizes are PTFE

Component Terminology

- Non-linear connection force at many pressures
- No maximum connection-pressure restrictions
- Head pressure or valve bleed-by has minimal effect on connection force
- Less susceptible to system contamination
- Design is scalable performing similarly in many sizes
- Smooth connection action

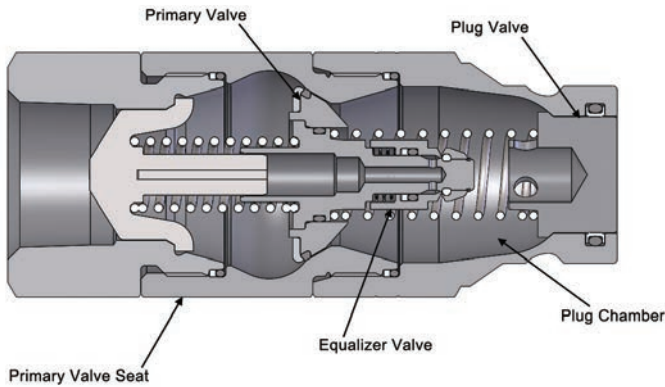

Rated Pressure Chart

Body Size	HTE-Series ISO16028 Connect Under Pressure Flushface Plug											
	Steel HT Coupler/ HTE-Plug Coupled				HTE-Plug Uncoupled				Air Inclusion	Fluid Loss	Vacuum inch HG	Flow ΔP = 14.5 PSI
	Max. Working		Burst		Max. Working		Burst					
	PSI	Bar	PSI	Bar	PSI	Bar	PSI	Bar				
3/8"	5,000	345	20,000	1,380	5,000	345	20,000	1,380	n/a	0.010cc	N/R	9.5 GPM
1/2"	5,000	345	20,000	1,380	5,000	345	20,000	1,380	n/a	0.010cc	N/R	15.0 GPM
5/8"	5,000	345	20,000	1,380	5,000	345	20,000	1,380	n/a	0.020cc	N/R	18.0 GPM
3/4"	5,000	345	20,000	1,380	5,000	345	20,000	1,380	n/a	0.030cc	N/R	24.0 GPM
1"	5,000	345	20,000	1,380	5,000	345	20,000	1,380	n/a	0.030cc	N/R	44.0 GPM

The Connection Process

Stage 1: The Disconnected State

The plug has residual pressure trapped behind the primary valve, while the coupler has no trapped pressure.

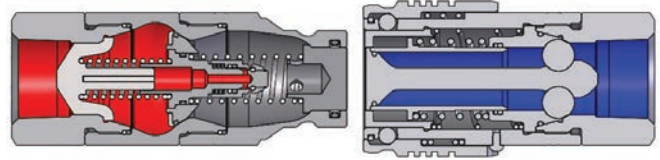

Stage 2: Plug Chamber Evacuated

The plug valve is opened, then the socket valve opens, evacuating the plug chamber to the unpressurized socket.

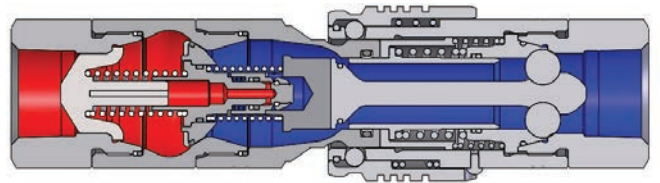

Stage 3: Release Pressure

The connection continues, with the valve being activated, releasing the trapped pressure into the plug chamber, then to the unpressurized socket.

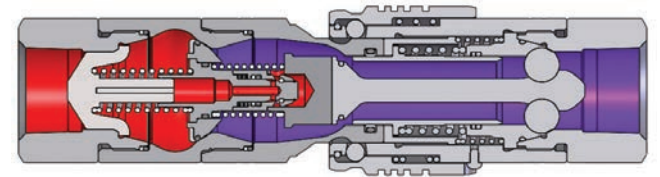

Stage 4: Complete the Connection

The primary valve can now open easily, since there is no longer any pressure trapped behind it, allowing the socket to fully engage the plug.

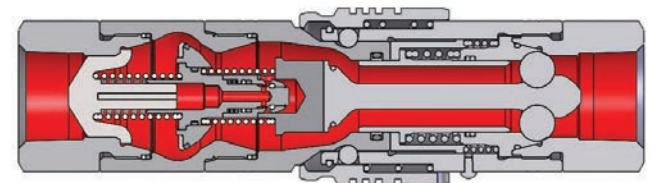

Hydraulic Couplings: HTE-Series

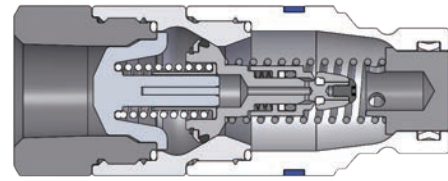

- For use with HT-Series couplers

Body Size	HTE-Series ISO 16028 Connect Under Pressure Flushface Plug (Female Threads)							
	Part Detail			Length		Maximum OD		Hex inch
	Part #	Threads	Material	inch	mm	inch	mm	
3/8"	HTE3F3	3/8" - 18 NPTF	steel	3.21	81.4	1.31	33.3	1-3/16"
	HTE3F4	1/2" - 14 NPTF	steel	3.25	82.6	1.30	33.0	1-1/8"
	HTE3BF4	1/2" - 14 BSPP	steel	3.25	82.6	1.30	33.0	1-1/8"
	HTE3OF4	3/4" - 16 ORB	steel	3.25	82.6	1.30	33.0	1-1/8"
1/2"	HTE4F4	1/2" - 14 NPTF	steel	3.40	86.4	1.30	33.0	1-3/16"
	HTE4BF4	1/2" - 14 BSPP	steel	3.40	86.4	1.30	33.0	1-3/16"
	HTE4OF4	3/4" - 16 ORB	steel	3.40	86.4	1.30	33.0	1-3/16"
	HTE4OF5	7/8" - 14 ORB	steel	3.40	86.4	1.30	33.0	1-1/2"
	HTE4F6	3/4" - 14 NPTF	steel	3.60	91.4	1.65	41.9	1-1/2"
	HTE4BF6	3/4" - 14 BPSS	steel	3.60	91.4	1.65	41.9	1-1/2"
	HTE4OF6	1-1/16" - 12 ORB	steel	3.60	91.4	1.65	41.9	1-1/2"
5/8"	HTE5OF5	7/8" - 14 ORB	steel	3.75	95.3	1.65	41.9	1-1/2"
	HTE5F6	3/4" - 14 NPTF	steel	3.75	95.3	1.65	41.9	1-1/2"
	HTE5BF6	3/4" - 14 BSPP	steel	3.75	95.3	1.65	41.9	1-1/2"
	HTE5OF6	1-1/16" - 12 ORB	steel	3.75	95.3	1.65	41.9	1-1/2"
3/4"	HTE6F6	3/4" - 14 NPTF	steel	4.25	108.0	1.96	49.8	1-1/2"
	HTE6BF6	3/4" - 14 BSPP	steel	4.25	108.0	1.96	49.8	1-1/2"
	HTE6OF6	1-1/16" - 12 ORB	steel	4.25	108.0	1.96	49.8	1-1/2"
	HTE6F8	1" - 11-1/2 NPTF	steel	4.40	111.8	1.96	49.8	1-3/4"
	HTE6BF8	1" - 11 BSPP	steel	4.40	111.8	1.96	49.8	1-3/4"
	HTE6OF8	1-5/16" - 12 ORB	steel	4.40	111.8	1.96	49.8	1-3/4"
1"	HTE8F8	1" - 11-1/2 NPTF	steel	4.88	124.0	1.96	49.8	1-3/4"
	HTE8BF8	1" - 11 BSPP	steel	4.88	124.0	1.96	49.8	1-3/4"
	HTE8OF8	1-5/16" - 12 ORB	steel	4.88	124.0	1.96	49.8	1-3/4"
	HTE8F10	1-1/4" - 11-1/2 NPTF	steel	5.00	127.0	2.47	62.7	2-3/16"
	HTE8BF10	1-1/4" - 11 BSPP	steel	5.00	127.0	2.47	62.7	2-3/16"
	HTE8OF10	1-5/8" - 12 ORB	steel	5.00	127.0	2.47	62.7	2-3/16"

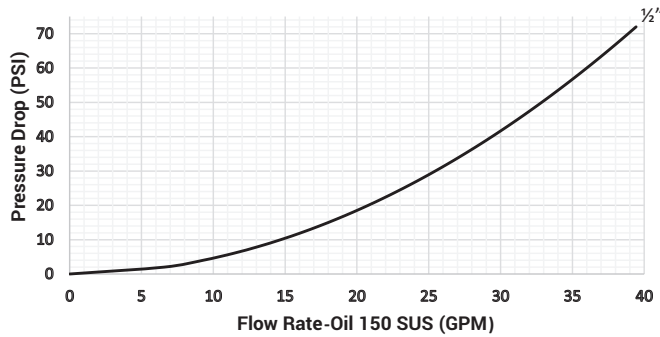

Interchange Data

- Interchangeable to ISO16028

Materials

- Machined components are manufactured using solid steel or 316 stainless steel bar stock
- Stainless steel balls, retaining rings, and springs maximize corrosion resistance and extend service life
- Steel componentry is plated using ROHS compliant zinc-nickel for corrosion resistance
- Steel coupler sleeves are hardened to resist deformation and maximize service life
- Steel plugs are hardened to provide resistance to brinelling during impulse service

Seal Components

- 1/2" plugs have molded polyurethane valve seals, with a temperature range of -65°F to 212°F (-54°C to 100°C)
- Couplers have a polyurethane valve stem O-ring, with a temperature range of -65°F to 212°F (-54°C to 100°C)
- Ancillary coupler and plug seals are nitrile (buna-N), with a temperature range of -40°F to 250°F (-40°C to 121°C)
- PTFE or TPC-ET anti-extrusion ring protects main coupling valve seal from dynamic impulse pressure damage

Rated Pressure Chart

Body Size	HTZ-Series ISO16028 Flushface															
	Steel Coupler/Plug Coupled				316 SS Coupler/Plug Coupled				Steel Coupler Uncoupled				Steel Plug Uncoupled			
	Max. Working		Burst		Max. Working		Burst		Max. Working		Burst		Max. Working		Burst	
	PSI	Bar	PSI	Bar	PSI	Bar	PSI	Bar	PSI	Bar	PSI	Bar	PSI	Bar	PSI	Bar
1/2"	5,000	345	20,000	1,379	3,400	234	17,000	1,172	5,000	345	20,000	1,379	5,000	345	20,000	1,379

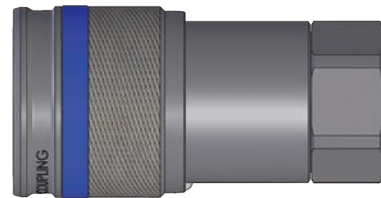
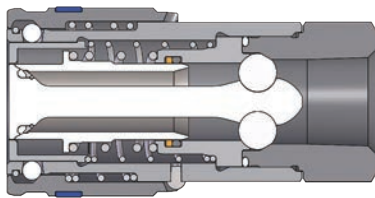

Body Size	HTZ-Series ISO16028 Connect Under Pressure Flush Face Coupler							
	Part Detail			Length		Maximum OD		Hex inch
	Part #	Threads	Material	inch	mm	inch	mm	
1/2"	4HTZF4	1/2" -14 NPTF	steel	3.00	76.20	1.54	39.12	1-3/16"
	4HTZF6	3/4" - 14 NPTF	steel	3.22	81.79	1.65	41.91	1-1/2"
	4HTZOF4	3/4" - 16 ORB	steel	3.00	76.20	1.54	39.12	1-3/16"
	4HTZOF5	7/8" - 14 ORB	steel	3.22	81.79	1.65	41.91	1-1/2"
	4HTZOF6	1-1/16" - 12 ORB	steel	3.22	81.79	1.65	41.91	1-1/2"

Hydraulic Couplings: HT-AG-Series

Interchange Data

- Agricultural Interchange, Parker/Pioneer 4000 Series, Faster NS/NV-Series, Safeway Series-S20, and Stucchi IR-Series
- Conforms to ISO16028 interchange standard, with Eaton/Hansen FF, Parker FEM, Faster FFH/2FFN/2FFI, Stucchi A/FIRG, and Holmbury HQ/A/FIMC

Materials

- Machined components are manufactured using solid bar stock
- Stainless steel balls, retaining rings, and springs maximize corrosion resistance and extend service life
- Steel componentry is plated using ROHS-compliant trivalent chrome
- Steel coupler sleeves are hardened to resist deformation and maximize service life

Seal Components

- HT-series couplers have polyurethane valve stem O-ring, with a temperature range of **-65° to 212°F (-54°C to 100°C)**
- Ancillary HT-series coupler seals are nitrile (Buna-N), with a temperature range of **-40°F to 250°F (-40°C to 121°C)**
- PTFE or TPC-ET anti-extrusion ring protects main coupling valve seal from dynamic impulse pressure damage
- Nitrile (Buna-N) seals are standard in AG-series coupler and plug
- AG-series couplers have a PTFE anti-extrusion ring

4AGHT4 Flow Chart

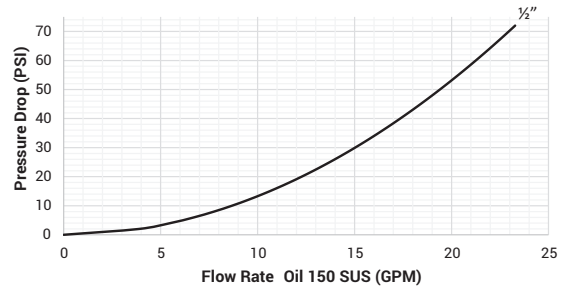

4HTAG4 Flow Chart

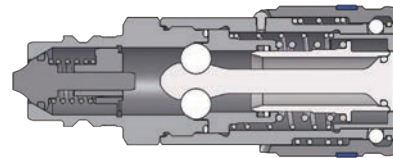
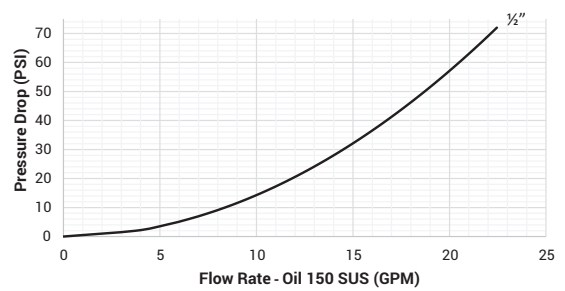

HT-AG-Series Flushface ISO16028 Coupler x ISO7241-A AG Plug Adapter

Body Size	Part Detail		Length		Maximum OD	
	Part #	Material	inch	mm	inch	mm
	1/2"	4HTAG4	steel	3.89	98.81	1.57

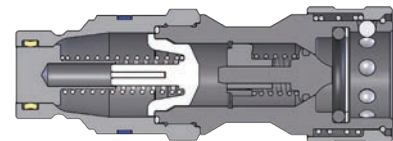

HT-AG-Series ISO7241-A AG Coupler x ISO16028 Flushface Plug Adapter

Body Size	Part Detail		Length		Maximum OD	
	Part #	Material	inch	mm	inch	mm
	1/2"	4AGHT4	steel	4.15	105.41	1.51

Interchange Data

- 10K Flushface
- Interchanges with Parker FH-Series

Materials

- Machined components are manufactured using solid bar stock
- Stainless steel balls, retaining rings, and springs maximize corrosion resistance and extend service life
- Steel componentry is plated using ROHS-compliant zinc nickel for corrosion resistance
- Steel plugs are hardened to provide resistance to brinelling

Seal Components

- Plugs have molded polyurethane valve seals, with a temperature range of **-65°F to 212°F (-54°C to 100°C)**
- Couplers have a polyurethane valve stem O-ring, with a temperature range of **-65°F to 212°F (-54°C to 100°C)**
- Ancillary coupler and plug seals are nitrile (buna-N), with a temperature range of **-40°F to 250°F (-40°C to 121°C)**
- PTFE or TPC-ET anti-extrusion ring protects main coupling valve seal from dynamic impulse pressure damage

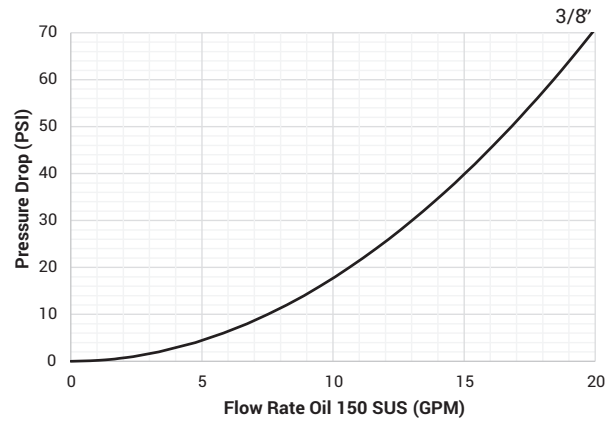

Feature

- Automatic locking mechanism

NOTE: Contact Dixon for 1/4" body size

Rated Pressure Chart

Body Size	XK-Series 10K Flushface							
	Max. Working		Connected Burst		Disconnected Burst Coupler		Disconnected Burst Plug	
	PSI	Bar	PSI	Bar	PSI	Bar	PSI	Bar
3/8"	10,000	690	30,000	2068	28,000	1930	27,000	1860

Technical Specifications

Body Size	Interchange Standards				Functional Parameters			
	U.S. Military	U.S. Government	International Standards	ANSI/NFPA Standards	Air Inclusion	Fluid Loss	Vacuum inch HG	Flow $\Delta P = 15$ PSI
3/8"	-	-	-	-	n/a	0.010cc	N/R	9.2 GPM

Hydraulic Couplings: XK-Series

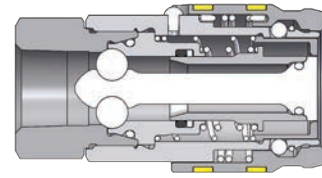

Body Size	XK-Series 10K Flushface Coupler (Female Threads)							
	Part Detail			Length		Maximum OD		Hex inch
	Part #	Threads	Material	inch	mm	inch	mm	
3/8"	3XKF3	3/8" - 18 NPTF	steel	2.41	61.21	1.31	33.27	1"

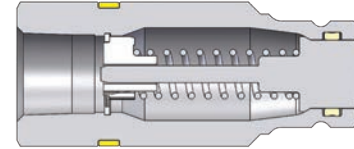

Body Size	XK-Series 10K Flushface Plug (Female Threads)							
	Part Detail			Length		Maximum OD		Hex inch
	Part #	Threads	Material	inch	mm	inch	mm	
3/8"	XK3F3	3/8" - 18 NPTF	steel	2.50	63.5	1.07	27.18	1"

Interchange Data

- Interchangeable with Parker/Snap-Tite 71-Series

Materials

- Machined components are manufactured using solid steel or 316 stainless bar stock
- Stainless steel balls, retaining rings, and springs maximize corrosion resistance and extend service life
- Steel componentry is plated using ROHS-compliant trivalent chrome
- Steel coupler sleeves are hardened to resist deformation and maximize service life
- Steel plugs are hardened to provide heavy-duty performance

Seal Components

- Nitrile (Buna-N) seals are standard, providing a temperature range of -40°F to 250°F (-40°C to 121°C)
- All couplers and plugs incorporate PTFE anti-extrusion rings to protect the seal components from dynamic impulse damage

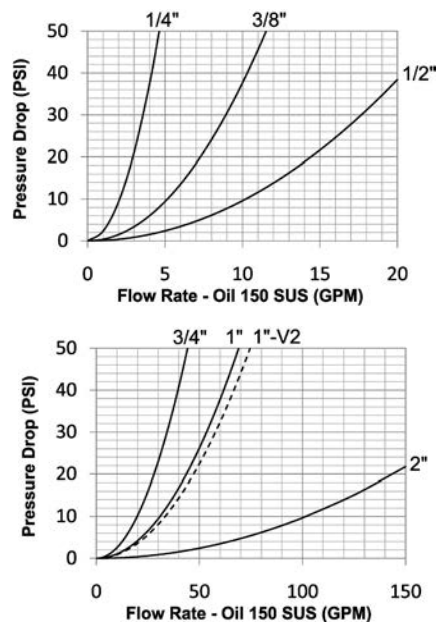

Rated Pressure Chart

Body Size	ST-Series Heavy-Duty Flushface							
	Steel Coupler/Plug Coupled				316 Stainless Coupler/Plug Coupled			
	Maximum Working		Burst		Maximum Working		Burst	
	PSI	Bar	PSI	Bar	PSI	Bar	PSI	Bar
1/4"	10,000	700	27,300	1,800	5,000	345	28,000	1,900
3/8"	10,000	700	27,300	1,800	5,000	345	28,000	1,900
1/2"	10,000	700	22,500	1,500	5,000	345	25,000	1,700
3/4"	7,500	500	20,200	1,400	5,000	345	22,800	1,550
1"	7,500	500	19,400	1,300	4,000	275	18,500	1,250
1"-V2	8,500	585	25,900	1,750	-	-	-	-
2"	5,000	345	16,000	1,100	3,000	200	10,000	700

Technical Specifications

Body Size	Interchange Standards				Functional Parameters				
	U.S. Military	U.S. Government	International Standards	ANSI/NFPA Standards	Locking Ball Quantity	Air Inclusion	Fluid Loss	Vacuum inch HG	Flow ΔP = 22 PSI
1/4"	-	-	-	-	10	0.01cc	0.02cc	N/R	3.1 GPM
3/8"	-	-	-	-	10	0.02cc	0.02cc	N/R	7.7 GPM
1/2"	-	-	-	-	12	0.03cc	0.03cc	N/R	15.0 GPM
3/4"	-	-	-	-	12	0.04cc	0.06cc	N/R	30.0 GPM
1"	-	-	-	-	12	0.06cc	0.07cc	N/R	45.0 GPM
1"-V2	-	-	-	-	12	0.09cc	0.10cc	N/R	50.0 GPM
2"	-	-	-	-	15	3.14cc	5.25cc	N/R	150.0 GPM

Available Options

Body Size	Standard Seal Options				Kalrez® Seal Options			Sleeve	Treatments
	FKM	EPDM	Mil-Nitrile	Fuel Nitrile	4079	6375	7075	Locking	Oxy-Clean
1/4"	F-	P-	M-	JF-	K4-	K6-	K7-	-LS	-C1
3/8"	F-	P-	M-	JF-	K4-	K6-	K7-	-LS	-C1
1/2"	F-	P-	M-	JF-	K4-	K6-	K7-	-LS	-C1
3/4"	F-	P-	M-	JF-	K4-	K6-	K7-	-LS	-C1
1"	F-	P-	M-	JF-	K4-	K6-	K7-	-LS	-C1
1"-V2	F-	P-	M-	JF-	K4-	K6-	K7-	-LS	-C1
2"	F-	P-	M-	JF-	K4-	K6-	K7-	-LS	-C1

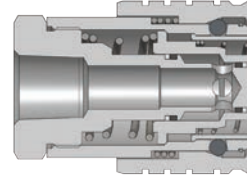
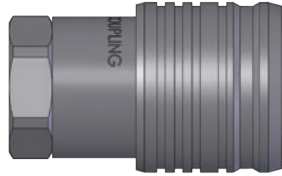

Body Size	ST-Series Heavy-Duty Flushface Coupler (Female Threads)							
	Part Detail			Length		Maximum OD		Hex inch
	Part #	Threads	Material	inch	mm	inch	mm	
1/4"	2STF2	1/4" - 18 NPTF	steel	1.96	49.8	1.23	31.2	15/16"
	2STF2-SS	1/4" - 18 NPTF	316 stainless	1.96	49.8	1.23	31.2	15/16"
	2STBF2	1/4" - 19 BSPP	steel	1.96	49.8	1.23	31.2	15/16"
	2STBF2-SS	1/4" - 19 BSPP	316 stainless	1.96	49.8	1.23	31.2	15/16"
3/8"	3STF2	1/4" - 18 NPTF	steel	2.36	59.9	1.60	40.6	1-3/16"
	3STF3	3/8" - 18 NPTF	steel	2.36	59.9	1.60	40.6	1-3/16"
	3STF3-SS	3/8" - 18 NPTF	316 stainless	2.36	59.9	1.60	40.6	1-3/16"
	3STBF3	3/8" - 19 BSPP	steel	2.36	59.9	1.60	40.6	1-3/16"
	3STBF3-SS	3/8" - 19 BSPP	316 stainless	2.36	59.9	1.60	40.6	1-3/16"
	3STF4	1/2" - 14 NPTF	steel	2.36	59.9	1.60	40.6	1-3/16"
	3STF4-SS	1/2" - 14 NPTF	316 stainless	2.36	59.9	1.60	40.6	1-3/16"
	3STBF4	1/2" - 14 BSPP	steel	2.36	59.9	1.60	40.6	1-3/16"
1/2"	3STBF4-SS	1/2" - 14 BSPP	316 stainless	2.36	59.9	1.60	40.6	1-3/16"
	4STF4	1/2" - 14 NPTF	steel	2.77	70.4	1.98	50.3	1-1/2"
	4STF4-SS	1/2" - 14 NPTF	316 stainless	2.77	70.4	1.98	50.3	1-1/2"
	4STBF4	1/2" - 14 BSPP	steel	2.77	70.4	1.98	50.3	1-1/2"
	4STBF4-SS	1/2" - 14 BSPP	316 stainless	2.77	70.4	1.98	50.3	1-1/2"
3/4"	4STOF4	3/4" - 16 ORB	steel	2.77	70.4	1.98	50.3	1-1/2"
	6STF6	3/4" - 14 NPTF	steel	3.03	77.0	2.35	59.7	1-3/4"
	6STF6-SS	3/4" - 14 NPTF	316 stainless	3.03	77.0	2.35	59.7	1-3/4"
	6STBF6	3/4" - 14 BSPP	steel	3.03	77.0	2.35	59.7	1-3/4"
	6STBF6-SS	3/4" - 14 BSPP	316 stainless	3.03	77.0	2.35	59.7	1-3/4"
1"	6STOF6	1-1/16" - 12 ORB	steel	3.03	77.0	2.35	59.7	1-3/4"
	8STF8	1" - 11-1/2 NPTF	steel	3.33	84.6	2.73	69.3	2"
	8STF8-SS	1" - 11-1/2 NPTF	316 stainless	3.33	84.6	1.55	39.3	2"
	8STBF8	1" - 11 BSPP	steel	3.33	84.6	2.73	69.3	2"
	8STBF8-SS	1" - 11 BSPP	316 stainless	3.33	84.6	2.73	69.3	2"
	8STOF8	1-5/16" - 12 ORB	steel	3.33	84.6	2.73	69.3	2"
	8STF10	1-1/4" - 11-1/2 NPTF	steel	3.67	93.2	2.73	69.3	2"
	8STF10-SS	1-1/4" - 11-1/2 NPTF	316 stainless	3.67	93.2	2.73	69.3	2"
	8STBF10	1-1/4" - 11 BSPP	steel	3.67	93.2	2.73	69.3	2"
	8STBF10-SS	1-1/4" - 11 BSPP	316 stainless	3.67	93.2	2.73	69.3	2"
	8STOF10	1-5/8" - 12 ORB	steel	3.67	93.2	2.73	69.3	2"

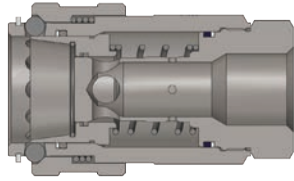

Body Size	ST-Series Heavy-Duty Flushface Coupler (Female Threads)							
	Part Detail			Length		Maximum OD		Hex inch
	Part #	Threads	Material	inch	mm	inch	mm	
2"	16STF12	1-1/2" - 11-1/2 NPTF	steel	6.20	157.5	4.47	113.5	3.78"
	16STBF12	1-1/2" - 11 BSPP	steel	6.20	157.5	4.47	113.5	3.78"
	16STOF12	1-7/8" - 12 ORB	steel	6.20	157.5	4.47	113.5	3.78"
	16STF16	2" - 11-1/2 NPTF	steel	6.20	157.5	4.47	113.5	3.78"
	16STF16-SS	2" - 11-1/2 NPTF	316 stainless	6.20	157.5	4.47	113.5	3.78"
	16STBF16	2" - 11 BSPP	steel	6.20	157.5	4.47	113.5	3.78"
	16STOF16	2-1/2" - 12 ORB	steel	6.20	157.5	4.47	113.5	3.78"

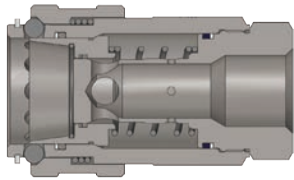

Body Size	ST-Series Heavy-Duty Flushface 'Old Style' Coupler (Female Threads)							
	Part Detail			Length		Maximum OD		Hex inch
	Part #	Threads	Material	inch	mm	inch	mm	
1"	8STF8-V2	1" - 11-1/2 NPTF	steel	4.55	115.6	2.74	69.6	2"
	8STBF8-V2	1" - 11 BSPP	steel	4.55	115.6	2.74	69.6	2"
	8STF10-V2	1-1/4" - 11-1/2 NPTF	steel	4.90	124.5	2.74	69.6	2"

ST-Series Profiles

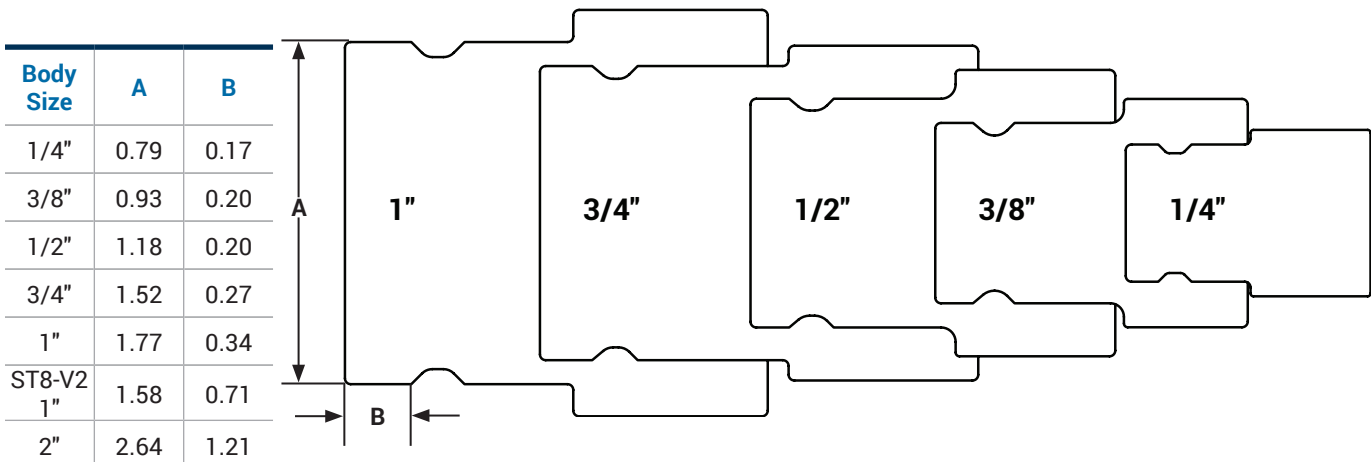

Hydraulic Couplings: ST-Series

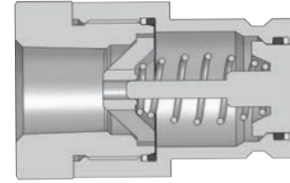

Body Size	ST-Series Heavy-Duty Flushface Plug (Female Threads)							
	Part Detail			Length		Maximum OD		Hex inch
	Part #	Threads	Material	inch	mm	inch	mm	
1/4"	ST2F2	1/4" - 18 NPTF	steel	1.84	46.7	0.90	22.9	13/16"
	ST2F2-SS	1/4" - 18 NPTF	316 stainless	1.84	46.7	0.90	22.9	13/16"
	ST2BF2	1/4" - 19 BSPP	steel	1.84	46.7	0.90	22.9	13/16"
	ST2BF2-SS	1/4" - 19 BSPP	316 stainless	1.84	46.7	0.90	22.9	13/16"
3/8"	ST3F2	1/4" - 18 NPTF	steel	2.32	58.9	1.48	37.6	1"
	ST3F3	3/8" - 18 NPTF	steel	2.32	58.9	1.48	37.6	1"
	ST3F3-SS	3/8" - 18 NPTF	316 stainless	2.32	58.9	1.48	37.6	1"
	ST3BF3	3/8" - 19 BSPP	steel	2.32	58.9	1.48	37.6	1"
	ST3BF3-SS	3/8" - 19 BSPP	316 stainless	2.32	58.9	1.48	37.6	1"
	ST3F4	1/2" - 14 NPTF	steel	2.32	58.9	1.48	37.6	1"
	ST3F4-SS	1/2" - 14 NPTF	316 stainless	2.32	58.9	1.48	37.6	1"
	ST3BF4	1/2" - 14 BSPP	steel	2.32	58.9	1.48	37.6	1"
1/2"	ST4F4	1/2" - 14 NPTF	steel	2.37	60.2	1.65	41.9	1-1/2"
	ST4F4-SS	1/2" - 14 NPTF	316 stainless	2.37	60.2	1.65	41.9	1-1/2"
	ST4BF4	1/2" - 14 BSPP	steel	2.37	60.2	1.65	41.9	1-1/2"
	ST4BF4-SS	1/2" - 14 BSPP	316 stainless	2.37	60.2	1.65	41.9	1-1/2"
3/4"	ST4OF4	3/4" - 16 ORB	steel	2.37	60.2	1.65	41.9	1-1/2"
	ST6F6	3/4" - 14 NPTF	steel	2.96	75.2	1.92	48.8	1-3/4"
	ST6F6-SS	3/4" - 14 NPTF	316 stainless	2.96	75.2	1.92	48.8	1-3/4"
	ST6BF6	3/4" - 14 BSPP	steel	2.96	75.2	1.92	48.8	1-3/4"
	ST6BF6-SS	3/4" - 14 BSPP	316 stainless	2.96	75.2	1.92	48.8	1-3/4"
	ST6OF6	1-1/16" - 12 ORB	steel	2.96	75.2	1.92	48.8	1-3/4"
1"	ST8F8	1" - 11-1/2 NPTF	steel	3.22	81.8	2.10	53.3	1-7/8"
	ST8F8-SS	1" - 11-1/2 NPTF	316 stainless	3.22	81.8	2.10	53.3	1-7/8"
	ST8BF8	1" - 11 BSPP	steel	3.22	81.8	2.10	53.3	1-7/8"
	ST8BF8-SS	1" - 11 BSPP	316 stainless	3.22	81.8	2.10	53.3	1-7/8"
	ST8OF8	1-5/16" - 12 ORB	steel	3.22	81.8	2.10	53.3	1-7/8"
	ST8F10	1-1/4" - 11-1/2 NPTF	steel	3.48	88.4	2.20	55.9	2"
	ST8F10-SS	1-1/4" - 11-1/2 NPTF	316 stainless	3.48	88.4	2.20	55.9	2"
	ST8BF10	1-1/4" - 11 BSPP	steel	3.48	88.4	2.20	55.9	2"
	ST8BF10-SS	1-1/4" - 11 BSPP	316 stainless	3.48	88.4	2.20	55.9	2"
	ST8OF10	1-5/8" - 12 ORB	steel	3.48	88.4	2.20	55.9	2"

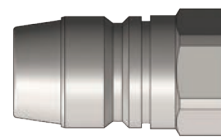
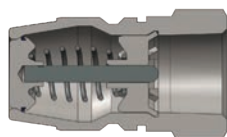

Body Size	ST-Series Heavy-Duty Flushface Plug (Female Threads)							
	Part Detail			Length		Maximum OD		Hex inch
	Part #	Threads	Material	inch	mm	inch	mm	
2"	ST16F12	1-1/2" - 11-1/2 NPTF	steel	4.50	114.3	3.48	88.4	3-1/4"
	ST16BF12	1-1/2" - 11 BSPP	steel	4.50	114.3	3.48	88.4	3-1/4"
	ST16OF12	1-7/8" - 12 ORB	steel	4.50	114.3	3.48	88.4	3-1/4"
	ST16F16	2" - 11-1/2 NPTF	steel	4.50	114.3	3.48	88.4	3-1/4"
	ST16F16-SS	2" - 11-1/2 NPTF	316 stainless	4.50	114.3	3.48	88.4	3-1/4"
	ST16BF16	2" - 11 BSPP	steel	4.50	114.3	3.48	88.4	3-1/4"
	ST16OF16	2-1/2" - 12 ORB	steel	4.50	114.3	3.48	88.4	3-1/4"

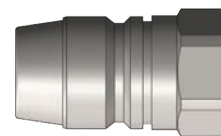
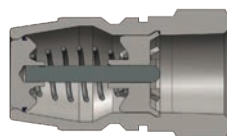

Body Size	ST-Series Heavy-Duty Flushface 'Old Style' Plug (Female Threads)							
	Part Detail			Length		Maximum OD		Hex inch
	Part #	Threads	Material	inch	mm	inch	mm	
1"	ST8F8-V2	1" - 11-1/2 NPTF	steel	3.26	82.8	1.92	48.8	1-3/4"
	ST8BF8-V2	1" - 11 BSPP	steel	3.26	82.8	1.92	48.8	1-3/4"
	ST8F10-V2	1-1/4" - 11-1/2 NPTF	steel	3.50	88.9	1.98	50.3	2"



Body Size	ST-Series Coupler Dust Plug			
	Part Detail			
	Part #	Lanyard	Body	
1/4"	2STDP-A	steel cable	aluminum	
3/8"	3STDP-A	steel cable	aluminum	
1/2"	4STDP-A	steel cable	aluminum	
3/4"	6STDP-A	steel cable	aluminum	
1"	8STDP-A	steel cable	aluminum	
1"-V2	8STDP-A-V2	steel cable	aluminum	
2"	16STDP-A	steel cable	aluminum	

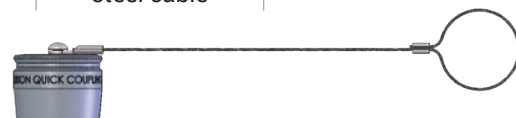

Body Size	ST-Series Plug Dust Cap			
	Part Detail			
	Part #	Lanyard	Body	
1/4"	ST2DC-A	steel cable	aluminum	
3/8"	ST3DC-A	steel cable	aluminum	
1/2"	ST4DC-A	steel cable	aluminum	
3/4"	ST6DC-A	steel cable	aluminum	
1"	ST8DC-A	steel cable	aluminum	
1"-V2	ST8DC-A-V2	steel cable	aluminum	
2"	ST16DC-A	steel cable	aluminum	

Hydraulic Couplings: ST-Series

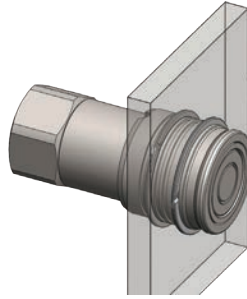

Body Size	ST-Series Heavy-Duty Flushface Coupler Bulkhead Kits			
	Part Detail			Bulkhead Kit Contents
	Part #	Mounting Hole ID	Ring Material	
1/4"	2ST-BMK	1.250"	steel	two 360° retaining rings
3/8"	3ST-BMK	1.625"	steel	two 360° retaining rings
1/2"	4ST-BMK	2.000"	steel	two 360° retaining rings
3/4"	6ST-BMK	2.375"	steel	two 360° retaining rings

Body Size	ST-Series Heavy-Duty Flushface Coupler Seal Kits			
	Part Detail			Seal Kit Contents
	Part #	Coupler Style	Seal Material	
1/4"	2ST-SKIT	all	nitrile	two seals and anti-extrusion rings
3/8"	3ST-SKIT	all	nitrile	two seals and anti-extrusion rings
1/2"	4ST-SKIT	all	nitrile	two seals and anti-extrusion rings
3/4"	6ST-SKIT	all	nitrile	two seals and anti-extrusion rings
1"	8ST-SKIT	all	nitrile	two seals and anti-extrusion rings
1"	8ST-SKIT-V2	all	nitrile	three seals and two anti-extrusion rings
2"	16ST-SKIT	all	nitrile	three seals and two anti-extrusion rings

Body Size	ST-Series Heavy-Duty Flushface Plug Seal Kits			
	Part Detail			Seal Kit Contents
	Part #	Coupler Style	Seal Material	
1/4"	ST2-SKIT	all	nitrile	valve O-ring/back-up and adapter O-ring
3/8"	ST3-SKIT	all	nitrile	valve O-ring/back-up and adapter O-ring
1/2"	ST4-SKIT	all	nitrile	valve O-ring/back-up and adapter O-ring
3/4"	ST6-SKIT	all	nitrile	valve O-ring/back-up and adapter O-ring
1"	ST8-SKIT	all	nitrile	valve O-ring/back-up and adapter O-ring
2"	ST16-SKIT	all	nitrile	main valve seal

Interchange Data

- Interchangeable to ISO15171-1
- Parker PD-Series, Eaton/Aeroquip FD90

Materials

- Machined components are manufactured using solid steel bar stock
- Stainless steel springs. Carbon steel balls and retaining rings
- Steel plugs are machined from solid steel bar stock and hardened
- Steel componentry is plated using ROHS-compliant trivalent chrome

Seal Components

- Nitrile (Buna-N) seals are standard, providing a temperature range of **-40°F to 250°F (-40°C to 121°C)**
- PTFE anti-extrusion ring protects main coupler O-ring from dynamic impulse pressure damage

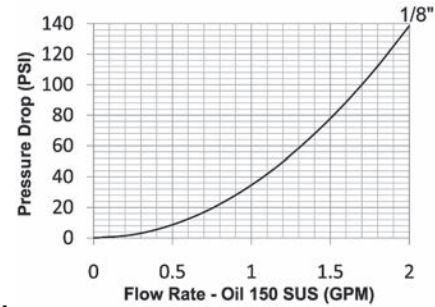

Rated Pressure Chart

Body Size	PD-Series ISO15171-1 Diagnostic Interchange							
	Steel Coupler/Plug Connected				Steel Plug Disconnected			
	Maximum Working		Burst		Maximum Working		Burst	
	PSI	Bar	PSI	Bar	PSI	Bar	PSI	Bar
1/8"	6,000	400	18,700	1,300	6,000	400	24,000	1,600

Technical Specifications

Body Size	Interchange Standards				Functional Parameters				
	U.S. Military	U.S. Government	International Standards	ANSI/NFPA Standards	Locking Ball Quantity	Air Inclusion	Fluid Loss	Vacuum Rating	Flow ΔP = 22 PSI
1/8"	-	-	ISO15171-1	SAE J1502	10	0.02	0.1	27.4	0.8

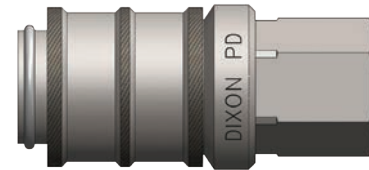
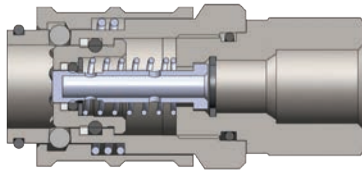

Body Size	PD-Series ISO15171-1 Diagnostic Coupler (Female Threads)							
	Part Detail			Length		Maximum OD		Hex mm
	Part #	Threads	Material	inch	mm	inch	mm	
1/8"	1PDF1	1/8" - 27 NPT	steel	2.13	54.1	0.98	24.8	21
	1PDF2	1/4" - 18 NPT	steel	2.13	54.1	0.98	24.8	21

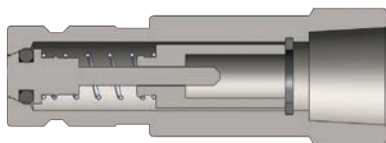

Body Size	PD-Series ISO15171-1 Diagnostic Plug (Female Threads)							
	Part Detail			Length		Maximum OD		Hex mm
	Part #	Threads	Material	inch	mm	inch	mm	
1/8"	PD1F1	1/8" - 27 NPT	steel	1.88	47.7	0.76	19.3	17
	PD1F2	1/4" - 18 NPT	steel	1.88	47.7	0.76	19.3	17

Hydraulic Couplings: PD-Series

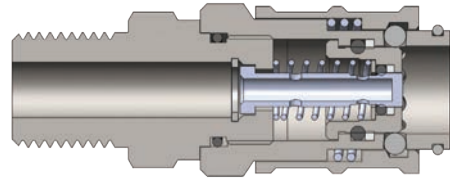

Body Size	PD-Series ISO15171-1 Diagnostic Coupler (Male Threads)							
	Part Detail			Length		Maximum OD		Hex mm
	Part #	Threads	Material	inch	mm	inch	mm	
1/8"	1PDM2	1/4" - 18 NPT	steel	2.28	57.9	0.98	24.9	21

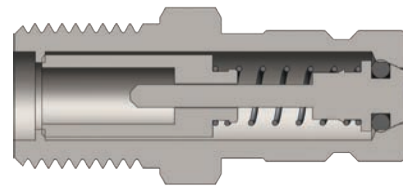
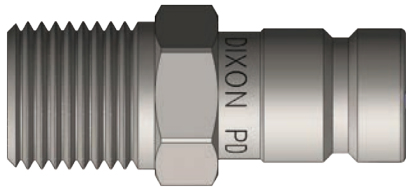

Body Size	PD-Series ISO15171-1 Diagnostic Plug (Male Threads)							
	Part Detail			Length		Maximum OD		Hex mm
	Part #	Threads	Material	inch	mm	inch	mm	
1/8"	PD1M1	1/8" - 27 NPT	steel	1.98	50.2	0.76	19.3	17
	PD1M2	1/4" - 18 NPT	steel	1.48	37.5	0.76	19.3	17

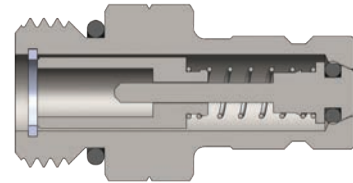

Body Size	PD-Series ISO15171-1 Diagnostic Plug (Male ORB Threads)							
	Part Detail			Length		Maximum OD		Hex mm
	Part #	Threads	Material	inch	mm	inch	mm	
1/8"	PD10M2	7/16" - 20 ORB	steel	1.93	49.0	0.76	19.3	17
	PD10M3	9/16" - 18 ORB	steel	1.48	37.5	0.76	19.3	17

Body Size	PD-Series Plug Dust Cap	
	Part Detail	
	Part #	Material
1/8"	H1DC	nitrile

PD-Series Profile

Body Size	A	B
1/8"	0.49	0.19

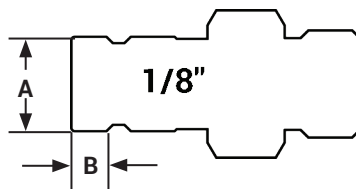

Interchange Data

- Stucchi VEP-P/VEP-HD Series, DNP PST4/FSI Series, Voswinkel FT Series, Parker FET-Series, and Holmbury HFT Series

Seal Components

- Plugs have nitrile-energized PTFE valve seals, with a temperature range of **-40°F to 250°F (-40°C to 121°C)**
- 3/8" plugs have molded polyurethane valve seals, with a temperature range of **-65°F to 212°F (-54°C to 100°C)**
- 3/8" to 3/4" valve stems have molded acetal seals, with a temperature range of **-65°F to 212°F (-54°C to 100°C)**
- 1" to 2" valve stems have molded polyurethane seals, with a temperature range of **-65°F to 212°F (-54°C to 100°C)**
- Ancillary coupler and plug seals are nitrile (buna-N), with a temperature range of **-40°F to 250°F (-40°C to 121°C)**
- TPC-ET anti-extrusion ring protects main coupling valve seal from dynamic impulse pressure damage

Materials

- Machined components are manufactured using solid steel bar stock
- Stainless steel retaining rings and springs maximize corrosion resistance and extend service life
- Steel componentry is plated using ROHS compliant zinc nickel for corrosion resistance

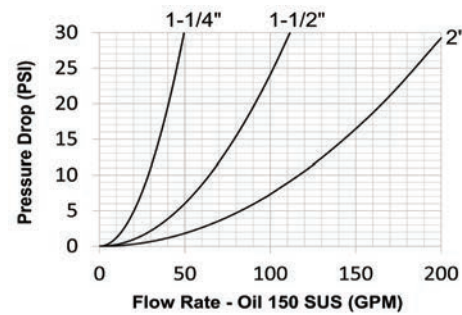
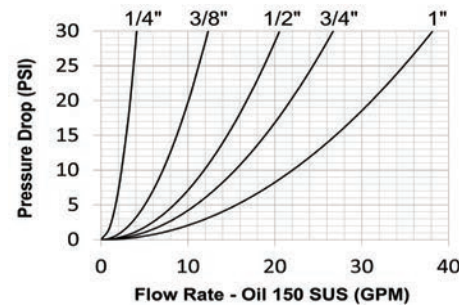

Two-stage valving to protect critical sealing components during pressurized connection and disconnection

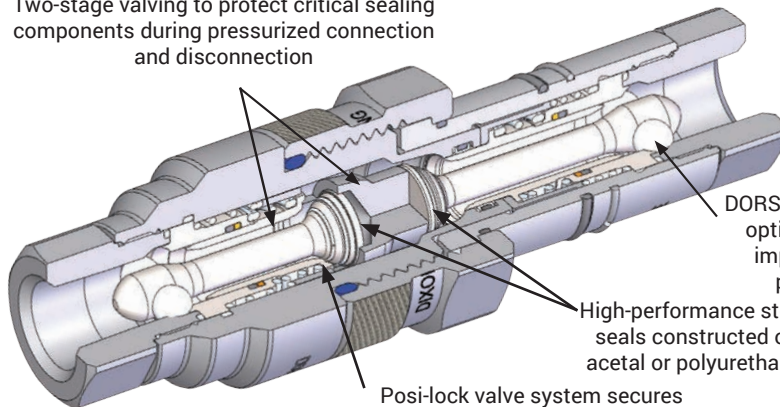

DORS retention system optimizes flow and impulse pressure performance

High-performance stem seals constructed of acetal or polyurethane

Posi-lock valve system secures valving during surge-flow conditions to prevent high-velocity damage

Rated Pressure Chart

VEP-Series Interchange

Body Size	Pressure Rating				Burst Pressure						Max. Pressure Connect ³		Max. Pressure Disconnect ³		Rated Flow ΔP=21.75 PSI	
	ISO Working ¹		Max. Impulse ²		Connected		Coupler		Plug		PSI	Bar	PSI	Bar	GPM	L/min
	PSI	Bar	PSI	Bar	PSI	Bar	PSI	Bar	PSI	Bar	PSI	Bar	PSI	Bar		
1/4"	6,000	400	9,000	625	24,000	1,650	22,000	1,525	22,000	1,525	5,500	375	5,500	375	3.5	13
3/8"	5,500	375	8,000	550	22,000	1,525	18,000	1,250	20,000	1,375	4,500	300	4,500	300	10.5	40
1/2"	5,500	375	8,000	550	22,000	1,525	18,000	1,250	20,000	1,375	4,500	300	4,500	300	17.5	66
3/4"	5,500	375	8,000	550	22,000	1,525	18,000	1,250	20,000	1,375	4,500	300	4,500	300	22.7	85
1"	5,500	375	7,500	525	22,000	1,525	14,500	1,000	20,000	1,375	3,625	250	3,625	250	32.5	123
1-1/4"	5,000	350	7,000	475	20,000	1,375	14,500	1,000	16,000	1,100	3,625	250	3,625	250	46.4	174
1-1/2"	4,500	300	5,800	400	18,000	1,250	12,000	8,325	14,500	1,000	3,000	200	3,000	200	95.0	360
2"	4,000	275	5,000	350	18,000	1,250	12,000	8,325	14,500	1,000	3,000	200	3,000	200	172.5	653

¹Couplings impulse tested in accordance with ISO18869 for 1,000,000 cycles connected and 100,000 cycles disconnected at 133% of ISO working pressure.

²Couplings impulse tested in accordance with ISO18869 for 100,000 cycles connected and disconnected at maximum impulse pressure listed

³System temperature for maximum connect/disconnect pressure must not exceed **150°F (65°C)**

How to Connect and Disconnect the VEP-Series Coupling

1. Prior to connecting, thoroughly clean all mating surfaces and threads on both halves, then pull the coupler sleeve forward.
2. To initiate the connection, align the coupler and plug, pushing/turning the coupler sleeve toward the plug while engaging the threads. Keep the mating halves aligned during the connection process.
3. Allow the threads to pull the coupler onto the plug; do not push the coupler onto the plug.
4. The first phase of the connection should be threaded by hand, without the use of tools. Please note the connection sleeve may seize when dirt and debris accumulate in the threads - remove debris with a cloth, compressed air, or a brush.
5. The second phase of the connection may require a wrench if the pressure is higher than anticipated.
6. Continue to thread the coupler sleeve onto the plug until the end of the sleeve meets the plug body
7. To disconnect, use a wrench to break the coupler sleeve free and keep the mating halves aligned during the disconnection process.

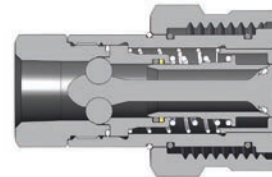
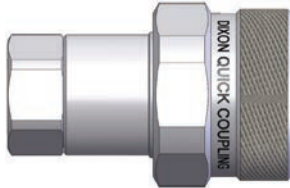

Body Size	VEP-Series Coupler (Female Threads)							
	Part Detail			Length		Maximum OD		Hex mm
	Part #	Threads	Materials	inch	mm	inch	mm	
1/4"	2VEPF2	1/4" - 18 NPTF	steel	2.14	54.4	1.49	37.8	22
	2VEPBF2	1/4" - 19 BSPP	steel	2.14	54.4	1.49	37.8	22
	2VEPOF3	9/16" - 18 ORB	steel	2.14	54.4	1.49	37.8	22
3/8"	3VEPF3	3/8" - 18 NPTF	steel	2.55	64.8	1.62	41.1	25
	3VEPBF3	3/8" - 19 BSPP	steel	2.55	64.8	1.62	41.1	25
	3VEPOF4	3/4" - 16 ORB	steel	2.77	70.4	1.62	41.1	25
	3VEPF4	1/2" - 14 NPTF	steel	2.77	70.4	1.62	41.1	28
	3VEPBF4	1/2" - 14 BSPP	steel	2.77	70.4	1.62	41.1	28
1/2"	4VEPF4	1/2" - 14 NPTF	steel	3.08	78.2	1.98	50.3	30
	4VEPBF4	1/2" - 14 BSPP	steel	3.08	78.2	1.98	50.3	30
	4VEPOF4	3/4" - 16 ORB	steel	3.08	78.2	1.98	50.3	30
	4VEPOF5	7/8" - 14 ORB	steel	3.18	80.8	1.98	50.3	32
	4VEPF6	3/4" - 14 NPTF	steel	3.38	85.9	1.98	50.3	38
	4VEPBF6	3/4" - 14 BSPP	steel	3.38	85.9	1.98	50.3	38
	4VEPOF6	1-1/16" - 12 ORB	steel	3.58	90.9	1.98	50.3	38
3/4"	6VEPF6	3/4" - 14 NPTF	steel	3.37	85.6	2.19	55.6	38
	6VEPBF6	3/4" - 14 BSPP	steel	3.37	85.6	2.19	55.6	38
	6VEPOF6	1-1/16" - 12 ORB	steel	3.37	85.6	2.19	55.6	38
1"	8VEPF8	1" - 11-1/2 NPTF	steel	3.89	98.8	2.46	62.5	44
	8VEPF8-SS	1" - 11-1/2 NPTF	316 stainless steel	3.89	98.8	2.46	62.5	44
	8VEPBF8	1" - 11 BSPP	steel	3.89	98.8	2.46	62.5	44
	8VEPOF8	1-5/16" - 12 ORB	steel	3.89	98.8	2.46	62.5	44
1-1/4"	10VEPF10	1-1/4" - 11-1/2 NPTF	steel	4.40	111.8	2.70	68.6	55
	10VEPBF10	1-1/4" - 11 BSPP	steel	4.40	111.8	2.70	68.6	55
	10VEPOF10	1-5/8" - 12 ORB	steel	4.40	111.8	2.70	68.6	55
1-1/2"	12VEPF12	1-1/2" - 11-1/2 NPTF	steel	5.28	134.1	3.74	95.0	63
	12VEPBF12	1-1/2" - 11 BSPP	steel	5.28	134.1	3.74	95.0	63
	12VEPOF12	1-7/8" - 12 ORB	steel	5.28	134.1	3.74	95.0	63
2"	16VEPF16	2" - 11-1/2 NPTF	steel	9.42	239.3	7.39	187.7	89
	16VEPBF16	2" - 11 BSPP	steel	9.42	239.3	7.39	187.7	89
	16VEPOF16	2-1/2" - 12 ORB	steel	9.42	239.3	7.39	187.7	89

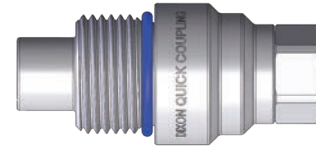
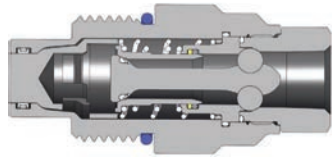

Body Size	VEP-Series Plug (Female Threads)							
	Part Detail			Length		Maximum OD		Hex mm
	Part #	Threads	Material	inch	mm	inch	mm	
1/4"	VEP2F2	1/4" - 18 NPTF	steel	2.67	67.8	1.35	34.3	22
	VEP2BF2	1/4" - 19 BSPP	steel	2.67	67.8	1.35	34.3	22
	VEP2OF3	9/16" - 18 ORB	steel	2.67	67.8	1.35	34.3	22
3/8"	VEP3F3	3/8" - 18 NPTF	steel	3.28	83.3	1.48	37.6	25
	VEP3BF3	3/8" - 19 BSPP	steel	3.28	83.3	1.48	37.6	25
	VEP3OF4	3/4" - 16 ORB	steel	3.50	88.9	1.48	37.6	25
	VEP3F4	1/2" - 14 NPTF	steel	3.50	88.9	1.48	37.6	28
	VEP3BF4	1/2" - 14 BSPP	steel	3.50	88.9	1.48	37.6	28
1/2"	VEP4F4	1/2" - 14 NPTF	steel	3.87	98.3	1.86	47.2	30
	VEP4BF4	1/2" - 14 BSPP	steel	3.87	98.3	1.86	47.2	30
	VEP4OF4	3/4" - 16 ORB	steel	3.87	98.3	1.86	47.2	30
	VEP4OF5	7/8" - 14 ORB	steel	3.97	100.8	1.86	47.2	32
	VEP4F6	3/4" - 14 NPTF	steel	4.07	103.4	1.86	47.2	38
	VEP4BF6	3/4" - 14 BSPP	steel	4.07	103.4	1.86	47.2	38
	VEP4OF6	1-1/16" - 12 ORB	steel	4.27	108.5	1.86	47.2	38
3/4"	VEP6F6	3/4" - 14 NPTF	steel	4.12	104.6	1.98	50.3	38
	VEP6BF6	3/4" - 14 BSPP	steel	4.12	104.6	1.98	50.3	38
	VEP6OF6	1-1/16" - 12 ORB	steel	4.12	104.6	1.98	50.3	38
1"	VEP8F8	1" - 11-1/2 NPTF	steel	4.95	125.7	2.20	55.9	44
	VEP8F8-SS	1" - 11-1/2 NPTF	316 stainless steel	4.95	125.7	2.20	55.9	44
	VEP8BF8	1" - 11 BSPP	steel	4.95	125.7	2.20	55.9	44
	VEP8OF8	1-5/16" - 12 ORB	steel	4.95	125.7	2.20	55.9	44
1-1/4"	VEP10F10	1-1/4" - 11-1/2 NPTF	steel	5.43	137.9	2.73	69.3	55
	VEP10BF10	1-1/4" - 11 BSPP	steel	5.43	137.9	2.73	69.3	55
	VEP10OF10	1-5/8" - 12 ORB	steel	5.43	137.9	2.73	69.3	55
1-1/2"	VEP12F12	1-1/2" - 11-1/2 NPTF	steel	6.63	168.4	3.74	95.0	63
	VEP12BF12	1-1/2" - 11 BSPP	steel	6.63	168.4	3.74	95.0	63
	VEP12OF12	1-7/8" - 12 ORB	steel	6.63	168.4	3.74	95.0	63
2"	VEP16F16	2" - 11-1/2 NPTF	steel	11.08	281.4	5.70	144.8	89
	VEP16BF16	2" - 11 BSPP	steel	11.08	281.4	5.70	144.8	89
	VEP16OF16	2-1/2" - 12 ORB	steel	11.08	281.4	5.70	144.8	89

Hydraulic Couplings: VEP-Series

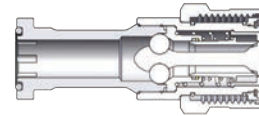

VEP-Series Code 62 Flange Head Coupler

Body Size	Part Detail						
	Part Detail			Length		Maximum OD	
	Part #	Threads	Material	inch	mm	inch	mm
3/4"	6VEPFH6	3/4"	steel	4.95	125.63	2.20	55.88
1"	8VEPFH8	1"	steel	5.34	135.64	2.47	62.74
1-1/4"	10VEPFH10	1-1/4"	steel	6.26	158.88	2.70	68.58
1-1/2"	12VEPFH12	1-1/2"	steel	8.02	203.71	3.74	95.00

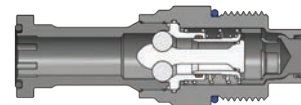

VEP-Series Code 62 Flange Head Plug

Body Size	Part Detail						
	Part Detail			Length		Maximum OD	
	Part #	Threads	Material	inch	mm	inch	mm
3/4"	VEP6FH6	3/4"	steel	5.70	144.78	1.98	50.29
1"	VEP8FH8	1"	steel	6.40	162.59	2.20	55.88
1-1/4"	VEP10FH10	1-1/4"	steel	7.30	185.42	2.73	69.34
1-1/2"	VEP12FH12	1-1/2"	steel	9.26	235.25	3.74	94.87

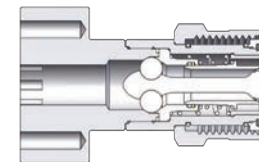

VEP-Series Code 62 Flange Pad Coupler

Body Size	Part Detail						
	Part Detail			Length		Maximum OD	
	Part #	Threads	Material	inch	mm	inch	mm
3/4"	6VEFPF6	3/4"	steel	4.45	112.93	3.02	76.71
1"	8VEFPF8	1"	steel	5.34	135.64	3.44	87.38
1-1/4"	10VEFPF10	1-1/4"	steel	5.56	141.10	4.03	102.29
1-1/2"	12VEFPF12	1-1/2"	steel	6.52	165.71	4.76	120.93

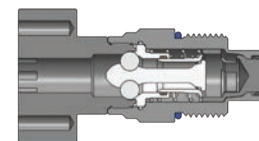

VEP-Series Code 62 Flange Pad Plug

Body Size	Part Detail						
	Part Detail			Length		Maximum OD	
	Part #	Threads	Material	inch	mm	inch	mm
3/4"	VEP6FP6	3/4"	steel	5.20	132.08	3.02	76.71
1"	VEP8FP8	1"	steel	6.40	162.59	3.44	87.38
1-1/4"	VEP10FP10	1-1/4"	steel	6.60	167.64	4.03	102.29
1-1/2"	VEP12FP12	1-1/2"	steel	7.76	197.15	4.76	120.93

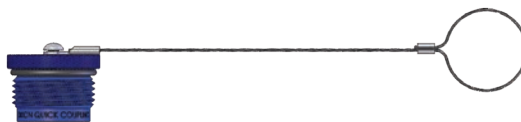

Body Size	VEP-Series Rigid Dust Plug	
	Part #	
1/4"	2VEPDP-A	
3/8"	3VEPDP-A	
1/2"	4VEPDP-A	
3/4"	6VEPDP-A	
1"	8VEPDP-A	
1-1/4"	10VEPDP-A	
1-1/2"	12VEPDP-A	
2"	16VEPDP-A	

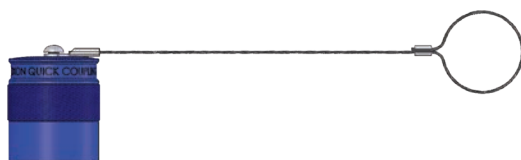

Body Size	VEP-Series Rigid Dust Cap	
	Part #	
1/4"	VEP2DC-A	
3/8"	VEP3DC-A	
1/2"	VEP4DC-A	
3/4"	VEP6DC-A	
1"	VEP8DC-A	
1-1/4"	VEP10DC-A	
1-1/2"	VEP12DC-A	
2"	VEP16DC-A	

NOTE: VEP-Series dust caps and plugs are aluminum with a steel cable

Body Size	A	B
1/4"	0.64	0.49
3/8"	0.78	0.70
1/2"	0.96	0.74
3/4"	1.06	0.76
1"	1.18	0.94
1-1/4"	1.42	0.98
1-1/2"	2.25	1.25
2"	3.43	2.44

VEP-Series Profile

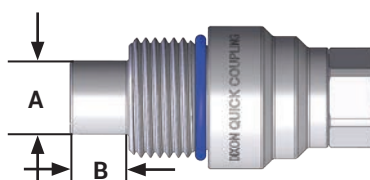

Hydraulic Couplings: VEP-BOP-Series

Interchange Data

- Stucchi VEP/VEP-HD Series, DNP FSI-BOP-Series

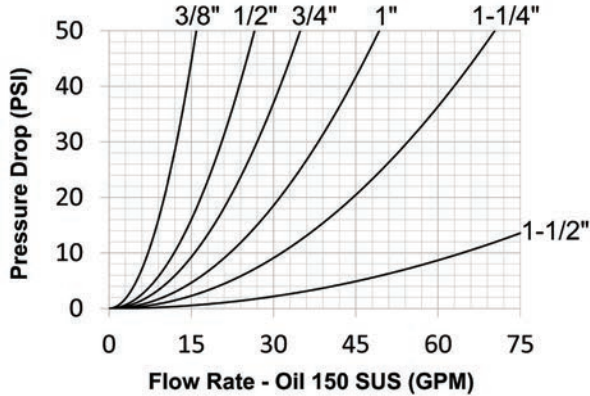

Seal Components

- Blowout preventer (BOP) coupling critical seals are severe service FKM

Materials

- Machined components are manufactured using solid steel bar stock
- Stainless steel retaining rings and springs maximize corrosion resistance and extend service life
- Steel components are plated using ROHS-compliant zinc nickel
- Red powder-coated components and external O-rings for easy BOP service identification

- BOP couplings have been fire tested and Lloyd's certified to 1300°F (700°C) in accordance with API 16D. Certificate available upon request.
- Use VEP dust caps and dust plugs found on page 141

Rated Pressure Chart

VEP-BOP-Series Interchange

Body Size	Pressure Rating				Burst Pressure						Max. Pressure Connect		Max. Pressure Disconnect		Rated Flow ΔP=21.75PSI	
	ISO Working		Max. Impulse		Connected		Coupler		Plug		PSI	Bar	PSI	Bar	GPM	L/min
	PSI	Bar	PSI	Bar	PSI	Bar	PSI	Bar	PSI	Bar						
3/8"	5,500	375	8,000	550	22,000	1,525	18,000	1,250	20,000	1,375	4,500	300	4,500	300	10.5	40
1/2"	5,500	375	8,000	550	22,000	1,525	18,000	1,250	20,000	1,375	4,500	300	4,500	300	17.5	66
3/4"	5,500	375	8,000	550	22,000	1,525	18,000	1,250	20,000	1,375	4,500	300	4,500	300	22.7	85
1"	5,500	375	7,500	525	22,000	1,525	14,500	1,000	20,000	1,375	3,625	250	3,625	250	32.5	123
1-1/4"	5,000	350	7,000	475	20,000	1,375	14,500	1,000	16,000	1,100	3,625	250	3,625	250	46.4	174
1-1/2"	5,000	300	5,800	400	18,000	1,250	12,000	8,325	14,500	1,000	3,000	200	3,000	200	95.0	360

VEP-BOP-Series Profile

Body Size	A	B
3/8"	0.78	0.70
1/2"	0.96	0.74
3/4"	1.06	0.76
1"	1.18	0.94
1-1/4"	1.42	0.98
1-1/2"	2.25	1.25

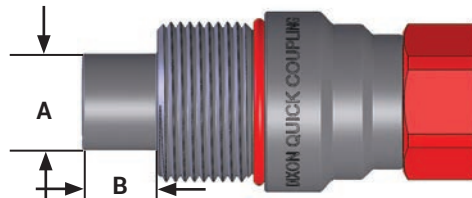

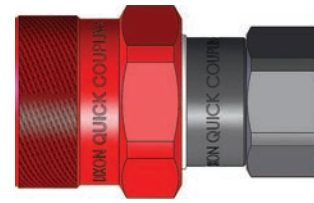
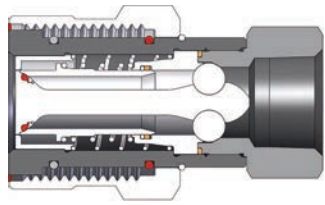

Body Size	VEP-BOP-Series Blowout Preventer Safety Coupler (Female Threads)							
	Part Detail			Length		Maximum OD		Hex mm
	Part #	Threads	Material	inch	mm	inch	mm	
3/8"	3VEPF3-BOP	3/8" - 18 NPTF	steel	2.55	64.8	1.62	41.1	25
	3VEPF4-BOP	1/2" - 14 NPTF	steel	2.77	70.4	1.62	41.1	28
1/2"	4VEPF4-BOP	1/2" - 14 NPTF	steel	3.08	78.2	1.98	50.3	30
3/4"	6VEPF6-BOP	3/4" - 14 NPTF	steel	3.37	85.6	2.19	55.6	38
1"	8VEPF8-BOP	1" - 11-1/2 NPTF	steel	3.89	98.8	2.46	62.5	44
1-1/4"	10VEPF10-BOP	1-1/4" - 11-1/2 NPTF	steel	4.40	111.8	2.70	68.6	55
1-1/2"	12VEPF12-BOP	1-1/2" - 11-1/2 NPTF	steel	5.28	134.1	3.74	95.0	63

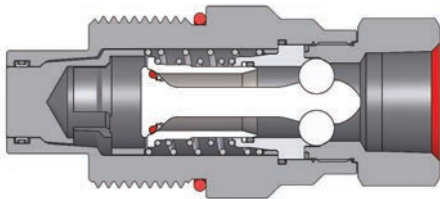

Body Size	VEP-BOP-Series Blowout Preventer Safety Plug (Female Threads)							
	Part Detail			Length		Maximum OD		Hex mm
	Part #	Threads	Material	inch	mm	inch	mm	
3/8"	VEP3F3-BOP	3/8" - 18 NPTF	steel	3.28	83.3	1.48	37.6	25
	VEP3F4-BOP	1/2" - 14 NPTF	steel	3.50	88.9	1.48	37.6	28
1/2"	VEP4F4-BOP	1/2" - 14 NPTF	steel	3.87	98.3	1.86	47.2	30
3/4"	VEP6F6-BOP	3/4" - 14 NPTF	steel	4.12	104.6	1.98	50.3	38
1"	VEP8F8-BOP	1" - 11-1/2 NPTF	steel	4.95	125.7	2.20	55.9	44
1-1/4"	VEP10F10-BOP	1-1/4" - 11-1/2 NPTF	steel	5.43	137.9	2.73	69.3	55
1-1/2"	VEP12F12-BOP	1-1/2" - 11-1/2 NPTF	steel	6.63	164.4	3.74	95.0	63

Hydraulic Couplings: W-Series

Interchange Data

- Eaton/Aeroquip 5100-Series, Parker 6100-Series
- Snap-Tite 78-Series, Faster Series-FB, Safeway S51-Series

Materials

- Machined components are manufactured using solid steel and brass bar stock
- Stainless steel retaining rings and springs maximize corrosion resistance and extend service life
- Steel componentry is plated using ROHS-compliant trivalent chrome
- Rugged steel wing nut for threaded connect and disconnect operation
- For steel models, coupler valve sleeve and plug valve are constructed of brass

Seal Components

- Nitrile (Buna-N) seals are standard, providing a temperature range of **-40°F to 250°F (-40°C to 121°C)**
- Couplings have a TPC-ET back-up ring on the main coupler valve sleeve to extend service life
- Main coupler valve has a bonded face-seal to improve seal integrity during pressurized connection/disconnection
- Plug valve seal is crimped to improve seal integrity and prolong service life; 1-1/2" has bonded plug valve
- External O-ring on plug indicates full connection and acts as a contamination shield in connected mode
- Redundant O-ring on the coupler body will engage plug for secondary sealing support

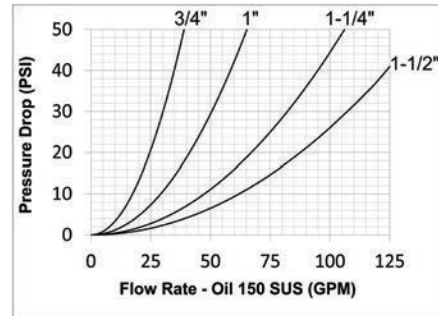

Rated Pressure Chart

Body Size	W-Series Wingstyle Interchange (Connected)			
	Coupler/Plug			
	Maximum Working		Burst	
	PSI	Bar	PSI	Bar
1/4"	3,000	207	14,000	965
3/8"	3,000	207	13,000	897
3/4"	3,000	207	13,000	897
1"	4,000	276	16,000	1,103
1-1/4"	3,000	207	12,000	828
1-1/2"	2,500	172	10,000	690

Technical Specifications

Body Size	Interchange Standards				Functional Parameters				
	U.S. Military	U.S. Government	International Standards	ANSI/NFPA Standards	Locking Mechanism	Air Inclusion	Fluid Loss	Vacuum inch HG	Flow ΔP = 32 PSI
1/4"					threaded	0.03cc	0.01cc	27.4	6 GPM
3/8"					threaded	0.05cc	0.06cc	27.4	15 GPM
3/4"	-	-	-	-	threaded	0.34cc	0.26cc	27.4	31 GPM
1"	-	-	-	-	threaded	0.50cc	0.35cc	27.4	52 GPM
1-1/4"	-	-	-	-	threaded	0.68cc	0.70cc	27.4	85 GPM
1-1/2"	-	-	-	-	threaded	0.60cc	0.94cc	27.4	110 GPM

! Although the wingstyle couplings are able to connect and disconnect while under pressure, it is recommended that hydraulic power supply be de-energized during connection to ensure operator safety. If it is not possible to de-energize the circuit, operators must be aware of their surroundings to ensure that an attachment or tool does not put them at risk, once hydraulic power is applied during the connection process.

W-Series couplings are not recommended for continuous hydraulic impulse applications at rated pressures.

Wingstyle Socket Features

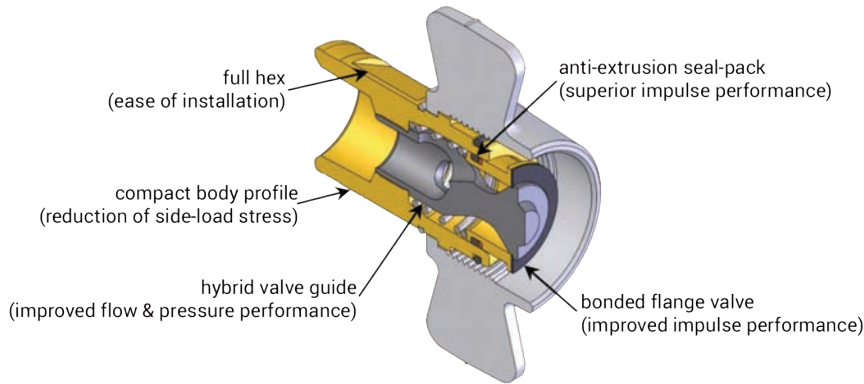

Wingstyle Plug Features

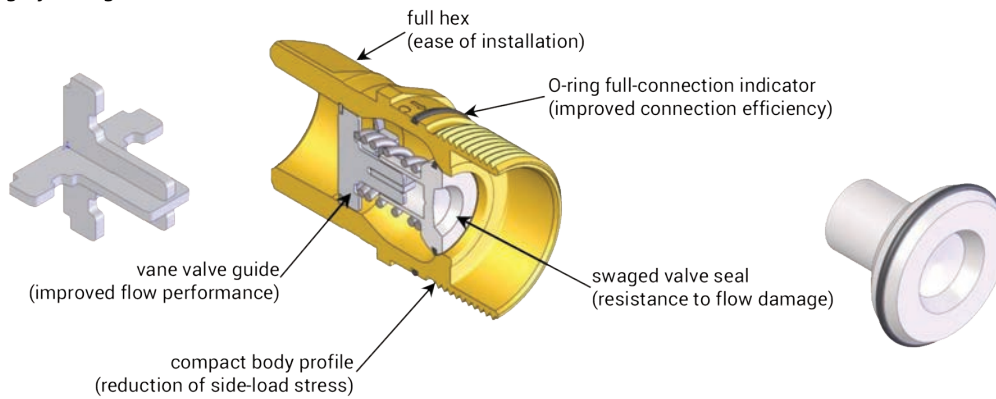

Hybrid valve design increases flow and pressure performance.



industry norm tubular valve guide

hybrid valve guide

Body Size	A	B
1/4"	0.93	0.94
3/8"	1.12	1.06
3/4"	1.49	0.95
1"	1.85	1.49
1-1/4"	2.12	1.62
1-1/2"	2.47	1.91

W-Series Profiles

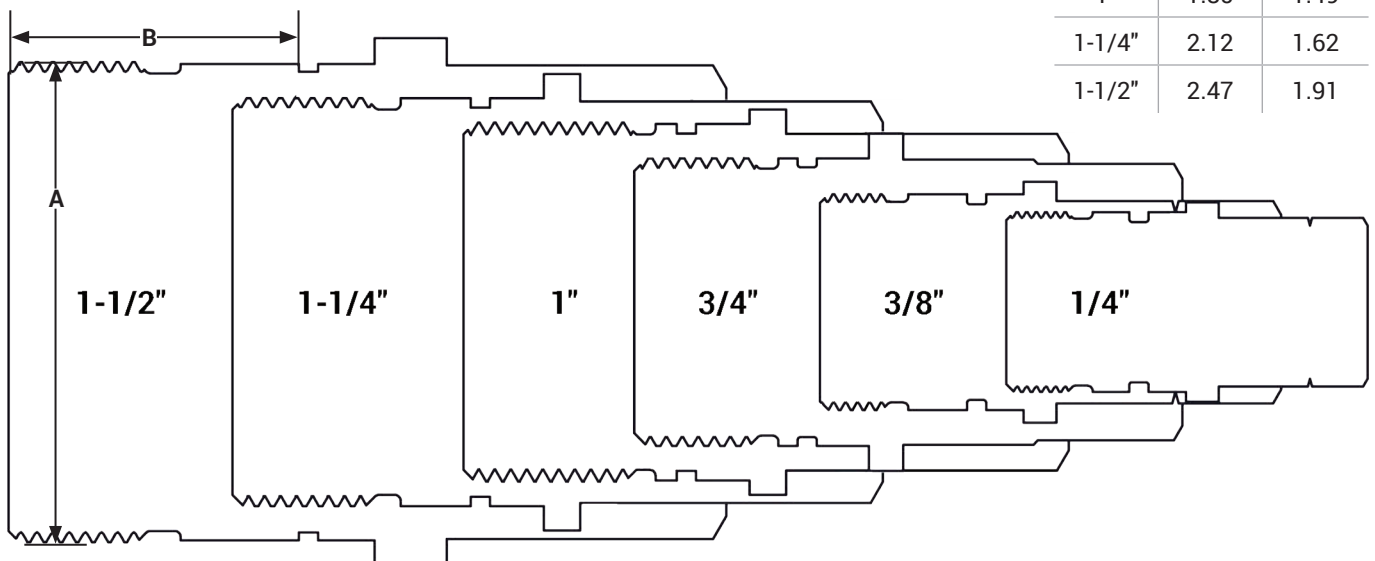

Hydraulic Couplings: W-Series

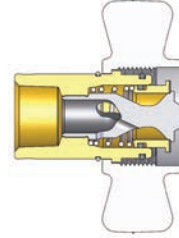

Body Size	W-Series Wingstyle Interchange Coupler (Female Threads)							
	Part Detail			Length		Maximum OD		Flats inch
	Part #	Threads	Material	inch	mm	inch	mm	
1/4"	2WF1-B	1/8" - 27 NPTF	brass	2.00	50.8	3.02	76.7	5/8"
3/8"	3WF2-B	1/4" - 18 NPTF	brass	2.33	59.1	3.46	87.8	13/16"
	3WF3-B	3/8" - 18 NPTF	brass	2.33	59.1	3.46	87.8	13/16"
3/4"	6WF4-B	1/2" - 14 NPTF	brass	2.73	69.3	4.09	103.9	1-5/32"
	6WBF4-B	1/2" - 14 BSPP	brass	2.73	69.3	4.09	103.9	1-5/32"
	6WF6-B	3/4" - 14 NPTF	brass	2.73	69.3	4.09	103.9	1-5/32"
	6WBF6-B	3/4" - 14 BSPP	brass	2.73	69.3	4.09	103.9	1-5/32"
1"	8WF8-B	1" - 11-1/2 NPTF	brass	3.33	84.6	4.49	114.0	1-15/32"
	8WF8	1" - 11-1/2 NPTF	steel	3.33	84.6	4.49	114.0	1-15/32"
	8WBF8-B	1" - 11 BSPP	brass	3.33	84.6	4.49	114.0	1-15/32"
1-1/4"	10WF10-B	1-1/4" - 11-1/2 NPTF	brass	3.64	92.5	5.27	133.9	1-25/32"
	10WBF10-B	1-1/4" - 11 BSPP	brass	3.64	92.5	5.27	133.9	1-25/32"
1-1/2"	12WF12-B	1-1/2" - 11-1/2 NPTF	brass	3.67	93.2	5.35	135.9	2-7/64"
	12WBF12-B	1-1/2" - 11 BSPP	brass	4.08	103.6	5.35	135.9	2-7/64"

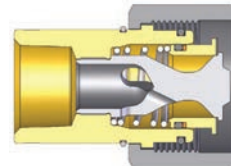
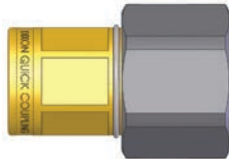

Body Size	W-Series Wingstyle Interchange Hex-Nut Coupler (Female Threads)							
	Part Detail			Length		Maximum OD		Hex inch
	Part #	Threads	Material	inch	mm	inch	mm	
1/4"	2WF1-B-HN	1/8" - 27 NPTF	brass	2.00	50.8	3.00	76.2	0.63"
3/8"	3WF2-B-HN	1/4" - 18 NPTF	brass	2.33	59.2	3.45	87.6	0.81"
	3WF3-B-HN	3/8" - 18 NPTF	brass	2.33	59.2	3.45	87.6	0.81"
3/4"	6WF4-B-HN	1/2" - 14 NPTF	brass	2.73	69.3	1.92	48.8	1-5/32"
	6WBF4-B-HN	1/2" - 14 BSPP	brass	2.73	69.3	1.92	48.8	1-5/32"
	6WF6-B-HN	3/4" - 14 NPTF	brass	2.73	69.3	1.92	48.8	1-5/32"
	6WBF6-B-HN	3/4" - 14 BSPP	brass	2.73	69.3	1.92	48.8	1-5/32"
1"	8WF8-B-HN	1" - 11-1/2 NPTF	brass	3.33	84.6	2.33	59.2	1-15/32"
	8WF8-HN	1" - 11-1/2 NPTF	steel	3.33	84.6	2.33	59.2	1-15/32"
	8WBF8-B-HN	1" - 11 BSPP	brass	3.33	84.6	2.33	59.2	1-15/32"
1-1/4"	10WF10-B-HN	1-1/4" - 11-1/2 NPTF	brass	3.64	92.5	2.75	69.9	1-25/32"
	10WBF10-B-HN	1-1/4" - 11 BSPP	brass	3.64	92.5	2.75	69.9	1-25/32"
1-1/2"	12WF12-B-HN	1-1/2" - 11-1/2 NPTF	brass	3.67	93.2	3.01	76.5	2-7/64"
	12WBF12-B-HN	1-1/2" - 11 BSPP	brass	3.67	93.2	3.01	76.5	2-7/64"

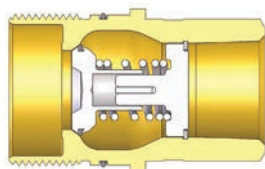

Body Size	W-Series Wingstyle Interchange Plug (Female Threads)							
	Part Detail			Length		Maximum OD		Hex inch
	Part #	Threads	Material	inch	mm	inch	mm	
1/4"	W2F1-B	1/8"-27 NPTF	brass	1.88	47.8	1.04	26.3	15/16"
3/8"	W3F2-B	1/4"-18 NPTF	brass	2.30	58.4	1.25	31.8	1-1/4"
	W3F3-B	3/8"-18 NPTF	brass	2.40	61.0	1.25	31.8	1-1/4"
3/4"	W6F4-B	1/2" - 14 NPTF	brass	2.85	72.4	1.75	44.5	1-5/16"
	W6BF4-B	1/2" - 14 BSPP	brass	2.85	72.4	1.75	44.5	1-5/16"
	W6F6-B	3/4" - 14 NPTF	brass	2.85	72.4	1.75	44.5	1-5/16"
	W6BF6-B	3/4" - 14 BSPP	brass	2.85	72.4	1.75	44.5	1-5/16"
1"	W8F8-B	1" - 11-1/2 NPTF	brass	3.15	80.0	2.00	50.8	1-9/16"
	W8F8	1" - 11-1/2 NPTF	steel	3.15	80.0	2.00	50.8	1-9/16"
	W8BF8-B	1" - 11 BSPP	brass	3.15	80.0	2.00	50.8	1-9/16"
1-1/4"	W10F10-B	1-1/4" - 11-1/2 NPTF	brass	3.39	86.1	2.37	60.2	1-15/16"
	W10BF10-B	1-1/4" - 11 BSPP	brass	3.39	86.1	2.37	60.2	1-15/16"
1-1/2"	W12F12-B	1-1/2" - 11-1/2 NPTF	brass	3.74	95.0	2.73	69.3	2-1/4"
	W12BF12-B	1-1/2" - 11 BSPP	brass	3.74	95.0	2.73	69.3	2-1/4"

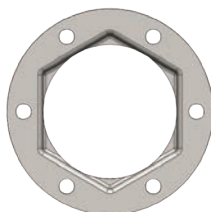

Plug not included with flange

Body Size	W-Series Wingstyle Interchange Plug Mounting Flange		
	Part Detail		
	Part #	Bolt Hole Size	Material
3/4"	W6-BMF	0.201"	steel
1"	W8-BMF	0.201"	steel
1-1/4"	W10-BMF	0.201"	steel
1-1/2"	W12-BMF	0.201"	steel

Hydraulic Couplings: W-Series



Body Size	W-Series Wingstyle Interchange Coupler Rigid Dust Plug			
	Part Detail			
	Part #	Lanyard	Body	
1/4"	2WDP	steel cable	steel	
3/8"	3WDP	steel cable	steel	
3/4"	6WDP	steel cable	steel	
1"	8WDP	steel cable	steel	
1-1/4"	10WDP	steel cable	steel	
1-1/2"	12WDP	steel cable	steel	



Body Size	W-Series Wingstyle Interchange Plug Rigid Dust Cap			
	Part Detail			
	Part #	Lanyard	Body	
1/4"	W2DC	steel cable	steel	
3/8"	W3DC	steel cable	steel	
3/4"	W6DC	steel cable	steel	
1"	W8DC	steel cable	steel	
1-1/4"	W10DC	steel cable	steel	
1-1/2"	W12DC	steel cable	steel	

Body Size	W-Series Wingstyle Interchange Coupler Repair Kits				
	Part Detail			Repair Kit Contents (for one coupler)	
	Part #	Coupler Style	Seal Material		
3/4"	6W-RKIT-V2	all	nitrile	bonded valve, O-rings, and Hytrel® backup	
1"	8W-RKIT-V2	all	nitrile	bonded valve, O-rings, and Hytrel® backup	
1-1/4"	10W-RKIT-V2	all	nitrile	bonded valve, O-rings, and Hytrel® backup	
1-1/2"	12W-RKIT-V2	all	nitrile	bonded valve, O-rings, and Hytrel® backup	

Body Size	W-Series Wingstyle Interchange Plug Repair Kits				
	Part Detail			Repair Kit Contents (for one coupler)	
	Part #	Coupler Style	Seal Material		
3/4"	W6-RKIT-V2	all	nitrile	valve assembly and O-ring	
1"	W8-RKIT-V2	all	nitrile	valve assembly and O-ring	
1-1/4"	W10-RKIT-V2	all	nitrile	valve assembly and O-ring	
1-1/2"	W12-RKIT-V2	all	nitrile	valve assembly and O-ring	

Interchange Data

- Parker/ Snap-Tite 75-Series, Hydraulics Inc. Series-5TV, DNP VFF-HD, Stucchi VOF, Faster OGV, Eaton FD85, Holmbury LC

Materials

- Machined components are manufactured using solid steel or 316 stainless steel bar stock
- Stainless steel retaining rings and springs maximize corrosion resistance and extend service life
- Steel componentry is plated using ROHS compliant zinc nickel for corrosion resistance
- Rugged high-strength steel sand-cast wing nut for threaded connect and disconnect operation
- 316 stainless steel plug connection-threads are coated to prevent galling during connection/disconnection

Seal Components

- Nitrile (Buna-N) seals are standard, providing a temperature range of **-40°F to 250°F (-40°C to 121°C)**
- PTFE anti-extrusion ring protects main coupling O-ring from dynamic impulse pressure damage

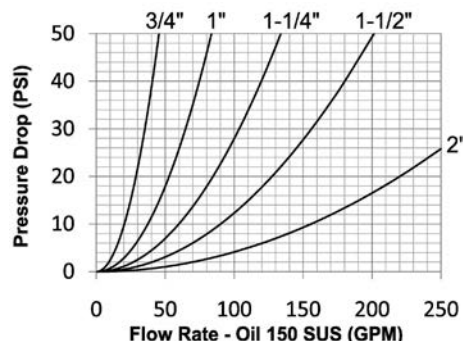

Rated Pressure Chart

Body Size	WS-Series Heavy-Duty Wingstyle (Connected)							
	Steel Coupler/Plug				316 Stainless Steel Coupler/Plug			
	Maximum Working		Burst		Maximum Working		Burst	
	PSI	Bar	PSI	Bar	PSI	Bar	PSI	Bar
3/4"	5,000	345	32,800	2,200	3,000	200	20,000	1,400
1"	5,000	345	25,100	1,700	3,000	200	20,000	1,400
1-1/4"	5,000	345	25,100	1,700	3,000	200	15,000	1,000
1-1/2"	5,000	345	20,000	1,400	3,000	200	15,000	1,000
2"	5,000	345	15,000	1,000	3,000	200	15,000	1,000

Technical Specifications

Body Size	Interchange Standards				Functional Parameters				
	U.S. Military	U.S. Government	International Standards	ANSI/NFPA Standards	Locking Mechanism	Air Inclusion	Fluid Loss	Vacuum inch HG	Flow ΔP = 30 PSI
3/4"	-	-	-	-	threaded	10cc	10cc	27.4	35 GPM
1"	-	-	-	-	threaded	23cc	15cc	27.4	65 GPM
1-1/4"	-	-	-	-	threaded	50cc	30cc	27.4	105 GPM
1-1/2"	-	-	-	-	threaded	100cc	60cc	27.4	160 GPM
2"					threaded	200cc	135cc	27.4	270 GPM

Available Options

Body Size	Standard Seal Options					Standard Coupling Options		
	FKM	EPDM	Mil-Nitrile	Fuel Nitrile	Silicone	Wrench Flats	View Port	Oxy-Clean
	Pre	Pre	Pre	Pre	Pre	Suf	Suf	Suf
3/4"	F-	P-	M-	JF-	S-	-WF	-VP	-C1
1"	F-	P-	M-	JF-	S-	-WF	-VP	-C1
1-1/4"	F-	P-	M-	JF-	S-	-WF	-VP	-C1
1-1/2"	F-	P-	M-	JF-	S-	-WF	-VP	-C1
2"	F-	P-	M-	JF-	S-	-WF	-VP	-C1

Hydraulic Couplings: WS-Series

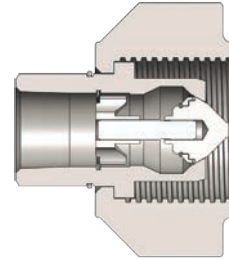

Body Size	WS-Series Heavy-Duty Wingstyle Coupler (Female Threads)							
	Part Detail			Length		Maximum OD		Hex inch
	Part #	Threads	Material	inch	mm	inch	mm	
3/4"	6WSF4	1/2" - 14 NPTF	steel	2.76	70.1	3.31	82.0	-
	6WSF6	3/4" - 14 NPTF	steel	2.76	70.1	3.31	82.0	-
	6WSF6-SS	3/4" - 14 NPTF	316 stainless	2.76	70.1	3.31	82.0	-
	6WSBF6	3/4" - 14 BSPP	steel	2.76	70.1	3.31	82.0	-
	6WSBF6-SS	3/4" - 14 BSPP	316 stainless	2.76	70.1	3.31	82.0	-
	6WSOF6	1-1/16" - 12 ORB	steel	2.76	70.1	3.31	82.0	-
1"	8WSF8	1" - 11-1/2 NPTF	steel	3.45	87.6	4.10	101.6	-
	8WSF8-SS	1" - 11-1/2 NPTF	316 stainless	3.45	87.6	4.10	101.6	-
	8WSBF8	1" - 11 BSPP	steel	3.45	87.6	4.10	101.6	-
	8WSBF8-SS	1" - 11 BSPP	316 stainless	3.45	87.6	4.10	101.6	-
	8WSOF8	1-5/16" - 12 ORB	steel	3.45	87.6	4.10	101.6	-
1-1/4"	10WSF10	1-1/4" - 11-1/2 NPTF	steel	4.40	111.8	4.78	118.1	-
	10WSF10-SS	1-1/4" - 11-1/2 NPTF	316 stainless	4.40	111.8	4.78	118.1	-
	10WSBF10	1-1/4" - 11 BSPP	steel	4.40	111.8	4.78	118.1	-
	10WSBF10-SS	1-1/4" - 11 BSPP	316 stainless	4.40	111.8	4.78	118.1	-
	10WSOF10	1-5/8" - 12 ORB	steel	4.40	111.8	4.78	118.1	-
1-1/2"	12WSF12	1-1/2" - 11-1/2 NPTF	steel	5.13	130.3	5.68	137.9	-
	12WSF12-SS	1-1/2" - 11-1/2 NPTF	316 stainless	5.13	130.3	5.68	137.9	-
	12WSBF12	1-1/2" - 11 BSPP	steel	5.13	130.3	5.68	137.9	-
	12WSBF12-SS	1-1/2" - 11 BSPP	316 stainless	5.13	130.3	5.68	137.9	-
	12WSOF12	1-7/8" - 12 ORB	steel	5.13	130.3	5.68	137.9	-
2"	16WSF16	2" - 11-1/2 NPTF	steel	6.09	154.7	6.90	170.9	-
	16WSF16-SS	2" - 11-1/2 NPTF	316 stainless	6.09	154.7	6.90	170.9	-
	16WSBF16	2" - 11 BSPP	steel	6.09	154.7	6.90	170.9	-
	16WSBF16-SS	2" - 11 BSPP	316 stainless	6.09	154.7	6.90	170.9	-
	16WSOF16	2-1/2" - 12 ORB	steel	6.09	154.7	6.90	170.9	-

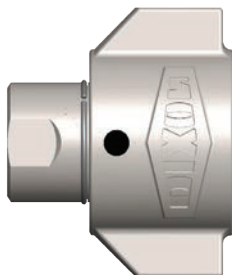

WS coupler with view port



WS coupler with wrench flats

NOTE: Wrench flats may result in reduced pressure performance.

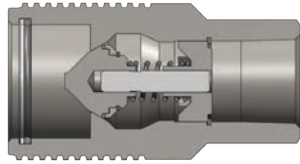

Body Size	WS-Series Heavy-Duty Wingstyle Plug (Female Threads)							
	Part Detail			Length		Maximum OD		Hex inch
	Part #	Threads	Material	inch	mm	inch	mm	
3/4"	WS6F4	1/2" - 14 NPTF	steel	3.27	83.1	1.74	44.2	-
	WS6F6	3/4" - 14 NPTF	steel	3.27	83.1	1.74	44.2	-
	WS6F6-SS	3/4" - 14 NPTF	316 stainless	3.27	83.1	1.74	44.2	-
	WS6BF6	3/4" - 14 BSPP	steel	3.27	83.1	1.74	44.2	-
	WS6BF6-SS	3/4" - 14 BSPP	316 stainless	3.27	83.1	1.74	44.2	-
	WS6OF6	1-1/16" - 12 ORB	steel	3.27	83.1	1.74	44.2	-
1"	WS8F8	1" - 11-1/2 NPTF	steel	4.18	106.2	2.25	57.2	-
	WS8F8-SS	1" - 11-1/2 NPTF	316 stainless	4.18	106.2	2.25	57.2	-
	WS8BF8	1" - 11 BSPP	steel	4.18	106.2	2.25	57.2	-
	WS8BF8-SS	1" - 11 BSPP	316 stainless	4.18	106.2	2.25	57.2	-
	WS8OF8	1-5/16" - 12 ORB	steel	4.18	106.2	2.25	57.2	-
1-1/4"	WS10F10	1-1/4" - 11-1/2 NPTF	steel	5.38	136.7	2.63	66.8	-
	WS10F10-SS	1-1/4" - 11-1/2 NPTF	316 stainless	5.38	136.7	2.63	66.8	-
	WS10BF10	1-1/4" - 11 BSPP	steel	5.38	136.7	2.63	66.8	-
	WS10BF10-SS	1-1/4" - 11 BSPP	316 stainless	5.38	136.7	2.63	66.8	-
	WS10OF10	1-5/8" - 12 ORB	steel	5.38	136.7	2.63	66.8	-
1-1/2"	WS12F12	1-1/2" - 11-1/2 NPTF	steel	5.98	151.9	3.25	82.6	-
	WS12F12-SS	1-1/2" - 11-1/2 NPTF	316 stainless	5.98	151.9	3.25	82.6	-
	WS12BF12	1-1/2" - 11 BSPP	steel	5.98	151.9	3.25	82.6	-
	WS12BF12-SS	1-1/2" - 11 BSPP	316 stainless	5.98	151.9	3.25	82.6	-
	WS12OF12	1-7/8" - 12 ORB	steel	5.98	151.9	3.25	82.6	-
2"	WS16F16	2" - 11-1/2 NPTF	steel	7.05	179.1	4.00	101.6	-
	WS16F16-SS	2" - 11-1/2 NPTF	316 stainless	7.05	179.1	4.00	101.6	-
	WS16BF16	2" - 11 BSPP	steel	7.05	179.1	4.00	101.6	-
	WS16BF16-SS	2" - 11 BSPP	316 stainless	7.05	179.1	4.00	101.6	-
	WS16OF16	2-1/2" - 12 ORB	steel	7.05	179.1	4.00	101.6	-

Hydraulic Couplings: WS-Series

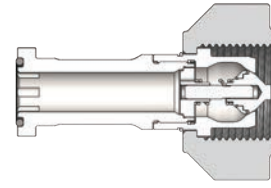
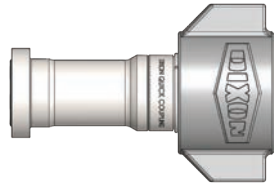

Body Size	WS-Series Heavy-Duty Wingstyle Code 62 Flange Head Coupler						
	Part Detail			Length		Maximum OD	
	Part #	Port Size	Material	inch	mm	inch	mm
3/4"	6WSFH6	3/4" code 62 flange head	steel	4.79	121.67	3.31	84.07
1"	8WSFH8	1" code 62 flange head	steel	6.98	177.29	4.10	104.14
1-1/4"	10WSFH10	1-1/4" code 62 flange head	steel	8.27	210.06	4.78	121.41
1-1/2"	12WSFH12	1-1/2" code 62 flange head	steel	9.30	236.14	5.68	144.27
2"	16WSFH16	2" code 62 flange head	steel	10.82	274.93	6.90	175.26

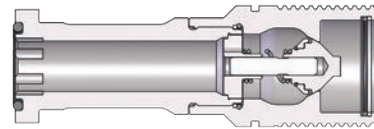

Body Size	WS-Series Heavy-Duty Wingstyle Code 62 Flange Head Plug						
	Part Detail			Length		Maximum OD	
	Part #	Port Size	Material	inch	mm	inch	mm
3/4"	WS6FH6	3/4" code 62 flange head	steel	5.23	132.84	1.74	44.20
1"	WS8FH8	1" code 62 flange head	steel	7.84	199.14	2.25	57.15
1-1/4"	WS10FH10	1-1/4" code 62 flange head	steel	9.39	238.61	2.63	66.68
1-1/2"	WS12FH12	1-1/2" code 62 flange head	steel	10.15	257.76	3.25	82.55
2"	WS16FH16	2" code 62 flange head	steel	11.78	299.31	4.00	101.60

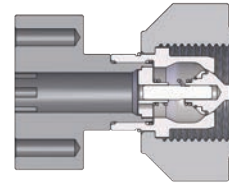
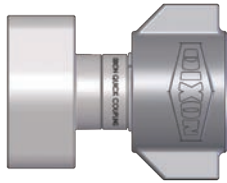

Body Size	WS-Series Heavy-Duty Wingstyle Code 62 Flange Pad Coupler						
	Part Detail			Length		Maximum OD	
	Part #	Port Size	Material	inch	mm	inch	mm
3/4"	6WSFP6	3/4" code 62 flange pad	steel	4.04	102.62	3.31	84.07
1"	8WSFP8	1" code 62 flange pad	steel	5.48	139.19	4.10	104.14
1-1/4"	10WSFP10	1-1/4" code 62 flange pad	steel	6.79	172.47	4.78	121.41
1-1/2"	12WSFP12	1-1/2" code 62 flange pad	steel	8.40	213.31	5.68	144.27
2"	16WSFP16	2" code 62 flange pad	steel	9.40	238.73	6.90	175.26

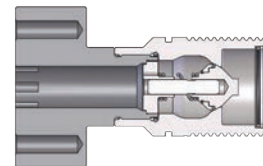
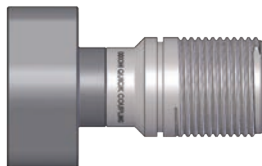

Body Size	WS-Series Heavy-Duty Wingstyle Code 62 Flange Pad Plug						
	Part Detail			Length		Maximum OD	
	Part #	Port Size	Material	inch	mm	inch	mm
3/4"	WS6FP6	3/4" code 62 flange pad	steel	4.48	113.79	3.02	76.71
1"	WS8FP8	1" code 62 flange pad	steel	6.34	161.04	3.44	87.40
1-1/4"	WS10FP10	1-1/4" code 62 flange pad	steel	7.91	201.02	4.03	102.41
1-1/2"	WS12FP12	1-1/2" code 62 flange pad	steel	9.25	234.90	4.76	120.90
2"	WS16FP16	2" code 62 flange pad	steel	10.36	263.12	5.67	144.12



Body Size	WS-Series Coupler Rigid Dust Plug		
	Part Detail		
	Part #	Lanyard	Body
3/4"	6WSDP-A	steel cable	aluminum
1"	8WSDP-A	steel cable	aluminum
1-1/4"	10WSDP-A	steel cable	aluminum
1-1/2"	12WSDP-A	steel cable	aluminum
2"	16WSDP-A	steel cable	aluminum



Body Size	WS-Series Plug Rigid Dust Cap		
	Part Detail		
	Part #	Lanyard	Body
3/4"	WS6DC-A	steel cable	aluminum
1"	WS8DC-A	steel cable	aluminum
1-1/4"	WS10DC-A	steel cable	aluminum
1-1/2"	WS12DC-A	steel cable	aluminum
2"	WS16DC-A	steel cable	aluminum

Hydraulic Couplings: WS-Series

Body Size	WS-Series Heavy-Duty Wingstyle Interchange Coupler Seal Kits			
	Part Detail			Seal Kit Contents
	Part #	Coupler Style	Seal Material	
3/4"	6WS-SKIT	all	nitrile	body / valve seals and retaining rings
1"	8WS-SKIT	all	nitrile	body / valve seals and retaining rings
1-1/4"	10WS-SKIT	all	nitrile	body / valve seals and retaining rings
1-1/2"	12WS-SKIT	all	nitrile	body / valve seals and retaining rings
2"	16WS-SKIT	all	nitrile	body / valve seals and retaining rings

Body Size	WS-Series BOP Wingstyle Interchange Coupler Seal Kits			
	Part Detail			Seal Kit Contents
	Part #	Coupler Style	Seal Material	
3/4"	6BOP-SKIT	all	FR FKM	body / valve seals and retaining rings
1"	8BOP-SKIT	all	FR FKM	body / valve seals and retaining rings
1-1/4"	10BOP-SKIT	all	FR FKM	body / valve seals and retaining rings
1-1/2"	12BOP-SKIT	all	FR FKM	body / valve seals and retaining rings
2"	16BOP-SKIT	all	FR FKM	body / valve seals and retaining rings

Body Size	WS-Series Heavy-Duty Wingstyle Interchange Coupler Repair Kits			
	Part Detail			Repair Kit Contents (for one coupler or plug)
	Part #	Coupler Style	Seal Material	
3/4"	6WS-RKIT	all	nitrile	valve assembly, O-ring, and PTFE B.U.
1"	8WS-RKIT	all	nitrile	valve assembly, O-ring, and PTFE B.U.
1-1/4"	10WS-RKIT	all	nitrile	valve assembly, O-ring, and PTFE B.U.
1-1/2"	12WS-RKIT	all	nitrile	valve assembly, O-ring, and PTFE B.U.
2"	16WS-RKIT	all	nitrile	valve assembly, O-ring, and PTFE B.U.

Interchange Data

- Parker/Snap-Tite 75-Series, DNP VFF-HD BOP-Series

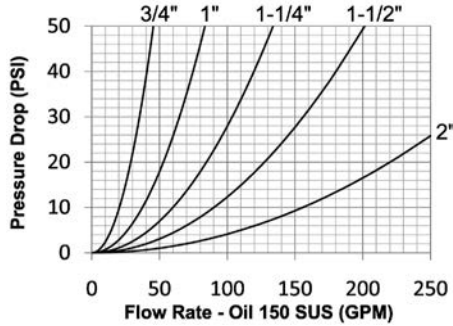

Seal Components

- Blowout preventer (BOP) couplings contain severe service FKM seals
- PTFE anti-extrusion ring protects main coupling valve seal from dynamic impulse pressure damage

Materials

- Machined components are manufactured using solid steel or 316 stainless steel bar stock
- Stainless steel retaining rings and springs maximize corrosion resistance and extend service life
- Steel componentry is plated using ROHS-compliant zinc nickel
- Rugged high-strength steel wing nut for threaded connect and disconnect operation
- 316 stainless steel plug connection-threads are coated to prevent galling during connection/disconnection
- Red powder-coated coupler wing-nut and external plug O-ring for easy BOP service identification

- BOP couplings have been fire tested and Lloyd's certified to 1300°F (700°C) in accordance with API 16D. Certificate available upon request.
- Use WS dust caps and dust plugs found on page 153

Rated Pressure Chart

Body Size	WS-BOP-Series Blowout Preventer Heavy-Duty Wingstyle							
	Steel Coupler/Plug				316 SS Coupler/Plug			
	Maximum Working		Burst		Maximum Working		Burst	
	PSI	Bar	PSI	Bar	PSI	Bar	PSI	Bar
3/4"	5,000	345	32,800	2,200	5,000	345	20,000	1,400
1"	5,000	345	25,100	1,700	5,000	345	20,000	1,400
1-1/4"	5,000	345	25,100	1,700	5,000	345	15,000	1,000
1-1/2"	5,000	345	20,000	1,400	5,000	345	15,000	1,000
2"	5,000	345	15,000	1,000	5,000	345	15,000	1,000

Technical Specifications

Body Size	Functional Parameters					Lloyd's Test Pressure
	Locking Mechanism	Air Inclusion	Fluid Loss	Vacuum inch HG	Flow ΔP = 30 PSI	PSI
3/4"	threaded	10cc	10cc	27.4	35 GPM	5,000
1"	threaded	23cc	15cc	27.4	65 GPM	5,000
1-1/4"	threaded	50cc	30cc	27.4	105 GPM	5,000
1-1/2"	threaded	100cc	60cc	27.4	160 GPM	5,000
2"	threaded	200cc	135cc	27.4	270 GPM	5,000

Body Size	A	B
3/4"	1.74	1.53
1"	2.25	1.90
1-1/4"	2.63	2.28
1-1/2"	3.25	2.80
2"	4.00	3.64

WS-BOP-Series Profile

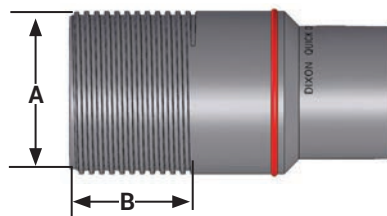

Hydraulic Couplings: WS-BOP-Series

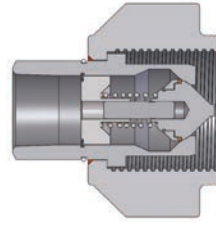

Body Size	WS-BOP-Series Blowout Preventer Safety Coupler (Female Threads)							
	Part Detail			Length		Maximum OD		Hex inch
	Part #	Threads	Material	inch	mm	inch	mm	
3/4"	6WSF4-BOP	1/2" - 14 NPTF	steel	2.76	70.1	3.31	82.0	-
	6WSF6-BOP	3/4" - 14 NPTF	steel	2.76	70.1	3.31	82.0	-
	6WSF6-SS-BOP	3/4" - 14 NPTF	316 stainless	2.76	70.1	3.31	82.0	-
1"	8WSF8-BOP	1" - 11-1/2 NPTF	steel	3.45	87.6	4.10	101.6	-
	8WSF8-SS-BOP	1" - 11-1/2 NPTF	316 stainless	3.45	87.6	4.10	101.6	-
1-1/4"	10WSF10-BOP	1-1/4" - 11-1/2 NPTF	steel	4.40	111.8	4.78	118.1	-
	10WSF10-SS-BOP	1-1/4" - 11-1/2 NPTF	316 stainless	4.40	111.8	4.78	118.1	-
1-1/2"	12WSF12-BOP	1-1/2" - 11-1/2 NPTF	steel	5.13	130.3	5.68	137.9	-
	12WSF12-SS-BOP	1-1/2" - 11-1/2 NPTF	316 stainless	5.13	130.3	5.68	137.9	-
2"	16WSF16-BOP	2" - 11-1/2 NPTF	steel	6.09	154.7	6.90	170.9	-
	16WSF16-SS-BOP	2" - 11-1/2 NPTF	316 stainless	6.09	154.7	6.90	170.9	-

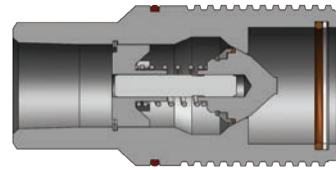

Body Size	WS-BOP-Series Blowout Preventer Safety Plug (Female Threads)							
	Part Detail			Length		Maximum OD		Hex inch
	Part #	Threads	Material	inch	mm	inch	mm	
3/4"	WS6F4-BOP	1/2" - 14 NPTF	steel	3.27	83.1	1.74	44.2	-
	WS6F6-BOP	3/4" - 14 NPTF	steel	3.27	83.1	1.74	44.2	-
	WS6F6-SS-BOP	3/4" - 14 NPTF	316 stainless	3.27	83.1	1.74	44.2	-
1"	WS8F8-BOP	1" - 11-1/2 NPTF	steel	4.18	106.2	2.25	57.2	-
	WS8F8-SS-BOP	1" - 11-1/2 NPTF	316 stainless	4.18	106.2	2.25	57.2	-
1-1/4"	WS10F10-BOP	1-1/4" - 11-1/2 NPTF	steel	5.38	136.7	2.63	66.8	-
	WS10F10-SS-BOP	1-1/4" - 11-1/2 NPTF	316 stainless	5.38	136.7	2.63	66.8	-
1-1/2"	WS12F12-BOP	1-1/2" - 11-1/2 NPTF	steel	5.98	151.9	3.25	82.6	-
	WS12F12-SS-BOP	1-1/2" - 11-1/2 NPTF	316 stainless	5.98	151.9	3.25	82.6	-
2"	WS16F16-BOP	2" - 11-1/2 NPTF	steel	7.05	179.1	4.00	101.6	-
	WS16F16-SS-BOP	2" - 11-1/2 NPTF	316 stainless	7.05	179.1	4.00	101.6	-

Interchange Data

- High-pressure 10K thread-together interchange
- Parker/Pioneer 3000-Series, Enerpac C604, Stucchi IVHP
- Eaton WS56000 and DNP PVM
- Interchangeable to ISO 14540

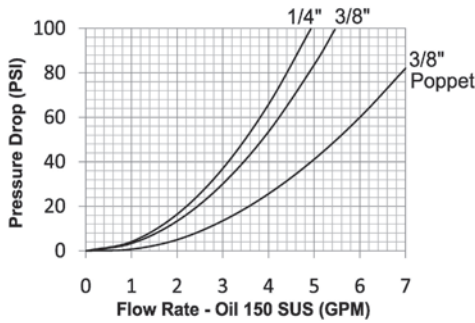

Seal Components

- Nitrile O-ring with TPC-ET back-up ring is standard, providing a temperature range of **-40°F to 250°F** (**-40°C to 121°C**)

Materials

- Machined components are manufactured using solid steel or 316 stainless steel bar stock
- Chrome steel ball valve is mechanically seated to improve pressure sealing performance
- Steel plugs are machined from solid high strength steel bar stock
- Steel componentry is plated using ROHS-compliant trivalent chrome

Rated Pressure Chart

Body Size	T-Series 10K Threaded (Connected)															
	Steel Ball Coupler/Plug				316 SS Ball Coupler/Plug				Steel Poppet Coupler/Plug				316 SS Poppet Coupler/Plug			
	Max. Working		Burst		Max. Working		Burst		Max. Working		Burst		Max. Working		Burst	
	PSI	Bar	PSI	Bar	PSI	Bar	PSI	Bar	PSI	Bar	PSI	Bar	PSI	Bar	PSI	Bar
1/4"	10,000	700	34,300	2,350	-	-	-	-	-	-	-	-	-	-	-	-
3/8"	10,000	700	30,000	2,050	10,000	700	30,900	2,100	10,000	700	36,800	2,500	10,000	700	36,500	2,500

Technical Specifications

Body Size	Interchange Standards				Functional Parameters					
	U.S. Military	U.S. Government	International Standards	ANSI/NFPA Standards	Valve Style	Air Inclusion	Fluid Loss	Vacuum inch HG	Flow $\Delta P = 60$ PSI	
1/4"	-	-	ISO14540	-	ball	0.97	0.56	N/R	3.8 GPM	
3/8"	-	-	ISO14540	-	ball	2.04	0.98	N/R	4.2 GPM	
	-	-	ISO14540	-	poppet	1.56	0.77	N/R	6.0 GPM	

Available Options

Body Size	Seal Options		Kalrez® Seal Options			Valve Options		Treatments
	FKM	Mil-Nitrile	4079	6375	7075	Unvalved	316 SS	Oxy-Clean
1/4"	F-	M-	K4-	K6-	K7-	-E	N/A	-C1
3/8"	F-	M-	K4-	K6-	K7-	-E	N/A	-C1

T-Series Profiles

Body Size	A	B
1/4"	0.62	0.44
3/8"	0.37	0.63

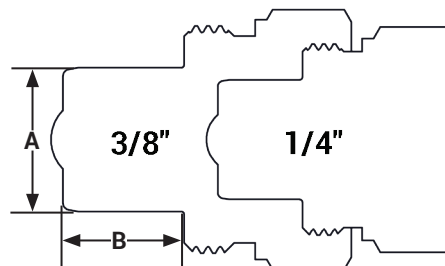

Hydraulic Couplings: T-Series

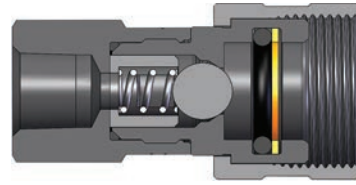

T-Series 10K Threaded Ball Coupler (Female Threads)

Body Size	T-Series 10K Threaded Ball Coupler (Female Threads)							
	Part Detail			Length		Maximum OD		Hex inch
	Part #	Threads	Material	inch	mm	inch	mm	
1/4"	2TF2	1/4" - 18 NPTF	steel	2.09	53.09	1.13	28.70	13/16"
3/8"	3TF3	3/8" - 18 NPTF	steel	2.54	64.60	1.37	34.70	1"

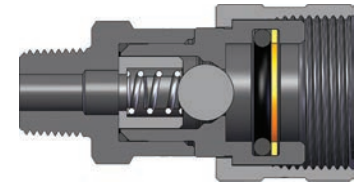

T-Series 10K Threaded Ball Coupler (Male Threads)

Body Size	T-Series 10K Threaded Ball Coupler (Male Threads)							
	Part Detail			Length		Maximum OD		Hex inch
	Part #	Threads	Material	inch	mm	inch	mm	
1/4"	2TM2	1/4" - 18 NPTF	steel	2.16	54.9	1.13	28.6	13/16"
3/8"	3TM3	3/8" - 18 NPTF	steel	2.59	65.8	1.37	34.7	1"
	3TM3-SS	3/8" - 18 NPT	316 stainless	2.59	65.8	1.37	34.7	1"

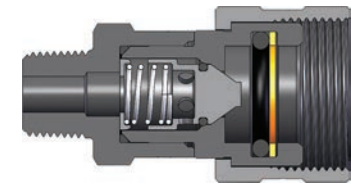

T-Series 10K Threaded Poppet Coupler (Male Threads)

Body Size	T-Series 10K Threaded Poppet Coupler (Male Threads)							
	Part Detail			Length		Maximum OD		Hex inch
	Part #	Threads	Material	inch	mm	inch	mm	
3/8"	3TM3-PV	3/8" - 18 NPT	steel	2.78	70.7	1.36	34.5	1"
	3TM3-SS-PV	3/8" - 18 NPT	316 stainless	2.78	70.7	1.36	34.5	1"

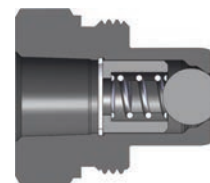

T-Series 10K Threaded Ball Plug (Female Threads)

Body Size	T-Series 10K Threaded Ball Plug (Female Threads)							
	Part Detail			Length		Maximum OD		Hex inch
	Part #	Threads	Material	inch	mm	inch	mm	
1/4"	T2F2	1/4" - 18 NPTF	steel	1.29	32.9	1.07	27.2	1-1/16"
3/8"	T3F3	3/8" - 18 NPTF	steel	1.56	39.7	1.35	34.3	1-1/4"
	T3F3-SS	3/8" - 18 NPT	316 stainless	1.56	39.7	1.35	34.3	1-1/4"

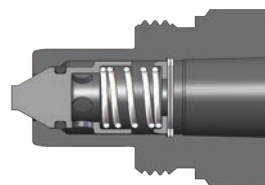
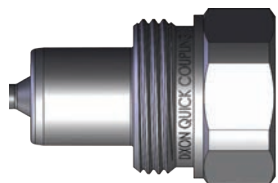

Body Size	T-Series 10K Threaded Poppet Plug (Female Threads)							
	Part Detail			Length		Maximum OD		Hex inch
	Part #	Threads	Material	inch	mm	inch	mm	
3/8"	T3F3-PV	3/8" - 18 NPT	steel	1.53	38.9	1.19	30.2	15/16"
	T3F3-SS-PV	3/8" - 18 NPT	316 stainless	1.53	38.9	1.19	30.2	15/16"



Body Size	T-Series Coupler Rigid Dust Plug			
	Part Detail			
	Part #	Lanyard	Body	
1/4"	2TDP	rubber	steel	
3/8"	3TDP	rubber	steel	



Body Size	T-Series Plug Rigid Dust Cap			
	Part Detail			
	Part #	Lanyard	Body	
1/4"	T2DC	steel cable	steel	
3/8"	T3DC	steel cable	steel	

Body Size	T-Series 10K Threaded Coupler Seal Kits				
	Part Detail			Seal Kit Contents	
	Part #	Coupler Style	Seal Material		
1/4"	2T-SKIT	ball valve	nitrile	nitrile o-ring with TPC-ET back-up ring	
3/8"	3T-SKIT	ball valve	nitrile	nitrile o-ring with TPC-ET back-up ring	

Hydraulic Couplings: CVV-Series

Interchange Data

- Interchangeable with ISO14541 1/4" - 3/4"
- European screw-together interchange
- Inteva STG-Series, Faster CVV-Series, DNP PVV3, Voswinkel Type-HS

Materials

- Machined components are manufactured using solid steel bar stock
- Steel retaining rings and springs maximize service life in rugged environments
- Steel componentry is plated using ROHS-compliant trivalent chrome

Seal Components

- Nitrile (Buna-N) seals are standard, providing a temperature range of -13°F to 257°F (-25°C to 125°C)
- Plugs have a PTFE anti-extrusion ring to prevent O-ring damage during dynamic impulse service

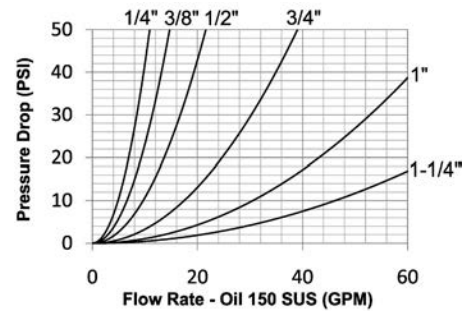

Rated Pressure Chart

Body Size	CVV-Series European Screw-Together Interchange			
	Coupler/Plug Coupled			
	Maximum Working		Burst	
	PSI	Bar	PSI	Bar
1/4"	6,500	450	26,000	1,800
3/8"	6,500	450	26,000	1,800
1/2"	5,800	400	23,200	1,600
3/4"	5,800	400	23,200	1,600
1"	4,400	300	17,600	1,200
1-1/4"	4,400	300	17,600	1,200

Technical Specifications

Body Size	Interchange Standards				Functional Parameters				
	U.S. Military	U.S. Government	International Standards	ANSI/NFPA Standards	Locking Mechanism	Air Inclusion	Fluid Loss	Vacuum Inch HG	Flow ΔP = 22 PSI
1/4"	-	-	ISO14541	-	Threaded	N/A	N/A	27.4	7 GPM
3/8"	-	-	ISO14541	-	Threaded	N/A	N/A	27.4	10 GPM
1/2"	-	-	ISO14541	-	Threaded	N/A	N/A	27.4	15 GPM
3/4"	-	-	ISO14541	-	Threaded	N/A	N/A	27.4	26 GPM
1"	-	-	-	-	Threaded	N/A	N/A	27.4	45 GPM
1-1/4"	-	-	-	-	Threaded	N/A	N/A	27.4	70 GPM

NOTE: Threaded sleeves enable easy connection and disconnection while system is under residual pressure only.

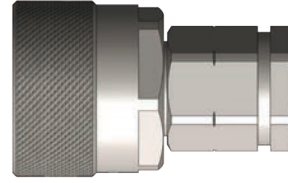
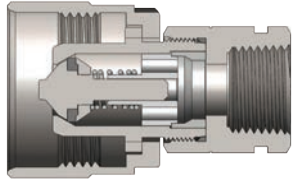

Body Size	CVV-Series European Interchange Coupler (Female Threads)							
	Part Detail			Length		Maximum OD		Hex mm
	Part #	Threads	Material	inch	mm	inch	mm	
1/4"	2CVVF2	1/4" - 18 NPTF	steel	2.33	59.3	1.34	34.0	19
	2CVVBF2	1/4" - 19 BSPP	steel	2.33	59.3	1.34	34.0	19
	2CVVFM1415	M14X1.5	steel	2.33	59.3	1.34	34.0	19
3/8"	3CVVF3	3/8" - 18 NPTF	steel	2.41	61.2	1.34	34.0	22
	3CVVBF3	3/8" - 19 BSPP	steel	2.41	61.2	1.34	34.0	22
	3CVVFM1615	M16X1.5	steel	2.41	61.2	1.34	34.0	22
1/2"	4CVVF4	1/2" - 14 NPTF	steel	2.66	67.5	1.65	41.8	27
	4CVVOF4	3/4" - 16 ORB	steel	2.66	67.5	1.65	41.8	27
	4CVVBF4	1/2" - 14 BSPP	steel	2.66	67.5	1.65	41.8	27
	4CVVFM1815	M18X1.5	steel	2.66	67.5	1.65	41.8	27
	4CVVOF5	7/8" - 14ORB	steel	2.66	67.5	1.65	41.8	27
	4CVVFM2215	M22X1.5	steel	2.66	67.5	1.65	41.8	27
3/4"	6CVVF6	3/4" - 14 NPTF	steel	3.15	80.0	1.89	48.0	36
	6CVVBF6	3/4" - 14 BSPP	steel	3.15	80.0	1.89	48.0	36
	6CVVFM2215	M22X1.5	steel	3.15	80.0	1.89	48.0	36
1"	8CVVF8	1" - 11-1/2 NPTF	steel	3.30	83.9	2.35	59.8	41
	8CVVBF8	1" - 11 BSPP	steel	3.30	83.9	2.35	59.8	41
1-1/4"	10CVVF10	1-1/4" - 11-1/2 NPTF	steel	5.59	142.0	3.14	79.8	50
	10CVVBF10	1-1/4" - 11 BSPP	steel	5.59	142.0	3.14	79.8	50

Hydraulic Couplings: CVV-Series

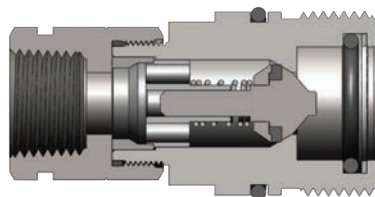
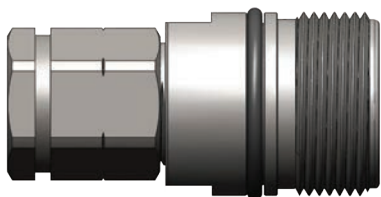

Body Size	CVV-Series European Interchange Plug (Female Threads)							
	Part Detail			Length		Maximum OD		Hex mm
	Part #	Threads	Material	inch	mm	inch	mm	
1/4"	CVV2F2	1/4" - 18 NPTF	steel	2.36	60.0	0.94	24.0	19
	CVV2BF2	1/4" - 19 BSPP	steel	2.36	60.0	0.94	24.0	19
	CVV2FM1415	M14X1.5	steel	2.36	60.0	0.94	24.0	19
3/8"	CVV3F3	3/8" - 18 NPTF	steel	2.52	64.0	1.10	28.0	22
	CVV3BF3	3/8" - 19 BSPP	steel	2.52	64.0	1.10	28.0	22
	CVV3FM1615	M16X1.5	steel	2.52	64.0	1.10	28.0	22
1/2"	CVV4F4	1/2" - 14 NPTF	steel	2.76	70.0	1.42	36.0	27
	CVV4OF4	3/4" - 16 ORB	steel	2.76	70.0	1.42	36.0	27
	CVV4BF4	1/2" - 14 BSPP	steel	2.76	70.0	1.42	36.0	27
	CVV4FM1815	M18X1.5	steel	2.76	70.0	1.42	36.0	27
	CVV4OF5	7/8" - 14ORB	steel	2.76	70.0	1.42	36.0	27
	CVV4FM2215	M22X1.5	steel	2.76	70.0	1.42	36.0	27
3/4"	CVV6F6	3/4" - 14 NPTF	steel	3.39	86.0	1.65	42.0	36
	CVV6BF6	3/4" - 14 BSPP	steel	3.39	86.0	1.65	42.0	36
	CVV6FM2215	M22X1.5	steel	3.39	86.0	1.65	42.0	36
1"	CVV8F8	1" - 11-1/2 NPTF	steel	3.94	100.0	1.89	48.0	41
	CVV8BF8	1" - 11 BSPP	steel	3.94	100.0	1.89	48.0	41
1-1/4"	CVV10F10	1-1/4" - 11-1/2 NPTF	steel	5.91	150.0	2.76	70.0	50
	CVV10BF10	1-1/4" - 11 BSPP	steel	5.91	150.0	2.76	70.0	50



Body Size	CVV-Series European Interchange Dust Plug		
	Part Detail		
	Part #	Lanyard	Body
1/4"	2CVVDP	plastic	plastic
3/8"	3CVVDP	plastic	plastic
1/2"	4CVVDP	plastic	plastic
3/4"	6CVVDP	plastic	plastic
1"	8CVVDP	plastic	plastic
1-1/4"	10CVVDP	plastic	plastic



Body Size	CVV-Series European Interchange Dust Cap		
	Part Detail		
	Part #	Lanyard	Body
1/4"	CVV2DC	plastic	plastic
3/8"	CVV3DC	plastic	plastic
1/2"	CVV4DC	plastic	plastic
3/4"	CVV6DC	plastic	plastic
1"	CVV8DC	plastic	plastic
1-1/4"	CVV10DC	plastic	plastic

CVV-Series Profiles

Body Size	A	B
1/4"	0.94	0.50
3/8"	1.10	0.57
1/2"	1.41	0.66
3/4"	1.64	0.77
1"	1.88	0.77
1-1/4"	2.75	1.28

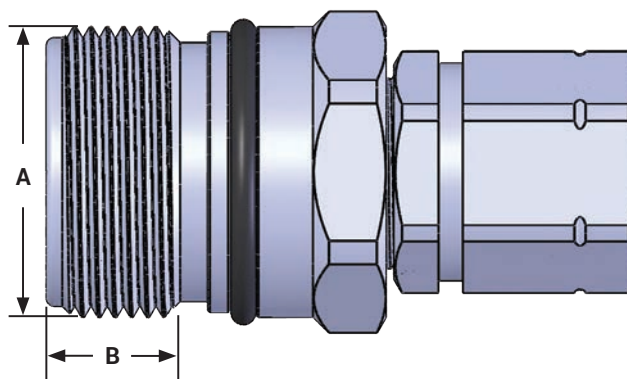

Hydraulic Couplings: TD-Series

Interchange Data

- Spir Star CQD Series, DNP CRS Series, Jetstream Screw Type

Materials

- Machined components are manufactured using 316 stainless steel bar stock
- Stainless steel retaining rings maximize corrosion resistance and extend service life

Seal Components

- Nitrile (Buna-N) seals are standard, providing a temperature range of -40°F to 250°F (-40°C to 121°C)
- Couplers have a nitrile anti-extrusion ring, providing resistance to O-ring dynamic impulse pressure damage

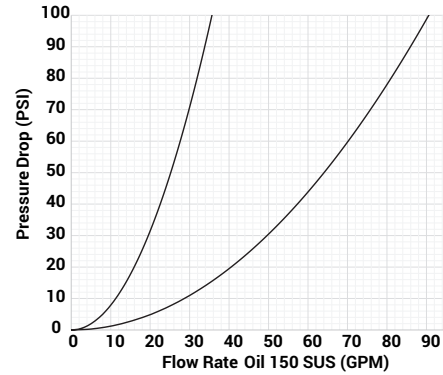

Rated Pressure Chart

Body Size	TD-Series 15K and 20K Threaded Couplings	
	Maximum Working	
	PSI	Bar
1/2" x 1/2" NPTF	15,000	1,034
1/2" x 9/16" MP	20,000	1,379

Technical Specifications

Body Size	Interchange Standards				Functional Parameters				
	U.S. Military	U.S. Government	International Standards	ANSI/NFPA Standards	Threaded	Air Inclusion	Fluid Loss	Vacuum inch HG	Flow $\Delta P = 40$ PSI
1/2"	-	-	-	-	Maxi-Latch	N/A	N/A	N/R	40 GPM

Body Size	A	B
1/2"	.75	.63

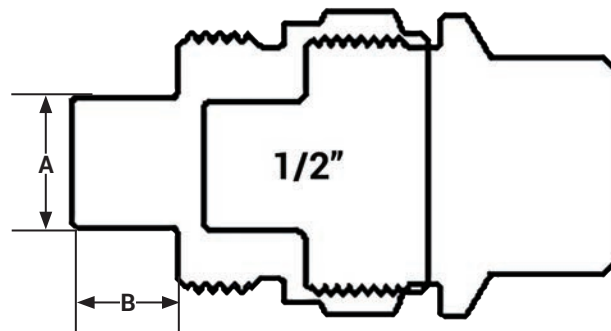

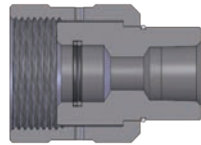

Body Size	TD-Series 15K Threaded Coupler (Female Threads)							
	Part Detail			Length		Maximum OD		Hex mm
	Part #	Threads	Material	inch	mm	inch	mm	
1/2"	4TDF4-SS	1/2" - 14 NPTF	316 stainless steel	2.57	65.28	1.85	46.99	1.13

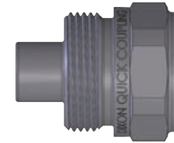
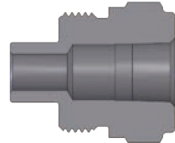

Body Size	TD-Series 15K Threaded Plug (Female Threads)							
	Part Detail			Length		Maximum OD		Hex mm
	Part #	Threads	Material	inch	mm	inch	mm	
1/2"	TD4F4-SS	1/2" - 14 NPTF	316 stainless steel	2.06	52.32	1.75	44.45	1.63

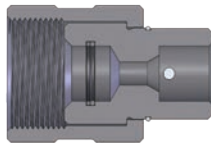

Body Size	TD-Series 20K Threaded Coupler (Female MP Threads)							
	Part Detail			Length		Maximum OD		Hex mm
	Part #	Threads	Material	inch	mm	inch	mm	
1/2"	4TDPF4.5-SS	9/16" MP	316 stainless steel	2.85	72.39	1.88	47.75	1.13

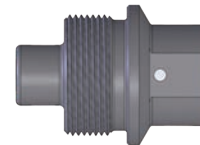
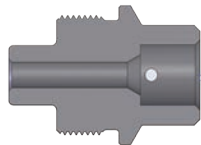

Body Size	TD-Series 20K Threaded Plug (Female MP Threads)							
	Part Detail			Length		Maximum OD		Hex mm
	Part #	Threads	Material	inch	mm	inch	mm	
1/2"	TD4PF4.5-SS	9/16" MP	316 stainless steel	2.40	60.96	1.74	44.20	1.13

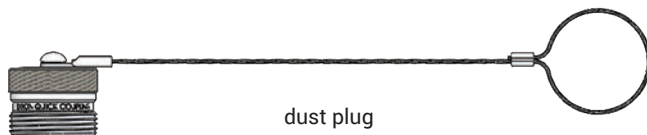

Body Size	TD-Series Dust Cap and Dust Plug							
	Part Detail				Length		Maximum OD	
	Part #	Description	Threads	Material	inch	mm	inch	mm
1/2"	TD4DC-A	dust cap	1/2" - 14 NPTF	aluminum	10	254	1.73	43.94
	TD4.5DC-A	dust cap	9/16" MP	aluminum	10	254	1.69	42.93
	4TDDP-A	dust plug	1/2" - 14 NPTF	aluminum	10	254	1.50	38.10
	4.5TDDP-A	dust plug	9/16" MP	aluminum	10	254	1.50	38.10

Hydraulic Couplings: E-Series

Interchange Data

- Straight-through pressure-wash interchange
- Parker ST-Series, Foster FST-Series, Hansen ST-Series

Seal Components

- Nitrile (Buna-N) seals are standard, providing a temperature range of -40°F to 250°F (-40°C to 121°C)

Materials

- Machined components are manufactured using solid steel, brass, or 303 stainless steel bar stock
- Stainless steel balls, retaining rings, and springs maximize corrosion resistance and extend service life
- Steel componentry is plated using ROHS-compliant trivalent chrome
- 1-1/4" to 2" brass couplers have steel sleeves as standard to maximize service life, hardened to resist deformation
- Steel plugs are hardened to provide heavy-duty performance

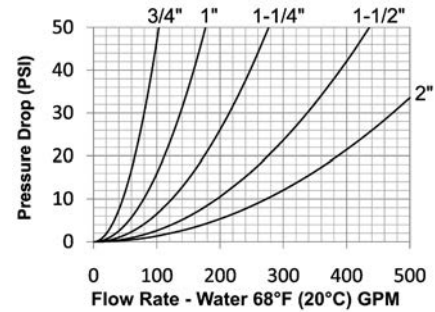
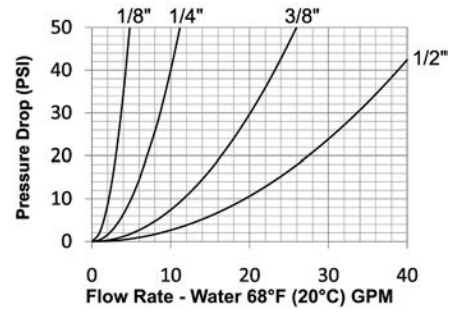

Rated Pressure Chart

Body Size	E-Series Straight-Through Interchange (Connected)											
	Brass Coupler/Steel Plug				Brass Coupler/Plug				303 Stainless Steel Coupler/Plug			
	Max. Working		Burst		Max. Working		Burst		Max. Working		Burst	
	PSI	Bar	PSI	Bar	PSI	Bar	PSI	Bar	PSI	Bar	PSI	Bar
1/8"	2,600	179	10,400	717	2,500	172	10,000	689	4,200	290	16,800	1,158
1/4"	5,500	379	22,000	1,517	5,200	359	20,800	1,434	6,700	462	26,800	1,848
3/8"	3,500	241	14,000	966	2,700	186	10,800	745	5,500	379	22,000	1,517
1/2"	2,700	186	10,800	745	2,200	152	8,800	607	3,000	207	12,000	827
3/4"	2,700	186	10,800	745	1,700	117	6,800	469	3,000	207	12,000	827
1"	2,000	138	8,000	552	1,200	83	4,800	331	1,700	117	6,800	469
1-1/4"	2,000	138	8,000	552	1,700	117	6,800	469	2,000	138	8,000	552
1-1/2"	2,000	138	8,000	552	1,400	97	5,600	386	2,000	138	8,000	552
2"	2,000	138	8,000	552	1,400	97	5,600	386	2,000	138	8,000	552

Technical Specifications

Body Size	Interchange Standards				Functional Parameters					
	U.S. Military	U.S. Government	International Standards	ANSI/NFPA Standards	Locking Ball Quantity	Air Inclusion	Fluid Loss	Vacuum inch HG	Flow ΔP = 15 PSI	
1/8"	-	-	-	-	6	N/A	N/A	N/R	3 GPM	
1/4"	-	-	-	-	6	N/A	N/A	N/R	6 GPM	
3/8"	-	-	-	-	8	N/A	N/A	N/R	14 GPM	
1/2"	-	-	-	-	8	N/A	N/A	N/R	24 GPM	
3/4"	-	-	-	-	8	N/A	N/A	N/R	58 GPM	
1"	-	-	-	-	8	N/A	N/A	N/R	100 GPM	
1-1/4"	-	-	-	-	8	N/A	N/A	N/R	150 GPM	
1-1/2"	-	-	-	-	8	N/A	N/A	N/R	250 GPM	
2"	-	-	-	-	8	N/A	N/A	N/R	350 GPM	

Available Options

Body Size	Standard Seal Options				Kalrez® Seal Options			Other Options	
	FKM	EPDM	Mil-Nitrile	Silicone	4079	6375	7075	Sleeve-Lock	Oxy-Clean
1/8"	F-	P-	M-	S-	N/A	N/A	N/A	-LS	-C1
1/4"	F-	P-	M-	S-	N/A	N/A	N/A	-LS	-C1
3/8"	F-	P-	M-	S-	N/A	N/A	N/A	-LS	-C1
1/2"	F-	P-	M-	S-	N/A	N/A	N/A	-LS	-C1
3/4"	F-	P-	M-	S-	N/A	N/A	N/A	-LS	-C1
1"	F-	P-	M-	S-	N/A	N/A	N/A	-LS	-C1
1-1/4"	F-	P-	M-	S-	N/A	N/A	N/A	-LS	-C1
1-1/2"	F-	P-	M-	S-	N/A	N/A	N/A	-LS	-C1
2"	F-	P-	M-	S-	N/A	N/A	N/A	-LS	-C1

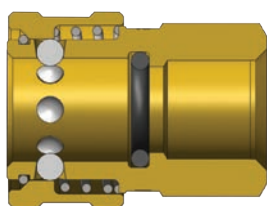

E-Series Straight-Through Interchange Coupler (Female Threads)

Body Size	E-Series Straight-Through Interchange Coupler (Female Threads)							
	Part Detail			Length		Maximum OD		Hex inch
	Part #	Threads	Material	inch	mm	inch	mm	
1/8"	1EF1-B	1/8" - 27 NPTF	brass	1.01	25.7	0.65	16.5	9-16"
	1EF1-S	1/8" - 27 NPTF	303 stainless	1.01	25.7	0.65	16.5	9/16"
1/4"	2EF2-B	1/4" - 18 NPTF	brass	1.40	35.6	0.96	24.4	13/16"
	2EF2-S	1/4" - 18 NPTF	303 stainless	1.40	35.6	0.96	24.4	13/16"
	2EBF2-B	1/4" - 19 BSPP	brass	1.40	35.6	0.96	24.4	13/16"
3/8"	3EF3-B	3/8" - 18 NPTF	brass	1.60	40.6	1.13	28.7	1"
	3EF3-S	3/8" - 18 NPTF	303 stainless	1.60	40.6	1.13	28.7	1"
	3EBF3-B	3/8" - 19 BSPP	brass	1.60	40.6	1.13	28.7	1"
1/2"	4EF4-B	1/2" - 14 NPTF	brass	1.96	49.8	1.27	32.3	1-1/8"
	4EF4-S	1/2" - 14 NPTF	303 stainless	1.96	49.8	1.27	32.3	1-1/8"
	4EBF4-B	1/2" - 14 BSPP	brass	1.96	49.8	1.27	32.3	1-1/8"
3/4"	6EF6-B	3/4" - 14 NPTF	brass	2.10	53.3	1.65	41.9	1-1/2"
	6EF6-S	3/4" - 14 NPTF	303 stainless	2.10	53.3	1.65	41.9	1-1/2"
	6EBF6-B	3/4" - 14 BSPP	brass	2.10	53.3	1.65	41.9	1-1/2"
1"	8EF8-B	1" - 11-1/2 NPTF	brass	2.36	59.9	2.02	51.3	1-3/4"
	8EF8-S	1" - 11-1/2 NPTF	303 stainless	2.36	59.9	2.02	51.3	1-3/4"
	8EBF8-B	1" - 11 BSPP	brass	2.36	59.9	2.02	51.3	1-3/4"
1-1/4"	10EF10-B	1-1/4" - 11-1/2 NPTF	brass	2.36	59.9	2.59	65.8	2-1/4"
	10EF10-S	1-1/4" - 11-1/2 NPTF	303 stainless	2.36	59.9	2.59	65.8	2-1/4"
1-1/2"	12EF12-B	1-1/2" - 11-1/2 NPTF	brass	2.89	73.4	3.18	80.8	2-3/4"
	12EF12-S	1-1/2" - 11-1/2 NPTF	303 stainless	2.89	73.4	3.18	80.8	2-3/4"
2"	16EF16-B	2" - 11-1/2 NPTF	brass	3.00	76.2	4.04	102.6	3-1/2"
	16EF16-S	2" - 11-1/2 NPTF	303 stainless	3.00	76.2	4.04	102.6	3-1/2"

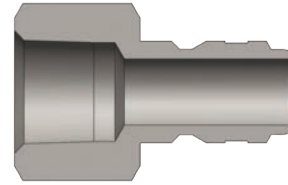
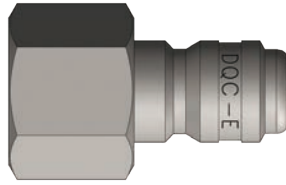

Body Size	E-Series Straight-Through Interchange Plug (Female Threads)							
	Part Detail			Length		Maximum OD		Hex inch
	Part #	Threads	Material	inch	mm	inch	mm	
1/8"	E1F1	1/8" - 27 NPTF	steel	0.98	24.9	0.65	16.5	9/16"
	E1F1-B	1/8" - 27 NPTF	brass	0.98	24.9	0.65	16.5	9/16"
	E1F1-S	1/8" - 27 NPTF	303 stainless	0.98	24.9	0.65	16.5	9/16"
1/4"	E2F2	1/4" - 18 NPTF	steel	1.47	37.3	0.79	20.1	11/16"
	E2F2-B	1/4" - 18 NPTF	brass	1.47	37.3	0.79	20.1	11/16"
	E2F2-S	1/4" - 18 NPTF	303 stainless	1.47	37.3	0.79	20.1	11/16"
	E2BF2-B	1/4" - 19 BSPP	brass	1.47	37.3	0.79	20.1	11/16"
3/8"	E3F3	3/8" - 18 NPTF	steel	1.60	40.6	1.01	25.7	7/8"
	E3F3-B	3/8" - 18 NPTF	brass	1.60	40.6	1.01	25.7	7/8"
	E3F3-S	3/8" - 18 NPTF	303 stainless	1.60	40.6	1.01	25.7	7/8"
	E3BF3-B	3/8" - 19 BSPP	brass	1.60	40.6	1.01	25.7	7/8"
1/2"	E4F4	1/2" - 14 NPTF	steel	1.82	46.2	1.16	29.5	1"
	E4F4-B	1/2" - 14 NPTF	brass	1.82	46.2	1.16	29.5	1"
	E4F4-S	1/2" - 14 NPTF	303 stainless	1.82	46.2	1.16	29.5	1"
	E4BF4-B	1/2" - 14 BSPP	brass	1.82	46.2	1.16	29.5	1"
3/4"	E6F6	3/4" - 14 NPTF	steel	2.05	52.1	1.37	34.8	1-3/16"
	E6F6-B	3/4" - 14 NPTF	brass	2.05	52.1	1.37	34.8	1-3/16"
	E6F6-S	3/4" - 14 NPTF	303 stainless	2.05	52.1	1.37	34.8	1-3/16"
	E6BF6-B	3/4" - 14 BSPP	brass	2.05	52.1	1.37	34.8	1-3/16"
1"	E8F8	1" - 11-1/2 NPTF	steel	2.36	59.9	1.73	43.9	1-1/2"
	E8F8-B	1" - 11-1/2 NPTF	brass	2.36	59.9	1.73	43.9	1-1/2"
	E8F8-S	1" - 11-1/2 NPTF	303 stainless	2.36	59.9	1.73	43.9	1-1/2"
	E8BF8-B	1" - 11 BSPP	brass	2.36	59.9	1.73	43.9	1-1/2"
1-1/4"	E10F10	1-1/4" - 11-1/2 NPTF	steel	2.47	62.7	2.31	58.7	2"
	E10F10-B	1-1/4" - 11-1/2 NPTF	brass	2.47	62.7	2.31	58.7	2"
	E10F10-S	1-1/4" - 11-1/2 NPTF	303 stainless	2.47	62.7	2.31	58.7	2"
1-1/2"	E12F12	1-1/2" - 11-1/2 NPTF	steel	2.74	69.6	2.60	66.0	2-1/4"
	E12F12-B	1-1/2" - 11-1/2 NPTF	brass	2.74	69.6	2.60	66.0	2-1/4"
	E12F12-S	1-1/2" - 11-1/2 NPTF	303 stainless	2.74	69.6	2.60	66.0	2-1/4"
2"	E16F16	2" - 11-1/2 NPTF	steel	3.00	76.2	3.03	77.0	2-5/8"
	E16F16-B	2" - 11-1/2 NPTF	brass	3.00	76.2	3.03	77.0	2-5/8"
	E16F16-S	2" - 11-1/2 NPTF	303 stainless	3.00	76.2	3.03	77.0	2-5/8"

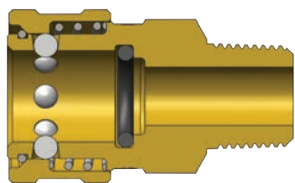

Body Size	E-Series Straight-Through Interchange Coupler (Male Threads)							
	Part Detail			Length		Maximum OD		Hex inch
	Part #	Threads	Material	inch	mm	inch	mm	
1/8"	1EM1-B	1/8" - 27 NPTF	brass	1.01	25.7	0.65	16.5	9/16"
	1EM1-S	1/8" - 27 NPTF	303 stainless	1.01	25.7	0.65	16.5	9/16"
1/4"	2EM2-B	1/4" - 18 NPTF	brass	1.66	42.2	0.96	24.4	13/16"
	2EM2-S	1/4" - 18 NPTF	303 stainless	1.66	42.2	0.96	24.4	13/16"
3/8"	3EM3-B	3/8" - 18 NPTF	brass	1.70	43.2	1.13	28.7	1"
	3EM3-S	3/8" - 18 NPTF	303 stainless	1.70	43.2	1.13	28.7	1"
1/2"	4EM4-B	1/2" - 14 NPTF	brass	2.00	50.8	1.27	32.3	1-1/8"
	4EM4-S	1/2" - 14 NPTF	303 stainless	2.00	50.8	1.27	32.3	1-1/8"
3/4"	6EM6-B	3/4" - 14 NPTF	brass	2.24	56.9	1.65	41.9	1-1/2"
	6EM6-S	3/4" - 14 NPTF	303 stainless	2.24	56.9	1.65	41.9	1-1/2"
1"	8EM8-B	1" - 11-1/2 NPTF	brass	2.61	66.3	2.02	51.3	1-3/4"
	8EM8-S	1" - 11-1/2 NPTF	303 stainless	2.61	66.3	2.02	51.3	1-3/4"
1-1/4"	10EM10-B	1-1/4" - 11-1/2 NPTF	brass	2.91	73.9	2.59	65.8	2-1/4"
1-1/2"	12EM12-B	1-1/2" - 11-1/2 NPTF	brass	3.44	87.4	3.18	80.8	2-3/4"
2"	16EM16-B	2" - 11-1/2 NPTF	brass	3.70	94.0	4.04	102.6	3-1/2"

E-Series Profiles

Body Size	A	B
1/8"	0.26	0.08
1/4"	0.40	0.11
3/8"	0.49	0.13
1/2"	0.64	0.13
3/4"	0.89	0.17
1"	1.20	0.17
1-1/4"	1.45	0.12
1-1/2"	1.79	0.17
2"	2.27	0.17

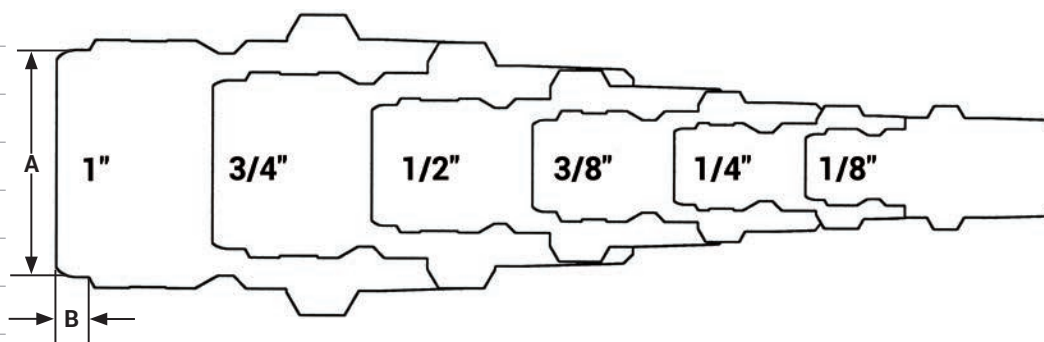

Hydraulic Couplings: E-Series

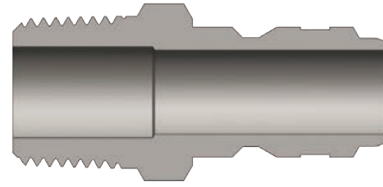
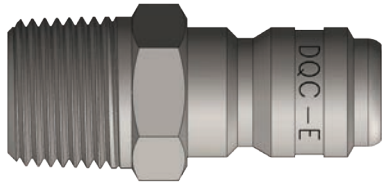

Body Size	E-Series Straight-Through Interchange Plug (Male Threads)							
	Part Detail			Length		Maximum OD		Hex inch
	Part #	Threads	Material	inch	mm	inch	mm	
1/8"	E1M1	1/8" - 27 NPTF	steel	1.15	29.2	0.58	14.7	1/2"
	E1M1-B	1/8" - 27 NPTF	brass	1.15	29.2	0.58	14.7	1/2"
	E1M1-S	1/8" - 27 NPTF	303 stainless	1.15	29.2	0.58	14.7	1/2"
1/4"	E2M2	1/4" - 18 NPTF	steel	1.50	38.1	0.65	16.5	9/16"
	E2M2-B	1/4" - 18 NPTF	brass	1.50	38.1	0.65	16.5	9/16"
	E2M2-S	1/4" - 18 NPTF	303 stainless	1.50	38.1	0.65	16.5	9/16"
3/8"	E3M3	3/8" - 18 NPTF	steel	1.69	42.9	0.79	20.1	11/16"
	E3M3-B	3/8" - 18 NPTF	brass	1.69	42.9	0.79	20.1	11/16"
	E3M3-S	3/8" - 18 NPTF	303 stainless	1.69	42.9	0.79	20.1	11/16"
1/2"	E4M4	1/2" - 14 NPTF	steel	1.91	48.5	1.01	25.7	7/8"
	E4M4-B	1/2" - 14 NPTF	brass	1.91	48.5	1.01	25.7	7/8"
	E4M4-S	1/2" - 14 NPTF	303 stainless	1.91	48.5	1.01	25.7	7/8"
3/4"	E6M6	3/4" - 14 NPTF	steel	2.25	57.2	1.23	31.2	1-1/16"
	E6M6-B	3/4" - 14 NPTF	brass	2.25	57.2	1.23	31.2	1-1/16"
	E6M6-S	3/4" - 14 NPTF	303 stainless	2.25	57.2	1.23	31.2	1-1/16"
1"	E8M8	1" - 11-1/2 NPTF	steel	2.45	62.2	1.59	40.4	1-3/8"
	E8M8-B	1" - 11-1/2 NPTF	brass	2.45	62.2	1.59	40.4	1-3/8"
	E8M8-S	1" - 11-1/2 NPTF	303 stainless	2.45	62.2	1.59	40.4	1-3/8"
1-1/4"	E10M10	1-1/4" - 11-1/2 NPTF	steel	2.80	71.1	2.02	51.3	1-3/4"
	E10M10-B	1-1/4" - 11-1/2 NPTF	brass	2.80	71.1	2.02	51.3	1-3/4"
1-1/2"	E12M12	1-1/2" - 11-1/2 NPTF	steel	3.38	85.9	2.60	66.0	2-1/4"
	E12M12-B	1-1/2" - 11-1/2 NPTF	brass	3.38	85.9	2.60	66.0	2-1/4"
2"	E16M16	2" - 11-1/2 NPTF	steel	3.58	90.9	3.03	77.0	2-5/8"
	E16M16-B	2" - 11-1/2 NPTF	brass	3.58	90.9	3.03	77.0	2-5/8"

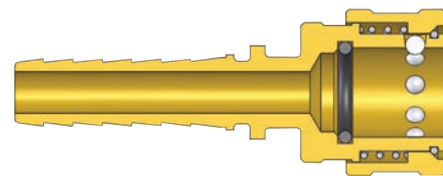
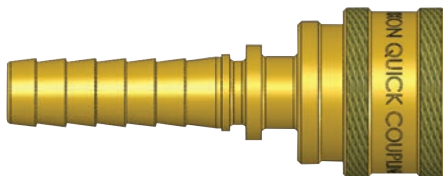

Body Size	E-Series Straight-Through Interchange Coupler (Hose Barb)							
	Part Detail			Length		Maximum OD		Hex inch
	Part #	Hose ID	Material	inch	mm	inch	mm	
1/4"	2ES2-B	1/4"	brass	2.06	52.2	1.00	25.4	-
3/8"	3ES3-B	3/8"	brass	2.03	51.6	1.13	28.6	-
1/2"	4ES4-B	1/2"	brass	3.45	87.6	1.34	34.0	-
3/4"	6ES6-B	3/4"	brass	3.64	92.3	1.64	41.7	-
1"	8ES8-B	1"	brass	4.58	116.2	1.99	50.5	-

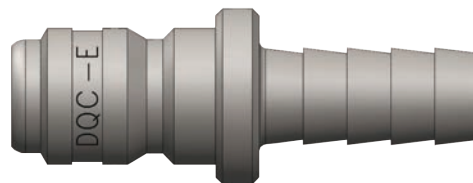
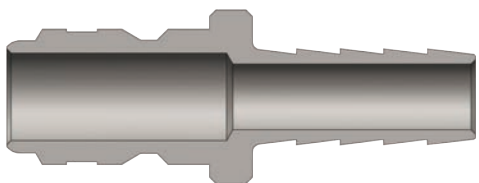

Body Size	E-Series Straight-Through Interchange Plug (Hose Barb)							
	Part Detail			Length		Maximum OD		Hex inch
	Part #	Hose ID	Material	inch	mm	inch	mm	
1/4"	E2S2	1/4"	steel	1.90	48.3	0.56	14.2	-
	E2S2-B	1/4"	brass	1.90	48.3	0.56	14.2	-
3/8"	E3S3	3/8"	steel	2.03	51.6	0.63	16.0	-
	E3S3-B	3/8"	brass	2.03	51.6	0.63	16.0	-
1/2"	E4S4	1/2"	steel	2.09	53.1	0.75	19.1	-
	E4S4-B	1/2"	brass	2.09	53.1	0.75	19.1	-
3/4"	E6S6	3/4"	steel	2.28	57.9	1.13	28.7	-
	E6S6-B	3/4"	brass	2.28	57.9	1.13	28.7	-
1"	E8S8	1"	steel	3.28	83.3	1.38	35.1	-
	E8S8-B	1"	brass	3.28	83.3	1.38	35.1	-

Body Size	E-Series Straight-Through Interchange Coupler Seal Kits			
	Part Detail			Seal Kit Contents
	Part #	Coupler Style	Seal Material	
1/4"	2E-SKIT	all	Nitrile	body O-ring
	F-2E-SKIT	all	FKM	body O-ring
	P-2E-SKIT	all	EPDM	body O-ring
3/8"	3E-SKIT	all	Nitrile	body O-ring
	F-3E-SKIT	all	FKM	body O-ring
	P-3E-SKIT	all	EPDM	body O-ring
1/2"	4E-SKIT	all	Nitrile	body O-ring
	F-4E-SKIT	all	FKM	body O-ring
	P-4E-SKIT	all	EPDM	body O-ring
3/4"	6E-SKIT	all	Nitrile	body O-ring
	F-6E-SKIT	all	FKM	body O-ring
	P-6E-SKIT	all	EPDM	body O-ring
1"	8E-SKIT	all	Nitrile	body O-ring
	F-8E-SKIT	all	FKM	body O-ring
	P-8E-SKIT	all	EPDM	body O-ring
1-1/4"	10E-SKIT	all	Nitrile	body O-ring
	F-10E-SKIT	all	FKM	body O-ring
	P-10E-SKIT	all	EPDM	body O-ring
1-1/2"	12E-SKIT	all	Nitrile	body O-ring
	F-12E-SKIT	all	FKM	body O-ring
	P-12E-SKIT	all	EPDM	body O-ring
2"	16E-SKIT	all	Nitrile	body O-ring
	F-16E-SKIT	all	FKM	body O-ring
	P-16E-SKIT	all	EPDM	body O-ring

Hydraulic Couplings: EA-Series

Interchange Data

- Water-blast interchange
- Parker Series-WB and Eaton/Aeroquip FD69

Seal Components

- Nitrile (Buna-N) seals are standard, providing a temperature range of **-40°F to 250°F (-40°C to 121°C)**
- Couplers have a PTFE anti-extrusion ring, providing resistance to O-ring dynamic impulse pressure damage

Materials

- Machined components are manufactured using solid high strength steel bar stock
- Stainless steel springs and retaining rings maximize corrosion resistance and extend service life
- Latches are manufactured from high-strength steel and plated with electroless nickel
- Steel plugs are machined from solid high strength steel bar stock and hardened
- Machined steel componentry is plated using ROHS-compliant trivalent chrome

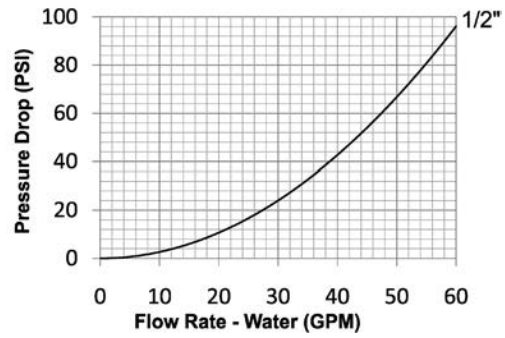

Rated Pressure Chart

Body Size	EA-Series Water-Blast Interchange (Connected)			
	Coupler/Plug			
	Maximum Working		Burst	
	PSI	Bar	PSI	Bar
1/2"	10,000	700	30,000	2,100

Technical Specifications

Body Size	Interchange Standards				Functional Parameters				
	U.S. Military	U.S. Government	International Standards	ANSI/NFPA Standards	Locking Mechanism	Air Inclusion	Fluid Loss	Vacuum inch HG	Flow ΔP = 40 PSI
1/2"	-	-	-	-	Maxi-Latch	N/A	N/A	N/R	40 GPM

Available Options

Body Size	Standard Seal Options					Kalrez® Seal Options			Other Options	
	FKM	EPDM	FDA FKM	Mil-Nitrile	Silicone	4079	6375	7075	No Pin-Lock	Oxy-Clean
	Pre	Pre	Pre	Pre	Pre	Pre	Pre	Pre	Suf	Suf
1/2"	F-	P-	D-	M-	S-	K4-	K6-	K7-	-NL	-C1

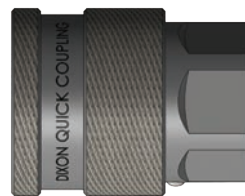
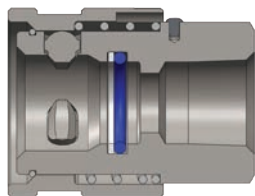

Body Size	EA-Series Water-Blast Interchange Coupler (Female Threads)							
	Part Detail			Length		Maximum OD		Hex inch
	Part #	Threads	Material	inch	mm	inch	mm	
1/2"	4EAF3	3/8" - 18 NPTF	steel	2.20	55.9	1.62	41.1	1-1/4"
	4EAF4	1/2" - 14 NPTF	steel	2.20	55.9	1.62	41.1	1-1/4"

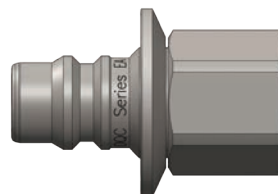
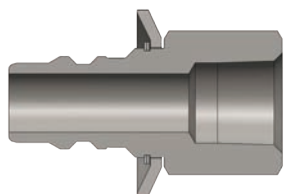

Body Size	EA-Series Water-Blast Interchange Plug (Female Threads)							
	Part Detail			Length		Maximum OD		Hex inch
	Part #	Threads	Material	inch	mm	inch	mm	
1/2"	EA4F3	3/8" - 18 NPTF	steel	2.35	59.7	1.62	41.1	1-1/8"
	EA4F4	1/2" - 14 NPTF	steel	2.35	59.7	1.62	41.1	1-1/8"

Body Size	EA-Series Water-Blast Interchange Coupler Seal Kits			
	Part Detail			Seal Kit
	Part #	Coupler Style	Seal Material	Contents
1/2"	4EA-SKIT	all	Nitrile	body O-ring and PTFE back-up
	F-4EA-SKIT	all	FKM	body O-ring and PTFE back-up
	P-4EA-SKIT	all	EPDM	body O-ring and PTFE back-up

EA-Series Profile

Body Size	A	B
1/2"	0.69	0.35

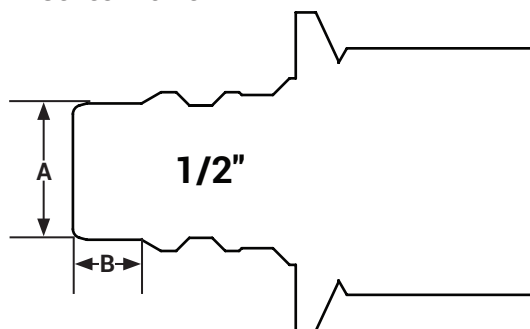

Hydraulic Couplings: CM-Series

Interchange Data

- Mold coolant interchange
- Foster Series-FJT, Hansen Flo-Temp, Parker Moldmate, DME Jiffy-Tite

Seal Components

- Silicon gaskets and valve O-rings are standard, providing a temperature range of -90°F to 400°F (-68°C to 205°C)

Materials

- Machined components are manufactured using solid steel or brass bar stock
- Stainless steel balls, retaining rings, and springs maximize corrosion resistance and extend service life
- Steel componentry is plated using ROHS-compliant trivalent chrome

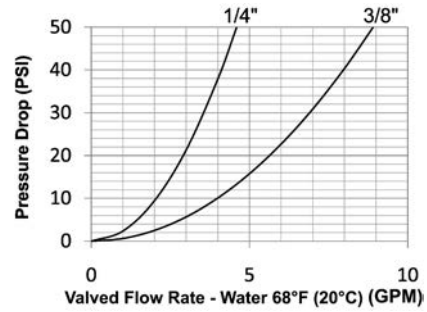
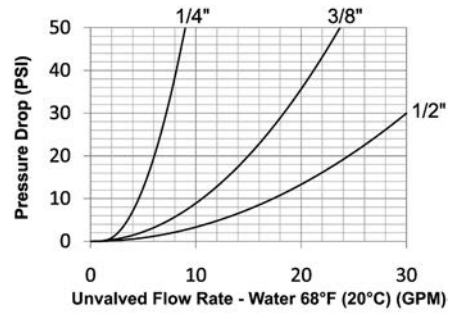

Rated Pressure Chart

Body Size	CM-Series Industrial Mold Interchange (Connected)															
	Unvalved Coupler/Brass Plug				Unvalved Coupler/Steel Plug				Valved Coupler/Brass Plug				Valved Coupler/Steel Plug			
	Max. Working		Burst		Max. Working		Burst		Max. Working		Burst		Max. Working		Burst	
	PSI	Bar	PSI	Bar	PSI	Bar	PSI	Bar	PSI	Bar	PSI	Bar	PSI	Bar	PSI	Bar
1/4"	300	20	10,000	700	500	35	10,700	750	300	20	6,000	400	300	20	6,100	400
3/8"	300	20	14,500	1,000	500	35	14,200	1,000	300	20	6,700	450	300	20	6,100	400
1/2"	300	20	4,900	340	-	-	-	-	-	-	-	-	-	-	-	-

Technical Specifications

Body Size	Interchange Standards				Functional Parameters					
	U.S. Military	U.S. Government	International Standards	ANSI/NFPA Standards	Locking Ball Quantity	Air Inclusion	Fluid Loss	Vacuum inch HG	Flow ΔP = 7 PSI	
1/4"	-	-	-	-	6	N/A	N/A	N/R	3 GPM	
3/8"	-	-	-	-	8	N/A	N/A	N/R	9 GPM	
1/2"	-	-	-	-	8	N/A	N/A	N/R	15 GPM	

CM-Series Profiles

Body Size	A	B
1/4"	0.37	0.32
3/8"	0.53	0.49
1/2"	0.78	0.65

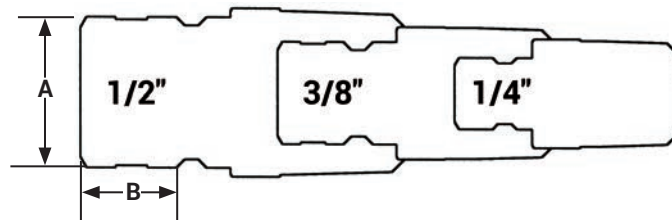

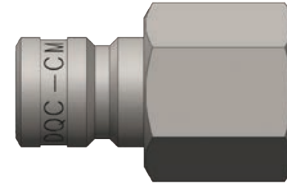
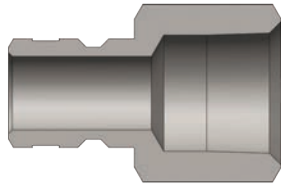

Body Size	CM-Series Industrial Mold Interchange Plug (Female Threads)							
	Part Detail			Length		Maximum OD		Hex inch
	Part #	Threads	Material	inch	mm	inch	mm	
1/4"	CM2F1	1/8" - 27 NPTF	steel	0.90	22.9	0.58	14.7	1/2"
	CM2F1-B	1/8" - 27 NPTF	brass	0.90	22.9	0.58	14.7	1/2"
	CM2F2	1/4" - 18 NPTF	steel	1.12	28.4	0.72	18.3	5/8"
	CM2F2-B	1/4" - 18 NPTF	brass	1.12	28.4	0.72	18.3	5/8"
	CM2F3	3/8" - 18 NPTF	steel	1.12	28.4	0.87	22.1	3/4"
	CM2F3-B	3/8" - 18 NPTF	brass	1.12	28.4	0.87	22.1	3/4"
3/8"	CM3F2	1/4" - 18 NPTF	steel	1.34	34.0	0.72	18.3	5/8"
	CM3F2-B	1/4" - 18 NPTF	brass	1.34	34.0	0.72	18.3	5/8"
	CM3F3	3/8" - 18 NPTF	steel	1.34	34.0	0.87	22.1	3/4"
	CM3F3-B	3/8" - 18 NPTF	brass	1.34	34.0	0.87	22.1	3/4"
1/2"	CM4F4-B	1/2" - 14 NPTF	brass	1.69	42.9	1.16	29.5	1"
	CM4F6-B	3/4" - 14 NPTF	brass	1.69	42.9	1.37	34.8	1-3/16"

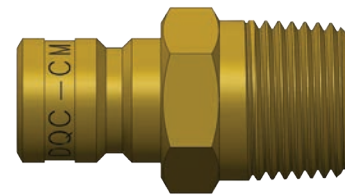
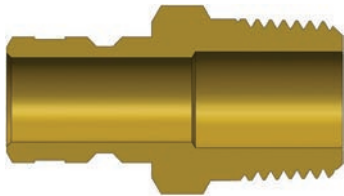

Body Size	CM-Series Industrial Mold Interchange Plug (Male Threads)							
	Part Detail			Length		Maximum OD		Hex inch
	Part #	Threads	Material	inch	mm	inch	mm	
1/4"	CM2M1-B	1/8" - 27 NPTF	brass	1.00	25.4	0.65	16.5	9/16"
	CM2M2-B	1/4" - 18 NPTF	brass	1.26	32.0	0.65	16.5	9/16"
	CM2M3-B	3/8" - 18 NPTF	brass	1.20	30.5	0.79	20.1	11/16"
3/8"	CM3M2-B	1/4" - 18 NPTF	brass	1.37	34.8	0.65	16.5	9/16"
	CM3M3-B	3/8" - 18 NPTF	brass	1.43	36.3	0.79	20.1	11/16"
	CM3M4-B	1/2" - 14 NPTF	brass	1.58	40.1	1.01	25.7	7/8"
1/2"	CM4M4-B	1/2" - 14 NPTF	brass	1.69	42.9	1.01	25.7	7/8"
	CM4M6-B	3/4" - 14 NPTF	brass	1.79	45.5	1.23	31.2	1-1/16"

Hydraulic Couplings: CM-Series



Body Size	CM-Series Industrial Mold Interchange Extension Plug (Male Threads)							
	Part Detail			Length		Maximum OD		Hex inch
	Part #	Threads	Material	inch	mm	inch	mm	
1/4"	CM2M1-B-L2.5	1/8" - 27 NPTF	brass	2.50	63.5	0.51	13.0	7/16"
	CM2M1-B-L4	1/8" - 27 NPTF	brass	4.00	101.6	0.51	13.0	7/16"
	CM2M1-B-L5.5	1/8" - 27 NPTF	brass	5.50	139.7	0.51	13.0	7/16"
	CM2M2-B-L2.5	1/4" - 18 NPTF	brass	2.50	63.5	0.65	16.5	9/16"
	CM2M2-B-L4	1/4" - 18 NPTF	brass	4.00	101.6	0.65	16.5	9/16"
	CM2M2-B-L5.5	1/4" - 18 NPTF	brass	5.50	139.7	0.65	16.5	9/16"
	CM2M2-B-L7	1/4" - 18 NPTF	brass	7.00	177.8	0.65	16.5	9/16"
3/8"	CM3M1-B-L2.5	1/8" - 27 NPTF	brass	2.50	63.5	0.65	16.5	9/16"
	CM3M1-B-L4	1/8" - 27 NPTF	brass	4.00	101.6	0.65	16.5	9/16"
	CM3M1-B-L5.5	1/8" - 27 NPTF	brass	5.50	139.7	0.65	16.5	9/16"
	CM3M1-B-L7	1/8" - 27 NPTF	brass	7.00	177.8	0.65	16.5	9/16"
	CM3M2-B-L2.5	1/4" - 18 NPTF	brass	2.50	63.5	0.65	16.5	9/16"
	CM3M2-B-L4	1/4" - 18 NPTF	brass	4.00	101.6	0.65	16.5	9/16"
	CM3M2-B-L5.5	1/4" - 18 NPTF	brass	5.50	139.7	0.65	16.5	9/16"
	CM3M2-B-L7	1/4" - 18 NPTF	brass	7.00	177.8	0.65	16.5	9/16"
	CM3M2-B-L8.5	1/4" - 18 NPTF	brass	8.50	215.9	0.65	16.5	9/16"
	CM3M2-B-L11.5	1/4" - 18 NPTF	brass	11.50	292.1	0.65	16.5	9/16"

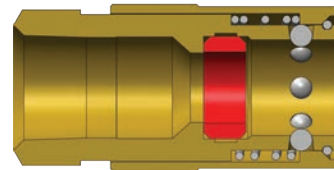

Body Size	CM-Series Industrial Mold Interchange Unvalved Coupler (Female Threads)							
	Part Detail			Length		Maximum OD		Hex inch
	Part #	Threads	Material	inch	mm	inch	mm	
1/4"	2CMF1-B-E	1/8" - 27 NPTF	brass	1.35	34.3	0.69	17.5	9/16"
	2CMF2-B-E	1/4" - 18 NPTF	brass	1.35	34.3	0.79	20.1	11/16"
3/8"	3CMF2-B-E	1/4" - 18 NPTF	brass	1.84	46.7	0.95	24.1	3/4"
	3CMF3-B-E	3/8" - 18 NPTF	brass	1.84	46.7	1.01	25.7	7/8"
1/2"	4CMF4-B-E	1/2" - 14 NPTF	brass	2.02	51.3	1.24	31.5	1-1/8"

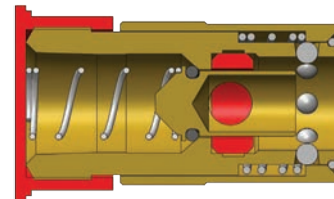
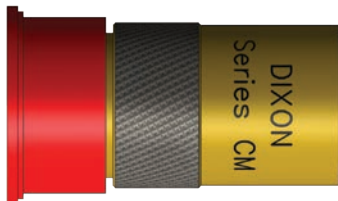

Body Size	CM-Series Industrial Mold Interchange Valved Coupler (Female Threads)							
	Part Detail			Length		Maximum OD		Hex inch
	Part #	Threads	Material	inch	mm	inch	mm	
1/4"	2CMF1-B	1/8" - 27 NPTF	brass	1.35	34.3	0.69	17.5	9/16"
3/8"	3CMF2-B	1/4" - 18 NPTF	brass	1.84	46.7	0.95	24.1	3/4"

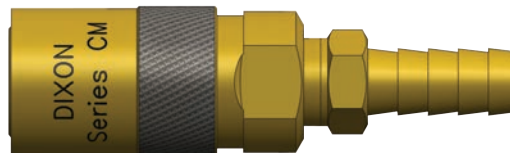
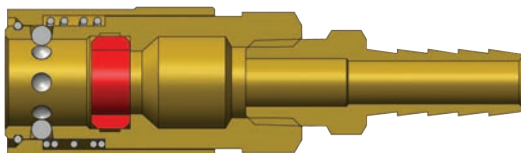

Body Size	CM-Series Industrial Mold Interchange Unvalved Coupler (Hose Barb)							
	Part Detail			Length		Maximum OD		Hex inch
	Part #	Hose ID	Material	inch	mm	inch	mm	
1/4"	2CMS2-B-E	1/4"	brass	2.11	53.6	0.69	17.5	-
	2CMS2.5-B-E	5/16"	brass	2.10	53.3	0.69	17.5	-
	2CMS3-B-E	3/8"	brass	2.10	53.3	0.69	17.5	-
3/8"	3CMS3-B-E	3/8"	brass	2.55	64.8	0.95	24.1	-
	3CMS4-B-E	1/2"	brass	2.55	64.8	0.95	24.1	-
1/2"	4CMS4-B-E	1/2"	brass	2.98	75.7	1.18	30.0	-
	4CMS6-B-E	3/4"	brass	2.98	75.7	1.18	30.0	-

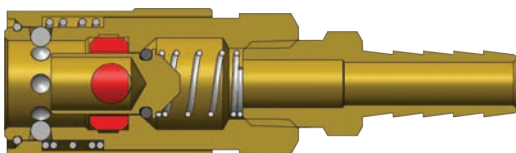

Body Size	CM-Series Industrial Mold Interchange Valved Coupler (Hose Barb)							
	Part Detail			Length		Maximum OD		Hex inch
	Part #	Hose ID	Material	inch	mm	inch	mm	
1/4"	2CMS2-B	1/4"	brass	2.66	67.6	0.69	17.5	-
	2CMS2.5-B	5/16"	brass	2.66	67.6	0.69	17.5	-
	2CMS3-B	3/8"	brass	2.66	67.6	0.69	17.5	-
3/8"	3CMS3-B	3/8"	brass	3.30	83.8	0.95	24.1	-
	3CMS4-B	1/2"	brass	3.28	83.3	0.95	24.1	-

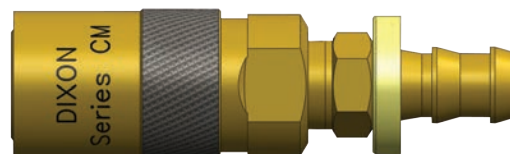
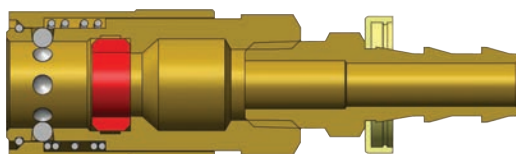

Body Size	CM-Series Industrial Mold Interchange Unvalved Coupler (Push-Loc Barb)							
	Part Detail			Length		Maximum OD		Hex inch
	Part #	Hose ID	Material	inch	mm	inch	mm	
1/4"	2CMB2-B-E	1/4"	brass	2.08	52.8	0.69	17.5	-
	2CMB3-B-E	3/8"	brass	2.08	52.8	0.69	17.5	-
3/8"	3CMB3-B-E	3/8"	brass	2.53	64.3	0.95	24.1	-
	3CMB4-B-E	1/2"	brass	2.69	68.3	0.95	24.1	-
1/2"	4CMB4-B-E	1/2"	brass	3.12	79.2	1.18	30.0	-
	4CMB6-B-E	3/4"	brass	3.12	79.2	1.18	30.0	-

Hydraulic Couplings: CM-Series

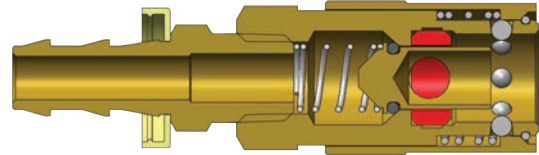
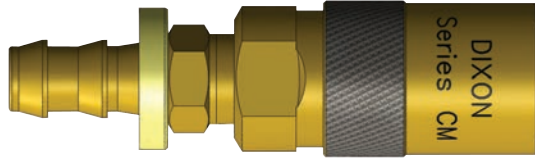

CM-Series Industrial Mold Interchange Valved Coupler (Push-Loc Barb)

Body Size	Part Detail			Length		Maximum OD		Hex inch
	Part #	Hose ID	Material	inch	mm	inch	mm	
	1/4"	2CMB2-B	1/4"	brass	2.64	67.1	0.69	
	2CMB3-B	3/8"	brass	2.67	67.8	0.69	17.5	-
3/8"	3CMB3-B	3/8"	brass	3.28	83.3	0.95	24.1	-
	3CMB4-B	1/2"	brass	3.44	87.4	0.95	24.1	-

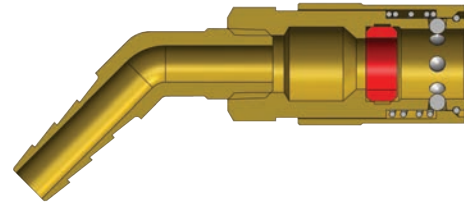
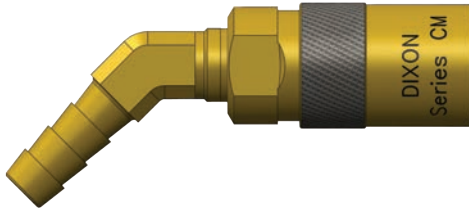

CM-Series Industrial Mold Interchange Unvalved Coupler (45° Hose Barb)

Body Size	Part Detail			Length		Maximum OD		Hex inch
	Part #	Hose ID	Material	inch	mm	inch	mm	
	1/4"	2CM4S2-B-E	1/4"	brass	2.87	72.9	0.69	
	2CM4S2.5-B-E	5/16"	brass	2.89	73.4	0.69	17.5	-
	2CM4S3-B-E	3/8"	brass	2.91	73.9	0.69	17.5	-
3/8"	3CM4S3-B-E	3/8"	brass	3.83	97.3	0.95	24.1	-
	3CM4S4-B-E	1/2"	brass	3.86	98.0	0.95	24.1	-
1/2"	4CM4S4-B-E	1/2"	brass	4.18	106.2	1.18	30.0	-
	4CM4S6-B-E	3/4"	brass	4.56	115.8	1.18	30.0	-

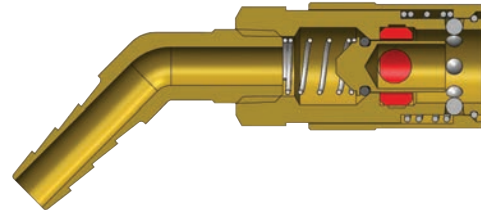
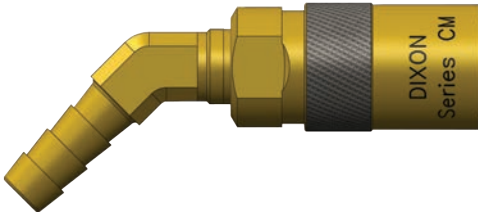

CM-Series Industrial Mold Interchange Valved Coupler (45° Hose Barb)

Body Size	Part Detail			Length		Maximum OD		Hex inch
	Part #	Hose ID	Material	inch	mm	inch	mm	
	1/4"	2CM4S2-B	1/4"	brass	2.87	72.9	0.69	
	2CM4S2.5-B	5/16"	brass	2.89	73.4	0.69	17.5	-
	2CM4S3-B	3/8"	brass	2.91	73.9	0.69	17.5	-
3/8"	3CM4S3-B	3/8"	brass	3.83	97.3	0.95	24.1	-
	3CM4S4-B	1/2"	brass	3.86	98.0	0.95	24.1	-

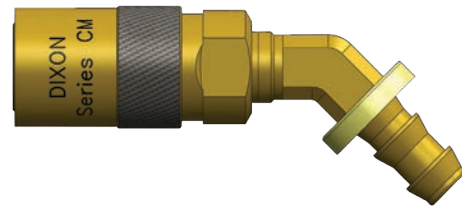
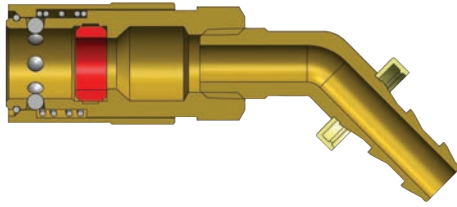

Body Size	CM-Series Industrial Mold Interchange Unvalved Coupler (45° Push-Loc Barb)							
	Part Detail			Length		Maximum OD		Hex inch
	Part #	Hose ID	Material	inch	mm	inch	mm	
1/4"	2CM4B2-B-E	1/4"	brass	2.86	72.6	0.69	17.5	-
	2CM4B3-B-E	3/8"	brass	2.92	74.2	0.69	17.5	-
3/8"	3CM4B3-B-E	3/8"	brass	3.82	97.0	0.95	24.1	-
	3CM4B4-B-E	1/2"	brass	3.98	101.1	0.95	24.1	-
1/2"	4CM4B4-B-E	1/2"	brass	4.28	108.7	1.18	30.0	-
	4CM4B6-B-E	3/4"	brass	4.56	115.8	1.18	30.0	-

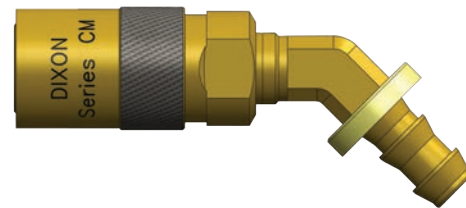
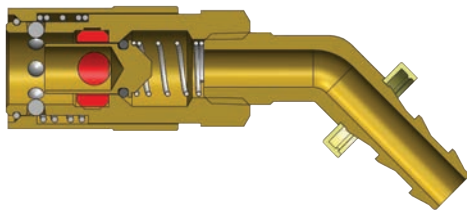

Body Size	CM-Series Industrial Mold Interchange Valved Coupler (45° Push-Loc Barb)							
	Part Detail			Length		Maximum OD		Hex inch
	Part #	Hose ID	Material	inch	mm	inch	mm	
1/4"	2CM4B2-B	1/4"	brass	2.86	72.6	0.69	17.5	-
	2CM4B3-B	3/8"	brass	2.92	74.2	0.69	17.5	-
3/8"	3CM4B3-B	3/8"	brass	3.82	97.0	0.95	24.1	-
	3CM4B4-B	1/2"	brass	3.98	101.1	0.95	24.1	-

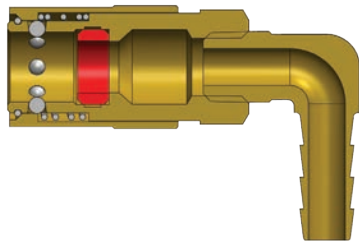

Body Size	CM-Series Industrial Mold Interchange Unvalved Coupler (90° Hose Barb)							
	Part Detail			Length		Maximum OD		Hex inch
	Part #	Hose ID	Material	inch	mm	inch	mm	
1/4"	2CM9S2-B-E	1/4"	brass	1.98	50.3	0.69	17.5	-
	2CM9S2.5-B-E	5/16"	brass	1.98	50.3	0.69	17.5	-
	2CM9S3-B-E	3/8"	brass	2.17	55.1	0.69	17.5	-
3/8"	3CM9S3-B-E	3/8"	brass	2.84	72.1	0.95	24.1	-
	3CM9S4-B-E	1/2"	brass	2.85	72.4	0.95	24.1	-
1/2"	4CM9S4-B-E	1/2"	brass	3.50	88.9	1.18	30.0	-
	4CM9S6-B-E	3/4"	brass	3.50	88.9	1.18	30.0	-

Hydraulic Couplings: CM-Series

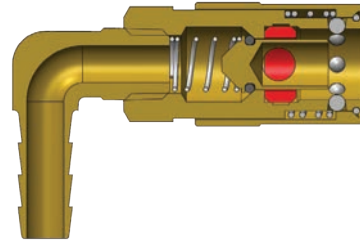

Body Size	CM-Series Industrial Mold Interchange Valved Coupler (90° Hose Barb)							
	Part Detail			Length		Maximum OD		Hex inch
	Part #	Hose ID	Material	inch	mm	inch	mm	
1/4"	2CM9S2-B	1/4"	brass	1.98	50.3	0.69	17.5	-
	2CM9S2.5-B	5/16"	brass	1.98	50.3	0.69	17.5	-
	2CM9S3-B	3/8"	brass	2.17	55.1	0.69	17.5	-
3/8"	3CM9S3-B	3/8"	brass	2.84	72.1	0.95	24.1	-
	3CM9S4-B	1/2"	brass	2.85	72.4	0.95	24.1	-

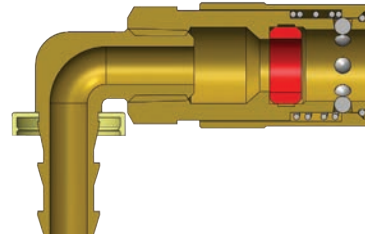
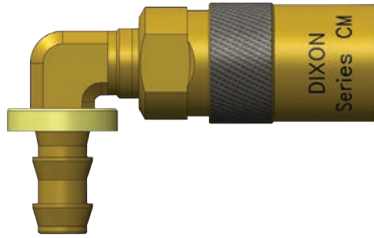

Body Size	CM-Series Industrial Mold Interchange Unvalved Coupler (90° Push-Loc Barb)							
	Part Detail			Length		Maximum OD		Hex inch
	Part #	Hose ID	Material	inch	mm	inch	mm	
1/4"	2CM9B2-B-E	1/4"	brass	2.07	52.6	0.69	17.5	-
	2CM9B3-B-E	3/8"	brass	2.17	55.1	0.69	17.5	-
3/8"	3CM9B3-B-E	3/8"	brass	2.93	74.4	0.95	24.1	-
	3CM9B4-B-E	1/2"	brass	2.98	75.7	0.95	24.1	-
1/2"	4CM9B4-B-E	1/2"	brass	3.50	88.9	1.18	30.0	-
	4CM9B6-B-E	3/4"	brass	3.50	88.9	1.18	30.0	-

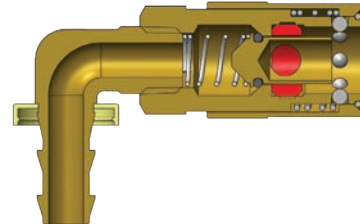
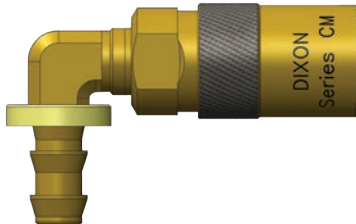

Body Size	CM-Series Industrial Mold Interchange Valved Coupler (90° Push-Loc Barb)							
	Part Detail			Length		Maximum OD		Hex inch
	Part #	Hose ID	Material	inch	mm	inch	mm	
1/4"	2CM9B2-B	1/4"	brass	2.07	52.6	0.69	17.5	-
	2CM9B3-B	3/8"	brass	2.17	55.1	0.69	17.5	-
3/8"	3CM9B3-B	3/8"	brass	2.93	74.4	0.95	24.1	-
	3CM9B4-B	1/2"	brass	2.98	75.7	0.95	24.1	-

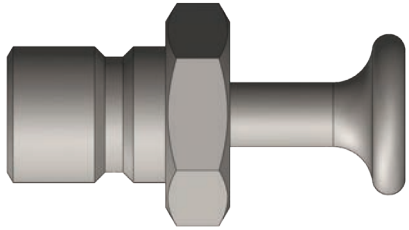

Body Size	CM-Series Coupler Rigid Dust Plug		
	Part Detail		
	Part #	Lanyard	Body
1/4"	2CMPC-B	N/A	brass
3/8"	3CMPC-B	N/A	brass
1/2"	4CMPC-B	N/A	brass

Body Size	CM-Series Industrial Mold Interchange Coupler Seal Kits			
	Part Detail			Seal Kit Contents
	Part #	Coupler Style	Seal Material	
1/4"	2CM-SKIT	all	silicone	body seal
3/8"	3CM-SKIT	all	silicone	body seal
1/2"	4CM-SKIT	all	silicone	body seal

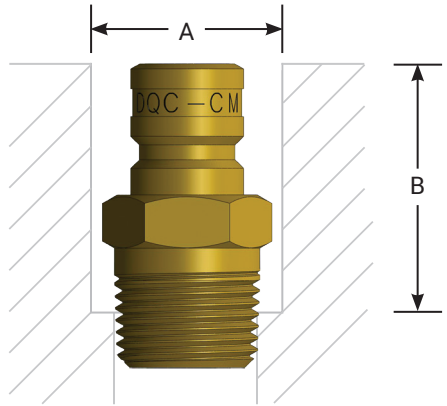

Counterbored mold ports will protect the male threaded plug, allowing the plug to be mounted below the surface, simplifying storing and handling of molds. Dixon male threaded plugs are constructed of corrosion resistant brass to maximize longevity in moist environments.

Body Size	Part Detail		Dimension A	Dimension B
	Part #	Threads		
1/4"	CM2M1-B	1/8" - 27 NPTF	17.5 mm (0.69")	17.5 mm (0.69")
	CM2M2-B	1/4" - 18 NPTF	21.3 mm (0.84")	23.9 mm (0.94")
	CM2M3-B	3/8" - 18 NPTF	25.4 mm (1.00")	24.6 mm (0.97")
3/8"	CM3M2-B	1/4" - 18 NPTF	17.5 mm (0.69")	23.9 mm (0.94")
	CM3M3-B	3/8" - 18 NPTF	21.3 mm (0.84")	28.7 mm (1.13")
	CM3M4-B	1/2" - 14 NPTF	25.4 mm (1.00")	31.8 mm (1.25")
1/2"	CM4M4-B	1/2" - 14 NPTF	31.8 mm (1.25")	38.1 mm (1.50")
	CM4M6-B	3/4" - 14 NPTF	38.1 mm (1.50")	39.6 mm (1.56")

Dixon Blowout Prevention Couplings

Application

- Designed specifically for blowout prevention systems on drilling rigs

Features

- Fire tested and Lloyd's certified to **1300°F (700°C)** in accordance with API 16D, certificate available upon request
- Certified at a test pressure of **5,000 PSI**
- Red powder-coated components and external seals provide easy BOP-approved identification
- Critical seals are FKM

Product Offering

- VEP-BOP-Series: (pg. 140)
 - Thread to connect flushface interchange
 - 3/8" to 1-1/2" in steel
- H-BOP-Series: (pg. 80)
 - ISO-B interchange
 - 3/8" to 1" in steel and 316 stainless
- WS-BOP-Series: (pg. 153)
 - Same reliable wing coupling you know, with red components
 - 3/4" to 2" in steel and 316 stainless steel



Part #	Page #	Part #	Page #	Part #	Page #	Part #	Page #
10BOP-SKIT	154	10WSDP-A	153	12VM12-SS	102	16VEPOF16	138
10CVVBF10	161	10WSF10	150	12VM12-SS-E	107	16VF16	100
10CVVDP	163	10WSF10-BOP	156	12VOF12	100	16VF16-B	100
10CVVF10	161	10WSF10-SS	150	12V-SKIT	110	16VF16-B-E	105
10EF10-B	167	10WSF10-SS-BOP	156	12WBF12-B	146	16VF16-E	105
10EF10-S	167	10WSFH10	152	12WBF12-B-HN	146	16VF16-SS	100
10EM10-B	169	10WSFP10	152	12WDP	148	16VF16-SS-E	105
10E-SKIT	171	10WSOF10	150	12WF12-B	146	16VM16	102
10HBF10	73	10WS-RKIT	154	12WF12-B-HN	146	16VM16-B	102
10HBF10-B	73	10WS-SKIT	154	12W-RKIT-V2	148	16VM16-E	107
10HBF10-S	73	12BOP-SKIT	154	12WSBF12	150	16VM16-SS	102
10HBF10-SS	73	12EF12-B	167	12WSBF12-SS	150	16VM16-SS-E	107
10H-BRKIT	79	12EF12-S	167	12WSDP-A	153	16V-SKIT	110
10HF10	73	12EM12-B	169	12WSF12	150	16WSBF16	150
10HF10-B	73	12E-SKIT	171	12WSF12-BOP	156	16WSBF16-SS	150
10HF10-S	73	12HBF12	73	12WSF12-SS	150	16WSDP-A	153
10HF10-SS	73	12HBF12-B	73	12WSF12-SS-BOP	156	16WSF16	150
10H-RKIT	79	12HBF12-S	73	12WSFH12	152	16WSF16-BOP	156
10H-SKIT	78	12HBF12-SS	73	12WSFP12	152	16WSF16-SS	150
10H-SRKIT	79	12H-BRKIT	79	12WSOF12	150	16WSF16-SS-BOP	156
10H-SSRKIT	79	12HDP-A	77	12WS-RKIT	154	16WSFH16	152
10KBF10	87	12HF10	73	12WS-SKIT	154	16WSFP16	152
10KDP-A	90	12HF10-B	73	140030-10	111	16WSOF16	150
10KF10	87	12HF10-S	73	140030-10	111	16WS-RKIT	154
10K-SKIT	90	12HF10-SS	73	140030-12	111	16WS-SKIT	154
10VBF10	100	12HF12	73	140030-12	111	1AF1-B	65
10VBF10-B	100	12HF12-B	73	140030-16	111	1AM1-B	66
10VBF10-B-E	105	12HF12-S	73	140030-16	111	1AS1-B	66
10VBF10-E	105	12HF12-SS	73	140032-10	111	1BRBF1-B-7	63
10VBF10-SS	100	12HOF10	73	140032-10	111	1BRBF2-B-7	63
10VBF10-SS-E	105	12HOF12	73	140032-12	111	1BRF1-B-7	63
10VDP-A	109	12H-RKIT	79	140032-12	111	1BRF2-B-7	63
10VEPBF10	138	12H-SKIT	78	140032-16	111	1BRGM1-B-7	64
10VEPDP-A	141	12H-SSRKIT	79	16BOP-SKIT	154	1BRGM2-B-7	64
10VEPF10	138	12HTBF12	119	16EF16-B	167	1BRM1-B-7	64
10VEPF10-BOP	143	12HTF12	119	16EF16-S	167	1BRM2-B-7	64
10VEPFH10	140	12HTOF12	119	16EM16-B	169	1BRS1.25-B-7	64
10VEFPF10	140	12KBF12	87	16E-SKIT	171	1BRS1.86-B-7	64
10VEPOF10	138	12KDP-A	90	16HTBF16	119	1BRS2.83-B-7	64
10VF10	100	12KF12	87	16HTF16	119	1EF1-B	167
10VF10-B	100	12K-SKIT	90	16HTOF16	119	1EF1-S	167
10VF10-B-E	105	12VBF12	100	16KBF16	87	1EM1-B	169
10VF10-E	105	12VBF12-B	100	16KDP-A	90	1EM1-S	169
10VF10-SS	100	12VBF12-SS	100	16KF16	87	1HDP	108
10VF10-SS-E	105	12VDP-A	109	16K-SKIT	90	1HDP	77
10VJM10	104	12VEPBF12	138	16STBF12	131	1HF1	71
10VM10	102	12VEPDP-A	141	16STBF16	131	1HF1-B	71
10VM10-B	102	12VEPF12	138	16STDP-A	133	1HF1-S	71
10VM10-E	107	12VEPF12-BOP	143	16STF12	131	1HF1-SS	71
10VM10-SS	102	12VEPFH12	140	16STF16	131	1HOF2	71
10VM10-SS-E	107	12VEFPF12	140	16STF16-SS	131	1H-SKIT	78
10VOF10	100	12VEPOF12	138	16STOF12	131	1PDF1	135
10V-SKIT	110	12VF12	100	16STOF16	131	1PDF2	135
10WBF10-B	146	12VF12-B	100	16ST-SKIT	134	1PDM2	136
10WBF10-B-HN	146	12VF12-B-E	105	16VBF16	100	20HDP-A	77
10WDP	148	12VF12-E	105	16VBF16-B	100	20HF16	73
10WF10-B	146	12VF12-SS	100	16VBF16-SS	100	20HF16-B	73
10WF10-B-HN	146	12VF12-SS-E	105	16VDP-A	109	20HF20	73
10W-RKIT-V2	148	12VM12	102	16VEPBF16	138	20HF24	73
10WSBF10	150	12VM12-B	102	16VEPDP-A	141	2AE2-B	67
10WSBF10-SS	150	12VM12-E	107	16VEPF16	138	2AF1-B	65
						2AF2-B	65

Alpha Numeric Product Index

Part #	Page #	Part #	Page #	Part #	Page #	Part #	Page #
2AGDP	94	2DF2-B	21	2HOF3	71	2SHDM3	43
2AGF2	92	2DF2-S	21	2H-RKIT	79	2SHDS2	44
2AGF2-PV	92	2DF3-B	21	2HSBF2-B	83	2SHDS3	44
2AM1-B	66	2DF3-S	21	2HSBF2-S	83	2STBF2	130
2AM2-B	66	2DH2-B	28	2HSF2-B	83	2STBF2-SS	130
2AS2-B	66	2DK3-B	28	2HSF2-S	83	2ST-BMK	134
2CJBF2-B	39	2DL3-B	28	2H-SKIT	78	2STDP-A	133
2CJBF3-B	39	2DM1-B	23	2H-SRKIT	79	2STF2	130
2CJBM2-B	40	2DM2-B	23	2H-SSRKIT	79	2STF2-SS	130
2CJBM3-B	40	2DM2-S	23	2HTBAND-B	115	2ST-SKIT	134
2CJF2-B	39	2DM3-B	23	2HTBAND-G	115	2TDP	159
2CJF3-B	39	2DM3-S	23	2HTBAND-O	115	2TF2	158
2CJM2-B	40	2DS2-B	26	2HTBAND-R	115	2TM2	158
2CJM3-B	40	2DS2-S	26	2HTBAND-Y	115	2T-SKIT	159
2CM4B2-B	179	2DS3-B	26	2HTBF2	116	2UB2-B	48
2CM4B2-B-E	179	2DS3-S	26	2HTDP	121	2UB3-B	48
2CM4B3-B	179	2EBF2-B	167	2HTF2	116	2UBF2-B	48
2CM4B3-B-E	179	2EF2-B	167	2HTF2-FS	120	2UBF3-B	48
2CM4S2.5-B	178	2EF2-S	167	2HTOF3	116	2UBM2-B	48
2CM4S2.5-B-E	178	2EM2-B	169	2HT-SKIT	121	2UBM3-B	48
2CM4S2-B	178	2EM2-S	169	2JB2-B	34	2UF2-B	48
2CM4S2-B-E	178	2ES2-B	170	2JB3-B	34	2UF3-B	48
2CM4S3-B	178	2E-SKIT	171	2JF1-B	31	2UM2-B	48
2CM4S3-B-E	178	2FB2-B	28	2JF2-B	31	2UM3-B	48
2CM9B2-B	180	2FB3-B	28	2JF3-B	31	2US2-B	48
2CM9B2-B-E	180	2FBF1-B	21	2JM1-B	32	2US3-B	48
2CM9B3-B	180	2FBF2-B	21	2JM2-B	32	2VBF2	98
2CM9B3-B-E	180	2FBF3-B	21	2JM3-B	32	2VBF2-B	98
2CM9S2.5-B	180	2FBM1-B	24	2JS2-B	33	2VBF2-B-E	105
2CM9S2.5-B-E	179	2FBM2-B	24	2JS3-B	33	2VBF2-E	105
2CM9S2-B	180	2FBM3-B	24	2KBF2	86	2VBF2-SS	98
2CM9S2-B-E	179	2FF1-B	21	2KBF2-SS	86	2VBF2-SS-E	105
2CM9S3-B	180	2FF2	21	2KDP-K2DC	89	2V-BRKIT	111
2CM9S3-B-E	179	2FF2-B	21	2KF1	86	2VDP-A	109
2CMB2-B	178	2FF2-S	21	2KF2	86	2VEPBF2	138
2CMB2-B-E	177	2FF3-B	21	2KF2-SS	86	2VEPDP-A	141
2CMB3-B	178	2FF3-S	21	2KOF2	86	2VEPF2	138
2CMB3-B-E	177	2FM1-B	24	2K-SKIT	90	2VEPOF3	138
2CMF1-B	176	2FM1-S	24	2LF2-B	45	2VF1	98
2CMF1-B-E	176	2FM2	24	2LM2-B	46	2VF2	98
2CMF2-B-E	176	2FM2-B	24	2MF2-B	36	2VF2-B	98
2CMPC-B	181	2FM2-S	24	2MF2-PL	35	2VF2-B-E	105
2CMS2.5-B	177	2FM3-B	24	2MF3-B	36	2VF2-E	105
2CMS2.5-B-E	177	2FM3-S	24	2MF3-PL	35	2VF2-SS	98
2CMS2-B	177	2FS2	26	2MM2-B	37	2VF2-SS-E	105
2CMS2-B-E	177	2FS2.5-B	26	2MM2-PL	36	2VJM2	104
2CMS3-B	177	2FS2-B	26	2MM3-B	37	2VM1	102
2CMS3-B-E	177	2FS2-S	26	2MM3-PL	36	2VM2	102
2CM-SKIT	181	2FS3-B	26	2MS2.5-PL	37	2VM2-B	102
2CVVBF2	161	2FS3-S	26	2MS2-B	38	2VM2-B-E	107
2CVVDP	163	2HBF2	71	2MS2-PL	37	2VM2-E	107
2CVVF2	161	2HBF2-B	71	2MS3-B	38	2VM2-SS	102
2CVVFM1415	161	2HBF2-S	71	2MS3-PL	37	2VM2-SS-E	107
2DB2-B	27	2HBF2-SS	71	2NKBF2	61	2VOF2	98
2DB3-B	27	2H-BRKIT	79	2NKBM2	62	2V-RKIT	111
2DBF2-B	21	2HDP-A	77	2NKF2	61	2V-SKIT	110
2DBF3-B	21	2HDP-H2DC	77	2NKM2	62	2V-SSRKIT	111
2DBM2-B	23	2HF2	71	2NK2	62	2WDP	148
2DBM3-B	23	2HF2-B	71	2NS2	62	2WF1-B	146
2DE2-B	28	2HF2-S	71	2SHDF2	42	2WF1-B-HN	146
2DF1-B	21	2HF2-SS	71	2SHDF3	42	3AGDP	94

Part #	Page #	Part #	Page #	Part #	Page #	Part #	Page #
3AGF3	92	3EF3-B	167	3HTM4	118	3VBF3	98
3AGF3-PS	93	3EF3-S	167	3HTOF3	116	3VBF3-B	98
3AGF3-PV	92	3EM3-B	169	3HTOF4	116	3VBF3-B-E	105
3AGF3-PV-PS	93	3EM3-S	169	3HTOM3	118	3VBF3-E	105
3CJBF3-B	39	3ES3-B	170	3HTOM4	118	3VBF3-SS	98
3CJBF4-B	39	3E-SKIT	171	3HT-SKIT	121	3VBF3-SS-E	105
3CJBM3-B	40	3FB2	28	3JB2	34	3VBRKIT	111
3CJBM4-B	40	3FB3	28	3JB3	34	3VDP-A	109
3CJF3-B	39	3FB4	28	3JB4	34	3VDP-V3DC	108
3CJF4-B	39	3FBF3	21	3JF2	31	3VEPBF3	138
3CJM3-B	40	3FBM3	24	3JF3	31	3VEPBF4	138
3CJM4-B	40	3FF2	21	3JF4	31	3VEPDP-A	141
3CM4B3-B	179	3FF3	21	3JM2	32	3VEPF3	138
3CM4B3-B-E	179	3FF3-S	21	3JM3	32	3VEPF3-BOP	143
3CM4B4-B	179	3FF4	21	3JM4	32	3VEPF4	138
3CM4B4-B-E	179	3FM2	24	3JS2	33	3VEPF4-BOP	143
3CM4S3-B	178	3FM3	24	3JS3	33	3VEPOF4	138
3CM4S3-B-E	178	3FM3-S	24	3JS4	33	3VF3	98
3CM4S4-B	178	3FM4	24	3KBF3	86	3VF3-B	98
3CM4S4-B-E	178	3FS2	26	3KBF3-SS	86	3VF3-B-E	105
3CM9B3-B	180	3FS3	26	3KDP-K3DC	108	3VF3-E	105
3CM9B3-B-E	180	3FS3-S	26	3KDP-K3DC	89	3VF3-SS	98
3CM9B4-B	180	3FS4	26	3KF3	86	3VF3-SS-E	105
3CM9B4-B-E	180	3HBF3	71	3KF3-SS	86	3VF4	98
3CM9S3-B	180	3HBF3-B	71	3KOF3	86	3VJM3	104
3CM9S3-B-E	179	3HBF3-S	71	3K-SKIT	90	3VM3	102
3CM9S4-B	180	3HBF3-SS	71	3MF3-PL	35	3VM3-B	102
3CM9S4-B-E	179	3H-BRKIT	79	3MM3-PL	36	3VM3-B-E	107
3CMB3-B	178	3HDP-A	77	3MM4-PL	36	3VM3-E	107
3CMB3-B-E	177	3HDP-H3DC	77	3MS3-PL	37	3VM3-SS	102
3CMB4-B	178	3HF3	71	3NBM4	52	3VM3-SS-E	107
3CMB4-B-E	177	3HF3-B	71	3NCS4	54	3VOF3	98
3CMF2-B	176	3HF3-BOP	81	3NM4	52	3V-RKIT	111
3CMF2-B-E	176	3HF3-S	71	3N-SKIT	56	3V-SKIT	110
3CMF3-B-E	176	3HF3-SS	71	3STBF3	130	3V-SSRKIT	111
3CMPC-B	181	3HF3-SS-BOP	81	3STBF3-SS	130	3WDP	148
3CMS3-B	177	3HOF4	71	3STBF4	130	3WF2-B	146
3CMS3-B-E	177	3H-RKIT	79	3STBF4-SS	130	3WF2-B-HN	146
3CMS4-B	177	3HSBF3-B	83	3ST-BMK	134	3WF3-B	146
3CMS4-B-E	177	3HSBF3-S	83	3STDP-A	133	3WF3-B-HN	146
3CM-SKIT	181	3HSF3-B	83	3STF2	130	3XKF3	128
3CVVBF3	161	3HSF3-S	83	3STF3	130	4.5TDDP-A	165
3CVVDP	163	3H-SKIT	78	3STF3-SS	130	4AGBF4	92
3CVVF3	161	3H-SRKIT	79	3STF4	130	4AGBF4-PV	92
3CVVFM1615	161	3H-SSRKIT	79	3STF4-SS	130	4AGF4	92
3DB3-B	27	3HTBAND-B	115	3ST-SKIT	134	4AGF4-PS	93
3DBF3-B	21	3HTBAND-G	115	3TDP	159	4AGF4-PV	92
3DBM3-B	23	3HTBAND-O	115	3TF3	158	4AGF4-PV-PS	93
3DF2-B	21	3HTBAND-R	115	3TM3	158	4AGF6	92
3DF3-B	21	3HTBAND-Y	115	3TM3-PV	158	4AGF6-PS	93
3DF3-S	21	3HTBF3	116	3TM3-SS	158	4AGF6-PV	92
3DF4-B	21	3HTBF3-SS	116	3TM3-SS-PV	158	4AGF6-PV-PS	93
3DM2-B	23	3HTBF4	116	3TRBF3	113	4AGHT4	126
3DM3-B	23	3HTBF4-SS	116	3TRF3	113	4AGOF4	92
3DM3-S	23	3HTDP	121	3TR-SKIT	113	4AGOF4-PS	93
3DM4-B	23	3HTF3	116	3T-SKIT	159	4AGOF4-PV	92
3DS2-B	26	3HTF3-FS	120	3UBF3-B	48	4AGOF4-PV-PS	93
3DS3-B	26	3HTF3-SS	116	3UBM3-B	48	4AGOF5	92
3DS3-S	26	3HTF4	116	3UF3-B	48	4AGOF5-PS	93
3DS4-B	26	3HTF4-SS	116	3UM3-B	48	4AGOF5-PV	92
3EBF3-B	167	3HTM3	118	3US3-B	48	4AGOF5-PV-PS	93

Alpha Numeric Product Index

Part #	Page #	Part #	Page #	Part #	Page #	Part #	Page #
4CM4B4-B-E	179	4FM3	32	4HTRB5	119	4NS4	54
4CM4B6-B-E	179	4FM4	24	4HTRB6	119	4NS4-B	54
4CM4S4-B-E	178	4FM4	32	4HT-SKIT	121	4NS4-B-WF	56
4CM4S6-B-E	178	4FM4-S	24	4HTZF4	125	4NS4-WF	56
4CM9B4-B-E	180	4FM6	24	4HTZF6	125	4NS6	54
4CM9B6-B-E	180	4FM6	32	4HTZOF4	125	4NS6-B	54
4CM9S4-B-E	179	4FS3	26	4HTZOF5	125	4NS6-B-WF	56
4CM9S6-B-E	179	4FS3	33	4HTZOF6	125	4NS6-S	54
4CMB4-B-E	177	4FS4	26	4K-B-DP	89	4NS6-SS	54
4CMB6-B-E	177	4FS4	33	4KBF4	86	4NS6-WF	56
4CMF4-B-E	176	4FS4-S	26	4KBF4-SS	86	4NS8	54
4CMPC-B	181	4FS6	26	4KDP	89	4NS8-B	54
4CMS4-B-E	177	4FS6	33	4KF4	86	4NS8-S	54
4CMS6-B-E	177	4HBF4	71	4KF4-SS	86	4NS8-SS	54
4CM-SKIT	181	4HBF4-B	71	4KF6	86	4N-SKIT	56
4CVVBF4	161	4HBF4-S	71	4K-G-DP	89	4PDC-A	59
4CVVDP	163	4HBF4-SS	71	4K-O-DP	89	4PF4	58
4CVVF4	161	4H-BRKIT	79	4KOF4	86	4PF6	58
4CVVFM1815	161	4HDP-A	77	4KOF5	86	4PF6-B	58
4CVVFM2215	161	4HDP-H4DC	77	4K-R-DP	89	4PF6-S	58
4CVVOF4	161	4HF4	71	4K-SKIT	90	4PM3	59
4CVVOF5	161	4HF4-B	71	4K-Y-DP	89	4PM4	59
4DB4-B	27	4HF4-BOP	81	4N4N	56	4PM6	59
4DBF4-B	21	4HF4-HV	75	4NBF3	50	4PM6-9	59
4DBM4-B	23	4HF4-S	71	4NBF4	50	4PM6-S	59
4DF3-B	21	4HF4-SS	71	4NBF4-B	50	4PM8	59
4DF4-B	21	4HF4-SS-BOP	81	4NBF6	50	4PS3	60
4DF4-S	21	4HOF5	71	4NBF6-B	50	4PS4	60
4DF6-B	21	4H-RKIT	79	4NBF8	50	4PS4-B	60
4DM3-B	23	4HSBF4-B	83	4NBF8-B	50	4PS4-B-WF	60
4DM4-B	23	4HSBF4-S	83	4NBM3	52	4PS4-WF	60
4DM4-S	23	4HSF4-B	83	4NBM4	52	4PS6	60
4DM6-B	23	4HSF4-S	83	4NBM4-B	52	4PS6-9	60
4DS3-B	26	4H-SKIT	78	4NBM6	52	4PS6-B	60
4DS4-B	26	4H-SRKIT	79	4NBM6-B	52	4PS6-B-WF	60
4DS4-S	26	4H-SSRKIT	79	4NBM8	52	4PS6-S	60
4DS6-B	26	4HT9OF3	120	4NBM8-B	52	4PS6-S-WF	60
4EAF3	173	4HT9OF4	120	4NF3	50	4PS6-WF	60
4EAF4	173	4HTAG4	126	4NF3-B	50	4PS8	60
4EA-SKIT	173	4HTBAND-B	115	4NF4	50	4PS8-B	60
4EBF4-B	167	4HTBAND-G	115	4NF4-B	50	4P-SKIT	60
4EF4-B	167	4HTBAND-O	115	4NF6	50	4SHDF3	42
4EF4-S	167	4HTBAND-R	115	4NF6-B	50	4SHDF4	42
4EM4-B	169	4HTBAND-Y	115	4NF6-S	50	4SHDF6	42
4EM4-S	169	4HTBF4	116	4NF6-SS	50	4SHDM3	43
4ES4-B	170	4HTBF4-SS	116	4NF8	50	4SHDM4	43
4E-SKIT	171	4HTBF6	116	4NF8-B	50	4SHDS3	44
4FB3	28	4HTBF6-SS	116	4NF8-SS	50	4SHDS4	44
4FB3	34	4HTDP	121	4NM3	52	4STBF4	130
4FB4	28	4HTF4	116	4NM3-B	52	4STBF4-SS	130
4FB4	34	4HTF4-FS	120	4NM4	52	4ST-BMK	134
4FBF4	21	4HTF4-SS	116	4NM4-B	52	4STDP-A	133
4FBM4	24	4HTF6	116	4NM6	52	4STF4	130
4FF3	21	4HTF6-SS	116	4NM6-B	52	4STF4-SS	130
4FF3	31	4HTJB5	119	4NM6-S	52	4STOF4	130
4FF4	21	4HTJB6	119	4NM6-SS	52	4ST-SKIT	134
4FF4	31	4HTM4	118	4NM8	52	4TDDP-A	165
4FF4-S	21	4HTOF4	116	4NM8-B	52	4TDF4-SS	165
4FF6	21	4HTOF5	116	4NM8-SS	52	4TDPF4.5-SS	165
4FF6	31	4HTOF6	116	4NS3	54	4TRBF4	113
4FM3	24	4HTRB4	119	4NS3-B	54	4TRF4	113

Part #	Page #	Part #	Page #	Part #	Page #	Part #	Page #
4TR-SKIT	113	6DM4-B	23	6STBF6	130	6WSF6-SS-BOP	156
4VBF4	98	6DM6-B	23	6STBF6-SS	130	6WSFH6	152
4VBF4-B	98	6DM8-B	23	6STBMK	134	6WSFP6	152
4VBF4-B-E	105	6DS4-B	26	6STDP-A	133	6WSOF6	150
4VBF4-E	105	6DS6-B	26	6STF6	130	6WS-RKIT	154
4VBF4-SS	98	6DS8-B	26	6STF6-SS	130	6WS-SKIT	154
4VBF4-SS-E	105	6EBF6-B	167	6STOF6	130	8AGDP	94
4V-BRKIT	111	6EF6-B	167	6ST-SKIT	134	8AGF8	92
4VDP-A	109	6EF6-S	167	6TRBF6	113	8AGF8-PV	92
4VEPBF4	138	6EM6-B	169	6TRF6	113	8BOP-SKIT	154
4VEPBF6	138	6EM6-S	169	6TR-SKIT	113	8CVVBF8	161
4VEPDP-A	141	6ES6-B	170	6VBF6	98	8CVVDP	163
4VEPF4	138	6E-SKIT	171	6VBF6-B	98	8CVVF8	161
4VEPF4-BOP	143	6HBF6	71	6VBF6-B-E	105	8EBF8-B	167
4VEPF6	138	6HBF6-B	71	6VBF6-E	105	8EF8-B	167
4VEPOF4	138	6HBF6-S	71	6VBF6-SS	98	8EF8-S	167
4VEPOF5	138	6HBF6-SS	71	6VBF6-SS-E	105	8EM8-B	169
4VEPOF6	138	6H-BRKIT	79	6VBRKIT	111	8EM8-S	169
4VF4	98	6HDP-A	77	6VDP-A	109	8ES8-B	170
4VF4-B	98	6HDP-H6DC	77	6VDP-V6DC	108	8E-SKIT	171
4VF4-B-E	105	6HF6	71	6VEPBF6	138	8HBF8	71
4VF4-E	105	6HF6-B	71	6VEPDP-A	141	8HBF8-B	71
4VF4-SS	98	6HF6-BOP	81	6VEPF6	138	8HBF8-S	71
4VF4-SS-E	105	6HF6-S	71	6VEPF6-BOP	143	8HBF8-SS	71
4VF6	98	6HF6-SS	71	6VEPFH6	140	8H-BRKIT	79
4VJM4	104	6HF6-SS-BOP	81	6VEPPF6	140	8HDP-A	77
4VM4	102	6HOF6	71	6VEPOF6	138	8HDP-H8DC	77
4VM4-B	102	6H-RKIT	79	6VF6	98	8HF8	71
4VM4-B-E	107	6HSBF6-B	83	6VF6-B	98	8HF8-B	71
4VM4-E	107	6HSBF6-S	83	6VF6-B-E	105	8HF8-BOP	81
4VM4-SS	102	6HSF6-B	83	6VF6-E	105	8HF8-S	71
4VM4-SS-E	107	6HSF6-S	83	6VF6-SS	98	8HF8-SS	71
4VOF4	98	6H-SKIT	78	6VF6-SS-E	105	8HF8-SS-BOP	81
4V-RKIT	111	6H-SRKIT	79	6VJM6	104	8HOF8	71
4V-SKIT	110	6H-SSRKIT	79	6VM6	102	8H-RKIT	79
4V-SSRKIT	111	6HTBAND-B	115	6VM6-B	102	8HSBF8-B	83
5HTBAND-B	115	6HTBAND-G	115	6VM6-B-E	107	8HSBF8-S	83
5HTBAND-G	115	6HTBAND-O	115	6VM6-E	107	8HSF8-B	83
5HTBAND-O	115	6HTBAND-R	115	6VM6-SS	102	8HSF8-S	83
5HTBAND-R	115	6HTBAND-Y	115	6VM6-SS-E	107	8H-SKIT	78
5HTBAND-Y	115	6HTBF6	116	6VOF6	98	8H-SRKIT	79
5HTBF6	116	6HTBF6-SS	116	6V-RKIT	111	8H-SSRKIT	79
5HTBF6-SS	116	6HTBF8	116	6V-SKIT	110	8HTBAND-B	115
5HTDP	121	6HTBF8-SS	116	6V-SSRKIT	111	8HTBAND-G	115
5HTF6	116	6HTDP	121	6WBF4-B	146	8HTBAND-O	115
5HTF6-SS	116	6HTF6	116	6WBF4-B-HN	146	8HTBAND-R	115
5HTOF5	116	6HTF6-FS	120	6WBF6-B	146	8HTBAND-Y	115
5HTOF6	116	6HTF6-SS	116	6WBF6-B-HN	146	8HTBF10	116
5HT-SKIT	121	6HTF8	116	6WDP	148	8HTBF10-SS	116
6AGDP	94	6HTF8-SS	116	6WF4-B	146	8HTBF8	116
6AGF6	92	6HTOF5	116	6WF4-B-HN	146	8HTBF8-SS	116
6AGF6-PS	93	6HTOF6	116	6WF6-B	146	8HTDP	121
6AGF6-PV	92	6HTOF8	116	6WF6-B-HN	146	8HTF10	116
6AGF6-PV-PS	93	6HT-SKIT	121	6W-RKIT-V2	148	8HTF10-SS	116
6BOP-SKIT	154	6KBF6	87	6WSBF6	150	8HTF8	116
6CVVBF6	161	6KBF6-SS	87	6WSBF6-SS	150	8HTF8-FS	120
6CVVDP	163	6KDP-K6DC	89	6WSDP-A	153	8HTF8-SS	116
6CVVF6	161	6KF6	87	6WSF4	150	8HTOF10	116
6CVVFM2215	161	6KF6-SS	87	6WSF4-BOP	156	8HTOF8	116
6DF4-B	21	6KOF6	87	6WSF6	150	8HT-SKIT	121
6DF6-B	21	6K-SKIT	90	6WSF6-BOP	156	8KBF8	87
6DF8-B	21			6WSF6-SS	150	8KBF8-SS	87

Alpha Numeric Product Index

Part #	Page #	Part #	Page #	Part #	Page #	Part #	Page #
8KDP-K8DC.....	89	8WF8.....	146	BR1S1.86-B-E-7.....	64	CM3M2-B.....	181
8KF8.....	87	8WF8-B.....	146	BR1S2.83-B-E-7.....	64	CM3M2-B-L11.5.....	176
8KF8-SS.....	87	8WF8-B-HN.....	146	CJ2BF2-B.....	40	CM3M2-B-L2.5.....	176
8KOF8.....	87	8WF8-HN.....	146	CJ2BF2-LG.....	40	CM3M2-B-L4.....	176
8K-SKIT.....	90	8W-RKIT-V2.....	148	CJ2BF3-B.....	40	CM3M2-B-L5.5.....	176
8STBF10.....	130	8WSBF8.....	150	CJ2BF3-LG.....	40	CM3M2-B-L7.....	176
8STBF10-SS.....	130	8WSBF8-SS.....	150	CJ2BM2-B.....	41	CM3M2-B-L8.5.....	176
8STBF8.....	130	8WSDP-A.....	153	CJ2BM2-LG.....	41	CM3M3-B.....	175
8STBF8-SS.....	130	8WSF8.....	150	CJ2BM3-B.....	41	CM3M3-B.....	181
8STBF8-V2.....	131	8WSF8-BOP.....	156	CJ2BM3-LG.....	41	CM3M4-B.....	175
8STDP-A.....	133	8WSF8-SS.....	150	CJ2F2-B.....	40	CM3M4-B.....	181
8STDP-A-V2.....	133	8WSF8-SS-BOP.....	156	CJ2F2-LG.....	40	CM4F4-B.....	175
8STF10.....	130	8WSFH8.....	152	CJ2F3-B.....	40	CM4F6-B.....	175
8STF10-SS.....	130	8WSFP8.....	152	CJ2F3-LG.....	40	CM4M4-B.....	175
8STF10-V2.....	131	8WSOF8.....	150	CJ2M2-B.....	41	CM4M4-B.....	181
8STF8.....	130	8WS-RKIT.....	154	CJ2M2-LG.....	41	CM4M6-B.....	175
8STF8-SS.....	130	8WS-SKIT.....	154	CJ2M3-B.....	41	CM4M6-B.....	181
8STF8-V2.....	131	A1F1-B.....	66	CJ2M3-LG.....	41	CVV10BF10.....	162
8STOF10.....	130	A1M1-B.....	66	CJ3BF3.....	40	CVV10DC.....	163
8STOF8.....	130	A1S1-B.....	67	CJ3BF3-B.....	40	CVV10F10.....	162
8ST-SKIT.....	134	A2E2.....	67	CJ3BF4.....	40	CVV2BF2.....	162
8ST-SKIT-V2.....	134	A2E2-B.....	67	CJ3BF4-B.....	40	CVV2DC.....	163
8TRBF8.....	113	A2F1-B.....	66	CJ3BM3.....	41	CVV2F2.....	162
8TRF8.....	113	A2F2.....	66	CJ3BM3-B.....	41	CVV2FM1415.....	162
8TR-SKIT.....	113	A2F2-B.....	66	CJ3BM4.....	41	CVV3BF3.....	162
8VBF8.....	98	A2M2.....	66	CJ3BM4-B.....	41	CVV3DC.....	163
8VBF8-B.....	98	A2M2-B.....	66	CJ3F3.....	40	CVV3F3.....	162
8VBF8-B-E.....	105	A2S2.....	67	CJ3F3-B.....	40	CVV3FM1615.....	162
8VBF8-E.....	105	AG2DC.....	94	CJ3F4.....	40	CVV4BF4.....	162
8VBF8-SS.....	98	AG2F2.....	93	CJ3F4-B.....	40	CVV4DC.....	163
8VBF8-SS-E.....	105	AG2F2-PV.....	94	CJ3M3.....	41	CVV4F4.....	162
8V-BRKIT.....	111	AG3DC.....	94	CJ3M3-B.....	41	CVV4FM1815.....	162
8VDP-A.....	109	AG3F3.....	93	CJ3M4.....	41	CVV4FM2215.....	162
8VDP-V8DC.....	108	AG3F3-PV.....	94	CJ3M4-B.....	41	CVV4OF4.....	162
8VEPBF8.....	138	AG4BF4.....	93	CM2F1.....	175	CVV4OF5.....	162
8VEPDP-A.....	141	AG4BF4-PV.....	94	CM2F1-B.....	175	CVV6BF6.....	162
8VEPF8.....	138	AG4F4.....	93	CM2F2.....	175	CVV6DC.....	163
8VEPF8-BOP.....	143	AG4F4-PV.....	94	CM2F2-B.....	175	CVV6F6.....	162
8VEPF8-SS.....	138	AG4F6.....	93	CM2F3.....	175	CVV6FM2215.....	162
8VEPFH8.....	140	AG4F6-PV.....	94	CM2F3-B.....	175	CVV8BF8.....	162
8VEFPF8.....	140	AG4OF4.....	93	CM2M1-B.....	175	CVV8DC.....	163
8VEPOF8.....	138	AG4OF4-PV.....	94	CM2M1-B.....	181	CVV8F8.....	162
8VF8.....	98	AG4OF5.....	93	CM2M1-B-L2.5.....	176	D2B2.....	28
8VF8-B.....	98	AG4OF5-PV.....	94	CM2M1-B-L4.....	176	D2B2-B.....	28
8VF8-B-E.....	105	AG6DC.....	94	CM2M1-B-L5.5.....	176	D2B3.....	28
8VF8-E.....	105	AG6F6.....	93	CM2M2-B.....	175	D2BF2.....	22
8VF8-SS.....	98	AG6F6-PV.....	94	CM2M2-B.....	181	D2BF3.....	22
8VF8-SS-E.....	105	AG8DC.....	94	CM2M2-B-L2.5.....	176	D2BM2.....	25
8VJM8.....	104	AG8F8.....	93	CM2M2-B-L4.....	176	D2BM3.....	25
8VM8.....	102	AG8F8-PV.....	94	CM2M2-B-L5.5.....	176	D2E2.....	28
8VM8-B.....	102	AGE4F4-PV.....	94	CM2M2-B-L7.....	176	D2F1.....	22
8VM8-B-E.....	107	AGE4OF4-PV.....	94	CM2M3-B.....	175	D2F2.....	22
8VM8-E.....	107	BR1BF1-B-E-7.....	63	CM2M3-B.....	181	D2F2-B.....	22
8VM8-SS.....	102	BR1BF2-B-E-7.....	63	CM3F2.....	175	D2F2-S.....	22
8VM8-SS-E.....	107	BR1F1-B-E-7.....	63	CM3F2-B.....	175	D2F3.....	22
8VOF8.....	98	BR1F2-B-E-7.....	63	CM3F3.....	175	D2F3-B.....	22
8V-RKIT.....	111	BR1GM1-B-E-7.....	64	CM3F3-B.....	175	D2F3-S.....	22
8V-SKIT.....	110	BR1GM2-B-E-7.....	64	CM3M1-B-L2.5.....	176	D2H2.....	28
8V-SSRKIT.....	111	BR1M1-B-E-7.....	64	CM3M1-B-L4.....	176	D2K3.....	28
8WBF8-B.....	146	BR1M2-B-E-7.....	64	CM3M1-B-L5.5.....	176	D2L3.....	28
8WBF8-B-HN.....	146	BR1S1.25-B-E-7.....	64	CM3M1-B-L7.....	176	D2M1.....	25
8WDP.....	148			CM3M2-B.....	175		

Part #	Page #	Part #	Page #	Part #	Page #	Part #	Page #
D2M1-B	25	D6B6	28	E6BF6-B	168	H12DC-A	77
D2M1-S	25	D6F4	22	E6F6	168	H12F10	74
D2M2	25	D6F6	22	E6F6-B	168	H12F10-B	74
D2M2-B	25	D6F8	22	E6F6-S	168	H12F10-S	74
D2M2-S	25	D6M4	25	E6M6	170	H12F10-SS	74
D2M3	25	D6M6	25	E6M6-B	170	H12F12	74
D2M3-B	25	D6M8	25	E6M6-S	170	H12F12-B	74
D2M3-S	25	D6S4	27	E6S6	171	H12F12-S	74
D2S2	27	D6S6	27	E6S6-B	171	H12F12-SS	74
D2S2.5	27	D6S8	27	E8BF8-B	168	H12OF10	74
D2S2-B	27	D-H4F4-S	76	E8F8	168	H12OF12	74
D2S2-S	27	D-H4F4-SS	76	E8F8-B	168	H1DC	136
D2S3	27	D-H4F4-SV-8	76	E8F8-S	168	H1DC	77
D2S3-B	27	E10F10	168	E8M8	170	H1F1	72
D2S3-S	27	E10F10-B	168	E8M8-B	170	H1F1-B	72
D3B2	28	E10F10-S	168	E8M8-S	170	H1F1-S	72
D3B3	28	E10M10	170	E8S8	171	H1F1-SS	72
D3B4	28	E10M10-B	170	E8S8-B	171	H1OF2	72
D3BF3	22	E12F12	168	EA4F3	173	H20DC-A	77
D3BM3	25	E12F12-B	168	EA4F4	173	H20F16	74
D3F2	22	E12F12-S	168	F-10E-SKIT	171	H20F16-B	74
D3F3	22	E12M12	170	F-10-SKIT	78	H20F20	74
D3F3-B	22	E12M12-B	170	F-10V-SKIT	110	H20F24	74
D3F3-S	22	E16F16	168	F-12E-SKIT	171	H2BF2	72
D3F4	22	E16F16-B	168	F-12H-SKIT	78	H2BF2-B	72
D3M2	25	E16F16-S	168	F-12V-SKIT	110	H2BF2-S	72
D3M3	25	E16M16	170	F-16E-SKIT	171	H2BF2-SS	72
D3M3-B	25	E16M16-B	170	F-16V-SKIT	110	H2DC-A	77
D3M3-S	25	E1F1	168	F-1H-SKIT	78	H2F2	72
D3M4	25	E1F1-B	168	F-2E-SKIT	171	H2F2-B	72
D3S2	27	E1F1-S	168	F-2H-SKIT	78	H2F2-S	72
D3S3	27	E1M1	170	F-2V-SKIT	110	H2F2-SS	72
D3S3-B	27	E1M1-B	170	F-3E-SKIT	171	H2M3	74
D3S3-S	27	E1M1-S	170	F-3H-SKIT	78	H2OF3	72
D3S4	27	E2BF2-B	168	F-3V-SKIT	110	H3BF3	72
D4B4	28	E2F2	168	F-4EA-SKIT	173	H3BF3-B	72
D4BF4	22	E2F2-B	168	F-4E-SKIT	171	H3BF3-S	72
D4BM4	25	E2F2-S	168	F-4HF4-HV	75	H3BF3-SS	72
D4F3	22	E2M2	170	F-4H-SKIT	78	H3DC-A	77
D4F4	22	E2M2-B	170	F-4N-SKIT	56	H3F3	72
D4F4-B	22	E2M2-S	170	F-4P-SKIT	60	H3F3-B	72
D4F4-S	22	E2S2	171	F-4V-SKIT	110	H3F3-BOP	81
D4F6	22	E2S2-B	171	F-6E-SKIT	171	H3F3-S	72
D4F6-B	22	E3BF3-B	168	F-6H-SKIT	78	H3F3-SS	72
D-4HF4-S-FNS	75	E3F3	168	F-6V-SKIT	110	H3F3-SS-BOP	81
D-4HF4-S-FSB	75	E3F3-B	168	F-8E-SKIT	171	H3OF4	72
D-4HF4-SS-FNS	75	E3F3-S	168	F-8H-SKIT	78	H4BF4	72
D-4HF4-SS-FSB	75	E3M3	170	F-8V-SKIT	110	H4BF4-B	72
D4M2	25	E3M3-B	170	F-H4F4-HV	75	H4BF4-S	72
D4M3	25	E3M3-S	170	H10BF10	74	H4BF4-SS	72
D4M4	25	E3S3	171	H10BF10-B	74	H4DC-A	77
D4M4-B	25	E3S3-B	171	H10BF10-S	74	H4F4	72
D4M4-S	25	E4BF4-B	168	H10BF10-SS	74	H4F4-B	72
D4M6	25	E4F4	168	H10F10	74	H4F4-BOP	81
D4S3	27	E4F4-B	168	H10F10-B	74	H4F4-HV	75
D4S3-B	27	E4F4-S	168	H10F10-S	74	H4F4-S	72
D4S4	27	E4M4	170	H10F10-SS	74	H4F4-SS	72
D4S4-B	27	E4M4-B	170	H12BF12	74	H4F4-SS-BOP	81
D4S4-S	27	E4M4-S	170	H12BF12-B	74	H4M6-S	74
D4S6	27	E4S4	171	H12BF12-S	74	H4OF5	72
D4S6-B	27	E4S4-B	171	H12BF12-SS	74	H6BF6	72

Alpha Numeric Product Index

Part #	Page #	Part #	Page #	Part #	Page #	Part #	Page #
H6BF6-B	72	HT2BAND-R	115	HT5F6	117	HTE8BF8	124
H6BF6-S	72	HT2BAND-Y	115	HT5F6-SS	117	HTE8F10	124
H6BF6-SS	72	HT2BF2	117	HT5OF5	117	HTE8F8	124
H6DC-A	77	HT2DC	121	HT5OF6	117	HTE8OF10	124
H6F6	72	HT2F2	117	HT5-SKIT-V2	121	HTE8OF8	124
H6F6-B	72	HT2OF3	117	HT6BAND-B	115	J2B2	34
H6F6-BOP	81	HT2-SKIT-V2	121	HT6BAND-G	115	J2B3	34
H6F6-S	72	HT3BAND-B	115	HT6BAND-O	115	J2F1	31
H6F6-SS	72	HT3BAND-G	115	HT6BAND-R	115	J2F2	31
H6F6-SS-BOP	81	HT3BAND-O	115	HT6BAND-Y	115	J2F2-B	31
H6OF6	72	HT3BAND-R	115	HT6BF6	117	J2F3	31
H8BF8	72	HT3BAND-Y	115	HT6BF6-SS	117	J2M1	32
H8BF8-B	72	HT3BF3	117	HT6BF8	117	J2M2	32
H8BF8-S	72	HT3BF3-SS	117	HT6BF8-SS	117	J2M2-B	32
H8BF8-SS	72	HT3BF4	117	HT6DC	121	J2M3	32
H8DC-A	77	HT3BF4-SS	117	HT6F6	117	J2S2	33
H8F8	72	HT3DC	121	HT6F6-SS	117	J2S3	33
H8F8-B	72	HT3F3	117	HT6F8	117	J3B3	34
H8F8-BOP	81	HT3F3-SS	117	HT6F8-SS	117	J3F2	31
H8F8-S	72	HT3F4	117	HT6OF5	117	J3F3	31
H8F8-SS	72	HT3F4-SS	117	HT6OF6	117	J3F4	31
H8F8-SS-BOP	81	HT3M3	118	HT6OF8	117	J3M2	32
H8OF8	72	HT3M4	118	HT6-SKIT-V2	121	J3M3	32
HS2BF2	84	HT3OF3	117	HT8BAND-B	115	J3M4	32
HS2BF2-B	84	HT3OF4	117	HT8BAND-G	115	J3S2	33
HS2BF2-S	84	HT3OM3	118	HT8BAND-O	115	J3S3	33
HS2F2	84	HT3OM4	118	HT8BAND-R	115	J3S4	33
HS2F2-B	84	HT3-SKIT-V2	121	HT8BAND-Y	115	J4B4	34
HS2F2-S	84	HT49OF3	120	HT8BF10	117	J4F3	31
HS3BF3	84	HT49OF4	120	HT8BF10-SS	117	J4F4	31
HS3BF3-B	84	HT4BAND-B	115	HT8BF8	117	J4F6	31
HS3BF3-S	84	HT4BAND-G	115	HT8BF8-SS	117	J4M3	32
HS3F3	84	HT4BAND-O	115	HT8DC	121	J4M4	32
HS3F3-B	84	HT4BAND-R	115	HT8F10	117	J4M6	32
HS3F3-S	84	HT4BAND-Y	115	HT8F10-SS	117	J4S3	33
HS4BF4	84	HT4BF4	117	HT8F8	117	J4S4	33
HS4BF4-B	84	HT4BF4-SS	117	HT8F8-SS	117	J4S6	33
HS4BF4-S	84	HT4BF6	117	HT8OF10	117	K10BF10	88
HS4F4	84	HT4BF6-SS	117	HT8OF8	117	K10DC-A	90
HS4F4-B	84	HT4DC	121	HT8-SKIT-V2	121	K10F10	88
HS4F4-S	84	HT4F4	117	HTE3BF4	124	K12BF12	88
HS6BF6	84	HT4F4-SS	117	HTE3F3	124	K12DC-A	90
HS6BF6-B	84	HT4F6	117	HTE3F4	124	K12F12	88
HS6BF6-S	84	HT4F6-SS	117	HTE3OF4	124	K16BF16	88
HS6F6	84	HT4JB5	119	HTE4BF4	124	K16DC-A	90
HS6F6-B	84	HT4JB6	119	HTE4BF6	124	K16F16	88
HS6F6-S	84	HT4M4	118	HTE4F4	124	K2BF2	88
HS8BF8	84	HT4OF4	117	HTE4F6	124	K2BF2-SS	88
HS8BF8-B	84	HT4OF5	117	HTE4OF4	124	K2F1	88
HS8BF8-S	84	HT4OF6	117	HTE4OF5	124	K2F2	88
HS8F8	84	HT4RB4	119	HTE4OF6	124	K2F2-SS	88
HS8F8-B	84	HT4RB5	119	HTE5BF6	124	K2OF2	88
HS8F8-S	84	HT4RB6	119	HTE5F6	124	K3BF3	88
HT12BF12	119	HT4-SKIT-V2	121	HTE5OF5	124	K3BF3-SS	88
HT12F12	119	HT5BAND-B	115	HTE5OF6	124	K3F3	88
HT12OF12	119	HT5BAND-G	115	HTE6BF6	124	K3F3-SS	88
HT16BF16	119	HT5BAND-O	115	HTE6BF8	124	K3OF3	88
HT16F16	119	HT5BAND-R	115	HTE6F6	124	K4-B-DC	89
HT16OF16	119	HT5BAND-Y	115	HTE6F8	124	K4BF4	88
HT2BAND-B	115	HT5BF6	117	HTE6OF6	124	K4BF4-SS	88
HT2BAND-G	115	HT5BF6-SS	117	HTE6OF8	124	K4DC	89
HT2BAND-O	115	HT5DC	121	HTE8BF10	124	K4F4	88

Part #	Page #	Part #	Page #	Part #	Page #	Part #	Page #
K4F4-SS	88	N4F6-LS	51	P-16E-SKIT	171	SCVM4	69
K4F6	88	N4F6-S	51	P-16V-SKIT	110	SCVM6	69
K4-G-DC	89	N4F6-SS	51	P-1H-SKIT	78	SCVM8	69
K4-O-DC	89	N4F6-ZLS	51	P-2E-SKIT	171	SCVR6	69
K40F4	88	N4F8	51	P-2H-SKIT	78	SCVS10	69
K40F5	88	N4F8-B	51	P-2V-SKIT	110	SCVS12	69
K4-R-DC	89	N4F8-SS	51	P-3E-SKIT	171	SCVS16	69
K4-Y-DC	89	N4M3	53	P-3H-SKIT	78	SCVS24	69
K6BF6	88	N4M3-B	53	P-3V-SKIT	110	SCVS3	69
K6BF6-SS	88	N4M4	53	P-4EA-SKIT	173	SCVS4	69
K6F6	88	N4M4-B	53	P-4E-SKIT	171	SCVS6	69
K6F6-SS	88	N4M4-B-LS	53	P4F3	58	SCVS8	69
K60F6	88	N4M4-LS	53	P4F4	58	SCVX12	69
K8BF8	88	N4M6	53	P4F4-B	58	SHD2F1	43
K8BF8-SS	88	N4M6-B	53	P4F6	58	SHD2F2	43
K8F8	88	N4M6-B-LS	53	P4F6-9	58	SHD2M1	43
K8F8-SS	88	N4M6-LS	53	P4F6-B	58	SHD2M2	43
K80F8	88	N4M6-S	53	P4F6-S	58	SHD2S2	44
L2F2	45	N4M6-S-LS	53	P4F8	58	SHD2S3	44
L2M2	46	N4M6-SS	53	P4F8-B	58	SHD4F3	43
M2B2	38	N4M6-ZLS	52	P-4H-SKIT	78	SHD4M3	43
M2F2	36	N4M8	53	P4M3	59	SHD4M4	43
M2F2-B	36	N4M8-B	53	P4M4	59	SHD4S3	44
M2F3	36	N4M8-SS	53	P4M4-B	59	SHD4S4	44
M2M1	37	N4S3	54	P4M6	59	ST16BF12	133
M2M2	37	N4S3-B	54	P4M6-9	59	ST16BF16	133
M2M2-B	37	N4S4	54	P4M6-B	59	ST16DC-A	133
M2M3	37	N4S4-B	54	P4M6-S	59	ST16F12	133
M2S2	38	N4S4-B-LS	55	P4M8	59	ST16F16	133
M2S3	38	N4S4-B-LS-WF	55	P4M8-B	59	ST16F16-SS	133
M3F3	36	N4S4-B-WF	55	P-4V-SKIT	110	ST160F12	133
M3M3	37	N4S4-LS	55	P-6E-SKIT	171	ST160F16	133
M3S3	38	N4S4-LS-WF	55	P-6H-SKIT	78	ST16-SKIT	134
N3BM4	53	N4S4-WF	55	P-6V-SKIT	110	ST2BF2	132
N3CS4	54	N4S6	54	P-8E-SKIT	171	ST2BF2-SS	132
N3M4	53	N4S6-B	54	P-8H-SKIT	78	ST2DC-A	133
N4BF3	51	N4S6-B-LS	55	P-8V-SKIT	110	ST2F2	132
N4BF4	51	N4S6-B-LS-WF	55	PD1F1	135	ST2F2-SS	132
N4BF4-B	51	N4S6-B-WF	55	PD1F2	135	ST2-SKIT	134
N4BF6	51	N4S6-LS	55	PD1M1	136	ST3BF3	132
N4BF6-B	51	N4S6-LS-WF	55	PD1M2	136	ST3BF3-SS	132
N4BF8	51	N4S6-S	54	PD1OM2	136	ST3BF4	132
N4BF8-B	51	N4S6-S-LS	55	PD1OM3	136	ST3BF4-SS	132
N4BM3	53	N4S6-SS	54	SCVH10	69	ST3DC-A	133
N4BM4	53	N4S6-S-WF	55	SCVH12	69	ST3F2	132
N4BM4-B	53	N4S6-WF	55	SCVH16	69	ST3F3	132
N4BM4-LS	53	N4S6-ZLS	55	SCVH24	69	ST3F3-SS	132
N4BM6	53	N4S8	54	SCVH6	69	ST3F4	132
N4BM6-B	53	N4S8-B	54	SCVH8	69	ST3F4-SS	132
N4BM6-LS	53	N4S8-S	54	SCVJ6	69	ST3-SKIT	134
N4BM8	53	N4S8-SS	54	SCVL10	69	ST4BF4	132
N4BM8-B	53	NK2BF2	61	SCVL12	69	ST4BF4-SS	132
N4DC	56	NK2BM2	62	SCVL16	69	ST4DC-A	133
N4DC-B	56	NK2F2	61	SCVL2	69	ST4F4	132
N4F3	51	NK2M2	62	SCVL24	69	ST4F4-SS	132
N4F3-B	51	NK2S2	62	SCVL3	69	ST40F4	132
N4F4	51	P-10E-SKIT	171	SCVL6	69	ST4-SKIT	134
N4F4-B	51	P-10-SKIT	78	SCVL8	69	ST6BF6	132
N4F4-B-LS	51	P-10V-SKIT	110	SCVM10	69	ST6BF6-SS	132
N4F6	51	P-12E-SKIT	171	SCVM12	69	ST6DC-A	133
N4F6-B	51	P-12H-SKIT	78	SCVM16	69	ST6F6	132
N4F6-B-LS	51	P-12V-SKIT	110	SCVM3	69		

Alpha Numeric Product Index

Part #	Page #	Part #	Page #	Part #	Page #	Part #	Page #
ST6F6-SS.....	132	V12DC-A.....	109	V3-BRKIT.....	111	V6M6-B-E.....	108
ST6OF6.....	132	V12F12.....	101	V3DC-A.....	109	V6M6-E.....	108
ST6-SKIT.....	134	V12F12-B.....	101	V3F3.....	99	V6M6-SS.....	103
ST8BF10.....	132	V12F12-B-E.....	106	V3F3-B.....	99	V6M6-SS-E.....	108
ST8BF10-SS.....	132	V12F12-E.....	106	V3F3-B-E.....	106	V6OF6.....	99
ST8BF8.....	132	V12F12-SS.....	101	V3F3-E.....	106	V6-RKIT.....	111
ST8BF8-SS.....	132	V12F12-SS-E.....	106	V3F3-SS.....	99	V6-SSRKIT.....	111
ST8BF8-V2.....	133	V12M12.....	103	V3F3-SS-E.....	106	V8BF8.....	99
ST8DC-A.....	133	V12M12-B.....	103	V3F4.....	99	V8BF8-B.....	99
ST8DC-A-V2.....	133	V12M12-E.....	108	V3JM3.....	104	V8BF8-B-E.....	106
ST8F10.....	132	V12M12-SS.....	103	V3M3.....	103	V8BF8-E.....	106
ST8F10-SS.....	132	V12M12-SS-E.....	108	V3M3-B.....	103	V8BF8-SS.....	99
ST8F10-V2.....	133	V12OF12.....	101	V3M3-B-E.....	108	V8BF8-SS-E.....	106
ST8F8.....	132	V16BF16.....	101	V3M3-E.....	108	V8-BRKIT.....	111
ST8F8-SS.....	132	V16BF16-B.....	101	V3M3-SS.....	103	V8DC-A.....	109
ST8F8-V2.....	133	V16BF16-SS.....	101	V3M3-SS-E.....	108	V8F8.....	99
ST8OF10.....	132	V16DC-A.....	109	V3OF3.....	99	V8F8-B.....	99
ST8OF8.....	132	V16F16.....	101	V3-RKIT.....	111	V8F8-B-E.....	106
ST8-SKIT.....	134	V16F16-B.....	101	V3-SSRKIT.....	111	V8F8-E.....	106
T2DC.....	159	V16F16-B-E.....	106	V4BF4.....	99	V8F8-SS.....	99
T2F2.....	158	V16F16-E.....	106	V4BF4-B.....	99	V8F8-SS-E.....	106
T3DC.....	159	V16F16-SS.....	101	V4BF4-B-E.....	106	V8JM8.....	104
T3F3.....	158	V16F16-SS-E.....	106	V4BF4-E.....	106	V8M8.....	103
T3F3-PV.....	159	V16M16.....	103	V4BF4-SS.....	99	V8M8-B.....	103
T3F3-SS.....	158	V16M16-B.....	103	V4BF4-SS-E.....	106	V8M8-B-E.....	108
T3F3-SS-PV.....	159	V16M16-E.....	108	V4-BRKIT.....	111	V8M8-E.....	108
TD4.5DC-A.....	165	V16M16-SS.....	103	V4DC-A.....	109	V8M8-SS.....	103
TD4DC-A.....	165	V16M16-SS-E.....	108	V4F4.....	99	V8M8-SS-E.....	108
TD4F4-SS.....	165	V2BF2.....	99	V4F4-B.....	99	V8OF8.....	99
TD4PF4.5-SS.....	165	V2BF2-B.....	99	V4F4-B-E.....	106	V8-RKIT.....	111
TR3BF3.....	113	V2BF2-B-E.....	106	V4F4-E.....	106	V8-SSRKIT.....	111
TR3F3.....	113	V2BF2-E.....	106	V4F4-SS.....	99	VEP10BF10.....	139
TR4BF4.....	113	V2BF2-SS.....	99	V4F4-SS-E.....	106	VEP10DC-A.....	141
TR4F4.....	113	V2BF2-SS-E.....	106	V4F6.....	99	VEP10F10.....	139
TR6BF6.....	113	V2-BRKIT.....	111	V4JM4.....	104	VEP10F10-BOP.....	143
TR6F6.....	113	V2DC.....	108	V4M4.....	103	VEP10FH10.....	140
TR8BF8.....	113	V2DC-A.....	109	V4M4-B.....	103	VEP10FP10.....	140
TR8F8.....	113	V2F1.....	99	V4M4-B-E.....	108	VEP10OF10.....	139
V10BF10.....	101	V2F2.....	99	V4M4-E.....	108	VEP12BF12.....	139
V10BF10-B.....	101	V2F2-B.....	99	V4M4-SS.....	103	VEP12DC-A.....	141
V10BF10-B-E.....	106	V2F2-B-E.....	106	V4M4-SS-E.....	108	VEP12F12.....	139
V10BF10-E.....	106	V2F2-E.....	106	V4OF4.....	99	VEP12F12-BOP.....	143
V10BF10-SS.....	101	V2F2-SS.....	99	V4-RKIT.....	111	VEP12FH12.....	140
V10BF10-SS-E.....	106	V2F2-SS-E.....	106	V4-SSRKIT.....	111	VEP12FP12.....	140
V10DC-A.....	109	V2JM2.....	104	V6BF6.....	99	VEP12OF12.....	139
V10F10.....	101	V2M1.....	103	V6BF6-B.....	99	VEP16BF16.....	139
V10F10-B.....	101	V2M2.....	103	V6BF6-B-E.....	106	VEP16DC-A.....	141
V10F10-B-E.....	106	V2M2-B.....	103	V6BF6-E.....	106	VEP16F16.....	139
V10F10-E.....	106	V2M2-B-E.....	108	V6BF6-SS.....	99	VEP16OF16.....	139
V10F10-SS.....	101	V2M2-E.....	108	V6BF6-SS-E.....	106	VEP2BF2.....	139
V10F10-SS-E.....	106	V2M2-SS.....	103	V6-BRKIT.....	111	VEP2DC-A.....	141
V10JM10.....	104	V2M2-SS-E.....	108	V6DC-A.....	109	VEP2F2.....	139
V10M10.....	103	V2OF2.....	99	V6F6.....	99	VEP2OF3.....	139
V10M10-B.....	103	V2-RKIT.....	111	V6F6-B.....	99	VEP3BF3.....	139
V10M10-E.....	108	V2-SSRKIT.....	111	V6F6-B-E.....	106	VEP3BF4.....	139
V10M10-SS.....	103	V3BF3.....	99	V6F6-E.....	106	VEP3DC-A.....	141
V10M10-SS-E.....	108	V3BF3-B.....	99	V6F6-SS.....	99	VEP3F3.....	139
V10OF10.....	101	V3BF3-B-E.....	106	V6F6-SS-E.....	106	VEP3F3-BOP.....	143
V12BF12.....	101	V3BF3-E.....	106	V6JM6.....	104	VEP3F4.....	139
V12BF12-B.....	101	V3BF3-SS.....	99	V6M6.....	103	VEP3F4-BOP.....	143
V12BF12-SS.....	101	V3BF3-SS-E.....	106	V6M6-B.....	103	VEP3OF4.....	139

Part #	Page #	Part #	Page #	Part #	Page #	Part #	Page #
VEP4BF4.....	139	WS100F10.....	151				
VEP4BF6.....	139	WS12BF12.....	151				
VEP4DC-A.....	141	WS12BF12-SS.....	151				
VEP4F4.....	139	WS12DC-A.....	153				
VEP4F4-BOP.....	143	WS12F12.....	151				
VEP4F6.....	139	WS12F12-BOP.....	156				
VEP4OF4.....	139	WS12F12-SS.....	151				
VEP4OF5.....	139	WS12F12-SS-BOP.....	156				
VEP4OF6.....	139	WS12FH12.....	152				
VEP6BF6.....	139	WS12FP12.....	152				
VEP6DC-A.....	141	WS120F12.....	151				
VEP6F6.....	139	WS16BF16.....	151				
VEP6F6-BOP.....	143	WS16BF16-SS.....	151				
VEP6FH6.....	140	WS16DC-A.....	153				
VEP6FP6.....	140	WS16F16.....	151				
VEP6OF6.....	139	WS16F16-BOP.....	156				
VEP8BF8.....	139	WS16F16-SS.....	151				
VEP8DC-A.....	141	WS16F16-SS-BOP.....	156				
VEP8F8.....	139	WS16FH16.....	152				
VEP8F8-BOP.....	143	WS16FP16.....	152				
VEP8F8-SS.....	139	WS160F16.....	151				
VEP8FH8.....	140	WS6BF6.....	151				
VEP8FP8.....	140	WS6BF6-SS.....	151				
VEP8OF8.....	139	WS6DC-A.....	153				
W10BF10-B.....	147	WS6F4.....	151				
W10-BMF.....	147	WS6F4-BOP.....	156				
W10DC.....	148	WS6F6.....	151				
W10F10-B.....	147	WS6F6-BOP.....	156				
W10-RKIT-V2.....	148	WS6F6-SS.....	151				
W12BF12-B.....	147	WS6F6-SS-BOP.....	156				
W12-BMF.....	147	WS6FH6.....	152				
W12DC.....	148	WS6FP6.....	152				
W12F12-B.....	147	WS60F6.....	151				
W12-RKIT-V2.....	148	WS8BF8.....	151				
W2DC.....	148	WS8BF8-SS.....	151				
W2F1-B.....	147	WS8DC-A.....	153				
W3DC.....	148	WS8F8.....	151				
W3F2-B.....	147	WS8F8-BOP.....	156				
W3F3-B.....	147	WS8F8-SS.....	151				
W6BF4-B.....	147	WS8F8-SS-BOP.....	156				
W6BF6-B.....	147	WS8FH8.....	152				
W6-BMF.....	147	WS8FP8.....	152				
W6DC.....	148	WS8OF8.....	151				
W6F4-B.....	147	XK3F3.....	128				
W6F6-B.....	147						
W6-RKIT-V2.....	148						
W8BF8-B.....	147						
W8-BMF.....	147						
W8DC.....	148						
W8F8.....	147						
W8F8-B.....	147						
W8-RKIT-V2.....	148						
WS10BF10.....	151						
WS10BF10-SS.....	151						
WS10DC-A.....	153						
WS10F10.....	151						
WS10F10-BOP.....	156						
WS10F10-SS.....	151						
WS10F10-SS-BOP.....	156						
WS10FH10.....	152						
WS10FP10.....	152						

Glossary of Terms

Absolute Pressure: The sum of gauge and atmospheric pressure.

Accidental Disconnection: Disconnection of a coupling while in operation due to failure of the coupling mechanism (a.k.a. unintentional disconnection).

Accumulator: A container in which fluid is stored under pressure as a source of reserve fluid power.

Aeration: Air in a fluid.

Air Inclusion: The air forced into the system during the connection of a quick disconnect coupling.

Atmospheric Pressure: Pressure exerted by the atmosphere at any specific location. Sea level pressure is approximately 14.7 PSI.

Backpressure: Refers to pressure existing on the discharge side of a system.

Bar: An international standard unit of pressure equal to 100,000 Pascals, approximately 14.5 PSI.

Blind-Mate: A coupling that can be automatically connected without human intervention and without visibility.

Break-Away: Automatic disconnection of a coupling when an axial separation force is applied.

Brinelling: Dimples or grooves worn into the shoulder of a male half by locking balls in the female half. This is terminology stemming from a test that is done to evaluate the hardness of metals. Swedish metallurgist, Johan August Brinell (1849-1925), developed a hardness test that measured the relative hardness of metals and alloys by forcing a 10 mm hard steel ball into a test piece with a 3,000 kg load for 30 seconds. After completion of the test, the surface area of the resulting indentation was measured.

Burst Pressure: The pressure at which a device loses the capability to retain pressure.

Case Hardening: Hardening the entire surface of a low carbon steel to a specific depth.

Cavitation: A localized gaseous condition within a liquid stream which occurs where the pressure is reduced to the vapor pressure.

Charge Pressure: The pressure at which replenishing fluid is forced into the hydraulic system (above atmospheric pressure).

Check Valve: A valve which permits flow of media in one direction only.

Cold Flow: Continued deformation under load.

Connect Under Pressure: The ability to connect coupling halves with internal line pressure applied to either both sides or one side.

Contamination: Any material foreign to a media that has a harmful effect on its performance in a system.

Coupling, Female Half: a.k.a. coupler, socket, receiver.

Coupling, Male Half: a.k.a. nipple, plug, adapter.

Coupling, Quick Disconnect: A component that can quickly join or separate a fluid line without the use of tools or special devices.

Differential Pressure: (DP) The difference in pressure between any two points of a system or a component, also known as Delta-P or pressure drop.

Drybreak Coupling: A coupling that allows connection and disconnection without spillage or air inclusion (a.k.a. flushface, flat face, no-spill.)

Double-Acting Sleeve: Permits push-to-connect and pull-to-connect convenience when female half is mounted on the sleeve.

Dust Cap: Dust or dirt repelling enclosure for the plug.

Dust Plug: Dust or dirt repelling enclosure for the coupler.

Dynamic Pressure: Pressure that, once it is released, is able to be immediately replenished.

Flow Checking: Occurs when a valve closes during flow conditions, such as when quickly lowering a heavy implement (a.k.a. check off, back checking, lock-up).

Flush Position (valve): A no-spill valve that allows connection and disconnection without spillage or air inclusion. (a.k.a. flushface, drybreak, no-spill).

Force to Connect: Axial and/or rotational force required to make a complete connection.

Force to Disconnect: The reverse of the above.

GPM: Acronym for gallons per minute, a measure of flow.

Leakage: The media that is unintentionally released from a coupling due to component failure or retention weaknesses.

LPM: Acronym for liters per minute, a measure of flow.

Induction Hardening: Hardening of a localized area of medium or high carbon steel.

Operating Pressure: The pressure at which a system is operated (a.k.a. working pressure).

Peak Pressure: Maximum momentary pressure encountered in the operation of a component (a.k.a. pressure spike, surge pressure.)

Pressure Cap: A cap that incorporates a seal capable of withstanding the rated pressures on the male half.

Pressure Impulse Test: Subjecting a component to a specified pressure at a specific rate of increase or decrease for a specified time limit and cycle.

Proof Pressure: The nondestructive test pressure in excess of the maximum rated operating pressure, generally 1.5 times the standard operating pressure.

PSI: Acronym for pounds per square inch, a measure of pressure.

Push to Connect: Locking arrangement that permits one-handed connection by pushing the plug into the coupler (a.k.a. automatic sleeve, automatic collar, automatic connection).

Rotation: The act of spinning the coupler and plug in opposite directions in a continuous manner beyond 360°.

Single Acting Sleeve: Making connection requires manually pulling female sleeve back, inserting the male tip (a.k.a. semi-auto sleeve, manual sleeve)

Sleeve Lock: A coupling arrangement that provides an additional lock that must be actuated before locking sleeve can be retracted (a.k.a. pin-lock, locking sleeve).

Spillage: The fluid released from the system due to disconnection of a quick disconnect coupling. This is the fluid trapped between the mating seal and the valve seal of the coupling halves.

Static Pressure: Pressure that, once released, is not able to be immediately replenished.

Surge Flow: A rapid increase in fluid flow.

Swivel: The act of spinning the coupler and plug in opposite directions to a degree that is less than 360°.

Thermal Build-Up: Pressure caused by expansion of a media due to heat from an external source such as sunlight (a.k.a. thermal expansion).

Trapped Pressure: Pressurized fluid trapped behind a closed coupling valve.

Turbulence: Is the condition where the media does not move smoothly parallel to the flow direction. Turbulent flow is caused by abrupt changes in direction, changes of cross-section, or by high velocity. The result is increased friction, which generates heat, decreases operating pressure, and wastes power.

Twist Lock: A locking arrangement that requires a rotational actuation to unlock the mating halves.

Vacuum: Partially or completely exhausted of air, gas, or other media to create a negative pressure. Theoretically, a perfect vacuum would be measured as 30 inches of mercury, but that is unattainable. The true perfect vacuum is 29.7 inches of mercury.

F - 4 H F 4 - B - E - LS - 7

Body Size

1	1/8"
1.25	4mm
1.5	3/16"
1.88	6mm
2	1/4"
2.5	5/16"
2.83	9mm
3	3/8"
4	1/2"
5	5/8"
6	3/4"
8	1"
10	1-1/4"
12	1-1/2"
16	2"
20	2-1/2"
24	3"

End Size

1	1/8"
1.25	4mm
1.5	3/16"
1.88	6mm
2	1/4"
2.5	5/16"
2.83	9mm
3	3/8"
4	1/2"
5	5/8"
6	3/4"
8	1"
10	1-1/4"
12	1-1/2"
16	2"
20	2-1/2"
24	3"

Materials

S	303 stainless steel
SS	316 stainless steel
A	aluminum
B	brass

Standard material is steel.
No designation is necessary for standard steel configurations.

Valve Options

SSV	316 SS valve
SV	303 SS valve
BTV	Brass tube valve
BV	Brass valve
E	Unvalved (no valve)
HV	Heavy-duty valve
PV	Poppet valve
RV	Prong valve
TV	Tube valve
V	Valved
VA	Valve actuator

Seals

H	Aflas™
C	Celazole back-up
CZ	Chemrez
P	EPDM
PS	EPDM (steam)
D	FDA FKM
F	FKM
FS	Fluorosilicone
JF	Hydrocarbon fuel nitrile
K4	Kalrez® 4079
K6	Kalrez® 6375
K7	Kalrez® 7075
M	Military low temp nitrile
E	Neoprene
M1	Nitrile (FDA)
T	PTFE
TS	PTFE / silicone
S	Silicone
U	Urethane

Standard seal is nitrile. No designation is necessary for standard nitrile seal configurations.

Product Series

T	10K Threaded
AG	Agricultural Interchange Hydraulic
M	ARO 210/310 Interchange
J	Automotive Interchange
N	Bowes Interchange
A	Compact
CJ	European High Flow Interchange
CVV	European Screw Together
ST	Heavy-Duty Flushface
WS	Heavy-Duty Wingstyle
WS-BOP	Heavy-Duty Wingstyle Blow Out Preventer
TD	High Pressure Couplings
DF	Industrial Interchange Pneumatic
HTZ	ISO16028 Connect Under Pressure Coupler
HTE	ISO16028 Connect Under Pressure Plug
HT	ISO16028 Flushface Interchange
K	ISO-A Mobile Interchange
H	ISO-B Industrial Interchange
HS	ISO-B Steam Interchange
NK	Japanese Industrial Interchange
L	Lincoln Long-Stem Interchange
V	MIL-C-51234
CM	Mold Coolant Interchange
SHD	Rectus 17/Schrader Interchange
BR	Rectus 21 Interchange
SCV	Safety Check Valve
E	Straight-Through Pressure Wash Interchange
EA	Straight-Through Water-Blast Interchange
TR	TEMA European Interchange
P	Thor Interchange
U	Universal Pneumatic Combo-Couplers
VEP-BOP	VEP Blow out Preventer Interchange
VEP	VEP Hydraulic Interchange
W	Wingstyle Interchange
XK	10K Flushface

End Connection

4B	45° Push-loc barb
4S	45° hose barb
9B	90° Push-loc barb
9S	90° hose barb
RB	Bulkhead ORFS
FH	Code 62 flange head
FP	Code 62 flange pad
CS	Collar hose barb
JF	Female 37° JIC
BF	Female BSPP
FM	Female metric
PF	Female MP threads
F	Female NPT(F)
OF	Female ORB
S	Hose barb
JM	Male 37° JIC
GM	Male BSPP
BM	Male BSPT
JB	Male bulkhead 37° JIC
MM	Male metric
M	Male NPT(F)
OM	Male ORB
RM	Male ORFS
MBM	Metric bulkhead
B	Push-loc barb
P	Tube fitting

Sleeve Options

HNS	303 SS hex nut sleeve
XLS	303 SS locking sleeve
XS	303 SS sleeve
YLS	316 SS locking sleeve
YS	316 SS sleeve
PB	Automatic ball latch
PL	Automatic latch pin
BFS	Brass flanged sleeve
BLS	Brass locking sleeve
BS	Brass sleeve
FLS	Flanged locking sleeve
FNS	Flanged nylon sleeve
FS	Flanged sleeve
HN	Hex nut sleeve
LS	Locking sleeve
NLS	No locking sleeve
FSB	Silicone fryer boot
ZFS	Steel flanged sleeve
ZLS	Steel locking sleeve
ZS	Steel sleeve
TP	Tangle prevention

Other Options

4	Black oxide plating
7	Bright nickel plating
11	Chrome over nickel
8	Electroless nickel plating
HL	Extended hex
BMF	Flange mount bracket
L##	Length
C1	Oxygen clean
9	PTFE coating
10	Standard nickel plating
WF	Wrench flats

To Designate Couplers
Body size numerical designation precedes coupling series alpha designation.
Example: 2HF2 (1/4" ISO-B Coupler)

To Designate Plugs
Coupling series alpha designation precedes body size numerical designation.
Example: H2F2 (1/4" ISO-B Plug)

Aflas™ is a trademark of Asahi Glass Limited
Kalrez® is a trademark of Dupont Polymers, Inc.
Teflon® is a trademark of The Chemours Company FC, LLC
Viton® is a trademark of The Chemours Company FC, LLC

! Many variations of the part numbers contained within this guide can be ordered utilizing the format shown above. However, some variations may require minimum order quantities, longer lead times, and/or price adjustments based upon the uniqueness of construction. Please contact your Dixon Quick Coupling representative for details regarding your particular coupling configuration.

Limited Warranty

DIXON VALVE AND COUPLING COMPANY, LLC (herein called "Dixon") warrants the products described herein and manufactured by Dixon to be free from defects in material and workmanship for a period of one (1) year from date of shipment by Dixon under normal use and service. Its sole obligation under this warranty being limited to repairing or replacing, as hereinafter provided, at its option any product found to Dixon's satisfaction to be defective upon examination by it, provided that such product shall be returned for inspection to Dixon's factory within three (3) months after discovery of the defect. The repair or replacement of defective products will be made without charge for parts or labor. This warranty shall not apply to: (a) parts or products not manufactured by Dixon, the warranty of such items being limited to the actual warranty extended to Dixon by its supplier; (b) any product that has been subject to abuse, negligence, accident, or misapplication; (c) any product altered or repaired by others than Dixon; and (d) to normal maintenance services and the replacement of service items (such as washers, gaskets, and lubricants) made in connection with such services. To the extent permitted by law, this limited warranty shall extend only to the buyer and any other person reasonably expected to use or consume the goods who is injured in person by any breach of the warranty. No action may be brought against Dixon for an alleged breach of warranty unless such action is instituted within one (1) year from the date the cause of action accrues. This limited warranty shall be construed and enforced to the fullest extent allowable by applicable law.

Other than the obligation of Dixon set forth herein, Dixon disclaims all warranties, express or implied, including but not limited to any implied warranties of merchantability or fitness for a particular purpose, and any other obligation or liability. The foregoing constitutes Dixon's sole obligation with respect to damages, whether direct, incidental, or consequential, resulting from the use or performance of the product.

Some products and sizes may be discontinued when stock is depleted or may require a minimum quantity for ordering.

Limits of Liability

This catalog is intended as a product offering. It is not intended to be a user or technical manual. Information in this catalog is subject to change without notice. All users and distributors of products sold through this catalog should contact Dixon with questions of use, compatibilities, coupling procedures, and life of product. Our full-time engineering and test staff are always available to recommend uses and to assist distributors and users with any questions.



Safety



Safety logos, which appear throughout our catalog, are used as a reminder that the user should carefully review for the appropriateness of the product for the media, application, and environment in which it will be used.

NOTE: Because of the health hazards associated with contamination and lead content in drinking water systems, Dixon couplings, unless otherwise specifically approved, are not recommended for potable water service and should not be used in applications where drinking water will contact the wetted surfaces of the coupling.

Warning: Dixon products may contain chemicals known to the State of California to cause cancer, birth defects, or other reproductive harm.



Trademarks

Delrin® and Zytel® are registered trademarks of E.I. duPont Nemours and Company.

Kalrez® is a registered trademark of DuPont Dow Elastomers.

All other trademarks appearing in the Dixon illustrated price list are the property of their respective owners.

Copyright

Copyright © 2021 by Dixon Valve and Coupling, LLC

All rights reserved. This book is copyrighted material. Use, reproduction or copying of it by anyone other than Dixon® is strictly forbidden without its express written consent.

NOTE: Reasonable care has been taken in preparing this catalog. Dixon Valve & Coupling Company, LLC reserves the right to make corrections.

