

# Emhart Aftermarket Products



## HeliCoil

Thread Repair Inserts



## POP<sup>®</sup>

Blind Rivets and Tools



## DRILL-OUT<sup>®</sup>

Broken Bolt & Stud Extractors

## Chase'em Back<sup>™</sup>

Stud Repair Sets



# Emhart Aftermarket Products

## Heli-Coil

Did you know...

Indy and NASCAR racing teams use Heli-Coil inserts.

A Boeing 747 has 250,000 Heli-Coil inserts as original equipment

There are 250,000 Heli-Coil inserts in every space shuttle.

### Why?

All the above use lightweight, exotic materials and need strong threads.

### What does this mean to you?

Today's cars are also made of light materials, such as aluminum, and tapped hole damage is a common occurrence. Stripping during removal of seized bolts, cross-threading and wear from constant assembly and disassembly and corrosion can also cause thread damage. For these reasons companies like General Motors, Ford, Chrysler, Boeing, Pratt & Whitney, McDonnell-Douglas, NASA, Harley-Davidson, Caterpillar, Cummins, General Electric, Rolls-Royce, BMW, Porsche and many more, including the military, all use Heli-Coil inserts as original equipment in critical threaded areas of parts made of lightweight materials. They have found that the use of Heli-Coil inserts gives them a stronger and more reusable thread that resists the effects of corrosion.

The inserts offered in all of our Heli-Coil Thread Repair Kits are made of the same high quality stainless steel as the inserts used by these companies. The same technology that took us to the moon is available to fix the damaged threads on your car, truck, motorcycle, boat; anywhere they happen. This repair is better than the original thread. It is quick, easy, permanent and in almost all cases less expensive than replacing the part.

## POP

POP Blind Rivets are available in a variety of sizes, types and materials combined with dome, countersunk or large-flange head styles. This makes POP blind rivets ideal for a wide range of riveting applications. They are the most popular rivets for automotive use. Also available from POP are Sheet Metal Inserts, a general purpose threaded insert with exceptionally strong torque-out and pull-out characteristics, POP Plastic Rivets, a one-piece, all-plastic expansion rivet, POP WELL-NUT Threaded Inserts, a flanged rubber bushing with brass threads molded into one end, and a variety of manual and power tools.

## Drill-Out

Drill-Out is a drill bit and extractor in one. The drill bit is made from high quality tool steel that has been hardened and tempered giving it the ability to even drill into Grade 8 and stainless steel bolts. The extractor is made from hard, flexible die steel which allows it to bite into any bolt or stud without slipping or stripping.

## Chase 'em Back™

The unique, patented hinge design of Chase 'em Back allows for the repair of damaged or corroded threads on most studs by attaching to the undamaged threads and working back through the damaged areas. Made from heat-treated steel, sets are available for the most common inch and metric thread sizes. Other sets include the 8-piece Sav-A-Stud Plus™ set for wheel stud repair and the 20-piece Spindle-Saver™ set for front wheel drive spindle repair.

---

HELI-COIL

POP

DRILL-OUT

CHASE 'EM BACK

# Product Portfolio

**Heli-Coil** Products are manufactured to the same exacting quality systems required by the military, aerospace and automotive standards. The Danbury manufacturing facility has been certified ISO 9001 and QS 9000. We are committed to an ongoing and never ending process of quality improvement and total customer satisfaction.

**Heli-Coil®** – the most effective and universally accepted method of thread repair. Restores damaged threads to better than new condition. Available in a range of inch and metric thread sizes.

## Heli-Coil Product Assortment

- Thread Kits
  - Inch & Metric
- Master Thread Repair Sets
  - Inch
  - Metric
  - Spark Plug
  - Sav-A-Thread
- Special Application Kits
  - Oxygen Sensor
  - Motorcycle
  - Pipe Thread
  - Recessed Spark Plug
- Packaged Inserts
- Bulk Inserts
- Point-of-Purchase Displays
- Drill-Out
  - Kits
  - Sets
  - Displays

**POP®** Blind Rivet Systems – a high tech fastening system. Ideal for structural repairs, body and collision work and more. Rivets are available in various materials, types, sizes and styles for all types of fastening.

## POP Product Assortment

- Point-of-Purchase Displays
- Bulk Rivets Assortments
  - 100 Piece Box
  - 500 Piece Box
- Thrift Packs
- Nosepieces & Jaws
- Rivetools
  - Manual
  - Power
- Plastic Rivets
- Sheet Metal Inserts
- WELL-NUT Inserts

**Drill-Out®** – a drill bit and extractor in one. The drill bit is made from high quality tool steel that has been hardened and tempered giving it the ability to even drill into Grade 8 steel bolts. The extractor is made from hard, flexible die steel which allows it to bite into any bolt or stud without slipping or stripping.

## Drill-Out Product Assortment

- Point-of-Purchase Displays
- 4-Piece Kits
- Individual tools

## Chase 'em Back™

Four different sets available for common stud repair applications.

- Chase 'em Back
- Sav-A-Stud Plus
- Sav-A-Stud Plus-HD
- Spindle Saver

## Orders & Inquiries

To inquire further about Emhart Aftermarket Products or to place an order, contact us at:

### Shelton, CT

**Telephone: (203) 924-4722**

**Fax: (800) 732-3116**

### Irvine, CA

**Telephone: (949) 851-2099**

**Fax: (949) 851-2099**

### Canada

**Telephone: (514) 351-0300**

**Fax: (514) 351-0458**

**[www.emhart.com](http://www.emhart.com)**

# Table of Contents



Heli-Coil Introduction .....5

Inch Thread Repair Kits .....6

Metric Thread Repair Kits .....7

Master Thread Repair Sets – Inch & Metric .....8

Spark Plug & Sav-A-Thread Master Sets .....9

Special Applications .....10

    Oxygen Sensor, Motorcycle, Pipe Thread,  
    Sav-A-Thread Quick Repair

Application Guide .....11

Packaged Inserts & Tooling .....12

Bulk Inserts – Inch, Metric, Pipe Thread, Spark Plug,  
    Sav-A-Thread .....13

Heli-Coil Point-of-Purchase Displays .....14

Drill-Out .....15

Stud Repair Sets .....16

    Chase 'em Back, Sav-A-Stud Plus, Spindle Saver

POP Rivet Introduction .....17

Rivet Ordering Information .....18, 19

POP Point-of-Purchase Displays .....20

Thrift Packs, PowerLink 30, Custom Rivets .....21

Manual & Power Rivetools .....22

Selection Guides – Manual Tool, Power Tool,  
    Interchangeable Nosepieces, Replacement Jaws .....23

Plastic Rivets .....24

Sheet Metal .....25

Well-Nut .....26



# The Heli-Coil Thread Repair System

Heli-Coil has the most effective and universally accepted method of thread repair. Heli-Coil inserts quickly and permanently restore **stripped, worn or damaged threads** to their original size and condition.

The inserts work in any part or material; **aluminum, magnesium, cast iron, bronze**, etc. The use of light weight (and soft) materials in fuel efficient cars means more thread damage...there is a Heli-Coil insert to repair virtually every application.

Damaged threads can be restored to better than new condition in spark plug ports, carburetor fuel inlets, transmission housings, oil drain plugs, exhaust and intake manifolds, head

bolt holes, brake calipers and more! The Heli-Coil system makes all other thread repair methods obsolete: welding, plugging, oversized fasteners and oversized drilling of mating parts. It's faster – you save time, increase your shop's repair capabilities and restore parts that otherwise would have to be scrapped.



Heli-Coil repairs are available in the following standard thread series and size ranges: **Inch Coarse** (#8 thru 1-1/2), **Inch Fine** (#10 thru 1-1/2), **Metric Coarse** (M3 thru M20), **Metric Fine** (M8 thru M18), **Spark Plug** (10mm, 12mm, 14mm, 18mm & 7/8"), and **Pipe Thread** (1/8" thru 1").

In addition to the above, custom sizes are available for various repairs.

## Heli-Coil Stainless Steel Inserts

Heli-Coil inserts are precision formed coils of extremely hard stainless steel (18-8) diamond shaped wire. When installed into a Heli-Coil tapped hole, the insert provides permanent conventional screw threads. The insert has a driving "tang" for installation which is notched for easy removal.

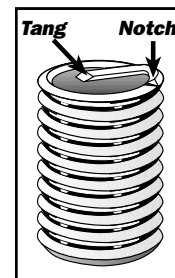

## The Retention Principle

Heli-Coil inserts are larger in diameter before installation than the tapped hole. During installation, the inserting tool reduces the diameter of the leading coil so it can enter the tapped hole. After the installation, each high tensile stainless steel coil expands outward against the tapped hole to permanently anchor the insert.

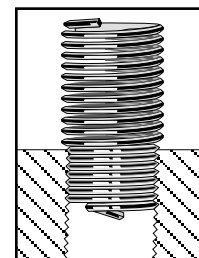

## Installation

### Drill

Drill out the damaged threads using the drill size specified on the kit or set. Drill to sufficient depth to accommodate the insert length and bolt or screw being used.



### Install

Use the installation tool supplied in the kit or set. Just wind the insert into the hole until the top coil is 1/4 - 1/2 turn into the tapped thread. Now you're back to the original size and the original size fastener can be used.



### Tap

Use the Heli-Coil tap supplied in the kit or set. Check the size on the shank to make sure you have the right one. Tap the hole to sufficient depth to accommodate the insert length and bolt or screw being used.

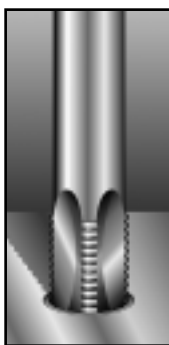

### Tang Removal

The tang must be removed to allow full passage of the bolt or screw through the insert. Place square (unchamfered) end of a punch on the tang and strike sharply. For inserts over 1/2", M14 and up, and all spark plug sizes, use long nose pliers. Holding the tang with the pliers, bend it alternately in and out until it comes free. **Note:** For **Spark Plug** repairs, **NO** drilling is necessary. The Heli-Coil spark plug kit contains a piloted reamer tap. With this tap, the damaged threads are removed and new threads are cut in one continuous operation.

## Stripped & Fixed

When threads become stripped, worn or damaged for any reason, the strength and reliability are greatly reduced. Potentially dangerous situations are eliminated when the damaged thread is repaired with Heli-Coil inserts. The Heli-Coil threaded insert provides stronger, more reliable threads than the original tapped hole and at the same time eliminates the possibility of thread wear, corrosion, galling, seizing and rust.

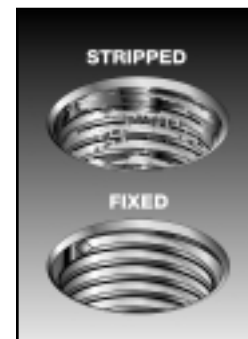

# Inch Thread Repair Kits

Heli-Coil has complete coverage of inch thread repair sizes. Available from stock are Inch Coarse kits in sizes #8 through 1-1/2" and Inch Fine kits in

sizes #10 through 1-1/2". Kits up to 3/4" are packaged in durable placon or vinyl pouches, and kits 7/8" and larger are packaged in sturdy metal cases and

contain the proper size high speed steel drill. All kits contain a Heli-Coil tap, installation tool, a quantity of inserts and detailed instructions.

<b>INCH COARSE</b>				<b>Kit Contents and Replacement Parts</b>					<b>DRILL SIZE</b>
<b>THREAD SIZE + LENGTH</b>	<b>KIT PART NO.</b>	<b>KIT PKG. TYPE</b>	<b>INSERTS PER KIT</b>	<b>TAP PART NO.</b>	<b>INSTALLATION TOOL PART NO.</b>	<b>TOOL TYPE</b>	<b>PACKAGED INSERT PART NO.</b>	<b>PACKAGED INSERT QTY.</b>	
8-32 x .246	5521-2	A	12	819-2	2288-2	2	R1185-2	12	11/64
10-24 x .285	5521-3	A	12	819-3	2288-3	2	R1185-3	12	13/64
12-24 x .324	5521-1	A	12	819-1	2288-1	2	R1185-1	12	15/64
1/4-20 x .375*	5521-4	A	12	819-4	5288-4	1	R1185-4	12	17/64
5/16-18 x .469*	5521-5	A	12	819-5	5288-5	1	R1185-5	12	21/64
3/8-16 x .562*	5521-6	A	12	819-6	5288-6	1	R1185-6	12	25/64
7/16-14 x .656*	5521-7	A	6	819-7	5288-7	1	R1185-7	6	29/64
1/2-13 x .750*	5521-8	A	6	819-8	5288-8	1	R1185-8	6	17/32
9/16-12 x .844	5521-9	B	6	819-9	2288-9	2	R1185-9	6	19/32
5/8-11 x .938	5521-10	B	6	819-10	5288-10	1	R1185-10	6	21/32
3/4-10 x 1.125	5521-12	B	4	819-12	2288-12	2	R1185-12	4	25/32
<b>THE FOLLOWING KITS COME COMPLETE WITH HIGH SPEED STEEL DRILL BIT FOR 1/2" CHUCK.</b>									
7/8-9 x 1.312	5521-14	C	6	8187-14	3724-14	2	K1185-14	1	29/32
1-8 x 1.500	5521-16	C	6	8187-16	3724-16	2	K1185-16	1	1-1/32
1-1/8-7 x 1.688	5521-18	C	5	8187-18	3724-18	2	K1185-18	1	1-5/32
1-1/4-7 x 1.875	5521-20	C	4	8187-20	3724-20	2	K1185-20	1	1-9/32
1-3/8-6 x 2.062	5521-22	C	4	8187-22	3724-22	2	K1185-22	1	1-13/32
1-1/2-6 x 2.250	5521-24	C	4	8187-24	3724-24	2	K1185-24	1	1-17/32

\*Sizes included in Master Thread Repair Set - Part No. 5621



<b>INCH FINE</b>				<b>Kit Contents and Replacement Parts</b>					<b>DRILL SIZE</b>
<b>THREAD SIZE + LENGTH</b>	<b>KIT PART NO.</b>	<b>KIT PKG. TYPE</b>	<b>INSERTS PER KIT</b>	<b>TAP PART NO.</b>	<b>INSTALLATION TOOL PART NO.</b>	<b>TOOL TYPE</b>	<b>PACKAGED INSERT PART NO.</b>	<b>PACKAGED INSERT QTY.</b>	
10-32 x .285**	5528-3	A	12	821-3	2299-3	3	R1191-3	12	13/64
1/4-28 x .375**	5528-4	A	12	821-4	2299-4	3	R1191-4	12	17/64
5/16-24 x .469**	5528-5	A	12	821-5	6299-5	3	R1191-5	12	21/64
3/8-24 x .562**	5528-6	A	12	821-6	6299-6	3	R1191-6	12	25/64
7/16-20 x .656**	5528-7	A	6	821-7	6299-7	3	R1191-7	6	29/64
1/2-20 x .750**	5528-8	A	6	821-8	6299-8	3	R1191-8	6	33/64
9/16-18 x .844	5528-9	B	6	821-9	2299-9	3	R1191-9	6	37/64
5/8-18 x .938	5528-10	B	6	821-10	2299-10	3	R1191-10	6	41/64
3/4-16 x 1.125	5528-12	B	4	821-12	2299-12	3	R1191-12	4	49/64
<b>THE FOLLOWING KITS COME COMPLETE WITH HIGH SPEED STEEL DRILL BIT FOR 1/2" CHUCK.</b>									
7/8-14 x 1.312	5528-14	C	6	8193-14	535-14	4	K1191-14	1	57/64
1-14 x 1.500	5528-16	C	6	8193-16	535-16	4	K1191-16	1	1-1/64
1-12 x 1.500	5528-161	C	6	8193-161	535-161	4	K1191-161	1	1-1/64
1-1/8-12 x 1.688	5528-18	C	5	8193-18	535-18	4	K1191-18	1	1-5/32
1-1/4-12 x 1.875	5528-20	C	4	8193-20	535-20	4	K1191-20	1	1-9/32
1-3/8-12 x 2.062	5528-22	C	4	8193-22	535-22	4	K1191-22	1	1-13/32
1-1/2-12 x 2.250	5528-24	C	4	8193-24	535-24	4	K1191-24	1	1-17/32

\*Sizes included in Master Thread Repair Set - Part No. 5621

# Metric Thread Repair Kits

Heli-Coil has all you need in metric thread repair items. Available from stock are Metric Coarse kits in sizes M3 through M20 and Metric Fine kits in

sizes M8 through M20. All Metric kits contain a Heli-Coil tap, installation tool, a quantity of inserts and complete instructions.

METRIC COARSE				Kit Contents and Replacement Parts					DRILL SIZE
THREAD SIZE + LENGTH	KIT PART NO.	KIT PKG. TYPE	INSERTS PER KIT	TAP PART NO.	INSTALLATION TOOL PART NO.	TOOL TYPE	PACKAGED INSERT PART NO.	PACKAGED INSERT QTY.	
M3x0.5 x 4.5mm	5546-3	B	12	2087-3	7751-3	5	R1084-3	12	1/8
M4x0.7 x 6.0mm	5546-4	A	12	2087-4	3747-4	3	R1084-4	12	11/64
M5x0.8 x 7.5mm*†	5546-5	A	12	570-5	3747-5	3	R1084-5	12	13/64
M6x1 x 9.0mm*†	5546-6	A	12	570-6	3747-6	3	R1084-6	12	1/4
M7x1 x 10.5mm	5546-7	A	12	570-7	3747-7	2	R1084-7	12	9/32
M8x1.25 x 12.0mm*†	5546-8	A	12	570-8	8747-8	2	R1084-8	12	21/64
M9x1.25 x 13.5mm	5546-9	A	12	570-9	8747-9	2	R1084-9	12	23/64
M10x1.5 x 15.0mm*	5546-10	A	12	570-10	8747-10	2	R1084-10	12	13/32
M11x1.5 x 16.5mm	5546-11	A	6	580-11	8747-11	3	R1084-11	6	29/64
M12x1.75 x 18.0mm	5546-12	A	6	2087-12	8747-12	2	R1084-12	6	31/64
M14x2 x 21.0mm	5546-14	B	6	2087-14	3747-14	2	R1084-14	6	37/64
M16x2 x 24.0mm	5546-16	B	6	2087-16	3747-16	2	R1084-16	6	21/32
M18x2.5 x 27.0mm	5546-18	B	6	2087-18	3747-18	2	R1084-18	6	47/64
M20x2.5 x 30.0mm	5546-20	B	4	2087-20	3747-20	2	R1084-20	4	13/16

\*Sizes included in Master Thread Repair Set - Part No. 5626-150

†Sizes included in Master Thread Repair Set - Part No. 5626-125

A - Carded B - Pouch



METRIC FINE				Kit Contents and Replacement Parts					DRILL SIZE
THREAD SIZE + LENGTH	KIT PART NO.	KIT PKG. TYPE	INSERTS PER KIT	TAP PART NO.	INSTALLATION TOOL PART NO.	TOOL TYPE	PACKAGED INSERT PART NO.	PACKAGED INSERT QTY.	
M8x1 x 12.0mm	5542-8	A	12	573-8	4835-8	3	R4255-8	12	21/64
M10x1 x 15.0mm	5542-10	A	12	573-10	4835-10	3	R4255-10	12	13/32
M11x1 x 16.5mm	5542-11	A	6	573-11	4835-11	3	R4255-11	6	7/16
M10x1.25 x 15.0mm†	5543-10	A	12	575-10	8640-10	3	R4649-10	12	13/32
M11x1.25 x 16.5mm	5543-11	A	6	4944-11	8640-11	3	R4649-11	6	29/64
M12x1.25 x 18.0mm	5543-12	A	6	4944-12	4640-12	3	R4649-12	6	31/64
M12x1.5 x 18.0mm	5544-12	A	6	4976-12	8973-12	3	R3745-12	6	31/64
M14x1.5 x 21.0mm	5544-14	B	6	4976-14	4973-14	3	R3745-14	6	9/16
M16x1.5 x 24.0mm	5544-16	B	6	4976-16	4973-16	3	R3745-16	6	21/32

†Sizes included in Master Thread Repair Set - Part No. 5626-125

# Master Thread Repair Sets

These “Shop Sets” are the professional’s choice and are available in inch and metric — coarse and fine. The inch and metric Master Sets contain the most common thread repair sizes. All of these master sets come complete with a drill, tap, installation tool and a quantity of inserts for each size and complete instructions.



## Inch Master Thread Repair Sets

There are two master sets for inch sizes. The coarse set contains five sizes: 1/4, 5/16, 3/8, 7/16 and 1/2. The fine set has six sizes: #10, 1/4, 5/16, 3/8, 7/16 and 1/2.

THREAD SIZE + LENGTH	PACKAGED INSERT PART NO.	INSERT QUANTITY	TAP PART NO.	INSTALLATION TOOL PART NO.	DRILL SIZE
<b>PART NO. 5621 – INCH COARSE CONTENTS</b>					
1/4-20 x .375	R1185-4	12	819-4	5288-4	17/64
5/16-18 x .469	R1185-5	12	819-5	5288-5	21/64
3/8-16 x .562	R1185-6	12	819-6	5288-6	25/64
7/16-14 x .656	R1185-7	6	819-7	5288-7	29/64
1/2-13 x .750	R1185-8	6	819-8	5288-8	17/32
<b>PART NO. 5625 – INCH FINE CONTENTS</b>					
10-32 x .285	R1191-3	12	821-3	2299-3	13/64
1/4-28 x .375	R1191-4	12	821-4	2299-4	17/64
5/16-24 x .469	R1191-5	12	821-5	2299-5	21/64
3/8-24 x .562	R1191-6	12	821-6	2299-6	25/64
7/16-20 x .656	R1191-7	6	821-7	2299-7	29/64
1/2-20 x .750	R1191-8	6	821-8	2299-8	33/64

## Metric Master Thread Repair Sets

Two sets are available in metric sizes. The metric coarse set contains sizes M5, M6, M8 and M10x1.5 and the metric fine set contains sizes M5, M6, M8 and M10x1.25.

THREAD SIZE + LENGTH	PACKAGED INSERT PART NO.	INSERT QUANTITY	TAP PART NO.	INSTALLATION TOOL PART NO.	DRILL SIZE
<b>PART NO. 5626-150 – METRIC COARSE CONTENTS</b>					
M5x0.8 x 7.5mm	R1084-5	12	570-5	3747-5	13/64
M6x1 x 9.0mm	R1084-6	12	570-6	3747-6	1/4
M8x1.25 x 12.0mm	R1084-8	12	570-8	8747-8	21/64
M10x1.5 x 15.0mm	R1084-10	12	570-10	8747-10	13/32
<b>PART NO. 5626-125 – METRIC FINE CONTENTS</b>					
M5x0.8 x 7.5mm	R1084-5	12	570-5	3747-5	13/64
M6x1 x 9.0mm	R1084-6	12	570-6	3747-6	1/4
M8x1.25 x 12.0mm	R1084-8	12	570-8	3747-8	21/64
M10x1.25 x 15.0mm	R4649-10	12	575-10	8640-10	13/32





# Spark Plug & Sav-A-Thread



## Spark Plug

Heli-Coil is the original spark plug port thread repair. These kits offer the highest quality and most durable repair available. They are the first choice of professional mechanics and engine rebuilders. Kits are available in sizes M10, M12, M14, M18, and 7/8". Each kit contains a piloted reamer tap (no drilling necessary), an installation tool, and a quantity of inserts. The M12 and M14 kits contain several insert lengths to accommodate

all spark plug reaches. Heli-Coil Spark Plug Inserts are the preferred method of repair specified by virtually all U.S. and foreign vehicle manufacturers.

**NOTE:** Do **NOT** use Heli-Coil wire inserts to repair taper seat spark plug ports.

THREAD SIZE	REACH	KIT PART NO.	INSERTS PER KIT	Kit Contents and Replacement Parts			
				TAP PART NO.	INSTALLATION TOOL PART NO.	INSERT PKG. PART NO.	INSERT QUANTITY
10-1.0mm	1/2"	5523-10	24	1030-10	4971-10	R474-4	6
12-1.25mm	1/2"	5523-12	12	1030-12	4971-12	R482-1	6
	3/4"		R482-2			6	
14-1.25mm	3/8"	5523-14	6	1030-14	4971-14	R512	6
	7/16"		6			R513	6
	1/2"		6			R513-13	6
	3/4"		6			R513-10	6
	.472		6			R513-20	6
18-1.50mm	1/2"	5523-18	24	1030-18	4971-18	R514-6	6
7/8-18	1/2"-5/8"	550	10	549	548	K518-12	5

## Sav-A-Thread

Sav-A-Thread is the easiest way to permanently repair stripped spark plug hole threads. Virtually all engines built today have aluminum cylinder heads. Combining this with the growing number of do-it-yourselfers and the need for quick, easy, on-the-spot repairs makes Sav-A-Thread a must for every store and shop.

**NOTE:** Heli-Coil recommends removing the head before installation to insure chips do not enter cylinder.

- Three insert lengths are available to accommodate all spark plug reaches.
- Positive mechanical locking feature means the insert will never come out!
- The piloted reamer tap means no drilling is necessary and perfect alignment of the tapped hole.
- Available in kit or set for the do-it-yourselfer and professional engine rebuilder.



Complete Kits				Kit Contents and Replacement Parts				
SIZE	KIT PART NO.	REACH	INSERTS PER KIT	TAP PART NO.	TOOL PART NO.	REACH	INSERT PKG. PART NO.	INS. QTY.
M14x1.25	5334-14	Short	1	5329-14	5332-14	Short	R5326-14S	1
		Normal	1			Normal	R5326-14N	1
		Long	1			Long	R5326-14L	1
M14x1.25	5408-14	Short	6	5329-14	5332-14	Short	R5326-14S-6	6
		Normal	6			Normal	R5326-14N-6	6
		Long	6			Long	R5326-14L-6	6
M14x1.25	5409-14	Extended	–	5329-14-1	5332-14-1	Extended Reach		

# Special Applications

## Custom Kits

Custom application kits round out the complete line of Heli-Coil Thread Repair Kits. They are recommended by both domestic and foreign automakers and include kits for carburetors, various heavy duty applications, and several specially designed repairs for a number of Volkswagen models.

All kits contain a Heli-Coil tap, installation tool, a quantity of inserts, and detailed instructions. The American Bosch kit and Detroit Diesel kit also include high speed steel drill bits.

## Motorcycle

Heli-Coil offers a complete range of kits and sets for the repair of damaged threads on motorcycles. The Heli-Coil Motorcycle Thread Repair Set contains M6, M8 and M10 sizes. Two lengths of M10 inserts are available: 15mm for most repairs and 25mm for head bolt repairs.

Also available are special sizes for specific Harley Davidson applications. All kits come with tap, installation tool, a quantity of inserts and complete instructions.



## Pipe Thread Kits

Heli-Coil Pipe Thread Kits are available in a complete range of sizes for the most often occurring taper pipe thread failures, such as exhaust pipes on small engines. Each kit contains a high speed steel drill, tap, installation tool, a quantity of inserts, and complete instructions.

## Oxygen Sensor Thread Repair Kit – Part No. 4833

Quickly and permanently restore damaged M18 x 1.5 oxygen sensor threads in exhaust manifolds with this kit. No drilling is necessary with the piloted reamer tap, resulting in perfect alignment of the new tapped hole. Corrosion resistant stainless steel inserts improve future serviceability. This application is easy to use, works in minutes, and eliminates exhaust manifold replacement. Perfect for the professional engine rebuilder and the do-it-yourselfer.



## Sav-A-Thread® Quick Thread Repair

No special tools or taps are required with this kit. Works with standard drill and taps. Inserts are made of carbon steel for strength and durability and zinc plated to resist corrosion. The locking pin aligns in insert slot and

broaches threads in parent material.

The pin breaks off easily for flush, clean repair, and the insert locks into place automatically for a permanent installation.



### Kit Contents and replacement parts

Thread Size	Insert Length	External Thread Size	Drill Size	Tap Size	Inserts Per Kit	Part No.
<b>INCH COARSE PACKAGED INSERTS</b>						
6-32	.312"	5/16-18	17/64	5/16-18	10	20203
8-32	.312"	5/16-18	17/64	5/16-18	10	20205
10-24	.312"	5/16-18	17/64	5/16-18	10	20207
1/4-20	.375"	3/8-16	21/64	3/8-16	8	20211
5/16-18	.437"	7/16-14	"W"	7/16-14	8	20213
3/8-16	.500"	1/2-13	29/64	1/2-13	6	20215
7/16-14	.562"	9/16-12	33/64	9/16-12	6	20217
1/2-13	.625"	5/8-18	37/64	5/8-18	6	20219
<b>INCH FINE PACKAGED INSERTS</b>						
10-32	.312"	5/16-18	17/64	5/16-18	10	20208
1/4-28	.375"	3/8-16	21/64	3/8-16	8	20212
5/16-24	.437"	7/16-14	"W"	7/16-14	8	20214
3/8-24	.500"	1/2-13	29/64	1/2-13	6	20216
7/16-20	.562"	9/16-12	33/64	9/16-12	6	20218
1/2-20	.625"	5/8-18	37/64	5/8-18	6	20220
<b>METRIC PACKAGED INSERTS</b>						
M6X1	.375"	3/8-16	21/64	3/8-16	8	20504
M8X1.25	.500"	1/2-13	29/64	1/2-13	6	20506
M10X1.5	.562"	9/16-12	33/64	9/16-12	6	20508
M12X1.75	.625"	5/8-18	37/64	5/8-18	6	20511

# Applications Guide

## TYPICAL AUTOMOTIVE APPLICATIONS

SIZE	HELI-COIL KIT PART NO.
<b>Oil &amp; Transmission Pan Screws</b>	
1/4-20	5521-4
5/16-18	5521-5
<b>Cylinder Head Bolts</b>	
7/16-14	5521-7
1/2-13	5521-8
9/16-12	5521-9
M10x1.5	5546-10
M11x1.5	5546-11
M11x1.25	5543-11
M12x1.75	5546-12
<b>Exhaust Manifold Studs</b>	
1/4-20	5521-4
1/4-28	5528-4
5/16-18	5521-5
5/16-24	5528-5
3/8-16	5521-6
3/8-24	5528-6
7/16-14	5521-7
7/16-20	5528-7
1/2-20	5528-8
9/16-18	5528-9
5/8-18	5528-10
3/4-10	5521-12
M5x0.8	5546-5
M6x1	5546-6
M8x1.25	5546-8
M10x1.5	5546-10
M10x1.25	5543-10
<b>Starter Bolts</b>	
3/8-16	5521-6
M10x1.5	5546-10
<b>Alternator Bolts</b>	
5/16-18	5521-5
3/8-16	5521-6
M10x1.5	5546-10
<b>Drain Plugs</b>	
1/2-20	5528-8
5/8-18	5528-10
3/4-16	5528-12
7/8-14	5528-14
M12x1.75	5546-12
M14x1.5	5544-14
M16x1.5	5544-16
<b>Brake Caliper Bolts</b>	
M9x1.25	5546-9
M11x1.25	5543-11

## TYPICAL HEAVY DUTY APPLICATIONS

SIZE	HELI-COIL KIT PART NO.
<b>Aux. Transmission Cases (Fuller)</b>	
3/8-16	5521-6
5/16-18	5521-5
<b>Caterpillar Flywheel Bolts</b>	
3/4-16	5528-12
<b>Cummins Head Bolt</b>	
11/16-16	5559-11
<b>Caterpillar Pre-Combustion Chamber</b>	
3/4-12	4922-12
7/8-12	4922-141
1-12	4922-161
1 1/8-12	4922-18
1 1/4-12	4922-20
<b>Wheel Studs</b>	
3/4-10	5521-12
3/4-16	5528-12
<b>Motor Mounts/Bell Housing</b>	
1/2-13	5521-8
5/8-11	5521-10
<b>Oil Pan</b>	
7/16-14	5521-7
<b>Intake Manifolds</b>	
3/8-16	5521-6
<b>After Coolers</b>	
5/16-18	5521-5
<b>Valve Cover</b>	
3/8-16	5521-6
<b>Detroit Diesel Series "92" Block Head Bolt/Main Bearing</b>	
11/16-11	5575-11
<b>Mack-Scania Head Bolt</b>	
M14x1.5	5544-14
<b>American Bosch APE Diesel Fuel Pumps</b>	
1/4-20	5401-4-1-SL

## SPARK PLUG HOLE THREADS

SIZE	HELI-COIL KIT PART NO.
<b>Wire Insert*</b>	
10-1.0mm	5523-10
12-1.25mm	5523-12
14-1.25mm	5523-14
18-1.5mm	5523-18
7/8-18	550
<b>Sav-A-Thread**</b>	
M14x1.25	5334-14 or 5408-14 5409-14

\*For gasket type spark plug assemblies only.

\*\*For Taper seat or gasket type spark plug assemblies.

## TYPICAL MOTORCYCLE APPLICATIONS

SIZE	HELI-COIL KIT PART NO.
<b>Motorcycle Thread Repair Set</b>	
M6x1, M8x1.25 and M10x1.25 (2 lengths)	4650
<b>Cam Screw Cover, Tappet Guide, Oil Pump Stud and Timer Mounting</b>	
1/4-24	5540-4
<b>Front/Rear Brake Drum</b>	
3/8-20	5540-6
<b>Head Bolt</b>	
7/16-16	5540-7
<b>Drain Plug - Engine and Transmission</b>	
1/2-13	5521-8-2
<b>Drain Plug - Chain Case</b>	
1/2-20	5528-8-2
<b>Timing Plug</b>	
5/8-18	5528-10-2
<b>Generator Case Bolt</b>	
5/16-18	5521-5-2
<b>Transmission Cover</b>	
5/16-18	5521-5-3
<b>Japanese Motorcycle Head Bolt</b>	
M10x1.25	4647-10-1

## TYPICAL VOLKSWAGEN APPLICATIONS

SIZE	HELI-COIL KIT PART NO.
<b>VW Electro Magnetic</b>	
M8x1	5542-8-1
<b>Fuel Cut Off Jet</b>	
M11x1	5542-11-1
<b>VW Rabbit Head Bolt Threads</b>	
M11x1.25	5546-11-5
<b>VW Fuel Injection Head Sensor</b>	
M10x1	5542-10-1

## PIPE THREAD KITS

SIZE	HELI-COIL KIT PART NO.
1/8-27	5407-2
1/4-18	5407-4
3/8-18	5407-6
1/2-14	5407-8
3/4-14	5407-12
1-11 1/2	5407-16

# Packaged Inserts & Tooling



Heli-Coil inserts are packaged according to thread size for easy handling and display. The inserts are con-

tained in a sturdy, clear, plastic display box and marked with part number and thread size. The length of the inserts in inch and metric packages is 1-1/2 times the diameter of the bolt. This provides sufficient strength in most applications. Spark plug hole inserts are packaged in lengths corresponding to the various spark plug reaches. For shorter or longer lengths and volume applications, see page 13.

Thread Size + Length	Packaged Insert Part No.	Insert Qty.
<b>INCH COARSE</b>		
8-32x.246	R1185-2	12
10-24x.285	R1185-3	12
12-24x.324	R1185-1	12
1/4-20x.375	R1185-4	12
5/16-18x.469	R1185-5	12
3/8-16x.562	R1185-6	12
7/16-14x.656	R1185-7	6
1/2-13x.750	R1185-8	6
9/16-12x.844	R1185-9	6
5/8-11x.938	R1185-10	6
3/4-10x1.125	R1185-12	4
7/8-9x1.312	K1185-14	1
1-8x1.500	K1185-16	1
1-1/8-7x1.688	K1185-18	1
1-1/4-7x1.875	K1185-20	1
1-3/8-6x2.062	K1185-22	1
1-1/2-6x2.250	K1185-24	1
<b>INCH FINE</b>		
10-32x.285	R1191-3	12
1/4-28x.375	R1191-4	12
5/16-24x.469	R1191-5	12
3/8-24x.562	R1191-6	12
7/16-20x.656	R1191-7	6
1/2-20x.750	R1191-8	6
9/16-18x.844	R1191-9	6
5/8-18x.938	R1191-10	6
3/4-16x1.125	R1191-12	4
7/8-14x1.312	K1191-14	1
1-14x1.500	K1191-16	1
1-12x1.500	K1191-161	1
1-1/8-12x1.688	K1191-18	1
1-1/4-12x1.875	K1191-20	1
1-3/8-12x2.062	K1191-22	1
1-1/2-12x2.250	K1191-24	1

Thread Size	Length	Packaged Insert Part No.	Insert Qty.
<b>METRIC COARSE</b>			
M3x0.5	4.5	R1084-3	12
M4x0.7	6.0	R1084-4	12
M5x0.8	7.5	R1084-5	12
M6x1	9.0	R1084-6	12
M7x1	10.5	R1084-7	12
M8x1.25	12.0	R1084-8	12
M9x1.25	13.5	R1084-9	12
M10x1.5	15.0	R1084-10	12
M12x1.75	18.0	R1084-12	6
M14x2	21.0	R1084-14	6
M16x2	24.0	R1084-16	6
M18x2.5	27.0	R1084-18	6
M20x2.5	30.0	R1084-20	4

Thread Size	Reach	Packaged Insert Part No.	Insert Qty.
<b>METRIC FINE</b>			
M8x1	8.0	R4255-8-10	12
M10x1	15.0	R4255-10	12
M10x1.25	15.0	R4649-10	12
M11x1	11.0	R4255-11-10	6
M11x1.25	16.5	R4649-11	6
M12x1.25	18.0	R4649-12	6
M12x1.5	18.0	R3745-12	6
M14x1.5	21.0	R3745-14	6
M16x1.5	24.0	R3745-16	6

## Spark Plug Sav-A-Thread Inserts

Thread Size	Reach	Packaged Insert Part No.	Insert Qty.
M14x1.25	Short	R5326-14S	1
M14x1.25	Normal	R5326-14N	1
M14x1.25	Long	R5326-14L	1

## SAV-A-THREAD PRO SET

M14x1.25	Short	R5326-14S-6	6
M14X1.25	Normal	R5326-14N-6	6
M14X1.25	Long	R5326-14L-6	6

## Spark Plug – Wire Inserts

Thread Size	Reach	Packaged Insert Part No.	Insert Qty.
10-1.0mm	1/2"	R474-4	6
12-1.25mm	1/2"	R482-1	6
	3/4"	R482-2	6
14-1.25mm	3/8"	R512	6
	7/16"	R513	6
	1/2"	R513-13	6
	3/4"	R513-10	6
	.472	R513-20	6
	18-1.5mm	1/2"	R514-6
7/8"	1/2"-5/8"	R518-12	5

There are two types of industrial installation tools available:

1. **Steel kit tools** for 1/4, 5/16, 3/8, 7/16, 1/2 and 5/8 coarse thread sizes which can be used for medium production quantities.
2. **Prewinder type** installation tools for higher production quantities.



## Prewinder Type Tools

Size	Part No.	Size	Part No.
<b>INCH COARSE</b>		<b>INCH FINE</b>	
8-32	7551-2	10-32	7552-3
10-24	7551-3	1/4-28	7552-4
12-24	7551-1	5/16-24	7552-5
1/4-20	7551-4	3/8-24	7552-6
5/16-18	7551-5	7/16-20	7552-7
3/8-16	7551-6	1/2-20	7552-8
7/16-14	7551-7	9/16-18	535-9
1/2-13	7551-8	5/8-18	535-10
9/16-12*	3724-9	3/4-16	535-12
5/8-11*	3724-10		
3/4-10*	3724-12		

Size	Part No.	Size	Part No.
<b>METRIC COARSE</b>		<b>METRIC FINE</b>	
M3x0.5	7751-3	M8x1	7755-8
M4x0.7	7751-4	M10x1	7755-10
M5x0.8	7751-5	M10x1.25	7756-10
M6x1	7751-6	M12x1.25	7756-12
M7x1	7751-7	M12x1.5	7753-12
M8x1.25	7751-8	M14x1.5	7753-14
M10x1.5	7751-10	M16x1.5	7753-16
M12x1.75	7751-12	M18x1.5	7753-18
M14x2	7751-14		
M16x2	7751-16		
M18x2.5	7751-18		
M20x2.5	7751-20		

**Note:** These industrial tools do not require a prewinder to facilitate installation. They are "T"-Type threaded mandrel tools.

## One Piece Steel Kit Tools

Size	Part No.
1/4-20	2288-4
5/16-18	2288-5
3/8-16	2288-6
7/16-14	2288-7
1/2-13	2288-8
5/8-11	2288-10

# Bulk Inserts

Heli-Coil stainless steel inserts are available in bulk for higher quantity applications such as rebuilding or remanufacture. Each size comes in three different lengths:

- **Short** (length same as the diameter of the bolt or screw) – for short thread engagement applications.
- **Medium** (length 1–1/2 times the diameter of the bolt or screw) – provides sufficient strength in most applications.
- **Long** (length two times the diameter of the bolt or screw) – provides higher strength in critical applications, (especially in magnesium).

## Inch Series Coarse

Size	Length	Part Number
4-40	.112	1185-04CN 112
	.168	1185-04CN 168
	.224	1185-04CN 224
6-32	.138	1185-06CN 138
	.207	1185-06CN 207
	.276	1185-06CN 276
8-32	.164	1185-2CN 164
	.246	1185-2CN 246
	.328	1185-2CN 328
10-24	.190	1185-3CN 190
	.285	1185-3CN 285
	.380	1185-3CN 380
12-24	.216	1185-1CN 216
	.324	1185-1CN 324
	.432	1185-1CN 432
1/4-20	.250	1185-4CN 250
	.375	1185-4CN 375
	.500	1185-4CN 500
5/16-18	.312	1185-5CN 312
	.469	1185-5CN 469
	.625	1185-5CN 625
3/8-16	.375	1185-6CN 375
	.562	1185-6CN 562
	.750	1185-6CN 750
7/16-14	.438	1185-7CN 438
	.656	1185-7CN 656
	.875	1185-7CN 875
1/2-13	.500	1185-8CN 500
	.750	1185-8CN 750
	1.00	1185-8CN 1000
9/16-12	.562	1185-9CN 562
	.844	1185-9CN 844
	1.125	1185-9CN 1125
5/8-11	.625	1185-10CN 625
	.938	1185-10CN 938
	1.250	1185-10CN 1250
3/4-10	.750	1185-12CN 750
	1.125	1185-12CN 1125
	1.500	1185-12CN 1500
7/8-9	.875	1185-14CN 875
	1.312	1185-14CN 1312
	1.750	1185-14CN 1750
1-8	1.000	1185-16CN 1000
	1.500	1185-16CN 1500
	2.000	1185-16CN 2000

## Inch Series Fine

Size	Length	Part Number
10-32	.190	1191-3CN 190
	.285	1191-3CN 285
	.380	1191-3CN 380
1/4-28	.250	1191-4CN 250
	.375	1191-4CN 375
	.500	1191-4CN 500
5/16-24	.312	1191-5CN 312
	.469	1191-5CN 469
	.625	1191-5CN 625
3/8-24	.375	1191-6CN 375
	.562	1191-6CN 562
	.750	1191-6CN 750
7/16-20	.438	1191-7CN 438
	.656	1191-7CN 656
	.875	1191-7CN 875
1/2-20	.500	1191-8CN 500
	.750	1191-8CN 750
	1.00	1191-8CN 1000
9/16-18	.562	1191-9CN 562
	.844	1191-9CN 844
	1.125	1191-9CN 1125
5/8-18	.625	1191-10CN 625
	.938	1191-10CN 938
	1.250	1191-10CN 1250
3/4-16	.750	1191-12CN 750
	1.125	1191-12CN 1125
	1.500	1191-12CN 1500
7/8-14	.875	1191-14CN 875
	1.312	1191-14CN 1312
	1.750	1191-14CN 1750
1-14	1.000	1191-16CN 1000
	1.500	1191-16CN 1500
	2.000	1191-16CN 2000
1-12	1.000	1191-161CN 1000
	1.500	1191-161CN 1500
	2.000	1191-161CN 2000

## Metric Series Coarse

Size	Length	Part Number
M4X0.7	4.0	1084-4CN 040
	6.0	1084-4CN 060
	8.0	1084-4CN 080
M5x0.8	5.0	1084-5CN 050
	7.5	1084-5CN 075
	10.0	1084-5CN 100
M6x1	6.0	1084-6CN 060
	9.0	1084-6CN 090
	12.0	1084-6CN 120
M7x1	7.0	1084-7CN 070
	10.5	1084-7CN 105
	14.0	1084-7CN 140
M8x1.25	8.0	1084-8CN 080
	12.0	1084-8CN 120
	16.0	1084-8CN 160
M9x1.25	9.0	1084-9CN 090
	13.5	1084-9CN 135
	18.0	1084-9CN 180
M10x1.5	10.0	1084-10CN 100
	15.0	1084-10CN 150
	20.0	1084-10CN 200
M11x1.5	11.0	1084-11CN 110
	16.5	1084-11CN 165
	22.0	1084-11CN 220
M12x1.75	12.0	1084-12CN 120
	18.0	1084-12CN 180
	24.0	1084-12CN 240
M14x2	14.0	1084-14CN 140
	21.0	1084-14CN 210
	28.0	1084-14CN 280
M16x2	16.0	1084-16CN 160
	24.0	1084-16CN 240
	32.0	1084-16CN 320
M18x2.5	18.0	1084-18CN 180
	27.0	1084-18CN 270
	36.0	1084-18CN 360
M20x2.5	20.0	1084-20CN 200
	30.0	1084-20CN 300
	40.0	1084-20CN 400

## Metric Series Fine

Size	Length	Part Number
M8x1	8.0	4255-8CN 080
	12.0	4255-8CN 120
	16.0	4255-8CN 160
M10x1	10.0	4255-10CN 100
	15.0	4255-10CN 150
	20.0	4255-10CN 200
M10x1.25	10.0	4649-10CN 100
	15.0	4649-10CN 150
	20.0	4649-10CN 200
M11x1	11.0	4255-11CN 110
	16.5	4255-11CN 165
	22.0	4255-11CN 220
M11x1.25	11.0	4649-11CN 110
	16.5	4649-11CN 165
	22.0	4649-11CN 220
M12x1.25	12.0	4649-12CN 120
	18.0	4649-12CN 180
	24.0	4649-12CN 240
M12x1.5	12.0	3745-12CN 120
	18.0	3745-12CN 180
	24.0	3745-12CN 240
M14x1.5	14.0	3745-14CN 140
	21.0	3745-14CN 210
	28.0	3745-14CN 280
M16x1.5	16.0	3745-16CN 160
	24.0	3745-16CN 240
	32.0	3745-16CN 320
M18x1.5	18.0	3745-18CN 180
	27.0	3745-18CN 270
	36.0	3745-18CN 360

## Spark Plug Series

Size	Reach	Part No.
10-1.0mm	1/2"	474-4
12-1.25mm	1/2"	482-1
	3/4"	482-2
	3/8"	512
	7/16"	513
14-1.25mm	1/2"	513-13
	3/4"	513-10
	.472	513-20
18-1.50mm	1/2"	514-6
7/8-18	1/2"	518-12
	5/8"	518-12

## Pipe Thread Series

Size	Part No.
1/8-27	327-2
1/4-18	327-4
3/8-18	327-6
1/2-14	327-8
3/4-14	327-12
1-11-1/2	327-16

## Sav-A-Thread Series

Size	Reach	Part No.
M14x1.25	Short	5326-14S
M14x1.25	Normal	5326-14N
M14x1.25	Long	5326-14L

# POP® Blind Riveting Systems

POP is the world acknowledged leader in blind rivet fastening technology, and POP rivet tools are the state-of-the-art in design, performance and durability. In addition to being the industry's original manufacturer and pioneer, POP is constantly updating and improving its complete product line to keep pace with rapidly advancing automotive markets and the increasing needs of today's automotive service professionals.

POP rivets are more effective and practical than other fastening methods such as welding, sheet metal screws, nuts and bolts, solid rivets and adhesives. They are ideal for repairs where access is limited to one side only. No surface preparation is required. The job can be done with no special skills. Almost any material can be fastened with POP rivets, especially plastics and sheet metal. The results are uniform and vibration proof.

## Installation

POP rivets consist of two parts: **(A) rivet body** and **(B) setting mandrel**. In operation, the mandrel is pulled back to expand the rivet body and form a tight vibration-free fastener. The mandrel breaks off automatically after the rivet is set.

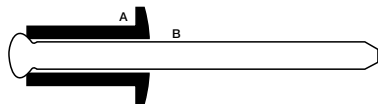

1. After selecting the proper rivet, drill a hole corresponding to the diameter of the rivet through the materials to be fastened. When using counter-sunk head rivets a 120° countersunk bit is required. Use POP Part No. 60928 for countersink drilling.
2. Open the handle of the rivet tool and insert the rivet mandrel in the nose-piece of the tool.
3. Place the rivet body in the pre-drilled hole. Then squeeze the rivet tool handles until the rivet mandrel breaks off.

### Automotive repair, shop use

POP rivets provide an effective, high strength fastening technique. They're ideal for structural repairs, body and collision work, modifications, parts and accessory mounting and countless in-shop and miscellaneous applications. The use of rivets in automotive assembly has increased significantly because of their strength and ease of use.

### Choose power or manual

POP's rivet fastening system is one of the most versatile you can buy. It requires minimal capital investment and inventory. The rivets can be installed manually or by power tools. They're designed for simple operation and ease of use.

### Wide application range

POP offers a complete range of rivets to meet almost every automotive, marine, small engine, hardware and shop application. POP rivets are available in various materials, types, sizes and styles for all types of fastening from plastics to dissimilar metals to pressure tight sealing.

## RIVET MATERIALS

In order to meet a variety of requirements for strength, corrosion and rust considerations and application materials, POP rivets are offered in specific materials and material combinations.

TYPE	APPLICATION
<b>All Steel</b>	<b>High strength:</b> use with steel
<b>Aluminum</b>	<b>Lightweight:</b> Use with aluminum, areas susceptible to rust & corrosion
<b>Alum./Steel</b>	Combines features of both materials
<b>All Stainless</b>	Very high strength: Use with stainless & steel. Prevents corrosion or rust.
<b>Stainless/Steel</b>	<b>Very high strength.</b> Applications where corrosion resistance is not a major factor.
<b>Copper</b>	Electrical conductivity

## TYPES & STYLES

### Rivet Types

There are three basic rivet types available for automotive use.

#### Open End

Designed for a wide range of applications, they resemble conventional tubular rivets when set, but retain the mandrel within the rivet body for added strength. Open end rivets are available in a variety of materials in dome, countersunk or large flange head styles.

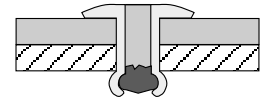

#### Closed End

Specially configured with a cup shaped end that forms a tight seal, POP closed end rivets are much stronger than open end rivets. They are available in dome and countersunk head styles.

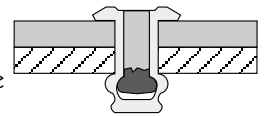

#### T-Rivets

Made for structural and high stress applications. They feature a hardened steel mandrel which splits the rivet body into a trifurcated shape. This provides high clamping strength even in thin or fragile material.

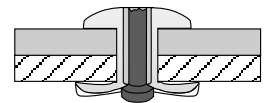

### Head Styles

#### Dome Head

Low profile design and neat appearance, this style is very versatile and most commonly used. The head size is twice the diameter of the rivet body. It provides enough bearing surface for all applications except soft or brittle material.

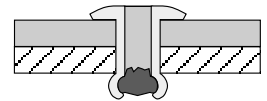

#### Large Flange

Features twice the under-head bearing surface as the dome style. It's ideal for fastening soft or brittle materials to a rigid backing surface.

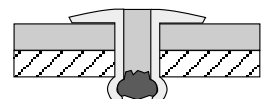

#### Countersunk

Designed with a 120° head profile for flush surface mounting applications.

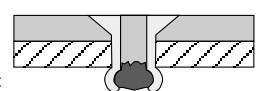

# Rivet Ordering Information

All rivet sizes are available in these **500-piece Pro Pack** boxes to meet the increasing needs of today's automotive service professionals. POP also offers all rivet sizes and back-up plates packaged in **100-piece Shop Pack** boxes — convenient for body shop or service garage.



Rivet Dia.	Head Dia.	Grip Range	Plated Steel Rivet Steel Mandrel			Stainless Steel Rivet Steel Mandrel			Stainless Steel Rivet Stainless Steel Mandrel		
			Code No.	100 pc. Shop Pack No.	500 pc. Pro Pack No.	Code No.	100 pc. Shop Pack No.	500 pc. Pro Pack No.	Code No.	100 pc. Shop Pack No.	500 pc. Pro Pack No.
<b>OPEN END RIVETS</b>											
3/32	3/16	Up to 1/8	SD32	59435	60435						
	3/16	1/8 to 1/4	SD34	59436	60436						
1/8	1/4	1/32 to 1/16	SD41	59437	60437	SSD42	59560	60560	SSD42-S	59540	60540
	1/4	1/16 to 1/8	SD42	59438	60438						
	.220	1/16 to 1/8	SK42	59439	60439						
	3/8	1/16 to 1/8	SDL42	59440	60440	SSD43	59561	60561	SSD43-S	59541	60541
	1/4	1/8 to 3/16	SD43	59441	60441						
	.220	1/8 to 3/16				SSD44	59562	60562	SSD44-S	59542	60542
	1/4	3/16 to 1/4	SD44	59442	60442						
	.220	3/16 to 1/4	SK44	59443	60443	SSD46	59563	60563	SSD46-S	59543	60543
	3/8	3/16 to 1/4	SDL44	59444	60444						
	1/4	1/4 to 5/16	SD45	59445	60445	SSD48	59573	60573	SSD48-S	59544	60544
1/4	5/16 to 3/8	SD46	59446	60446							
1/4	3/8 to 1/2	SD48	59447	60447							
5/32	5/16	1/16 to 1/8	SD52	59448	60448	SSD52	59564	60564	SSD52-S	59545	60545
	5/16	1/8 to 3/16	SD53	59449	60449						
	5/16	3/16 to 1/4	SD54	59450	60450	SSD54	59565	60565	SSD54-S	59546	60546
	5/16	1/4 to 3/8	SD56	59451	60451						
	5/16	3/8 to 1/2				SSD56	59566	60566	SSD56-S	59547	60547
3/16	3/8	1/16 to 1/8	SD62	59453	60453	SSD62	59567	60567	SSD62-S	59548	60548
	3/8	1/8 to 1/4	SD64	59454	60454						
	5/8	1/8 to 1/4	SDL64	59455	60455	SSD66	59569	60569	SSD66-S	59550	60550
	3/8	1/4 to 3/8	SD66	59456	60456						
	5/8	1/4 to 3/8	SDL66	59457	60457	SSD68	59570	60570	SSD68-S	59551	60551
	3/8	3/8 to 1/2	SD68	59458	60458						
	5/8	3/8 to 1/2	SDL68	59459	60459						
	3/8	1/2 to 5/8	SD610	59460	60460						
	5/8	1/2 to 5/8	SDL610	59461	60461						
	3/8	5/8 to 3/4	SD612	59462	60462						
	5/8	5/8 to 3/4	SDL612	59463	60463						
	1/4	1/2	1/16 to 1/4	SD84	59464	60464					
1/2		1/4 to 3/8	SD86	59465	60465						
1/2		3/8 to 1/2	SD88	59466	60466						
1/2		5/8 to 3/4	SD812	59467	60467						
<b>CLOSED END RIVETS</b>											
1/8	.236	1/16 to 1/8									
	.236	1/8 to 3/16									
	.236	3/16 to 1/4									
	.236	3/16 to 1/4									
	.236	1/4 to 5/16									
	.236	3/8 to 1/2									
5/32	5/16	1/16 to 1/8									
	5/16	1/8 to 3/16									
	5/16	1/8 to 3/16									
	5/16	1/16 to 1/4									
	5/16	3/16 to 5/16									
3/16	3/8	1/8 to 1/4	SD64H	59640	60640						
	3/8	1/4 to 3/8									
	3/8	3/8 to 1/2									
1/4	1/2	1/8 to 1/4	SD84H	59642	60642						
	1/2	1/4 to 3/8									
<b>T-RIVETS</b>											
1/4	.510	1/32 to 9/64									
	.510	9/64 to 3/16									
	.510	33/64 to 5/8									

## Rivet Code Explanation – Example: Rivet Code No. AD42AH

<b>A</b>	<b>D</b>	<b>4</b>	<b>2</b>	<b>A</b>	<b>H</b>
<b>Body Material</b>	<b>Head Style</b>	<b>Rivet Diameter</b>	<b>Max. Grip Length</b>	<b>Mandrel Material</b>	<b>Core Design*</b>
A – Aluminum S – Carbon Steel SS – Stainless Steel	D – Dome Head DL – Dome Head, Large Flange K – Countersunk	in 32nds of an inch 4/32 = 1/8"	in 16ths of an inch 2/16 = 1/8"	A – Aluminum S – Stainless Steel Blank – Steel	H – Hollow Blank – Solid Core

\* Pertains to closed end rivets only.

# Rivet Ordering Information

Rivet Dia.	Head Dia.	Grip Range	Aluminum Rivet Aluminum Mandrel			Aluminum Rivet Steel Mandrel			Copper Rivet Steel Mandrel		
			Code No.	100 pc. Shop Pack No.	500 pc. Pro Pack No.	Code No.	100 pc. Shop Pack No.	500 pc. Pro Pack No.	Code No.	100 pc. Shop Pack No.	500 pc. Pro Pack No.
<b>OPEN END RIVETS</b>											
33/32	3/16	Up to 1/8	AD32-A	59470	60470	AD32	59503	60503			
	3/16	1/8 to 1/4	AD34-A	59471	60471	AD34	59504	60504			
1/8	1/4	1/32 to 1/16	AD41-A	59472	60472	AD41	59505	60505	CD42	59571	60571
	1/4	1/16 to 1/8	AD42-A	59473	60473	AD42	59506	60506			
	.220	1/16 to 1/8	AK42-A	59474	60474	AK42	59507	60507			
	3/8	1/16 to 1/8	ADL42-A	59475	60475	ADL42	59508	60508			
	1/4	1/8 to 3/16	AD43-A	59476	60476	AD43	59509	60509			
	.220	1/8 to 3/16				AK43	59510	60510			
	1/4	3/16 to 1/4	AD44-A	59477	60477	AD44	59511	60511	CD44	59572	60572
	.220	3/16 to 1/4				AK44	59512	60512			
	3/8	3/16 to 1/4	ADL44-A	59478	60478	ADL44	59513	60513			
	1/4	1/4 to 5/16	AD45-A	59479	60479	AD45	59514	60514			
	1/4	5/16 to 3/8	AD46-A	59480	60480	AD46	59515	60515			
	1/4	3/8 to 1/2	AD48-A	59481	60481	AD48	59516	60516			
5/32	5/16	1/16 to 1/8	AD52-A	59482	60482	AD52	59517	60517			
	5/16	1/8 to 3/16	AD53-A	59483	60483	AD53	59518	60518			
	5/16	3/16 to 1/4	AD54-A	59484	60484	AD54	59519	60519			
	5/16	1/4 to 3/8	AD56-A	59485	60485	AD56	59520	60520			
	5/16	3/8 to 1/2	AD58-A	59486	60486	AD58	59521	60521			
3/16	3/8	1/16 to 1/8	AD62-A	59487	60487	AD62	59522	60522			
	3/8	1/8 to 1/4	AD64-A	59488	60488	AD64	59523	60523			
	5/8	1/8 to 1/4	ADL64-A	59489	60489	ADL64	59524	60524			
	3/8	1/4 to 3/8	AD66-A	59490	60490	AD66	59525	60525			
	5/8	1/4 to 3/8	ADL66-A	59491	60491	ADL66	59526	60526			
	3/8	3/8 to 1/2	AD68-A	59492	60492	AD68	59527	60527			
	5/8	3/8 to 1/2	ADL68-A	59493	60493	ADL68	59528	60528			
	3/8	1/2 to 5/8	AD610-A	59494	60494	AD610	59529	60529			
	5/8	1/2 to 5/8	ADL610-A	59495	60495	ADL610	59530	60530			
	3/8	5/8 to 3/4	AD612-A	59496	60496	AD612	59531	60531			
	5/8	5/8 to 3/4	ADL612-A	59497	60497	ADL612	59532	60532			
	1/4	1/2	1/16 to 1/4	AD84-A	59498	60498	AD84	59533	60533		
1/2		1/4 to 3/8	AD86-A	59499	60499	AD86	59534	60534			
1/2		3/8 to 1/2				AD88	59535	60535			
1/2		5/8 to 3/4	AD812-A	59500	60500	AD812	59536	60536			
<b>CLOSED END RIVETS</b>											
1/8	.236	1/16 to 1/8	AD42AH	59620	60620	AD42H	59590	60590	CD45H	59644	60644
	.236	1/8 to 3/16				AD43H	59604	60604			
	.236	3/16 to 1/4	AD44AH	59621	60621	AD44H	59592	60592			
	.236	3/16 to 1/4				AK44H	59593	60593			
	.236	1/4 to 5/16				AD45H	59608	60608			
	.236	3/8 to 1/2				AD48H	59595	60595			
5/32	5/16	1/16 to 1/8				AD52H	59596	60596			
	5/16	1/8 to 3/16				AD53H	59609	60609			
	5/16	1/8 to 3/16				AK53H	59607	60607			
	5/16	1/16 to 1/4	AD54AH	59622	60622						
3/16	3/8	1/8 to 1/4	AD64AH	59624	60624	AD64H	59599	60599			
	3/8	1/4 to 3/8				AD66H	59605	60605			
	3/8	3/8 to 1/2				AD68H	59601	60601			
1/4	1/2	1/8 to 1/4				AD84H	59606	60606			
	1/2	1/4 to 3/8				AD86H	59603	60603			
<b>T-RIVETS</b>											
1/4	.510	1/32 to 9/64				AD8140-T	59580	60580			
	.510	9/64 to 3/16				AD8187-T	59581	60581			
	.510	33/64 to 5/8				AD8620-T	59582	60582			

## BACK-UP PLATES

Hole Size	Material	Code No.	100 pc. Shop Pack	Thrift Packs	
			Part No.	Part No.	Qty./Pkg.
1/8	Steel	SBUP-4	59660	57660	40
1/8	Aluminum	ABUP-4	59661	57661	30
3/16	Aluminum	ABUP-6	59662	57662	30

In order to select the proper rivet for your application, follow the procedure below:

1. Select rivet type according to application material and holding strength required. (Refer to Rivet Types, Page 17.)
2. Choose rivet head style best suited for your application. (See Head Styles, Page 17.)
3. Measure joint thickness to determine correct rivet length (Grip Range).
4. Select proper rivet diameter according to recommendations for hole size and strength required. (Larger rivets provide more strength.)



# Thrift Packs



## Thrift Packs

The nine most popular rivet sizes are packaged in these reusable, easy-to-store boxes. Perfect for the do-it-yourselfer!

Rivet Dia.	Head Dia.	Grip Range	Plated Steel Rivet Steel Mandrel		Aluminum Rivet Aluminum Mandrel		Qty. Per Pkg.
			Part No.	Code No.	Part No.	Code No.	
<b>Rivet Thrift Packs – Open End Rivets</b>							
1/8	1/4	1/16 to 1/8	57438	SD42	57473	AD42-A	25
	1/4	3/16 to 1/4	57442	SD44	57477	AD44-A	20
	1/4	5/16 to 3/8	57446	SD46	57480	AD46-A	15
3/16	3/8	Up to 1/8			57487	AD62-A	15
	3/8	1/8 to 1/4			57488	AD64-A	15
	3/8	1/4 to 3/8			57490	AD66-A	15

# PowerLink 30™



Rivet materials and sizes included:

Kit Part No. 5880

Material	Diameter	Grip Range
Aluminum rivet/aluminum mandrel	3/16"	3/16-1/4"
Aluminum rivet/aluminum mandrel	1/8"	1/16-1/8"
Aluminum rivet/steel mandrel	3/16"	1/16-1/8"
Steel rivet/steel mandrel	1/8"	1/16-1/8"
Steel rivet/steel mandrel	1/8"	3/16-1/4"
Countersunk steel rivet/steel mandrel	1/8"	3/16-1/4"

## PowerLink 30 Rivetool Kit

Contains one PowerLink 30™ rivetool, wrench and nosepieces for up to 3/16" rivets AND an assortment of six popular rivet sizes/materials, for a total of 200 rivets, in a durable storage case.

# Custom Application Rivets

POP has the most complete line of special application rivets. These include **T-Rivets** for window regulator and door handle applications, **Trim Rivets**, **Bumper Rivets**, **Rear Window Gasket Rivets**, **Swivel Emblem Trunk Rivets** and more.

Rivet Dia.	Head Dia.	Application	Plated Steel Rivet Steel Mandrel		Aluminum Rivet Aluminum Mandrel		Aluminum Rivet Steel Mandrel		St. Steel Rivet Steel Mandrel		Use on/Equivalent to
			P/N	Code No.	P/N	Code No.	P/N	Code No.	P/N	Code No.	
<b>Pro Packs – Custom Application Rivets – 500 Per Pack</b>											
1/8	1/4	Aluminum Trim Channel Rivet			60477	AD44-A					For attaching molding channels with snap-in color trim
1/4	.510	Window Regulator Rivet					60580	AD8140-T			GM #9436175, Ford #385189, Chrysler #6031115
1/4	.510	Outside Door Handle Rivet					60581	AD8187-T			Ford, Lincoln & Mercury cars & trucks #388047-S100
1/4	.510	Glass Stop Rivet					60582	AD8620-T			Ford #385323, Chrysler #6031091
5/32	5/16	Swivel Emblem Trunk Lock Rivet					60607	AK53H			GM #9432137, Chrysler #6032138
1/4	1/2	Bumper Rivet	60800	SD84038							Ford #372820-S36, yellow zinc dichromate coated
3/16	3/8	Bumper Fascia Rivet	60801	SD66025							GM #9439719, Black oxide coated
1/8	13/64	Std. Alum. Trim Clip Rivet			60802	AD43-A-28					Used on trim clips
1/8	13/64	Long Alum. Trim Clip Rivet			60803	AD44-A-28					Used on filler covered panels
1/8	13/64	Std. Stainless Trim Clip Rivet							60804	SSD43-28	Used for high strength applications
1/8	.318	Rear Window Gasket Rivet					60805	ADL43-318			Fisher body #20325696
1/8	1/4	Multi purpose Rivet					60806	ADL43			GM #9432552
<b>Shop Packs – Customer Application Rivets – 100 Per Box</b>											
1/8	1/4	Aluminum Trim Channel Rivet			59477	AD44-A					For attaching molding channels with snap-in color trim
1/4	.510	Window Regulator Rivet					59580	AD8140-T			GM #9436175, Chrysler #6031115, Ford #385189
1/4	.510	Outside Door Handle Rivet					59581	AD8187-T			Ford, Lincoln & Mercury cars & trucks #388047-S100
1/4	.510	Glass Stop Rivet					59582	AD8620-T			Ford #385323, Chrysler #6031091
5/32	5/16	Swivel Emblem Trunk Lock Rivet					59607	AK53H			GM #9432137, Chrysler #6032138
1/4	1/2	Bumper Rivet	59800	SD84038							Ford #372820-S36, yellow zinc dichromate coated
3/16	3/8	Bumper Fascia Rivet	59801	SD66025							GM #9439719, Black oxide coated
1/8	13/64	Std. Alum. Trim Clip Rivet			59802	AD43-A-28					Used on trim clips
1/8	13/64	Long Alum. Trim Clip Rivet			59803	AD44-A-28					Used on filler covered panels
1/8	13/64	Std. Stainless Trim Clip Rivet							59804	SSD43-28	Used for high strength applications
1/8	.318	Rear Window Gasket Rivet					59805	ADL43-318			Fisher body #20325696
1/8	1/4	Multi Purpose Rivet					59806	ADL43			GM #9432552

# Manual Rivetools

POP makes the easiest to use and most portable rivettools available on the market. They're the industry standard — world renowned for quality, craftsmanship and versatility. POP manual tools

are designed for shop, field or low-volume use where power is not practical or available. A single, firm squeeze is all it takes to set the smaller rivet sizes. All POP rivet tools are equipped with

hardened tool steel jaws to provide durability and longer life as well as nosepieces to set 3/32" to 3/16" open end rivets.



## A475

This PowerLink LeverLite comes ready to set 1/4" diameter POP rivets. Included is the nosepiece required to set tough T-Rivets. Features a durable, unitized body with adjustable stroke for fast, easy operation.



## PRG111

An inexpensive hand tool for the do-it-yourself or occasional user. Designed to set 1/8" diameter rivets and some larger sizes. Ideal for the mechanic's tool box.

## PRG440\*

Durable, dependable push-type hand-operated riveter sets most types and styles of POP rivets up to 1/4". Specially designed for use where lateral space is limited.

\*Special Tooling is required to set 1/4" Rivets (Use PRN 811 nosepiece, PRG 540-44 Jaws and PRG 740-7A Jaw Pusher).



## PowerLink 30 P/N PowerLink 30

This revolutionary rivettool has up to twice the pulling power of other tools tested. The shorter grip is designed for one-hand operation, and the innovative soft handles contour to fit the hand. This rivettool includes wrench and nosepieces for up to 3/16" rivets.



## Pop Swivelhead Rivet Tool P/N 61946\*

- Rotates full 360° for easy access to any application
- Includes 3/32, 1/8, 5/32, and 3/16 nosepieces and wrench
- All steel construction for durability

\*Available late 2002

# Power Rivetools



## PRG510A-Plus

Designed for high production and trouble-free operation. This pneumatic rivet tool is ideal for a variety of applications. Comes with everything needed to set 1/8" thru 3/16" rivet sizes.

## 60865

Light duty hydraulic rivettool kit (85–90 psi maximum). This kit, contained in a sturdy, blow-molded box, comes complete with spare front-end parts and jaw lube and supplies nosepieces to set 3/16" and 1/4" rivets.



## PRG544

Heavy duty air hydraulic rivet tool designed to help increase productivity and avoid downtime. It is the leading choice for high volume, trouble-free operations. Sets a variety of rivet styles and materials up to 1/4" and has hardened steel jaws. Tool comes ready to set 1/4" rivet and includes a 3/16" conversion kit.

# Selection Guides

## MANUAL TOOL & RIVET GUIDE

TOOL	RIVET MATERIAL		RIVET DIAMETERS						TOOL	RIVET MATERIAL		RIVET DIAMETERS					
	Rivet	Mandrel	3/32	7/64	1/8	5/32	3/16	1/4		Rivet	Mandrel	3/32	7/64	1/8	5/32	3/16	1/4
Power Link30	Alum.	Alum.	●			● ●	● ●	● ●	A475 & PRG 440	Alum.	Alum.	●		● ●	● ●	● ●	● ●
	Alum.	Steel	●			● ●	● ●	●		Alum.	Steel	●		● ●	● ●	● ●	● ●
	Steel	Steel	●			●	●	●		Steel	Steel	●		●	●	●	●
PRG 111	St'less	St'less				●			PRG 440	St'less	St'less			●	●	●	
	St'less	Steel				●				St'less	Steel			● ●	● ●	● ●	
	T-Rivets									T-Rivets							● ●

● Open-End Rivets ● Closed-End Rivets

## POWER TOOL/RIVET GUIDE

TOOL	RIVET MATERIAL		RIVET DIAMETERS													
			OPEN-END RIVETS					CLOSED-END SEALING RIVETS				T-RIVETS				
			3/32	1/8	5/32	3/16	1/4	1/8	5/32	3/16	1/4	3/16	1/4			
PRG510	Rivet	Mandrel														
A-PLUS	Alum.	Alum.	● ●	● ●	● ●	● ● ●	● ●	● ●	● ●	● ●	● ●					
	Alum.	Steel	● ●	● ●	● ●	● ● ●	● ●	● ●	● ●	● ●	● ●	● ●	● ●	● ●	● ●	● ●
PRG 544	Steel	Steel	● ●	● ●	● ●	● ● ●	● ●					● ●				
	St'less	St'less		● ●	● ●	● ● ●	● ●	● ●	● ●	● ●	● ●					
60865	St'less	Steel		● ●	● ●	● ● ●	● ●									

● PRG510A-Plus ● PRG544 ● 60865



Nosepieces

## POP Rivetool Interchangeable Nosepieces

POP Rivetools are furnished with nosepieces to set the most frequently used range of rivet sizes (see tool descriptions on page 21). To order additional nosepieces for other requirements — rivet sizes and types — use the chart below.

TOOL	RIVET SIZE					
	3/32	1/8	5/32	3/16	1/4	1/4 T-Rivet
PowerLink 30	PL30-015	PL30-016	PL30-017	PL30-018	—	—
A475	—	A450-22	A450-6	A450-5	A450-23	A450-21
PRG440 & PRG544	PRN314	PRN414	PRN514	PRN614	PRN811	PRN825
PRG510A-Plus	PRN314	PRN414	PRN514	PRN614	—	—
60865	—	—	—	60865-01D	60865-01F	60865-

## Replacement Jaws

Replacement Jaws Stock No.	For Use With Tool Stock No.	Accommodates Rivet Diameters
PL30-010	PowerLink 30	Up to 3/16"
A450-2	A475	All
PRG540-46	PRG440 & PRG544	Up to 3/16"
PRG540-44	PRG440 & PRG544	1/4"
PRG402-8A	PRG510A-Plus	Up to 3/16"
60865-07	60865	All

\*PRG111 – no replacement parts available



Countersunk Drill  
(P/N 60928)

Jaws

# Plastic Expansion Rivets



This unique device is a one piece, all plastic expansion rivet designed to securely fasten a wide variety of

materials in a broad range of applications.

The POP Plastic Rivet quickly inserts from one side of the assembly, using standard rivet setting tools. As the tool pulls the pin through the body, it draws the panels together.

When set, the pin breaks off flush with the head, leaving an attractive, solid color finished appearance.

The POP Plastic Rivet will hold panels of a wide variety of materials, metal or plastic. It is particularly effective for soft materials such as rubber or padded fabrics.

Auto manufacturers use these rivets for many applications on today's automobiles. When necessary, these rivets must be replaced with plastic rivets that

meet or exceed OEM specifications. POP Plastic Rivets are designed to meet these specifications.

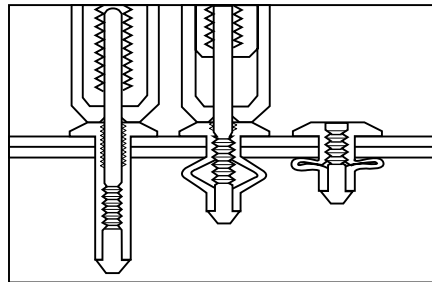

1. Insert plastic rivet in assembly with Plastic Rivet Tool P/N 60930 engaging the pin.
2. As tool pulls pin through body it folds legs in middle and draws panels together at same time.
3. Pin is pulled to full extension after legs are clamped tight against the panel for a secure hold. The pin breaks off and is removed.

## Features:

- Easy assembly from one side
- Draws mating panels together and clamps them securely without secondary washers.
- Prevents marring of soft, painted or other materials that are easily damaged
- Wide-flange design eliminates rivet pull-through in soft materials
- Provides secure clamping action
- Rivet pin is broken off during assembly for an attractive, solid color finished appearance
- Strong, lightweight, non-corrosive, non-conductive
- Available in a wide variety of sizes

## Applications:

- Fascia strips and grill attachments
- License plate brackets
- Exterior molding
- Hi mount stop light
- Door panel attachments

## Ordering Information

POP offers plastic rivets for the most popular aftermarket applications. All sizes are packaged in reusable, plastic boxes. Each package contains 25 rivets.



PART NO.	RIVET DIA.	SUGGESTED DRILL SIZE	GRIP RANGE	HEAD DIA.	REPLACES OEM PLASTIC RIVET PART NUMBER
57712	5.0mm	7/32	.059-.177	.472	GM 20423647, Ford N803170S, Ford N804189S
57714	5.0mm	7/32	.118-.177	.472	AMC 8934202855, Ford N804863S, Chry 34202855, Chry 6500859
57715	5.0mm	7/32	.118-.236	.472	AMC 8934202652, Chry 6500899, GM 20432975, Ford N804343S, VW 175-853-577
57720	5.0mm	7/32	.236-.394	.472	Chry 6500898, Chry 6500982
57721	6.0mm	1/4	.157-.335	.512	GM-BOC 25524005
57732	6.3mm	1/4	.157-.236	.669	Chry 4370132, GM 14070914
57735	6.3mm	1/4	.157-.236	.669	Chry 6500911, GM 14063981, GM-CPC 15506827, GM- T&B 15506921, Ford/Mazda KA01500Z1, Ford N803043S
57736	6.3mm	1/4	.157-.394	.512	GM 20452072, Ford N803862S
57737	6.3mm	1/4	.157-.394	.669	AMC 8934201631, AMC 8934201835
57741	6.3mm	1/4	.315-.472	.661	Chry 4370138, Ford N804675S
57747	6.6mm	9/32	.098-.197	.512	GM 20421672
57748	6.6mm	9/32	.098-.197	.709	GM 20433026, VW 175-853-577A
57752	7.0mm	5/16	.098-.236	.709	GM 1019689, GM-CPC 10087278

## Plastic Rivet Tool

The POP Plastic Rivet Setting Tool P/N 60930, is designed especially for setting POP Plastic Rivets. It was developed to set most plastic rivets in one stroke and you never need to

change the nosepiece. The POP Plastic Rivet Setter is suitable for utility needs as well as service or repair needs.



# POP-NUT® Sheet Metal Inserts



POP Sheet Metal Inserts are designed for use in any sheet metal application. They allow the do-it-yourselfer, as well as the automotive professional,

to use bolts and machine screws in place of weaker sheet metal screws even when you can get to only one side of the work.

POP Sheet Metal Inserts are knurled to keep them from spinning in the hole. When forced into the hole and set in place, the knurl engages the parent material providing high resistance to spinning due to over-torque or cross threading. The “bubble” of material over the backside means that the insert will not pull through; even when used

in thin material. POP Sheet Metal Inserts are made of cadmium-plated steel to provide strong, corrosion-resistant threads. Two different grip ranges are available to accommodate most applications. When installed, the low profile head is nearly flush so no countersinking is necessary.

Sheet Metal Inserts can be used to attach luggage racks, mud flaps, side moldings, rear window louvers, roof racks, ladders, grab bars, truck bed hand rails, wind deflection screens, custom ground effects, almost any accessory to sheet material.

Sheet Metal Inserts are stronger and more reliable than sheet metal screws and allow more flexibility in assembly and disassembly.

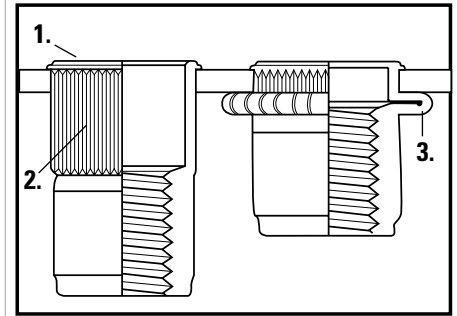

1. Low profile head means the insert is nearly flush. No countersinking necessary.
2. Axial knurl keeps the insert from spinning in the hole.
3. “Bubble” of material provides high resistance to insert pull out.



POP offers general purpose threaded inserts for sheet metal fastening applications. These inserts are packaged in reusable plastic boxes. Ideal for body/customizing shop use as well as the do-it-yourselfer.

## Mandrel/Nosepiece Sets

Each sheet metal insert thread size requires it's own mandrel/nosepiece set to facilitate installation.

Part No.	Thread Size
67933	6-32
67934	8-32
67935	10-24
67936	10-32
67937	1/4-20
67939	5/16-18
67941	3/8-16
67944	M5x0.8
67945	M6x1
67946	M8x1.25
67947	M10x1.5

## Ordering Information

PART NO.	THREAD SIZE	DRILL SIZE	GRIP RANGE	PIECES PER BOX
57821	6-32	17/64	.020-.080	50
57822	8-32	17/64	.020-.080	50
57823	10-24	19/64	.020-.130	50
57824	10-32	19/64	.020-.130	50
57825	1/4-20	25/64	.027-.165	40
57827	5/16-18	17/32	.027-.150	25
57829	3/8-16	17/32	.027-.150	20
57836	6-32	17/64	.080-.130	50
57837	8-32	17/64	.080-.130	50
57838	10-24	19/64	.130-.225	50
57839	10-32	19/64	.130-.225	50
57840	1/4-20	25/64	.165-.260	40
57842	5/16-18	17/32	.150-.312	25
57844	3/8-16	17/32	.150-.312	20
57832	M5x0.8	19/64	0.5-3.3mm	50
57833	M6x1	25/64	0.7-4.2mm	40
57834	M8x1.25	17/32	0.7-3.8mm	25
57835	M10x1.5	17/32	0.7-3.8mm	20

## Kwikset POP-Nut Sheet Metal Insert Tool P/N 67931\*

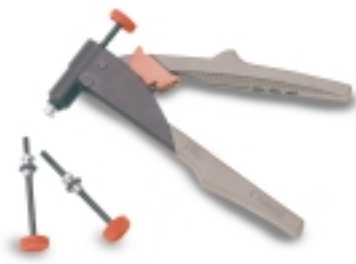

- Powerlink design for fast installation of POP-Nut sheet metal inserts
- Compact, slim-line design for easy carriage in pocket/tool belt
- Comfortable santoprene handle grip offers extra shock absorption
- Robust cast steel construction

## Kwikset POP-Nut Sheet Metal Insert Kits

- Includes Kwikset POP-Nut Sheet Metal Insert Tool and 10 pieces of assorted inserts
- Metric Kit includes M4, M5, M6, M8 inserts and mandrels **P/N6799\***
- Inch Kit includes 8-32, 10-24, 10-32, 1/4-20, and 5/16-18 inserts and mandrels **P/N6798\***
- Durable molded box for storage and quick access

\*Due late 2002

# WELL-NUT Threaded Inserts



The WELL-NUT Threaded Insert is a flanged rubber bushing with a brass nut molded into one end. Tightening a conventional machine screw threaded in the brass nut causes the insert to expand against the inner side of thin-walled materials such as body panels, firewalls, etc., or against the sides of a blind hole in solid material — making a secure fastening.

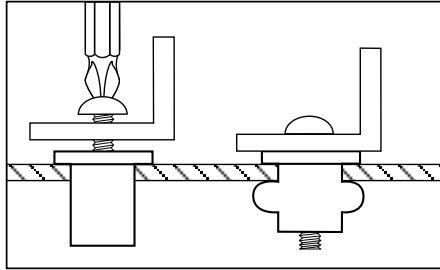

1. Place WELL-NUT insert all the way into pre-drilled hole until flange is firmly against mounting surface.
2. Pass machine screw through part to be fastened and tighten until snug.

- **Provides a leak-proof seal**
- **No special tool required**
- **Muffles noise and absorbs shock**

## Features:

- Fastens in thin walls or blind holes
- Functions as a threaded insert or a fastener or BOTH
- Seals against air or liquid leakage
- Muffles noise
- Dampens vibration and shock
- Ideal for mixed material fastening
- Removable
- Installs with conventional tools
- One-step installation

## Applications:

- Luggage carriers
- Roof racks
- License plate brackets
- Mirror supports
- Inner door panels
- Spoilers and other aerodynamic accessories
- Ground effects
- Speaker housings
- Anywhere a leak-proof seal is required

## Ordering Information

PART NUMBER	THREAD SIZE	DRILL SIZE	GRIP RANGE	PIECES PER BOX
57205	6-32	5/16	.015-.156	25
57207	8-32	5/16	.015-.154	25
57219	10-32	3/8	.015-.192	25
57220	M5x0.8	3/8	.015-.192	25
57243	1/4-20	1/2	.031-.187	20
57244	M6x1	1/2	.031-.187	20
57255	5/16-18	5/8	Up to .187	12
57256	M8x1.25	5/8	Up to .187	12
57259	3/8-16	3/4	.015-.437	6



POP WELL-NUTS are available in reusable, plastic boxes. No special tooling is required to set these inserts. Ideal for body shop use as well as the do-it-yourselfer.

# Creating the Future Worldwide

---

At **Emhart**, creating the future is about growth, about change and about taking risks. It is who we are and what we do. Our focus is to reduce the overall product assembly costs of our customers by anticipating needs and meeting those needs with technology and market-driven solutions.

Emhart is a global leader in the design and creation of unique assembly technologies, delivering depth and breadth of service and product through a flexible, cross-functional global organization.

## **Owning the Customer's Total Experience**

We provide every customer with the capability to satisfy every aspect of fastening and assembly technology. From concept through installation, around the corner and around the globe, Emhart develops and delivers solutions for challenging assembly applications.

## **Technology Optimization**

Emhart has the ability to objectively match customer priorities, applications and manufacturing environment with the most appropriate assembly technology and fastening systems. We provide this capability through Application engineers, and Mobile, Stationary and Virtual Innovation Centers located around the world. Each is electronically linked, capable of sharing application data and new design concepts with each other as well as with our customers.

---

DODGE

GRIPCO

HELI-COIL

NPR

PARKER-KALON

POP

TUCKER

WARREN

Products and specifications subject to change without notice.  
Roush Racing and Matt Kenseth's name and/or likeness used by the  
authority of Roush Racing, Livonia, MI.

---

**HeliCoil** Your global resource for precision  
formed stainless steel wire inserts.



**HELI- COIL SALES & TECHNICAL SUPPORT  
ASIA – INDIA**

**Noble Fastotech Pvt. Ltd.  
307 Raja House , 30-31 Nehru Place,  
New Delhi – 110019 INDIA**

**Phone : +91-11- 41617246 , +91-11- 41617274**

**FAX : +91-11- 41617271**

**E-Mail : [helicoil@helicoil.in](mailto:helicoil@helicoil.in)**

**Website : [www.helicoil.in](http://www.helicoil.in)**

**Emhart<sup>®</sup>  
Teknologies**

A  **BLACK&DECKER COMPANY**

**Emhart Teknologies  
Industrial Division  
50 Shelton Technology Center  
P.O. Box 859  
Shelton , CT 06484 USA**

**Heli-Coil is a Registered Trade Mark Of Emhart Teknologies Inc., Worldwide**