

HITCH PIN CLIPS

HUYETT.COM • 785-392-3017

BOX 232 • MINNEAPOLIS, KS • 67467
SALES@HUYETT.COM • FAX 785-392-2845

BRIDGE – IMPERIAL

DESCRIPTION

Bridge pins are simple and extremely versatile wire forms used as locking devices. They are reusable and cost effective. Commonly used on clevis pins and shafts.

HOW TO IDENTIFY

1. Verify bridge pin shaped wire form.
 2. Measure wire diameter (K).
 3. Measure length (A).
 4. Find the part in the chart below.
- Or:
Compare to part silhouette in chart below.

SEE IMAGES BELOW FOR EXACT CONFIGURATIONS

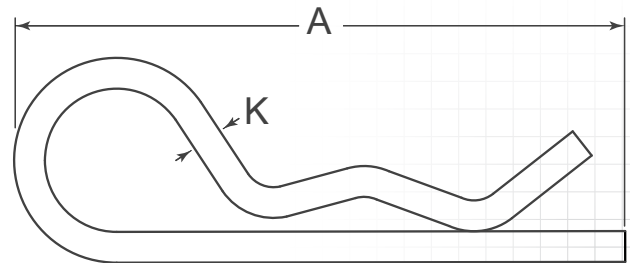
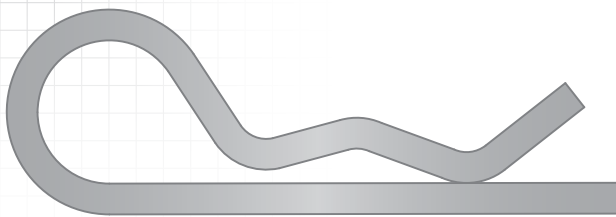

PREFIX MATERIAL/FINISH

- BP = MB SPRING WIRE, ZINC CLEAR
- BPP = MB SPRING WIRE, PLAIN*
- BPS = 302/304 STAINLESS STEEL, PLAIN
- BPS6 = 316 STAINLESS STEEL, PLAIN
- BPY = MB SPRING WIRE, ZINC YELLOW

Material/finish combinations may not be available in all sizes.

ADDITIONAL SIZES AND FINISHES MAY BE AVAILABLE UPON REQUEST

ITEM #	PREFIX-141	PREFIX-131	PREFIX-121	PREFIX-165	PREFIX-231	PREFIX-2101	PREFIX-145	PREFIX-226	PREFIX-112
(K) WIRE DIA.	.026"	.026"	.026"	.028"	.028"	.030"	.032"	.032"	.032"
(A) LENGTH	.344" (11/32)	.469" (15/32)	.484" (31/64)	.484" (31/64)	.600"	.594" (19/32)	.359" (23/64)	.438" (7/16)	.563" (9/16)
EYE DIA.	-	-	-	-	.094" (3/32)	.179"	-	.078" (5/64)	-
FITS SHAFT	3/64"	5/64"	3/32"	3/32"	1/8" to 5/32"	1/8" to 3/16"	7/64"	7/64" to 9/64"	1/8"

ITEM #	PREFIX-123	PREFIX-142	PREFIX-191	PREFIX-232	PREFIX-2102	PREFIX-223	PREFIX-111	PREFIX-144	PREFIX-221
(K) WIRE DIA.	.035"	.041"	.041"	.042"	.042"	.042"	.047" (3/64)	.047" (3/64)	.047" (3/64)
(A) LENGTH	.438" (7/16)	.625" (5/8)	1.000" (1)	.438" (7/16)	.938" (15/16)	1.000" (1)	.578" (37/64)	.578" (37/64)	.594" (19/32)
EYE DIA.	-	-	-	.080"	.258"	.250" (1/4)	-	-	.125" (1/8)
FITS SHAFT	1/16"	9/64"	5/64"	1/16" to 1/8"	3/16" to 1/4"	3/16" to 1/4"	3/32"	3/32"	1/8" to 3/16"

Images are approximate actual size.

FOR DETAILED SPECIFICATIONS AND TOLERANCES, VISIT HUYETT.COM.

Prices, materials, dimensions, tolerances, designs, and grades subject to change without notice. © 2022 Huyett

*Limited warranty for surface finish: 30 days from date of shipment. See page 8 for details.



HITCH PIN CLIPS

HUYETT.COM • 785-392-3017

BRIDGE – IMPERIAL

ITEM #	PREFIX-224	PREFIX-148	PREFIX-119	PREFIX-236	PREFIX-178	PREFIX-237	PREFIX-120	PREFIX-0002	PREFIX-127
(K) WIRE DIA.	.047" (3/64)	.051"	.051"	.054"	.054"	.054"	.054"	.054"	.054"
(A) LENGTH	1.563" (1-9/16)	.750" (3/4)	1.250" (1-1/4)	.750" (3/4)	.766" (49/64)	.875" (7/8)	.906" (29/32)	.969" (31/32)	1.125" (1-1/8)
EYE DIA.	.313" (5/16)	–	–	.125" (1/8)	–	.141" (9/64)	–	.243"	–
FITS SHAFT	1/4" to 3/8"	–	7/64"	3/16" to 1/4"	3/32"	1/4" to 3/8"	9/64"	3/16" to 1/4"	9/64"

ITEM #	PREFIX-2103	PREFIX-222	PREFIX-114	PREFIX-218	PREFIX-179	PREFIX-225	PREFIX-118	PREFIX-0004
(K) WIRE DIA.	.059"	.062" (1/16)	.062" (1/16)	.062" (1/16)	.072"	.072"	.072"	.072"
(A) LENGTH	1.125" (1-1/8)	1.313" (1-5/16)	1.547" (1-35/64)	1.563" (1-9/16)	.938" (15/16)	1.094" (1-3/32)	1.125" (1-1/8)	1.188" (1-3/16)
EYE DIA.	.253"	.313" (5/16)	–	.375" (3/8)	–	.141" (9/64)	–	.249"
FITS SHAFT	1/4" to 5/16"	1/4" to 1/2"	7/32"	3/8" to 1/2"	5/32"	5/16" to 3/8"	7/64"	1/4" to 3/8"

ITEM #	PREFIX-189	PREFIX-239	PREFIX-2104	PREFIX-213	PREFIX-186	PREFIX-217	PREFIX-164	PREFIX-0005
(K) WIRE DIA.	.072"	.072"	.073"	.080"	.080"	.080"	.080"	.091"
(A) LENGTH	1.219" (1-7/32)	1.875" (1-7/8)	1.438" (1-7/16)	1.188" (1-3/16)	1.563" (1-9/16)	1.563" (1-9/16)	1.875" (1-7/8)	1.625" (1-5/8)
EYE DIA.	–	.625" (5/8)	.360"	.250" (1/4)	–	.375" (3/8)	–	.375" (3/8)
FITS SHAFT	11/64"	3/8" to 1/2"	5/16" to 3/8"	1/4" to 3/8"	7/32"	3/8" to 1/2"	1/4"	5/16" to 1/2"

Images are approximate actual size.

FOR DETAILED SPECIFICATIONS AND TOLERANCES, VISIT HUYETT.COM.

Prices, materials, dimensions, tolerances, designs, and grades subject to change without notice. © 2022 Huyett

*Limited warranty for surface finish: 30 days from date of shipment. See page 8 for details.

HITCH PIN CLIPS

HUYETT.COM • 785-392-3017

BOX 232 • MINNEAPOLIS, KS • 67467
SALES@HUYETT.COM • FAX 785-392-2845

BRIDGE – IMPERIAL

PREFIX MATERIAL/FINISH

- BP = MB SPRING WIRE, ZINC CLEAR
- BPP = MB SPRING WIRE, PLAIN*
- BPS = 302/304 STAINLESS STEEL, PLAIN
- BPS6 = 316 STAINLESS STEEL, PLAIN
- BPY = MB SPRING WIRE, ZINC YELLOW

Material/finish combinations may not be available in all sizes.

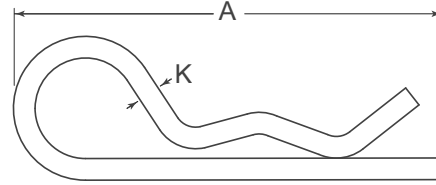

ITEM #	PREFIX-0006	PREFIX-156	PREFIX-2105	PREFIX-233	PREFIX-203	PREFIX-228	PREFIX-207
(K) WIRE DIA.	.091"	.091"	.092"	.094" (3/32)	.094" (3/32)	.094" (3/32)	.094" (3/32)
(A) LENGTH	2.000" (2)	2.250" (2-1/4)	1.875" (1-7/8)	1.125" (1-1/8)	1.625" (1-5/8)	2.000" (2)	2.313" (2-5/16)
EYE DIA.	.670"	-	.700"	.250" (1/4)	.375" (3/8)	.625" (5/8)	.625" (5/8)
FITS SHAFT	3/8" to 1/2"	5/16"	3/8" to 7/16"	1/4" to 1/2"	1/4" to 1/2"	1/4" to 1/2"	1/4" to 5/8"

ITEM #	PREFIX-214	PREFIX-230	PREFIX-138	PREFIX-134	PREFIX-143	PREFIX-0008
(K) WIRE DIA.	.094" (3/32)	.105"	.120"	.120"	.120"	.120"
(A) LENGTH	2.500" (2-1/2)	1.250" (1-1/4)	1.719" (1-23/32)	1.813" (1-13/16)	2.000" (2)	2.375" (2-3/8)
EYE DIA.	.563" (9/16)	.125" (1/8)	-	-	-	.547" (35/64)
FITS SHAFT	3/8" to 3/4"	5/16" to 3/8"	9/32"	1/8"	9/32"	1/2" to 9/16"

Images are approximate actual size.

FOR DETAILED SPECIFICATIONS AND TOLERANCES, VISIT HUYETT.COM.

Prices, materials, dimensions, tolerances, designs, and grades subject to change without notice. © 2022 Huyett





*Limited warranty for surface finish: 30 days from date of shipment. See page 8 for details.







HITCH PIN CLIPS

HUYETT.COM • 785-392-3017

BRIDGE – IMPERIAL

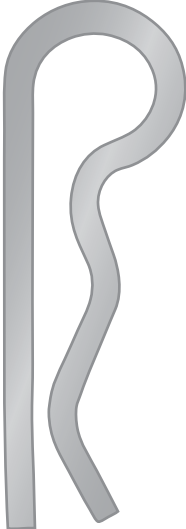
					
ITEM #	PREFIX-2106	PREFIX-135	PREFIX-140	PREFIX-215	PREFIX-216
(K) WIRE DIA.	.120"	.120"	.120"	.125" (1/8)	.125" (1/8)
(A) LENGTH	2.375" (2-3/8)	2.781" (2-25/32)	3.250" (3-1/4)	1.563" (1-9/16)	1.938" (1-15/16)
EYE DIA.	.702"	–	–	.500" (1/2)	.438" (7/16)
FITS SHAFT	1/2" to 5/8"	5/16"	13/32"	1/2" to 3/4"	1/2" to 3/4"

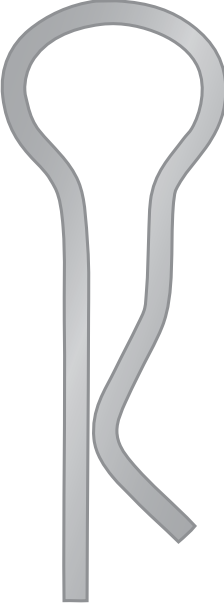
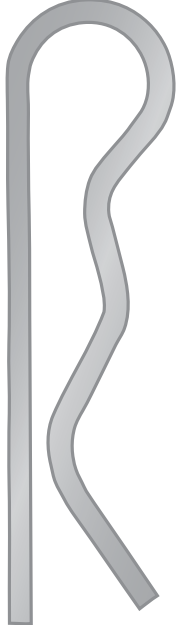
						
ITEM #	PREFIX-227	PREFIX-211	PREFIX-157	PREFIX-238	PREFIX-202	PREFIX-139
(K) WIRE DIA.	.125" (1/8)	.125" (1/8)	.125" (1/8)	.125" (1/8)	.125" (1/8)	.125" (1/8)
(A) LENGTH	2.500" (2-1/2)	2.563" (2-9/16)	2.750" (2-3/4)	2.875" (2-7/8)	3.125" (3-1/8)	3.250" (3-1/4)
EYE DIA.	.625" (5/8)	.563" (9/16)	–	.625" (5/8)	1.000" (1)	–
FITS SHAFT	5/8" to 7/8"	7/16" to 3/4"	13/32"	3/4" to 1-1/8"	3/4" to 1-1/8"	13/32"

FOR DETAILED SPECIFICATIONS AND TOLERANCES, VISIT HUYETT.COM.

Prices, materials, dimensions, tolerances, designs, and grades subject to change without notice. © 2022 Huyett



*Limited warranty for surface finish: 30 days from date of shipment. See page 8 for details.



HITCH PIN CLIPS

HUYETT.COM • 785-392-3017

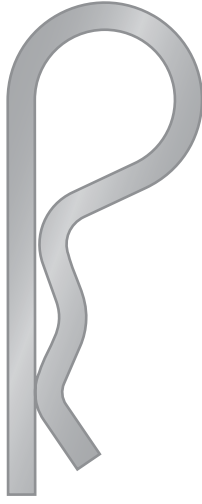
BOX 232 • MINNEAPOLIS, KS • 67467
SALES@HUYETT.COM • FAX 785-392-2845

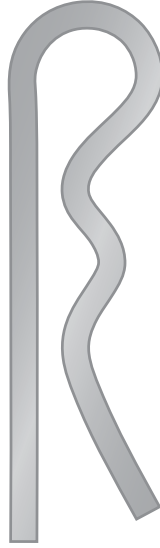
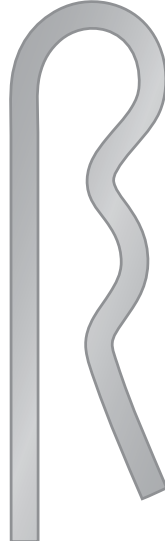
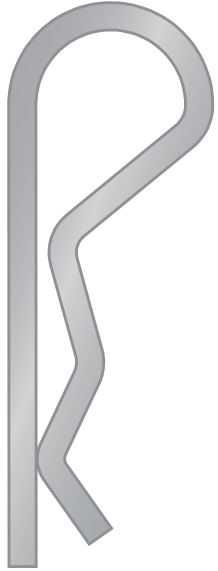
BRIDGE – IMPERIAL

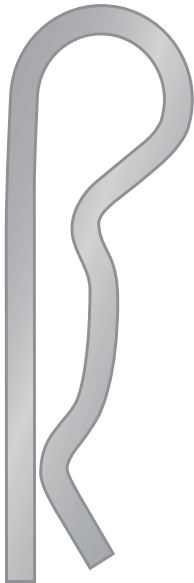
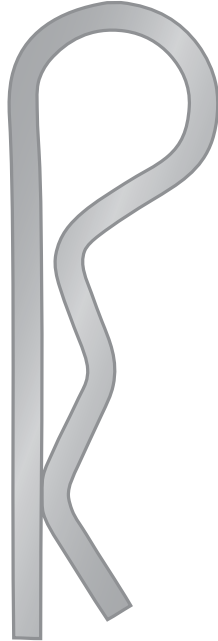
						
ITEM #	PREFIX-2107	PREFIX-0010	PREFIX-124	PREFIX-129	PREFIX-173	PREFIX-210
(K) WIRE DIA.	.148"	.148"	.148"	.148"	.148"	.148"
(A) LENGTH	2.563" (2-9/16)	2.750" (2-3/4)	2.813" (2-13/16)	2.813" (2-13/16)	2.813" (2-13/16)	2.938" (2-15/16)
EYE DIA.	.885"	.733"	–	–	–	.845"
FITS SHAFT	5/8" to 3/4"	5/8" to 7/8"	3/8"	27/64"	9/16"	5/8" to 1"

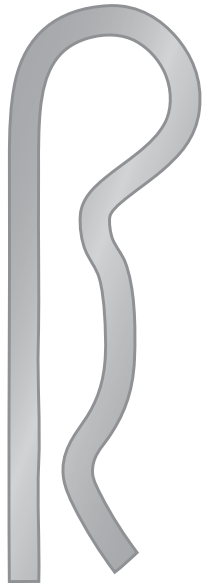
					
ITEM #	PREFIX-201	PREFIX-209	PREFIX-113	PREFIX-205	PREFIX-204
(K) WIRE DIA.	.148"	.148"	.156" (5/32)	.162"	.162"
(A) LENGTH	3.000" (3)	3.313" (3-5/16)	1.813" (1-13/16)	2.188" (2-3/16)	3.000" (3)
EYE DIA.	.500" (1/2)	.750" (3/4)	–	.875" (7/8)	.625" (5/8)
FITS SHAFT	1/2" x 5/8" to 5/8" x 1"	3/4" to 1-1/8"	13/64"	7/8" to 1-1/16"	1/2" x 3/4" to 5/8" x 1"

Images are approximate actual size.

FOR DETAILED SPECIFICATIONS AND TOLERANCES, VISIT HUYETT.COM.

Prices, materials, dimensions, tolerances, designs, and grades subject to change without notice. © 2022 Huyett

*Limited warranty for surface finish: 30 days from date of shipment. See page 8 for details.



HITCH PIN CLIPS

HUYETT.COM • 785-392-3017

BRIDGE – IMPERIAL

PREFIX	MATERIAL/FINISH
--------	-----------------

- | | |
|------|----------------------------------|
| BP | = MB SPRING WIRE, ZINC CLEAR |
| BPP | = MB SPRING WIRE, PLAIN* |
| BPS | = 302/304 STAINLESS STEEL, PLAIN |
| BPS6 | = 316 STAINLESS STEEL, PLAIN |
| BPY | = MB SPRING WIRE, ZINC YELLOW |

Material/finish combinations may not be available in all sizes.

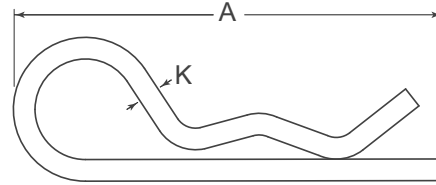

ITEM #	PREFIX-212	PREFIX-137	PREFIX-154	PREFIX-206
(K) WIRE DIA.	.162"	.177"	.177"	.177"
(A) LENGTH	3.438" (3-7/16)	2.609" (2-39/64)	2.766" (2-49/64)	3.250" (3-1/4)
EYE DIA.	.875" (7/8)	-	-	1.015"
FITS SHAFT	1/2" x 1" to 7/8" x 1"	5/16"	17/32"	5/8" to 1"

ITEM #	PREFIX-2109
(K) WIRE DIA.	.243" (See also page 112-113)
(A) LENGTH	5.000" (5)
EYE DIA.	1.229"
FITS SHAFT	1-1/8" to 1-1/2"

Images are approximate actual size.

FOR DETAILED SPECIFICATIONS AND TOLERANCES, VISIT HUYETT.COM.

Prices, materials, dimensions, tolerances, designs, and grades subject to change without notice. © 2022 Huyett

*Limited warranty for surface finish: 30 days from date of shipment. See page 8 for details.

HITCH PIN CLIPS

HUYETT.COM • 785-392-3017

BOX 232 • MINNEAPOLIS, KS • 67467
SALES@HUYETT.COM • FAX 785-392-2845

BRIDGE – IMPERIAL

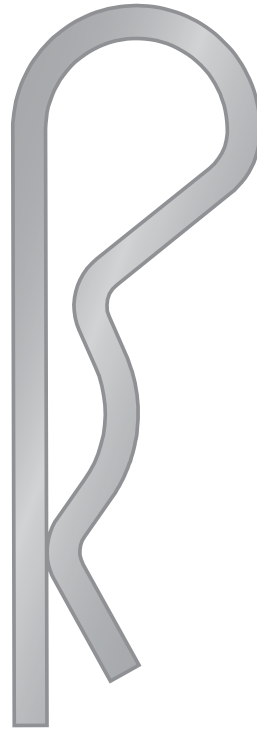
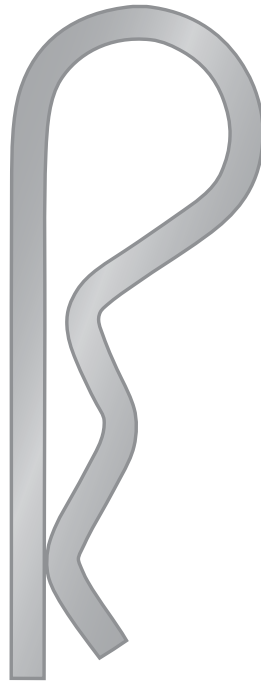
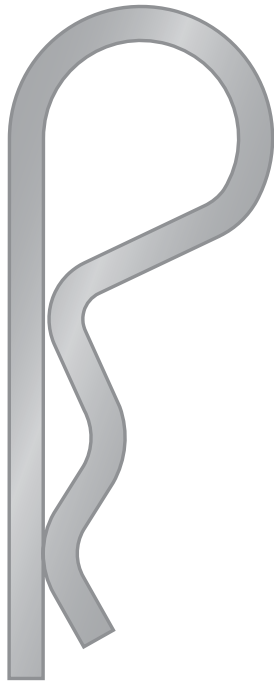

ITEM #	PREFIX-0012	PREFIX-229	PREFIX-208	PREFIX-2108
(K) WIRE DIA.	.177"	.177"	.177"	.178"
(A) LENGTH	3.500" (3-1/2)	3.500" (3-1/2)	3.750" (3-3/4)	3.750" (3-3/4)
EYE DIA.	1.004"	.938" (15/16)	.975"	1.005"
FITS SHAFT	7/8" to 1"	3/4" to 1-1/16"	7/8" to 1-1/4"	7/8" to 1"

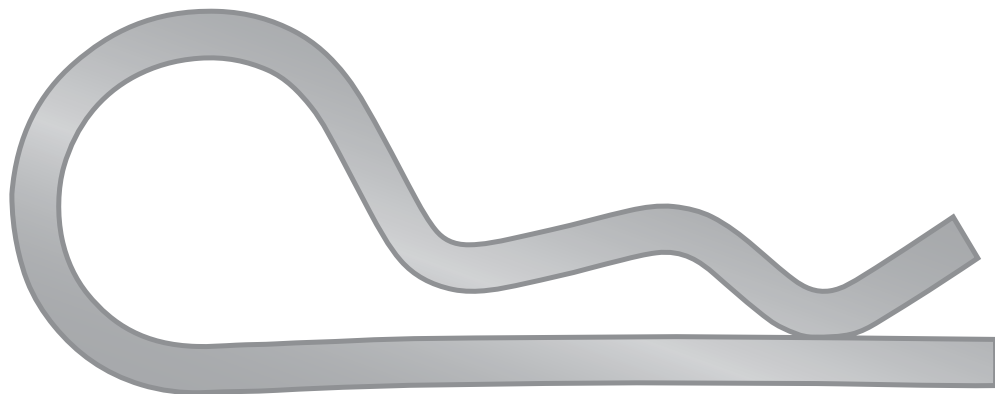

ITEM #	PREFIX-235
(K) WIRE DIA.	.243" (See also page 111, 113)
(A) LENGTH	5.125" (5-1/8)
EYE DIA.	1.500" (1-1/2)
FITS SHAFT	1-1/4" to 1-1/2"

Images are approximate actual size.

FOR DETAILED SPECIFICATIONS AND TOLERANCES, VISIT HUYETT.COM.

Prices, materials, dimensions, tolerances, designs, and grades subject to change without notice. © 2022 Huyett

*Limited warranty for surface finish: 30 days from date of shipment. See page 8 for details.



HITCH PIN CLIPS

HUYETT.COM • 785-392-3017

BRIDGE – IMPERIAL

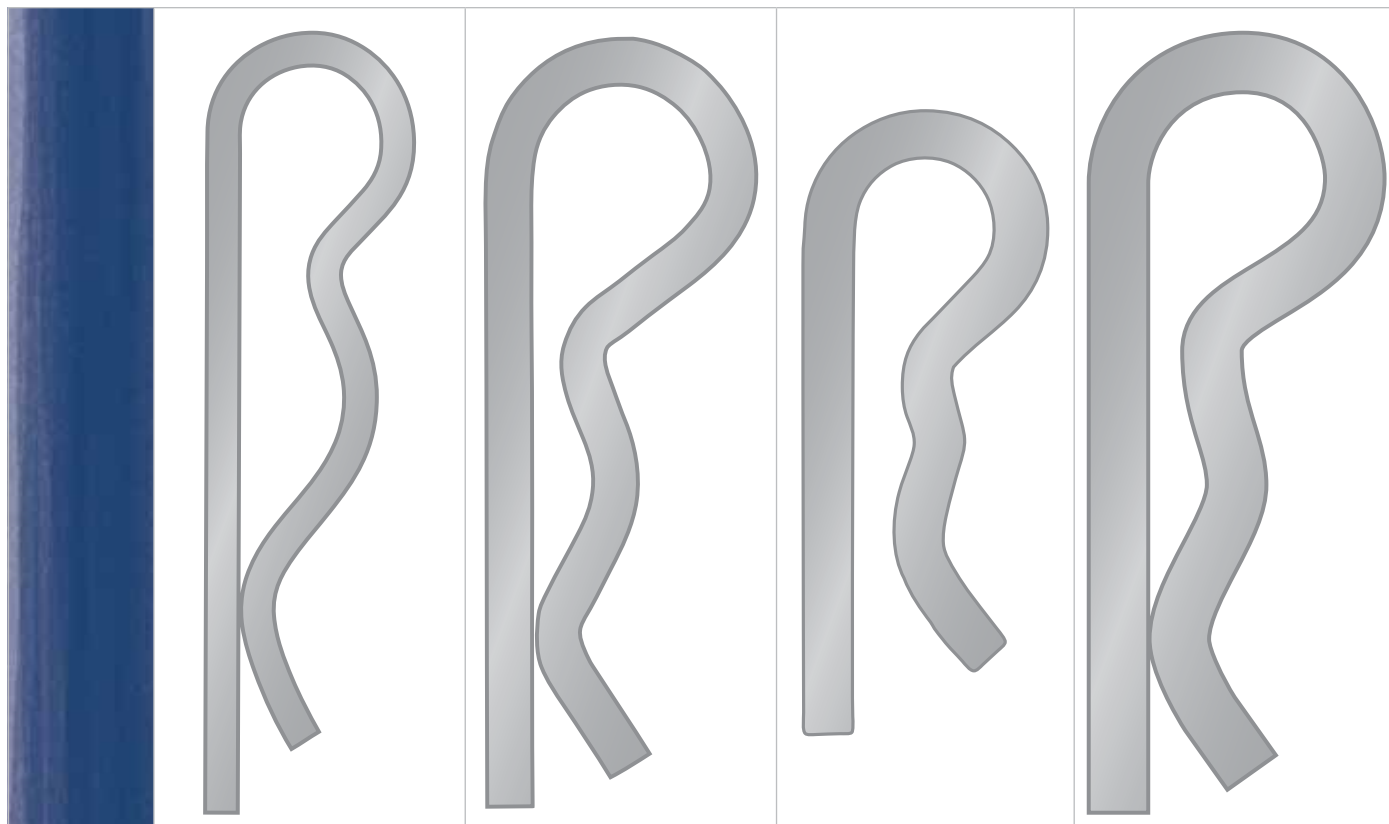

ITEM #	PREFIX-146	PREFIX-219	PREFIX-117	PREFIX-220
(K) WIRE DIA.	.187" (3/16)	.243" (See also page 111-112)	.250" (1/4)	.310"
(A) LENGTH	4.062" (4-1/16)	4.000" (4)	3.250" (3-1/4)	4.062" (4-1/16)
EYE DIA.	.722"	.938" (15/16)	-	.875" (7/8)
FITS SHAFT	23/32"	3/4" to 1"	1/2"	7/8" to 1"

Images are approximate actual size.

APPLICATIONS

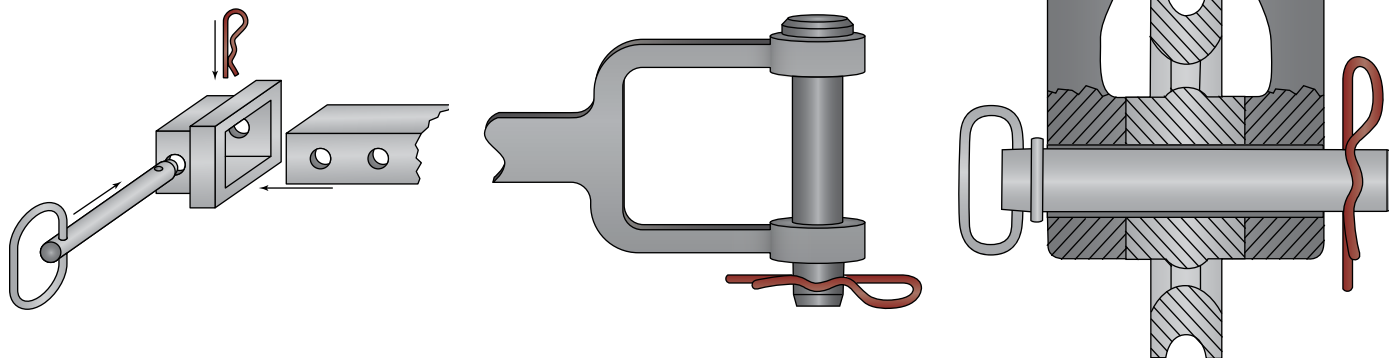

USED TO LOCK
A HITCH PIN IN PLACE

FOR DETAILED SPECIFICATIONS AND TOLERANCES, VISIT HUYETT.COM.

Prices, materials, dimensions, tolerances, designs, and grades subject to change without notice. © 2022 Huyett

*Limited warranty for surface finish: 30 days from date of shipment. See page 8 for details.