



Marson® Rivets, Rivet Nuts and Installation Tools





Table of Contents

Howmet Fastening Systems (HFS) offers the broadest line of blind fasteners in the industry. The breadth of the line is supported by the company's Industrial Distribution Group (IDG) and a nationwide network of independent stocking warehouses, which maintain inventories for delivery to customers within hours. In short, the company's responsiveness to its customers and their changing industrial needs is second-to-none.

In an ongoing effort to be the best, HFS's Industrial Distribution Group also offers custom services such as painting, plating, anodizing, packaging, bar-coding and labeling.

Quality Policy

Howmet Fastening Systems is committed to satisfying our customers by delivering safe and reliable products and services. Marson® brand rivets are engineered in accordance with and governed by the Industrial Fastener Institute quality standards.

INTRODUCTION	2
GENERAL INFORMATION — BLIND RIVETS	3
DESIGN INFORMATION	4
STEEL RIVETS	5
ALUMINUM RIVETS	6
ALUMINUM/STEEL RIVETS	7
STAINLESS RIVETS	8
STAINLESS/STEEL RIVETS	9
CLOSED-END RIVETS	10
MULTI-GRIP RIVETS	11
SPECIALTY RIVETS	12
COPPER/BRASS RIVETS	12
COPPER/STEEL RIVETS	12
TRI-BULB RIVETS	12
PAINTED RIVETS	12
BACK-UP WASHERS	12
STEEL Q-LOK RIVETS	13
T-RIVETS/KLIK-SPLIT™	13
AUTOMOTIVE/SPECIAL APPLICATION RIVETS	13
KLIK-LOCK® RIVETS	14-15
PLASTIC RIVET TOOLS	16
PLASTIC RIVETS	17
HAND RIVET TOOLS, KITS AND SPECIALTY ITEMS	18-20
POWER TOOLS	21-23
MARSON RIVET NUTS AND GENERAL INFORMATION	24-25
MRN SERIES	26
MPN/MTS SERIES	27
MLR SERIES	28
MLC SERIES	29
MSR SERIES	30
MSC SERIES	31
MHN SERIES	32
QUAD-LEG AND CROSS BULB	33
MET SERIES	34
MNN SERIES	35
RIVET NUT TOOLS AND KITS	36-40
CONVERSION TABLES	41-42

General Information — Blind Rivets

Rivet Styles

OPEN END



CLOSED END



MULTI-GRIP



TRI-BULB



Q-LOK



KLIK-LOCK



T-RIVETS



SPECIAL APPLICATION RIVETS



PLASTIC



Features/Benefits

- FOR BLIND FASTENING WHERE THERE IS NO ACCESS TO OPPOSITE SIDE OF WORK
- SIMPLE TO INSTALL
- WIDE VARIETY OF HEAD STYLES AND LENGTHS AVAILABLE FROM 3/32" TO 1/4" DIAMETERS

- MOISTURE-RESISTANT DUE TO CLOSED END
- GREATER SHEAR AND TENSILE STRENGTH
- MANDREL IS RETAINED 100% OF TIME
- 1/8" TO 1/4" DIAMETERS

- EXTENDED GRIP RANGE CAPACITY
- REDUCES INVENTORY (FEWER SIZES REQUIRED)
- USE AS A STANDARD OPEN END RIVET
- 1/8" TO 3/16" DIAMETERS

- LARGE FOOTPRINT ON BLIND SIDE
- MULTI-GRIP CAPABILITY
- OVERSIZED HOLE TOLERANT
- GREAT FOR SOFT OR BRITTLE MATERIALS
- AVAILABLE IN 5/32" TO 3/16" DIAMETERS

- RETAINED MANDREL INCREASES SHEAR AND TENSILE STRENGTH
- USE IN HIGH VIBRATION APPLICATIONS
- MANDREL BREAKS FLUSH WHEN USED IN MID-GRIP RANGE
- MOISTURE-RESISTANT DUE TO TIGHT SEAL
- 3/16" DIAMETER

- PERMANENTLY RETAINED MANDREL PROVIDES INCREASED SHEAR AND TENSILE VALUES
- USE IN HIGH VIBRATION APPLICATIONS
- PROVIDES WEATHER-RESISTANT JOINT
- AVAILABLE IN 3/16" AND 1/4" DIAMETERS

- HIGH CLAMP UP
- HIGH SHEAR STRENGTH
- CREATES A WIDE BEARING SURFACE
- 1/4" DIAMETER

- SMALL FLANGE RIVET USED PRIMARILY FOR FASTENING DECORATIVE MATERIALS ON BOATS, AUTOMOBILES, TRUCKS AND OTHER MOTOR VEHICLES
- BEST SUITED TO APPLICATIONS WHERE A DISCREET, SECURE INSTALLATION OF NON-CRITICAL COMPONENTS IS NEEDED

- PRECISION-MOLDED, ALL-NYLON
- SECURE LOCK PREVENTS PULL-OUT
- FASTEN PLASTIC TO PLASTIC, PLASTIC TO METAL OR PLASTIC TO FIBERGLASS

Materials Available

STEEL/STEEL, ALUMINUM/ALUMINUM
ALUMINUM/STEEL, STAINLESS/STAINLESS
STAINLESS/STEEL, COPPER/BRASS, COPPER/STEEL

ALUMINUM/STEEL, ALUMINUM/ALUMINUM,
STAINLESS/STAINLESS

ALUMINUM/STEEL, STEEL/STEEL

ALUMINUM/ALUMINUM

STEEL/STEEL

STEEL/STEEL, ALUMINUM/ALUMINUM,
STAINLESS/STAINLESS

ALUMINUM/STEEL

STAINLESS/STEEL, ALUMINUM/ALUMINUM

NYLON BODY, DELRIN 500 MANDREL

Head Styles

BUTTONHEAD



LARGE FLANGE



COUNTERSUNK



Features / Benefits

- LOW PROFILE HEAD DIAMETER IS TWICE THE RIVET BODY DIAMETER, PROVIDING ADEQUATE BEARING SURFACE FOR NEARLY ALL APPLICATIONS
- OPEN-END BUTTONHEAD RIVETS OFFER THE BROADEST SELECTION OF SIZES AVAILABLE

- PROVIDES GREATER BEARING SURFACE FOR FASTENING SOFT AND BRITTLE FACING MATERIALS AND OVERSIZE FACING HOLES
- WORKS WELL WITH SOFT MATERIALS, WHERE THE INCREASED FLANGE DIAMETER PROTECTS THE INTEGRITY OF THE APPLICATION

- 120° COUNTERSUNK RIVETS FOR APPLICATIONS WHERE FLUSH APPEARANCE IS REQUIRED

Design Information

HFS Code Descriptions

Example:	A — First Letter.....Rivet Material (A = Aluminum, S = Steel, C = Copper, SS = Stainless Steel)
ABL6-6A	B — Second Letter.....Style of Head (B = Buttonhead, C = Countersunk)
	L — Third Letter (if any).....Large Flange Head
	6 — First Number.....Body Diameter in 32nds
	6 — Second Number.....Maximum Grip Length in 16ths
	A — Final Letter.....A = Aluminum Mandrel, S = Stainless Steel Mandrel, B = Brass Mandrel, C = Copper-Plated Steel Mandrel, CLD = Closed-End Mandrel MG = Multi-Grip, QL = Q-Lok, KL = Klik-Lock ATB = All Aluminum Tri-Bulb Rivet. No letter indicates steel mandrel.

Design Information

- The shear and tensile strength of the rivet selected and the number of rivets used in the application should equal or exceed the joint strength requirements. Typical ultimate shear and tensile strengths are listed by diameter and material on pages 5 through 17 of this catalog. Testing is recommended before final selection and use in product.
- The rivet body material should be compatible with the materials to be joined to resist galvanic corrosion which may result in reduction of joint strength. If dissimilar materials are widely separated on the galvanic chart, it is advisable to separate them with a dielectric material such as paint or other coating. HFS can paint colors to match, as well as anodize or plate to your specifications.
- After determination of strengths required by diameter and material, the total thickness of materials to be joined must be considered. The grip range for each rivet is listed on pages 5 through 17. Select the rivet grip range which includes the total thickness of materials to be joined. Please note that the rivet barrel length (Column L) is not the grip range.
- Use recommended hole sizes for each rivet as shown on pages 5 through 17. An undersize hole will not allow insertion of rivet body. An oversize hole may cause rivet or joint failure and could adversely affect rivet shear and tensile strengths.
- The various head styles (illustrated on page 3) are offered to accommodate different assembly needs. The most popular Klik-Fast rivet is the buttonhead, whose lower-profile head is twice the diameter of the rivet body. This provides adequate bearing surface for nearly all applications. The large flange Klik-Fast rivet provides greater bearing surface for fastening soft or brittle facing materials. The countersunk Klik-Fast rivet is available for applications where a flush appearance is required.
- Please visit us at hfsindustrial.com and e-mail your questions. We will follow up with evaluations, recommendations and testing if required.
 - Samples are available upon request
 - Special packaging available



Installation Sequence



1 Insert rivet mandrel in rivet setting tool.



2 Using tool as a guide, insert rivet into prepared hole.

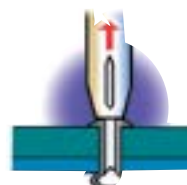

3 Or insert rivet into prepared hole and then engage the mandrel with rivet-setting tool. Squeeze trigger or handles to set rivet. Mandrel ejects after rivet is set.

Blind Rivet Benefits



One Length Handles Both



Hollow Extrusions and Tubes



High Grip Strength No Surface Distortion



Hard and Soft Materials



Vibration and Tamper Resistant



High Strength



No Marred Surfaces



Low-Profile Heads



Steel Rivets

Plated-Steel Rivet • Coated Steel Mandrel • IFI Grade 30

DIAMETER (MM)	HFS DESCRIPTION	BULK PART NO.**	GRIP RANGE		DRILL NO. & HOLE SIZE	H HEAD DIA NOM	E HEAD HEIGHT MAX	L RIVET LENGTH MAX		TYPICAL ULTIMATE STRENGTH (LBS.) (NEWTONS)	
			INCH	(MM)				INCH (MM)	INCH (MM)	INCH (MM)	SHEAR
BUTTONHEAD											
1/8" (.125) 3.2	SB4-1	M50111	.020-.062	5-1.6	#30 (.129-.133)	.250 6.35	.040 1.02	.212	5.4	305 1356	410 1823
	SB4-2	M50112	.063-.125	1.7-3.2				.275	7.0		
	SB4-3	M50115	.126-.187	3.3-4.8				.337	8.6		
	SB4-4	M50117	.188-.250	4.9-6.4				.400	10.2		
	SB4-5	M50120	.251-.312	6.5-7.9				.462	11.7		
	SB4-6	M50121	.313-.375	8.0-9.5				.525	13.4		
	SB4-8	M50122	.376-.500	9.6-12.7				.650	16.5		
	SB4-10	M50125	.501-.625	12.8-15.9	.775	19.7					
5/32" (.156) 4.0	SB5-2	M50132	.020-.125	5-3.2	#20 (.160-.164)	.312 7.92	.050 1.27	.300	7.6	420 1868	600 2668
	SB5-3	M50134	.126-.187	3.3-4.8				.362	9.2		
	SB5-4	M50135	.188-.250	4.9-6.4				.425	10.8		
	SB5-6	M50136	.251-.375	6.5-9.5				.550	14.0		
	SB5-8	M50137	.376-.500	9.6-12.7				.675	17.2		
	SB5-10	M50131	.501-.675	12.8-17.1				.800	20.3		
	SB5-12	M50133	.676-.750	17.2-19.1				.925	23.5		
3/16" (.187) 4.8	SB6-2	M50145	.020-.125	5-3.2	#11 (.192-.196)	.375 9.53	.060 1.52	.325	8.3	610 2713	870 3889
	SB6-4	M50147	.126-.250	3.3-6.4				.450	11.5		
	SB6-6	M50149	.251-.375	6.5-9.5				.575	14.6		
	SB6-8	M50152	.376-.500	9.6-12.7				.700	17.8		
	SB6-10	M50155	.501-.625	12.8-15.9				.825	21.0		
	SB6-12	M50159	.626-.750	16.0-19.1				.950	24.2		
	SB6-14	M50163	.751-.875	19.2-22.2				1.075	27.3		
	SB6-16	M50170	.876-1.000	22.3-25.4	1.200	30.5					
1/4" (.250) 6.4	SB8-2	M50179	.020-.125	5-3.2	F (.257-.261)	.500 12.70	.080 2.03	.375	9.4	1270 5649	1550 6894
	SB8-4	M50181	.126-.250	3.3-6.4				.500	12.7		
	SB8-6	M50183	.251-.375	6.5-9.5				.625	15.9		
	SB8-8	M50185	.376-.500	9.6-12.7				.750	19.1		
	SB8-10	M50187	.501-.625	12.8-15.9				.875	21.0		
	SB8-12	M50189	.626-.750	16.0-19.1				1.000	25.4		
	SB8-14	M50188	.751-.875	19.2-22.2				1.125	28.6		
	SB8-16	M50190	.876-1.000	22.3-25.4	1.250	31.8					
LARGE FLANGE											
1/8" (.125) 3.2	SBL4-2	M50114	.063-.125	1.7-3.2	#30 (.129-.133)	.375 9.53	.065 1.65	.275	7.0	305 1356	410 1823
	SBL4-3	M50124	.126-.187	3.3-4.8				.337	8.6		
	SBL4-4	M50119	.188-.250	4.9-6.4				.400	10.2		
	SBL4-6	M50108	.313-.375	8.0-9.5				.525	13.3		
	SBL4-8	M50109	.376-.500	9.6-12.7	.650	16.5					
5/32" (.156) 4.0	SBL5-4	M50138	.188-.250	4.9-6.4	#20 (.160-.164)	.468 11.90	.070 1.77	.425	10.8	420 1868	600 2668
	SBL5-6	M50139	.251-.375	6.5-9.5				.550	14.0		
	SBL5-8	M50110	.376-.500	9.6-12.7				.675	17.2		
3/16" (.187) 4.8	SBL6-4	M50148	.126-.250	3.3-6.4	#11 (.192-.196)	.615 15.88	.090 2.28	.450	11.5	610 2713	870 3889
	SBL6-6	M50150	.251-.375	6.5-9.5				.575	14.6		
	SBL6-8	M50153	.376-.500	9.6-12.7				.700	17.8		
	SBL6-10	M50156	.501-.625	12.8-15.9				.825	21.0		
	SBL6-12	M50160	.626-.750	16.0-19.1				.950	24.2		
	SBL6-14	M50165	.751-.875	19.2-22.2				1.075	27.3		
	SBL6-16	M50167	.876-1.000	22.3-25.4	1.200	30.5					
120° COUNTERSUNK											
1/8" (.125) 3.2	SC4-2	M50113	.092-.125	2.3-3.2	#30 (.129-.133)	.220 5.59	.031 1.14	.275	7.0	305 1356	410 1823
	SC4-3	M50116	.126-.187	3.3-4.8				.337	8.6		
	SC4-4	M50118	.188-.250	4.9-6.4				.400	10.2		
	SC4-6	M50126	.313-.375	6.5-9.5				.525	13.3		
	SC4-8	M50127	.376-.500	9.6-12.7				.650	16.5		
5/32" (.156) 4.0	SC5-4	M50140	.188-.250	4.9-6.4	#20 (.160-.164) (4.06-4.16)	.281 7.20	.040 1.20	.425	10.8	420 1868	600 2668
3/16" (.187) 4.8	SC6-4	M50151	.151-.250	3.8-6.4	#11 (.192-.196) (4.88-4.98)	.350 8.89	.050 1.27	.450	11.4	610 2713	870 3889
	SC6-6	M50129	.251-.375	6.5-9.5				.575	14.6		

KLK-FAST RIVETS CONFORM TO IFI-114 (INCH) AND IFI-505 (METRIC). MILLIMETERS (MM) AND NEWTONS (N) ARE IN GREEN. ** ALSO AVAILABLE IN VARIOUS PACKAGED QUANTITIES.



Aluminum Rivets

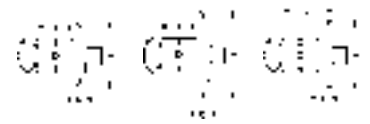

5052 Aluminum Rivet • Aluminum Mandrel • IFI Grade 11											
DIAMETER (MM)	HFS DESCRIPTION	BULK PART NO.**	GRIP RANGE		DRILL NO. & HOLE SIZE	H HEAD DIA NOM	E HEAD HEIGHT MAX	L RIVET LENGTH MAX		TYPICAL ULTIMATE STRENGTH (LBS.) (NEWTONS)	
			INCH	(MM)				INCH (MM)	INCH (MM)	INCH (MM)	SHEAR
BUTTONHEAD											
3/32" (.094) 2.4	AB3-2A	M50200	.020-.125	5-3.2	#41 (.097-.100)	.188	.032	.250	6.4	80	120
	AB3-4A	M50202	.126-.250	3.3-6.4	(2.46-2.54)	4.78	.810	.375	9.5	355	533
1/8" (.125) 3.2	AB4-1A	M50211	.020-.062	5-1.6	#30 (.129-.133) (3.28-3.38)	.250 6.35	.040 1.02	.212	5.4	155 689	240 1067
	AB4-2A	M50212	.063-.125	1.7-3.2				.275	7.0		
	AB4-3A	M50215	.126-.187	3.3-4.8				.337	8.6		
	AB4-4A	M50217	.188-.250	4.9-6.4				.400	10.2		
	AB4-5A	M50220	.251-.312	6.5-7.9				.462	11.7		
	AB4-6A	M50221	.313-.375	8.0-9.5				.525	13.4		
	AB4-8A	M50222	.376-.500	9.6-12.7				.650	16.5		
AB4-10A	M50225	.501-.625	12.8-15.9	.775	19.7						
5/32" (.156) 4.0	AB5-2A	M50232	.020-.125	5-3.2	#20 (.160-.164) (4.06-4.16)	.312 7.92	.050 1.27	.300	7.6	230 1023	340 1512
	AB5-3A	M50234	.126-.187	3.3-4.8				.362	9.2		
	AB5-4A	M50235	.188-.250	4.9-6.4				.425	10.8		
	AB5-6A	M50236	.251-.375	6.5-9.5				.550	14.0		
	AB5-8A	M50237	.376-.500	9.6-12.7				.675	17.2		
	AB5-10A	M50238	.501-.625	12.8-17.1				.800	20.3		
	AB5-12A	M50239	.626-.750	17.2-19.1				.925	23.5		
3/16" (.187) 4.8	AB6-2A	M50245	.020-.125	5-3.2	#11 (.192-.196) (4.88-4.98)	.375 9.53	.060 1.52	.325	8.3	330 1467	515 2290
	AB6-4A	M50247	.126-.250	3.3-6.4				.450	11.5		
	AB6-6A	M50249	.251-.375	6.5-9.5				.575	14.6		
	AB6-8A	M50252	.376-.500	9.6-12.7				.700	17.8		
	AB6-10A	M50255	.501-.625	12.8-15.9				.825	21.0		
	AB6-12A	M50259	.626-.750	16.0-19.1				.950	24.2		
	AB6-14A	M50263	.751-.875	19.2-22.2				1.075	27.3		
	AB6-16A	M50266	.876-1.000	22.3-25.4				1.200	30.5		
	1/4" (.250) 6.4	AB8-4A	M50281	.126-.250				3.3-6.4	F (.257-.261) (6.53-6.63)		
AB8-6A		M50283	.251-.375	6.5-9.5	.625	15.9					
AB8-8A		M50285	.376-.500	9.6-12.7	.750	19.1					
AB8-10A		M50287	.501-.625	12.8-15.9	.875	21.0					
AB8-12A		M50289	.626-.750	16.0-19.1	1.000	25.4					
AB8-14A		M50288	.751-.875	19.2-22.2	1.125	28.6					
AB8-16A		M50292	.876-1.000	22.3-25.4	1.250	31.8					
LARGE FLANGE											
1/8" (.125) 3.2	ABL4-2A	M50214	.063-.125	1.7-3.2	#30 (.129-.133) (3.28-3.38)	.375 9.53	.065 1.14	.275	7.0	155 689	240 1067
	ABL4-3A	M50224	.126-.187	3.3-4.8				.337	8.6		
	ABL4-4A	M50219	.188-.250	4.9-6.4				.400	10.2		
	ABL4-6A	M50226	.313-.375	8.0-9.5				.525	13.3		
	ABL4-8A	M50227	.376-.500	9.6-12.7				.650	16.5		
5/32" (.156) 4.0	ABL5-4A	M50244	.188-.250	4.9-6.4	#20 (.160-.164) (4.06-4.16)	.468 11.90	.070 1.20	.425	10.8	230 1023	340 1512
3/16" (.187) 4.8	ABL6-4A	M50248	.126-.250	3.3-6.4	#11 (.192-.196) (4.88-4.98)	.615 15.88	.090 2.28	.450	11.5	330 1467	515 2290
	ABL6-6A	M50250	.251-.375	6.5-9.5				.575	14.6		
	ABL6-8A	M50253	.376-.500	9.6-12.7				.700	17.8		
	ABL6-10A	M50256	.501-.625	12.8-15.9				.825	21.0		
	ABL6-12A	M50260	.626-.750	16.0-19.1				.950	24.2		
	ABL6-16A	M50267	.875-1.00	22.2-25.4				1.200	30.5		
120° COUNTERSUNK											
1/8" (.125) 3.2	AC4-2A	M50213	.092-.125	2.3-3.2	#30 (.129-.133) (3.28-3.38)	.220 5.59	.031 1.14	.275	7.0	155 689	240 1050
	AC4-3A	M50216	.126-.187	3.3-4.8				.337	8.6		
	AC4-4A	M50218	.188-.250	4.9-6.4				.400	10.2		
	AC4-6A	M50241	.313-.375	8.0-9.5				.525	13.3		
5/32" (.156) 4.0	AC5-4A	M50240	.188-.250	4.9-6.4	#20 (.160-.164) (4.06-4.16)	.281 7.20	.040 1.20	.425 .550	10.8 14.0	230 1020	340 1512
	AC5-6A	M50242	.313-.375	8.0-9.5							
3/16" (.187) 4.8	AC6-4A	M50251	.151-.250	3.8-6.4	#11 (.192-.196) (4.88-4.98)	.350 8.89	.050 1.27	.407	10.3	330 1467	515 2290
	AC6-6A	M50229	.251-.375	6.5-9.5				.575	14.6		
	AC6-8A	M50246	.376-.500	9.6-12.7				.700	17.8		

KLK-FAST RIVETS CONFORM TO IFI-114 (INCH) AND IFI-505 (METRIC). MILLIMETERS (MM) AND NEWTONS (N) ARE IN GREEN. ** ALSO AVAILABLE IN VARIOUS PACKAGED QUANTITIES.

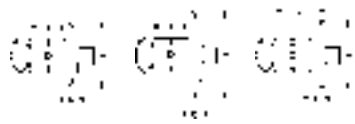

Aluminum / Steel Rivets

5056 Aluminum Rivet • Coated Steel Mandrel • IFI Grade 19

DIAMETER (MM)	HFS DESCRIPTION	BULK PART NO.**	GRIP RANGE		DRILL NO. & HOLE SIZE	H HEAD DIA NOM	E HEAD HEIGHT MAX	L RIVET LENGTH MAX		TYPICAL ULTIMATE STRENGTH (LBS.) (NEWTONS)	
			INCH	(MM)				INCH (MM)	INCH (MM)	INCH (MM)	SHEAR
BUTTONHEAD											
3/32" (.094) 2.4	AB3-2	M50300	.020-.125	.5-3.2	#41 (.097-.100) (2.46-2.54)	.188	.032	.250	6.4	120	160
	AB3-4	M50302	.126-.250	3.3-6.4		.478	.810	.375	9.5	534	711
1/8" (.125) 3.2	AB4-1	M50311	.020-.062	.5-1.6	#30 (.129-.133) (3.28-3.38)	.250 6.35	.040 1.02	.212	5.4	225 1000	315 1401
	AB4-2	M50312	.063-.125	1.7-3.2				.275	7.0		
	AB4-3	M50315	.126-.187	3.3-4.8				.337	8.6		
	AB4-4	M50317	.188-.250	4.9-6.4				.400	10.2		
	AB4-5	M50320	.251-.312	6.5-7.9				.462	11.7		
	AB4-6	M50321	.313-.375	8.0-9.5				.525	13.4		
	AB4-8	M50322	.376-.500	9.6-12.7				.650	16.5		
AB4-10	M50325	.501-.625	12.8-15.9	.775	19.7						
5/32" (.156) 4.0	AB5-2	M50332	.020-.125	.5-3.2	#20 (.160-.164) (4.06-4.16)	.312 7.92	.050 1.27	.300	7.6	300 1334	470 2090
	AB5-3	M50334	.126-.187	3.3-4.8				.362	9.2		
	AB5-4	M50335	.188-.250	4.9-6.4				.425	10.8		
	AB5-6	M50336	.251-.375	6.5-9.5				.550	14.0		
	AB5-8	M50337	.376-.500	9.6-12.7				.675	17.2		
3/16" (.187) 4.8	AB6-2	M50345	.020-.125	.5-3.2	#11 (.192-.196) (4.88-4.98)	.375 9.53	.060 1.52	.325	8.3	465 2068	700 3113
	AB6-4	M50347	.126-.250	3.3-6.4				.450	11.5		
	AB6-6	M50349	.251-.375	6.5-9.5				.575	14.6		
	AB6-8	M50352	.376-.500	9.6-12.7				.700	17.8		
	AB6-10	M50355	.501-.625	12.8-15.9				.825	21.0		
	AB6-12	M50359	.626-.750	16.0-19.1				.950	24.2		
	AB6-16	M50366	.751-1.000	19.2-25.4				1.200	30.5		
1/4" (.250) 6.4	AB8-4	M50381	.126-.250	3.3-6.4	F (.257-.261) (6.53-6.63)	.500 12.70	.080 1.88	.500	12.7	990 4403	1195 5315
	AB8-6	M50383	.251-.375	6.5-9.5				.625	15.9		
	AB8-8	M50385	.376-.500	9.6-12.7				.750	19.1		
	AB8-10	M50387	.501-.625	12.8-15.9				.875	21.0		
	AB8-12	M50389	.626-.750	16.0-19.1				1.000	25.4		
	AB8-14	M50388	.751-.875	19.2-22.2				1.125	28.6		
	AB8-16	M50390	.876-1.000	22.3-25.4				1.250	31.8		
LARGE FLANGE											
#30 (.129-.133) (3.28-3.38)	ABL4-2	M50314	.063-.125	1.7-3.2	#30 (.129-.133) (3.28-3.38)	.375 9.53	.065 1.65	.275	7.0	225 1000	315 1401
	ABL4-3	M50324	.126-.187	3.3-4.8				.337	8.6		
	ABL4-4	M50319	.188-.250	4.9-6.4				.400	10.2		
	ABL4-6	M50326	.313-.375	8.0-9.5				.525	13.3		
#20 (.160-.164) (4.06-4.16)	ABL5-4	M50338	.126-.250	3.2-6.4	#20 (.160-.164) (4.06-4.16)	.468 11.9	.070 1.78	.425	10.8	300 1334	470 2090
#11 (.192-.196) (4.88-4.98)	ABL6-4	M50348	.126-.250	3.3-6.4	#11 (.192-.196) (4.88-4.98)	.615 15.88	.090 2.08	.450	11.5	465 2068	700 3113
	ABL6-6	M50350	.251-.375	6.5-9.5				.575	14.6		
	ABL6-8	M50353	.376-.500	9.6-12.7				.700	17.8		
	ABL6-10	M50356	.501-.625	12.8-15.9				.825	21.0		
	ABL6-12	M50360	.626-.750	16.0-19.1				.950	24.2		
	ABL6-14	M50365	.751-.875	19.2-22.2				1.075	27.3		
	ABL6-16	M50367	.876-1.000	22.3-25.4				1.200	30.5		
120° COUNTERSUNK											
1/8" (.125) 3.2	AC4-2	M50313	.092-.125	2.3-3.2	#30 (.129-.133) (3.28-3.38)	.220 5.59	.031 1.14	.275	7.0	225 1000	315 1401
	AC4-3	M50316	.126-.187	3.3-4.8				.337	8.6		
	AC4-4	M50318	.188-.250	4.9-6.4				.400	10.2		
	AC4-5	M50323	.251-.312	6.5-9.5				.525	11.7		
5/32" (.156) 4.0	AC5-4	M50340	.188-.250	4.9-6.4	#20 (.160-.164) (4.06-4.16)	.281 7.2	.040 1.20	.425	10.8	300 1334	470 2090
	AC5-6	M50342	.251-.375	6.5-9.5				.550	14.0		
	AC5-8	M50343	.376-.500	9.6-12.7				.675	17.2		
3/16" (.187) 4.8	AC6-4	M50346	.151-.250	3.8-6.4	#11 (.192-.196) (4.88-4.98)	.350 8.89	.050 1.27	.407	10.3	465 2068	700 3113
	AC6-6	M50329	.251-.375	6.5-9.5				.575	14.6		
	AC6-8	M50306	.376-.500	9.6-12.7				.700	17.8		

KLIK-FAST RIVETS CONFORM TO IFI-114 (INCH) AND IFI-505 (METRIC). MILLIMETERS (MM) AND NEWTONS (N) ARE IN GREEN. ** ALSO AVAILABLE IN VARIOUS PACKAGED QUANTITIES.



Stainless Rivets

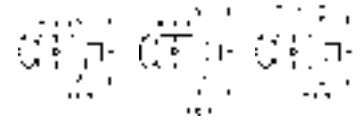

Stainless Rivet • Stainless Mandrel • IFI Grade 51

DIAMETER (MM)	HFS DESCRIPTION	BULK PART NO.**	GRIP RANGE		DRILL NO. & HOLE SIZE	H HEAD DIA NOM	E HEAD HEIGHT MAX	L RIVET LENGTH MAX		TYPICAL ULTIMATE STRENGTH (LBS.) (NEWTONS)	
			INCH	(MM)				INCH (MM)	INCH (MM)	INCH (MM)	SHEAR
BUTTONHEAD											
1/8" (.125) 3.2	SSB4-1S	M50411	.020-.062	.5-1.6	#30 (.129-.133) (3.28-3.38)	.250 6.35	.040 1.02	.212	5.4	520 2310	600 2660
	SSB4-2S	M50412	.063-.125	1.7-3.2				.275	7.0		
	SSB4-3S	M50415	.126-.187	3.3-4.8				.337	8.6		
	SSB4-4S	M50417	.188-.250	4.9-6.4				.400	10.2		
	SSB4-5S	M50420	.251-.312	6.5-7.9				.462	11.7		
	SSB4-6S	M50421	.313-.375	8.0-9.5				.525	13.4		
SSB4-8S	M50422	.376-.500	9.6-12.7	.650	16.5						
5/32" (.156) 4.0	SSB5-2S	M50432	.020-.125	.5-3.2	#20 (.160-.164) (4.06-4.16)	.312 7.92	.045 1.14	.300	7.6	785 3490	1040 4620
	SSB5-3S	M50434	.126-.187	3.3-4.8				.338	8.0		
	SSB5-4S	M50435	.188-.250	4.7-6.4				.425	10.8		
	SSB5-6S	M50436	.251-.375	6.5-9.5				.550	14.0		
	SSB5-8S	M50437	.376-.500	9.6-12.7				.675	17.2		
	SSB5-10S	M50427	.501-.625	12.8-15.9				.800	20.3		
3/16" (.187) 4.8	SSB6-2S	M50445	.020-.125	.5-3.2	#11 (.192-.196) (4.88-4.98)	.375 9.53	.066 1.40	.325	8.3	1150 5110	1300 5780
	SSB6-4S	M50447	.126-.250	3.3-6.4				.450	11.5		
	SSB6-6S	M50449	.251-.375	6.5-9.5				.575	14.6		
	SSB6-8S	M50450	.376-.500	9.6-12.7				.700	17.8		
	SSB6-10S	M50457	.501-.625	12.8-15.9				.825	21.0		
	SSB6-12S	M50458	.626-.750	16.0-19.1				.950	24.2		
SSB6-16S	M50466	.751-1.000	19.2-25.4	1.200	30.5						
1/4" (.250) 6.4	SSB8-4S	M50481	.126-.250	3.3-6.4	F (.257-.261) (6.53-6.63)	.500 12.70	.074 1.88	.500	12.7	1700 7560	2100 9340
	SSB8-6S	M50483	.251-.375	6.5-9.5				.625	15.9		
	SSB8-8S	M50485	.376-.500	9.6-12.7				.750	19.1		
	SSB8-10S	M50487	.501-.625	12.8-15.9				.875	21.0		
	SSB8-12S	M50489	.626-.750	16.0-19.1				1.000	25.4		
LARGE FLANGE											
1/8" (.125) 3.2	SSBL4-2S	M50409	.063-.125	1.7-3.2	#30 (.129-.133) (3.28-3.38)	.375 9.53	.045 1.14	.275	7.0	520 2310	600 2660
	SSBL4-3S	M50416	.126-.187	3.3-4.8				.337	8.6		
	SSBL4-4S	M50418	.188-.250	4.9-6.4				.400	10.2		
3/16" (.187) 4.8	SSBL6-4S	M50452	.126-.250	3.3-6.4	#11 (.192-.196) (4.88-4.98)	.615 15.88	.082 2.08	.450	11.5	1150 5110	1300 5780
	SSBL6-6S	M50453	.251-.375	6.5-9.5				.575	14.6		
	SSBL6-8S	M50456	.376-.500	9.6-12.7				.700	17.8		
	SSBL6-10S	M50451	.501-.625	12.8-15.9				.825	21.0		
	SSBL6-12S	M50455	.626-.750	16.0-19.1				.950	24.2		
120° COUNTERSUNK											
1/8" (.125) 3.2	SSC4-2S	M50423	.063-.125	2.3-3.2	#30 (.129-.133) (3.28-3.38)	.220 5.59	.031 1.14	.275	7.0	520 2310	600 2660
	SSC4-3S	M50424	.126-.187	3.3-4.8				.337	8.6		
	SSC4-4S	M50425	.188-.250	4.9-6.4				.400	10.2		
	SSC4-5S	M50426	.251-.312	6.5-7.9				.462	11.7		
3/16" (.187) 4.8	SSC6-4S	M50429	.151-.250	3.8-6.4	#11 (.192-.196) (4.88-4.98)	.350 8.89	.050 1.27	.407	10.3	1150 5110	1300 5780

KLK-FAST RIVETS CONFORM TO IFI-114 (INCH) AND IFI-505 (METRIC). MILLIMETERS (MM) AND NEWTONS (N) ARE IN GREEN. ** ALSO AVAILABLE IN VARIOUS PACKAGED QUANTITIES.

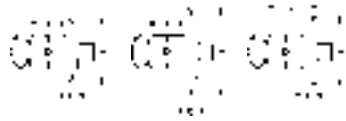

Stainless / Steel Rivets

Stainless Rivet • Coated Steel Mandrel • IFI Grade 50

DIAMETER (MM)	HFS DESCRIPTION	BULK PART NO.**	GRIP RANGE		DRILL NO. & HOLE SIZE	H HEAD DIA NOM	E HEAD HEIGHT MAX	L RIVET LENGTH MAX		TYPICAL ULTIMATE STRENGTH (LBS.) (NEWTONS)	
			INCH	(MM)				INCH (MM)	INCH (MM)	INCH (MM)	INCH (MM)
BUTTONHEAD											
1/8" (.125) 3.2	SSB4-1	M50511	.020-.062	.5-1.6	#30 (.129-.133) (3.28-3.38)	.250 6.35	.040 1.02	.212	5.4	520 2310	600 2660
	SSB4-2	M50512	.063-.125	1.7-3.2				.275	7.0		
	SSB4-3	M50515	.126-.187	3.3-4.8				.337	8.6		
	SSB4-4	M50517	.188-.250	4.9-6.4				.400	10.2		
	SSB4-5	M50526	.251-.312	6.5-7.9				.462	11.7		
	SSB4-6	M50521	.313-.375	8.0-9.5				.525	13.4		
	SSB4-8	M50522	.376-.500	9.6-12.7				.650	16.5		
5/32" (.156) 4.0	SSB5-2	M50532	.020-.125	.5-3.2	#20 (.160-.164) (4.06-4.16)	.312 7.92	.045 1.14	.300	7.6	785 3490	1040 4620
	SSB5-4	M50535	.188-.250	4.7-6.4				.425	8.0		
	SSB5-6	M50536	.251-.375	6.5-9.5				.550	14.0		
3/16" (.187) 4.8	SSB6-2	M50545	.020-.125	.5-3.2	#11 (.192-.196) (4.88-4.98)	.375 9.53	.055 1.40	.325	8.3	1150 5110	1300 5780
	SSB6-4	M50547	.126-.250	3.3-6.4				.450	11.5		
	SSB6-6	M50549	.251-.375	6.5-9.5				.575	14.6		
	SSB6-8	M50550	.376-.500	9.6-12.7				.700	17.8		
	SSB6-10	M50557	.501-.625	12.8-15.9				.825	21.0		
	SSB6-12	M50558	.626-.750	16.0-19.1				.950	24.2		
	SSB6-16	M50566	.751-1.000	19.2-25.4				1.120	30.5		
LARGE FLANGE											
1/8" (.125) 3.2	SSBL4-2	M50513	.063-.125	1.7-3.2	#30 (.129-.133) (3.28-3.38)	.375 9.53	.045 1.14	.275	7.0	520 2310	600 2660
	SSBL4-3	M50518	.126-.187	3.3-4.8				.337	8.6		
	SSBL4-4	M50519	.188-.250	4.9-6.4				.400	10.2		
3/16" (.187) 4.8	SSBL6-4	M50548	.126-.250	3.3-6.4	#11 (.192-.196) (4.88-4.98)	.615 15.88	.082 2.08	.450	11.5	1150 5110	1300 5780
	SSBL6-6	M50553	.251-.375	6.5-9.5				.575	14.6		
	SSBL6-8	M50556	.376-.500	9.6-12.7				.700	17.8		
	SSBL6-10	M50551	.501-.625	12.8-15.9				.825	21.0		
	SSBL6-12	M50555	.626-.750	16.0-19.1				.950	24.2		
120° COUNTERSUNK											
1/8" (.125) 3.2	SSC4-2	M50523	.092-.125	2.3-3.2	#30 (.129-.133) (3.28-3.38)	.220 5.59	.031 1.14	.275	7.0	520 2310	600 2660
	SSC4-3	M50524	.126-.187	3.3-4.8				.337	8.6		
	SSC4-4	M50525	.188-.250	4.9-6.4				.400	10.2		
	SSC4-5	M50528	.251-.312	6.5-7.9				.462	11.7		
3/16" (.187) 4.8	SSC6-4	M50529	.151-.250	3.8-6.4	#11 (.192-.196) (4.88-4.98)	.350 8.89	.050 1.27	.407	10.3	1150 5110	1300 5780

KLIK-FAST RIVETS CONFORM TO IFI-114 (INCH) AND IFI-505 (METRIC). MILLIMETERS (MM) AND NEWTONS (N) ARE IN GREEN. ** ALSO AVAILABLE IN VARIOUS PACKAGED QUANTITIES.

Closed-End Rivets

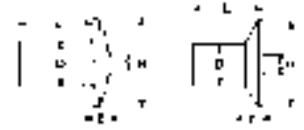

5056 Aluminum / Stainless • IFI Grade 19											
DIAMETER (MM)	HFS DESCRIPTION	BULK PART NO.**	GRIP RANGE		DRILL NO. & HOLE SIZE	H HEAD DIA NOM	E HEAD HEIGHT MAX	L RIVET LENGTH MAX		TYPICAL ULTIMATE STRENGTH (LBS.) (NEWTONS)	
			INCH	(MM)				INCH (MM)	INCH (MM)	INCH (MM)	INCH (MM)
BUTTONHEAD											
1/8" (.125) 3.2	AB4-1C	M56000	.020-.062	.5-1.6	#30 (.129-.133)	.236 5.99	.050 1.27	.297	7.54	240	280
	AB4-2C	M56001	.063-.125	1.7-3.2				.360	9.14		
	AB4-3C	M56002	.126-.187	3.3-4.8				.422	10.72		
	AB4-4C	M56003	.188-.250	4.9-6.4				.485	12.32		
	AB4-5C	M56004	.251-.312	6.5-7.9				.547	13.89		
	AB4-6C	M56015	.313-.375	8.0-9.5				.610	15.50		
5/32" (.157) 4.0	AB5-2C	M56005	.020-.125	.51-3.2	#20 (.160-.164)	.315 8.00	.065 1.65	.375	9.53	350	480
	AB5-3C	M56006	.126-.187	3.3-4.8				.437	11.10		
	AB5-5C	M56007	.188-.312	4.9-6.35				.562	12.70		
3/16" (.188) 4.8	AB6-2C	M56008	.020-.125	.51-3.2	#11 (.192-.196)	.374 9.50	.080 2.03	.406	10.31	500	690
	AB6-4C	M56009	.126-.250	3.3-4.75				.531	11.89		
	AB6-6C	M56010	.251-.375	6.5-9.5				.656	16.66		
	AB6-8C	M56011	.376-.500	9.6-12.7				.781	19.84		
	AB6-10C	M56012	.501-.625	12.8-15.9				.906	23.01		
1/4" (.252) 6.4	AB8-4C	M56013	.126-.250	3.2-6.4	F (.257-.261)	.512 13.0	.090 2.29	.570	14.48	900	1100
	AB8-6C	M56014	.251-.375	6.5-9.5				.695	17.65		
120° COUNTERSUNK											
1/8" (.125) 3.2	AC4-2C	M56016	.063-.125	1.7-3.2	#30 (.129-.133)	.236 5.99	.050 1.27	.395	10.03	240	280
	AC4-3C	M56017	.126-.187	3.3-4.8				.457	11.61		
	AC4-4C	M56018	.188-.250	4.9-6.4				.520	13.21		
3/16" (.188) 4.8	AC6-4C	M56019	.126-.250	3.3-4.75	#11 (.192-.196)	.374 9.50	.540 13.72	.601	13.67	500 2224	690 3070
ALL ALUMINUM BUTTONHEAD - IFI GRADE 9											
1/8" (.125) 3.2	AB4-2AC	M56201	.063-.125	1.7-3.2	#30 (.129-.133)	.236 5.99	.050 1.27	.360	9.14	100	110
	AB4-3AC	M56202	.126-.187	3.3-4.8				.422	10.72		
	AB4-4AC	M56203	.188-.250	4.9-6.4				.485	12.32		
5/32" (.157) 4.0	AB5-4AC	M56207	.126-.250	3.3-4.75	#20 (.160-.164)	.315 8.00	.065 1.65	.500	11.10 12.70	130 578	160 712
3/16" (.188) 4.8	AB6-2AC	M56208	.020-.125	.51-3.2	#11 (.192-.196)	.374 9.50	.080 2.03	.406	10.31	210	250
	AB6-4AC	M56209	.126-.250	3.3-4.75				.531	11.89		
	AB6-6AC	M56210	.251-.375	6.5-9.5				.656	16.66		
	AB6-8AC	M56211	.376-.500	9.6-12.7				.781	19.84		
	AB6-10AC	M56022	.501-.625	12.8-15.9				.906	23.01		
ALL STAINLESS BUTTONHEAD - IFI GRADE 51											
1/8" (.125) 3.2	SSB4-2SC	M56403	.020-.125	.51-3.2	#30 (.129-.133)	.236 5.99	.039 .990	.360	9.14	400	450
	SSB4-3SC	M56405	.126-.187	3.3-4.8				.422	10.72		
	SSB4-4SC	M56406	.188-.250	4.9-6.4				.485	12.32		
3/16" (.188) 4.8	SSB6-2SC	M56408	.020-.125	.51-3.2	#11 (.192-.196)	.374 9.49	.070 1.77	.406	10.31	850	900
	SSB6-4SC	M56409	.126-.250	3.3-4.75				.531	11.89		
	SSB6-6SC	M56410	.251-.375	6.5-9.5				.656	16.66		
	SSB6-8SC	M56411	.376-.500	9.6-12.7				.781	19.84		
	SSB6-10SC	M56412	.501-.625	12.8-15.9				.906	23.01		

NOTE: A SLIGHTLY SMALLER MANDREL DIAMETER IS REQUIRED FOR CLOSED-END RIVETS; THEREFORE WHEN SETTING CLOSED-END RIVETS USING MARSON BRAND RIVET SETTING TOOLS, WE RECOMMEND YOU USE ONE SIZE SMALLER NOSEPIECE WHEN POSSIBLE (I.E., TO SET 1/8" RIVETS, USE 3/32" NOSEPIECE).

KLIK-FAST RIVETS CONFORM TO IFI-114 (INCH) AND IFI-505 (METRIC). MILLIMETERS (MM) AND NEWTONS (N) ARE IN GREEN. ** ALSO AVAILABLE IN VARIOUS PACKAGED QUANTITIES.

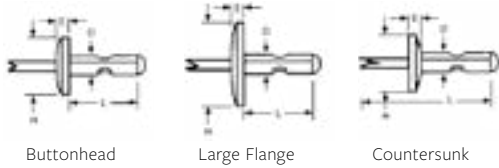

Multi-Grip Rivets

Plated Steel Rivet • Steel Mandrel

DIAMETER (MM)	HFS DESCRIPTION	BULK PART NO.**	GRIP RANGE		DRILL NO. & HOLE SIZE	H HEAD DIA NOM	E HEAD HEIGHT MAX	L RIVET LENGTH MAX		TYPICAL ULTIMATE STRENGTH (LBS.) (NEWTONS)	
			INCH	(MM)				INCH (MM)	INCH (MM)	INCH (MM)	SHEAR
STEEL BUTTONHEAD											
1/8" (.125) 3.2	SB41-42MG	M56112	.043-.156	1.1-4.0	#30 (.129-.133) (3.28-3.38)	.283 7.20	.033 .850	.355	9.0	340 1510	385 1710
5/32" (.156) 4.0	SB52-53MG	M56134	.056-.196	1.4-5.0	#20 (.160-.164) (4.06-4.16)	.319 8.10	.047 1.20	.433	11.0	440 1960	530 2360
3/16" (.187) 4.8	SB62-63MG	M56146	.047-.187	1.2-4.8	#11 (.192-.196) (4.88-4.98)	.386 9.80	.069 1.75	.405 .500	10.3 12.7	810	750
	SB63-64MG	M56147	.156-.250	4.0-6.3						3605	3335
ALUMINUM / STEEL BUTTONHEAD†											
1/8" (.125) 3.2	AB41-43MG	M56315	.031-.187	.8-4.8	#30 (.129-.133) (3.28-3.38)	.250 6.35	.037 .95	.315 .375 .438 .500	8.0 9.5 11.1 12.7	165 735	230 1025
	AB42-44MG	M56317	.046-.250	1.2-6.4							
	AB44-45MG	M56320	.156-.312	4.0-7.9							
	AB45-46MG	M56321	.216-.375	5.5-9.5							
5/32" (.156) 4.0	AB52-54MG	M56335	.046-.250	1.2-6.4	#20 (.160-.164) (4.06-4.16)	.312 7.92	.047 1.20	.375 .500 .666	9.5 12.7 16.9	255 1135	375 1670
	AB54-56MG	M56336	.156-.375	4.0-9.5							
	AB56-58MG	M56337	.250-.500	6.4-12.7							
3/16" (.187) 4.8	AB62-64MG	M56347	.062-.250	1.6-6.4	#11 (.192-.196) (4.88-4.98)	.386 9.80	.057 1.45	.406 .595 .666 .978	10.3 15.1 16.9 24.8	350 1560	530 2360
	AB63-67MG	M56351	.187-.437	4.8-11.1							
	AB66-68MG	M56352	.250-.500	6.4-12.7							
	AB610-612MG	M56359	.500-.781	12.7-19.8							
ALUMINUM / STEEL LARGE FLANGE											
1/8" (.125) 3.2	ABL42-43MG	M56314	.031-.187	.8-4.8	#30 (.129-.133) (3.28-3.38)	.325 8.25	.039 1.00	.315 .375 .438	8.0 9.5 11.1	165 735	230 1025
	ABL42-44MG	M56319	.046-.250	1.2-6.4							
	ABL44-45MG	M56322	.156-.312	4.0-7.9							
5/32" (.156) 4.0	ABL52-54MG	M56241	.062-.250	1.6-6.4	#20 (.160-.164) (4.06-4.16)	.374 9.50	.051 1.30	.375 .438 .690	9.5 11.1 17.5	255 1135	375 1670
	ABL53-55MG	M56340	.125-.312	3.2-7.9							
	ABL55-58MG	M56342	.251-.500	6.4-12.7							
3/16" (.187) 4.8	ABL62-64MG	M56350	.062-.250	1.6-6.4	#11 (.192-.196) (4.88-4.98)	.625 15.85	.069 1.75	.406 .666 .978	10.3 16.9 24.8	350 1560	530 2360
	ABL66-68MG	M56353	.250-.500	6.4-12.7							
	ABL610-612MG	M56360	.500-.781	12.7-19.8							
ALUMINUM / STEEL 120° COUNTERSUNK											
1/8" (.125) 3.2	AC43-44MG	M56318	.093-.250	2.4-6.4	#30 (.129-.133) (3.28-3.38)	.209 5.30	.029 .75	.383	9.7	155 690	206 912
5/32" (.156) 4.0	AC53-55MG	M56357	.109-.312	2.7-7.9	#20 (.160-.164) (4.06-4.16)	.252 6.40	.049 1.24	.470	11.9	255 1135	300 1670
3/16" (.187) 4.8	AC62-65MG AC66-68MG	M56361 M56362	.062-.312 .250-.500	1.6-7.9 6.4-12.7	#11 (.192-.196) (4.88-4.98)	.345 8.75	.051 1.30	.500 .690	12.7 17.5	350 1560	530 2360

†COUNTERSUNK—TOTAL LENGTH (L) INCLUDING HEAD. MILLIMETERS (MM) AND NEWTONS (N) ARE IN GREEN.
**ALSO AVAILABLE IN PACKAGED QUANTITIES. *KLIK-FAST MULTI-GRIP RIVETS CONFORM TO IFI-116.

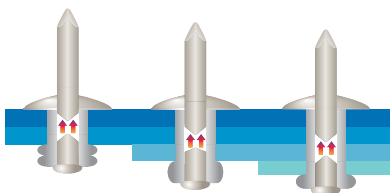

Multi-grip rivets provide an effective and economical alternative to other, more costly methods of fastening, because one size handles the grip range capacity of up to 3 standard open end rivets. Multi-grip rivets can be used in any application requiring open end rivets, while reducing inventory requirements. Use multi-grip rivets as a standard open-end rivet — no special tool is needed.

Specialty Rivets



Tri-Bulb

Painted

#110 Copper / Brass and #110 Copper / Steel

DIAMETER (MM)	HFS DESCRIPTION	BULK PART NO.**	GRIP RANGE		DRILL NO. & HOLE SIZE	H HEAD DIA NOM	E HEAD HEIGHT MAX	L RIVET LENGTH MAX		TYPICAL ULTIMATE STRENGTH (LBS.) (NEWTONS)		
			INCH	(MM)				INCH (MM)	INCH (MM)	INCH (MM)	SHEAR	TENSILE
PLATED MANDREL												
1/8" (.125) 3.2	CB4-2B CB4-4B	M58600 M58602	.063-.125 .188-.250	1.7-3.2 4.9-6.4	#30 (.129-.133) 3.3 (3.28-3.38)	.250 6.35	.040 1.02	.275 .400	7.0 10.2	215 950	300 1330	
1/8" (.125) 3.2	CB4-2C CB4-4C	M56600 M56602	.063-.125 .188-.250	1.7-3.2 4.9-6.4	#30 (.129-.133) 3.3 (3.28-3.38)	.250 6.35	.040 1.02	.275 .400	7.0 10.2	215 950	300 1330	

B - COPPER / BRASS; C - COPPER / STEEL (PLATED MANDREL) **ALSO AVAILABLE IN PACKAGED QUANTITIES.

TRI-BULB RIVETS

DIAMETER	HFS DESCRIPTION	GRIP RANGE	DRILL NO. AND HOLE SIZE	A	E	H	N	Y	SHEAR		TENSILE	
									LBS.	NEWTONS	LBS.	NEWTONS
5/32" (.156)	A0516ATB A0523ATB	.039-.118 .039-.276	#20 (.160-.164)	.091 .091	.055 .055	.315 .315	.630 .835	.236 .335	134 134	600 600	224 224	1000 1000
3/16" (.187)	A0619ATB A0622ATB A0625ATB A0630ATB AL0625ATB	.039-.157 .039-.248 .039-.354 .157-.472 .039-.354	#11 (.192-.196)	.115 .115 .115 .115 .115	.071 .071 .071 .071 .079	.386 .386 .386 1.063 .551	.720 .807 .925 1.063 .925	.276 .335 .374 .433 .374	202 202 202 202 202	900 900 900 900 900	269 269 269 269 269	1200 1200 1200 1200 1200

FOR BLACK RIVETS ADD BL TO THE PART NUMBER. WHITE AVAILABLE AS SPECIAL ORDER ITEM. REFER TO PRICE LIST FOR BULK PART NUMBER.

PAINTED RIVETS*

DIAMETER (MM)	HFS DESCRIPTION	BULK PART NO.**	RIVET COLOR	GRIP RANGE		DRILL NO. & HOLE SIZE	H HEAD DIA NOM	E HEAD HEIGHT MAX	L RIVET LENGTH MAX		TYPICAL ULTIMATE STRENGTH (LBS.) (NEWTONS)	
				INCH	(MM)				INCH (MM)	INCH (MM)	INCH (MM)	SHEAR
1/8" (.125) 3.2	AB4-2AW AB4-3AW AB4-4AW	M53032 M53007 M53009	W	.062-.125 .126-.187 .188-.250	1.7-3.2 3.2-4.8 4.9-6.4	#30 (.129-.133) 3.3 (3.28-3.38)	.250 6.35	.040 1.02	.275 .337 .400	7.0 8.6 10.2	155 689	240 1067
1/8" (.125) 3.2	AB4-2ABR AB4-3ABR AB4-4ABR	M53097 M53081 M53099	BR	.062-.125 .126-.187 .188-.250	1.7-3.2 3.2-4.8 4.9-6.4	#30 (.129-.133) 3.3 (3.28-3.38)	.275 .337	.040 1.02	.275 .337 .400	7.0 8.6 10.2	155 689	240 1067
1/8" (.125) 3.2	AB4-2ABL AB4-3ABL AB4-4ABL	M53098 M53102 M53100	BL	.062-.125 .126-.187 .188-.250	1.7-3.2 3.2-4.8 4.9-6.4	#30 (.129-.133) 3.3 (3.28-3.38)	.275 .337	.040 1.02	.275 .337 .400	7.0 8.6 10.2	155 689	240 1067
1/8" (.125) 3.2	SB4-2W SB4-3W SB4-4W	M53033 M53034 M53036	W	.062-.125 .126-.187 .188-.250	1.7-3.2 3.2-4.8 4.9-6.4	#30 (.129-.133) 3.3 (3.28-3.38)	.275 .337	.040 1.02	.275 .337 .400	7.0 8.6 10.2	305 1356	410 1823
1/8" (.125) 3.2	SB4-2BR SB4-3BR SB4-4BR	M53003 M53011 M53012	BR	.062-.125 .126-.187 .188-.250	1.7-3.2 3.2-4.8 4.9-6.4	#30 (.129-.133) 3.3 (3.28-3.38)	.275 .337	.040 1.02	.275 .337 .400	7.0 8.6 10.2	305 1356	410 1823
1/8" (.125) 3.2	SB4-2BL SB4-4BL	M53060 M53051	BL	.062-.125 .188-.250	1.7-3.2 3.2-4.8	#30 (.129-.133) 3.3 (3.28-3.38)	.275	.040 1.02	.275 .400	7.0 10.2	330 1467	515 2290

*CUSTOM COLORS AVAILABLE; CONTACT FACTORY FOR ADDITIONAL INFORMATION. PAINTED RIVETS WORK BEST WHEN HOLE SIZE IS AT THE HIGH END OF TOLERANCE TO ALLOW FOR PAINT. **ALSO AVAILABLE IN PACKAGED QUANTITIES.

BACK-UP WASHERS

HFS DESCRIPTION	STANDARD CARTON QTY.	BULK PART NO.**	500 PACK NO.	MATERIAL	FOR HOLE SIZE	SIZE / SHAPE
SS-3	5M	M50653	M40653	STEEL	3/32"	1/2" SQ
SS-4	5M	M50654	M40654	STEEL	1/8"	1/2" SQ
SS-6	5M	M50656	M40656	STEEL	3/16"	1/2" SQ
SS-8	10M	M50658	M40658	STEEL	1/8"	3/8" RD
SS-9	10M	M50655	M40655	STEEL	5/32"	7/16" RD
SS-10	10M	M50661	M40661	STEEL	3/16"	1/2" RD
SS-12	10M	M50662	M40662	STEEL	1/4"	1/2" RD
AS-8	10M	M50657	M40657	ALUMINUM	1/8"	3/8" RD
AS-9	10M	M50659	M40659	ALUMINUM	5/32"	7/16" RD
AS-10	10M	M50660	M40660	ALUMINUM	3/16"	1/2" RD
AS-12	10M	M50665	M40665	ALUMINUM	1/4"	1/2" RD

Back-up washers are .056"-.062" thick. They are used when fastening soft materials or to compensate for oversize holes.



Double-Ended Drill Bit / M39100

This double-ended drill bit provides the correct size hole and angle for 1/8" diameter countersink rivets, drilling and countersinking in one operation.



**ALSO AVAILABLE IN PACKAGED QUANTITIES.

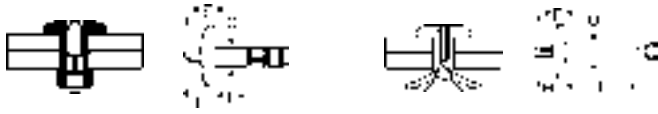

Specialty Rivets

Steel Q-Lok™ Rivets

DIAMETER (MM)	HFS DESCRIPTION	BULK PART NO.**	GRIP RANGE		DRILL NO. & HOLE SIZE	H HEAD DIA NOM	E HEAD HEIGHT MAX	L RIVET LENGTH MAX		TYPICAL ULTIMATE STRENGTH (LBS.) (NEWTONS)	
			INCH	(MM)		INCH (MM)	INCH (MM)	INCH (MM)	INCH	(MM)	SHEAR
PLATED STEEL BODY PLATED STEEL MANDREL											
3/16" (.187) 4.8	SB6-2QL	M55145	.062-.125	2.3-3.2	#11(.192-.196) (4.88-4.98)	.375	.065	.350	8.9	1050 4670	825 3670
	SB6-4QL	M55147	.126-.250	3.3-6.4		.475	.725	12.0			
	SB6-6QL	M55149	.251-.375	6.5-9.5		.600	.725	15.2			
	SB6-8QL	M55152	.376-.500	9.6-12.7		.725	.725	18.4			

T-Rivets / Klik-Split™

ALUMINUM/STEEL**											
1/4" (.250) 6.4	—	M52372	.062-.125	1.58-3.18	F (.257-.261) (.653-6.63)	.500	.120	.520	13.22	1500 6670	1000 4445
		M52371	.032-.140	.81-3.56				.520	13.22		
		M52368	.251-.312	6.38-7.93				.707	17.79		
		M52369	.312-.375	7.95-9.53				.770	19.56		
		M52370	.376-.437	9.55-11.10				.832	21.13		
		M50376	.520-.620	13.21-15.97				.960	24.38		

Automotive / Special Application Rivets

HFS DESCRIPTION	BULK PART NO.*	GRIP RANGE	DESCRIPTION	MATERIALS BODY/MANDREL	RIVET DIA NOM	FLANGE DIA NOM	HOLE DIA RANGE	500 PACK NO.
TRIM RIVETS								
ABN4-3A	M50261***	.126-.187	TRIM MOULDING RIVET	ALUM/ALUM	.125	.208	.129-.133	M40261
ABN4-4A	M50262***	.188-.250	LONG TRIM MOULDING RIVET	ALUM/ALUM	.125	.208	.129-.133	M40262
SSBN4-3	M50516***	.126-.187	TRIM MOULDING RIVET W/SS BODY	SS/STEEL	.125	.208	.129-.133	M40516

Klik-Split™ Window and Door Rivets*

ALUMINUM/STEEL**								50 PACK NO.
—	M52371	.032-.140	WINDOW REGULATOR RIVET	ALUM/STEEL	.250	.500	.257-.261	M42371
—	M52372	.090-.115	OUTSIDE DOOR HANDLE RIVET WITH RECESSED HEAD	ALUM/STEEL	.250	.500	.257-.261	M42372
—	M52373	.110-.177	DOOR HANDLE RIVET WITH RECESSED HEAD AND ZINC COATED MANDREL	ALUM/STEEL	.250	.500	.257-.261	M42373
—	M52374	.140-.187	WINDOW REGULATOR RIVET WITH YELLOW ZINC COATED MANDREL	ALUM/STEEL	.250	.500	.257-.261	M42374
—	M52375	.090-.115	BLACK ANODIZED DOOR HANDLE RIVET	ALUM/STEEL	.250	.500	.257-.261	M42375
—	M50376	.520-.620	GLASS STOP RIVET	ALUM/STEEL	.250	.500	.257-.261	M42376

Miscellaneous Rivets

ALUMINUM/STEEL**								50 PACK NO.
—	M53150	.250-.375	BUMPER FASCIA RIVET LARGE FLANGE BLACK	STEEL/STEEL	.187	.625	.192-.196	M43150
—	M53353	.125-.187	TRUNK LOCK SWIVEL EMBLEM RIVET SEALED END, COUNTERSUNK HEAD	ALUM/STEEL	.156	.312	.160-.164	M43353
ALUMINUM/STEEL**								100 Pack No.
—	M53295	.125-.187	REAR WINDOW GASKET RIVET	ALUM/STEEL	.125	.325	.129-.130	M43295
—	M53181	.125-.250	BUMPER FASCIA RIVET W/YELLOW ZINC COATED MANDREL	STEEL/STEEL	.250	.500	.257-.261	M43181

*ALSO AVAILABLE IN PACKAGED QUANTITIES. **REQUIRES NOSEPIECE No. M96028 WHEN USING THE MARSON BRAND BIG DADDY® OR BIG DADDY II HAND TOOL. ***USE 39112 TRIM CLIP RIVET NOSEPIECES WITH HP-2 OR HP-3 TO FORM TRIM CLIP STUDS WITH 50261, 50262 AND 50516 RIVETS.

KLIK-FAST RIVETS CONFORM TO IFI-130 (INCH) AND IFI-505 (METRIC). MILLIMETERS (MM) AND NEWTONS (N) ARE IN GREEN.

Klik-Lock® Rivets

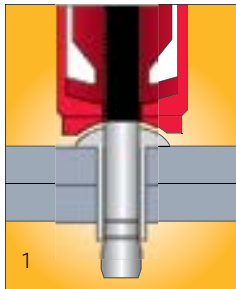
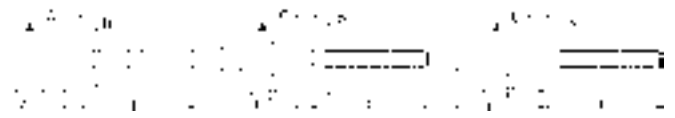

1 After drilling hole to proper diameter, rivet is placed into hole and rivet setting tool is placed over mandrel.

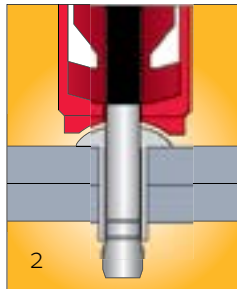

2 Actuating tool starts mandrel into rivet body, pulling work material together and expanding body on the blind side.

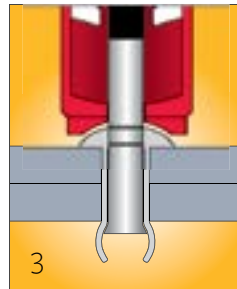

3 Solid circle lock is created between the body and mandrel, creating a weather-resistant assembly that virtually eliminates pin pushout.

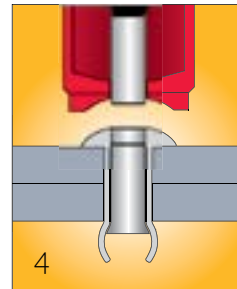

4 After the mandrel is broken, the mandrel is flush with the rivet body, removing the need for grinding.



5 The expansion of the body tightly fills the hole, creating a weather-resistant joint.

Steel • IFI Grade 19

HFS DESCRIPTION	BULK PART NO.**	GRIP RANGE		A RIVET DIA INCH	REQUIRED HOLESIZE	B HEAD DIA	C HEAD HEIGHT MAX	D BODY LENGTH MAX		E OVERALL LENGTH MAX		F LENGTH MIN		AVERAGE STRENGTH (LBS.) (NEWTONS)	AVERAGE STRENGTH (LBS.) (NEWTONS)
		INCH	(MM)	INCH (MM)	INCH (MM)	INCH (MM)	INCH (MM)	INCH	(MM)	INCH	(MM)	INCH	(MM)	SHEAR	TENSILE
STEEL RIVET • STEEL MANDREL • BUTTONHEAD															
SB6-4KL	M50807	.062-.270	1.57-6.85	.187	.191-.201	.385	.085	.415	10.45	.733	15.87	.980	23.06	1450	1200
SB6-7KL	M50808	.214-.437	5.43-11.09	4.8	4.9-5.10	9.77	2.15	.582	14.78	.892	22.66	.968	24.39	6499	5338
SB6-EKL	M50809	.062-.437	1.57-11.09					.582	14.78	1.031	26.19	.991	25.17		
SB8-6KL	M50810	.080-.375	2.03-9.52	.253	.261-.272	.530	.120	.560	14.62	.984	24.99	1.043	26.49	2750	2200
SB8-10KL	M50811	.350-.625	8.89-15.75	6.5	6.6-6.9	13.46	3.05	.810	20.57	1.234	31.34	1.043	26.49	12233	9786
SB8-EKL	M50812	.080-.625	2.03-15.87					.810	20.57	1.419	36.04	1.043	26.49		
LARGE FLANGE															
SBL6-4KL	M50813	.062-.270	1.57-6.85	.187	.191-.201	.530	.095	.415	10.45	.733	18.62	.973	24.71	1450	1200
SBL6-EKL	M50814	.062-.437	1.57-11.09	4.8	4.9-5.1	13.46	2.41	.582	14.78	1.031	26.19	.984	24.99	6499	5338
SBL8-6KL	M50815	.80-.375	2.03-9.52	.253	.261-.272	.592	.120	.560	14.62	.984	24.99	1.043	26.49	2750	2200
				6.4	6.6-6.9	15.04	3.05							12233	9786
100° COUNTERSUNK															
SC6-6KL	M50816	.125-.331	3.17-8.40	.187	.191-.201	.350	.080	.490	12.45	.809	20.55	.987	25.07	1450	1200
SC6-9KL	M50818	.305-.500	7.74-12.70	4.8	4.9-5.1	8.9	2.03	.660	16.76	.968	24.59	.975	24.77	6499	5338
SC8-8KL	M50819	.160-.475	4.06-12.06	.253	.261-.272	.410	.090	.665	16.89	1.089	27.66	1.055	26.80	2750	2200
SC8-12KL	M50820	.415-.725	10.54-18.41	6.4	6.6-6.9	10.4	2.29	.915	23.24	1.339	34.01	1.055	26.80	12233	9786

Stainless Steel • IFI Grade 19

HFS DESCRIPTION	BULK PART NO.**	GRIP RANGE	A RIVET DIA.	REQUIRED HOLE SIZE	B HEAD DIA.	C HEAD HEIGHT MAX	D BODY LENGTH MAX	E OVERALL LENGTH	F LENGTH MIN	AVERAGE SHEAR STRENGTH LBS.	AVERAGE TENSILE STRENGTH LBS.
		INCH(MM)	INCH(MM)	INCH(MM)	INCH(MM)	INCH(MM)	INCH(MM)	INCH(MM)	INCH(MM)	LBS.(NEWTONS)	LBS.(NEWTONS)
STAINLESS RIVET • STAINLESS MANDREL • BUTTONHEAD											
SSB6-4SKL	M50833	.062-.270 1.57-6.85					.415 10.54	.773 15.87	.980 23.06		
SSB6-7SKL	M50834	.214-.437 5.43-11.09	.187 4.8	.191-.201 4.9-5.1	.385 9.8	.085 2.15	.582 14.78	.892 22.66	.968 24.39	1400 6228	1100 4893
SSB6-ESKL	M50835	.062-.437 1.57-11.09					.582 14.78	1.031 26.19	.991 25.17		
SSB8-6SKL	M50836	.080-.375 2.03-9.52	.253 6.5	.261-.272 6.6-6.9	.530 13.46	.120 3.05	.560 14.62	.984 24.99	1.043 26.49	2500 11121	2000 8896
SSB8-10SKL	M50837	.350-.625 8.89-15.87					.810 20.57	1.234 31.34	1.043 26.49		
100° COUNTERSUNK											
SSC6-6SKL	M50838	.125-.331 3.17-8.40	.187 4.8	.191-.201 4.9-5.1	.350 8.8	.080 1.8	.490 12.45	.809 20.55	.987 25.07	1400 6228	1100 4893
SSC8-8SKL	M50839	.160-.475 4.06-12.06	.253 6.5	.261-.272 6.6-6.9	.410 10.4	.090 2.29	.665 14.62	1.089 27.66	1.055 26.80	2750 12233	2200 12233

5056 Aluminum • IFI Grade 19

ALUMINUM RIVET • ALUMINUM MANDREL • BUTTONHEAD											
AB6-4AKL	M50821	.062-.270 1.57-6.85					.415 10.54	.733 15.87	.980 23.06		
AB6-7AKL	M50822	.214-.437 5.43-11.09	.187 4.8	.191-.201 4.9-5.1	.385 9.8	.085 2.15	.582 14.78	.892 22.66	.968 24.39	700 3114	580 2580
AB6-AEKL	M50823	.062-.437 1.57-11.09					.582 14.78	1.031 26.19	.991 25.17		
AB8-6AKL	M50824	.080-.375 2.03-9.52					.560 14.62	.984 24.99	1.043 26.49		
AB8-10AKL	M50825	.350-.625 8.89-15.87	.253 6.4	.261-.272 6.6-6.9	.530 13.46	.120 3.05	.810 20.57	1.234 31.34	1.013 26.49	1300 5783	950 4226
AB8-AEKL	M50826	.080-.625 2.03-15.87					.810 20.57	1.419 36.04	1.043 26.49		
ALUMINUM / LARGE FLANGE											
ABL6-4AKL	M50827	.062-.270 1.57-6.85	.187 4.8	.191-.201 4.9-5.1	.530 13.46	.085 2.15	.415 10.45	.733 15.87	.973 24.71	700 3114	580 2580
ABL6-7AKL	M50828	.214-.437 5.43-11.09					.572 14.52	.892 22.66	.984 24.99		
ALUMINUM / 100° COUNTERSUNK											
AC6-6AKL	M50829	.125-.331 3.17-8.40	.187 4.8	.191-.201 4.9-5.1	.350 8.9	.080 1.8	.490 12.45	.809 20.55	.987 25.07	700 3114	580 2580
AC6-9AKL	M50830	.305-.500 7.74-12.70					.660 16.76	.968 24.09	.975 24.77		
AC8-8AKL	M50831	.160-.475 4.06-12.06	.253 6.4	.261-.272 6.6-6.9	.410 10.4	.090 2.29	.665 16.89	1.089 27.66	1.055 26.80	1300 5783	950 4226
AC8-12AKL	M50832	.415-.725 10.54-18.41					.915 23.24	1.339 34.01	1.055 26.80		

PIN RETENTION VALUES

SIZE	STEEL LBS.	ALUMINUM LBS.	STAINLESS STEEL LBS.
3/16"	300	50	125
1/4"	500	100	250

MATERIAL AND FINISH

MATERIAL	SLEEVE	PIN	SLEEVE FINISH	PIN FINISH
STEEL	LOW	MEDIUM	ZINC PLATED	ZINC PLATED CLEAR TRIVALENT CHROMATE
	CARBON STEEL	CARBON STEEL	CLEAR CHROMATE	ZINC PLATED CLEAR TRIVALENT CHROMATE
ALUMINUM	5056	7075	CLEAR CHROMATE	CLEAR TRIVALENT CHROMATE
STAINLESS	302	305/304	PASSIVATED	DRY LUBRICATED

MILLIMETERS (MM) AND NEWTONS (N) ARE IN GREEN. **ALSO AVAILABLE IN PACKAGED QUANTITIES.



Plastic Rivets and Tools

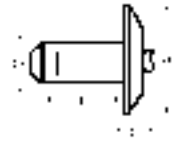

Klik-Lock® Plastic Rivets • Nylon Body ST801HS • Delrin 500 Mandrel

Marson brand Klik-Lock Plastic Rivets are the same precision-molded all-nylon rivets used by domestic auto manufacturers, both for original equipment and replacement parts. In addition, Klik-Lock Plastic Rivets are ideal for non-conductive and non-corrosive environments. Klik-Lock Plastic Rivets fasten plastic to plastic, plastic to metal and plastic to fiberglass. As they set, three “legs” form to securely lock the components in place and prevent pullout.

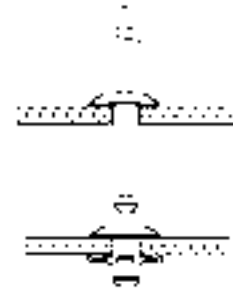

Plastic rivet before and after set

Plastic Rivet Tools

Klik-Lock® KL-2 Plastic Rivet Setter / M48005

This long-reach tool is just what today’s professional needs for hard-to-reach spots, especially in automotive applications such as flexible bumpers, wheel wells, license plate brackets and bumper reinforcements. In addition to the tool’s long reach, it offers one-stroke setting and a universal nosepiece that sets all plastic rivets. The tool is packaged in a reusable, heavy-duty vinyl pouch. Weight: .75 lb.



Professional Plastic Rivet Kit / M48006

This kit includes the versatile KL-2 Plastic Rivet Setter, plus a 20-pack each of our four most popular rivet sizes: Nos. M58106, M58108, M58149 and M58150. A reclosable carton provides storage for rivets and tool. Weight: 1.5 lbs.

Plastic Rivets

Klik-Lock™ Plastic Rivets • Nylon Body ST801HS • Delrin 500 Mandrel

DIAGRAM REFERENCE	100-PACK PART NO.*	GRIP RANGE		D RIVET DIA NOM INCH	HOLE SIZE		H HEAD DIA		E HEAD HEIGHT		RIVET LENGTH		TYPICAL ULTIMATE STRENGTH (LBS.)			
		INCH	(MM)		INCH	(MM)	INCH	(MM)	INCH	(MM)	MAX INCH	(MM)	SHEAR	(N)	TENSILE	(N)
A	M48286	.236-.413	6.0-10.5	.154	.156	4	.315	8	.098	2.5	1.024	20	40	178	82	365
B	M48305	.059-.177	1.5-4.5	.195	.197	5	.472	12	.130	3.3	.728	18.5	68	302	120	534
C	M48306	.118-.236	3.0-6.0	.195	.197	5	.472	12	.071	1.8	.787	20	68	302	120	534
D	M48307	.118-.177	3.0-4.5	.195	.197	5	.472	12	.071	1.8	.787	20	68	302	120	534
E	M48308	.236-.394	6.0-10.0	.195	.197	5	.472	12	.071	1.8	.984	25	68	302	120	534
F	M48309	.118-.157	3.0-4.0	.195	.197	5	.354	9	.071	1.8	.650	16.5	68	302	120	534
G	M48330	.157-.335	4.0-8.5	.234	.236	6.0	.512	13	.098	2.5	1.102	28	110	489	181	805
H	M48349	.157-.236	4.0-6.0	.246	.250	6.3	.669	17	.098	2.5	.709	18	121	538	194	863
I	M48350	.157-.394	4.0-10.0	.246	.250	6.3	.669	17	.098	2.5	1.102	28	121	538	194	863
J	M48351	.157-.394	4.0-10.0	.246	.250	6.3	.512	13	.098	2.5	1.102	28	121	538	194	863
K	M48354	.028-.178	.7-4.5	.246	.250	6.3	.670	17	.098	2.5	.682	17.3	121	538	194	863
L	M48385	.098-.197	2.5-5.0	.258	.260	6.6	.512	13	.098	2.5	.787	20	137	609	219	974
M	M48386	.098-.197	2.5-5.0	.258	.260	6.6	.709	18	.098	2.5	.787	20	137	609	219	974

* ALSO AVAILABLE IN BULK 2,000/CTN AND VISUAL BOXES, 20/PKG.

Actual Size Rivets / Flanges When ordering, match diagram reference letter with those in above chart.

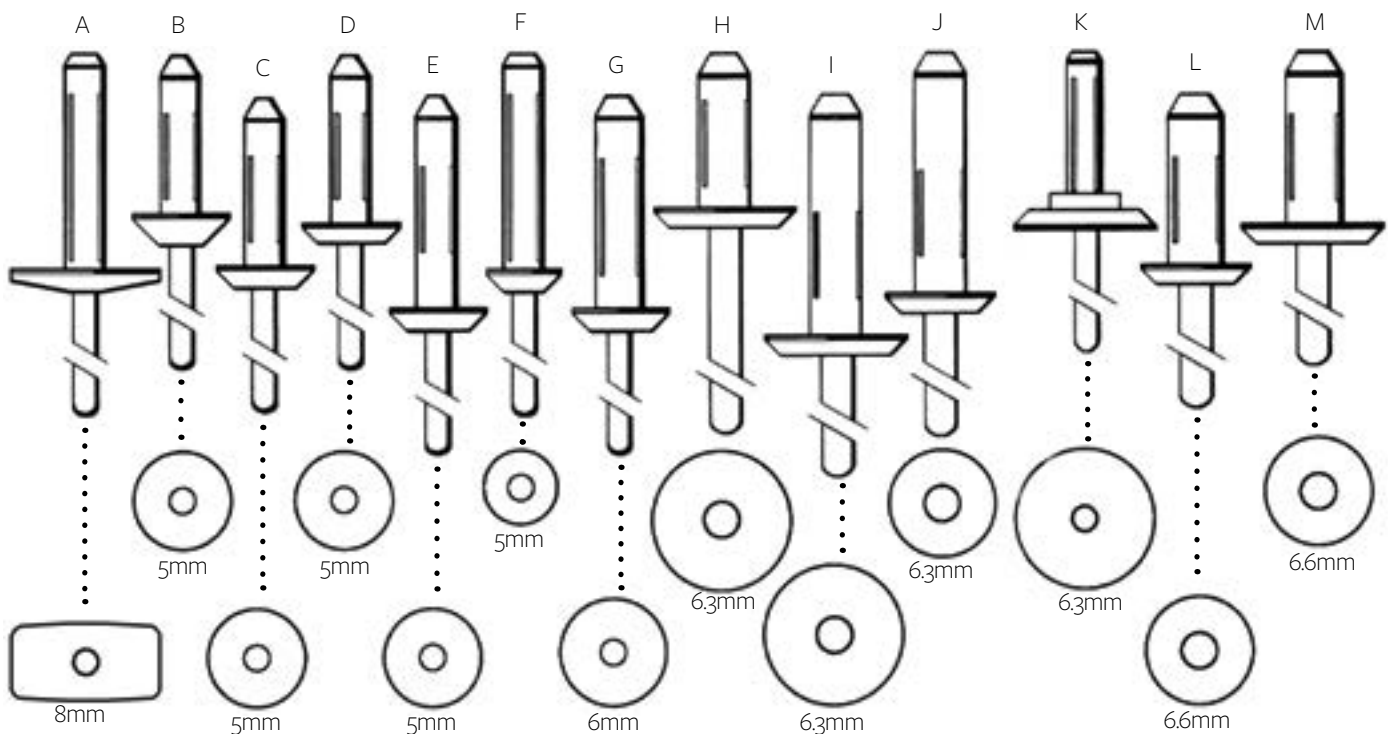

Hand Rivet Tools

HP-2® / M39000*

The HP-2 is the number one selling hand rivet tool in the industry. Known and trusted for durability, quality and performance, the HP-2 is often copied but never duplicated. Its square shoulder fulcrum pin of cold-formed heat-treated steel prevents pin rotation that can elongate the engaging holes and cause premature tool failure in imitation tools. Other quality features include: precision die-cast, high-strength aluminum alloy body; drop-forged carbon steel upper handle; and thick, cushion-molded vinyl grips for comfort. The HP-2 sets up to 3/16" steel rivets and comes with four mounted nosepieces (3/32", 1/8", 5/32" and 3/16") and a service wrench. Refer to the Hand Rivet Tool Capacity Chart on page 19 for specific capabilities. Weight: 1.2 lbs.



HP-3™ / M39002

This hand rivet tool offers long, ergonomically designed handles to increase leverage. The tool is spring-loaded to secure the rivet in the nosepiece while the tool is in any position.

The HP-3™ offers powerful riveting capacity with 4 standard nosepieces to set 3/32", 1/8" and 5/32" in all alloys and up to 3/16" in steel. It features a drop-forged steel handle with heat-treated aluminum body with steel insert, high quality powder coated finish, special alloy steel fulcrum pin with anti-wearing design and durable jaws and jaw case. Weight: 1.2 lbs.



Klik-Turn SP-1 / M39005

The SP-1 swivel head hand-held rivet tool features a patented positive-ratchet locking feature which will allow the swivel head section of the tool to turn 360° and hold in place in any of the forty-plus positions. The high-strength steel body and cast aluminum head complement this innovative design in a swivel head riveting tool. The SP-1 also includes built-in threaded nosepiece storage holes and a service wrench.

The SP-1 sets up to 3/16" steel rivets. Weight: 1.2 lbs.



200 Kit / M39001*

The deluxe hand riveter kit includes the HP-2 and 200 assorted Klik-Fast rivets: 50 each SB4-2, SB4-4, AB4-2A; 25 each SC4-4, AB6-2. The molded plastic case houses and protects the tool and rivets. Weight: 4 lbs.

Stainless Steel Kit / M39003*

This kit is the same as our M39001, but contains 200 assorted Klik-Fast stainless steel rivets: 40 each SSB4-2S, SSB4-3S, SSB4-4S, SSBL4-2S, SSBL4-4S. Weight: 4 lbs.



* Warning: This product contains phthalates that are chemicals known to the State of California to cause cancer, or birth defects, or other reproductive harm.

Big Daddy® / M39031*

The Big Daddy is the most versatile and powerful Marson brand hand riveter, taking the hard work out of setting large diameter blind rivets. Its extra long handles provide excellent leverage and permit working a foot beyond natural reach. Other features include a patented bearing design, self-adjusting two-piece jaws and single-unit body construction with a steel insert to provide stronger threads for the nosepieces. In addition, the Big Daddy features a double-gear reduction system which easily sets from 1/8" to 1/4" diameter Klik-Fast rivets in all alloys, including 1/4" Klik-Split and 3/16" and 1/4" Klik-Lock® rivets. Additionally, a one-piece collet case eliminates the need to adjust the tool when changing rivet diameters. The Big Daddy model #M39031 comes with 5/32", 3/16" and 1/4" nosepieces, which are stored in the body. Weight: 3.75 lbs.

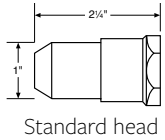

Big Daddy / M39035*

This is the same tool as M39010, but comes with M39009 attached, extending the tool's reach by an additional 2 1/2". Weight: 4 lbs.



Big Daddy / M39010*

This is the same tool as M39031, but comes with 3/16", 1/4" and special 1/4" Klik-Split rivet nosepieces. Weight: 3.75 lbs.

Big Daddy II / M39032*

With all the features of the Big Daddy, Big Daddy II includes a built-in mandrel collection receptacle; just remove the end cap on the bottom handle to discard the spent mandrels.

Big Daddy Conversion Kit 3 Jaw Set Up / M96050

Converting to a three-jaw set adds additional gripping power and extends jaw life.

Big Daddy Extended Nosepiece Kit / M39009

Install kit to add an additional 2-1/2" to any Big Daddy tool. Weight: .25 lb.



*Warning: This product contains phthalates that are chemicals known to the State of California to cause cancer, or birth defects, or other reproductive harm.

Hand Rivet Tool Capacity Chart

	STEEL					ALL ALUMINUM					ALUMINUM STEEL					STAINLESS					MONO-BOLT®*		"T" RIVETS			
	3/32"	1/8"	5/32"	3/16"	1/4"	3/32"	1/8"	5/32"	3/16"	1/4"	3/32"	1/8"	5/32"	3/16"	1/4"	3/32"	1/8"	5/32"	3/16"	1/4"	3/16"	1/4"	3/16"	1/4"		
HP-2/M39000	•	•	•	•		•	•	•	•		•	•	•	•		•	•	•	•							
HP-3/M39002	•	•	•	•		•	•	•	•		•	•	•	•		•	•	•	•							
SP-1/M39005	•	•	•	•		•	•	•	•		•	•	•	•		•	•	•	•							
BIG DADDY (ALL)		•	•	•	•	•	•	•	•	•	•	•	•	•	•	•	•	•	•	•	•	•	•	•	•	•

Hand Rivet Tools — Standard and Special Nosepieces

	SIZES					MONOBOLT®*		T-RIVET SIZES	
	3/32"	1/8"	5/32"	3/16"	1/4"	3/16"	1/4"	3/16"	1/4"
HP-2 / M39000	M39131	M39128	M39130	M39129					
HP-3 / M39002	M39131	M39128	M39130	M39129					
SP-1 / M39005	M39160	M39165	M39164	M39162					
BIG DADDY (ALL)		M96024	M96025	M96026	M96027	M96031	M96030	M96029	M96028

* WHEN SETTING MARSON BAND KLIK-LOCK RIVETS, NO SPECIAL NOSEPIECE IS REQUIRED.

Kits and Specialty Items

Marson Big Daddy Huck Tool Kits

Available in new tool kits with nose assemblies that fit Huck Magna-Lok®, Magna-Tite® and Magna-Grip® 3/16" or 1/4" fasteners or both sizes. Order the kit that's right for you.

Marson Big Daddy Huck Tool Kits		
KIT PART NO.	MAGNA-GRIP® SIZE RANGE	NOSEPIECE
M39500	3/16" AND 1/4"	INCLUDED
M39502	3/16"	INCLUDED
M39504	1/4"	INCLUDED



Marson BIG DADDY® Huck Tool Nose Assemblies*	
KIT PART NO.	MAGNA-GRIP® SIZE RANGE
M96070	3/16"
M96072	1/4"

* Also works with 3/16" and 1/4" Huck Magna-Lok and Magna-Tite nose assemblies.

Huck OEM-Quality Fasteners and Repair Kit

For truck cabs and trailers, Howmet Fastening Systems offers a broad range of industry-leading blind fasteners and structural rivets to attach or repair panels, doors, floor structures, shelving, storage compartments and much more. Each of our fasteners delivers the industry's best combination of clamp, tensile strength and zero-maintenance performance.



Huck Aftermarket Starter Kit — TCR-KIT		
REFILL PACK QTY	DESCRIPTION CODE	DESCRIPTION AND GRIP RANGE
HUCK MAGNA-LOK / KLIK-LOCK BLIND RIVET		
25	MGLP-R6-4-PKT	3/16" STEEL LOCKING .062-.270
25	MGLP-R6-E-PKT	3/16" STEEL LOCKING .62-.437
25	MGLP-R8-6-PKT	1/4" STEEL LOCKING .080-.375
25	MGLP-R8-10-PKT	1/4" STEEL LOCKING .350-.625
25	MGLP-B6-4-PKT	3/16" ALUMINUM LOCKING .62-.270
25	MGLP-B6-E-PKT	3/16" ALUMINUM LOCKING .062-.437
25	MGLP-B8-E-PKT	1/4" ALUMINUM LOCKING .080-.625
HUCK MAGNA-TITE BLIND RIVET		
25	MTP-B6-8S-PKT	3/16" ALUMINUM (SEALANT) .050-.500
25	MTP-B8-10S-PKT	1/4" ALUMINUM (SEALANT) .375-.625
HUCK MAGNA-GRIP PINS		
10	MGP98T-E6-10-PKT	3/16" ALUM BUTTON HEAD .062-.625
10	MGP98T-R6-10G-PKT	3/16" STEEL BUTTON HEAD .062-.625
10	MGPB-R8-10G-PKT	1/4" STEEL BUTTON HEAD .062-.625
10	MGPB-R8-20G-PKT	1/4" STEEL BUTTON HEAD .312-1.250
10	MGPT-R8-10G-PKT	1/4" STEEL TRUSS-HEAD .062-.625
10	MGC-R6U-PKT	3/16" STEEL STANDARD FLANGE COLLAR
10	MGC-R8U-PKT	1/4" STEEL STANDARD FLANGE COLLAR
10	MGCW-R6U-PKT	3/16" STEEL LARGE FLANGE COLLAR
10	MGCW-F6-PKT	3/16" ALUMINUM LARGE FLANGE COLLAR

Huck Rivet Shaver

The Huck® Rivet Shaver tool fits any standard size drill and burnishes 5/32", 3/16", and 1/4" shavable rivet heads to leave a clean, solid appearance that closely matches solid or brazier head rivets. Shavable head rivets can be installed in a blind hole where the blind side or back side does not allow you access.

PART NO.	DESCRIPTION
105-MT	HUCK RIVET SHAVER TOOL + BIT+ HOLDER
124351	HUCK RIVET SHAVER TOOL BIT
124486	HUCK RIVET SHAVER TOOL HOLDER



Power Tools

These next generation, professional series air / hydraulic riveters are designed to be lightweight and well-balanced. Both are engineered to maximize stroke and pull force with a 3-jaw set. For added convenience, you can direct connect or use the attached swivel. Each tool is supplied with nosepieces to set rivets in all alloys and comes complete with adjustment service wrenches, hydraulic fluid, fluid applicator, spare jaws and a removable swivel air connection line with an air OFF / ON valve built in. An adjustable vacuum system allows you to control the force of air needed to hold the rivet in place, or you may operate with the vacuum system turned off. Recommended air pressure is 70-95 PSI.

Each of these proven, professional tools features a one-piece molded frame and front swivel air inlet for maximum operator comfort and durability. An external vacuum adjustment offers convenient air flow control for rivet placement and mandrel disposal. This allows the operator to install rivets in any orientation using one hand, and freeing up the other for assembly. Spent mandrels are conveniently collected in the bottle for disposal, encouraging a safer, clean work environment. Tools come complete with oil, replacement jaws and nosepieces. Recommended air pressure: 85-95 psi.



MP-3V / M39045

Stroke: 3/4"
 Pulling Force: 1,800 lbs.
 Capacity: 3/32" - 3/16",
 all alloys
 Weight: 2.9 lbs.



301-E / M39061

Stroke: 0.807"
 Pulling Force: 2,360 lbs
 Capacity: 3/32" - 3/16"
 diameter in all alloys and
 up to 1/4" in aluminum
 Weight: 3.5 lbs.



302-E / M39062

Stroke: .812"
 Pulling Force: 2,000 lbs.
 Capacity: 3/32" - 3/16"
 diameter in all alloys and
 up to 1/4" in aluminum
 Weight: 4 lbs.



MP-4V / M39048

Stroke: 1"
 Pulling Force: 3,420 lbs.
 Capacity: 5/32" - 1/4", all
 alloys, 1/4" monobolt
 nosepiece included
 Weight: 3.7 lbs.



304-E / M39064

Stroke: 1"
 Pulling Force: 4,200 lbs.
 Capacity: 3/16" to 1/4"
 in all alloys, including structural rivets
 Also included are 3/16" and 1/4"
 Monobolt® and Magna-lok
 assemblies
 Weight: 5.5 lbs.



**Extended Head
 Accessory for
 301-E, 302-E
 and 304-E**

TOOL	DESCRIPTION	PART NUMBER
301-E / M39061 302-E / M39062	5" EXTENSION HEAD	M88082
301-E / M39061 302-E / M39062	8" EXTENSION HEAD	M88086
304-E / M39064	5" EXTENSION HEAD	M723358

Power Tools

With the BT-2A battery-powered rivet tool, you'll enjoy all the reliability that Marson is known for. Includes superior features and industry-leading performance for manufacturing applications in construction, furniture assembly, lighting fixtures, signs, trailers and more.

* Includes nose tips for 3/32", 1/8", 5/32" and 3/16" rivet sizes. Also pulls 3/16" structural rivets. Optional nose tip for 3/16" Monobolts are available.

BT-2A / M39480

Stroke: 0.83" (21mm)
 Pulling Force: 2,248 lbs. (10,000n)
 Capacity: 3/32" (2.4mm) to 3/16" (4.8mm)*
 Weight (with Li-ion battery pack): 4 lbs. (1.8 kg)



The BT-3 battery-powered tool, offers 4,600 lbs (20,000n) of pulling force, and it only weighs 4.4 lbs. The BT-3 features a built-in mandrel collection box and a high-capacity 20 V Li-ion / 2.0 Ah battery pack. Recharge time is approximately 30 minutes. A soft grip handle reduces vibration and fatigue. The BT-3 Kit includes one tool with battery, battery charger and carrying case, along with nose tips for 5/32", 3/16", and 1/4" rivets.** Also pulls 3/16" to 1/4" structural blind rivets.

**Optional nose tips for 3/16" and 1/4" Monobolts available.

BT-3 / M38980

Stroke: 1.18" (30mm)
 Pulling Force: 4,600 lbs. (20,000n)
 Capacity: 5/32" to 1/4" diameter
 Weight: 4.4 lbs. (with battery pack)
 Battery Pack: 20V / Li-ion / 2.0 Ah
 Recharge Time: approx. 30 minutes



The IF-1 is the one-and-only tool needed for single-pull installations of all blind rivets and structural blind fasteners from 3/16" to 1/4". Single integral front end eliminates the need for nosepiece change out during installation. The secret to the IF-1's unique versatility is its stroke — the longest in the industry.

*Does not include HUCK® BOM® structural blind fasteners.

IntegraFuse IF-1 / M39075

Stroke: 1.125" (28.575mm)
 Pulling Force: 4,600 lbs. (20.5kn)
 Capacity: 3/16" to 1/4"
 Weight: 4.8 lbs. (2.177kg)



M-Series

These proven, heavy duty air / hydraulic riveters are designed with an aluminum forged head to hold up under demanding continuous use. The aluminum forged head allows for continuous full operating power and less internal wear. Tools come complete with nosepieces, service tools, swivel inlet air coupler and a mandrel collection bottle. Recommended air pressure: 85-95 psi.

M-3 M39054

Stroke: .551" (14mm)
 Pulling Force: 1,983 lbs. (8,820n)
 Capacity: 1/8" - 3/16" in all alloys including some structural rivets
 Weight: 4.2 lbs.



M-4 M39058

Stroke: .748" (19mm)
 Pulling Force: 3,500 lbs. (13,784n)
 Capacity: 3/32" to 1/4" in all alloys including structural rivets
 Weight: 6.6 lbs.



Power Rivet Tools — Standard and Special Nosepieces

	STANDARD					MONOBOLT®*	
	$\frac{3}{32}$ "	$\frac{1}{8}$ "	$\frac{5}{32}$ "	$\frac{3}{16}$ "	$\frac{1}{4}$ "	$\frac{3}{16}$ "	$\frac{1}{4}$ "
MP-3V/M39045	M95200	M95201	M95202	M95203			
M3/M39054		M95715	M95716	M95717			
MP-4V/M39048			M95300	M95301	M95302	M95299	M95303
M4/M39050	M95897	M95898	M95899	M95900		M95904	M95906
302-E/M39062	M717006	M717001	M717002	M717003	M717005		
304-E/M39064				M88220-1	M88220-79	M88220-85	M88220-84
BT-2A/M38980	M96208	M96209	M96210	M96211			
BT-3/M38980			M96310	M96311	M96322		
IF-1/M39075				M95137-2	M95137		

*FOR MONOBOLT® STRUCTURAL RIVETS, THE NOTED SPECIAL NOSEPIECE IS REQUIRED. FOR MARSON BRAND KLIK-LOCK® STRUCTURAL RIVETS, NO SPECIAL INSERT IS REQUIRED.

Power Rivet Tools — Capacity Chart

	STEEL				ALL ALUMINUM				ALUMINUM STEEL				STAINLESS				STRUCTURAL*						
	$\frac{3}{32}$ "	$\frac{1}{8}$ "	$\frac{5}{32}$ "	$\frac{3}{16}$ "	$\frac{1}{4}$ "	$\frac{3}{32}$ "	$\frac{1}{8}$ "	$\frac{5}{32}$ "	$\frac{3}{16}$ "	$\frac{1}{4}$ "	$\frac{3}{32}$ "	$\frac{1}{8}$ "	$\frac{5}{32}$ "	$\frac{3}{16}$ "	$\frac{1}{4}$ "	$\frac{3}{32}$ "	$\frac{1}{8}$ "	$\frac{5}{32}$ "	$\frac{3}{16}$ "	$\frac{1}{4}$ "	$\frac{3}{16}$ "	$\frac{1}{4}$ "	
M-3/M39054	•	•	•	•		•	•	•	•		•	•	•	•		•	•	•	•		•	•	•
MP-3V/M39045	•	•	•	•		•	•	•	•		•	•	•	•		•	•	•	•		•	•	•
M-4/M39058	•	•	•	•	•	•	•	•	•	•	•	•	•	•	•	•	•	•	•	•	•	•	•
MP-4V/M39048			•	•	•	•	•	•	•		•	•	•	•		•	•	•	•		•	•	•
301-E/M39061	•	•	•	•	•	•	•	•	•	•	•	•	•	•	•	•	•	•	•	•			
302-E/M39062	•	•	•	•		•	•	•	•	•	•	•	•	•		•	•	•	•				
304-E/M39064				•	•				•	•				•	•				•	•	•	•	•
BT-2A/M39080	•	•	•	•		•	•	•	•		•	•	•	•		•	•	•	•				
BT-3/M38980				•	•				•	•				•	•				•	•	•	•	•
IF-1/M39075				•	•				•	•				•	•				•	•	•	•	•

*FOR MONOBOLT® STRUCTURAL RIVETS, THE NOTED SPECIAL NOSEPIECE IS REQUIRED. FOR MARSON BRAND KLIK-LOCK® STRUCTURAL RIVETS, NO SPECIAL INSERT IS REQUIRED.

Power Rivet Tools — Dimensions

TOOL	A	B	C	D	E	F	G	WT
M-3/M39054	12"	6"	1.25"	3"	6"	1"	2"	4.2 LBS.
MP-3V/M39045	10"	3.5"	1.5"	3.5"	6.5"	.925"	2.75"	2.9 LBS.
M-4/M39058	12"	4.5"	1.5"	3.5"	7"	.987"	4.5"	6.6 LBS.
MP-4V/M39048	12"	5.5"	2."	4.5"	7"	.925"	3.5"	3.7 LBS.
301E/M39061	11"	5"	1.75"	4.5"	8"	.875"	2.375"	4.8 LBS.
302-E/M39062	11.125"	5"	2.375"	4.5"	13"	.828"	2.5"	4 LBS.
304-E/M39064	13.125"	6"	2.375"	5.25"	13"	.938"	2.5"	5.5 LBS.
BT-2A/M39080	10.5"	2"	2.375"	4.25"	8"	1"	2.5"	4 LBS.
BT-3/M38980	11"	2.125"	2.5"	4.5"	9"	1"	3.125"	4.4 LBS.
IF-1/M39075	12"	5.56"	1.575"	4.99"	9.18"	12.79"	4.155"	4.8 LBS.

Power Rivet Tools — Specifications

TOOL	WORK FORCE	STROKE
MP-3/M39054	85-95 PSI, 2,000 LBS./8,896 N	.551"/14 MM
MP-3V/M39045	70-95 PSI, 1,800 LBS./8007 N	.75"/19 MM
M-4/M39058	70-95 PSI, 3,500 LBS./15,213 N	.748"/19 MM
MP-4V/M39048	70-95 PSI, 3,420 LBS./15,213 N	1."/25.4 MM
301E/M39061	85-95 PSI/2,360 LBS./10,498 N	.807"/20.5 MM
302-E/M39062	85-95 PSI, 2,000 LBS./8,896 N	.812"/21 MM
304-E/M39064	85-95 PSI, 4,200 LBS./18,682 N	1."/25.4 MM
BT-2A/M39080	2,248 LBS./10,000 N	.83"/21 MM
BT-3/M38980	4,600 LBS./20,000 N	1.18"/30 MM
IF-1/M39075	4,600 LBS./20,500 N	1.125"/28.575 MM

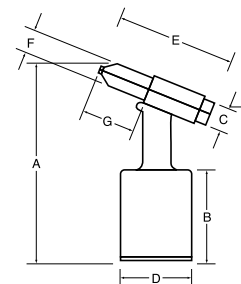

Marson Rivet Nuts

More Styles, Sizes and Tools to Fit Your Application Needs

Marson Rivet Nuts deliver low cost, permanent thread placement in thin material while providing at least six full thread turns per application install. Easy installation can be completed by one operator with minimum training. Blindsight access is not required when installing Marson Rivet Nuts. Ideal for painted surfaces, Marson Rivet Nuts help increase production and reduce rework by eliminating the surface damage that can occur with other fastening methods.



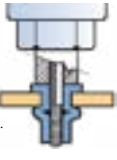
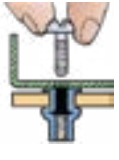
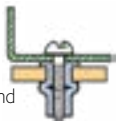









4 Easy Steps to Complete Installation and Application

- 1 Thread Rivet Nut onto tool mandrel and insert into hole. 
- 2 Actuate tool to properly set fastener into material. 
- 3 Complete your fastening operation with a bolt or screw with the proper thread. 
- 4 The positive riveting action of the Klik Rivet Nut will provide a permanent thread. As threads are tightened, so are Rivet Nut and application. 

Rivet Nuts can be used to fasten multiple sheets as well as single sheets.



General Information — Rivet Nuts

Rivet Styles	Features / Benefits	Materials Available
MRN SERIES (p. 26)	 RIVET NUT, FLATHEAD FLANGE (THICK WALL) FOR APPLICATIONS THAT REQUIRE HEAVY PUSH OUT LOADS (RECOMMEND SPIN-PULL TOOL)	STEEL, ALUMINUM
MPN SERIES (p. 27)	 POLY-NUT RIVET NUT HAS VERY SMALL FLANGE, LOWEST PROFILE FOR NEAR COUNTERSINK APPLICATIONS	STEEL, ALUMINUM
MTS SERIES (p. 27)	 THREAD-SERT HAS SMALL FLANGE, 360 DEGREE SWAGING ACTION IN THE HOLE AND NO MAXIMUM GRIP RANGE	STEEL, ALUMINUM
MLR SERIES (p. 28)	 LARGE FLANGE RIBBED RIVET NUT PROVIDES INCREASED TURN-OUT RESISTANCE VS CONVENTIONAL RIVET NUT AND LARGE FLANGE FOR IMPROVED PUSH OUT PERFORMANCE	STEEL, ALUMINUM
MLC SERIES (p. 29)	 LARGE FLANGE RIBBED RIVET NUT WITH CLOSED END FOR THREAD SEAL	STEEL, ALUMINUM
MSR SERIES (p. 30)	 SMALL FLANGE LOW PROFILE RIBBED RIVET NUT FOR VIRTUALLY FLUSH INSTALL WITH INCREASED TURN-OUT RESISTANCE VS CONVENTIONAL LOW PROFILE PLY-NUT	STEEL, ALUMINUM
MSC SERIES (p. 31)	 SMALL FLANGE LOW PROFILE RIBBED RIVET NUT WITH CLOSED END FOR THREAD SEAL	STEEL, ALUMINUM
MHN SERIES (p. 32)	 LARGE FLANGE HALF HEX RIVET NUT FOR HEX HOLE TO PROVIDE EXCEPTIONAL TURN-OUT RESISTANCE	STEEL
MQN SERIES (p. 33)	 QUAD-LEG RIVET NUT USED FOR LIGHT DUTY THIN OR SOFT / BRITTLE MATERIAL – WILL ACCOMMODATE SLIGHTLY OVERSIZED HOLE WITH LARGE BACK SIDE FOOTPRINT	STEEL
MXN SERIES (p. 33)	 LARGE FLANGE CROSS BULB RIVET NUT LARGE GRIP RANGE WITH PRE-BULB AND 4 SLOTS CUT TO PROVIDE LARGE BLINDSIDE FOOTPRINT FOR GREATER PULL OUT STRENGTH IN THIN SHEET METAL AND PLASTICS	STEEL
MET SERIES (p. 34)	 EXTERNAL THREAD STUD RIVET NUT ALLOWS FOR COMPONENT MOUNTING AND MATE NUT	STEEL
MNN SERIES (p. 35)	 NEOPRENE INSERT WITH PRE-MOLDED BRASS NUT FOR QUICK FASTENING IN VIBRATION AND MOISTURE RESISTANT APPLICATIONS	NEOPRENE

All finishes are RoHS compliant.



MRN Series Flathead Rivet Nuts

Available in Steel-Zinc Plated or Aluminum

MRN Series Flathead Rivet Nut (Thick Wall)

MRN — Rivet Nut, Flathead Flange provides the most bearing surface for applications that require heavy push out loads and high torque for use in metal, fiberglass and rigid plastics too thin for tapped holes. Spin/Pull tool is recommended although smaller thread sizes can utilize a manual tool.

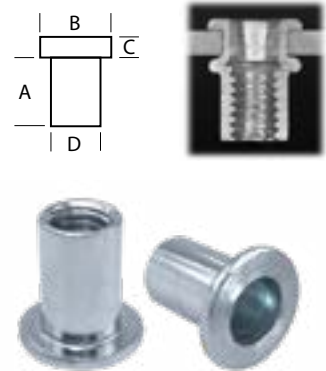

MRN Series Flathead Rivet Nut

THREAD SIZE	GRIP RANGE		STEEL *BULK PART #	ALUMINUM *BULK PART #	A BODY LENGTH @.015"	B HEAD DIA @.015"	C HEAD HEIGHT (NOM)	D BODY DIA MAX	HOLE SIZE		DRILL SIZE
	MIN	MAX							MIN	MAX	
6-32	.010	.075	M57110	M57210	.438	.325	.032	.189	.189	.193	#12
8-32	.010	.075	M57120	M57220	.438	.357	.032	.221	.221	.226	#2
8-32	.075	.120	M57121	M57221	.500	.357	.032	.221	.221	.226	#2
10-24	.010	.080	M57130	M57230	.531	.406	.038	.250	.250	.254	1/4
10-24	.080	.130	M57132	M57232	.594	.406	.038	.250	.250	.254	1/4
10-32	.010	.080	M57140	M57240	.531	.406	.038	.250	.250	.254	1/4
10-32	.080	.130	M57142	M57242	.594	.406	.038	.250	.250	.254	1/4
1/4-20	.020	.080	M57150	M57250	.625	.475	.058	.332	.332	.338	Q(.332)
1/4-20	.080	.140	M57152	M57252	.687	.475	.058	.332	.332	.338	Q(.332)
1/4-20	.140	.200	M57154	M57254	.750	.475	.058	.332	.332	.338	Q(.332)
5/16-18	.030	.125	M57171	M57271	.750	.665	.062	.413	.413	.423	Z(.423)
5/16-18	.125	.200	M57174	M57274	.875	.665	.062	.413	.413	.423	Z(.423)
3/8-16	.030	.115	M57181	M57281	.844	.781	.088	.490	.490	.500	1/2
3/8-16	.115	.200	M57184	M57284	.938	.781	.088	.490	.490	.500	1/2

* ALSO AVAILABLE IN SMALL PACKAGED QUANTITIES.
INCH SIZES ARE CLASS 2B THREAD.

MPN and MTS Series Poly-Rivet Nut and Thread-Sert®

MPN Series Poly-Rivet Nut

Available in Steel-Zinc Plated or Aluminum

MPN Series Lowest Profile Poly-Rivet Nut

MPN — Poly-Rivet Nut has very small flange and the lowest profile for near flush installation. Eliminates additional operations of countersinking or dimpling of the parent material. May install with all pneumatic and manual Rivet Nut tools.



THREAD SIZE	GRIP RANGE MIN - MAX	STEEL *BULK PART #	ALUMINUM *BULK PART #	A	B	C	D	HOLE SIZE MIN - MAX	DRILL SIZE
				BODY LENGTH @.015	HEAD DIA @.015	HEAD HEIGHT @.005	BODY DIA +0 -.005		
				Ⓢ 0.38 MM	Ⓢ 0.38 MM	Ⓢ 0.127 MM	TO -0.127 MM		
6-32	.020-.080	M57415	M57510	.410	.287	.017	.249	.250-.254	1/4
8-32	.020-.080	M57425	M57520	.410	.287	.017	.249	.250-.254	1/4
10-24	.020-.130	M57435	M57530	.465	.320	.020	.280	.281-.285	9/32
10-32	.020-.130	M57445	M57540	.465	.320	.020	.280	.281-.285	9/32
1/4-20	.030-.165	M57455	M57550	.591	.415	.020	.374	.375-.379	3/8
5/16-18	.030-.165	M57475	M57575	.720	.540	.024	.499	.500-.504	1/2
3/8-16	.030-.165	M57485	M57585	.720	.540	.024	.499	.500-.504	1/2
4 MM	.50-2.03	M57407	N/A	10.41	7.29	0.43	6.32	6.35-6.45	6.35
5 MM	.50-3.30	M57409	N/A	11.81	8.13	.61	7.11	7.14-7.23	7.14
6 MM	.76-4.19	M57411	N/A	15.01	10.54	.61	9.50	9.52-9.62	9.52
8 MM	.76-4.19	M57413	N/A	18.29	13.72	.61	12.67	12.7-12.8	12.7
10 MM**	.76-4.19	M57414	N/A	18.29	13.72	.61	12.67	12.7-12.8	12.7

* ALSO AVAILABLE IN SMALL PACKAGED QUANTITIES. ** LIMITED AVAILABILITY, MINIMUMS MAY APPLY. INCH SIZES ARE CLASS 2B THREAD. METRIC SIZES ARE CLASS 6H THREAD.

MTS Series Thread-Sert®

Available in Steel-Zinc Plated or Aluminum

MTS — Thread-Sert fasteners have a small flange and 360 degree swaging action as the Rivet Nut expands inside the hole. Provides high resistance to torque-out with minimal backside protrusion. Can be installed in blind hole with unlimited maximum grip range. May install with all pneumatic and manual Rivet Nut tools.

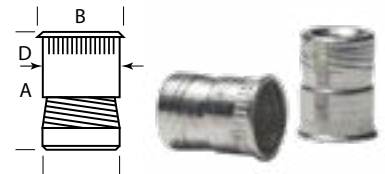

THREAD SIZE	STEEL *BULK PART #	ALUMINUM *BULK PART #	A**	B	D**	MATERIAL THICKNESS .0937-.1562		MATERIAL THICKNESS .1562- INFINITY	
			BODY LENGTH @.005"	HEAD DIA @.005"	BODY DIA @.002"	HOLE SIZE	DRILL SIZE	HOLE SIZE	DRILL SIZE
6-32	M57810	M57910	.375	.250	.215	.221	#2	.234	A (.234)
8-32	M57820	M57920	.375	.282	.246	.250	1/4	.261	G (.261)
10-24	M57830	M57930	.375	.314	.277	.281	9/32	.290	L (.290)
10-32	M57840	M57940	.375	.314	.277	.281	9/32	.290	L (.290)
1/4-20	M57850	M57950	.510	.408	.372	.391	3/8	.376	25/64
5/16-18	M57871	M57971	.615	.537	.496	.500	1/2	.516	33/64
3/8-16	M57881	M57981	.740	.600	.559	.562	9/16	.578	37/64

* ALSO AVAILABLE IN SMALL PACKAGED QUANTITIES. ** A AND D DIMENSIONS ARE PRIOR TO SETTING. INCH SIZES ARE CLASS 2B THREAD.

MLR — Large Flange Ribbed Low-Profile Rivet Nuts

Available in Steel-Zinc Plated or Aluminum

MLR — Large Flange Ribbed Rivet Nuts feature ribbed external body for increased torque-out resistance vs conventional Rivet Nut. Large flange offers improved push out performance. Overall MLR offers the best and highest strength levels. May install with all pneumatic and manual Rivet Nut tools.

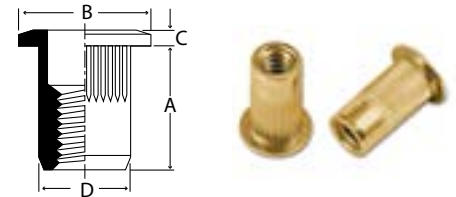

MLR Series Large Flange Ribbed Low-Profile Rivet Nut

THREAD SIZE	GRIP RANGE MIN-MAX	STEEL *BULK PART #	ALUMINUM *BULK PART #	A BODY LENGTH Ⓢ.015" Ⓢ 0.38 MM	B HEAD DIA. Ⓢ.010" Ⓢ 0.254 MM	C HEAD HEIGHT Ⓢ.003" Ⓢ 0.76 MM	D BODY DIA MAX	HOLE SIZE MIN-MAX	DRILL SIZE
6-32	.020-.080	M57310	M57610	.420	.390	.030	.265	.265-.271	17/64
6-32	.080-.130	M57312	M57612	.470	.390	.030	.265	.265-.271	17/64
8-32	.020-.080	M57320	M57620	.420	.390	.030	.265	.265-.271	17/64
8-32	.080-.130	M57321	M57621	.470	.390	.030	.265	.296-.302	17/64
10-24	.020-.130	M57330	M57630	.475	.415	.030	.296	.296-.302	19/64
10-24	.130-.225	M57332	M57632	.585	.415	.030	.296	.296-.302	19/64
10-32	.020-.130	M57340	M57640	.475	.415	.030	.296	.296-.302	19/64
10-32	.130-.225	M57342	M57642	.585	.415	.030	.296	.296-.302	19/64
1/4-20	.027-.165	M57350	M57650	.580	.500	.030	.390	.390-.396	25/64
1/4-20	.165-.260	M57354	M57654	.680	.500	.030	.390	.390-.396	25/64
1/4-28	.027-.165	M57358	M57658	.580	.500	.030	.390	.390-.396	25/64
1/4-28	.165-.260	M57359	M57659	.680	.500	.030	.390	.390-.396	25/64
5/16-18	.027-.150	M57371	M57671	.690	.685	.035	.530	.530-.536	17/32
5/16-18	.150-.312	M57374	M57674	.805	.685	.035	.530	.530-.536	17/32
5/16-24	.027-.150	M57378	M57678	.690	.685	.035	.530	.530-.536	17/32
5/16-24	.150-.312	M57379	M57679	.805	.685	.035	.530	.530-.536	17/32
3/8-16	.027-.150	M57381	M57681	.690	.685	.035	.530	.530-.536	17/32
3/8-16	.150-.312	M57382	M57682	.805	.685	.035	.530	.530-.536	17/32
3/8-24	.027-.150	M57395	M57695	.690	.685	.035	.530	.530-.536	17/32
3/8-24	.150-.312	M57396	M57696	.805	.685	.035	.530	.530-.536	17/32
M4x.07	.5-2.0	M57360	M57660	10.67	9.91	.76	6.73	6.75+.15	6.75
M4x.07	2.0-3.3	M57365	M57665	11.94	9.91	.76	6.73	6.75+.15	6.75
M5x.08	.5-3.3	M57385	M57684	12.07	10.54	.76	7.52	7.6+.15	7.6
M5x.08	3.3-5.7	M57384	M57685	14.86	10.54	.76	7.52	7.6+.15	7.6
M6x1.0	.7-4.2	M57386	M57686	14.73	12.7	.76	9.91	10.0+.15	10.0
M6x1.0	4.2-6.6	M57387	M57687	17.27	12.7	.76	9.91	10.0+.15	10.0
M8x1.25	.7-3.8	M57388	M57688	17.53	17.4	.89	13.46	13.5+.15	13.5
M8x1.25	3.8-7.9	M57389	M57689	20.45	17.4	.89	13.46	13.5+.15	13.5
M10x1.5	.7-3.8	M57390	M57690	17.53	17.4	.89	13.46	13.5+.15	13.5
M10x1.5	3.8-7.9	M57391	M57691	20.45	17.4	.89	13.46	13.5+.15	13.5

DIMENSIONS IN GREEN INDICATE MILLIMETERS (MM) *ALSO AVAILABLE IN SMALL PACKAGED QUANTITIES. INCH SIZES ARE CLASS 2B THREAD. METRIC SIZES ARE CLASS 6H THREAD.

MLC — Large Flange Closed End Ribbed Rivet Nuts

Available in Steel-Zinc Plated or Aluminum

MLC — Large Flange Ribbed Rivet Nuts are the same as MLR with Closed End for complete thread seal.

Use in moisture resistant applications. May install with all pneumatic and manual Rivet Nut tools.

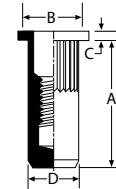

MLC Series Large Flange Closed End Ribbed Rivet Nut

THREAD SIZE	GRIP RANGE MIN-MAX	STEEL *BULK PART #	ALUMINUM *BULK PART #	A BODY LENGTH @.015" Ⓢ 0.38 MM	B HEAD DIA @.010" Ⓢ 0.254 MM	C HEAD HEIGHT @.003" Ⓢ 0.76 MM	D BODY DIA MAX	HOLE SIZE MIN-MAX	DRILL SIZE
6-32**	.020-.080	M27310	M37310	.740	.390	.030	.265	.265-.271	17/64
6-32**	.080-.130	M27312	M37312	.740	.390	.030	.265	.265-.271	17/64
8-32**	.020-.080	M27320	M37320	.740	.390	.030	.265	.265-.271	17/64
8-32**	.080-.130	M27321	M37321	.740	.390	.030	.265	.296-.302	17/64
10-24**	.020-.130	M27330	M37330	.990	.415	.030	.296	.296-.302	19/64
10-24**	.130-.225	M27332	M37332	.990	.415	.030	.296	.296-.302	19/64
10-32**	.020-.130	M27340	M37340	.990	.415	.030	.296	.296-.302	19/64
10-32**	.130-.225	M27342	M37342	.990	.415	.030	.296	.296-.302	19/64
1/4-20**	.027-.165	M27350	M37350	1.190	.500	.030	.390	.390-.396	25/64
1/4-20**	.165-.260	M27354	M37354	1.190	.500	.030	.390	.390-.396	25/64
1/4-28**	.027-.165	M27358	M37358	1.190	.500	.030	.390	.390-.396	25/64
1/4-28**	.165-.260	M27359	M37359	1.190	.500	.030	.390	.390-.396	25/64
5/16-18**	.027-.150	M27371	M37371	1.390	.685	.035	.530	.530-.536	17/32
5/16-18**	.150-.312	M27374	M37374	1.390	.685	.035	.530	.530-.536	17/32
5/16-24**	.027-.150	M27378	M37378	1.390	.685	.035	.530	.530-.536	17/32
5/16-24**	.150-.312	M27379	M37379	1.390	.685	.035	.530	.530-.536	17/32
3/8-16**	.027-.150	M27381	M37381	1.390	.685	.035	.530	.530-.536	11/16
3/8-16**	.150-.312	M27382	M37382	1.390	.685	.035	.530	.530-.536	11/16
3/8-24**	.027-.150	M27395	M37395	1.390	.685	.035	.530	.530-.536	11/16
3/8-24**	.150-.312	M27396	M37396	1.390	.685	.035	.530	.530-.536	11/16
M4x.07**	.5-2.0	M27360	M37360	18.8	9.91	.76	6.73	6.75+.15	6.75
M4x.07**	2.0-3.3	M27365	M37365	18.8	9.91	.76	6.73	6.75+.15	6.75
M5x0.8**	.5-3.3	M27385	M37385	25.15	10.54	.76	7.52	7.6+.15	7.60
M5x0.8**	3.3-5.7	M27384	M37384	25.15	10.54	.76	7.52	7.6+.15	7.60
M6x1.0**	.7-4.2	M27386	M37386	30.23	12.7	.76	9.91	10.0+.15	10.00
M6x1.0**	4.2-6.6	M27387	M37387	30.23	12.7	.76	9.91	10.0+.15	10.00
M8x1.25**	.7-3.8	M27388	M37388	35.31	17.4	.89	13.46	13.5+.15	13.50
M8x1.25**	3.8-7.9	M27389	M37389	35.31	17.4	.89	13.46	13.5+.15	13.50
M10x1.5**	.7-3.8	M27390	M37390	35.31	17.4	.89	13.46	13.5+.15	13.50
M10x1.5**	3.8-7.9	M27391	M37391	35.31	17.4	.89	13.46	13.5+.15	13.50

DIMENSIONS IN GREEN INDICATE MILLIMETERS (MM) *ALSO AVAILABLE IN SMALL PACKAGED QUANTITIES. ** LIMITED AVAILABILITY, MINIMUMS MAY APPLY. INCH SIZES ARE CLASS 2B THREAD. METRIC SIZES ARE CLASS 6H THREAD.



MSR — Small Flange Low Profile Ribbed Rivet Nuts

Available in Steel-Zinc Plated, Aluminum, or Stainless Steel

MSR — Small Flange low profile Ribbed Rivet Nut for virtually flush installation with ribbed external body for increased torque-out resistance versus conventional low profile Poly-Nut. May install with all pneumatic and manual Rivet Nut tools.

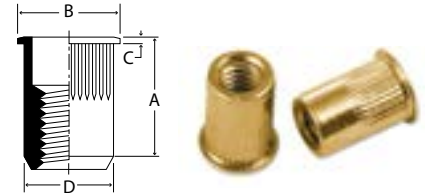

MSR Series Small Flange Low Profile Ribbed Rivet Nut

THREAD SIZE	GRIP RANGE MIN-MAX	STEEL *BULK PART #	ALUMINUM *BULK PART #	A	B	C	D	HOLE SIZE MIN-MAX	DRILL SIZE MIN-MAX
				BODY LENGTH @.015" Ⓟ 0.38 MM	HEAD DIA @.010" Ⓟ 0.254 MM	HEAD HEIGHT @.003" Ⓟ 0.76 MM	BODY DIA MAX		
6-32	.020-.080	M56810	M56910	.420	.310	.019	.265	.265-.271	17/64
6-32	.080-.130	M56812	M56912	.470	.310	.019	.265	.265-.271	17/64
8-32	.020-.080	M56820	M56920	.420	.310	.019	.265	.265-.271	17/64
8-32	.080-.130	M56821	M56921	.470	.310	.019	.265	.296-.302	17/64
10-24	.020-.130	M56830	M56930	.475	.340	.019	.296	.296-.302	19/64
10-24	.130-.225	M56832	M56932	.585	.340	.019	.296	.296-.302	19/64
10-32	.020-.130	M56840	M56940	.475	.340	.019	.296	.296-.302	19/64
10-32	.130-.225	M56842	M56942	.585	.340	.019	.296	.296-.302	19/64
1/4-20	.027-.165	M56850	M56950	.580	.455	.022	.390	.390-.396	25/64
1/4-20	.165-.260	M56854	M56954	.680	.455	.022	.390	.390-.396	25/64
1/4-28	.027-.165	M56858	M56958	.580	.455	.022	.390	.390-.396	25/64
1/4-28	.165-.260	M56859	M56959	.680	.455	.022	.390	.390-.396	25/64
5/16-18	.027-.150	M56871	M56971	.690	.595	.022	.530	.530-.536	17/32
5/16-18	.150-.312	M56874	M56974	.805	.595	.022	.530	.530-.536	17/32
5/16-24	.027-.150	M56878	M56978	.690	.595	.022	.530	.530-.536	17/32
5/16-24	.150-.312	M56879	M56979	.805	.595	.022	.530	.530-.536	17/32
3/8-16	.027-.150	M56881	M56981	.690	.595	.022	.530	.530-.536	17/32
3/8-16	.150-.312	M56882	M56982	.805	.595	.022	.530	.530-.536	17/32
3/8-24	.027-.150	M56895	M56995	.690	.595	.022	.530	.530-.536	17/32
3/8-24	.150-.312	M56896	M56996	.805	.595	.022	.530	.530-.536	17/32
M4x07	.5-2.0	M56860	M56960	10.67	7.87	.48	6.73	6.75+.15	6.75
M4x07	2.0-3.3	M56865	M56965	11.94	7.87	.48	6.73	6.75+.15	6.75
M5x0.8	.5-3.3	M56884	M56984	12.07	8.64	.48	7.52	7.6+.15	7.60
M5x0.8	3.3-5.7	M56885	M56985	14.86	8.64	.48	7.52	7.6+.15	7.60
M6x1.0	.7-4.2	M56886	M56986	14.73	11.56	.55	9.91	10.0+.15	10.00
M6x1.0	4.2-6.6	M56887	M56987	17.27	11.56	.55	9.91	10.0+.15	10.00
M8x1.25	.7-3.8	M56888	M56988	17.53	15.11	.55	13.46	13.5+.15	13.50
M8x1.25	3.8-7.9	M56889	M56989	20.45	15.11	.55	13.46	13.5+.15	13.50
M10x1.5	.7-3.8	M56890	M56990	17.53	15.11	.55	13.46	13.5+.15	13.50
M10x1.5	3.8-7.9	M56891	M56991	20.45	15.11	.55	13.46	13.5+.15	13.50

THREAD SIZE	GRIP RANGE MIN-MAX	STEEL *BULK PART #	A	B	C	D	HOLE SIZE MIN-MAX	DRILL SIZE MIN-MAX
			BODY LENGTH @.015" Ⓟ 0.38 MM	HEAD DIA @.010" Ⓟ 0.254 MM	HEAD HEIGHT @.003" Ⓟ 0.76 MM	BODY DIA MAX		
10-24	.020-.130	M28430	.475	.340	.019	.296	.296-.302	19/64
10-32	.020-.130	M28440	.475	.340	.019	.296	.296-.302	19/64
1/4-20	.027-.165	M28450	.580	.455	.022	.390	.390-.396	25/64

DIMENSIONS IN GREEN INDICATE MILLIMETERS (MM) * ALSO AVAILABLE IN SMALL PACKAGED QUANTITIES. INCH SIZES ARE CLASS 2B THREAD. METRIC SIZES ARE CLASS 6H THREAD.

MSC — Small Flange Closed End Ribbed Rivet Nuts

Available in Steel-Zinc Plated or Aluminum

MSC — Small Flange Ribbed Rivet Nut is the same as MSR with Closed End for complete thread seal. For use in moisture resistant applications. May install with all pneumatic and manual Rivet Nut tools.

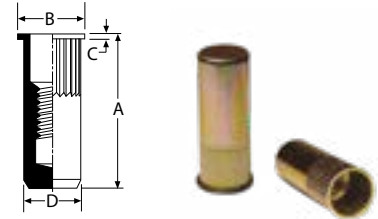

MSC Series Small Flange Closed End Ribbed Rivet Nut (Built to order, minimums required)

THREAD SIZE	GRIP RANGE MIN-MAX	STEEL *BULK PART #	ALUMINUM *BULK PART #	A	B	C	D	HOLE SIZE MIN-MAX	DRILL SIZE MIN-MAX
				BODY LENGTH @.015" @ 0.38 MM	HEAD DIA @.010" @ 0.254 MM	HEAD HEIGHT @.003" @ 0.76 MM	BODY DIA MAX		
6-32	.020-.080	M26810	M36910	.740	.310	.019	.265	.265-.271	17/64
6-32	.080-.130	M26812	M36912	.740	.310	.019	.265	.265-.271	17/64
8-32	.020-.080	M26820	M36920	.740	.310	.019	.265	.265-.271	17/64
8-32	.080-.130	M26821	M36921	.740	.310	.019	.265	.296-.302	17/64
10-24	.020-.130	M26830	M36930	.990	.340	.019	.296	.296-.302	19/64
10-24	.130-.225	M26832	M36932	.990	.340	.019	.296	.296-.302	19/64
10-32	.020-.130	M26840	M36940	.990	.340	.019	.296	.296-.302	19/64
10-32	.130-.225	M26842	M36942	.990	.340	.019	.296	.296-.302	19/64
1/4-20	.027-.165	M26850	M36950	1.190	.455	.022	.390	.390-.396	25/64
1/4-20	.165-.260	M26854	M36954	1.190	.455	.022	.390	.390-.396	25/64
1/4-28	.027-.165	M26858	M36958	1.190	.455	.022	.390	.390-.396	25/64
1/4-28	.165-.260	M26859	M36959	1.190	.455	.022	.390	.390-.396	25/64
5/16-18	.027-.150	M26871	M36971	1.390	.595	.022	.530	.530-.536	17/32
5/16-18	.150-.312	M26874	M36974	1.390	.595	.022	.530	.530-.536	17/32
5/16-24	.027-.150	M26878	M36978	1.390	.595	.022	.530	.530-.536	17/32
5/16-24	.150-.312	M26879	M36979	1.390	.595	.022	.530	.530-.536	17/32
3/8-16	.027-.150	M26881	M36981	1.390	.595	.022	.530	.530-.536	17/32
3/8-16	.150-.312	M26882	M36982	1.390	.595	.022	.530	.530-.536	17/32
3/8-24	.027-.150	M26895	M36995	1.390	.595	.022	.530	.530-.536	17/32
3/8-24	.150-.312	M26896	M36996	1.390	.595	.022	.530	.530-.536	17/32
M4x.07	.5-2.0	M26860	M36960	18.8	7.87	.48	6.73	6.75+.15	6.75
M4x.07	2.0-3.3	M26865	M36965	18.8	7.87	.48	6.73	6.75+.15	6.75
M5x0.8	.5-3.3	M26884	M36984	25.15	8.64	.48	7.52	7.6+.15	7.60
M5x0.8	3.3-5.7	M26885	M36985	25.15	8.64	.48	7.52	7.6+.15	7.60
M6x1.0	.7-4.2	M26886	M36986	30.23	11.56	.55	9.91	10.0+.15	10.00
M6x1.0	4.2-6.6	M26887	M36987	30.23	11.56	.55	9.91	10.0+.15	10.00
M8x1.25	.7-3.8	M26888	M36988	35.31	15.11	.55	13.46	13.5+.15	13.50
M8x1.25	3.8-7.9	M26889	M36989	35.31	15.11	.55	13.46	13.5+.15	13.50
M10x1.5	.7-3.8	M26890	M36990	35.31	15.11	.55	13.46	13.5+.15	13.50
M10x1.5	3.8-7.9	M26891	M36991	35.31	15.11	.55	13.46	13.5+.15	13.50

DIMENSIONS IN GREEN INDICATE MILLIMETERS (MM) *ALSO AVAILABLE IN SMALL PACKAGED QUANTITIES. INCH SIZES ARE CLASS 2B THREAD. METRIC SIZES ARE CLASS 6H THREAD.

MHN — Large Flange Half Hex Rivet Nuts

Available in Steel-Zinc Plated Threads

MHN — Large Flange Half Hex Rivet Nut provides exceptional torque-out strength and superior vibration resistance as the Rivet Nut external flat sides engage the hex cut opening. May be installed with all pneumatic and manual Rivet Nut tools.



MHN Series Large Flange Half Hex Rivet Nut

THREAD SIZE	GRIP RANGE MIN-MAX	STEEL *BULK PART #	A BODY LENGTH $\text{\textcircled{P}}.015''$ $\text{\textcircled{P}} 0.38 \text{ MM}$	B HEAD DIA $\text{\textcircled{P}}.010''$ $\text{\textcircled{P}} 0.254 \text{ MM}$	C HEAD HEIGHT $\text{\textcircled{P}}.003''$ $\text{\textcircled{P}} 0.76 \text{ MM}$	D BODY DIA MAX	HEX HOLE ACROSS FLATS $+ .004'' - .000''$
6-32	.020 - .080	M52610	.385	.375	.027	.249	.250
6-32	.080 - .130	M52612	.435	.375	.027	.249	.250
8-32	.020 - .080	M52620	.385	.375	.027	.249	.250
8-32	.080 - .130	M52621	.435	.375	.027	.249	.250
10-24	.020 - .130	M52630	.435	.390	.027	.280	.281
10-24	.130 - .225	M52632	.535	.390	.027	.280	.281
10-32	.020 - .130	M52640	.435	.390	.027	.280	.281
10-32	.130 - .225	M52642	.535	.390	.027	.280	.281
1/4-20	.027 - .165	M52650	.585	.510	.030	.374	.375
1/4-20	.165 - .260	M52654	.685	.510	.030	.374	.375
5/16-18	.027 - .165	M52671	.685	.655	.035	.499	.500
5/16-18	.165 - .260	M52674	.845	.655	.035	.499	.500
3/8-16	.027 - .150	M52681	.685	.655	.035	.499	.500
3/8-16	.150 - .312	M52682	.845	.655	.035	.499	.500
M4x0.7	.5 - 2.0	M52660	9.78	9.53	.68	6.35	6.35
M4x0.7	2.0 - 3.3	M52665	11.05	9.53	.68	6.35	6.35
M5x0.8	.5 - 3.3	M52684	11.05	9.91	.68	7.1	7.14
M5x0.8	3.3 - 5.7	M52685	13.59	9.91	.68	7.1	7.14
M6x1.0	.7 - 4.2	M52686	14.86	12.96	.76	9.5	9.53
M6x1.0	4.2 - 6.6	M52687	17.40	12.96	.76	9.5	9.53
M8x1.25	.7 - 3.8	M52688	17.40	16.64	.89	12.7	12.7
M8x1.25	3.8 - 7.9	M52689	21.46	16.64	.89	12.7	12.7
M10x1.5	.7 - 3.8	M52690	17.40	16.64	.89	12.7	12.7
M10x1.5	3.8 - 7.9	M52691	21.46	16.64	.89	12.7	12.7

DIMENSIONS IN GREEN INDICATE MILLIMETERS (MM) *ALSO AVAILABLE IN SMALL PACKAGED QUANTITIES. INCH SIZES ARE CLASS 2B THREAD. METRIC SIZES ARE CLASS 6H THREAD.

Quad-Leg and Cross Bulb Rivet Nuts

MQN Series Quad-Leg Rivet Nuts

Available in Steel-Zinc Plated Threads

MQN — Quad-Leg Rivet Nut is used for light duty, thin or soft / brittle material. It will accommodate slightly oversized hole with large back side footprint similar to a wall anchor. Utilizes dedicated manual tool for proper installation.



THREAD SIZE	GRIP RANGE MIN-MAX	STEEL *BULK PART #	A OVERALL LENGTH	B HEAD DIA REF	E HEAD HEIGHT (Nom)	D BODY DIA MAX	HOLE SIZE MIN-MAX	DRILL SIZE
6-32	.000-.197	M52510	.670	.472	.063	.315	.318-.330	P (.323)
6-32	.197-.394	M52511	.866	.472	.063	.315	.318-.330	P (.323)
10-24	.000-.197	M52530	.709	.547	.063	.394	.397-.406	X (.397)
10-24	.197-.394	M52532	.906	.547	.063	.394	.397-.406	X (.397)
1/4-20	.000-.197	M52550	.709	.630	.063	.472	.475-.487	31/64
1/4-20	.197-.394	M52554	.906	.630	.063	.472	.475-.487	31/64
M4x0.7	.0-5.0	M52560	17.0	12.0	1.60	8.0	8.08-8.38	P (.323)
M4x0.7	5.0-10.0	M52565	22.0	12.0	1.60	8.0	8.08-8.38	P (.323)
M5x0.8	.0-5.0	M52584	18.0	13.9	1.60	10.0	10.08-10.31	X (.397)
M5x0.8	5.0-10.0	M52585	23.0	13.9	1.60	10.0	10.08-10.31	X (.397)
M6x1.0	.0-5.0	M52586	18.0	16.0	1.60	12.0	12.06-12.37	31/64
M6x1.0	.0-5.0	M52587	23.0	16.0	1.60	12.0	11.13-11.43	31/64

DIMENSIONS IN GREEN INDICATE MILLIMETERS (MM) *ALSO AVAILABLE IN SMALL PACKAGED QUANTITIES. INCH SIZES ARE CLASS 2B THREAD. METRIC SIZES ARE CLASS 6H THREAD.

MXN Series Large Flange Cross Bulb Rivet Nuts

Available in Steel-Zinc Plated Threads

MXN — Large Flange Cross Bulb Rivet Nut has a large grip range with pre-bulb shank made up of 4 slots cut to Rivet Nut body providing large blindside footprint for greater pull out strength. Recommended for thin sheet metal and plastics, and works well in oversized hole. May be installed with all pneumatic and manual Rivet Nut tools.



THREAD SIZE	GRIP RANGE MIN-MAX	STEEL *BULK PART #	A BODY LENGTH MIN-MAX	B HEAD DIA	C HEAD HEIGHT	D BODY DIA MAX	HOLE SIZE MIN-MAX	DRILL SIZE
1/4-20	.020-.280	M27150	.985-1.014	.610-.645	.053-.063	.382	.390-.396	25/64
1/4-20	.280-.500	M27155	1.218-1.248	.610-.645	.053-.063	.382	.390-.396	25/64
5/16-18	.020-.280	M27160	1.113-1.166	.740-.770	.057-.067	.495	.500-.506	1/2
5/16-18	.280-.500	M27161	1.359-1.390	.740-.770	.057-.067	.495	.500-.506	1/2
3/8-16**	.020-.280	M27162	1.205-1.233	.865-.895	.083-.093	.587	.594-.600	#53
6MM	.5-7.1	M27151	25.02-25.78	15.49-16.38	1.35-1.60	9.7	10.0-10.15	X (.397)
6MM**	7.1-12.7	M27156	30.96-31.72	15.49-16.38	1.35-1.60	9.7	10.0-10.15	X (.397)
8MM	.5-7.1	M27157	28.29-29.63	18.80-19.56	1.45-1.70	12.57	12.70-12.85	1/2
8MM**	7.1-12.7	M27163	34.54-35.31	18.80-19.56	1.45-1.70	12.57	12.70-12.85	1/2
10MM**	.5-7.1	M27164	30.61-31.32	21.97-22.73	2.11-2.36	14.91	15.09-15.24	#53

DIMENSIONS IN GREEN INDICATE MILLIMETERS (MM) *ALSO AVAILABLE IN SMALL PACKAGED QUANTITIES. INCH SIZES ARE CLASS 2B THREAD. METRIC SIZES ARE CLASS 6H THREAD. ** LIMITED AVAILABILITY, MINIMUMS MAY APPLY.

MET — External Thread Stud Rivet Nuts

Available in Steel-Zinc Plated Threads

MET — External Thread Stud Rivet Nut provides a strong external thread in blind applications. Allows for component mounting and mating nut. Easy to install with Spin/Spin and manual tools using the proper external thread front end assembly.



MET Series External Thread Stud Rivet Nut (Built to order, minimums required)

THREAD SIZE	GRIP RANGE MIN-MAX	*STEEL BULK PART #	A** EXPOSED THREAD	B HEAD DIA @.010" @ .25 MM	L BODY LENGTH @.020" @ .50 MM	C HEAD HEIGHT @.003" @ .08 MM	D BODY DIA MAX	HOLE SIZE MIN-MAX	DRILL SIZE
6-32	.020-.080	M28310	.500	.390	.485	.030	.265	.265-.271	17/64
6-32	.080-.130	M28312	.450	.390	.535	.030	.265	.265-.271	17/64
8-32	.020-.080	M28320	.500	.390	.485	.030	.265	.296-.302	17/64
8-32	.080-.130	M28321	.450	.390	.535	.030	.265	.296-.302	17/64
10-24	.020-.130	M28330	.500	.415	.545	.030	.296	.296-.302	19/64
10-24	.130-.225	M28332	.405	.415	.655	.030	.296	.296-.302	19/64
10-32	.020-.130	M28340	.500	.415	.545	.030	.296	.296-.302	19/64
10-32	.130-.225	M28342	.405	.415	.655	.030	.296	.296-.302	19/64
1/4-20	.027-.165	M28350	.625	.500	.670	.030	.390	.390-.396	25/64
1/4-20	.165-.260	M28354	.530	.500	.770	.030	.390	.390-.396	25/64
5/16-18	.027-.150	M28371	.625	.685	.810	.035	.530	.530-.536	17/32
5/16-18	.150-.312	M28374	.463	.685	.925	.035	.530	.530-.536	17/32
3/8-16	.027-.150	M28381	.750	.685	.810	.035	.530	.530-.536	17/32
3/8-16	.150-.312	M28382	.588	.685	.925	.035	.530	.530-.536	17/32
4MM	.50-2.00	M28360	12.0	9.91	12.32	.76	6.73	6.75+.15	6.75
4MM	2.00-3.30	M28365	10.7	9.91	13.59	.76	6.73	6.75+.15	6.75
5MM	.50-3.30	M28385	12.0	10.54	13.84	.76	7.52	7.6+.15	7.6
5MM	3.30-5.70	M28384	9.6	10.54	16.64	.76	7.52	7.6+.15	7.6
6MM	.70-4.20	M28386	15.0	12.7	17.02	.76	9.91	10.0+.15	10.0
6MM	4.20-6.60	M28387	12.6	12.7	19.56	.76	9.91	10.0+.15	10.0
8MM	.70-3.8	M28388	16.0	17.4	20.57	.89	13.46	13.5+.15	13.5
8MM	3.8-7.90	M28389	11.9	17.4	23.5	.89	13.46	13.5+.15	13.5
10MM	.70-3.8	M28390	20.0	17.4	20.57	.89	13.46	13.5+.15	13.5
10MM	3.8-7.90	M28391	15.9	17.4	23.5	.89	13.46	13.5+.15	13.5

DIMENSIONS IN GREEN INDICATE MILLIMETERS (MM) *ALSO AVAILABLE IN SMALL PACKAGED QUANTITIES. ** DIMENSIONS AT MAXIMUM GRIP RANGE. INCH SIZES ARE CLASS 2B THREAD. METRIC SIZES ARE CLASS 6H THREAD.

MNN — Neoprene Inserts

MNN — Neoprene Insert contains pre-molded brass nut for quick fastening in vibration, moisture protection, shock dampening and even electrical insulation applications. Easy installation from blindside with conventional wrench; just insert the proper thread screw or bolt and tighten.



MNN Series Neoprene Insert

THREAD SIZE	GRIP RANGE MIN-MAX	BULK PART #	A BODY LENGTH @.015" @ 0.38 MM	B HEAD DIA @.010" @ 0.254 MM	C HEAD HEIGHT @.003" @ 0.76 MM	D BODY DIA MAX	HOLE SIZE MIN-MAX	DRILL SIZE MIN-MAX
6-32	.015-.157	M52710	.496	.433	.055	.312	.312-.323	5/16
8-32	.015-.157	M52720	.496	.433	.055	.312	.312-.323	5/16
10-32	.015-.193	M52730	.555	.500	.035	.378	.378-.386	W (.386)
10-32	.033-.232	M52731	.669	.551	.039	.378	.378-.386	W (.386)
10-32	.031-.228	M52732	.709	.748	.079	.378	.378-.386	W (.386)
10-32	.031-.228	M52733	.825	.746	.185	.378	.378-.386	W (.386)
10-32	.311-.630	M52734	.846	.551	.035	.378	.378-.386	W (.386)
10-32	.311-.449	M52735	1.030	.551	.051	.378	.378-.386	W (.386)
10-32	.984-1.256	M52736	1.732	.551	.035	.378	.378-.386	W (.386)
1/4-20	.015-.110	M52750	.630	.630	.051	.500	.500-.508	1/2
1/4-20	.031-.185	M52751	.831	.750	.187	.500	.500-.508	1/2
1/4-20	.252-.453	M52752	1.051	.642	.079	.500	.500-.508	1/2
1/4-20	.453-.906	M52753	1.377	.630	.051	.512	.512-.520	33/64
5/16-18	.015-.157	M52771	.720	.847	.126	.626	.626-.634	41/64
5/16-18	.156-.374	M52772	1.099	.847	.225	.626	.626-.634	41/64
5/16-18	.079-.709	M52773	1.970	.787	.063	.750	.750-.758	3/4
3/8-16	.748-1.570	M52781	2.165	.886	.051	.750	.750-.758	3/4
1/2-13**	1.470-1.575	M52791	3.070	1.060	.051	.945	.945-.953	61/64
M3-0.5	.4-4.0	M52810	12.6	11.0	1.4	7.9	7.90-8.20	7.9
M4-0.7	.4-4.0	M52820	12.6	11.0	1.4	7.9	7.90-8.20	7.9
M5-0.8	.4-4.9	M52830	14.1	12.7	.9	9.6	9.60-9.80	9.6
M5-0.8	.85-5.9	M52831	17.0	14.0	1.0	9.6	9.60-9.80	9.6
M5-0.8	.8-5.8	M52832	18.0	19.0	2.0	9.6	9.60-9.80	9.6
M5-0.8	.8-5.8	M52833	20.95	18.95	4.7	9.6	9.60-9.80	9.6
M5-0.8	7.9-16	M52834	26.1	14.0	1.3	9.6	9.60-9.80	9.6
M5-0.8	7.9-11.4	M52835	21.5	14.0	.9	9.6	9.60-9.80	9.6
M5-0.8	20.5-30	M52836	39.8	14.0	1.3	9.6	9.60-9.80	9.6
M6-1.0	.4-2.8	M52850	16.0	16.0	1.3	12.7	12.7-12.9	1/2
M6-1.0	.8-4.7	M52851	21.1	19.05	4.75	12.7	12.7-12.9	1/2
M6-1.0	6.4-11.5	M52852	26.7	16.3	2.0	12.7	12.7-12.9	1/2
M6-1.0	11.5-23	M52853	35.0	16.0	1.3	13.0	13.0-13.20	13.0
M8-1.25	.4-4.0	M52871	18.3	21.5	3.2	15.9	15.9-16.1	16.0
M8-1.25	3.95-9.5	M52872	27.93	21.5	5.72	15.9	15.9-16.1	16.0
M8-1.25	2.0-18.0	M52873	50.0	20.0	1.6	18.0	18.0-18.2	18.0
M10-1.5	19.0-40.0	M52881	55.0	22.5	1.3	15.9	20.0-20.2	20.0
M12-1.75	36.0-64.0	M52891	78.0	27.0	1.3	15.9	24.0-24.2	24.0

DIMENSIONS IN GREEN INDICATE MILLIMETERS (MM) * ALSO AVAILABLE IN SMALL PACKAGED QUANTITIES. INCH SIZES ARE CLASS 2B THREAD. METRIC SIZES ARE CLASS 6H THREAD. ** BUILT TO ORDER, MINIMUMS REQUIRED.

Rivet Nut Tools and Kits

Klik-Turn® SRN-2 / M39400

The SRN-2 swivel head, hand held Rivet Nut tool features a positive-ratchet locking feature which allows the swivel head to turn 360°. This feature helps hold in place in forty-plus positions. An innovative design, the SRN-2 features a heat treated steel upper handle and precision die-cast body of high-strength aluminum. In addition, the SRN-2 offers adjustable stroke with a positive locking feature, patented fulcrum pin design, quick-change mandrel, comfortable hand grips and longer handles to improve leverage. Included are built-in threaded nosepiece storage holes and a service wrench. The SRN-2 can set steel and aluminum Rivet Nuts up to 1/4-20" and 6mm. The tool is supplied with 6-32, 8-32, 10-24, 10-32 and 1/4-20 mandrels and nosepieces.

Mandrel / Nosepiece Chart

THREAD SIZE	MANDREL No.	NOSEPIECE No.
6-32	M39454	M39361
8-32	M39455	M39362
10-24	M39456	M39363
10-32	M39457	M39363
1/4-20	M39458	M39379
1/4-28*	M39471	M39379
4MM*	M39466	M39374
5MM*	M39467	M39373
6MM*	M39468	M39375

*SOLD SEPERATELY



Rivet Nut Setter™ RN-1 / M39300

Capable of installing all sizes of Rivet Nuts and threaded inserts up to 1/4-20 and 6mm threads in steel, the next-generation Rivet Nut Setter features a quick-change mandrel and longer handles for improved leverage and an adjustable stroke, positive-stop locking feature. Rivet Nut Setter is ergonomically designed, with a forged, heat-treated steel upper handle, precision die-cast body of high-strength aluminum alloy, patented fulcrum pin design and comfortable hand grips. Supplied with 8-32, 10-24 and 10-32 mandrels and nosepieces. Available in a variety of kit forms. Weight: 1.2 lbs.

Mandrel / Nosepiece Chart

THREAD SIZE	MANDREL No.	NOSEPIECE No.	COMPLETE SET No.
6-32	M39354	M39361	M39380
8-32	M39355	M39362	M39381
10-24	M39356	M39363	M39382
10-32	M39357	M39363	M39383
1/4-20	M39358	M39379	M39384
1/4-28	M39371	M39379	
5/16-18*	M39359	NOT NEEDED	
5/16-24*	M39372	NOT NEEDED	
3/8-16*	M39360	NOT NEEDED	
4MM	M39366	M39374	M39385
5MM	M39367	M39373	M39386
6MM	M39368	M39375	M39387
8MM	M39369	NOT NEEDED	

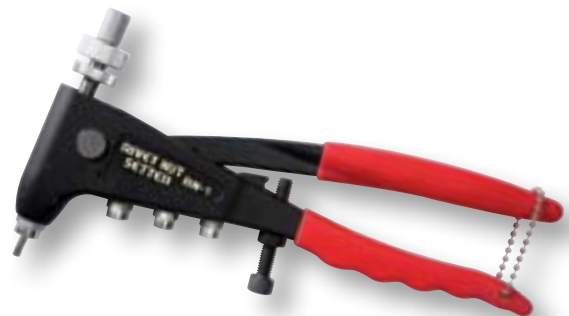

FOR TOOL RN-1 M39300 *NOT RECOMMENDED FOR STEEL RIVET NUT.

Rivet Nut Kit / M39301

Model M39301 Rivet Nut Kit contains the M39300 Rivet Nut tool in a molded plastic case; mandrels and nosepieces for 6-32, 8-32, 10-24 and 1/4-20, instructions and wrench. The kit also includes 103 assorted Klik Rivet Nuts and Klik Poly-Nuts: 25 each M57210, M57425, M57130; 20 each M57250; 8 each M57445. Weight: 2.75 lbs.

Poly-Nut Kit / M39302

Model M39302 Poly-Nut Kit contains the M39300 Rivet Nut tool in a molded plastic case with 8-32, 10-32 and 1/4-20 mandrels and nosepieces, wrench and instructions. The kit contains 52 assorted Klik Poly-Nuts: 12 each M57425, M57435, M57445; 16 each M57455. Weight: 3 lbs.

Metric Poly-Nut Kit / M39303

Model M39303 Metric Poly-Nut Kit contains the M39300 Rivet Nut tool in a molded plastic case with 4mm, 5mm, 6mm and 8mm mandrels and nosepieces, wrench and instructions. The kit contains 75 assorted Klik Poly-Nuts: 25 each M57407, M57409; 15 each M57411; 10 each M57413. Weight: 3.25 lbs.

Ribbed Rivet Nut Kit / M39315

Model M39315 Ribbed Rivet Nut kit contains the M39300 Rivet Nut tool in a molded plastic case; mandrels, nosepieces, wrench and instructions for setting 8-32, 10-24, 10-32 and 1/4-20 Rivet Nuts. The kit also includes 50 assorted Ribbed style Rivet Nuts: 12 each M57320, M57330, M57340; 8 each M57350; 6 each M57354. Weight: 2.75 lbs.

Quad Leg Nut Installation Tool (MJN-2 / M39043)

Marson's MJN-2 hand-held Quad Leg Nut Installation tool is designed to effortlessly set quad leg nuts and Jack Nuts® in sizes ranging from #6-32 to 1/4-20 and M4 to M6. It works by threading the bolt to the quad leg nut, then dropping the component in the slot of the tool, inserting it into the pre-drilled hole and squeezing until set. Tightening the exposed bolt completes the installation.

Jack Nut® is a registered trademark of Stanley Engineered Fastening.



Metric Ribbed Rivet Nut Kit / M39316

Model M39316 Ribbed Rivet Nut kit contains the M39300 Rivet Nut tool in a molded plastic case with 4mm, 5mm and 6mm mandrels and nosepieces, wrench and instructions. The kit also includes 50 assorted Ribbed style Rivet Nuts: 12 each M57360, M57385, M57384; 8 each M57386; 6 each M57387. Weight: 2.75 lbs.

Steel Klik Thread-sert Kit / M39314

Model M39314 Thread-sert Kit contains the M39300 Rivet Nut tool in a plastic case with 6-32, 8-32, 10-24, 10-32, 1/4-20, 5/16-18 and 3/8-16 mandrels and nosepieces, wrench and instructions. The kit contains 62 assorted Steel Klik Thread-serfs: 10 each M57810, M57820, M57830, M57840, M57850; 6 each M57871, M57881. Weight: 3.25 lbs.

Aluminum Klik Thread-sert Kit / M39313

Model M39313 Thread-sert Kit contains the M39300 Rivet Nut tool in a molded plastic case with 6-32, 8-32, 10-24, 10-32, 1/4-20, 5/16-18 and 3/8-16 mandrels and nosepieces, wrench and instructions. The kit contains 62 assorted Aluminum Klik Thread-serfs: 10 each M57910, M57920, M57930, M57940, M57950; 6 each M57971, M57981. Weight: 3 lbs.



Rivet Nut Tools and Kits



325RN / M34604

Choose the M34604 for installing larger size Rivet Nuts. Model M34604 is a heavy-duty tool that will install 10-24 through 3/8"-16, and 5mm through 10mm threaded inserts in aluminum or steel. It features quick-change mandrels with an easily adjustable stroke. Supplied with 1/4"-20 mandrel and nosepiece only. Weight: 4.25 lbs.

325RNK Kit / M34606

The M34606 / 325RNK kit comes complete with the heavy-duty 325RN Rivet Nut tool, mandrels and nosepieces to set 10-24", 10-32", 1/4-20", 5/16-18" and 3/8-16" Rivet Nuts and service / adjustment tools all contained within a sturdy carrying case. Optional external thread adapters available.



425RN / M34607

Like the 325RN, the 425RN will install the full range of Rivet Nuts. It offers quick-change mandrels, easy adjust stroke and a fast-action Push/Pull plunger that can be used to spin on and spin off Rivet Nuts for more speed. Supplied with 1/4-20 mandrel and nosepiece only. Weight 4.5 lbs.

425RNK Kit / M34608

The M34608 / 425RNK kit comes complete with the heavy-duty 425RN Rivet Nut tool, mandrels and nosepieces to set 10-24", 10-32", 1/4-20", 5/16-18" and 3/8-16" Rivet Nuts and service / adjustment tools all contained within a sturdy carrying case. Optional external thread adapters available.



Mandrel / Nosepiece Chart for M34610 Kit (Inch)

THREAD SIZE	MANDREL NO.	NOSEPIECE NO.	MANDREL / NOSEPIECE COMBO No.
10-24	M95635	M95645	M34615
10-32	M95636	M95645	M34616
1/4-20	M95637	M95647	M34617
5/16-18	M95638	M95648	M34618
3/8-16	M95639	M95649	M34619

Mandrel / Nosepiece Chart for M34613 Kit (Inch)

THREAD SIZE	MANDREL NO.	NOSEPIECE NO.	MANDREL / NOSEPIECE COMBO No.
5MM	M95630	M95640	M34625
6MM	M95631	M95641	M34626
8MM	M95632	M95642	M34627
10MM	M95633	M95643	M34628

Mandrel / Nosepiece Chart for M34604 and M34607

THREAD SIZE	MANDREL NO.	NOSEPIECE NO.	MANDREL / NOSEPIECE COMBO No.
10-24	M95635	M95645	M34615
10-32	M95636	M95645	M34616
1/4-20	M95637	M95647	M34617
5/16-18	M95638	M95648	M34618
3/8-16	M95639	M95649	M34619
5MM	M95630	M95640	M34625
6MM	M95631	M95641	M34626
8MM	M95632	M95642	M34627
10MM	M95633	M95643	M34628



140-SP / M39223

The 140-SP features advanced Spin/Pull action, along with 3,057 lbs. of pull force, in a smaller tool. Just hold the Rivet Nut onto the mandrel end and engage; the tool will automatically spin the nut on. Insert the Rivet Nut in the hole and pull the trigger to set the fastener, then toggle to the bottom trigger and reverse spin the mandrel off. Easy installation in seconds. Comes supplied with inch mandrels and nosepieces 6-32" through 1/4-20" conveniently stored in a durable carry case. Mandrels and nosepieces for 4mm through 6mm can be purchased separately. Weight: 4.9 lbs.

Mandrel Nosepiece Chart for 140-SP / M39223

THREAD SIZE	MANDREL NO.	NOSEPIECE NO.
6-32	M88708	M88701
8-32	M88709	M88702
10-24	M88710	M88703
10-32	M88711	M88703
1/4-20	M88712	M88704
4MM	M88651	M88646
5MM	M88652	M88647
6MM	M88653	M88648

160-SP / M39225

Featuring 6,159 lbs. of pull force, the Marson 160-SP Spin/Pull Rivet Nut setting tool is our most powerful air / hydraulic Rivet Nut tool yet. Engage the Rivet Nut onto the mandrel, and the 160-SP automatically threads the fastener on the tool. Pressing and holding the trigger in position will set the Rivet Nut and reverse itself out automatically, all in one operation.

This advanced tool features an adjustable stroke knob in the base of the tool to fully adjust stroke length to suit any grip range. Included is a swivel air inlet for increased mobility. For added convenience, adjustments and changes are performed outside the tool, with no required tear-down to adjust the stroke or change thread sizes.

Comes supplied with either all inch (M39225) or all metric (M39226) mandrels and nosepieces conveniently stored in a durable carry case. Weight: 6 lbs.



Mandrel Nosepiece Chart for 160-SP / M39225

THREAD SIZE	MANDREL NO.	NOSEPIECE NO.
6-32	M71345403	M71345396
8-32	M71345404	M71345397
10-24	M71345405	M71345398
10-32	M71345406	M71345398
1/4-20	M71345407	M71345399
5/16-18	M71345408	M71345400
3/8-16	M71345409	M71345401
1/2-13	M71345410	M71345402

Metric Mandrel Nosepiece Chart for 160-SP / M39226

THREAD SIZE	MANDREL NO.	NOSEPIECE NO.
4MM	M71C00277	M713287
5MM	M71C00278	M713288
6MM	M71C00279	M713289
8MM	M71C00514	M713290
10MM	M71C00281	M713291
12MM	M713177	M713292

Rivet Nut Tools and Kits

Spin/Pull Tool Stroke Adjustment

Follow these easy steps for correct tool stroke adjustment:

1. Measure and write down the overall length of Rivet Nut.
2. Write down the Maximum Grip Range of the Rivet Nut (reference catalog).
3. Subtract Material Thickness from Maximum Grip range.
4. Add the Pull-up Factor from chart at right for your existing thread size.
5. This will give you the correct stroke required to properly set the Rivet Nut.
6. To double check, set a Rivet Nut, measure length and subtract from length of a non-set Rivet Nut (#1). Adjust tool stroke accordingly.

Example: M57150 (1/4-20) Rivet Nut
 Max Grip of Rivet Nut: (.080)
 Subtract Material Thickness: - (.060)
 Difference: (.020)
 Add Pull-up Factor for 1/4": + (.095)
 Equals Required Tool Stroke: = (.115)

Refer to page 39 for fractional breakdown of decimal.

Pull-up Factor Chart Per Thread Size

INCH	METRIC
4 - .055	M3 - .055
6 - .065	M4 - .075
8 - .065	M5 - .095
10 - .080	M6 - .115
1/4 - .095	M7 - .115
5/16 - .120	M8 - .125
3/8 - .155	M10 - .155
1/2 - .185	M12 - .180

SST Series

The versatile, low cost Spin/Spin pneumatic Rivet Nut production tool now comes with a quick-change nosepiece assembly and standard socket head cap screw for convenient replacement and changeover. For added ease of operation, the Spin/Spin offers a superior ergonomic design, lightweight body and operates without stroke adjustment. Available models come with two front assemblies of your choice (refer to table below).

Additional nosepiece and mandrel sizes are available:

- SST-1/M39801 - 3000 RPM
- SST-2/M39802 - 1500 RPM
- SST-3/M39803 - 600 RPM
- SST-4/M39804 - 400 RPM



MARSON SPIN/ TOOL MODEL THREAD SIZE	3000 RPM SST-1		1500 RPM SST-2		600 RPM SST-3		400 RPM SST-4
	RECOMMENDED	RECOMMENDED	OPTIONAL	RECOMMENDED	OPTIONAL	RECOMMENDED	
4-40	✓						
6-32	✓						
8-32	✓		✓				
10-24		✓			✓		
10-32		✓			✓		
1/4-20			✓	✓			
1/4-28			✓	✓			
5/16-18					✓	✓	
5/16-24					✓	✓	
3/8-16						✓	
3/8-24						✓	
M3	✓						
M4	✓		✓				
M5		✓			✓		
M6			✓	✓			
M8					✓	✓	
M10						✓	

OPERATOR IS LIABLE FOR CORRECT AIR PRESSURE. DO NOT EXCEED 100 PSI.

Purchasing the Optional Front End Assemblies are at the Owner's discretion. Care must be taken to optimize the tool's Rivet Nut setting ability. Recommended for thin wall Rivet Nuts only. Adjustment of the air pressure will be necessary in order for the tool to function in both minimum and maximum capacity on ALL optional thread sizes per tool. Contact customer service for available retrofit for MET external thread.

Conversion Tables

Spin/Spin Front End Assembly Table

RECOMMENDED TOOL	INCH SIZE	FRONT END ASSEMBLY FEA #
M39801	4-40	M95500
M39801	6-32	M95501
M39801	8-32	M95502
M39802	10-24	M95503
M39802	10-32	M95504
M39803	1/4-20	M95505
M39803	1/4-28	M95506
M39804	5/16-18	M95507
M39804	5/16-24	M95508
M39804	3/8-16	M95509
M39804	3/8-24	M95510

CONTACT CUSTOMER SERVICE FOR MET SERIES FRONT ENDS.

FEA PARTS			
ANVIL/ NOSEPIECE	3 BEARING SET	HEX-DRIVE	MANDREL/ SCREW THREAD
M95399	M95525	M95535	M95424
M95400	M95526	M95536	M95425
M95401	M95527	M95537	M95426
M95402	M95528	M95538	M95427
M95402	M95528	M95538	M95428
M95404	M95529	M95539	M95429
M95404	M95529	M95539	M95430
M95406	M95530	M95540	M95431
M95406	M95530	M95540	M95432
M95408	M95531	M95541	M95433
M95408	M95531	M95541	M95434

RECOMMENDED TOOL	METRIC SIZE	FRONT END ASSEMBLY FEA #
M39801	M3	M95515
M39801	M4	M95516
M39802	M5	M95517
M39803	M6	M95518
M39804	M8	M95519
M39804	M10	M95520

FEA PARTS			
ANVIL/ NOSEPIECE	3 BEARING SET	HEX-DRIVE	MANDREL/ SCREW THREAD
M95400	M95526	M95545	M95440
M95401	M95527	M95546	M95441
M95402	M95528	M95547	M95442
M95404	M95529	M95548	M95443
M95406	M95530	M95549	M95444
M95408	M95531	M95550	M95445

Conversion Tables

Inch-Metric Conversion Table

INCHES			INCHES		
FRACTION	DECIMAL	MM	FRACTION	DECIMAL	MM
1/64	.015 625	.397	33/64	.515 625	13.097
1/32	.031 250	.794	17/32	.531 250	13.494
3/64	.046 875	1.191	35/64	.546 875	13.891
1/16	.062 500	1.588	9/16	.562 500	14.288
5/64	.078 125	1.984	37/64	.578 125	14.684
3/32	.093 750	2.381	19/32	.593 750	15.081
7/64	.109 375	2.778	39/64	.609 375	15.478
1/8	.125 000	3.175	5/8	.625 000	15.875
9/64	.140 625	3.572	41/64	.640 625	16.272
5/32	.156 250	3.969	21/32	.656 250	16.669
11/64	.171 875	4.366	43/64	.671 875	17.066
3/16	.187 500	4.763	11/16	.687 500	17.463
13/64	.203 125	5.159	45/64	.703 125	17.860
7/32	.218 750	5.556	23/32	.718 750	18.256
15/64	.234 375	5.953	47/64	.734 375	18.653
1/4	.250 000	6.350	3/4	.750 000	19.050
17/64	.265 625	6.747	49/64	.765 625	19.447
9/32	.281 250	7.144	25/32	.781 250	19.844
19/64	.296 875	7.541	51/64	.796 875	20.241
5/16	.312 500	7.938	13/16	.812 500	20.638
21/64	.328 125	8.334	53/64	.828 125	21.034
11/32	.343 750	8.731	27/32	.843 750	21.431
23/64	.359 375	9.128	55/64	.859 375	21.828
3/8	.375 000	9.525	7/8	.875 000	22.225
25/64	.390 625	9.922	57/64	.890 625	22.622
13/32	.406 250	10.319	29/32	.906 250	23.019
27/64	.421 875	10.716	59/64	.921 875	23.416
7/16	.437 500	11.113	15/16	.937 500	23.813
29/64	.453 125	11.510	61/64	.953 125	24.209
15/32	.468 750	11.906	31/32	.968 750	24.606
31/64	.484 375	12.303	63/64	.984 375	25.003
1/2	.500 000	12.700	1	1.000 000	25.400

DIMENSIONS IN GREEN INDICATE MILLIMETERS (MM)

Decimal Equivalents of Standard Sheet Gauges

INCHES No. OF GAUGE	THICKNESS IN THOUSANDTHS	
	ALUMINUM (B&S)	STEEL (U.S. STD.)
10	.102	.135
11	.091	.120
12	.081	.105
13	.072	.090
14	.064	.075
15	.057	.067
16	.051	.060
17	.045	.054
18	.040	.048
19	.036	.042
20	.032	.036
21	.029	.033
22	.025	.030
23	.023	.027
24	.020	.024
25	.018	.021
26	.016	.018
27	.014	.016
28	.012	.015
29	.011	.014
30	.010	.012



**HOWMET
AEROSPACE**

Howmet Fastening Systems

Industrial Division Brands



Huck, Marson, Recoil, Keysert, Camloc, Simmonds and Snep are trademarks of Howmet Aerospace Inc. and/or its subsidiaries.

North America

Waco Operations

PO Box 8117
8001 Imperial Drive
Waco, TX 76714-8117
Tel: +1 800-388-4825
Fax: +1 800-798-4825
hfs.sales.waco@howmet.com

Kingston Operations

1 Corporate Drive
Kingston, NY 12401
Tel: +1 800-278-4825
Fax: +1 845-334-7333
hfs.sales.kingston@howmet.com

Tracy Operations

1925 North MacArthur Drive
Tracy, CA 95376
Tel: +1 800-826-2884
Fax: +1 800-573-2645
hfs.sales.idg@howmet.com

Global

Telford Operations

Unit C, Stafford Park 7
Telford, Shropshire
England TF3 3BQ
Tel: +44 (0) 1952-290011
Fax: +44 (0) 1952-290459
thisales@howmet.com

Suzhou Operations

58 Yinsheng Road,
SIP Suzhou, Jiangsu
215126 China
Tel: +86-512-62863800-8888

Melbourne Operations

1508 Centre Road
Clayton, Victoria
Australia 3168
Tel: +613-8545-3333
Fax: +613-8545-3390
hfs.sales@howmet.com

Tokyo Operations (Japan & Korea)

1013 Hibiya U-1 Bldg.
Uchisaiwai-cho 1-1-7
Chiyoda-ku, Tokyo
100-0011 Japan
Tel: +81-3-3539-6594
Fax: +81-3-3539-6585

hfsindustrial.com

[YouTube.com/HFSIndustrial](https://www.youtube.com/HFSIndustrial)

The information contained in this publication is only for general guidance, and is not intended to create any warranty, express, implied, or statutory; all warranties are contained only in Howmet Fastening Systems' written quotations, acknowledgments, and/or purchase orders. It is recommended that the user secure specific, up-to-date data and information regarding each application and/or use of such products.

© 2020 Howmet Aerospace Inc. All rights reserved. HFS6010 0220
HP-2, HP-3, Klik-Lock, Klik-Turn, Klik-Split, Thread-Sert, Big Daddy, Q-Lok, Magna-Grip, Magna-Lok,
Magna-Tite and BOM are trademarks of Howmet Aerospace Inc. and/or its subsidiaries.