

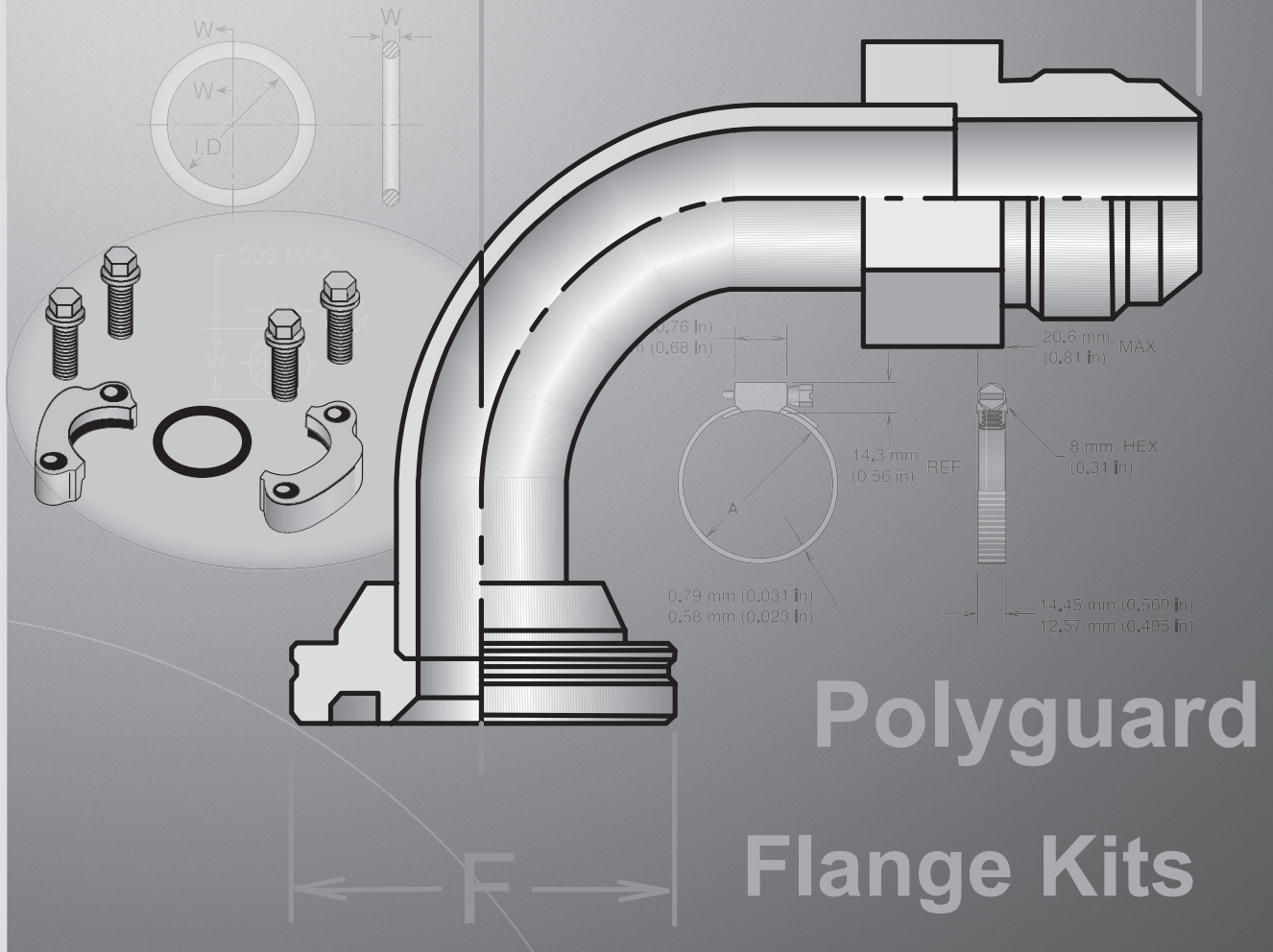

Accessories

ACCESSORIES

More of what you need to work smarter,
faster, and better. Visit www.parkerhose.com for
up-to-the-minute accessory selections.











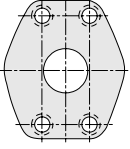
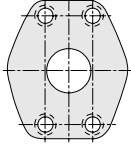

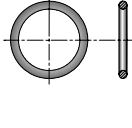
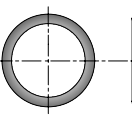









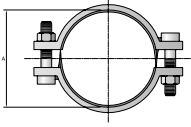

Polyguard Flange Kits

Parker Kart

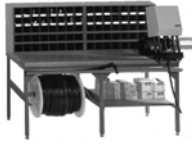
Fire Sleeve

Hose
A
Fittings
B
Equipment
C
Accessories
D
Technical
E

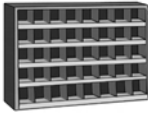
 <p>Hydraulic Flanges</p>	15T3 D-5	17T3 D-5	19T3 D-5	39T3 D-6	41T3 D-6
	<i>Straight</i>	<i>45° Elbow</i>	<i>90° Elbow</i>	<i>Swivel Nut 90° Tube Elbow</i>	<i>Swivel Nut 90° Tube Elbow - Long</i>
4AH3 D-6	4FH3 D-7	4NH3 D-7	6AH3 D-7	6FH3 D-7	6NH3 D-8
<i>Straight</i>	<i>45° Elbow</i>	<i>90° Elbow</i>	<i>Straight</i>	<i>45° Elbow</i>	<i>90° Elbow</i>
4AJM D-8	4FJM D-8	4NJM D-8	6AJM D-9	6FJM D-9	6NJM D-9
<i>Straight</i>	<i>45° Elbow</i>	<i>90° Elbow</i>	<i>Straight</i>	<i>45° Elbow</i>	<i>90° Elbow</i>
Standard Pressure (Code 61) D-10	High Pressure (Code 62) D-10	50H D-10	5050HK D-11	51H D-11	5151HK D-11
		<i>Flange Half 5000 psi (Code 61)</i>	<i>Flange 5000 psi (Code 61) Kit</i>	<i>Flange Half (Code 61)</i>	<i>Flange (Code 61) Kit</i>
HFH D-12	HFHFHK D-12	8FH D-12	8FHFHK D-12	M1H D-13	M1M1HK D-13
<i>Flange Half (Code 62)</i>	<i>Flange (Code 62) Kit</i>	<i>Flange Half (8000 psi)</i>	<i>Flange Kit (8000 psi)</i>	<i>ISO (Code 61)</i>	<i>ISO (Code 61) Kit</i>
M2H D-14	M2M2HK D-14	 <p>O-Rings</p>		711509 D-15	711510 D-15
<i>ISO (Code 62)</i>	<i>ISO (Code 62) Kit</i>				
C9RG D-15	D9DT D-15	J0RG D-16	XARG D-16	8ARG D-16	59RG D-17
<i>O-Rings for C9, OC, 1C Metric Swivels</i>	<i>Bonded Seal for BSSP Port Fittings</i>		<i>Flange "D" Rings Caterpillar® Style Flanges</i>	<i>Flange "D" Rings</i>	<i>Tube O-Ring Fittings and Compressor Fittings</i>
T1RG D-17	CORG D-17	 <p>Hose Guards</p>		Partek Sleeve D-18	PolyGuard (HG) D-19
<i>O-Rings for Compression Fittings (IT126)</i>					

Spring Guard (SG) D-20 Armor Guard (AG) 	Firesleeve (FS-F) D-21 	FSC Clamp D-21 	Firesleeve Accessories D-22	Firesleeve Assembly Instructions D-22	CL Clamp D-23 
HC Clamp D-24 	88HC-H Clamp D-24 	88DB Clamp D-24 	Protection Shields D-25 	Hose Assembly Workstations	Hose Assembly D-26 Workstations 
HoseFab Table D-27 	Rotary Reel Rack D-27 	Saw Table D-27 	3/4 Reel Rack D-27 	Parker Kart D-28 	72B-Cabinet D-28 
HR6 Hose Bin D-28 	Hose Adapters	Hose Adapters D4 			

Hose
A

Fittings
B

Equipment
C

Accessories
D

Technical
E

Hose
A

Fittings
B

Equipment
C

Accessories
D

Technical
E

SAE/NPT/Metric Hose Adapters



O-Ring Face-Seal Seal-Lok™

Sizes: 6 mm – 38 mm
Materials: Steel, Stainless Steel
Pressures: Up to 9200 psi

O-Ring Face-Seal Metric Seal-Lok™

Sizes: 1/4" – 2"
Materials: Steel, Stainless Steel
Pressures: Up to 9200 psi

37° Flare Fittings Triple-Lok®

Sizes: 1/8" – 2"
Materials: Steel, Stainless Steel, Brass
Pressures: Up to 9000 psi

37° Flare Metric Triple-Lok®

Sizes: 6 mm – 38 mm
Materials: Steel, Stainless Steel
Pressures: Up to 7200 psi

Pipe Fittings and Port Adapters

Sizes: 1/8" – 2"
Materials: Steel, Stainless Steel, Brass
Pressures: Up to 7200 psi

Conversion Adapters

Sizes: 1/4" – 1-1/2"
Materials: Steel, Stainless Steel
Pressures: Up to 7700 psi



Pipe Swivels

Sizes: 1/8" – 2"
Materials: Steel, Stainless Steel
Pressures: Up to 5000 psi

Hydraulic Flange and Flange Adapters

Sizes: 3/4" – 3"
Materials: Steel, Stainless Steel
Pressures: Up to 6000 psi

Japanese Industrial Standard JIS

Sizes: 1/4" – 1"
Materials: Steel
Pressures: Up to 5000 psi

30° Flare Komatsu Style

Sizes: M14 x 1.5 – M33 x 1.5
Materials: Steel
Pressures: Up to 4000 psi

60° Cone BSPP K4

Sizes: 1/8" – 2"
Materials: Steel
Pressures: Up to 5000 psi

How to Order Parker Hose Adapters

When ordering Parker Adapters, please state the Catalogued Number of each type of adapter desired. Be sure to double check tube and hose sizes of items required.

To select proper seal materials for specific applications, refer to Media Compatibility Chart in Tube Fitting Catalog 4300, or contact your Parker Tube Fitting Distributor.

If in doubt about which type or size of fitting to specify, consult your Parker Tube Fitting Distributor. In addition Parker Field Sales, Technical Services, the Tube Fitting Division and your local Parker Service Center will help you find answers to all your issues.

Phone: (614) 279-7070
Fax: (614) 279-7685
Web: <http://www.parker.com/tfd>

Note: Refer to **Parker Catalog 4300** for more detailed application information.

CALL TOLL-FREE 1-800-C PARKER (1-800-272-7537)

Parker Information Center for catalogs, literature or additional information.



15T3

SAE (Code 61) Flange – Male SAE (JIC) 37° Flare

# Part Number	Flange inch	Thread T1		A		W inch	F inch
		inch	mm	inch	mm		
15T3-8-8	1/2	1/2	3/4x16	2.80	71	1-1/4	1-3/16
15T3-12-12	3/4	3/4	1-1/16x12	3.20	81	1-9/16	1-1/2
15T3-16-12	1	3/4	1-1/16x12	2.68	47	1-1/8	1-3/4
15T3-16-16	1	1	1-5/16x12	3.22	82	1-7/8	1-3/4
15T3-20-16	1-1/4	1	1-5/16x12	2.76	51	1-3/8	2
15T3-20-20	1-1/4	1-1/4	1-5/8x12	3.69	94	2-1/4	2
15T3-24-24	1-1/2	1-1/2	1-7/8x12	4.04	103	2-1/2	2-3/8
15T3-32-32	2	2	2-1/2x12	4.44	113	2-7/8	2-13/16

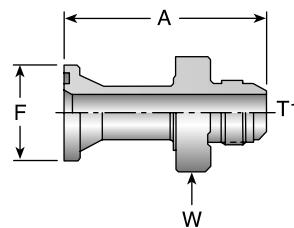

17T3

SAE (Code 61) Flange – Male SAE (JIC) 37° Flare - 45° Elbow

# Part Number	Flange inch	Thread T1		A		E		W inch	F inch
		inch	mm	inch	mm	inch	mm		
17T3-8-8	1/2	1/2	3/4x16	2.54	65	0.78	20	13/16	1-3/16
17T3-12-12	3/4	3/4	1-1/16x12	2.76	70	1.00	25	1-9/16	1-1/2
17T3-16-12	1	3/4	1-1/16x12	2.76	70	1.00	25	1-1/8	1-3/4
17T3-16-16	1	1	1-5/16x12	2.99	76	1.06	27	1-3/8	1-3/4
17T3-20-16	1-1/4	1	1-5/16x12	2.99	76	1.06	27	1-7/8	2
17T3-20-20	1-1/4	1-1/4	1-5/8x12	3.22	82	1.12	28	1-11/16	2
17T3-24-20	1-1/2	1-1/4	1-5/8x12	3.26	83	1.17	30	1-11/16	2-3/8
17T3-24-24	1-1/2	1-1/2	1-7/8x12	3.43	87	1.12	28	2	2-3/8
17T3-32-32	2	2	2-1/2x12	4.02	102	1.25	32	2-5/8	2-13/16

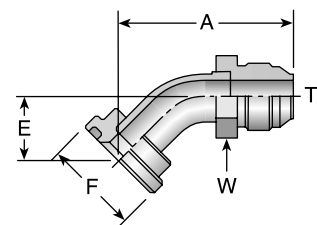

19T3

SAE (Code 61) Flange – Male SAE (JIC) 37° Flare - 90° Elbow

# Part Number	Flange inch	Thread T1		A		E		W inch	F inch
		inch	mm	inch	mm	inch	mm		
19T3-8-8	1/2	1/2	3/4x16	1.92	49	1.62	41	13/16	1-13/16
19T3-12-12	3/4	3/4	1-1/16x12	2.46	62	2.12	54	1-1/8	1-1/2
19T3-16-12	1	3/4	1-1/16x12	2.46	62	2.12	54	1-3/8	1-3/4
19T3-20-12	1-1/4	3/4	1-1/16x12	2.46	62	2.12	54	1-3/8	2
19T3-16-16	1	1	1-5/16x12	2.79	71	2.37	60	1-3/8	1-3/4
19T3-20-16	1-1/4	1	1-5/16x12	2.79	71	2.37	60	1-3/8	2
19T3-24-16	1-1/2	1	1-5/16x12	2.79	71	2.44	62	1-11/16	2-3/8
19T3-20-20	1-1/4	1-1/4	1-5/8x12	3.12	79	2.50	64	1-11/16	2
19T3-24-20	1-1/2	1-1/4	1-5/8x12	3.12	79	2.56	65	1-11/16	2-3/8
19T3-20-24	1-1/4	1-1/2	1-7/8x12	3.48	88	2.69	68	2	2
19T3-24-24	1-1/2	1-1/2	1-7/8x12	3.48	88	2.75	70	2	2-3/8
19T3-32-24	2	1-1/2	1-7/8x12	3.48	88	2.75	70	2	2-13/16
19T3-32-32	2	2	2-1/2x12	5.61	142	4.50	114	2-5/8	2-13/16

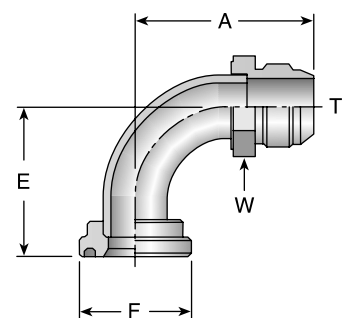

Caution: Do not use the T3 flange to tube or swivel nut to tube adapter in hose assembly applications in which pressures exceed the SAE100R2 working pressure range.

Hose
A

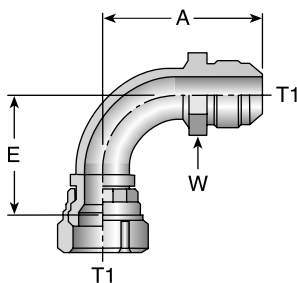

39T3

Male - Female Swivel - SAE (JIC) 37° - 90° Elbow

# Part Number	Thread T1		A		E		W
	inch	mm	inch	mm	inch	mm	inch
39T3-6-6	3/8	9/16x18	1.61	41	0.85	22	5/8
39T3-8-8	1/2	3/4x16	1.86	47	1.09	28	13/16
39T3-10-10	5/8	7/8x14	2.13	54	1.24	31	15/16
39T3-12-12	3/4	1-1/16x12	2.62	67	1.81	46	1-1/8
39T3-16-16	1	1-5/16x12	2.94	75	2.14	54	1-3/8
39T3-20-20	1-1/4	1-5/8x12	3.12	79	2.59	66	1-11/16

Fittings
B

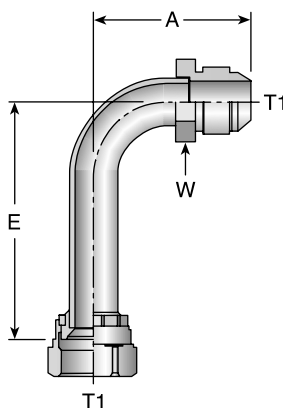

41T3

Male - Female Swivel - SAE (JIC) 37° - 90° Elbow - Long

# Part Number	Thread T1		A		E		W
	inch	mm	inch	mm	inch	mm	inch
41T3-8-8	1/2	3/4x16	1.94	49	2.43	62	13/16
41T3-10-10	5/8	7/8x14	2.20	56	2.57	65	15/16
41T3-12-12	3/4	1-1/16x12	2.50	64	3.74	95	1-1/8
41T3-16-16	1	1-5/16x12	2.79	71	4.23	107	1-3/8

Equipment
C

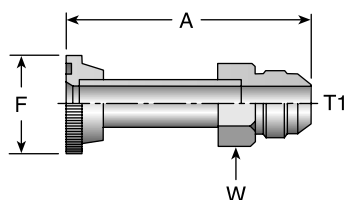

4AH3

SAE Code 61 Flange - Male SAE (JIC) 37° Flare - 5000 psi

# Part Number	Flange	Thread T1		A		W	F
	inch	inch	mm	inch	mm	inch	inch
4AH3-12-12	3/4	3/4	1-1/16x12	3.82	97	1-1/8	1-1/2
4AH3-16-16	1	1	1-5/16x12	4.09	104	1-3/8	1-3/4
4AH3-20-20	1-1/4	1-1/4	1-5/8x12	4.16	106	1-3/4	2
4AH3-24-24	1-1/2	1-1/2	1-7/8x12	4.97	126	2	2-3/8

Accessories
D

Technical
E

Caution: Do not use the T3 flange to tube or swivel nut to tube adapter in hose assembly applications in which pressures exceed the SAE100R2 working pressure range.

4FH3

SAE Code 61 Flange - Male SAE (JIC) 37° Flare - 5000 psi - 45° Elbow

# Part Number	Flange		Thread T1		A		E		W	F
	inch				inch	mm	inch	mm	inch	inch
4FH3-12-12	3/4		3/4	1-16x12	3.39	86	1.06	27	1-1/8	1-1/2
4FH3-16-16	1		1	1-5/16x12	3.85	98	1.27	32	1-3/8	1-3/4
4FH3-20-20	1-1/4		1-1/4	1-5/8x12	4.22	107	1.36	35	1-3/4	2

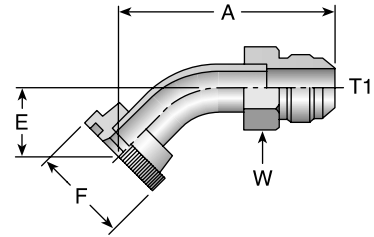

4NH3

SAE Code 61 Flange - Male SAE (JIC) 37° Flare - 5000 psi - 90° Elbow

# Part Number	Flange		Thread T1		A		E		W	F
	inch				inch	mm	inch	mm	inch	inch
4NH3-8-8	1/2		1/2	3/4x16	1.93	49	1.68	43	13/16	1-13/16
4NH3-12-12	3/4		3/4	1-1/16x12	3.07	78	2.24	57	1-1/8	1-1/2
4NH3-16-16	1		1	1-5/16x12	3.25	83	2.48	63	1-3/8	1-3/4
4NH3-20-20	1-1/4		1-1/4	1-5/8x12	4.68	119	2.99	76	1-3/4	2
4NH3-24-24	1-1/2		1-1/2	1-7/8x12	3.92	100	3.64	92	2	2-3/8

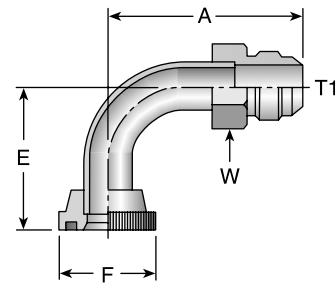

6AH3

SAE Code 62 Flange - Male SAE (JIC) 37° Flare

# Part Number	Flange		Thread T1		A		W	F
	inch				inch	mm	inch	inch
6AH3-12-12	3/4		3/4	1-1/16x12	3.82	97	1-1/8	1-5/8
6AH3-16-16	1		1	1-5/16x12	4.09	104	1-3/8	1-7/8
6AH3-20-20	1-1/4		1-1/4	1-5/8x12	4.16	106	1-3/4	2-1/8
6AH3-24-24	1-1/2		1-1/2	1-7/8x12	4.97	126	2	2-1/2

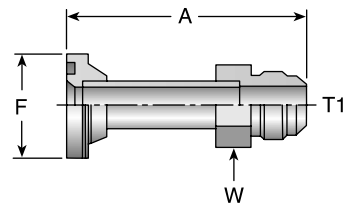

6FH3

SAE Code 62 Flange - Male SAE (JIC) 37° Flare - 45° Elbow

# Part Number	Flange		Thread T1		A		E		W	F
	inch				inch	mm	inch	mm	inch	inch
6FH3-12-12	3/4		3/4	1-1/16x12	3.40	86	1.06	27	1-1/8	1-5/8
6FH3-16-16	1		1	1-5/16x12	3.85	98	1.28	33	1-3/8	1-7/8
6FH3-20-20	1-1/4		1-1/4	1-5/8x12	4.22	107	1.36	35	1-3/4	2-1/8
6FH3-24-24	1-1/2		1-1/2	1-7/8x12	5.13	130	1.71	43	2	2-1/2

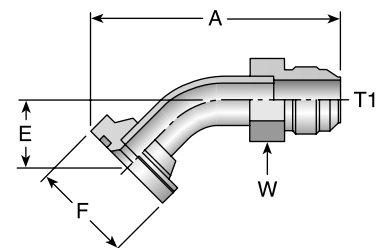

Hose
A

Fittings
B

Equipment
C

Accessories
D

Technical
E

Hose
A

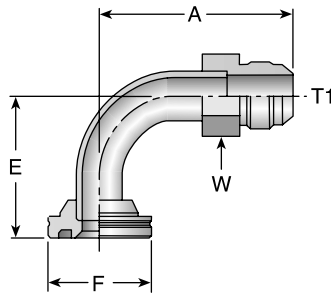

6NH3

SAE Code 62 Flange - Male SAE (JIC) 37° Flare - 90° Elbow

# Part Number	Flange inch	Thread T1	A		E		W inch	F inch	
			inch	mm	inch	mm			
6NH3-12-12	3/4	3/4	1-1/16x12	3.07	78	2.24	57	1-1/8	1-5/8
6NH3-16-16	1	1	1-5/16x12	3.58	91	2.81	71	1-3/8	1-7/8
6NH3-20-20	1-1/4	1-1/4	1-5/8x12	4.68	119	2.99	76	1-3/4	2-1/8
6NH3-24-24	1-1/2	1-1/2	1-7/8x12	3.92	100	3.64	92	2	2-1/2

Fittings
B

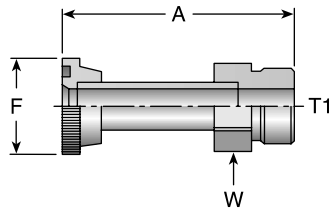

4AJM

Code 61 Flange - Male Seal-Lok

# Part Number	Flange inch	Thread T1	A		W inch	F inch
			inch	mm		
4AJM-12-12	1x1/2	1-3/16x12	3.65	93	1-1/4	1-1/2
4AJM-16-16	1x3/4	1-7/16x12	3.90	99	1-1/2	1-3/4
4AJM-20-20	2	1-11/16x12	3.92	100	1-3/4	2

Equipment
C

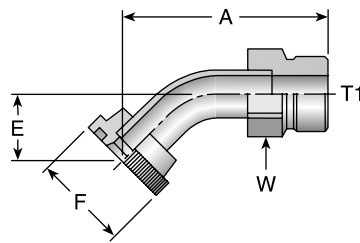

4FJM

Code 61 Flange - Male Seal-Lok - 45° Elbow

# Part Number	Flange inch	Thread T1	A		E		W inch	F inch
			inch	mm	inch	mm		
4FJM-12-12	1x1/2	1-3/16x12	3.22	82	1.06	27	1-1/4	1-1/2
4FJM-16-16	1x3/4	1-7/16x12	3.64	92	1.27	33	1-1/2	1-3/4
4FJM-20-20	2	1-11/16x12	3.99	101	1.36	35	1-3/4	2

Accessories
D

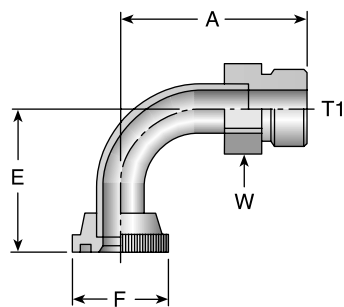

4NJM

Code 61 Flange - Male Seal-Lok - 90° Elbow

# Part Number	Flange inch	Thread T1	A		E		W inch	F inch
			inch	mm	inch	mm		
4NJM-12-12	1x1/2	1-3/16x12	2.90	74	2.24	57	1-1/4	1-1/2
4NJM-16-16	1x3/4	1-7/16x12	3.38	86	2.81	71	1-1/2	1-3/4
4NJM-20-20	2	1-11/16x12	4.44	113	2.99	76	1-3/4	2

Technical
E

6AJM

Code 62 Flange - Male Seal-Lok

# Part Number	Flange inch	Thread T1	A		W inch	F inch
			inch	mm		
6AJM-12-12	1x1/2	1-3/16x12	3.65	93	1-1/4	1-5/8
6AJM-16-16	1-7/16x12	1-7/16x12	3.90	99	1-1/2	1-7/8
6AJM-20-20	2-1/8	1-11/16x12	3.92	100	1-3/4	2-1/8

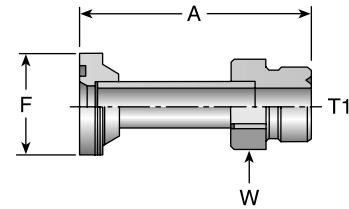

6FJM

Code 62 Flange - Male Seal-Lok - 45° Elbow

# Part Number	Flange inch	Thread T1	A		E		W inch	F inch
			inch	mm	inch	mm		
6FJM-12-12	1x1/2	1-3/16x12	3.22	82	1.06	27	1-1/4	1-5/8
6FJM-16-16	1-7/16x12	1-7/16x12	3.64	92	1.27	33	1-1/2	1-7/8
6FJM-20-20	2-1/8	1-11/16x12	3.99	101	1.36	35	1-3/4	2-1/8

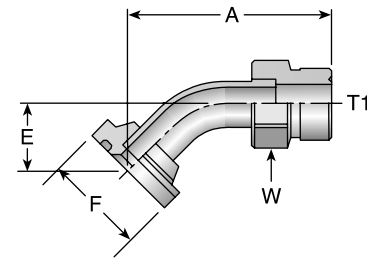

6NJM

Code 62 Flange - Male Seal-Lok - 90° Elbow

# Part Number	Flange inch	Thread T1	A		E		W inch	F inch
			in	mm	in	mm		
6NJM-12-12	1x1/2	1-3/16x12	2.90	74	2.24	57	1-1/4	1-5/8
6NJM-16-16	1-7/16x12	1-7/16x12	3.38	86	2.81	71	1-1/2	1-7/8
6NJM-20-20	2-1/8	1-11/16x12	4.44	113	2.99	76	1-3/4	2-1/8

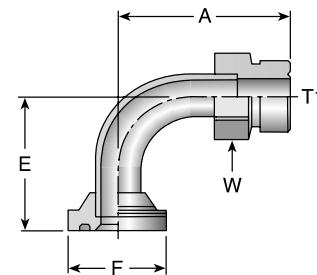

Hose
A

Fittings
B

Equipment
C

Accessories
D

Technical
E

SAE J518 port dimensions for 4-Bolt Split Flanges

There are two non-interchangeable SAE split flanges:

- a. Standard or Code 61 is for 3,000psi to 5,000psi maximum, depending on size.
- b. High Pressure or Code 62 is for 6,000psi maximum, regardless of size. The flange head is "V" notched for identification.

Consult these tables to determine flange halves and flange kits specifications.

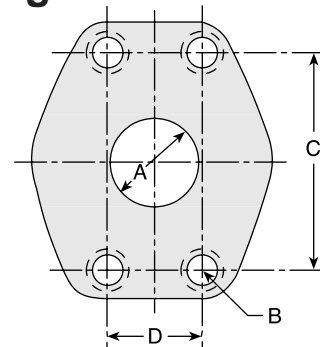

Standard Pressure (Code 61)

Nominal Flange	Flange Dash Size	A Dia Max		B Thread	C		D		Maximum Working Pressure	
		inch	mm		±0.010 inch	±0.25 mm	±0.010 inch	±0.25 mm	psi	MPa
1/2	-8	0.50	13	5/16x18	1.50	38,10	0.68	17,47	5,000	34,5
3/4	-12	0.75	19	3/8x16	1.88	47,63	0.87	22,22	5,000	34,5
1	-16	1.00	25	3/8x16	2.06	52,37	1.03	26,18	5,000	34,5
1 1/4	-20	1.25	32	7/16x14	2.31	58,72	1.18	30,17	4,000*	27,6
1 1/2	-24	1.50	38	1/2x13	2.75	69,85	1.40	35,71	3,000*	20,7
2	-32	2.00	51	1/2x13	3.06	77,77	1.68	42,87	3,000*	20,7

Note: *5000 psi with 4A, 4F and 4N Fittings and 50H Flange Halves.

High Pressure (Code 62)

Nominal Flange	Flange Dash Size	A Dia Max		B Thread	C		D		Maximum Working Pressure	
		inch	mm		±0.010 inch	±0.25 mm	±0.010 inch	±0.25 mm	psi	MPa
3/4	-12	0.75	19	3/8x16	2.00	47,75	0.88	22,35	6,000	41,4
1	-16	1.00	25	7/16x14	2.25	57,15	1.09	27,76	6,000	41,4
1-1/4	-20	1.25	32	1/2x13	2.63	66,67	1.25	31,75	6,000	41,4
1-1/2	-24	1.50	38	5/8x11	3.13	79,37	1.43	36,49	6,000	41,4
2	-32	2.00	51	3/4x10	3.81	96,82	1.75	44,45	6,000	41,4

50H

5000 psi Flange Half (Code 61)

# Part Number	SAE Flange Size inch	A inch	B inch	C inch	Maximum Working Pressure psi
50H-20	1-1/4	2.31	0.55	0.47	5,000
50H-24	1-1/2	2.75	0.66	0.53	5,000
50H-32	2	3.06	0.80	0.53	5,000

Note: For use with 4A, 4F and 4N Flanges.

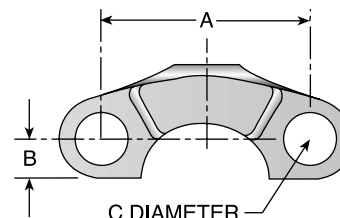

Hose
A

Fittings
B

Equipment
C

Accessories
D

Technical
E

5050HK 5000 psi Flange Kit (Code 61)

# Part Number	SAE Flange Size inch	Maximum Working Pressure (psi)	(2) Flange Halves	O-Ring	(4) Bolts Grade 8		(4) Washers
					Thread inch	Length inch	
5050HK-20	1-1/4	5,000	50H-20	711510-3	7/16x14	1-1/2	7/16
5050HK-24	1-1/2	5,000	50H-24	711510-2	1/2x13	1-1/2	1/2
5050HK-32	2	5,000	50H-32	711510-1	1/2x13	1-1/2	1/2

Note: For use with 4A, 4F and 4N Flanges.

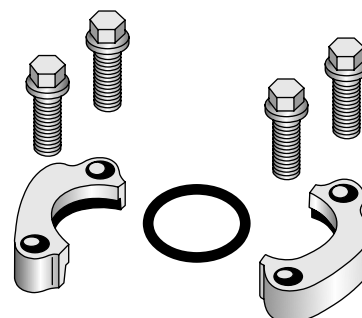

51H SAE Flange Half (Code 61)

# Part Number	SAE Flange Size inch	A inch	B inch	C inch	Maximum Working Pressure psi
51H-8	1/2	1.50	0.31	0.34	5,000
51H-12	3/4	1.88	0.40	0.41	5,000
51H-16	1	2.06	0.48	0.41	5,000
51H-20	1-1/4	2.31	0.56	0.47	4,000
51H-24	1-1/2	2.75	0.67	0.53	3,000
51H-32	2	3.06	0.81	0.53	3,000
51H-40	2-1/2	3.50	0.96	0.53	2,500

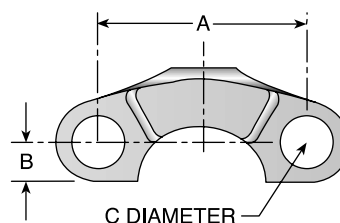

5151HK SAE Flange Kit (Code 61)

# Part Number	SAE Flange Size inch	Maximum Working Pressure (psi)	(2) Flange Halves	O-Ring	(4) Bolts Grade 8		(4) Washers
					Thread inch	Length inch	
5151HK-8	1/2	5,000	51H-8	711510-6	5/16x18	1-1/4	5/16
5151HK-12	3/4	5,000	51H-12	711510-5	3/8x16	1-1/4	3/8
5151HK-16	1	5,000	51H-16	711510-4	3/8x16	1-1/4	3/8
5151HK-20	1-1/4	4,000	51H-20	711510-3	7/16x14	1-1/2	7/16
5151HK-24	1-1/2	3,000	51H-24	711510-2	1/2x13	1-1/2	1/2
5151HK-32	2	3,000	51H-32	711510-1	1/2x13	1-1/2	1/2
5151HK-40	2-1/2	2,500	51H-40	711510-7	1/2x13	1-3/4	1/2
5151HK-48	3	2,000	51H-48	711510-8	5/8-11	1-3/4	5/8

Note: High pressure applications also require the use of Code 61 Flange End hose fittings.

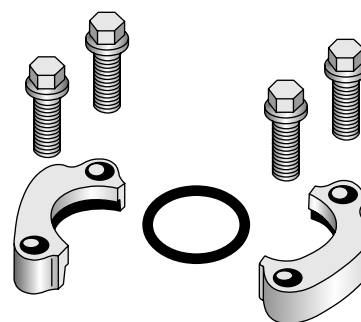

Hose
A

Fittings
B

Equipment
C

Accessories
D

Technical
E

Hose
A
Fittings
B
Equipment
C
Accessories
D
Technical
E

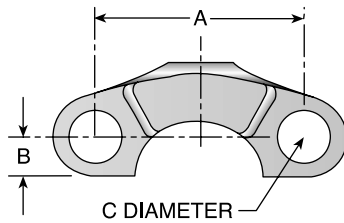

HFH SAE Flange Half (Code 62)

# Part Number	SAE Flange Size inch	A inch	B inch	C inch	Maximum Working Pressure psi
HFH-12	3/4	2.00	0.43	0.41	6,000
HFH-16	1	2.25	0.51	0.47	6,000
HFH-20	1 1/4	2.62	0.59	0.53	6,000
HFH-24	1 1/2	3.12	0.68	0.66	6,000
HFH-32	2	3.81	0.84	0.78	6,000

HFHFHK SAE Flange Kit (Code 62)

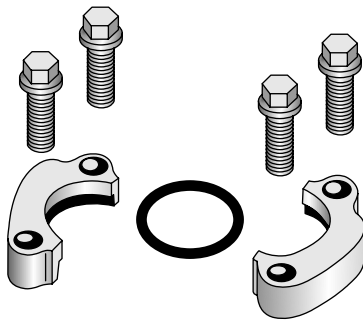

# Part Number	SAE Flange Size inch	Maximum Working Pressure psi	(2) Flange Halves	O-Ring	(4) Bolts Grade 8		(4) Washers
					Thread inch	Length inch	
HFHFHK-12	3/4	6,000	HFH-12	711510-5	3/8x16	1-1/2	3/8
HFHFHK-16	1	6,000	HFH-16	711510-4	7/16x14	1-3/4	7/16
HFHFHK-20	1-1/4	6,000	HFH-20	711510-3	1/2x13	1-3/4	1/2
HFHFHK-24	1-1/2	6,000	HFH-24	711510-2	5/8x11	2-1/4	5/8
HFHFHK-32	2	6,000	HFH-32	711510-1	3/4x10	2-3/4	3/4

8FH Flange Half (8000 psi)

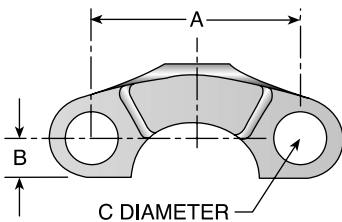

# Part Number	SAE Flange Size inch	A inch	B inch	C inch	Maximum Working Pressure psi
8FH-12	3/4	2.00	0.43	0.41	8,000
8FH-16	1	2.25	0.51	0.47	8,000

8FHFHK Flange Kit (8000 psi)

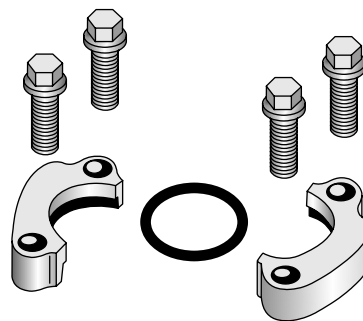

# Part Number	SAE Flange Size inch	Maximum Working Pressure psi	(2) Flange Halves	D-Ring	(4) Bolts Grade 8		(4) Washers
					Thread inch	Length inch	
8FHFHK-12	3/4	8,000	8FH-12	8ARG-12	3/8-16	1-3/4	3/8
8FHFHK-16	1	8,000	8FH-16	8ARG-16	7/16-14	1-3/4	7/16

DIN and ISO Metric Ports

DIN (German) and ISO (International Organization for Standardization) flange heads are the same as SAE flange heads. By comparison, the ports have the same configuration except that the DIN and ISO Type I ports accept metric bolts. This requires special flange halves in most sizes.

SAE J518	DIN 20078	ISO 6162 Type I
Code 61	Form R	3,5 to 35 MPa Series
Code 62	Form S	35 to 40 MPa Series

M1H

DIN (ISO) Flange Half

# Part Number	DIN Flange Size	ISO Flange Size	A mm	B mm	C mm	Maximum Working Pressure	
						psi	MPa
M1H-8	8	13	38	8	9	5,000	34,5
M1H-12	12	19	48	10	11	5,000	34,5
M1H-16	16	25	52	12	11	5,000	34,5
M1H-20	20	32	59	14	11	4,000	27,6
M1H-24	24	38	70	17	13.5	3,000	20,7
M1H-32	32	51	78	21	13.5	3,000	20,7

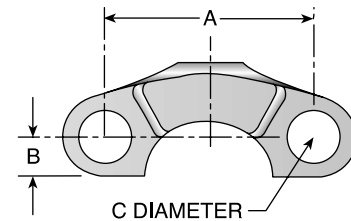

Note: High pressure applications also require the use of Code 62 Flange End hose fittings.

M1M1HK

DIN (ISO) Flange Kit (Code 61)

# Part Number	DIN Flange Size	ISO Flange Size	Maximum Working Pressure		(2) Flange Halves	O-Ring	(4) Bolts		(4) Washers
			psi	MPa			Thread mm	Length mm	
M1M1HK-8	8	13	5,000	34,5	M1H-8	711510-6	M8x1.25	30	10
M1M1HK-12	12	19	5,000	34,5	M1H-12	711510-5	M10x1.50	30	10
M1M1HK-16	16	25	5,000	34,5	M1H-16	711510-4	M10x1.50	30	10
M1M1HK-20	20	32	4,000	27,6	M1H-20	711510-3	M10x1.50	40	10
M1M1HK-24	24	38	3,000	20,7	M1H-24	711510-2	M12x1.75	40	12
M1M1HK-32	32	51	3,000	20,7	M1H-32	711510-1	M12x1.75	40	12
M1M1HK-40	40	64	2,500	17,2	M1H-40	711510-7	M12x1.75	45	12

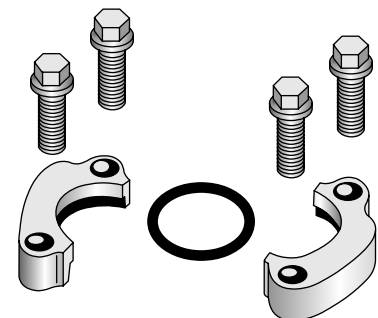

Hose
A

Fittings
B

Equipment
C

Accessories
D

Technical
E

Hose
A
Fittings
B
Equipment
C
Accessories
D
Technical
E

M2H
DIN (ISO) Flange Half (Code 62)

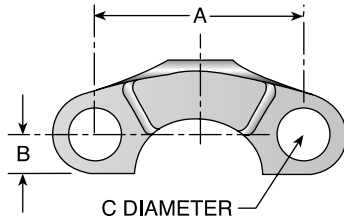

# Part Number	DIN Flange Size	ISO Flange Size	A mm	B mm	C mm	Maximum Working Pressure	
						psi	MPa
M2H-8	8	13	41	8	9	6,000	41,5
M2H-12	12	19	51	11	11	6,000	41,5
M2H-16	16	25	57	13	13,5	6,000	41,5
M2H-20	20	32	67	15	13,5	6,000	41,5
M2H-24	24	38	79	17	17,5	6,000	41,5
M2H-32	32	51	97	21	22	6,000	41,5

M2M2HK
DIN (ISO) Flange Kit (Code 62)

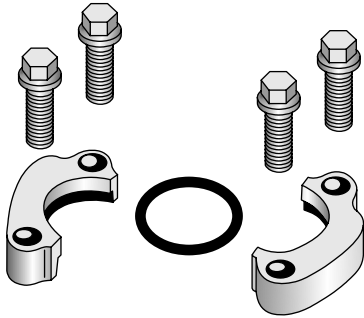

# Part Number	DIN Flange Size	ISO Flange Size	Maximum Working Pressure		(2) Flange Halves	O-Ring	(4) HHCS		(4) Washers
			psi	MPa			Thread mm	Length mm	
M2M2HK-8	8	13	6,000	41,5	M2H-8	711510-6	M8x1.25	30	8
M2M2HK-12	12	19	6,000	41,5	M2H-12	711510-5	M10x1.50	35	10
M2M2HK-16	16	25	6,000	41,5	M2H-16	711510-4	M12x1.75	45	12
M2M2HK-20	20	32	6,000	41,5	M2H-20	711510-3	M12x1.75	45	12
M2M2HK-24	24	38	6,000	41,5	M2H-24	711510-2	M16x2.00	55	16
M2M2HK-32	32	51	6,000	41,5	M2H-32	711510-1	M20x2.50	70	20

711509

O-Rings - SAE Thread (Compound N552-90)*

# Part Number	Tube Dash Size	Tube O.D. inch	SAE Thread inch	W		I.D.	
				inch	mm	inch	mm
711509-1	-4	1/4	7/16x20	0.072	1,83	0.351	8,92
711509-2	-5	5/16	1/2x20	0.072	1,83	0.414	10,52
711509-3	-6	3/8	9/16x20	0.078	1,98	0.468	11,89
711509-4	-8	1/2	3/4x16	0.087	2,21	0.644	16,36
711509-5	-10	5/8	7/8x14	0.097	2,46	0.755	19,18
711509-6	-12	3/4	1-1/16x12	0.116	2,95	0.924	23,61
711509-7	-16	1	1-5/16x12	0.116	2,95	1.171	29,74
711509-8	-20	1-1/4	1-5/8x12	0.118	3,00	1.475	37,47
711509-9	-24	1-1/2	1-7/8x12	0.118	3,00	1.720	43,69
711509-10	-32	2	2-1/2x12	0.118	3,00	2.337	59,36

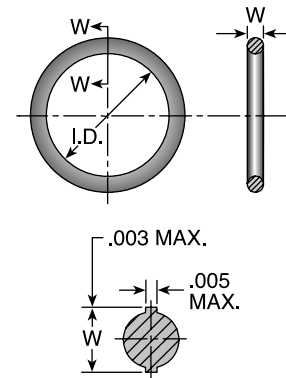

711510

O-Rings - Code 61 and Code 62 Flanges (Compound N552-90)*

# Part Number	Flange Dash Size	Flange Size inch	W		I.D.	
			inch	mm	inch	mm
711510-6	-8	1/2	0.14	3,53	0.73	18,64
711510-9*	-10	5/8	0.14	3,53	0.79	20,20
711510-5	-12	3/4	0.14	3,53	0.98	25,00
711510-4	-16	1	0.14	3,53	1.29	32,92
711510-3	-20	1-1/4	0.14	3,53	1.48	37,69
711510-2	-24	1-1/2	0.14	3,53	1.85	47,22
711510-1	-32	2	0.14	3,53	2.23	56,74
711510-7	-40	2-1/2	0.14	3,53	2.73	69,44
711510-8	-48	3	0.14	3,53	3.35	85,32

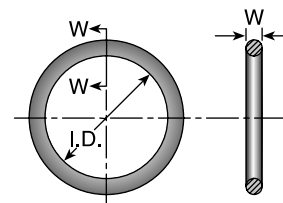

*Note: For use with petroleum base fluids, other compounds available for Phosphate Ester fluids. Please contact The Parker Hannifin Seal Group/O-Ring Division (1-800-C-PARKER) for additional information.

C9RG

O-Rings for CA, CE, CF Metric

# Part Number	W mm	I.D. mm
C9RG-8	1,5	6,0
C9RG-10	1,5	7,5
C9RG-12	1,5	9,0
CARG-15	2,0	12,0
CARG-18	2,0	15,0
CARG-22	2,0	20,0
CARG-28	2,0	26,0

C9RG

O-Rings for C9, OC, 1C Metric Swivels

# Part Number	W mm	I.D. mm
C9RG-8	1,5	6,0
C9RG-10	1,5	7,5
C9RG-12	1,5	9,0
C9RG-14	2,0	10,0
C9RG-20	2,4	16,3
C9RG-25	2,4	20,3
C9RG-30	2,4	25,3
C9RG-38	2,5	33,0

D9DT

Bonded Seal for BSPP Port Fittings

# Part Number	I.D.		O.D.	
	Inch	mm	Inch	mm
D9DT-4	0.54	13,7	0.81	20,6
D9DT-6	0.68	17,3	0.94	23,9
D9DT-8	0.85	21,6	1.13	28,7
D9DT-10	0.93	23,6	1.25	31,8
D9DT-12	1.06	27,0	1.38	35,1
D9DT-16	1.33	33,8	1.68	42,7

*Note: D9DT must be ordered from the Tube Fittings Division. Please contact TFD for additional size and product information.

Hose
A
Fittings
B
Equipment
C
Accessories
D
Technical
E

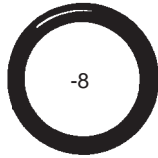

SAE 711509-4



Seal-Lok J0RG-8

Photo shows an actual comparison between an SAE port O-Ring (top) and a Seal-Lok® O-Ring (bottom). They differ in both diameter and cross section.

J0RG O-Rings - Seal-Lok®

Part Number	Tube Dash Size	Tube O.D. Inch	SAE Thread Inch	I.D.		O.D.	
				Inch	mm	Inch	mm
J0RG-4	-4	1/4	9/16x18	0.301	7,65	0.070	1,78
J0RG-6	-6	3/8	11/16x16	0.364	9,25	0.070	1,78
J0RG-8	-8	1/2	13/16x16	0.489	12,42	0.070	1,78
J0RG-10	-10	5/8	1x14	0.614	15,59	0.070	1,78
J0RG-12	-12	3/4	1-3/16x12	0.739	18,77	0.070	1,78
J0RG-16	-16	1	1-7/16x12	0.926	23,52	0.070	1,78
J0RG-20	-20	1-1/4	1-11/16x12	1.176	29,87	0.070	1,78
J0RG-24	-24	1-1/2	2x12	1.489	37,82	0.070	1,78

Note: O-Rings for use in Seal-Lok® connections are illustrated in actual size. Part numbers for O-Rings used in Seal-Lok® and in SAE port connections are also listed in the table. O-Rings are supplied in Nitrile NBR compound, 90 durometer hardness.

XARG Flange "D" Rings Caterpillar® Style Flanges

Part Number	Flange Size	Dash Size	I.D.		O.D.	
			Inch	mm	Inch	mm
XARG-12	3/4	-12	0.20	5,0	1.00	25,4
XARG-16	1	-16	0.20	5,0	1.25	31,8
XARG-20	1-1/4	-20	0.20	5,0	1.50	38,1
XARG-24	1-1/2	-24	0.20	5,0	1.75	44,5
XARG-32	2	-32	0.20	5,0	2.52	63,9

8ARG Flange "D" Rings for 76 Series Style Flange

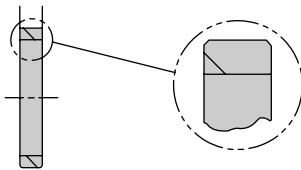

Part Number	Flange Size	Dash Size	Seal Thickness		Seal I.D.	
			Inch	mm	Inch	mm
8ARG-12	3/4	-12	0.20	5,0	1.00	25,4
8ARG-16	1	-16	0.20	5,0	1.25	31,9

59RG

O-Rings for Tube O-Ring Fittings and Compressor Fittings

Part Number	Tube O.D. Inch	Tube Dash Size	Parker Seal Number
59RG-6	3/8	-6	2-011
59RG-8	1/2	-8	2-013
59RG-10	5/8	-10	2-015
59RG-12	3/4	-12	2-017

Note: The above O-Rings (RG) have HNBR compound number N1195-70 (green).

T1RG

O-Rings for Compression Fittings (1T126)

Part Number	Tube O.D. Inch	Tube Dash Size	Parker Seal Number
T1RG-6	3/8	-6	2-012
T1RG-8	1/2	-8	2-014
T1RG-10	5/8	-10	2-016
T1RG-12	3/4	-12	2-018

Charge Ports Caps R134a

Part Number	Fitting Size	Fitting Shape	Port Type	
			Flow	Side
940199	-6 & -8	Straight	High	High
940200	-10 & -12	Straight	High	Low
940188	-6 & -8	Elbows	Standard	High
940189	-10 & -12	Elbows	Standard	Low

R12

Part Number	Thread
940249	7/16x20

CORG

Captive O-Ring Assembly Tools

Parker's new CORG Assembly Tools are designed to facilitate the installation of the O-Ring into the half-dovetail groove of the O-Ring face seal fitting.

Fitting Size	Hand Type Part Number	Bench Type Part Number
-4	CORG-4	CORG-AT04 Bench
-6	CORG-6	CORG-AT06 Bench
-8	CORG-8	CORG-AT08 Bench
-10	CORG-10	CORG-AT10 Bench
-12	CORG-12	CORG-AT12 Bench
-16	CORG-16	CORG-AT16 Bench
-20	CORG-20	CORG-AT20 Bench
-24	CORG-24	CORG-AT24 Bench
-32	CORG-32	



Bench Type



Hand Type

Note: CORG Assembly Tools must be ordered from the Tube Fittings Division (614) 279-7070.

Note: O-Rings listed are for use with petroleum base fluids. Other compounds are available for Phosphate Ester fluids by special order. For Viton® or other O-Ring compounds, consult Parker Hannifin, Seal/O-Rings Products Division (1-800-C-PARKER.)

Hose
A

Fittings
B

Equipment
C

Accessories
D

Technical
E

Accessory Selection Guide – Partek Sleeve (AS-B, AS-Y or PS)

Parker's Partek Nylon Protective Sleeveing gives you tough hose abrasion protection two ways. First, per the ISO 6945 specification, Partek has a unique tubular weave nylon construction, Partek "AS" is strong enough to withstand greater than 200,000 abrasion cycles without wearing through the fabric at any location. Partek "PS" can withstand greater than 50,000 abrasion cycles. In addition, this weave also gives an exceptionally smooth interior wall, allowing rubber hose to move freely inside the sleeve. This provides easy installation and prevents any internal abrasion problems. Partek sleeveing is available in either black or yellow and in sizes to fit most hydraulic hose. Partek, the quick and easy solution to hose protection in high-abrasion areas.

Temperature Range: -67°F to +248°F (-53°C to +120°C)

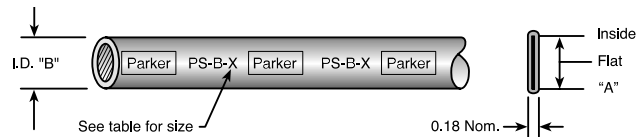

Note: The inside flat "A" dimension corresponds with the inside diameter "B" dimension. For example, AS-Y-13 flat surface "A" is 1.34 in. This offers a .86 in. inside diameter "B". Hose with a smaller O.D. can be specified for this size sleeve. Parker 201-5 hose has a .58 in. O.D. and can easily be inserted in the Partek AS-Y-13 Sleeve.

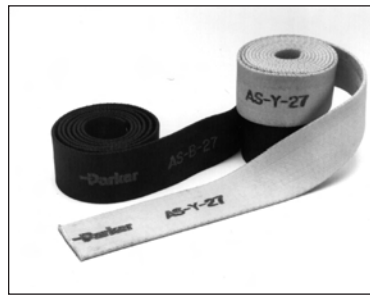

Partek Sleeve



Partek "PS" Sleeve

Partek Sleeve (Black) Part Number	Partek Sleeve (Yellow) Part Number	Partek PS Sleeve (Black) Part Number	Inside Dia.		SS23CG SS25UL 201 221FR 206, 225		213 244 266	285 293	302 301LT 304 341 421WC BXX	422, AX, 424 426, 431, 436 351TC/ST 451TC/ST 471TC/ST 472TC 482TC/ST	601	701 721, 721TC 772TC/ST 774 782TC/ST 792TC/ST	731 P35, 781 782TC/ST 791TC 792TC/ST	801 804 821 821FR 831, 836	811 881 881HT
			A inch	B inch	244	293									
AS-B-11	AS-Y-11		1.07	0.69	-4	-4				-3/-4				-4	
AS-B-13	AS-Y-13	PS-B-13	1.34	0.86	-5/-6	-5/-6			-4/-5	-5/-6	-4/-5			-5/-6	
AS-B-15	AS-Y-15	PS-B-15	1.66	1.06	-8	-8/-10			-6	-8	-6	-6		-8	
AS-B-17	AS-Y-17	PS-B-17	1.92	1.22	-10	-12			-8/-10	-10	-8	-8		-10	
AS-B-19	AS-Y-19		2.12	1.35	-12				-12	-12	-10	-10	-8	-12	
		PS-B-22	2.24	1.42	-12				-12	-12		-10		-12	
AS-B-22	AS-Y-22	PS-B-22	2.24	1.42	-16	-16					-12	-12	-10		-12
AS-B-27	AS-Y-27		2.55	1.63						-16			-12	-16	
		PS-B-33	2.85	1.81						-16			-12	-16	
AS-B-33	AS-Y-33	PS-B-33	2.85	1.81	-20	-20		-16			-16	-16	-16		-16
	AS-Y-35	PS-B-35	3.43	2.19	-24	-24				-20					-20
AS-B-37	AS-Y-37	PS-B-37	3.73	2.38				-20		-24		-20	-20		-24
		PS-B-39	4.12	2.63	-32	-32		-24				-24	-24		-24
		PS-B-45	4.12	2.88				-32		-32			-32		-32
		PS-B-47	4.90	3.13	-40	-40						-32			
AS-B-58			5.69	3.63	-48	-48									-48
AS-B-64			6.18	4.00											

Note: 1. The dimensions shown are related to the hose outside diameter and may not fit over the fitting. For over the fitting applications, a larger size sleeve may be required.
2. Cut lengths are available. Contact your local distributor for prices (www.parkerhose.com).

A Hose
 B Fittings
 C Equipment
 D Accessories
 E Technical

Accessory Selection Guide – PolyGuard (HG)

- Shield hose from abrasion and cuts
- Minimize kinking
- Cannot rust or corrode
- Resist water, oil, gasoline, hydraulic fluid, and most solvents
- Ideal for bundling plastic tubing or hose lines
- Easy to install without removing hose lines; no clamps needed

Heavy-duty polyethylene provides protection in rugged operating conditions. Great for bundling high-pressure hose lines.

Cut edges can be smoothed by applying heat.

CAUTION: This material will support combustion.

Color: Black

Temperature Range: 0°F to +200°F (-17°C to +93°C)

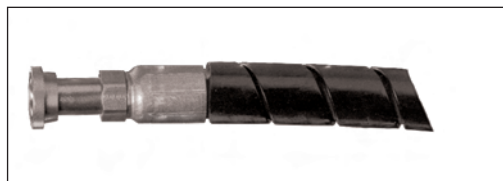

PolyGuard

Part Number	Inside Dia. inch	Box Qty. foot	201, 206		302		422, 421WC		601	701		P35, 781		801		811		
			213, 221FR	225, 244	301LT	304	431, 436, AX	451TC/ST		471TC/ST	472TC	721, 721TC	772TC/ST	782TC/ST	791TC	792TC/ST	821FR	831, 836
HG-075	0.75	100	-8/-10	-6/-8	-8/-10	-6/-8	-4/-6	-8/-10	-6/-8	-4/-6				-8/-10				
HG-100	1.00	100	-12	-10/-12	-12	-10	-8/-10	-12	-10	-8/-10				-12				-12
HG-125	1.25	100	-16		-16	-12	-12	-12	-12	-12	-12	-12	-12	-16				
HG-150	1.50	100	-20/-24	-16/-20	-20	-16/-20	-16	-20	-16/-20	-16	-16	-16	-16/-20					-16/-20
HG-200	2.00	100	-32/-40	-24/-32	-24/-32		-20/-24	-24/-32		-20/-24	-20/-24	-20/-24	-24/-32					-24/-32
HG-200	2.00	100					-32			-32	-32							-40
HG-350	3.50	30	-48															-48

Accessory Selection Guide – ParKoil™ (PG)

Lower-cost protection for applications that call for a tighter bend radius and are less demanding.

Cut edges can be smoothed by applying heat.

CAUTION: This material will support combustion.

Color: Black

Temperature Range: 0°F to +200°F (-17°C to +93°C)



ParKoil™

Part Number	Inside Dia. inch	Box Qty. foot	201, 221FR		302		422, 424, 426		601	701		731		801		811		
			206, 225	244	301LT	304	431, 436, AX	451TC/ST		471TC/ST	472TC	482TC/ST	721	721TC	782TC/ST	791TC	821FR	831, 836
PG-038	0.38	50																
PG-050	0.50	50	-4/-5		-3/-4	-4/-5	-4											
PG-062	0.62	50	-6	-6/-8	-5	-6												
PG-075	0.75	50	-8	-10	-6	-8	-6			-6	-6							
PG-088	0.88	50	-10	-12	-8	-10	-8			-8	-8							
PG-100	1.00	50	-12		-10/-12	-12				-10	-10	-10	-10	-12				
PG-119	1.19	25	-16	-16						-12	-12	-12	-12					-12
PG-138	1.38	25	-20/-24	-20/-24	-16	-16/-20	-16			-16	-16/-20	-16	-16					-16/-20
PG-188	1.88	25	-32/-40	-32/-40	-20/-24	-24				-24	-24	-20/-24	-24					-24
PG-188	1.88	25	-48	-48	-32	-32				-32	-32	-32	-32					-32

Accessory Selection Guide – Spring Guard and Armor Guard

Parker Spring Guard and Armor Guard are two products that prolong the life of hose lines that are exposed to rugged operating conditions. They distribute bending radii to avoid kinking in hose lines and protect hose from abrasion and deep cuts. Guards are constructed of steel wire and plated to resist rust.



Spring Guard (SG)



Armor Guard (AG)

Spring Guard Part Number	Armor Guard Part Number	Inside Dia. inch	201 221FR 206, 225, 244, 266	213 285 293	302 301LT 304 341 421WC BXX	351TC/ST 422 424,431,436 451TC/ST 471TC/ST 482TC/ST 472TC, AX	601	701 721 721TC 772TC/ST 774	731 P35 781 782TC/ST 791TC 792TC/ST	801 804 821 821FR 831, 836	811 881 811HT
SG-050	AG-050	0.50		-4	-4	-3					
SG-060	AG-060	0.60	-4	-5	-3	-4	-3/-4			-4/-5	
SG-066	AG-066	0.66	-5	-6	-4	-5					
SG-072	AG-072	0.72	-6	-6	-5	-6	-5			-6	
SG-084	AG-084	0.84	-8	-8	-6	-8	-6	-4/-6	-4	-8	
SG-097	AG-097	0.97	-10	-10	-8	-10	-8	-8	-6	-10	
SG-106	AG-106	1.06		-12	-10				-8		
SG-113	AG-113	1.13	-12			-12	-10	-10		-12	
SG-122	AG-122	1.22			-12				-10		
SG-131	AG-131	1.31	-16	-16			-12	-12	-12	-16	-12
SG-155	AG-155	1.55	-20	-20	-16	-16	-16	-16			-16
SG-161									-16		
SG-166		1.66							-16		
SG-182	AG-182	1.82	-24	-24		-20	-20				-20
SG-209	AG-209	2.09			-20	-24		-20	-20		
SG-232	AG-232	2.32	-32		-24				-24		
SG-292											-40

Note: Spring Guard and Armor Guard are packaged in 10 ft. pieces.

Hose
A
Fittings
B
Equipment
C
Accessories
D
Technical
E

Accessory Selection Guide – Firesleeve (FS-F)

Parker Firesleeve is a flame resistant sheath that protects the hose from extreme temperature conditions. Firesleeve easily slides over hoses and readily expands over fitting. It can be assembled with Parker FSC or properly sized wormgear clamp.

Construction: Braided fiberglass sleeve and an orange, bonded and seamless silicone rubber cover.

Specifications: Conforms to SAE Aerospace Standard 1072A Type 2A.

Temperature Range: -54°C to +260°C (-65°F to +500°F).

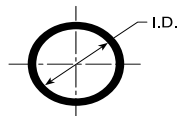

Note: The Firesleeve inside dimension (I.D.) must exceed the outside diameter (O.D.) of the hose and offer an allowance for easy hose insertion. For example, 201-16 has a 1.23 in. O.D. FS-S-24, with an I.D. of 1.46 in., is the suggested Firesleeve.

Note: Parker FSC Clamp fits all hoses up to 2 in. O.D.

Note: Parker HC Clamps (wormgear) are listed on page D-24.



Firesleeve (FS-F)



FSC Clamp

Part Number: FSC
(One size fits all hoses up to 2 inch O.D.)

Part Number	Inside Dia. inch	201, 221FR		302		422, 424, 426 431, 436, AX		701		801	
		206, 225 244 266	213 285 293	301LT 304, 341 BXX	351TC/ST, 472TC 451TC/ST 471TC/ST 482TC/ST	421WC	601	721 721TC 772TC/ST 774	731 P35, 781 782TC/ST 791TC 792TC/ST	804 821 821FR 831 836	811 881 811HT
FS-F-10	0.58	-4	-4	-3	-3/-4						-4
FS-F-11	0.65	-5	-5	-4	-5	-4	-4				
FS-F-12	0.71		-6	-5							-6
FS-F-14	0.84	-6/-8	-8	-6	-6	-6	-5/-6				-8
FS-F-16	0.96		-10		-8	-8		-6			
FS-F-18	1.08	-10	-12	-8/-10	-10	-8	-8				-10
FS-F-20	1.21	-12		-12	-12	-12	-10	-10	-8		-12
FS-F-24	1.46				-16						
FS-F-30	1.84	-24	-24								
FS-F-38	2.34	-32	-32	-20/-24	-24			-20/-24	-20		-24
FS-F-40	2.46								-24		

Note: See Page D-22 for Firesleeve assembly instructions.

Hose
A

Fittings
B

Equipment
C

Accessories
D

Technical
E

Accessory Selection Guide – Firesleeve (cont.)

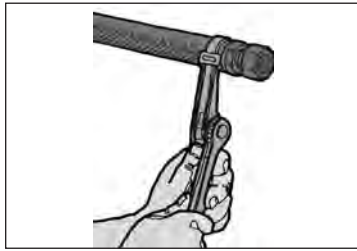

FSC Clamp

Used to attach firesleeve around socket on hose sizes with a 2" maximum O.D.

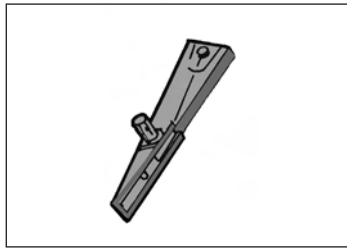

FST Clamp Tool

Part Number: FST-711617 Used to secure FSC clamp.



FSS Firesleeve Sealant

Keeps end of firesleeve from fraying - for neater, longer lasting installation.

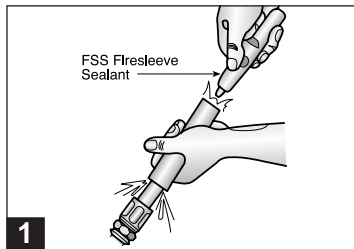

1

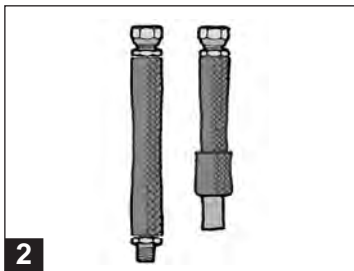

2



3



4

Firesleeve Assembly Instructions

1. Assemble one end fitting on hose. Cut firesleeve to same length as hose. Cover approximately 1" of each end of firesleeve with FSS sealant and allow to dry.
2. Push firesleeve back from cut end of hose and assemble the second end fitting. Then pull firesleeve completely over both sockets.
3. Insert tail of FSC clamp into FST clamping tool.
4. Position clamp around middle of socket and tighten with tool. Bend end of band back over buckle. Repeat on other end. Repair any scuffs or abrasions in firesleeve with FSS sealant.

Hose
A

Fittings
B

Equipment
C

Accessories
D

Technical
E

Accessory Selection Guide – CL Clamp

Vinyl coated steel clamps provide hose support where long lengths are used. Provides neater installation of hose lines, minimizes hose chafing and prevents damage to hose.

Material: CR Steel with Zinc Plating

Coating: Black Vinyl Plastisol - 0,8 mm (0.03 inch) thick.

Temperature Range: -40°C to +107°C (-40°F to +225°F).

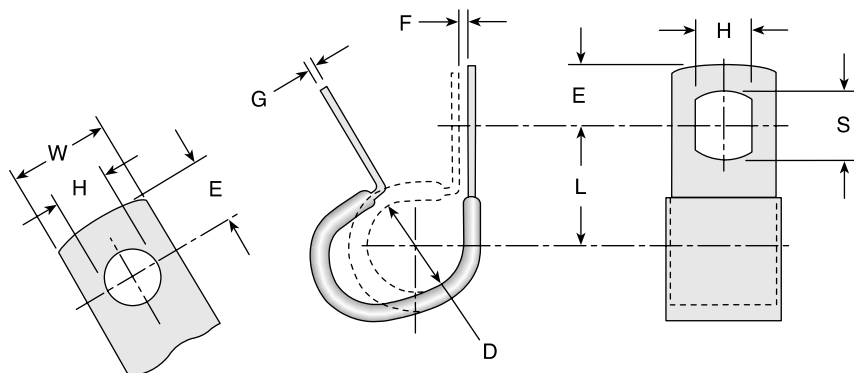

Part Number	D		H		L		W		E		F		G		S	
	±0,8 (mm)	±0.031 (inch)	±0,1 (mm)	±0.005 (inch)	±0,8 (mm)	±0.031 (inch)	±0,25 (mm)	±0.01 (inch)	±0,4 (mm)	±0.015 (inch)	±0,8 (mm)	±0.031 (inch)	±0,1 (mm)	±0.004 (inch)	±0,5 (mm)	±0.020 (inch)
CL-6	7,90	0.312	10,30	0.406	17,45	0.687	19,05	0.750	11,10	0.437	0,80	0.031	0,80	0.032	12,70	0.500
CL-7	9,50	0.375	10,30	0.406	18,25	0.718	19,05	0.750	11,10	0.437	1,55	0.062	0,80	0.032	12,70	0.500
CL-8+	11,10	0.437	10,30	0.406	19,05	0.750	19,05	0.750	11,10	0.437	1,55	0.062	1,20	0.048	12,70	0.500
CL-9	12,70	0.500	10,30	0.406	19,85	0.781	19,05	0.750	11,10	0.437	1,55	0.062	1,20	0.048	12,70	0.500
CL-10+	14,25	0.562	10,30	0.406	20,60	0.812	19,05	0.750	11,10	0.437	1,55	0.062	1,20	0.048	12,70	0.500
CL-11	15,90	0.625	10,30	0.406	21,40	0.843	19,05	0.750	11,10	0.437	1,55	0.062	1,20	0.048	12,70	0.500
CL-12	17,45	0.687	10,30	0.406	22,20	0.875	19,05	0.750	11,10	0.437	1,55	0.062	1,20	0.048	12,70	0.500
CL-13	19,05	0.750	10,30	0.406	23,00	0.906	19,05	0.750	11,10	0.437	1,55	0.062	1,20	0.048	12,70	0.500
CL-14	20,60	0.812	10,30	0.406	23,80	0.937	19,05	0.750	11,10	0.437	1,55	0.062	1,20	0.048	12,70	0.500
CL-15+	22,20	0.875	10,30	0.406	24,60	0.968	19,05	0.750	11,10	0.437	1,55	0.062	1,20	0.048	12,70	0.500
CL-16	23,80	0.937	10,30	0.406	25,40	1.000	19,05	0.750	11,10	0.437	1,55	0.062	1,20	0.048	12,70	0.500
CL-17	25,40	1.000	10,30	0.406	26,20	1.031	19,05	0.750	11,10	0.437	1,55	0.062	1,20	0.048	12,70	0.500
CL-18+	26,95	1.062	10,30	0.406	26,95	1.062	19,05	0.750	11,10	0.437	1,55	0.062	1,20	0.048	12,70	0.500
CL-19	28,60	1.125	10,30	0.406	27,75	1.093	19,05	0.750	11,10	0.437	1,55	0.062	1,20	0.048	12,70	0.500
CL-20+	30,20	1.188	13,50	0.531	31,75	1.250	25,40	1.000	14,25	0.562	1,55	0.062	1,20	0.048	15,90	0.625
CL-21	31,75	1.250	13,50	0.531	32,55	1.281	25,40	1.000	14,25	0.562	1,55	0.062	1,20	0.048	15,90	0.625
CL-22+	33,30	1.312	13,50	0.531	33,30	1.312	25,40	1.000	14,25	0.562	1,55	0.062	1,20	0.048	15,90	0.625
CL-23	34,90	1.375	13,50	0.531	34,10	1.343	25,40	1.000	14,25	0.562	1,55	0.062	1,20	0.048	15,90	0.625
CL-24+	36,50	1.437	13,50	0.531	34,90	1.375	25,40	1.000	14,25	0.562	1,55	0.062	1,20	0.048	15,90	0.625
CL-25	38,10	1.500	13,50	0.531	35,70	1.406	25,40	1.000	14,25	0.562	1,55	0.062	1,20	0.048	15,90	0.625
CL-26+	39,65	1.562	13,50	0.531	36,50	1.437	25,40	1.000	14,25	0.562	1,55	0.062	1,20	0.048	15,90	0.625
CL-27+	41,25	1.625	13,50	0.531	37,30	1.468	25,40	1.000	14,25	0.562	1,55	0.062	1,20	0.048	15,90	0.625
CL-29	44,45	1.750	13,50	0.531	38,90	1.531	25,40	1.000	14,25	0.562	1,55	0.062	1,20	0.048	15,90	0.625
CL-31+	47,65	1.875	13,50	0.531	40,45	1.593	25,40	1.000	14,25	0.562	1,55	0.062	1,20	0.048	15,90	0.625
CL-33	50,80	2.000	13,50	0.531	42,85	1.687	25,40	1.000	14,25	0.562	1,55	0.062	1,20	0.048	15,90	0.625
CL-36+	55,55	2.187	13,50	0.531	46,00	1.812	25,40	1.000	14,25	0.562	1,55	0.062	1,20	0.048	15,90	0.625
CL-37	57,15	2.250	13,50	0.531	46,00	1.812	25,40	1.000	14,25	0.562	1,55	0.062	1,20	0.048	15,90	0.625
CL-38+	58,70	2.312	13,50	0.531	49,20	1.937	25,40	1.000	14,25	0.562	1,55	0.062	1,20	0.048	15,90	0.625
CL-41+	63,50	2.500	13,50	0.531	50,80	2.000	25,40	1.000	14,25	0.562	1,55	0.062	1,20	0.048	15,90	0.625
CL-43	66,65	2.625	13,50	0.531	58,70	2.312	25,40	1.000	14,25	0.562	1,55	0.062	1,20	0.048	15,90	0.625

Accessory Selection Guide – HC, 88HC-H and 88DB Clamp

The Parker HC Clamp is a stainless steel worm gear clamp designed for low pressure industrial hose applications.

Material: Stainless steel

Specifications: SAE J1508, Type F and Type HD

HC Hose Clamp Table

Part Number	Size (SAE)	"A" Clamp Diameter			
		Minimum		Maximum	
		mm	inch	mm	inch
HC-6	-8	12	0.48	25	1.00
HC-8	-10	13	0.50	28	1.12
HC-10	-12	13	0.50	32	1.25
88HC-12	-16	19	0.75	38	1.50
88HC-16	-20	19	0.75	44	1.75
88HC-20	-24	25	1.00	51	2.00
88HC-24	-28	33	1.31	57	2.25

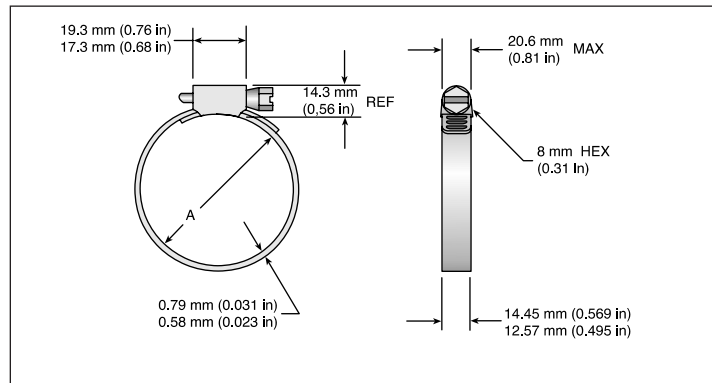

88HC-H Series Hose Clamp (High Torque Wormgear)

# Part Number	Hose I.D. inch
88HC-16H	3/4
88HC-16H	1
88HC-20H	1-1/4
88HC-32H	1-1/2
88HC-32H	2
88HC-40H	2-1/2
88HC-48H	3



88DB Series Heavy Duty Hose Clamp (Double Bolt Hose Clamp)

# Part Number	Hose I.D. inch
88DB-12	3/4
88DB-16	1
88DB-20	1-1/4
88DB-24	1-1/2
88DB-32	2

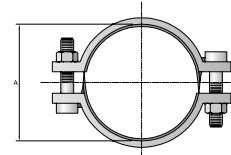

Note: See 88 Series Assembly Instructions for proper 88HC-H clamp attachment.

Hose
A

Fittings
B

Equipment
C

Accessories
D

Technical
E

Accessory Selection Guide – Protection Shields (HP, HT, and HP-B)

Prevent hose abrasion while extending your hose life. Parker Hose Protection Shields extend hose life by protecting the hose from abrasion that occurs when hose rubs against other hose, metal or concrete. Parker hose shields are resistant to oil, lubricants, gasoline, most solvents and can withstand ambient temperatures from -40° to +300° F. Easily installed and secured by cable ties without disconnecting any hose lines. Use with hose from 1/4" to 2" I.D.

- ◆ Eliminate hose abrasion on concrete, metal or any rough surface.
- ◆ Guard against hose deterioration on mobile hydraulic equipment.
- ◆ Let Parker fill all your hydraulic and pneumatic hose product needs.

Hose Protector Shields are a fast and extremely cost effective way to isolate fluid lines from direct contact with other lines, components or structural members. They're available in 4-inch, 6-inch and 8-inch lengths and the width can be trimmed to satisfy a variety of situations.

These flexible protectors simply clamp around the hose and are securely held in place by nylon cable ties which are included. The cable ties are recessed in molded grooves to protect them from abrasion. **You don't need to disconnect a line to install a Parker Hose Protector Shield the way you do with a continuous tubular sleeve. Just wait until the installation is up and running to see exactly where contact needs to be prevented.**

Parker Hose Protector Shields are available in bulk quantities and in convenient assortments in 4", 6" and 8" sizes. Cable ties are included with all protectors and are also available in bulk.

Hose Shields

HP-B-13X18-KIT

2 ea. HP-13 RFL

2 ea. HP-15 RFL

4 ea. HP-18 RFL

Tie Wraps

HT-12-KIT

HT-16-KIT

HT-22-KIT

30 ea. HT-12 Tie Wraps

30 ea. HT-16 Tie Wraps

15 ea. HT-22 Tie Wraps

20 Hose Protectors and 60 Tie Wraps for each size are in point of purchase display box.

HP-B-13-RFL

10 ea. HP-B-13 Hose Protectors (4").

30 ea. HT-12 Tie Wraps in a sealed plastic bag.

HP-B-15-RFL

10 ea. HP-B-15 Hose Protectors (6").

30 ea. HT-16 Tie Wraps in a sealed plastic bag.

HP-B-18-RFL

5 ea. HP-B-18 Hose Protectors (8").

15 ea. HT-22 Tie Wraps in a sealed plastic bag.

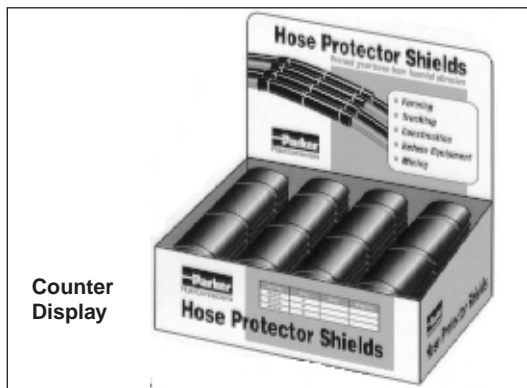
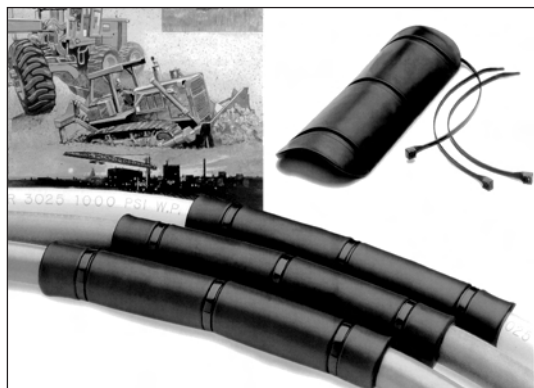

Contact your authorized Parker Hose Products Distributor for pricing and delivery information.

Note: Parker Hose Protector Shield products are intended to prevent damage. They are not suitable as patches or repairs for lines which are already damaged or worn beyond safe use standards.

HPD Hose Assembly Workstations

Hose
A

Fittings
B

Equipment
C

Accessories
D

Technical
E



Hose Products Division has set up an agreement to allow Hose Products customers to purchase directly from our vendor, Safety Step.

Safety Step's contact information is:

Safety Step
Annette Cox
888-448-4237
parker@safetystep.net

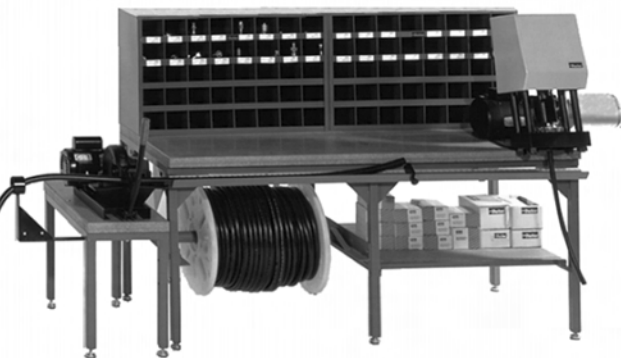

The complete on-site complete hose assembly workstation design (above) includes:

- TH7-5-C—6' table with 1 hose reel and 1 bottom shelf
- TH7-6—16 hose reel system, with rotating base
- TH7-7—15" wide table set up for Parker 239 or 339 Cut-Off Saw
- (2) 40B-Cabinet 40 openings - 4-1/2" x 4-1/2" x 12" in size
- TH7-6-C—Optional overhead crane
- TH7-5-HT—Optional 6' measured hose trough with adjustable hose stop

Specifications: HoseFab Table (heavy duty)

- Laminated wood table top
- 1-1/2" square tubing structure
- Gussetted corner braces
- 6-leg design
- All legs have adjustable feet
- Hose reel/shelf combinations
- 40B-Cabinet or 72B-Cabinet for fitting storage
- *Optional: Hose trough for measurement of hose*
 - Calibrated to line up to Saw Table
 - Adjustable stop for standard length cuts
 - Built-in tape measure

Specifications: Rotary Reel Rack (TH7-6)

- 16 Hose reel capacity
- Compact design
- Rotates for 1 man use
- Center post bolts to floor in 4 places
- Optional: Overhead crane

Specifications: Saw Table (TH7-7)

- Calibrated to line up to Hose trough
- Adjustable feet
- Mounts to 6-foot bench

Specifications: 3 or 4 Reel Rack

- Free standing 3 reel rack (TH7-8)
- Bolts to floor
- Optional: 4th reel capacity with wall mounts (TH7-8-F)



Pictured left is a complete on-site hose assembly workstation, the Parker Kart:

The **Parker Kart, TH7-4**, is a portable all-in-one unit designed to hold a Minikrimp, Karrykrimp, Karrykrimp 2, or Parkrimp 1; a 332T-115V Cut-off Saw; 4 reels of hose; and has a 40 bin cabinet with 3 drawers for tools. The TH7-4 can be customized to fit your specific hose assembly needs. Contact Parker HPD or your Parker Hose distributor for details.

Note: Part number TH7-4 does not include hose, fittings or equipment.

See Safety Step contact information at the top of this page

Note: Part number and specifications of components for both workstations are listed on the following pages.

HoseFab Table

Features

Heavy duty constructed table for mounting Minikrimp, Karrykrimp, Karrykrimp 2, or Parkrimp 1. HoseFab Table is available in 3 versions to meet your requirements. Options include two 40B-Cabinets or 72B-Cabinets for fitting storage.

Part Number	Description
TH7-5-R	6' table with 2 hose reels
TH7-5-S	6' table with 2 bottom shelves
TH7-5-C	6' table with 1 hose reel and 1 bottom shelf
TH7-5-HT	Optional 6' measured hose trough with adjustable hose stop
40B-Cabinet	40 openings - 4-1/2" x 4-1/2" x 12" in size
72B-Cabinet	72 openings - 4-1/2" x 4-1/2" x 12" in size

Table measurements:

Height - 31-3/4"
Width - 29"
Length - 72"

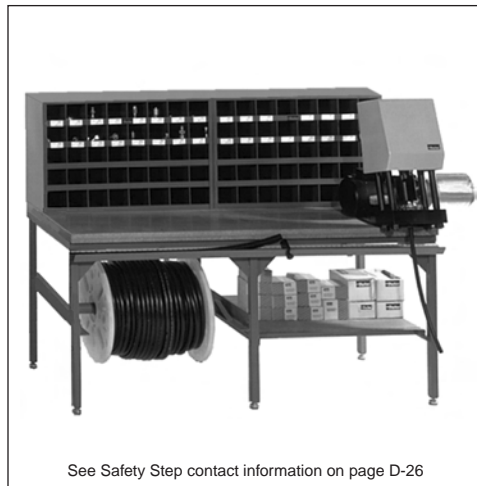

See Safety Step contact information on page D-26

Rotary Reel Rack

Features

16 Hose reel capacity that fits in a compact area. Supplied with heavy duty casters which allow for ease of turning, even when fully loaded. Optional overhead crane available.

Part Number	Description
TH7-6	16 hose reel system, with rotating base
TH7-6-C	Optional overhead crane

Rack measurements:

Height - 104" (120" with optional overhead crane)
Width - 67"
Length - 67"

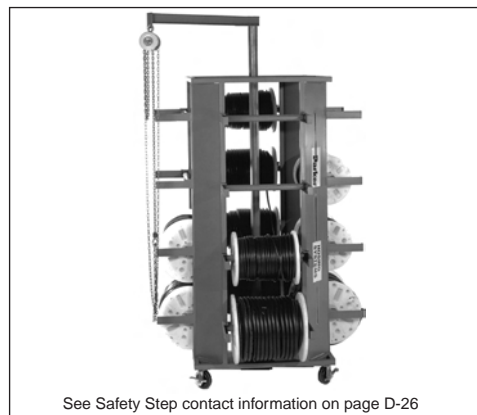

See Safety Step contact information on page D-26

Saw Table

Features

The Saw Table, specially designed for Parker 239 or 339 Hose Cut-Off Saw, attaches directly to the HoseFab Table. The Hose Guide lines up the hose to the saw blade for accurate cutting.

Part Number	Description
TH7-7	15" wide table set up for Parker 239 or 339 Cut-Off Saw

Table measurements:

Height - 18"
Width - 28"
Length - 14"



See Safety Step contact information on page D-26

3/4 Reel Rack

Features

Compact in its design, the standard version will hold 3 reels of hose. Optional 4th reel capacity designed with wall anchor mounts.

Part Number	Description
TH7-8	Upright 3 hose reel rack
TH7-8-F	Optional extension with wall anchor for 4th reel

Rack measurements:

Height - 59" (82-1/2" with 4th reel option)
Width - 27-3/4"
Length - 27-1/2"



See Safety Step contact information on page D-26

Hose
A

Fittings
B

Equipment
C

Accessories
D

Technical
E

Hose
A

Fittings
B

Equipment
C

Accessories
D

Technical
E



See Safety Step contact information on page D-26

Parker Kart Part No. TH7-4

Parker Kart organizes and stores all your necessary Parker hoses, fittings, power and hand tools - everything you need to make fast hose assemblies on site. As a valued addition to any facility, Parker Kart will save on downtime and labor costs, as well as eliminate errors in cutting and fitting attachment. With Parker Kart, you'll always have the materials you need, right when and where you need them.

- Easy one-man movement
- Eight-inch urethane casters with brakes
- Forklift carry tubes
- Electric receptacle with cord
- Fitting bins and drawers
- Large tool drawer
- Four hose reel holders
- Choice of Parker crimping equipment
- Optional accessories available

Parker Kart can be customized to fit specific hose assembly needs. Parker Kart does not include hose, fittings or equipment.

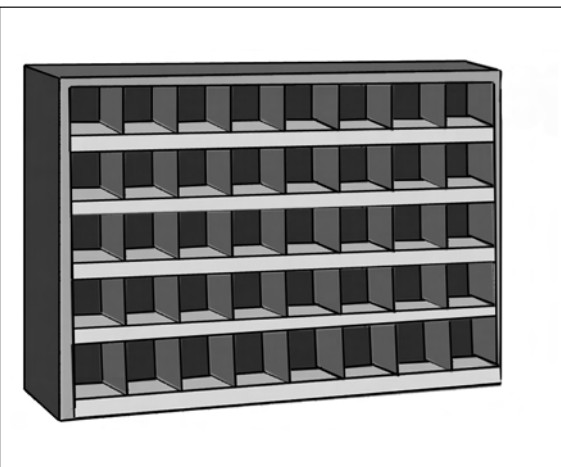

Fitting Stock Bins 72B-Cabinet

36" wide, 43" high, 12" deep, with 72 openings each 4-1/2" x 4-1/2" x 12", heavy duty steel, all welded construction. Product bin labels are available.

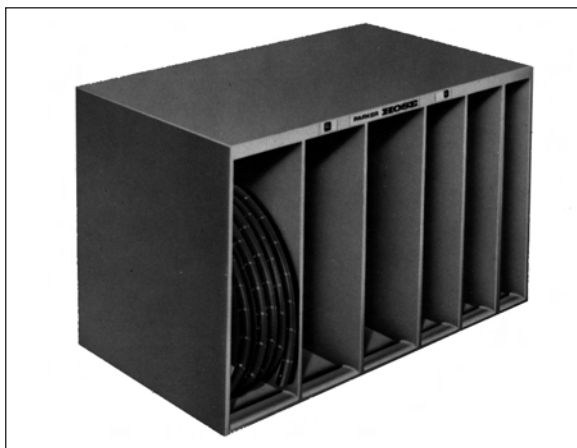

Hose Stock Bins HR6-Hose-Bin

Rugged metal cabinet for stocking coils of Parker hose 36" wide, 28" high, 20" deep, with upright separators to provide 6 compartments varying in width from 4" to 8".

Provides suitable base on which to place the fittings stock bin (top measures 36" x 20", bottom of fittings bin measures 36" x 12".)

Yellow with black "Parker Hose" lettering.