

# Section 1: Cap Screws & Bolts

## Table of Contents

### Cap Screws

Hex Head, *Grade 8 USS & SAE* ..... 3-6  
 Hex Head, *Grade 5 USS & SAE* ..... 8-12

### Nuts & Washers

Grade 8, *for use with Grade 8 Bolts* ..... 7  
 Grade 2, *for use with Grade 5 Bolts* ..... 13  
 Rod Coupling Nuts ..... 23

### Bolts

Hex Head Tap Bolts, *Grade 2 USS* ..... 14  
 Hex Head Lag Bolts ..... 15  
 Eye Bolts ..... 16  
 Acoustical Lag Bolts ..... 16  
 Hanger Bolts ..... 16  
 Elevator Bolts ..... 16  
 Carriage Bolts, *Grade 2 USS* ..... 17-18  
 Shaker Screen Bolts, *Grade 5 USS* ..... 19  
 #3 Head Plow Bolts ..... 20  
 Frame Bolts & Nuts ..... 21

### Studs & Rods

Manifold Studs ..... 22  
 Threaded Rod, *Grade 2 - Zinc Plated* ..... 23  
 Threaded Rod, *B7 - Alloy Steel* ..... 23

### Socket Screws

Socket Head Cap Screws ..... 24-26  
 Flat Socket Head Cap Screws ..... 27  
 Button Socket Head Cap Screws ..... 28  
 Socket Set Screws, *Cup Point* ..... 29-30  
 Socket Set Screws, *Knurl Point* ..... 31  
 Socket Set Screws, *Cone Point* ..... 32  
 Socket Set Screws, *Half Dog Point* ..... 32

### Faskit Assortments ..... 33-34



# HEX HEAD CAP SCREWS

DOMESTIC - GRADE 8 ALLOY STEEL

Plating: Zinc Yellow Chromate

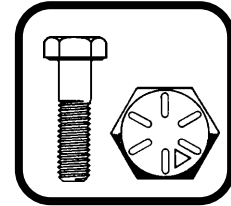

USA / CANADA

Dia	Length	Part #		Qty
		USS	SAE	
<b>1/4</b> -20 USS -28 SAE Thread	1/2	05301	05101	100
	5/8	05302	05102	100
	3/4	05303	05103	100
	7/8	05304	05104	100
	1	05305	05105	100
	1-1/4	05306	05106	100
	1-1/2	05307	05107	100
	1-3/4	05308	05108	100
	2	05309	05109	100
	2-1/4	05310	05110	50
	2-1/2	05311	05111	50
	2-3/4	05312	05112	50
	3	05313	05113	50
	3-1/4	05314	05114	50
	3-1/2	05315	05115	50
	3-3/4	05316	05116	50
	4	05317	05117	50
	4-1/2	05318	05118	25
	5	05319	05119	25
	5-1/2	05320	05120	25
6	05321	05121	25	
<b>5/16</b> -18 USS -24 SAE Thread	1/2	05322	05122	100
	5/8	05323	05123	100
	3/4	05324	05124	100
	7/8	05325	05125	100
	1	05326	05126	100
	1-1/4	05327	05127	100
	1-1/2	05328	05128	100
	1-3/4	05329	05129	100
	2	05330	05130	100
	2-1/4	05331	05131	50
	2-1/2	05332	05132	50
	2-3/4	05333	05133	50

Dia	Length	Part #		Qty
		USS	SAE	
<b>5/16</b> -18 USS -24 SAE Thread	3	05334	05134	50
	3-1/4	05335	05135	50
	3-1/2	05336	05136	50
	3-3/4	05337	05137	50
	4	05338	05138	50
	4-1/2	05339	05139	25
	5	05340	05140	25
	5-1/2	05341	05141	25
	6	05342	05142	25
	<b>3/8</b> -16 USS -24 SAE Thread	1/2	05343	05143
5/8		05344	05144	100
3/4		05345	05145	100
7/8		05346	05146	100
1		05347	05147	100
1-1/4		05348	05148	100
1-1/2		05349	05149	100
1-3/4		05350	05150	100
2		05351	05151	100
2-1/4		05352	05152	50
2-1/2		05353	05153	50
2-3/4		05354	05154	50
3		05355	05155	50
3-1/4		05356	05156	50
3-1/2		05357	05157	50
3-3/4		05358	05158	50
4		05359	05159	50
4-1/2		05360	05160	25
5		05361	05161	25
5-1/2		05362	05162	25
6	05363	05163	25	
7	05363B	05163B	10	
8	05363D	05163D	10	

**Meets or Exceeds:**

Standard Specifications ASTM A354

- » Traceable.
- » Double heat treated.
- » Available in full case & keg quantities.

# HEX HEAD CAP SCREWS

DOMESTIC - GRADE 8 ALLOY STEEL

Plating: Zinc Yellow Chromate

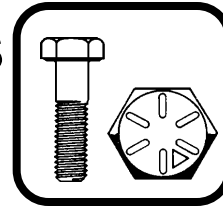

USA / CANADA

Dia	Length	Part #		Qty
		USS	SAE	
<b>7/16</b> -14 USS -20 SAE Thread	3/4	05364	05164	50
	7/8	05365	05165	50
	1	05366	05166	50
	1-1/4	05367	05167	50
	1-1/2	05368	05168	50
	1-3/4	05369	05169	50
	2	05370	05170	50
	2-1/4	05371	05171	25
	2-1/2	05372	05172	25
	2-3/4	05373	05173	25
	3	05374	05174	25
	3-1/4	05375	05175	25
	3-1/2	05376	05176	25
	3-3/4	05377	05177	25
	4	05378	05178	25
	4-1/2	05379	05179	25
	5	05380	05180	25
	5-1/2	05381	05181	25
	6	05382	05182	25
	<b>1/2</b> -13 USS -20 SAE Thread	3/4	05383	05183
7/8		05384	05184	50
1		05385	05185	50
1-1/4		05386	05186	50
1-1/2		05387	05187	50
1-3/4		05388	05188	50
2		05389	05189	50
2-1/4		05390	05190	25
2-1/2		05391	05191	25
2-3/4		05392	05192	25
3		05393	05193	25
3-1/4		05394	05194	25
3-1/2		05395	05195	25
3-3/4		05396	05196	25
4		05397	05197	25
4-1/2		05398	05198	25
5		05399	05199	25
5-1/2		05400	05200	25

Dia	Length	Part #		Qty
		USS	SAE	
<b>1/2</b> -13 USS -20 SAE Thread	6	05401	05201	25
	6-1/2	05401A	05201A	25
	7	07341	06541	10
	7-1/2	07341A	06541A	10
	8	07342	06542	10
	9	07342A	06542A	10
	10	07342B	06542B	10
<b>9/16</b> -12 USS -18 SAE Thread	1	05402	05202	25
	1-1/4	05403	05203	25
	1-1/2	05404	05204	25
	1-3/4	05405	05205	25
	2	05406	05206	25
	2-1/4	05407	05207	25
	2-1/2	05408	05208	25
	2-3/4	05409	05209	25
	3	05410	05210	25
	3-1/4	05411	05211	25
	3-1/2	05412	05212	25
	3-3/4	05413	05213	25
	4	05414	05214	25
	4-1/2	05415	05215	25
	5	05416	05216	25
	5-1/2	05417	05217	25
6	05418	05218	25	

- » Traceable.
- » Double heat treated.
- » Available in full case & keg quantities.

# HEX HEAD CAP SCREWS

DOMESTIC - GRADE 8 ALLOY STEEL

Plating: Zinc Yellow Chromate

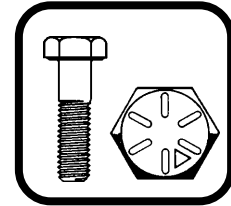

USA / CANADA

Dia	Length	Part #		Qty
		USS	SAE	
<b>5/8</b> -11 USS -18 SAE Thread	1	05419	05219	25
	1-1/4	05420	05220	25
	1-1/2	05421	05221	25
	1-3/4	05422	05222	25
	2	05423	05223	25
	2-1/4	05424	05224	25
	2-1/2	05425	05225	25
	2-3/4	05426	05226	25
	3	05427	05227	25
	3-1/4	05428	05228	25
	3-1/2	05429	05229	25
	3-3/4	05430	05230	25
	4	05431	05231	25
	4-1/2	05432	05232	25
	5	05433	05233	25
	5-1/2	05434	05234	25
	6	05435	05235	25
	6-1/2	05435A	05235A	10
	7	07343	06543	10
	7-1/2	07344	06544	10
8	07345	06545	10	
9	07346	06546	10	
10	07346A	06546A	10	
<b>3/4</b> -10 USS -16 SAE Thread	1	05435X	05235X	25
	1-1/4	05436	05236	25
	1-1/2	05437	05237	25
	1-3/4	05438	05238	25
	2	05439	05239	25
	2-1/4	05440	05240	25
	2-1/2	05441	05241	25
	2-3/4	05442	05242	25
	3	05443	05243	25
	3-1/4	05444	05244	25
	3-1/2	05445	05245	25
	3-3/4	05446	05246	25

Dia	Length	Part #		Qty
		USS	SAE	
<b>3/4</b> -10 USS -16 SAE Thread	4	05447	05247	25
	4-1/2	05448	05248	10
	5	05449	05249	10
	5-1/2	05450	05250	10
	6	05451	05251	10
	6-1/2	07347	06547	10
	7	07348	06548	10
	7-1/2	07349	06549	10
	8	07350	06550	10
	9	07351	06551	10
10	07351A	06551A	10	
<b>7/8</b> - 9 USS -14 SAE Thread	1-1/2	05452	05252	15
	1-3/4	05452A	05252A	15
	2	05453	05253	15
	2-1/4	05453A	05253A	15
	2-1/2	05454	05254	15
	2-3/4	05454A	05254A	15
	3	05455	05255	15
	3-1/4	05455A	05255A	15
	3-1/2	05456	05256	15
	3-3/4	05456A	05256A	15
	4	05457	05257	15
	4-1/2	05458	05258	10
	5	05459	05259	10
	5-1/2	05460	05260	10
	6	05461	05261	10
	6-1/2	07352	06552	10
	7	07353	06553	10
	7-1/2	07354	06554	10
8	07355	06555	10	
9	07356	06556	10	
10	07356A	06556A	10	

# HEX HEAD CAP SCREWS

DOMESTIC - GRADE 8 ALLOY STEEL

Plating: Zinc Yellow Chromate

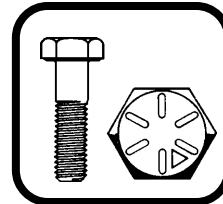

USA / CANADA

Dia	Length	Part #		Qty
		USS	SAE	
<b>1"</b> - 8 USS -14 SAE Thread	1-1/2	05461X	05261X	10
	1-3/4	05461Y	05261Y	10
	2	05462	05262	10
	2-1/4	05462A	05262A	10
	2-1/2	05463	05263	10
	2-3/4	05463A	05263A	10
	3	05464	05264	10
	3-1/4	05464A	05264A	10
	3-1/2	05465	05265	10
	3-3/4	05465A	05265A	10
	4	05466	05266	10
	4-1/2	05467	05267	10
	5	05468	05268	10
	5-1/2	05469	05269	10
	6	05470	05270	10
	6-1/2	07357	06557	10
	7	07358	06558	10
	7-1/2	07359	06559	10
	8	07360	06560	5
	8-1/2	07361	06561	5
9	07362	06562	1	
10	07363	06563	1	
<b>1-1/8</b> - 7 USS -12 SAE Thread	2-1/2	07363X	06563X	1
	3	07364	06564	1
	3-1/2	07365	06565	1
	4	07366	06566	1
	4-1/2	07366A	06566A	1
	5	07367	06567	1
	5-1/2	07367A	06567A	1
	6	07368	06568	1
	6-1/2	07368A	06568A	1
	7	07369	06569	1
7-1/2	07369A	06569A	1	
8	07370	06570	1	

Dia	Length	Part #		Qty
		USS	SAE	
<b>1-1/4</b> - 7 USS -12 SAE Thread	2-1/2	07370X	06570X	1
	3	07371	06571	1
	3-1/2	07371A	06571A	1
	4	07372	06572	1
	4-1/2	07373	06573	1
	5	07374	06574	1
	5-1/2	07374A	06574A	1
	6	07375	06575	1
	6-1/2	07375A	06575A	1
	7	07376	06576	1
<b>1-1/2</b> - 6 USS -12 SAE Thread	7-1/2	07376A	06576A	1
	8	07377	06577	1
	9	07378	06578	1
	10	07379	06579	1
	4	07804	—	1
	5	07806	—	1
	6	07808	—	1
	7	07810	—	1
	8	07812	—	1
	9	07813	—	1
	10	07814	—	1
	12	07816	—	1

- » Traceable.
- » Double heat treated.
- » Available in full case & keg quantities.

# FINISHED HEX NUTS

## GRADE 8 ALLOY STEEL

For Use With Grade 8 Cap Screws  
Plating: Zinc Yellow Chromate



- » Engineered specifically to match high torque requirements of alloy high tensile strength cap screws.
- » Manufactured on automatic nut forgers.
- » Cold formed for more dense grain structure.
- » Special high carbon steel.
- » Double heat treated.

Size	Part #		Qty
	USS	SAE	
1/4	07684	07672	100
5/16	07685	07673	100
3/8	07686	07674	100
7/16	07687	07675	100
1/2	07688	07676	100
9/16	07689	07677	50
5/8	07690	07678	50
3/4	07691	07679	50
7/8	07692	07680	50
1	07693	07681	25
1-1/8	07694	07682	25
1-1/4	07695	07683	25
1-3/8	07695A	07683A	10
1-1/2	07695B	07683B	10

\*\*\* SEE SECTION 2 FOR COMPLETE LISTING OF NUTS \*\*\*

# ALLOY STEEL FLAT & LOCK WASHERS

## FOR USE WITH GRADE 8 CAP SCREWS & NUTS

Plating: Zinc Yellow Chromate

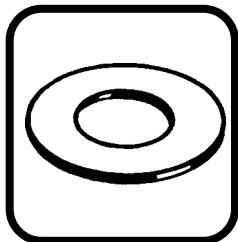

### Flat Washers

Size	Part #		Qty
	USS	SAE	
1/4	35468	39671	100
5/16	35469	39672	100
3/8	35470	39673	100
7/16	35471	39674	100
1/2	35472	39675	100
9/16	35473	39676	50
5/8	35474	39677	50
3/4	35475	39678	50
7/8	35476	39679	25
1	35477	39680	25
1-1/8	35478	39681	25
1-1/4	35479	39681A	25
1-1/2	35480	39681B	25

### Lock Washers

Size	Part #	Qty
1/4	00250	100
5/16	00251	100
3/8	00252	100
7/16	00253	100
1/2	00254	100
9/16	00255	50
5/8	00256	50
3/4	00257	50
7/8	00258	25
1	00259	25
1-1/8	00260	25
1-1/4	00261	25
1-1/2	00262	25

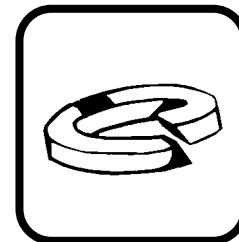

\*\*\* SEE SECTION 2 FOR COMPLETE LISTING OF WASHERS \*\*\*

# HEX HEAD CAP SCREWS

DOMESTIC - GRADE 5

Plating: Zinc

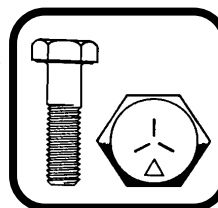

USA / CANADA

Dia	Length	Part #		Qty
		USS	SAE	
<b>1/4</b> -20 USS -28 SAE Thread	1/2	37001	35901	100
	5/8	37002	35902	100
	3/4	37003	35903	100
	7/8	37004	35904	100
	1	37005	35905	100
	1-1/4	37006	35906	100
	1-1/2	37007	35907	100
	1-3/4	37008	35908	100
	2	37009	35909	100
	2-1/4	37010	35910	50
	2-1/2	37011	35911	50
	2-3/4	37012	35912	50
	3	37013	35913	50
	3-1/4	37014	35914	50
	3-1/2	37015	35915	50
	3-3/4	37015A	35915A	50
	4	37015B	35915B	50
	4-1/2	37015C	35915C	25
	5	37015D	35915D	25
	5-1/2	37015E	35915E	25
	6	37015F	35915F	25
	7	37015H	35915H	25
	8	37015J	35915J	25
	<b>5/16</b> -18 USS -24 SAE Thread	1/2	37016	35916
5/8		37017	35917	100
3/4		37018	35918	100
7/8		37019	35919	100
1		37020	35920	100
1-1/4		37021	35921	100
1-1/2		37022	35922	100
1-3/4		37023	35923	100
2		37024	35924	100
2-1/4		37025	35925	50
2-1/2		37026	35926	50
2-3/4		37027	35927	50

- » Traceable.
- » Double heat treated.
- » Available in full case & keg quantities.
- » High tensile strength

Dia	Length	Part #		Qty
		USS	SAE	
<b>5/16</b> -18 USS -24 SAE Thread	3	37028	35928	50
	3-1/4	37029	35929	50
	3-1/2	37030	35930	50
	3-3/4	37030A	35930A	50
	4	37031	35931	50
	4-1/2	37032	35932	25
	5	37033	35933	25
	5-1/2	37033A	35933A	25
	6	37033B	35933B	25
	<b>3/8</b> -16 USS -24 SAE Thread	1/2	37034	35934
5/8		37035	35935	100
3/4		37036	35936	100
7/8		37037	35937	100
1		37038	35938	100
1-1/4		37039	35939	100
1-1/2		37040	35940	100
1-3/4		37041	35941	100
2		37042	35942	100
2-1/4		37043	35943	50
2-1/2		37044	35944	50
2-3/4		37045	35945	50
3		37046	35946	50
3-1/4		37047	35947	50
3-1/2		37048	35948	50
3-3/4		37049	35949	50
4		37050	35950	50
4-1/2		37051	35951	25
5		37052	35952	25
5-1/2		37053	35953	25
6	37054	35954	25	
6-1/2	37054A	35954A	10	
7	37054B	35954B	10	
7-1/2	37054X	—	10	
8	37054C	35954C	10	
9	37054D	35954D	10	
10	37054E	35954E	10	

- » Finished washer face.
- » Class 2A before plating.



# HEX HEAD CAP SCREWS

DOMESTIC - GRADE 5

Plating: Zinc

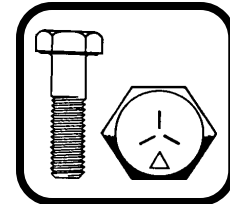

USA / CANADA

Dia	Length	Part #		Qty
		USS	SAE	
<b>7/16</b> -14 USS -20 SAE Thread	3/4	37055	35955	50
	7/8	37056	35956	50
	1	37057	35957	50
	1-1/4	37058	35958	50
	1-1/2	37059	35959	50
	1-3/4	37060	35960	50
	2	37061	35961	50
	2-1/4	37062	35962	25
	2-1/2	37063	35963	25
	2-3/4	37064	35964	25
	3	37065	35965	25
	3-1/4	37066	35966	25
	3-1/2	37067	35967	25
	3-3/4	37068	35968	25
	4	37069	35969	25
	4-1/2	37070	35970	25
	5	37071	35971	25
	5-1/2	37072	35972	25
	6	37073	35973	25
	<b>1/2</b> -13 USS -20 SAE Thread	3/4	37074	35974
7/8		37075	35975	50
1		37076	35976	50
1-1/4		37077	35977	50
1-1/2		37078	35978	50
1-3/4		37079	35979	50
2		37080	35980	50
2-1/4		37081	35981	25
2-1/2		37082	35982	25
2-3/4		37083	35983	25
3		37084	35984	25
3-1/4		37085	35985	25
3-1/2		37086	35986	25
3-3/4		37087	35987	25

Dia	Length	Part #		Qty
		USS	SAE	
<b>1/2</b> -13 USS -20 SAE Thread	4	37088	35988	25
	4-1/2	37089	35989	25
	5	37090	35990	25
	5-1/2	37091	35991	25
	6	37092	35992	25
	6-1/2	37093	35993	25
	7	37094	35994	25
	7-1/2	37095	35995	25
	8	37096	35996	25
	8-1/2	37097	35997	25
<b>9/16</b> -12 USS -18 SAE Thread	9	37098	35998	25
	10	37099	35999	25
	1	38700	38750	25
	1-1/4	38701	38751	25
	1-1/2	38702	38752	25
	1-3/4	38703	38753	25
	2	38704	38754	25
	2-1/4	38705	38755	25
	2-1/2	38706	38756	25
	2-3/4	38707	38757	25
	3	38708	38758	25
	3-1/4	38709	38759	25
	3-1/2	38710	38760	25
	3-3/4	38711	38761	25
4	38712	38762	25	
4-1/2	38713	38763	25	
5	38714	38764	25	
5-1/2	38715	38765	25	
6	38716	38766	25	

- » Traceable.
- » Double heat treated.
- » Available in full case & keg quantities.

# HEX HEAD CAP SCREWS

DOMESTIC - GRADE 5

Plating: Zinc

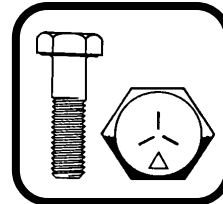

USA / CANADA

Dia	Length	Part #		Qty
		USS	SAE	
<b>5/8</b> -11 USS -18 SAE Thread	1	37100	36000	25
	1-1/4	37101	36001	25
	1-1/2	37102	36002	25
	1-3/4	37103	36003	25
	2	37104	36004	25
	2-1/4	37105	36005	25
	2-1/2	37106	36006	25
	2-3/4	37107	36007	25
	3	37108	36008	25
	3-1/4	37109	36009	25
	3-1/2	37110	36010	25
	3-3/4	37111	36011	25
	4	37112	36012	25
	4-1/2	37113	36013	25
	5	37114	36014	25
	5-1/2	37115	36015	25
	6	37116	36016	25
	6-1/2	37117	36017	25
	7	37118	36018	25
	7-1/2	37119	36019	25
	8	37120	36020	25
	8-1/2	37121	36021	25
	9	37122	36022	25
	10	37123	36023	25
11	37124	36024	25	
12	37125	36025	25	

Dia	Length	Part #		Qty
		USS	SAE	
<b>3/4</b> -10 USS -16 SAE Thread	1	37126	36026	25
	1-1/4	37127	36027	25
	1-1/2	37128	36028	25
	1-3/4	37129	36029	25
	2	37130	36030	25
	2-1/4	37131	36031	25
	2-1/2	37132	36032	25
	2-3/4	37133	36033	25
	3	37134	36034	25
	3-1/4	37135	36035	25
	3-1/2	37136	36036	25
	3-3/4	37137	36037	25
	4	37138	36038	25
	4-1/2	37139	36039	10
	5	37140	36040	10
	5-1/2	37141	36041	10
	6	37142	36042	10
	6-1/2	37143	36043	10
	7	37144	36044	10
	7-1/2	37145	36045	10
	8	37146	36046	10
	8-1/2	37147	36047	5
	9	37148	36048	5
	10	37149	36049	1
11	37150	36050	1	
12	37151	36051	1	

- » Traceable.
- » Double heat treated.
- » Available in full case & keg quantities.

# HEX HEAD CAP SCREWS

DOMESTIC - GRADE 5

Plating: Zinc

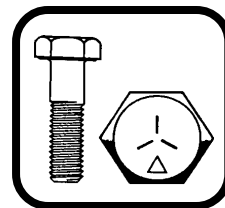

USA / CANADA

Dia	Length	Part #		Qty
		USS	SAE	
<b>7/8</b> - 9 USS -14 SAE Thread	1-1/2	37154	36054	15
	1-3/4	37155	36055	15
	2	37156	36056	15
	2-1/4	37157	36057	15
	2-1/2	37158	36058	15
	2-3/4	37159	36059	15
	3	37160	36060	15
	3-1/4	37161	36061	15
	3-1/2	37162	36062	15
	3-3/4	37163	36063	15
	4	37164	36064	15
	4-1/2	37165	36065	10
	5	37166	36066	10
	5-1/2	37167	36067	10
	6	37168	36068	10
	6-1/2	37168A	36068A	10
	7	37169	36069	10
	7-1/2	37169A	36069A	10
	8	37170	36070	10
	9	37171	36071	5
10	37172	36072	5	
11	37173	—	1	
12	37174	—	1	

Dia	Length	Part #		Qty
		USS	SAE	
<b>1"</b> - 8 USS -14 SAE Thread	1-1/2	37175	36075	10
	1-3/4	37176	36076	10
	2	37177	36077	10
	2-1/4	37178	36078	10
	2-1/2	37179	36079	10
	2-3/4	37180	36080	10
	3	37181	36081	10
	3-1/4	37182	36082	10
	3-1/2	37183	36083	10
	3-3/4	37184	36084	10
	4	37185	36085	10
	4-1/2	37186	36086	10
	5	37187	36087	10
	5-1/2	37188	36088	10
	6	37189	36089	10
	6-1/2	37190	36090	10
	7	37191	36091	10
	7-1/2	37191A	36091A	10
	8	37192	36092	10
	9	37193	36093	5
10	37194	36094	5	
11	37195	—	1	
12	37196	—	1	

- » Traceable.
- » Double heat treated.
- » Available in full case & keg quantities.

# HEX HEAD CAP SCREWS

DOMESTIC - GRADE 5

Plating: Zinc

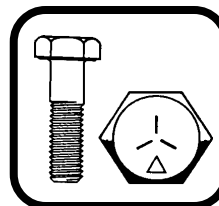

USA / CANADA

Dia	Length	Part #		Qty
		USS	SAE	
<b>1-1/8</b> - 7 USS -12 SAE Thread	2-1/2	05709	05710	10
	3	05711	05712	10
	3-1/2	05711A	05712A	10
	4	05713	05714	10
	4-1/2	05713A	05714A	10
	5	05715	05716	10
	5-1/2	05715A	05716A	10
	6	05717	05718	10
	6-1/2	05717A	05718A	10
	7	05719	05720	10
	7-1/2	05719A	05720A	10
	8	05721	05722	10
	9	05723	05724	5
	10	05725	05726	5
	11	05727	—	1
	12	05729	—	1
<b>1-1/4</b> - 7 USS -12 SAE Thread	2-1/2	05729A	05730A	5
	3	05731	05732	5
	3-1/2	05731A	05732A	5
	4	05733	05734	5
	4-1/2	05733A	05734A	5
	5	05735	05736	5
	5-1/2	05735A	05736A	5
	6	05737	05738	5
	6-1/2	05737A	05738A	5
	7	05739	05740	5
	7-1/2	05739A	05740A	5
	8	05741	05742	5
	9	05743	05744	5
	10	05745	05746	5
	11	05747	—	1
	12	05749	—	1

Dia	Length	Part #		Qty
		USS	SAE	
<b>1-1/2</b> - 6 USS -12 SAE Thread	4	07904	—	1
	5	07906	—	1
	6	07908	—	1
	7	07910	—	1
	8	07912	—	1
	9	07913	—	1
	10	07914	—	1
	12	07916	—	1

# FINISHED HEX NUTS

## FOR USE WITH GRADE 5 CAP SCREWS

Plating: Zinc



- » Engineered specifically to match high torque requirements of grade 5 tensile strength cap screws.
- » Manufactured on automatic nut forgers.
- » Cold formed for more dense grain structure.
- » Special high carbon steel.
- » Double heat treated.

\*\*\* SEE SECTION 2 FOR LISTING OF NUTS \*\*\*

Size	Part #		Qty
	USS	SAE	
1/4	00313	00306	100
5/16	00314	00307	100
3/8	00315	00308	100
7/16	00316	00309	100
1/2	00317	00310	100
9/16	00318	00311	50
5/8	00319	00312	50
3/4	00319A	00312A	50
7/8	00319B	00312B	50
1	00319C	00312C	10
1-1/8	00319D	00312D	5
1-1/4	00319E	00312E	5
1-3/8	00319G	00312G	5
1-1/2	00319F	00312F	5

# FLAT & LOCK WASHERS

## FOR USE WITH GRADE 5 CAP SCREWS & NUTS

Plating: Zinc

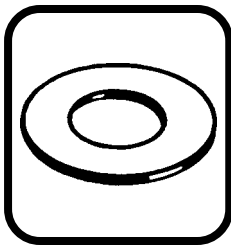

### Flat Washers

Size	Part #		Qty
	USS	SAE	
1/4	00367	00359	100
5/16	00368	00360	100
3/8	00369	00361	100
7/16	00370	00362	100
1/2	00371	00363	100
9/16	00372	00364	100
5/8	00373	00365	100
3/4	00373A	00365A	50
7/8	00373B	00365B	50
1	00373C	00365C	25
1-1/8	00373D	00365D	25
1-1/4	00373E	00365E	25
1-1/2	00373F	00365F	25

### Lock Washers

Size	Part #	Qty
1/4	00377	100
5/16	00378	100
3/8	00379	100
7/16	00380	100
1/2	00381	100
9/16	00382	100
5/8	00383	100
3/4	00384	100
7/8	00384A	50
1	00384B	50
1-1/8	00384C	25
1-1/4	00384D	25
1-1/2	00384E	25

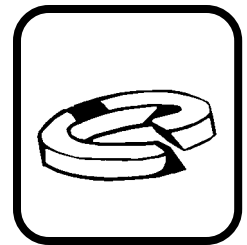

\*\*\* SEE SECTION 2 FOR COMPLETE LISTING OF WASHERS \*\*\*

# HEX HEAD TAP BOLTS

## GRADE 2 - USS

Threaded To The Head - Plating: Zinc

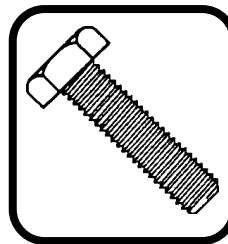

Dia	Length	Part #	Qty
<b>1/4</b> -20 USS Thread	1	<b>03000</b>	100
	1-1/4	<b>03001</b>	100
	1-1/2	<b>03002</b>	100
	2	<b>03003</b>	100
	2-1/2	<b>03004</b>	100
	3	<b>03005</b>	50
	3-1/2	<b>03006</b>	50
	4	<b>03007</b>	25
	5	<b>03008</b>	25
6	<b>03009</b>	25	
<b>5/16</b> -18 USS Thread	1	<b>03010</b>	100
	1-1/4	<b>03011</b>	100
	1-1/2	<b>03012</b>	50
	2	<b>03013</b>	50
	2-1/2	<b>03014</b>	50
	3	<b>03015</b>	50
	3-1/2	<b>03016</b>	50
	4	<b>03017</b>	25
5	<b>03018</b>	25	
6	<b>03019</b>	25	
<b>3/8</b> -16 USS Thread	1	<b>03020</b>	50
	1-1/2	<b>03021</b>	50
	2	<b>03022</b>	50
	2-1/2	<b>03023</b>	25
	3	<b>03024</b>	25
	3-1/2	<b>03025</b>	25
	4	<b>03026</b>	25
5	<b>03027</b>	25	
6	<b>03028</b>	25	
<b>1/2</b> -13 USS Thread	1-1/2	<b>03029</b>	25
	1-3/4	<b>03030</b>	25
	2	<b>03031</b>	25
	2-1/4	<b>03031A</b>	25
	2-1/2	<b>03032</b>	25
	3	<b>03033</b>	25
	3-1/2	<b>03034</b>	25
	4	<b>03035</b>	25
	5	<b>03036</b>	25
6	<b>03037</b>	25	

- » Finished washer face.
- » Chamfered point.
- » Class 2a thread before plating.

# HEX HEAD LAG BOLTS

Plating: Zinc

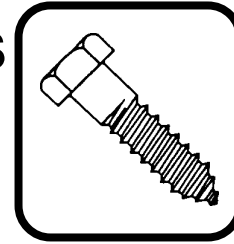

Dia	Length	Part #	Qty	
<b>1/4</b>	1	1416L	100	
	1-1/4	1420L	100	
	1-1/2	1424L	100	
	1-3/4	1428L	100	
	2	1432L	100	
	2-1/2	1440L	100	
	2-3/4	1444L	100	
	3	1448L	50	
	3-1/2	1456L	50	
	4	1464L	50	
	4-1/2	1472L	50	
	5	1480L	25	
	5-1/2	1488L	25	
	6	1496L	25	
	<b>5/16</b>	1	3116L	100
		1-1/4	3120L	100
		1-1/2	3124L	100
		1-3/4	3128L	100
2		3132L	100	
2-1/2		3140L	100	
3		3148L	50	
3-1/2		3156L	50	
4		3164L	25	
4-1/2		3172L	25	
5		3180L	25	
5-1/2		3188L	25	
6		3196L	25	

Dia	Length	Part #	Qty
<b>3/8</b>	1	3716L	100
	1-1/4	3720L	100
	1-1/2	3724L	100
	1-3/4	3728L	100
	2	3732L	50
	2-1/2	3740L	50
	3	3748L	50
	3-1/2	3756L	50
	4	3764L	25
	4-1/2	3772L	25
	5	3780L	25
	5-1/2	3788L	25
	6	3796L	15
	6-1/2	37104L	15
	7	37112L	10
	8	37128L	10
	10	37160L	10
	12	37192L	10
<b>1/2</b>	1-1/2	5024L	25
	1-3/4	5028L	25
	2	5032L	25
	2-1/2	5040L	25
	3	5048L	15
	3-1/2	5056L	15
	4	5064L	15
	4-1/2	5072L	15
	5	5080L	10
	5-1/2	5088L	10
	6	5096L	10
	6-1/2	50104L	10
	7	50112L	10
	8	50128L	10
	9	50144L	10
	10	50160L	10
	11	50176L	10
	12	50192L	10

Dia	Length	Part #	Qty	
<b>5/8</b>	2	6232L	15	
	2-1/2	6240L	15	
	3	6248L	15	
	3-1/2	6256L	15	
	4	6264L	15	
	4-1/2	6272L	15	
	5	6280L	10	
	5-1/2	6288L	10	
	6	6296L	10	
	7	62112L	10	
	8	62128L	10	
	9	62144L	10	
	10	62160L	10	
	11	62176L	10	
	12	62192L	10	
	<b>3/4</b>	2-1/2	7540L	10
		3	7548L	10
		3-1/2	7556L	10
4		7564L	10	
4-1/2		7572L	10	
5		7580L	10	
6		7596L	10	
7		75112L	10	
8		75128L	10	
10		75160L	10	
12		75192L	10	

# EYE BOLTS

Plating: Zinc

## Machine Thread

Dia.	Length	Part #	Qty
3/16-24	1	C-1	10
	2	C-3	10
1/4-20	1	E-1	10
	2	E-3	10
	2-1/2	E-4	10
	3	E-5	10
	4	E-7	10
5/16-18	2	F-2	10
	3	F-4	10
	4	F-6	10
	5	F-7	10
3/8-16	2-1/2	G-3	10
	4	G-6	10
	6	G-8	10



## Lag Thread

Dia.	Length	Part #	Qty
1/4	2-3/4	LS1	10
	4	LS2	10
5/16	2-3/4	LS3	10
	4-3/4	LS4	10
3/8	3	LS5	10
	6	LS6	10
1/2	3-1/2	LS7	10



## Acoustical Lag

Dia.	Length	Part #	Qty
1/4	3	03950	50



# HANGER BOLTS & ELEVATOR BOLTS

Plating: Zinc

## Hanger Bolts

Dia.	Length	Part #	Qty
10-24	1-1/2	37802	100
	2	37803	100
1/4-20	1-1/2	37804	100
	2	37805	100
	3	37807	100
5/16-18	1-1/2	37808	50
	2	37809	50
	2-1/2	37810	50
	3	37811	50
3/8-16	2-1/2	37812	50
	3	37813	50



## Elevator Bolts

Dia.	Length	Part #	Qty
1/4-20	3/4	06787	100
	1	06788	100
	1-1/4	06789	100
	1-1/2	06790	100
	1-3/4	06791	100
	2	06792	100
5/16-18	1	06795	50
	1-1/4	06795	50
	1-1/2	06797	50
	1-3/4	06798	50
	2	06799	50
	2-1/2	06801	50
3/8-16	1	06802	50
	1-1/4	06803	50
	1-1/2	06804	50
	1-3/4	06805	50
	2	06806	50
	2-1/2	06808	50
	3	06809	50

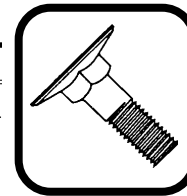



# CARRIAGE BOLTS

## GRADE 2

Uss Threads - Without Nuts - Plating: Zinc

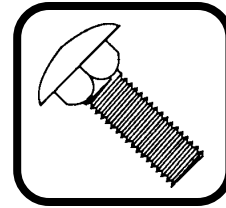

Dia	Length	Part #	Qty
<b># 10</b> -24 USS Thread	3/4	00334	100
	1	00335	100
	1-1/4	00336	100
	1-1/2	00337	100
	2	01509	100
	2-1/2	01510	100
<b>1/4</b> -20 USS Thread	3	01511	100
	3/4	00338	100
	1	00339	100
	1-1/4	00340	100
	1-1/2	00341	100
	1-3/4	06685	100
	2	00342	100
	2-1/4	06686	50
	2-1/2	01512	50
	2-3/4	06687	50
	3	01513	50
	3-1/2	01514	25
	4	01515	25
	4-1/2	06688	25
5	06689	25	
5-1/2	06690	25	
6	06691	25	
7	06691A	25	
<b>5/16</b> -18 USS Thread	3/4	00343	100
	1	00344	100
	1-1/4	00345	100
	1-1/2	00346	100
	1-3/4	06692	100
	2	00347	100
	2-1/4	06693	50
	2-1/2	00348	50
	2-3/4	06694	50
	3	01516	50
	3-1/2	01517	25
	4	01518	25
	4-1/2	01519	25
	5	01520	25
	5-1/2	01521	25
	6	01522	25
7	01522A	25	

Dia	Length	Part #	Qty
<b>3/8</b> -16 USS Thread	3/4	00349	100
	1	00350	100
	1-1/4	00351	100
	1-1/2	00352	100
	1-3/4	06695	50
	2	00353	50
	2-1/4	06696	50
	2-1/2	00354	50
	2-3/4	06697	25
	3	01523	25
	3-1/2	01524	25
	4	01525	25
4-1/2	01526	25	
5	01527	25	
5-1/2	01528	25	
6	01529	25	
7	01530	20	
8	01530A	20	
9	01530B	10	
10	01530C	10	
12	01530D	10	
<b>7/16</b> -14 USS Thread	1	00572	100
	1-1/4	06702	50
	1-1/2	00573	50
	1-3/4	06703	50
	2	00574	50
	2-1/4	06704	50
	2-1/2	00575	50
	3	00576	50
	3-1/2	00577	25
	4	00578	25
5	01531	25	
5-1/2	01532	25	
6	01533	25	

# CARRIAGE BOLTS

## GRADE 2

Uss Threads - Without Nuts - Plating: Zinc

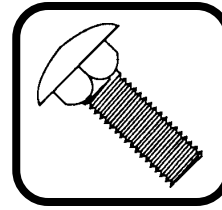

Dia	Length	Part #	Qty
<b>1/2</b> -13 USS Thread	1	06710	50
	1-1/4	06711	50
	1-1/2	00580	50
	2	00581	25
	2-1/2	00582	25
	3	00583	25
	3-1/2	00584	25
	4	00585	25
	4-1/2	00586	25
	5	00587	25
	5-1/2	01534	25
	6	01535	25
	6-1/2	06712	25
	7	06713	25
	7-1/2	06714	25
	8	06715	25
	9	06716	10
	10	06717	10
	12	06718	10
	14	06719	10
16	06720	10	
<b>5/8</b> -11 USS Thread	1-1/2	06721	25
	2	06722	25
	2-1/2	06723	25
	3	06725	25
	3-1/2	06726	25
	4	06727	25
	4-1/2	06728	25
	5	06729	25
	5-1/2	06729A	25
	6	06730	25
	6-1/2	06731	25
	7	06732	10
	8	06733	10
9	06734	10	
10	06735	10	
12	06736	10	

Dia	Length	Part #	Qty
<b>3/4</b> -10 USS Thread	2	06740	25
	2-1/2	06741	25
	3	06742	25
	3-1/2	06743	25
	4	06744	25
	4-1/2	06745	15
	5	06746	15
	5-1/2	06747	15
	6	06748	10
	7	06749	10
	8	06750	10
	10	06751	10
12	06752	10	

# SHAKER SCREEN BOLTS

GRADE 5 - HEAT TREATED

Plain Steel

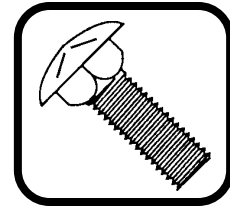

Dia	Length	Part #	Qty
<b>1/2</b> -13 USS Thread	1-1/2	<b>216095</b>	50
	1-3/4	<b>216115</b>	50
	2	<b>216135</b>	50
	2-1/2	<b>216155</b>	25
	3	<b>216175</b>	25
	3-1/2	<b>216195</b>	25
	4	<b>216215</b>	25
	4-1/2	<b>216235</b>	25
	5	<b>216255</b>	25
<b>5/8</b> -11 USS Thread	2	<b>217135</b>	25
	2-1/4	<b>217145</b>	25
	2-1/2	<b>217155</b>	25
	2-3/4	<b>217165</b>	25
	3	<b>217175</b>	25
	3-1/2	<b>217195</b>	25
	4	<b>217215</b>	25
	4-1/2	<b>217235</b>	25
	5	<b>217255</b>	25
	5-1/2	<b>217275</b>	25
	6	<b>217295</b>	20
<b>3/4</b> -10 USS Thread	2	<b>218135</b>	20
	2-1/2	<b>218155</b>	20
	2-3/4	<b>218165</b>	20
	3	<b>218175</b>	20
	3-1/2	<b>218195</b>	20
	4	<b>218215</b>	20
	4-1/2	<b>218235</b>	20
	5	<b>218255</b>	20
5-1/2	<b>218275</b>	20	
	6	<b>218295</b>	20

# #3 HEAD PLOW BOLTS

## GRADE 5 & GRADE 8

Flat & Dome Heads

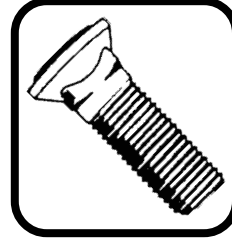

### Grade 5 - Flat Head

Dia	Length	Part #	Qty
<b>3/8</b> -16 USS Thread	1	202055	100
	1-1/2	202095	100
	2	202135	100
	2-1/4	202145	100
	2-1/2	202155	100
	3	202175	50
<b>7/16</b> -14 USS Thread	1-1/2	203095	100
	2	203135	100
	2-1/2	203155	50
	3	203175	50
	3-1/2	203195	50
<b>1/2</b> -13 USS Thread	4	203215	50
	1-1/2	204095	50
	1-3/4	204115	50
	2	204135	50
	2-1/4	204145	50
	2-1/2	204155	50
	3	204175	50
	3-1/2	204195	25
4	204215	25	

### Grade 8 - Dome Head

Dia	Length	Part #	Qty
<b>5/8</b> -11 USS Thread	2	205138	50
	2-1/4	205148	50
	2-1/2	205158	25
	2-3/4	205168	25
	3	205178	25
	3-1/2	205198	25
	4	205218	25
	4-1/2	205238	25
	5	205258	25
	<b>3/4</b> -10 USS Thread	2	206128
2-1/2		206158	25
2-3/4		206168	25
3		206178	25
3-1/2		206198	25
4		206218	25
4-1/2		206238	25
5	206258	25	
<b>7/8</b> - 9 USS Thread	2-1/2	207158	25
	3	207178	25
	3-1/2	207198	25
	4	207218	25
	4-1/2	207238	25
	5	207258	15
<b>1"</b> - 8 USS Thread	3	209178	10
	3-1/2	209198	10
	4	209218	10
	4-1/2	209238	10
	5	209258	10
	5-1/2	209278	10
6	209298	10	

# FRAME BOLTS & NUTS

## GRADE 8 - ALLOY

Black Phosphate & Oiled



**Frame Bolts**

Dia	Length	Part #	Qty
<b>3/8</b> -16 USS Thread	1	3716BF	25
	1-1/4	3720BF	25
	1-1/2	3724BF	25
	1-3/4	3728BF	25
	2	3732BF	25
<b>1/2</b> -13 USS Thread	1-1/4	5020BF	25
	1-1/2	5024BF	25
	1-3/4	5028BF	25
	2	5032BF	15
	2-1/4	5036BF	15
	2-1/2	5040BF	15
	2-3/4	5044BF	15
	3	5048BF	15
<b>5/8</b> -11 USS Thread	1-1/2	6224BF	10
	1-3/4	6228BF	10
	2	6232BF	10
	2-1/4	6236BF	10
	2-1/2	6240BF	10
	2-3/4	6244BF	10
	3	6248BF	10
<b>3/4</b> -10 USS Thread	2	7532BF	10
	2-1/4	7536BF	10
	2-1/2	7540BF	10
	3	7548BF	10
	3-1/2	7556BF	10

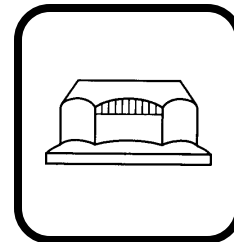

**Flange Style Lock Nuts**

Size	Part #	Qty
<b>3/8-16</b>	37NOR	25
<b>1/2-13</b>	50NOR	25
<b>5/8-11</b>	62NOR	25
<b>3/4-10</b>	75NOR	25

- » Manufactured to SAE J-429 specifications.
- » Coarse thread.
- » Indented hex flange.

# MANIFOLD STUDS

## GRADE 5 - HEAT TREATED

Plain Steel

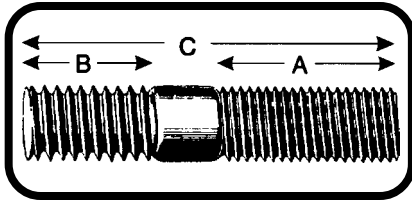

Part #	A Dia & Length	B Dia & Length	C OAL	Qty
A19595	1/4-20 USS x 1/2	1/4-20 USS x 8"	9"	10
A9667	1/4-28 SAE x 3/8	1/4-20 USS x 7/16	1"	10
A9668	1/4-28 SAE x 1/2	1/4-20 USS x 1/2	1-1/4	10
A9669	1/4-28 SAE x 3/4	1/4-20 USS x 1/2	1-1/2	10
A9670	1/4-28 SAE x 1"	1/4-20 USS x 1/2	2"	10
A9673	5/16-24 SAE x 1/2	5/16-18 USS x 3/8	1"	10
A9674	5/16-24 SAE x 5/8	5/16-18 USS x 1/2	1-1/4	10
A9675	5/16-24 SAE x 5/8	5/16-18 USS x 3/4	1-1/2	10
A19596	5/16-24 SAE x 13/16	5/16-18 USS x 9/16	1-1/2	10
A9676	5/16-24 SAE x 7/8	5/16-18 USS x 9/16	1-3/4	10
A9677	5/16-24 SAE x 1"	5/16-18 USS x 9/16	2"	10
A9678	5/16-24 SAE x 1/2	5/16-18 USS x 1/2	2-1/2	10
A14824	5/16-24 SAE x 1-5/8	5/16-18 USS x 1/2	2-1/2	10
A9679	5/16-18 USS x 7/8	5/16-18 USS x 7/16	1-1/2	10
A9680	5/16-18 USS x 1"	5/16-18 USS x 7/16	2"	10
A9681	5/16-24 SAE x 1-1/2	5/16-18 USS x 5/8	3"	10
A9683	3/8-24 SAE x 3/4	3/8-16 USS x 1/2	1-1/2	10
A9684	3/8-24 SAE x 3/4	3/8-16 USS x 1/2	1-3/4	10
A9685	3/8-24 SAE x 3/4	7/16-14 USS x 7/8	1-7/8	10
A9686	3/8-24 SAE x 1"	3/8-16 USS x 5/8	2"	10
A9687	3/8-16 USS x 1-1/8	3/8-16 USS x 5/8	2"	10
A9688	3/8-24 USS x 1"	3/8-16 USS x 5/8	2-1/8	10
A14827	3/8-16 USS x 1-5/8	3/8-16 USS x 7/16	2-7/32	10
A19597	3/8-16 USS x 1/2	3/8-16 USS x 1-7/8	2-1/2	10
A9689	3/8-24 SAE x 1"	3/8-16 USS x 3/4	2-3/4	10
A12129	3/8-16 USS x 5/8	3/8-16 USS x 2"	3"	10
A9690	3/8-24 SAE x 2	3/8-16 USS x 5/8	3"	10
A9692	3/8-16 USS x 1-5/8	3/8-16 USS x 7/16	3-1/4	10
A14828	3/8-16 USS x 2-3/16	3/8-16 USS x 1/2	3-5/16	10
A9694	3/8-24 SAE x 1"	3/8-16 USS x 3/4	3-3/4	10
A9695	3/8-16 USS x 2"	3/8-16 USS x 3/4	4"	10
A9696	3/8-24 SAE x 1-7/8	3/8-16 USS x 1/2	4"	10
A9697	7/16-20 SAE x 3/4	7/16-14 USS x 1/2	1-1/2	10
A9698	7/16-20 USS x 13/16	7/16-14 USS x 3/4	1-3/4	10
A9699	7/16-20 SAE x 3/4	7/16-14 USS x 9/16	1-3/4	10
A9701	7/16-20 SAE x 7/8	7/16-14 USS x 3/4	2"	10
A9702	7/16-14 USS x 15/16	7/16-14 USS x 3/4	2"	10
A9705	7/16-20 SAE x 3/4	7/16-14 USS x 3/4	2-1/4	10
A9709	7/16-20 SAE x 7/8	7/16-14 USS x 3/4	2-1/2	10
A9711	7/16-14 USS x 1-1/4	7/16-14 USS x 3/4	2-1/2	10
A9712	7/16-20 SAE x 1-3/8	7/16-14 USS x 3/4	2-1/2	10
A9715	7/16-20 SAE x 1-13/16	7/16-14 USS x 3/4	3"	10
A19599	7/16-20 SAE x 1-7/8	7/16-14 USS x 5/8	3-1/4	10
A19598	7/16-14 USS x 1-7/8	7/16-14 USS x 3/4	3-1/4	10
A9727	1/2-20 SAE x 3/4	1/2-13 USS x 3/4	1-7/8	10
A9728	1/2-20 SAE x 15/16	1/2-13 USS x 13/16	2"	10
A9729	1/2-20 SAE x 1-1/8	1/2-13 USS x 3/4	2-1/4	10
A9731	1/2-20 SAE x 1"	1/2-13 USS x 3/4	2-1/2	10
A9732	1/2-20 SAE x 2"	1/2-13 USS x 3/4	3"	10
A9738	9/16-18 SAE x 1"	9/16-12 USS x 3/4	2-1/2	10
A9739	9/16-18 SAE x 1-1/4	9/16-12 USS x 1"	3"	10
A9743	5/8-18 SAE x 1"	5/8-11 USS x 3/4	2-1/2	10
A9744	5/8-11 USS x 1-1/2	5/8-11 USS x 13/16	2-5/8	10
A9745	5/8-18 SAE x 1-1/4	5/8-11 USS x 1"	3"	10
A9746	5/8-18 SAE x 1-1/2	5/8-11 USS x 1-1/4	3-1/2	10
A9748	3/4-10 USS x 1-9/16	3/4-10 USS x 1-1/16	2-13/16	10

# THREADED ROD

Grade 2 & B-7 Alloy

## GRADE 2 - ZINC PLATED

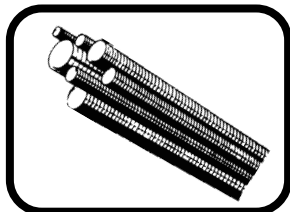

## B-7 ALLOY PLAIN STEEL

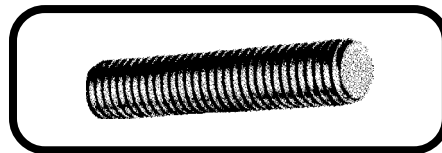

### USS THREAD

Size	Part #	
	3 ft	6 ft
6-32	07702	-
8-32	07703	-
10-24	07704	-
1/4-20	07705	07720
5/16-18	07706	07721
3/8-16	07707	07722
7/16-14	07708	07723
1/2-13	07709	07724
9/16-12	07710	07725
5/8-11	07711	07726
3/4-10	07712	07727
7/8-9	07713	07728
1"-8	07714	07729
1-1/8-7	07715	07730
1-1/4-7	07716	07731
1-1/2-6	07717	07732

### SAE THREAD

Size	Part #
	3 ft
10-32	07744
1/4-28	07745
5/16-24	07746
3/8-24	07747
7/16-20	07748
1/2-20	07749
9/16-18	07750
5/8-18	07751
3/4-16	07752
7/8-14	07753
1"-14	07754

### USS THREAD

Size	Part #
	3 ft
1/4-20	07760
5/16-18	07761
3/8-16	07762
7/16-14	07763
1/2-13	07764
9/16-12	07765
5/8-11	07766
3/4-10	07767
7/8-9	07768
1"-8	07769
1-1/8-7	07770
1-1/4-7	07771

- » A.S.T.M. specification #A193 grade B-7.
- » Full continuous cut thread.
- » Class 2A thread.

# ROD COUPLING NUTS

## COARSE THREAD ONLY

Plating: Zinc

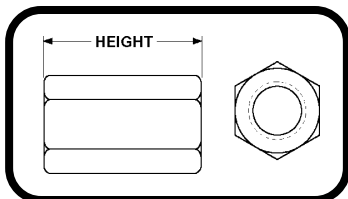

Size	Height	Part #	Qty
3/16-24	3/4	14931	50
1/4-20	7/8	14932	50
5/16-18	1-1/8	14933	50
3/8-16	1-3/4	14934	50
7/16-14	1-3/4	14935	25
1/2-13	1-3/4	14936	25
5/8-11	2-1/8	14937	10
3/4-10	2-1/4	14938	10
7/8-9	2-1/2	14939	5
1-8	2-3/4	14940	5

\*\*\* See Metric Section for Metric Threaded Rod \*\*\*

\*\*\* See Stainless Section for Stainless Threaded Rod \*\*\*

# SOCKET HEAD CAP SCREWS

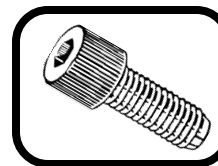

## ALLOY STEEL

Plain Steel - Black Oil Finish

Dia	Length	Part #		Qty	
		USS	SAE		
<b># 0</b> - 80 USS Thread .050 Key	1/8	02747	—	100	
	3/16	02748	—	100	
	1/4	02749	—	100	
	3/8	02750	—	100	
<b># 1</b> - 72 USS Thread 1/16 Key	1/8	02751	—	100	
	3/16	02752	—	100	
	1/4	02753	—	100	
	3/8	02754	—	100	
<b># 2</b> - 56 USS Thread 5/64 Key	3/16	02600	—	100	
	1/4	02601	—	100	
	3/8	02602	—	100	
	1/2	02603	—	100	
	5/8	02603A	—	100	
	3/4	02603B	—	100	
	1	02603C	—	100	
<b># 3</b> - 48 USS Thread 5/64 Key	3/16	02755	—	100	
	1/4	02756	—	100	
	3/8	02757	—	100	
	1/2	02758	—	100	
<b># 4</b> - 40 USS - 48 SAE Thread 3/32 Key	1/4	02604	—	100	
	5/16	02604A	—	100	
	3/8	02605	—	100	
	1/2	02606	02606F	100	
	5/8	02607	—	100	
	3/4	02608	—	100	
	1	02608A	—	100	
<b># 5</b> - 40 USS Thread 3/32 Key	1/4	02609	—	100	
	3/8	02610	—	100	
	1/2	02611	—	100	
	5/8	02612	—	100	
	3/4	02613	—	100	
<b># 6</b> - 32 USS - 40 SAE Thread 7/64 Key	1/8	02613C	—	100	
	3/16	02613D	—	100	
	1/4	02614	02614F	100	
	5/16	02614A	—	100	
	3/8	02615	02615F	100	
	1/2	02616	02616F	100	
	5/8	02617	02617F	100	
	3/4	02918	—	100	
	7/8	02919	—	100	
		1	02620	—	100
	1-1/8	02620A	—	100	

Dia	Length	Part #		Qty
		USS	SAE	
<b># 8</b> - 32 USS Thread 9/64 Key	1/4	02621	—	100
	3/8	02622	—	100
	1/2	02623	—	100
	5/8	02624	—	100
	3/4	02625	—	100
	7/8	02626	—	100
	1	02627	—	100
	1-1/4	02628	—	100
	1-1/2	02629	—	100
<b># 10</b> - 24 USS - 32 SAE Thread 5/32 Key	1/4	02629A	02717A	100
	3/8	02630	02718	100
	1/2	02631	02719	100
	5/8	02632	02720	100
	3/4	02633	02721	100
	7/8	02634	02722	100
	1	02635	02723	100
	1-1/4	02636	02724	50
	1-1/2	02637	02725	50
	1-3/4	02638	02726	50
	2	02639	02727	50
2-1/2	02639A	02727A	25	
3	02639B	02727B	25	
<b>1/4</b> - 20 USS - 28 SAE Thread 3/16 Key	1/4	02639C	—	100
	3/8	02639D	—	100
	1/2	02640	02728	100
	5/8	02641	02729	100
	3/4	02642	02730	100
	7/8	02642A	—	100
	1	02643	02731	50
	1-1/4	02644	02732	50
	1-1/2	02645	02733	50
	1-3/4	02646	—	50
	2	02647	—	50
	2-1/4	02647A	—	25
	2-1/2	02648	—	25
	3	02649	02649F	25
	3-1/2	02650	—	25
4	02651	—	25	



# SOCKET HEAD CAP SCREWS

**ALLOY STEEL**  
Plain Steel - Black Oil Finish



Dia	Length	Part #		Qty
		USS	SAE	
<b>5/16</b> - 18 USS - 24 SAE Thread 1/4 Key	1/2	02652	02652F	100
	5/8	02653	—	100
	3/4	02654	02734	50
	1	02655	02735	50
	1-1/4	02656	02736	25
	1-1/2	02657	02737	25
	1-3/4	02658	—	25
	2	02659	02738	25
	2-1/4	02659A	—	25
	2-1/2	02660	—	25
	2-3/4	02660A	—	25
	3	02661	—	25
	3-1/2	02662	—	25
	4	02663	—	25
<b>3/8</b> - 16 USS - 24 SAE Thread 5/16 Key	3/8	02663A	—	50
	1/2	02664	02664F	50
	5/8	02665	—	25
	3/4	02666	02739	25
	7/8	02666A	—	25
	1	02667	02740	25
	1-1/4	02668	02741	25
	1-1/2	02669	02742	25
	1-3/4	02670	—	25
	2	02671	02743	25
	2-1/4	02672	02672F	25
	2-1/2	02673	—	25
	2-3/4	02673A	—	25
	3	02674	02674F	25
	3-1/2	02675	—	25
	4	02676	—	25
4-1/2	02676A	—	20	
5	02676B	—	20	
6	02676D	—	20	

Dia	Length	Part #		Qty
		USS	SAE	
<b>7/16</b> - 14 USS - 20 SAE Thread 3/8 Key	1/2	02676J	—	25
	3/4	02677	—	25
	7/8	02677A	—	25
	1	02678	—	25
	1-1/4	02679	—	25
	1-1/2	02680	—	25
	1-3/4	02681	—	25
	2	02682	—	25
	2-1/4	02682A	—	25
	2-1/2	02683	—	25
	3	02684	—	25
	3-1/2	02684A	—	20
	4	02684B	—	20
	<b>1/2</b> - 13 USS - 20 SAE Thread 3/8 Key	1/2	02684J	—
5/8		02684K	—	25
3/4		02685	—	25
7/8		02685A	—	25
1		02686	02744	25
1-1/4		02687	02687F	25
1-1/2		02688	02745	25
1-3/4		02689	02689F	25
2		02690	02746	25
2-1/4		02690A	—	25
2-1/2		02691	—	25
2-3/4		02691A	—	25
3		02692	—	25
3-1/2		02693	—	20
4		02694	—	20
4-1/2		02695	—	20
5	02696	—	15	
5-1/2	02697	—	15	
6	02698	—	15	

- » Traceable.
- » Double heat treated.
- » Available in full case & keg quantities.

# SOCKET HEAD CAP SCREWS

**ALLOY STEEL**  
Plain Steel - Black Oil Finish



Dia	Length	Part #		Qty
		USS	SAE	
<b>5/8</b> - 11 USS - 18 SAE Thread 1/2 Key	1-1/2	02699	—	10
	1-3/4	02700	02700F	10
	2	02701	02701F	10
	2-1/4	02701A	—	10
	2-1/2	02702	—	10
	2-3/4	02702A	02702AF	10
	3	02703	—	10
	3-1/2	02704	—	10
	4	02705	—	5
	4-1/2	02706	—	5
	5	02707	—	5
<b>3/4</b> - 10 USS - 16 SAE Thread 5/8 Key	1-1/4	02707E	—	10
	1-1/2	02708	—	10
	1-3/4	02709	—	10
	2	02710	—	10
	2-1/4	02711	—	10
	2-1/2	02712	—	10
	2-3/4	02712A	—	5
	3	02713	—	5
	3-1/4	02713A	—	5
	3-1/2	02714	—	5
	4	02715	—	5
	4-1/2	02716	—	5
	5	02717	—	5
5-1/2	02717B	—	5	
6	02717C	—	5	
<b>7/8</b> - 9 USS Thread 3/4 Key	2-1/2	02759	—	1
	3	02760	—	1
	3-1/2	02761	—	1
	4	02762	—	1
	4-1/2	02763	—	1
	5	02763A	—	1
	5-1/2	02763B	—	1
6	02763C	—	1	

Dia	Length	Part #		Qty
		USS	SAE	
<b>1"</b> - 8 USS Thread 3/4 Key	2-1/2	02764	—	1
	3	02765	—	1
	3-1/2	02766	—	1
	4	02767	—	1
	4-1/2	02768	—	1
	5	02769	—	1
	5-1/2	02770	—	1
	6	02771	—	1
<b>1-1/4</b> - 7 USS Thread 7/8 Key	3	02772	—	1
	3-1/2	02773	—	1
	4	02774	—	1
	4-1/2	02775	—	1
	5	02776	—	1
	5-1/2	02777	—	1
	6	02778	—	1
	7	02779	—	1
	8	02780	—	1
	9	02781	—	1
10	02782	—	1	
<b>1-1/2</b> - 6 USS Thread 1" Key	3	02783	—	1
	3-1/2	02784	—	1
	4	02785	—	1
	4-1/2	02786	—	1
	5	02787	—	1
	6	02788	—	1
	7	02789	—	1
	8	02790	—	1
	9	02791	—	1
	10	02792	—	1
12	02793	—	1	

# FLAT HEAD SOCKET CAP SCREWS

ALLOY STEEL  
Plain Steel - Black Oil Finish



1

Dia	Length	Part #		Qty
		USS	SAE	
<b># 4</b> - 40 USS Thread 1/16 Key	1/4	02800	—	100
	3/8	02801	—	100
	1/2	02802	—	100
	5/8	02802A	—	100
	3/4	02803	—	100
	1	02803A	—	100
<b># 5</b> - 40 USS Thread 5/64 Key	3/8	02803D	—	100
	1/2	02803E	—	100
	5/8	02803F	—	100
	3/4	02803G	—	100
<b># 6</b> - 32 USS Thread 5/64 Key	1/4	02804	—	100
	3/8	02805	—	100
	1/2	02806	—	100
	5/8	02806A	—	100
	3/4	02807	—	100
<b># 8</b> - 32 USS Thread 3/32 Key	3/8	02808	—	100
	1/2	02809	—	100
	5/8	02809A	—	100
	3/4	02810	—	100
	1	02811	—	100
<b># 10</b> - 24 USS - 32 SAE Thread 1/8 Key	1/4	—	02816D	100
	3/8	02811D	02816E	100
	1/2	02812	02817	100
	5/8	02812A	02817A	100
	3/4	02813	02818	100
	1	02814	02819	100
	1-1/4	02815	02820	100
	1-1/2	02816	02821	100
	1/2	02822	02828D	100
5/8	02822A	02828E	100	
3/4	02823	02828F	100	
<b>1/4</b> - 20 USS - 28 SAE Thread 5/32 Key	1	02824	—	100
	1-1/4	02825	—	50
	1-1/2	02826	—	50
	1-3/4	02827	—	50
	2	02828	—	50

Dia	Length	Part #		Qty
		USS	SAE	
<b>5/16</b> - 18 USS - 24 SAE Thread 3/16 Key	1/2	02829	—	100
	3/4	02830	02835F	100
	1	02831	—	100
	1-1/4	02832	—	50
	1-1/2	02833	—	50
	1-3/4	02834	—	50
	2	02835	—	50
	2-1/4	02835A	—	50
	2-1/2	02835B	—	50
	2-3/4	02835C	—	50
<b>3/8</b> - 16 USS - 24 SAE Thread 7/32 Key	1/2	02835R	—	50
	5/8	02835S	02841D	50
	3/4	02836	—	50
	1	02837	—	50
	1-1/4	02838	—	50
	1-1/2	02839	—	50
<b>7/16</b> - 14 USS Thread 1/4 Key	2	02840	—	50
	2-1/2	02841	—	50
	1	02842	—	25
	1-1/4	02843	—	25
	1-1/2	02844	—	25
<b>1/2</b> - 13 USS - 20 SAE Thread 5/16 Key	1-3/4	02844A	—	25
	2	02845	—	25
	3/4	02845D	—	25
	1	02846	02852C	25
	1-1/4	02847	—	25
	1-1/2	02848	—	25
	1-3/4	02849	—	25
	2	02850	—	25
	2-1/2	02851	—	25
	3	02852	—	25
<b>5/8</b> - 11 USS Thread 3/8 Key	1-1/4	02852F	—	10
	1-1/2	02852G	—	10
	2	02852H	—	10
	2-1/2	02852I	—	10
	3	02852J	—	10
<b>3/4</b> - 10 USS Thread 1/2 Key	1-1/2	02852P	—	5
	2	02852Q	—	5
	2-1/2	02852R	—	5
	3	02852S	—	5

# BUTTON SOCKET CAP SCREWS

## ALLOY STEEL

Plain Steel - Black Oil Finish

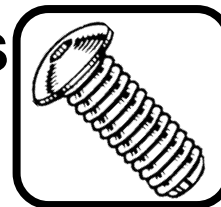

Dia	Length	Part #		Qty
		USS	SAE	
<b># 2</b> - 56 USS Thread .050 Key	3/16	02900	—	100
	1/4	02901	—	100
	3/8	02902	—	100
	1/2	02903	—	100
<b># 3</b> - 48 USS Thread 1/16 Key	1/4	02903D	—	100
	3/8	02903E	—	100
	1/2	02903F	—	100
<b># 4</b> - 40 USS Thread 1/16 Key	5/8	02903G	—	100
	1/4	02904	—	100
	3/8	02905	—	100
<b># 5</b> - 40 USS Thread 5/64 Key	1/2	02906	—	100
	5/8	02906A	—	100
	1/4	02906D	—	100
<b># 6</b> - 32 USS Thread 5/64 Key	3/8	02906E	—	100
	1/2	02906F	—	100
	5/8	02906G	—	100
	1/4	02907	—	100
	5/16	02908	—	100
<b># 8</b> - 32 USS Thread 3/32 Key	3/8	02909	—	100
	1/2	02910	—	100
	5/8	02910A	—	100
	3/4	02910B	—	100
	1/4	02911	—	100
<b># 10</b> - 24 USS - 32 SAE Thread 1/8 Key	3/8	02912	—	100
	1/2	02913	—	100
	5/8	02914	—	100
	3/4	02915	—	100
	1/4	02916	02932	100
	5/16	02917	02933	100
	3/8	02918	02934	100
	1/2	02919	02935	100
	5/8	02920	02936	100
3/4	02921	02937	100	
7/8	02920A	02937A	100	
1	02921	02938	100	

Dia	Length	Part #		Qty
		USS	SAE	
<b>1/4</b> - 20 USS Thread 5/32 Key	3/8	02921X	—	50
	1/2	02922	—	50
	5/8	02923	—	50
	3/4	02924	—	50
	1	02925	—	50
<b>5/16</b> - 18 USS - 24 SAE Thread 3/16 Key	3/8	02925X	—	50
	1/2	02926	02928F	50
	3/4	02927	02928G	50
	1	02928	—	50
	1-1/4	02928A	—	50
	1-1/2	02928B	—	50
	2	02928C	—	25
3	02928D	—	25	
<b>3/8</b> - 16 USS Thread 7/32 Key	5/8	02928M	—	25
	3/4	02929	—	25
	1	02930	—	25
<b>1/2</b> - 13 USS - 20 SAE Thread 5/16 Key	1-1/4	02931	—	25
	1-1/2	02931A	—	25
	2	02931K	—	25
<b>5/8</b> - 11 USS Thread 3/8 Key	1	02931H	02931P	25
	1-1/4	02931I	—	25
	1-1/2	02931J	—	25
	2	02931K	—	25
	1-1/4	02931T	—	10

- » High strength alloy steel.
- » Manufactured to S.A.E. grade & physical requirements.
- » Accurate burr-free deep hex socket.
- » Chamfered point.
- » Precision class 3 thread fit.

# SOCKET SET SCREWS - Cup Point

ALLOY STEEL  
Plain Steel - Black Oil Finish



Dia	Length	Part #		Qty	
		USS	SAE		
<b># 2</b>	1/8	11000	—	100	
	3/16	11001	—	100	
	- 56 USS	1/4	11002	—	100
	Thread	3/8	11003	—	100
	.035 Key	1/2	11004	—	100
<b># 4</b>	1/8	11030	11031	100	
	3/16	11032	11033	100	
	1/4	11034	11035	100	
	- 40 USS	5/16	11036	—	100
	- 48 SAE	3/8	11038	11039	100
	Thread	1/2	11041	—	100
	.050 Key	5/8	11042	—	100
<b># 5</b>	1/8	11006	—	100	
	3/16	11007	—	100	
	1/4	11008	—	100	
	- 40 USS	5/16	11009	—	100
	Thread	3/8	11010	—	100
	1/16 Key	1/2	11011	—	100
<b># 6</b>	1/8	11043	11044	100	
	3/16	11045	11046	100	
	1/4	04214	11047	100	
	5/16	04215	11048	100	
	3/8	04445	11049	100	
	- 32 USS	7/16	04217	—	100
	- 40 SAE	1/2	04218	—	100
	Thread	5/8	11050	—	100
	1/16 Key	3/4	11051	—	100
		7/8	11052	—	100
	1	11053	—	100	
<b># 8</b>	1/8	11054	11055	100	
	3/16	11056	11057	100	
	1/4	04219	11058	100	
	5/16	04220	11059	100	
	3/8	04221	11060	100	
	- 32 USS	7/16	04222	—	100
	- 36 SAE	1/2	04223	11061	100
	Thread	5/8	11062	—	100
	5/64 Key	3/4	11063	—	100
	7/8	11064	—	100	
	1	11065	—	100	

Dia	Length	Part #		Qty	
		USS	SAE		
<b># 10</b>	3/16	04385	04997	100	
	1/4	04386	04224	100	
	5/16	04387	04225	100	
	3/8	04998	04226	100	
	7/16	04999	04227	100	
	- 24 USS	1/2	05000	04228	100
	- 32 SAE	5/8	11066	11067	100
	Thread	3/4	11068	11069	100
	3/32 Key	7/8	11070	—	100
		1	11071	11072	100
		1-1/4	11073	11074	100
<b>1/4</b>	3/16	11075	11076	100	
	1/4	04388	05001	100	
	5/16	04389	05002	100	
	3/8	04390	05003	100	
	7/16	04391	05004	100	
	1/2	04392	05005	100	
	- 20 USS	5/8	11077	11078	100
	- 28 SAE	3/4	11079	11080	100
	Thread	7/8	11081	—	100
	1/8 Key	1	11082	11083	100
		1-1/4	11084	11085	100
	1-1/2	11086	—	100	
	1-3/4	11087	—	100	
	2	11088	—	100	
<b>5/16</b>	1/4	04393	05006	100	
	5/16	04394	05007	100	
	3/8	04395	05008	100	
	7/16	04396	05009	100	
	1/2	04397	05010	100	
	5/8	11089	11090	100	
	- 18 USS	3/4	11091	11092	100
	- 24 SAE	7/8	11093	—	100
	Thread	1	11094	11095	100
	5/32 Key	1-1/4	11096	11097	100
		1-1/2	11098	—	100
	1-3/4	11099	—	100	
	2	11100	—	100	

# SOCKET SET SCREWS - Cup Point

## ALLOY STEEL

Plain Steel - Black Oil Finish

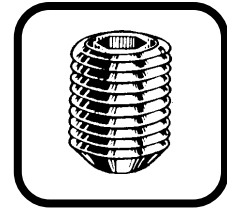

Dia	Length	Part #		Qty
		USS	SAE	
<b>3/8</b> - 16 USS - 24 SAE Thread 3/16 Key	1/4	11101	11102	100
	5/16	04398	05011	100
	3/8	04399	05012	100
	7/16	04400	05013	100
	1/2	04401	05014	100
	5/8	04402	05015	100
	3/4	11103	11104	100
	7/8	11105	—	100
	1	11106	11107	100
	1-1/4	11108	11109	100
	1-1/2	11110	11111	100
	1-3/4	11112	—	100
	2	11113	—	100
	2-1/2	11114	—	100
<b>7/16</b> - 14 USS - 20 SAE Thread 7/32 Key	3/8	04403	05016	100
	7/16	11115	11116	100
	1/2	04404	05017	100
	5/8	04405	—	100
	3/4	11117	—	100
	7/8	11118	—	100
	1	11119	—	100
	1-1/4	11120	—	100
	1-1/2	11121	—	100
	1-3/4	11122	—	100
	2	11123	—	50
2-1/2	11124	—	50	
<b>1/2</b> - 13 USS - 20 SAE Thread 1/4 Key	3/8	04406	—	100
	7/16	04407	—	100
	1/2	04408	05021	100
	5/8	04409	05022	100
	3/4	11125	11126	100
	7/8	11127	—	100
	1	11128	11129	100
	1-1/4	11130	—	100
	1-1/2	11131	—	100
	1-3/4	11132	—	50
	2	11133	—	50
	2-1/2	11134	—	50
	3	11135	—	50

Dia	Length	Part #		Qty
		USS	SAE	
<b>5/8</b> - 11 USS - 18 SAE Thread 5/16 Key	1/2	11136	—	50
	5/8	11137	11138	50
	3/4	11139	—	50
	7/8	11140	—	50
	1	11141	11142	50
	1-1/4	11143	—	50
	1-1/2	11144	—	50
	1-3/4	11145	—	50
	2	11146	—	50
	2-1/2	11147	—	50
	3	11148	—	50
<b>3/4</b> - 10 USS - 16 SAE Thread 3/8 Key	5/8	11149	—	50
	3/4	11150	—	50
	7/8	—	—	50
	1	11152	—	50
	1-1/4	11153	—	50
	1-1/2	11154	—	50
	1-3/4	11155	—	50
	2	11156	—	25
2-1/2	11157	—	25	
3	11158	—	25	
<b>7/8</b> - 9 USS - 14 SAE Thread 1/2 Key	7/8	11159	—	25
	1	11160	—	25
	1-1/4	—	—	25
	1-1/2	11162	—	25
	1-3/4	—	—	25
	2	11164	—	25
	2-1/2	11165	—	25
3	11166	—	25	

- » Class 3A thread fit standard.
- » Rockwell "C" hardness 47-53.
- » Manufactured to ASA B 18.3 1961 standard.

# SOCKET SET SCREWS - Knurl Point

1

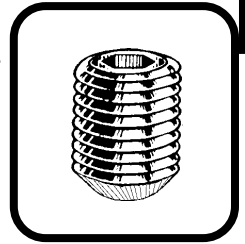

**ALLOY STEEL**  
Plain Steel - Black Oil Finish

Dia	Length	Part #		Qty
		USS	SAE	
<b># 4</b> - 40 USS Thread .050 Key	1/8	04000	—	100
	3/16	04001	—	100
	1/4	04002	—	100
	5/16	04003	—	100
	3/8	04004	—	100
<b># 6</b> - 32 USS Thread 1/16 Key	1/8	04005	—	100
	3/16	04006	—	100
	1/4	04007	—	100
	5/16	04008	—	100
	3/8	04009	—	100
	1/2	04010	—	100
<b># 8</b> - 32 USS Thread 5/64 Key	5/8	04011	—	100
	1/8	04012	—	100
	3/16	04013	—	100
	1/4	04014	—	100
	5/16	04015	—	100
<b># 10</b> - 24 USS - 32 SAE Thread 3/32 Key	3/8	04016	—	100
	1/2	04017	—	100
	5/8	04018	—	100
	3/4	04019	—	100
	3/16	04020	04029	100
	1/4	04021	04030	100
	5/16	04022	04031	100
	3/8	04023	04032	100
1/2	04024	04033	100	
5/8	04025	04034	100	
3/4	04026	04035	100	
7/8	04027	—	100	
1	04028	04036	100	
<b>1/4</b> - 20 USS - 28 SAE Thread 1/8 Key	1/4	04037	04045	100
	5/16	04038	04046	100
	3/8	04039	04047	100
	1/2	04040	04048	100
	5/8	04041	04049	100
	3/4	04042	04050	100
	1	04043	04051	100
	1-1/4	04044	04052	100

Dia	Length	Part #		Qty
		USS	SAE	
<b>5/16</b> - 18 USS - 24 SAE Thread 5/32 Key	5/16	04053	04061	100
	3/8	04054	04062	100
	1/2	04055	04063	100
	5/8	04056	04064	100
	3/4	04057	04065	100
	7/8	04058	—	100
	1	04059	04066	100
1-1/4	04060	04067	100	
<b>3/8</b> - 16 USS - 24 SAE Thread 3/16 Key	3/8	04068	04075	100
	1/2	04069	04076	100
	5/8	04070	04077	100
	3/4	04071	04078	100
	7/8	04072	—	100
	1	04073	04079	100
1-1/4	04074	04080	100	
<b>1/2</b> - 13 USS Thread 1/4 Key	1/2	04081	—	50
	5/8	04082	—	50
	3/4	04083	—	50
	1	04084	—	50
	1-1/4	04085	—	50

# SOCKET SET SCREWS

## CONE POINT & HALF DOG POINT

Alloy Steel - Plain Steel - Black Oil Finish

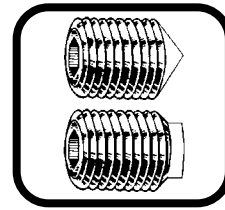

### Cone Point

Dia	Length	Part #		Qty
		USS	SAE	
# 4 - 40 USS Thread	1/8	04100	—	100
	3/16	04101	—	100
# 5 - 40 USS Thread	3/16	04102	—	100
	1/4	04103	—	100
# 6 - 32 USS Thread 1/16 Key	1/8	04104	—	100
	3/16	04105	—	100
	1/4	04106	—	100
	3/8	04107	—	100
# 8 - 32 USS Thread 5/64 Key	3/16	04108	—	100
	1/4	04109	—	100
	5/16	04110	—	100
	3/8	04111	—	100
# 10 - 24 USS Thread - 32 SAE Thread 3/32 Key	1/2	04112	—	100
	3/16	—	04117	100
	1/4	04113	04118	100
	5/16	04114	—	100
	3/8	04115	—	100
	1/2	04116	—	100
1/4 - 20 USS Thread - 28 SAE Thread 1/8 Key	1/4	04119	04126	100
	5/16	04120	—	100
	3/8	04121	04127	100
	1/2	04122	—	100
	5/8	04123	—	100
	3/4	04124	—	100
	1	04125	—	100
5/16 - 18 USS Thread - 24 SAE Thread 5/32 Key	5/16	04128	04134	100
	3/8	04129	04135	100
	1/2	04130	—	100
	5/8	04131	—	100
	3/4	04132	—	100
	1	04133	—	100
3/8 - 16 USS Thread - 24 SAE Thread 3/16 Key	3/8	04136	04141	100
	1/2	04137	04142	100
	5/8	04138	—	100
	3/4	04139	—	100
	1	04140	—	100
1/2 - 13 USS Thread 1/4 Key	1/2	04143	—	50
	5/8	04144	—	50
	3/4	04145	—	50
	1	04146	—	50

### Half Dog Point

Dia	Length	Part #		Qty
		USS	SAE	
# 8 - 32 USS Thread 5/64 Key	3/16	04150	—	100
	1/4	04151	—	100
	5/16	04152	—	100
	3/8	04153	—	100
	1/2	04154	—	100
# 10 - 24 USS Thread - 32 SAE Thread 3/32 Key	3/16	04155	04160	100
	1/4	04156	04161	100
	5/16	04157	—	100
	3/8	04158	—	100
	1/2	04159	—	100
1/4 - 20 USS Thread - 28 SAE Thread 1/8 Key	1/4	04162	04169	100
	5/16	04163	04170	100
	3/8	04164	—	100
	1/2	04165	—	100
	5/8	04166	—	100
	3/4	04167	—	100
	1	04168	—	100
	5/16	04171	—	100
5/16 - 18 USS Thread - 24 SAE Thread 5/32 Key	3/8	04172	04177	100
	1/2	04173	—	100
	5/8	04174	—	100
	3/4	04175	—	100
	1	04176	—	100
	3/8	04178	04184	100
3/8 - 16 USS Thread - 24 SAE Thread 3/16 Key	1/2	04179	04185	100
	5/8	04180	—	100
	3/4	04181	—	100
	1	04182	—	100
	1-1/4	04183	—	100
1/2 - 13 USS Thread 1/4 Key	1/2	04186	—	50
	5/8	04187	—	50
	3/4	04188	—	50
	1	04189	—	50
	1-1/4	04190	—	50
5/8 - 11 USS Thread 5/16 Key	5/8	—	04193	25
	1	04191	—	25
	1-1/4	04192	—	25





# FAS-KIT<sup>®</sup> BOLT & CAP SCREW ASSORTMENTS



Plastic Box Assortments		
Part Number	Description	Number of Pieces
FK02000	Gr 5 USS Hex Head Cap Screws - With Nuts & Washers	306
FK02005	Gr 5 SAE Hex Head Cap Screws - With Nuts & Washers	306
FK02100	Gr 8 USS Hex Head Cap Screws - With Nuts & Washers	306
FK02105	Gr 8 SAE Hex Head Cap Screws - With Nuts & Washers	306
FK03100	Socket Head Cap Screws - Alloy Steel	400
FK03200	Socket Set Screws - Cup Point - Alloy Steel	550

Metal Tray Assortments			
Small Drawer	Large Drawer	Description	Number of Pieces
FK11750	FK51750	Hanger Bolts	120
-	FK52600	Gr 5 USS Hex Head Cap Screws	400
-	FK52610	Gr 5 USS Hex Head Cap Screws - With Nuts	600
-	FK52650	Gr 5 SAE Hex Head Cap Screws	400
-	FK52660	Gr 5 SAE Hex Head Cap Screws - With Nuts	600
-	FK52700	Gr 8 USS Hex Head Cap Screws	400
-	FK52710	Gr 8 USS Hex Head Cap Screws - With Nuts	600
-	FK52750	Gr 8 SAE Hex Head Cap Screws	400
-	FK52760	Gr 8 SAE Hex Head Cap Screws - With Nuts	600
FK12780	FK52780	Carriage Bolts - With Nuts	395
FK12790	FK52790	Hex Head Lag Bolts	310
FK15000	FK55000	Socket Head Cap Screws	750
FK15050	FK55050	Flat Socket Head Cap Screws	770
FK15100	FK55100	Button Socket Head Cap Screws	830
FK15150	FK55150	Socket Set Screws - Cup Point	1405
FK15160	FK55160	Socket Set Screws - Knurl Point	1405
FK15170	FK55170	Socket Set Screws - Cone Point	1380
FK15180	FK55180	Socket Set Screws - Cone Point	705
-	FK59800	Cylinder Head & Manifold Studs	100
-	FK59850	Cylinder Head & Manifold Studs	80



# **FAS-KIT<sup>®</sup> BOLT & CAP SCREW ASSORTMENTS**



<b>40 Hole Bin Assortments</b>		
Part Number	Description	Number of Pieces
FK90000	Gr 5 USS 1/4-20 thru 1/2-13 Hex Head Cap Scr - With Nuts & Washers	2150
FK90010	Gr 5 USS 9/16-12 thru 1"-8 Hex Head Cap Scr - With Nuts & Washers	515
FK90020	Gr 5 SAE 1/4-28 thru 1/2-20 Hex Head Cap Scr - With Nuts & Washers	2150
FK90030	Gr 5 SAE 9/16-18 thru 1"-14 Hex Head Cap Scr - With Nuts & Washers	515
FK90040	Gr 8 USS 1/4-20 thru 1/2-13 Hex Head Cap Scr - With Nuts & Washers	2150
FK90050	Gr 8 USS 9/16-12 thru 1"-8 Hex Head Cap Scr - With Nuts & Washers	515
FK90060	Gr 8 SAE 1/4-28 thru 1/2-20 Hex Head Cap Scr - With Nuts & Washers	2150
FK90070	Gr 8 SAE 9/16-18 thru 1"-14 Hex Head Cap Scr - With Nuts & Washers	515

<b>Miscellaneous Assortments</b>		
Part Number	Description	Number of Pieces
FK90100	18 Drawer Fastener Treasure Chest	2467
FK90150	Zinc Plated Threaded Rods	24
FK90160	B-7 Alloy Steel Threaded Rods	13

# Section 2: Nuts & Washers

## Table of Contents

### Hex Nuts

Finished Hex Nuts, *Grade 8 USS & SAE* ..... 3  
Finished Hex Nuts, *Grade 2 USS & SAE* ..... 3  
Finished Hex Nuts, *Left Hand Thread* ..... 4  
Finished Jam Nuts, *USS & SAE Thread* ..... 4  
Heavy Hex Nuts, *USS Thread* ..... 5  
High Nuts, *SAE Thread* ..... 5  
Rod Coupling Nuts, *USS Thread* ..... 5  
Machine Screw Nuts ..... 6  
Square Nuts, *USS Thread* ..... 6  
Wing Nuts, *USS & SAE Thread* ..... 6  
Acorn Nuts, *USS & SAE Thread* ..... 6

### Lock Nuts

Slotted Hex Nuts, *USS & SAE Thread* ..... 7  
Keps Nuts, *USS & SAE Thread* ..... 7  
Serrated Flange Nuts, *USS & SAE Thread* ..... 8  
Flange Style Frame Nuts, *USS Thread* ..... 8  
Prevailing Torque Nuts, *USS & SAE Thread* ..... 8  
Nylon Insert Nuts, *USS & SAE Thread* ..... 9  
Thin Nylon Insert Nuts, *USS & SAE Thread* ..... 9

### Specialty Nuts

Tee Nuts, *USS & SAE Thread* ..... 10  
Jack Nuts, *USS & SAE Thread* ..... 10

### Threaded Inserts

Klik Poly-Nuts ..... 11  
Kilk Thread-Serts ..... 11  
Kilk Rivet-Nuts ..... 12  
Thread-Sert Kit ..... 12  
Thread-Sert Tools ..... 12

### Flat Washers

Grade 8, *USS & SAE Pattern* ..... 13  
Grade 2, *USS & SAE Pattern* ..... 13  
Machine Screw Sizes ..... 13  
Fender, *Zinc Plated* ..... 14  
Finishing, *Nickel Plated* ..... 14  
Bellville, *Phosphate & Oil* ..... 15  
Brass ..... 15  
Copper ..... 15  
Nylon ..... 16  
Bonded Neoprene Sealing Washers ..... 17

### Spacing Washers

Malleable Bevel Washers ..... 17  
Fender Shims ..... 18-19

### Lock Washers

Split, *Grade 8 Yellow Zinc Plated* ..... 20  
Split, *Grade 2 Zinc Plated* ..... 20  
Split, *Machine Screw Sizes Zinc Plated* ..... 20  
High Collar Split, *Alloy Steel Plain* ..... 20  
Internal Tooth Star, *Zinc Plated* ..... 21  
External Tooth Star, *Zinc Plated* ..... 21  
Countersunk Tooth Star, *Zinc Plated* ..... 21  
Vibration Proof Disc Type, *Zinc Yellow Plated* ..... 22  
X-Washers, *Zinc Plated* ..... 22

Faskit Assortments ..... 23-24



# FINISHED HEX NUTS

## GRADE 8 ALLOY STEEL FOR USE WITH GRADE 8 CAP SCREWS

Plating: Zinc Yello Chromate



- » Engineered specifically to match high torque requirements of alloy high tensile strength cap screws.
- » Manufactured on automatic nut forgers.
- » Cold formed for more dense grain structure.
- » Special high carbon steel.
- » Double heat treated.

Size	Part #		Qty
	USS	SAE	
1/4	07684	07672	100
5/16	07685	07673	100
3/8	07686	07674	100
7/16	07687	07675	100
1/2	07688	07676	100
9/16	07689	07677	50
5/8	07690	07678	50
3/4	07691	07679	50
7/8	07692	07680	50
1	07693	07681	25
1-1/8	07694	07682	25
1-1/4	07695	07683	25
1-3/8	07695A	07683A	10
1-1/2	07695B	07683B	10

# FINISHED HEX NUTS

## FOR USE WITH GRADE 5 CAP SCREWS

PLATING: ZINC



- » Engineered specifically to match high torque requirements of grade 5 tensile strength cap screws.
- » Manufactured on automatic nut forgers.
- » Cold formed for more dense grain structure.
- » Special high carbon steel.
- » Double heat treated.

Size	Part #		Qty
	USS	SAE	
1/4	00313	00306	100
5/16	00314	00307	100
3/8	00315	00308	100
7/16	00316	00309	100
1/2	00317	00310	100
9/16	00318	00311	50
5/8	00319	00312	50
3/4	00319A	00312A	50
7/8	00319B	00312B	50
1	00319C	00312C	10
1-1/8	00319D	00312D	5
1-1/4	00319E	00312E	5
1-3/8	00319G	00312G	5
1-1/2	00319F	00312F	5

# LEFT HAND HEX NUTS

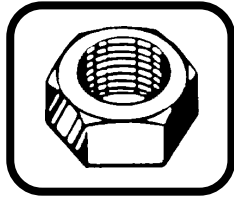

- » Made of C1006-C1015 steel.
- » Minimum Rockwell hardness: B49.
- » Minimum tensile strength: 44,225 psi.

Size	Part #		Qty
	USS	SAE	
1/4	03710	03725	50
5/16	03711	03726	50
3/8	03712	03727	50
7/16	03713	03728	25
1/2	03714	03729	25
9/16	03715	03730	25
5/8	03716	03731	25
3/4	03717	03732	25
7/8	03718	03733	10
1	03719	03734	10

# JAM FINISHED HEX NUTS

Plating: Zinc



- » Manufactured from approved nut steel.
- » Finished washer face chamfered.
- » Class 2B thread fit before plating.

Size	Part #		Qty
	USS	SAE	
1/4	06453	06463	100
5/16	06454	06464	100
3/8	06472	06480	100
7/16	06473	06481	100
1/2	06474	06482	100
9/16	06475	06483	50
5/8	06476	06484	50
3/4	06477	06485	50
7/8	06478	06486	25
1	06479	06487	25

# HEAVY HEX NUTS

## SEMI-FINISHED

Plating: Zinc



- » Heavy duty and engineered especially to match high torque requirements.
- » Double heat treated.
- » Class 2B thread fit.

Size	Part #	Qty
1/4-20	00524	25
3/8-16	00525	25
1/2-13	00526	25
5/8-11	00527	25
3/4-10	00528	25
7/8-9	00529	25
1-8	00530	10
1-1/8-7	00531	10
1-1/4-7	00532	10
1-1/2-6	00533	5

# HIGH HEX NUTS

## SAE FINE THREAD

Plating: Zinc

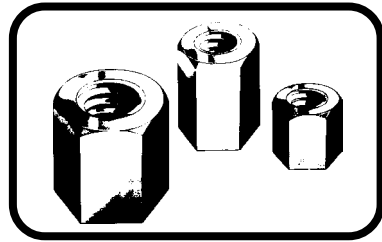

Size	Height	Part #	Qty
3/8-24	17/32	01483	100
7/16-20	39/64	01098	100
1/2-20	11/16	01099	50
9/16-18	49/64	01100	50
5/8-18	27/32	01101	25
3/4-16	13/16	01102	25
7/8-14	1-5/32	01504	25
1-14	15/16	01505	25

# ROD COUPLING NUTS

## COARSE THREAD ONLY

Plating: Zinc

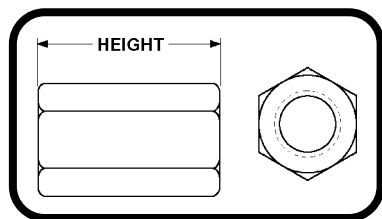

Size	Height	Part #	Qty
3/16-24	3/4	14931	50
1/4-20	7/8	14932	50
5/16-18	1-1/8	14933	50
3/8-16	1-3/4	14934	50
7/16-14	1-3/4	14935	25
1/2-13	1-3/4	14936	25
5/8-11	2-1/8	14937	10
3/4-10	2-1/4	14938	10
7/8-9	2-1/2	14939	5
1-8	2-3/4	14940	5

# MACHINE SCREW HEX NUTS

Plating: Zinc

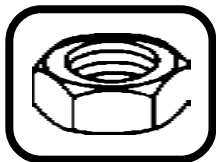

- » Exacting quality control.
- » Counterbored for easy starting.
- » Chamfered.
- » Precision finished threads.

Size	Part #	Qty
2-56	00658	100
3-48	00659	100
4-40	00660	100
5-40	00661	100
6-32	00662	100
8-32	00663	100
10-32	00664	100
10-24	00665	100
12-28	00667	100
12-24	00666	100
1/4-20	00670	100
5/16-18	00671	100
3/8-16	00672	100

# REGULAR SQUARE NUTS

Plating: Zinc

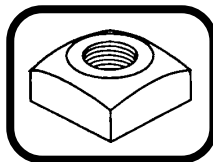

Size	Part #	Qty
10-24	03565	100
1/4-20	03566	100
5/16-18	03567	100
3/8-16	03568	100
7/16-14	03569	100
1/2-13	03570	100
5/8-11	03571	50
3/4-10	03572	25
7/8-9	03573	10
1-8	03574	5

# STEEL WING NUTS

Plating: Zinc

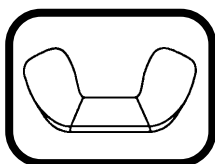

- » Cold Forged.
- » Solid type.
- » Class 2B thread fit before plating.

Size	Part #		Qty
	USS	SAE	
#6	02280		100
#8	02281		100
#10	02283	02282	100
1/4	02326	02341	100
5/16	03561	06522	100
3/8	03250	06523	100
7/16	08825	09154	25
1/2	33283		25
5/8	33284		20
3/4	33285		20

# CAP (ACORN) NUTS

Plating: Nickel

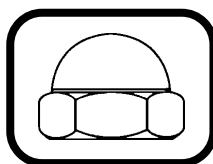

Size	Part #	Qty
6-32	39734	100
8-32	39735	100
10-24	39162	100
10-32	39163	100
12-24	39164	100
1/4-20	39165	100
5/16-18	39167	50
3/8-16	39169	50
1/2-13	39173	25



# SLOTTED FINISHED HEX NUTS

Plating: Zinc

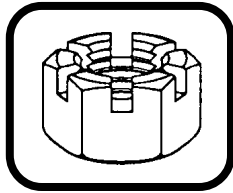

- » Manufactured from approved nut steel.
- » Finished washer face.
- » Exact slot dimensions
- » Class 2B thread fit before plating.

Size	Part #		Qty
	USS	SAE	
1/4	35675	00300	100
5/16	35676	00301	100
3/8	35677	00302	100
7/16	35678	00303	100
1/2	35668	00304	100
9/16	35679	00305	50
5/8	35669	01460	50
3/4	35670	01461	50
7/8	35671	01462	25
1	35672	01463	25
1-1/8	35673	06470	25
1-1/4	35674	06471	25
1-1/2	35681	06502	5

# “KEPS” NUTS

Plating: Zinc

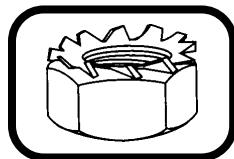

- » Manufactured from approved nut steel.
- » Washer-spring steel.
- » Free spinning washer.
- » Chamfered.
- » Positive self-locking.
- » Reusable.

Size	Part #		Qty
	USS	SAE	
#4	01357	—	100
#5	01358	—	100
#6	01359	—	100
#8	01360	—	100
#10	01361	01362	100
#12	01369	—	100
1/4	01363	01364	100
5/16	01365	01366	100
3/8	01367	01368	100

## SERRATED FLANGE LOCK NUTS HARDENED STEEL

Plating: Zinc

- » The serrated flange on these nuts grip better and hold longer.
- » Because the flange distributes the load over a greater area, nuts require more torque to remove than to install.
- » The flange also covers oversized holes.
- » Nuts are reusable.

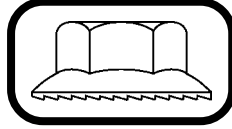

Size	Part #		Qty
	USS	SAE	
#6	03580		100
#8	03581		100
#10	03582	03594	100
1/4	03583	03595	100
5/16	03584	03596	100
3/8	03585	03597	100
7/16	03586	03598	50
1/2	03587	03599	50
5/8	03588		25
3/4	03589		25

## FLANGE STYLE STOVER LOCK NUT FOR USE WITH GRADE 8 FRAME BOLTS

Black Phosphate & Oiled

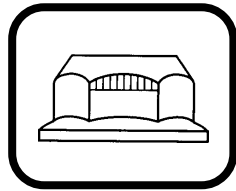

Size	Part #	Qty
3/8-16	37NOR	50
7/16-14	43NOR	25
1/2-13	50NOR	25
5/8-11	62NOR	25
3/4-10	75NOR	10

## PREVAILING TORQUE LOCKNUTS ONE PIECE - GRADE C

Plating: Zinc & Waxed

- » Top of nut is compressed to form an oval-shaped locking zone.
- » Provides a 360° locking zone.
- » Nuts twist freely on a bolt or stud until they make contact with the locking zone.
- » Use ASTM A563 Grade C nuts with Grade 8 bolts for high-strength applications.
- » Nuts are reusable.

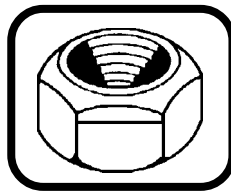

Size	Part #		Qty
	USS	SAE	
1/4	14233	14225	100
5/16	14234	14226	100
3/8	14235	14227	100
7/16	14236	14228	100
1/2	14237	14229	100
9/16	14238	14230	50
5/8	14239	14231	25
3/4	14240	14232	25
7/8	39494	39492	10
1	39495	39493	10
1-1/8	39496	39505	5
1-1/4	39497	39506	5
1-3/8	39498	—	5
1-1/2	39499	—	5

# NYLON INSERT STOP NUTS

## REGULAR HEIGHT

Plating: Zinc

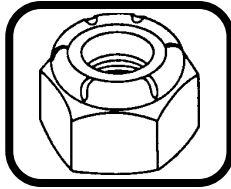

- » Manufactured from approved nut steel.
- » Nylon Compression locking action.
- » Rustproof positive locking action.
- » Vibration-proof.
- » Can be reused.

Size	Part #		Qty
	USS	SAE	
#2	06496	—	100
#4	06492	—	100
#5	06493	—	100
#6	06494	—	100
#8	06495	—	100
#10	06488	06489	100
1/4	01889	01879	100
5/16	01890	01880	100
3/8	01891	01881	100
7/16	01892	01882	50
1/2	01893	01883	50
9/16	01894	01884	50
5/8	01895	01885	25
3/4	01896	01886	25
7/8	01897	01887	25
1	01898	01888	25
1 1/8	06505	—	5
1 1/4	06506	06512	5
1 3/8	06507	—	5
1 1/2	06508	06514	5

# NYLON INSERT STOP NUTS

## THIN HEIGHT

Plating: Zinc

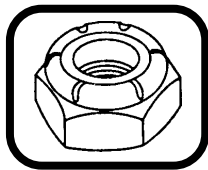

- » Manufactured from approved nut steel.
- » Nylon Compression locking action.
- » Rustproof positive locking action.
- » Vibration-proof.
- » Can be reused.
- » Class 2B thread before plating.

Size	Part #		Qty
	USS	SAE	
1/4	09134	09144	50
5/16	09135	09145	50
3/8	09136	09146	50
7/16	09137	09147	50
1/2	09138	09148	50
9/16	09139	09149	25
5/8	09140	09150	25
3/4	09141	09151	25
7/8	09142	09152	10
1	09143	09153	10

## TEE NUTS

### GENERAL PURPOSE

Plating: Zinc

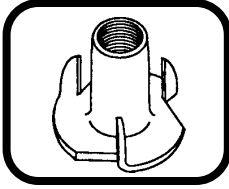

» Tee nut screw anchors items to soft material such as wood, fiber board, etc.

Size	Part #	Qty
8-32	04873	50
10-32	04874	50
10-24	04875	50
1/4-20	04876	50
5/16-18	04877	50
3/8-16	04878	25

## JACK NUTS

### SCREW ANCHOR

Plating: Zinc

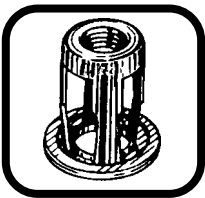

» Grips any material up to 3/8" thick.  
 » Holds securely in expansion space as small as 3/8".

Thread	Body Dia	Overall Length	Part #	Qty
6-32	.318	.653	A13012	25
6-32	.318	.841	A13013	25
10-24	.382	.716	A13014	25
10-24	.382	.888	A13015	25
1/4"-20	.438	.731	A13016	25
1/4"-20	.438	.919	A13017	25
1/4"-20	.438	1.094	A17585	15

# KLİK POLY-NUTS

## STANDARD & METRIC SIZES

Available in Aluminum or Zinc Plated Steel

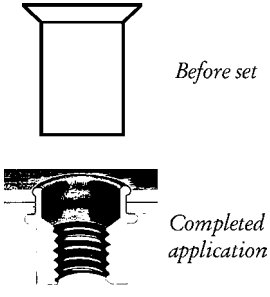

Thread	Part #		Grip Range	Drill Size	Qty
	Aluminum	Steel			
6-32	A13476	A11310	.020"-.080"	1/4"	50
8-32	A13478	A11311	.020"-.080"	1/4"	50
10-24	A13480	A11312	.020"-.130"	9/32"	50
10-32	A13482	A12978	.020"-.130"	9/32"	50
1/4"-20	A13484	A11313	.030"-.165"	3/8"	25
5/16"-18	—	A11314	.040"-.200"	1/2"	25
3/8"-16	—	A16785	.040"-.200"	1/2"	15
4mm-.7	—	A12980	.020"-.080"	1/4"	50
5mm-.8	A13492	A12982	.020"-.130"	9/32"	50
6mm-1.0	A13494	A12984	.030"-.165"	3/8"	25
8mm-1.25	—	A12986	.040"-.200"	1/2"	25

- » Klik Poly-Nuts are designed to provide a very efficient and cost-effective method of placing permanent threads in thin materials.
- » Installed from one side, Klik Poly-Nuts are perfect for use in metal, fiberglass and rigid plastic previously too thin for tapped threads.
- » Klik Poly-Nuts provide a nearly flush appearance and once in place, the internal threads are ready for a screw or bolt.
- » After installation, Klik Poly-Nuts provide permanent, captive threads that do not allow loosening under vibration and will not rotate when attached to the mating material.

# KLİK THREAD-SERTS

Plating: Zinc

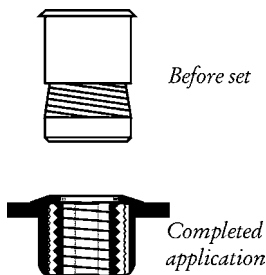

Thread	Part #	Hole Size	Drill Size	Qty
6-32	A10264	.221	# 2	25
8-32	A10267	.250	1/4"	25
10-24	A10270	.281	9/32"	25
10-32	A10273	.281	9/32"	25
1/4"-20	A10276	.391	25/64"	25
5/16"-18	A10282	.500	1/2"	10
3/8"-16	A10288	.562	9/16"	10

- » Use Klik Thread-Serts in any thickness of metal or rigid material of at least 3/32" (.0937).
- » Klik Thread-Serts' two piece design consists of an upper sleeve and a base which has internal threads.
- » During installation the base is drawn upwards inside the upper sleeve forcing a 360° contact between the sleeve and application material.
- » Because of its unique setting ability, Klik Thread-Serts can be used in almost any thickness of material.

# KLIK RIVET-NUTS

Available in Aluminum or Zinc Plated Steel

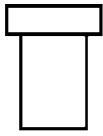
*Before set*

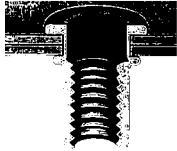

*Completed application*

Thread	Part #		Grip Range	Drill Size	Qty
	Aluminum	Steel			
8-32	A16177	A16187	.010"-.075"	#2	50
10-24	A16178	A16188	.010"-.080"	1/4"	50
10-24	A16179	A16189	.080"-.130"	1/4"	50
10-32	A16180	A16190	.010"-.080"	1/4"	25
10-32	A16181	A16191	.080"-.130"	1/4"	25
1/4"-20	A16182	A16192	.020"-.080"	Q	25
1/4"-20	A16183	A19193	.080"-.140"	Q	25
5/16"-18	A16184	A16194	.030"-.125"	Z	25
5/16"-18	—	A16195	.125"-.200"	Z	25
3/8"-16	A16789	A16787	.030"-.115"	12.5mm	10
3/8"-16	A16790	A16788	.115"-.200"	12.5mm	10

- » After installation, Klik Rivet-Nuts provide permanent, captive threads that do not allow loosening under vibration and will not rotate when attached to the mating material.
- » Klik Rivet-Nuts with large diameter heads can be used in soft materials which inherently offer little, if any, thread strength.
- » The flathead design provides the most bearing surface for higher torque applications.
- » The larger flange extends above the material in which it is installed and provides a built-in spacer.

## MARSON STEEL THREAD-SERT KIT

Part # FK91050



Kit consists of:

- Thread-Setter tool
- Mandrels; 6-32, 8-32, 10-24, 10-32, 1/4-20, 5/16-18, 3/8-16
- Nosepieces for each mandrel
- 10 pcs. each; 6-32, 8-32, 10-24, 10-32, 1/4-20 threadserts
- 6 pcs. each; 5/16-18, 3/8-16 threadserts
- Handy storage box



## MARSON THREAD-SETTER™ TOOL

Part # 39200



This quality threaded insert installation tool features patented bearing design, comfortable hand grips and a locking chain. The 39200 installs all sizes of Klik Poly-Nuts and Klik Rivet-Nuts up to 1/4-20 and 6mm threads in steel as well as Klik Thread-Serts up to 3/8-16. Tool comes with mandrels and nosepieces to set 8-32, 10-24 and 10-32 inserts.

### REPLACEMENT MANDRELS

Size	Part #
6-32	39254
8-32	39255
10-24	39256
10-32	39257
1/4-20	39258
5/16-18	39259
3/8-16	39260

Size	Part #
4mm	39266
5mm	39267
6mm	39268
8mm	39269

# ALLOY STEEL FLAT WASHERS

FOR USE WITH GRADE 8 CAP SCREWS & NUTS

Plating: Zinc Yellow Chromate

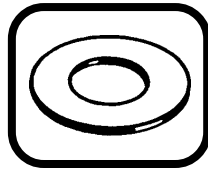

- » Made in the U.S.A.
- » 1035 steel.
- » R/C38-45 hardness.

Size	Part #		Qty
	USS	SAE	
1/4	35468	39671	100
5/16	35469	39672	100
3/8	35470	39673	100
7/16	35471	39674	100
1/2	35472	39675	100
9/16	35473	39676	50
5/8	35474	39677	50
3/4	35475	39678	50
7/8	35476	39679	25
1	35477	39680	25
1-1/8	35478	39681	25
1-1/4	35479	39681A	25
1-1/2	35480	39681B	25

# MACHINE SCREW FLAT WASHERS

Plating: Zinc

Size	Part #	Qty
2	00270	100
3	00271	100
4	00272	100
5	00273	100
6	00274	100
8	00275	100
10	00276	100
12	00277	100

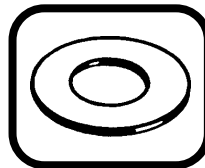

# FLAT WASHERS

FOR USE WITH GRADE 5  
CAP SCREWS & NUTS

Plating: Zinc

Size	Part #		Qty
	USS	SAE	
3/16	00366	00358	100
1/4	00367	00359	100
5/16	00368	00360	100
3/8	00369	00361	100
7/16	00370	00362	100
1/2	00371	00363	100
9/16	00372	00364	100
5/8	00373	00365	100
3/4	00373A	00365A	50
7/8	00373B	00365B	50
1	00373C	00365C	25
1-1/8	00373D	00365D	25
1-1/4	00373E	00365E	25
1-1/2	00373F	00365F	25

## FENDER WASHERS

Plating: Zinc

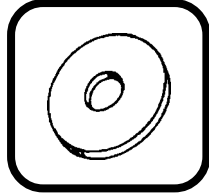

- » Also known as plaster washers.
- » Washers have an extra-wide bearing surface to eliminate the need for patching holes.
- » C1006-C1015 steel.
- » Rockwell hardness of B49.
- » Thickness tolerance is  $\pm 0.04$ .

I.D.	O.D.	Part #	Qty
<b>3/16</b>	3/4	00480	100
	1	00481	100
	1-1/4	00482	100
<b>1/4</b>	1	00483	100
	1-1/4	00484	100
	1-1/2	00485	100
	2	00486	100
<b>5/16</b>	1	00487	100
	1-1/4	00488	100
	1-1/2	00489	100
	2	00490	100
<b>3/8</b>	1-1/4	00491	100
	1-1/2	00492	100
	2	00494	100
<b>1/2</b>	1-1/2	00495	100
	2	00496	100

## FINISHING WASHERS

### COUNTERSUNK TYPE

Plating: Nickel

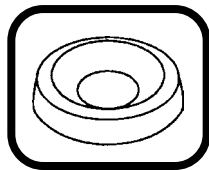

- » Countersunk washers provide a finished appearance.
- » Use with standard 82° flat- and oval-head countersunk screws.
- » Nickel-plated steel is made of C1006-C1022.

Size	Part #	Qty
# 4	00715	100
# 6	00710	100
# 8	00711	100
# 10	00712	100
# 12	00713	100
1/4	00716	100



# BELLVILLE WASHERS

Phosphate & Oil

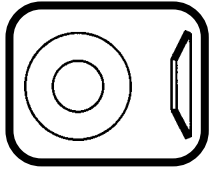

- » Also called conical washers.
- » Washers hold tight in situations where heat or vibration might loosen standard washers.
- » Made of C1075 spring steel
- » Rockwell hardness is C40.

Bolt Size	I.D.	O.D.	Thickness	Part #	Qty
1/4-6mm	.255	.500	.022	A14847	50
1/4-6mm	.255	.500	.038	A14848	50
5/16-8mm	.317	.625	.022	A14849	50
5/16-8mm	.317	.625	.047	A14850	50
3/8-10mm	.380	.750	.034	A14851	25
3/8-10mm	.380	.750	.056	A14852	25
7/16-11mm	.441	.886	.045	A14853	25
1/2-12mm	.505	1.00	.050	A14854	25

# BRASS FLAT WASHERS

Solid Brass

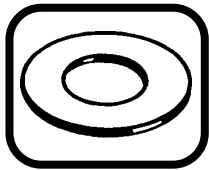

Screw Size	I.D.	O.D.	Thickness	Part #	Qty
1/8	.145	3/8	.032	11968	100
5/32	.172	7/16	.036	11969	100
3/16	.200	1/2	.040	11970	100
1/4	.260	11/16	.051	11972	100
5/16	.336	7/8	.064	39773	25
3/8	.395	1	.081	39774	25
1/2	9/16	1-1/4	.091	39775	25
5/8	11/16	1-1/2	.102	39776	25
3/4	13/16	1-7/8	.114	39777	25

# COPPER FLAT WASHERS

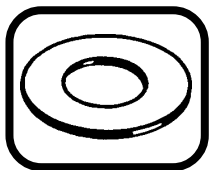

Bolt Size	I.D.	O.D.	Thickness	Part #	Qty
3/16	1/4	7/16	1/32	A15911	50
3/16	1/4	5/8	1/16	A15914	25
1/4	5/16	1/2	1/32	A15912	50
1/4	5/16	11/16	1/16	A15915	25
5/16	3/8	9/16	1/32	A15913	50
5/16	3/8	3/4	1/16	A15916	25
3/8	7/16	13/16	1/16	A15917	25
7/16	1/2	7/8	1/16	A15918	25
1/2	9/16	13/16	3/32	A15919	25

# NYLON FLAT WASHERS

Natural Nylon

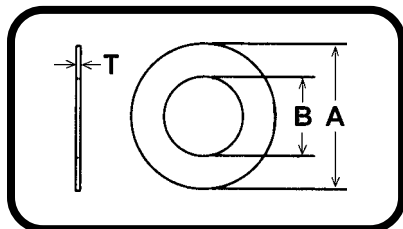

- » Tolerances: O.D. +/- .015.
- » Tolerances: I.D. +/- .015
- » Thickness: +/- .010.

Bolt Size	"B" I.D.	"A" O.D.	"T" Thickness	Part #	Qty
1/16	.115	.250	.032	A13888	100
1/16	.115	.250	.062	A13889	100
1/16	.140	.312	.032	A13890	100
1/16	.140	.312	.062	A13891	100
1/8	.171	.375	.032	A13892	100
1/8	.171	.375	.062	A13893	100
1/8	.194	.375	.032	A13894	100
1/8	.194	.375	.062	A13895	100
3/16	.242	.375	.062	A13896	100
1/8	.200	.437	.062	A13897	100
3/16	.257	.500	.062	A13898	100
1/4	.281	.500	.032	A13899	100
1/4	.317	.500	.062	A13900	100
3/16	.260	.562	.062	A13902	100
1/8	.187	.625	.062	A13903	50
5/16	.380	.625	.062	A13904	50
3/16	.260	.687	.060	A13905	50
3/8	.421	.687	.062	A13906	50
1/2	.568	.750	.062	A13907	50
1/4	.317	.750	.062	A13908	50
5/16	.390	.750	.062	A13909	50
3/8	.443	.750	.062	A13910	50
7/16	.505	.750	.062	A13911	50
3/16	.257	.825	.062	A13912	50
5/16	.343	.875	.062	A13913	50
3/8	.406	1.000	.062	A13914	25
7/16	.516	1.250	.062	A13916	25
5/16	.390	1.260	.062	A13918	25
7/16	.500	1.375	.062	A13919	25
7/16	.525	1.375	.125	A13920	25
5/8	.665	1.500	.094	A13921	25

# SEALING WASHERS

## BONDED NEOPRENE

Galvanized

Used on metal roofs and siding where the expansion and contraction of metal require a permanent resilient seal.



Size	O.D.	Part #	Qty
# 8-10	1/2	03880	100
# 12	5/8	03881	100
# 14	5/8	03882	100

# MALLEABLE BEVEL WASHERS

## STANDARD PATTERN - SLOPE 2" IN 12" OR 9° 28'

Plating: Zinc

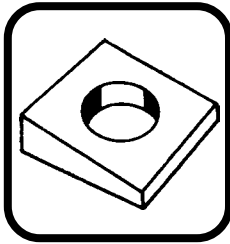

Bolt Size Across Inches	Diameter Size, Heavy Washer	Hole Light Inches	Thickness End	Thickness End	Part #	Qty
1/4	11/16 x 11/16	5/16	7/32	5/64	00450	100
5/16	1 x 1	3/8	1/4	3/32	00451	100
3/8	1-1/4 x 1-1/4	7/16	11/32	5/32	00452	50
1/2	1-1/4 x 1-1/4	9/16	11/32	5/32	00453	50
5/8	1-1/2 x 1-1/2	11/16	13/32	5/32	00454	25
3/4	1-1/2 x 1-1/2	13/16	15/32	7/32	00455	25
7/8	2 x 2	15/16	9/16	7/32	00456	15
1	2 x 2	1-1/16	9/16	7/32	00457	10

# SHIMS

Steel Zinc



1-1/4 x 1-1/8  
with 3/8" Slot

**A3155**  
1/16" Thick  
Qty: 100

**A3156**  
1/8" Thick  
Qty: 100

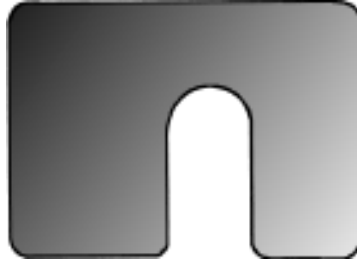

1-3/4 x 1-1/4  
with 1/2" Slot

**A2452**  
1/16" Thick  
Qty: 50

**A2453**  
1/8" Thick  
Qty: 50

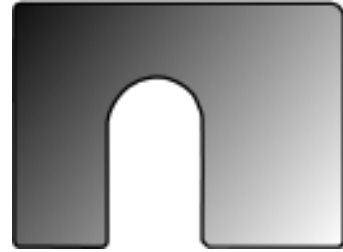

1-3/4 x 1-1/4  
with 1/2" Slot

**A8445**  
1/8" Thick (10 Gauge Steel)  
Qty: 50



2 x 1-1/2  
with 3/4" Slot

**A3000**  
1/8" Thick  
Qty: 50

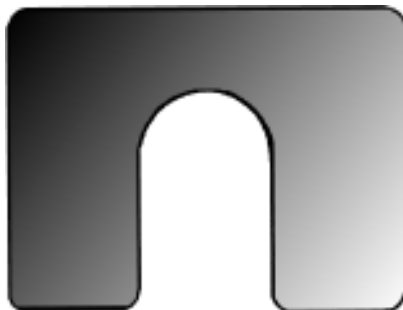

2 x 1-1/2  
with 5/8" Slot

**A2999**  
1/8" Thick  
Qty: 50



**Universal Alignment Shims**  
1-3/16 x 1-15/32  
with 5/8" Slot

**A11186**  
1/64" Thick  
Qty: 25

**A11187**  
1/32" Thick  
Qty: 25

**A11188**  
1/16" Thick  
Qty: 25

**A11189**  
1/8" Thick  
Qty: 25

# CASTER AND CHAMBER SHIMS

Steel Zinc



**Caster and Camber and ball joints for Ford**  
1-1/8 x 1-1/8  
with 1/2" Slot

- |  |  |  |                                       |
|--|--|--|---------------------------------------|
| <b>A5074</b><br>1/64" Thick<br>Qty: 50 | <b>A5075</b><br>1/32" Thick<br>Qty: 50 | <b>A5076</b><br>1/16" Thick<br>Qty: 50 | <b>A5077</b><br>1/8" Thick<br>Qty: 50 |
|--|--|--|---------------------------------------|



**Caster and Camber Shims**  
15/16 x 1-3/8  
with 7/16" Bolt Opening

- |  |  |                                       |
|--|--|---------------------------------------|
| <b>A5089</b><br>1/32" Thick<br>Qty: 50 | <b>A5090</b><br>1/16" Thick<br>Qty: 50 | <b>A5091</b><br>1/8" Thick<br>Qty: 50 |
|--|--|---------------------------------------|



**Caster and Camber Shims for GM**  
1 x 1-11/16  
with 37/64" Bolt Opening

- |  |  |                                       |
|--|--|---------------------------------------|
| <b>A5093</b><br>1/32" Thick<br>Qty: 50 | <b>A5094</b><br>1/16" Thick<br>Qty: 50 | <b>A5095</b><br>1/8" Thick<br>Qty: 50 |
|--|--|---------------------------------------|



**Caster and camber Shims for Chevrolet and GMC Trucks**  
1-1/2 x 2-1/2  
with 9/16" Slot

- |  |  |                                       |
|--|--|---------------------------------------|
| <b>A5096</b><br>1/32" Thick<br>Qty: 50 | <b>A5097</b><br>1/16" Thick<br>Qty: 50 | <b>A5098</b><br>1/8" Thick<br>Qty: 50 |
|--|--|---------------------------------------|



**A5099**  
3/16" Thick  
Qty: 50

**Caster and camber Shims for GMC Trucks**  
1-1/4 x 2  
with 17/32" Slot

## ALLOY STEEL LOCK WASHERS

FOR USE WITH GRADE 8  
CAP SCREWS & NUTS

Plating: Zinc Yellow Chromate

Size	Part #	Qty
1/4	00250	100
5/16	00251	100
3/8	00252	100
7/16	00253	100
1/2	00254	100
9/16	00255	100
5/8	00256	100
3/4	00257	50
7/8	00258	50
1	00259	50
1-1/8	00260	25
1-1/4	00261	25
1-1/2	00262	25

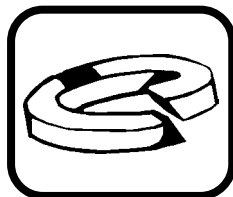

## LOCK WASHERS

FOR USE WITH GRADE 5  
CAP SCREWS & NUTS

Plating: Zinc

Size	Part #	Qty
1/4	00377	100
5/16	00378	100
3/8	00379	100
7/16	00380	100
1/2	00381	100
9/16	00382	100
5/8	00383	100
3/4	00384	100
7/8	00384A	50
1	00384B	50
1-1/8	00384C	25
1-1/4	00384D	25
1-1/2	00384E	25

## MACHINE SCREW LOCK WASHERS

Plating: Zinc

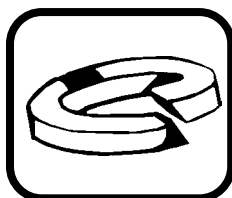

Size	Part #	Qty
#2	00280	100
#3	00281	100
#4	00282	100
#5	00283	100
#6	00284	100
#8	00285	100
#10	00286	100
#12	00287	100

## HIGH COLLAR LOCK WASHERS

MADE IN USA  
Alloy Steel Black Finish

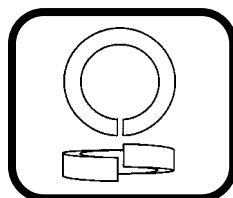

» Small O.D. for use with socket head cap screws.

Size	Part #	Qty
#4	00950	100
#6	00952	100
#8	00953	100
#10	00954	100
1/4	00955	100
5/16	00956	100
3/8	00957	100
7/16	00958	100
1/2	00959	50
5/8	00960	50
3/4	00961	50
7/8	00962	25
1	00963	25
1-1/4	00964	10
1-1/2	00965	10

# STAR LOCK WASHERS

## INTERNAL TOOTH

Plating: Zinc

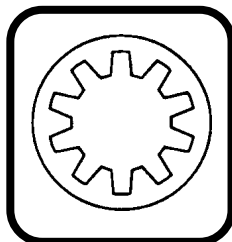

Size	Part #	Qty
#6	00702	100
#8	00703	100
#10	00704	100
#12	00705	100
1/4	00706	100
5/16	00707	100
3/8	00708	100
7/16	00709	100
1/2	00733	100
9/16	00734	100
5/8	00735	100

# STAR LOCK WASHERS

## EXTERNAL TOOTH

Plating: Zinc

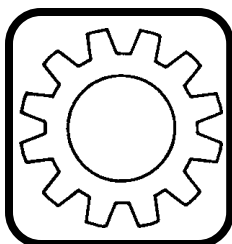

Size	Part #	Qty
#6	00694	100
#8	00695	100
#10	00696	100
#12	00697	100
1/4	00698	100
5/16	00699	100
3/8	00700	100
7/16	00701	100
1/2	00730	100
9/16	00731	100
5/8	00732	100

# STAR LOCK WASHERS

## COUNTERSUNK - EXTERNAL TOOTH

Plating: Zinc

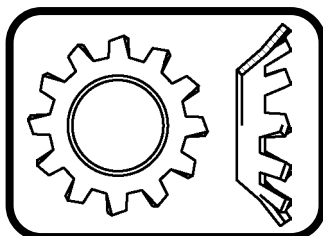

Size	Part #	Qty
#6	01061	100
#8	01062	100
#10	01063	100
1/4	01065	100

# DISK LOCK WASHERS

## VIBRATION PROOF LOCK WASHERS

FOR USE WITH GRADE 5 & GRADE 8 BOLTS

Zinc & Yellow Chromate Plated

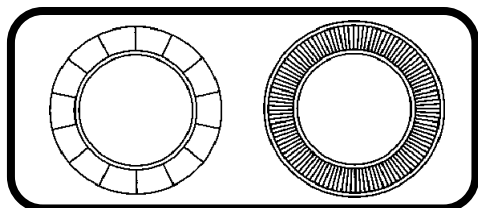

These washers have cams or wedges on one side, with a lead angle greater than a thread angle, and radial teeth or ribs on the other side. The washers are installed cam face to cam face. When tightening the fastener to preload, the teeth penetrate and seat against the joint material and the nut and/or fastener head. When subjected to vibration the interacting cams create a wedge action which prevents the fastener from vibrating loose.

Bolt Size	O.D.	Part #	Qty
3/16" (5mm)	11/32"	A19282	50 (25 pr)
1/4" (6mm)	27/64"	A19283	50 (25 pr)
5/16" (8mm)	17/32"	A19284	50 (25 pr)
3/8" (10mm)	21/32"	A19285	50 (25 pr)
7/16" (11mm)	23/32"	A19286	30 (15 pr)
1/2" (12mm)	49/64"	A19287	20 (10 pr)
9/16" (14mm)	29/32"	A19288	20 (10 pr)
5/8" (16mm)	1"	A19289	20 (10 pr)
3/4" (19mm)	1-7/32"	A19290	10 (5 pr)
1" (25mm)	1-17/32"	A19291	10 (5 pr)

» Carbon Steel.

» Through Hardened: Min. 44HRC, Max. 51 HRC.

# X-WASHERS

## SPLIT RETAINING RINGS

Plating: Zinc

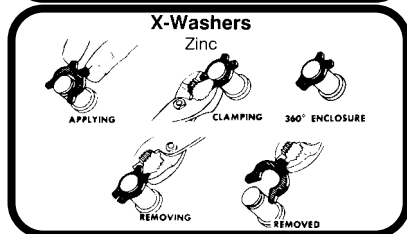
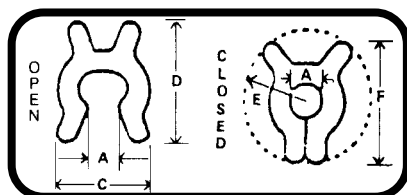

"A"	"C"	"D"	"E"	"F"	Thickness	Part #	Qty
.086	.320	.406	.210	.406	.025	A13691	50
.098	.364	.490	.297	.475	.055	A13692	50
.130	.364	.490	.297	.475	.055	A13693	50
.164	.523	.687	.422	.665	.065	A13694	50
.190	.593	.745	.437	.730	.065	A13695	25
.222	.622	.776	.469	.775	.075	A13696	25
.256	.698	.905	.500	.890	.075	A13697	25
.285	.822	.986	.563	.984	.075	A13698	25
.317	.872	1.100	.609	1.078	.089	A13699	25
.381	1.060	1.297	.797	1.281	.089	A13701	10





# FAS-KIT<sup>®</sup> NUT & WASHER ASSORTMENTS



Plastic Box Assortments		
Part Number	Description	Number of Pieces
FK01700	Fender Washers - Zinc Plated	150
FK01750	Countersunk Finishing Washers - Nickel Plated & Brass	300
FK01800	Copper Washers - Standard & Metric	120
FK02300	All Steel Prevailing Torque Lock Nuts	160

Metal Tray Assortments			
Small Drawer	Large Drawer	Description	Number of Pieces
FK11850	FK51850	SAE Flat Washers & Split Lock Washers - Zinc Plated	860
FK11870	FK51870	SAE Flat Washers & Split Lock Washers - Grade 8	860
FK11890	FK51890	USS Flat Washers & Split Lock Washers - Zinc Plated	860
FK11900	FK51900	USS Flat Washers & Split Lock Washers - Grade 8	860
FK11950	FK51950	SAE Flat Washers - Zinc Plated	1350
FK12000	FK52000	USS Flat Washers - Zinc Plated	750
FK12050	FK52050	SAE Flat Washers - Grade 8	460
FK12100	FK52100	USS Flat Washers - Grade 8	460
FK12150	FK52150	Fender Washers - Zinc Plated	475
FK12160	FK52160	Fender Washers - Zinc Plated	525
FK12200	FK52200	Split Lock Washers - Zinc Plated	1350
FK12250	FK52250	Split Lock Washers - Grade 8	625
FK12300	FK52300	Star Lock Washers - Internal & External Zinc Plated	1700
FK12350	FK52350	Star Lock Washers - External Zinc Plated	1150
FK12400	FK52400	Star Lock Washers - Internal Zinc Plated	1150
FK12450	FK52450	Washers - Flat, Split Lock, Internal & External Star	2400
FK12800	FK52800	Nuts, Flat & Lock Washers - USS & SAE Zinc Plated	1200
FK12810	FK52810	Nuts, Flat & Lock Washers - USS Zinc Plated	900
FK12850	FK52850	Nuts, Flat & Lock Washers - USS & SAE Grade 8	1200
FK12860	FK52860	Nuts, Flat & Lock Washers - USS Grade 8	900
FK12900	FK52900	Machine Screw Nuts - Zinc Plated	1400
FK12920	FK52920	Machine Screw Nuts, Flat & Lock Washers - Zinc Plated	1600
FK12950	FK52950	Finished Hex Nuts - USS & SAE Zinc Plated	640
FK13000	FK53000	Finished Hex Nuts - USS & SAE Grade 8	640
FK13050	FK53050	Finished Hex Nuts - USS Zinc Plated	450
FK13100	FK53100	Finished Hex Nuts - SAE Zinc Plated	450
FK13150	FK53150	Finished Hex Nuts - USS Grade 8	450
FK13200	FK53200	Finished Hex Nuts - SAE Grade 8	450
FK13250	FK53250	Hex Jam Nuts - USS Zinc Plated	295
FK13300	FK53300	Hex Jam Nuts - SAE Zinc Plated	295
-	FK53320	Hex Coupling Nuts - USS Zinc Plated	114



# FAS-KIT<sup>®</sup> NUT & WASHER ASSORTMENTS



<b>Metal Tray Assortments - cont'd</b>			
Small Drawer	Large Drawer	Description	Number of Pieces
FK13350	FK53350	Slotted Hex Nuts - SAE Thread Zinc Plated	185
FK13360	FK53360	Slotted Hex Nuts - USS Thread Zinc Plated	185
FK13370	FK53370	Slotted Hex Nuts - USS & SAE Thread Zinc Plated	232
FK13400	FK53400	Nylon Insert Stop Nuts - USS & SAE Zinc Plated	560
FK13450	FK53450	Nylon Insert Stop Nuts - USS Zinc Plated	350
FK13500	FK53500	Nylon Insert Stop Nuts - SAE Zinc Plated	350
FK13560	FK53560	Nylon Insert Stop Nuts - Mach Screw Sizes Zinc Plated	700
FK13650	FK53650	All Steel Prevailing Torque Lock Nuts - USS & SAE	450
FK13700	FK53700	All Steel Prevailing Torque Lock Nuts - USS	245
FK13750	FK53750	All Steel Prevailing Torque Lock Nuts - SAE	245
FK13800	FK53800	Keps Nuts - USS & SAE Zinc Plated	900
FK13850	FK53850	Keps Nuts & Nylon Insert Stop Nuts	1500
FK13870	FK53870	Serrated Flange Lock Nuts - USS Thread Zinc Plated	225
FK13900	FK53900	Wing Nuts - USS Thread Zinc Plated	145
FK13950	FK53950	Wing Nuts - USS & SAE Thread Zinc Plated	185
FK14050	FK54050	Acorn Nuts - Nickel Plated Steel	325

# Section 3: Screws

## Table of Contents

### Machine Screws

Slotted Round Head .....	3-4
Slotted Flat Head .....	5-6
Slotted Oval Head .....	7
Slotted Pan Head .....	8
Slotted Truss Head .....	9
Phillips Flat Head .....	10
Phillips Oval Head .....	11
Phillips Pan Head .....	12
Phillips Truss Head .....	13
Indented Hex Washer Head .....	14
Thumb Screws .....	14

### Sheet Metal Screws

Slotted Pan Head .....	15
Phillips Pan Head .....	15
Combo Pan Head .....	16
Slotted Flat Head .....	17
Phillips Flat Head .....	17
Phillips Oval Head .....	18
Slotted & Unslotted Hex Washer Head .....	19
Self Piercing Screws, <i>Zinc Plated</i> .....	19
Self Piercing Screws, <i>Painted Head</i> .....	19

### Self-Drilling Screws

Phillips Pan Head .....	20
Hex Head Washer .....	21
Heavy Duty Hex Head Washer .....	22
Phillips Flat Head w/wings .....	22
Wafer Head .....	22
Phillips Flat Head .....	22

### Lath Screws

Phillips Sharp Point .....	22
Phillips Drill Point .....	22
Door Hardware .....	22

### Miscellaneous Construction Screws

Woodgrip Sealing Screws .....	23
Tiemaster™ Landscape Screws .....	23
Insulation Fasteners .....	23

### Wood Screws

Slotted Flat Head .....	24
Phillips Flat Head .....	24
Slotted Round Head .....	25

### Drywall Screws

Coarse Phillips Bugle Head .....	26
Fine Phillips Bugle Head .....	26
Heavy Duty Laminating Screws .....	26
Self Drilling Phillips Bugle Head .....	27
Trim Head .....	27
Framing (Peanut) Screws .....	27
Exterior Decking Screws .....	28
Stainless Steel Square Drive Screws .....	28

### Tapcon™ Masonry Screw Anchors

Hex Washer Head .....	29
Phillips Flat Head .....	29
Carbide Tipped Masonry Bits .....	29
Tapcon™ Condrive 1000 Installation Tool Kit .....	29

### Automotive Tapping Screws

Torx Flat Head Floor Board Screws .....	30
Thread Cutting Screws .....	31
Black Oxide Phillips Oval Head .....	32
Black Oxide Phillips Flat Head .....	32
Black Oxide Phillips Pan Head .....	32
Phillips Oval Countersunk Washer Head .....	33
Phillips Oval Flush Washer Head .....	33
Phillips Oval Head Self Drilling Finishing Screw ...	34
Phillips Flat Top Washer Head .....	34
Phillips Pan Head Sems® .....	34
Metric Torx® Head .....	35

<b>Faskit Assortments</b> .....	36-37
---------------------------------	-------



# MACHINE SCREWS

## SLOTTED ROUND HEAD

Plating: Bright Zinc

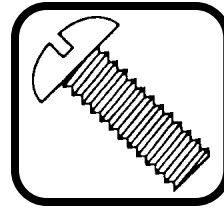

**3**

Dia	Length	Part #	Qty
<b># 4</b> - 40	1/4	13832	100
	3/8	13833	100
	1/2	13834	100
	5/8	13835	100
	3/4	13836	100
	1	13838	100
	1-1/2	13839	100
<b># 6</b> - 32	1/4	00753	100
	3/8	00673	100
	1/2	00674	100
	5/8	00675	100
	3/4	00676	100
	7/8	00677	100
	1	00678	100
	1-1/4	00754	100
	1-1/2	13826	100
	2	13840	50
	2-1/2	13841	50
3	09729	50	
4	09730	50	
<b># 8</b> - 32	1/4	00755	100
	3/8	00756	100
	1/2	00679	100
	5/8	00680	100
	3/4	00681	100
	7/8	00757	100
	1	00682	100
	1-1/4	00750	100
	1-1/2	00758	100
	2	13827	50
	2-1/2	13829	50
	3	09752	50
	4	09753	50

Dia	Length	Part #	Qty
<b># 10</b> - 32	3/8	00759	100
	1/2	00683	100
	5/8	00760	100
	3/4	00684	100
	7/8	00761	100
	1	00685	100
	1-1/4	00686	100
	1-1/2	00762	100
	1-3/4	00763	100
	2	00764	100
	2-1/2	13842	50
	3	13843	50
4	13844	50	
<b># 10</b> - 24	3/8	00765	100
	1/2	00687	100
	5/8	00766	100
	3/4	00688	100
	7/8	00767	100
	1	00689	100
	1-1/4	00751	100
	1-1/2	00752	100
	1-3/4	00768	100
	2	00769	100
2-1/2	13801	100	
3	09705	50	
4	09706	50	
5	09707	50	
6	09708	50	
<b># 12</b> - 24	1/2	00690	100
	5/8	00770	100
	3/4	00691	100
	1	00692	100
	1-1/4	00693	100
	1-1/2	00772	100
2	00774	100	

# MACHINE SCREWS

## SLOTTED ROUND HEAD

Plating: Bright Zinc

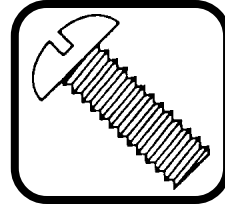

3

Dia	Length	Part #	Qty
<b>1/4</b> -20	1/2	01867	100
	5/8	01868	100
	3/4	01869	100
	7/8	13828	100
	1	01870	100
	1-1/4	01871	100
	1-1/2	01872	100
	1-3/4	01873	100
	2	01874	100
	2-1/4	13803	100
	2-1/2	13804	50
	3	09709	50
	3-1/2	13806	50
	4	09710	50
5	09711	50	
6	09712	50	
<b>5/16</b> -18	1/2	13807	100
	3/4	13808	100
	1	13809	100
	1-1/4	13810	100
	1-1/2	13811	100
	2	13812	100
	2-1/2	13813	50
	3	09713	25
	3-1/2	13814	25
	4	09714	25
5	09715	25	
6	09716	25	
<b>3/8</b> -16	4	09717	25
	5	09718	25
	6	09719	25

# MACHINE SCREWS

## SLOTTED FLAT HEAD

Plating: Bright Zinc

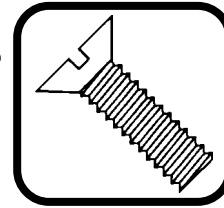

**3**

Dia	Length	Part #	Qty
<b># 4</b> - 40	1/4	14126	100
	3/8	14127	100
	1/2	14128	100
	5/8	14129	100
	3/4	14130	100
	1	14131	100
<b># 6</b> - 32	1/4	14132	100
	3/8	14133	100
	1/2	14134	100
	5/8	14135	100
	3/4	14136	100
	7/8	14137	100
	1	14138	100
	1-1/4	14139	100
	1-1/2	14140	100
	1-3/4	13822	100
	2	13823	100
	2-1/2	13824	100
	2-3/4	13825	100
	3	35067	50
4	35068	50	
<b># 8</b> - 32	1/4	14141	100
	3/8	14142	100
	1/2	14143	100
	5/8	14144	100
	3/4	14145	100
	7/8	14146	100
	1	14147	100
	1-1/4	14148	100
	1-1/2	14149	100
	2	14150	100
3	35084	50	

Dia	Length	Part #	Qty
<b># 10</b> - 32	3/8	14151	100
	1/2	14152	100
	5/8	14153	100
	3/4	14154	100
	7/8	14155	100
	1	14156	100
	1-1/4	14157	100
	1-1/2	14158	100
	1-3/4	14159	100
	2	14160	100
<b># 10</b> - 24	3/8	14161	100
	1/2	14162	100
	5/8	14163	100
	3/4	14164	100
	7/8	14165	100
	1	14166	100
	1-1/4	14167	100
	1-1/2	14168	100
	1-3/4	14169	100
	2	14170	100
	2-1/4	13816	100
	2-1/2	13817	100
	2-3/4	13818	100
	3	35069	50
4	35070	50	
5	35071	50	
6	35072	50	
<b># 12</b> - 24	1/2	14171	100
	5/8	14172	100
	3/4	14173	100
	7/8	14174	100
	1	14175	100
	1-1/4	14176	100
	1-1/2	14177	100
	1-3/4	14178	100
	2	14179	100

# MACHINE SCREWS

## SLOTTED FLAT HEAD

Plating: Bright Zinc

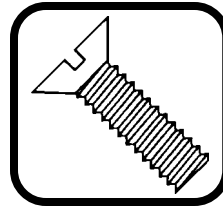

3

Dia	Length	Part #	Qty
<b>1/4</b> - 20	1/2	14180	100
	5/8	14181	100
	3/4	14182	100
	7/8	14183	100
	1	14184	100
	1-1/4	14185	100
	1-1/2	14186	100
	1-3/4	14187	100
	2	14188	100
	2-1/4	13819	50
	2-1/2	14189	50
	2-3/4	13820	50
	3	14190	50
	3-1/2	14191	50
	4	35074	25
5	35075	25	
6	35076	25	
<b>5/16</b> - 18	1/2	14192	100
	3/4	14193	100
	1	14194	100
	1-1/4	13821	50
	1-1/2	14195	50
	2	14196	50
	2-1/2	14197	25
	3	14198	25
	3-1/2	14199	25
	4	14200	50
5	35079	25	
6	35080	25	
<b>3/8</b> - 16	4	35081	25
	5	35082	25
	6	35083	25



# MACHINE SCREWS

## SLOTTED OVAL HEAD

Zinc Plated

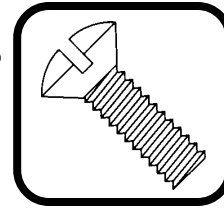

3

Dia	Length	Part #	Qty
<b># 6</b> - 32	1/4	00775	100
	3/8	00850	100
	1/2	00851	100
	5/8	00852	100
	3/4	00853	100
	7/8	00854	100
	1	00855	100
	1-1/4	00776	100
	1-1/2	05818	100
<b># 8</b> - 32	1/4	00777	100
	3/8	00778	100
	1/2	00856	100
	5/8	00857	100
	3/4	00858	100
	7/8	00779	100
	1	00859	100
	1-1/4	00860	100
	1-1/2	00780	100
2	05819	100	
<b># 10</b> - 32	3/8	00781	100
	1/2	00861	100
	5/8	00782	100
	3/4	00862	100
	1	00863	100
	1-1/4	00864	100
	1-1/2	00784	100
2	00786	100	

Dia	Length	Part #	Qty
<b># 10</b> - 24	1/4	05821	100
	3/8	00787	100
	1/2	00865	100
	5/8	00788	100
	3/4	00866	100
	7/8	00789	100
	1	00867	100
	1-1/4	00868	100
	1-1/2	00869	100
1/4 - 20	1-3/4	00790	100
	2	00791	100
	1/2	05810	100
1/4 - 20	5/8	05811	100
	3/4	05812	100
	7/8	05813	100
	1	05814	100
	1-1/4	05809	100
	1-1/2	05815	100
	1-3/4	05816	100
2	05817	100	

# MACHINE SCREWS

## SLOTTED PAN HEAD

Zinc Plated

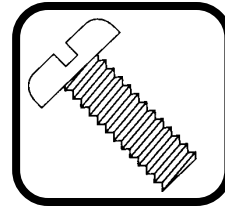

3

Dia	Length	Part #	Qty
<b># 4</b> - 40	1/8	<b>38910</b>	100
	3/16	<b>38911</b>	100
	1/4	<b>38912</b>	100
	5/16	<b>38913</b>	100
	3/8	<b>38914</b>	100
	7/16	<b>38915</b>	100
	1/2	<b>38916</b>	100
	5/8	<b>38917</b>	100
	3/4	<b>38918</b>	100
	7/8	<b>38919</b>	100
	1	<b>38920</b>	100
	1-1/4	<b>38921</b>	50
	1-1/2	<b>38922</b>	50
<b># 6</b> - 32	1/8	<b>38940</b>	100
	3/16	<b>38941</b>	100
	1/4	<b>38942</b>	100
	5/16	<b>38943</b>	100
	3/8	<b>38944</b>	100
	7/16	<b>38945</b>	100
	1/2	<b>38946</b>	100
	5/8	<b>38947</b>	100
	3/4	<b>38948</b>	100
	7/8	<b>38949</b>	100
	1	<b>38950</b>	100
	1-1/4	<b>38951</b>	50
	1-1/2	<b>38952</b>	50
<b># 8</b> - 32	3/16	<b>38956</b>	100
	1/4	<b>38957</b>	100
	5/16	<b>38958</b>	100
	3/8	<b>38959</b>	100
	7/16	<b>38960</b>	100
	1/2	<b>38961</b>	100
	5/8	<b>38962</b>	100
	3/4	<b>38963</b>	100
	7/8	<b>38964</b>	100
	1	<b>38965</b>	100
	1-1/4	<b>38966</b>	50
	1-1/2	<b>38967</b>	50

Dia	Length	Part #	Qty
<b># 10</b> - 24	1/4	<b>38972</b>	100
	5/16	<b>38973</b>	100
	3/8	<b>38974</b>	100
	1/2	<b>38976</b>	100
	5/8	<b>38977</b>	100
	3/4	<b>38978</b>	100
	7/8	<b>38979</b>	100
	1	<b>38980</b>	100
	1-1/4	<b>38981</b>	50
	1-1/2	<b>38982</b>	50
	1-3/4	<b>38983</b>	50
	2	<b>38984</b>	50
	<b># 10</b> - 32	1/4	<b>38987</b>
5/16		<b>38988</b>	100
3/8		<b>38989</b>	100
1/2		<b>38991</b>	100
5/8		<b>38992</b>	100
3/4		<b>38993</b>	100
7/8		<b>38994</b>	100
1		<b>38995</b>	100
1-1/4		<b>38996</b>	50
1-1/2		<b>38997</b>	50
1-3/4		<b>38998</b>	50
2		<b>38999</b>	50
<b>1/4</b> - 20		3/8	<b>39004</b>
	1/2	<b>39006</b>	100
	5/8	<b>39007</b>	100
	3/4	<b>39008</b>	100
	7/8	<b>39009</b>	100
	1	<b>39010</b>	100
	1-1/4	<b>39011</b>	50
	1-1/2	<b>39012</b>	50
	1-3/4	<b>39013</b>	50
	2	<b>39014</b>	50

# MACHINE SCREWS

## SLOTTED TRUSS HEAD

Zinc Plated

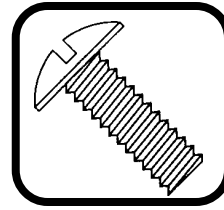

3

Dia	Length	Part #	Qty
# 4 -40	1/4	39105	100
	3/8	39106	100
	1/2	39107	100
# 6 -32	1/4	39112	100
	3/8	39113	100
	1/2	39114	100
	5/8	39115	100
	3/4	39116	100
	1	39117	100
# 8 -32	1/4	39122	100
	3/8	39123	100
	1/2	39124	100
	5/8	39125	100
	3/4	39126	100
	1	39127	100
# 10 -24	3/8	39132	100
	1/2	39133	100
	5/8	39134	100
	3/4	39135	100
	1	39136	100
# 10 -32	3/8	39141	100
	1/2	39142	100
	5/8	39143	100
	3/4	39144	100
	1	39145	100
1/4 -20	1/2	39150	100
	5/8	39151	100
	3/4	39152	100
	1	39153	100
	1-1/4	39154	100
	1-1/2	39155	100
	2	39156	100

# MACHINE SCREWS

## PHILLIPS FLAT HEAD

Plating: Bright Zinc

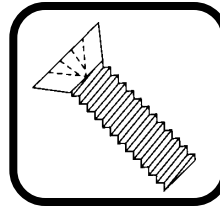

3

Dia	Length	Part #	Qty
<b># 4</b> - 40	1/4	14126P	100
	3/8	14127P	100
	1/2	14128P	100
	5/8	14129P	100
	3/4	14130P	100
	1	14131P	100
<b># 6</b> - 32	1/4	14132P	100
	3/8	14133P	100
	1/2	14134P	100
	5/8	14135P	100
	3/4	14136P	100
	7/8	14137P	100
<b># 8</b> - 32	1	14138P	100
	1/4	14141P	100
	3/8	14142P	100
	1/2	14143P	100
	5/8	14144P	100
	3/4	14145P	100
	7/8	14146P	100
	1	14147P	100
	1-1/4	14148P	100
	1-1/2	14149P	100
2	14150P	100	
<b># 10</b> - 32	3/8	14151P	100
	1/2	14152P	100
	5/8	14153P	100
	3/4	14154P	100
	7/8	14155P	100
	1	14156P	100
	1-1/4	14157P	100
	1-1/2	14158P	100

Dia	Length	Part #	Qty
<b># 10</b> - 24	3/8	14161P	100
	1/2	14162P	100
	5/8	14163P	100
	3/4	16164P	100
	7/8	14165P	100
	1	14166P	100
	1-1/4	14167P	100
	1-1/2	14168P	100
	2	14170P	100
	2-1/2	14171P	100
<b># 12</b> - 24	1/2	1208MPU	100 - Undercut
	1/2	1208FPU	100 - Thread Cutting
<b>1/4</b> - 20	1/2	14180P	100
	5/8	14181P	100
	3/4	14182P	100
	7/8	14183P	100
	1	14184P	100
	1-1/4	14185P	100
	1-1/2	14186P	100
	1-3/4	14187P	100
	2	14188P	100
	2-1/4	13819P	50
	2-1/2	14189P	50
	2-3/4	13820P	50
	3	14190P	50
	4	35074P	25
5	35075P	25	
6	35076P	25	

# MACHINE SCREWS

## PHILLIPS OVAL HEAD

Zinc Plated

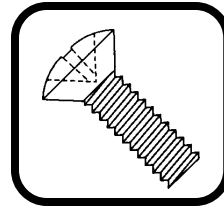

3

Dia	Length	Part #	Qty
<b># 6</b> - 32	3/8	00875	100
	1/2	00876	100
	5/8	00877	100
	3/4	00878	100
	7/8	00879	100
	1	00880	100
	1-1/4	00799	100
<b># 8</b> - 32	3/8	00736	100
	1/2	00881	100
	5/8	00882	100
	3/4	00883	100
	7/8	00737	100
	1	00884	100
	1-1/4	00885	100
<b># 10</b> - 32	1-1/2	00738	100
	3/8	00741	100
	1/2	00886	100
	5/8	00742	100
	3/4	00887	100
	7/8	00743	100
	1	00888	100
	1-1/4	00889	100
	1-1/2	00744	100
	1-3/4	00745	100
2	00746	100	

Dia	Length	Part #	Qty
<b># 10</b> - 24	3/8	00747	100
	1/2	00890	100
	5/8	00748	100
	3/4	00891	100
	7/8	00749	100
	1	00892	100
	1-1/4	00893	100
<b># 12</b> - 24	1-1/2	00894	100
	3/8	00726	100
	1/2	00895	100
	5/8	00727	100
	3/4	00896	100
	1	00897	100
<b>1/4</b> - 20	1-1/4	00898	100
	1/2	01858	100
	5/8	01859	100
	3/4	01860	100
	1	01862	100
	1-1/4	01863	100
	1-1/2	01864	100
2	01866	100	

# MACHINE SCREWS

## PHILLIPS PAN HEAD

Zinc Plated

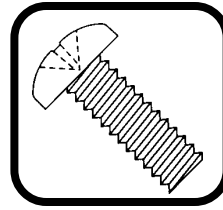

3

Dia	Length	Part #	Qty
<b># 4</b> - 40	3/16	39015	100
	1/4	39016	100
	5/16	39017	100
	3/8	39018	100
	7/16	39019	100
	1/2	39020	100
	5/8	39021	100
	3/4	39022	100
<b># 6</b> - 32	1/4	39030	100
	5/16	39031	100
	3/8	39032	100
	7/16	39033	100
	1/2	39034	100
	5/8	39035	100
	3/4	39036	100
	7/8	39037	100
	1	39038	100
1-1/4	39039	100	
<b># 8</b> - 32	1/4	39044	100
	5/16	39045	100
	3/8	39046	100
	7/16	39047	100
	1/2	39048	100
	5/8	39049	100
	3/4	39050	100
	7/8	39051	100
	1	39052	100
	1-1/4	39053	50
	1-1/2	39054	50

Dia	Length	Part #	Qty
<b># 10</b> - 24	5/16	39059	100
	3/8	39060	100
	7/16	39061	100
	1/2	39062	100
	5/8	39063	100
	3/4	39064	100
	1	39066	100
	1-1/4	39067	50
	1-1/2	39068	50
<b># 10</b> - 32	1-3/4	39069	50
	2	39070	50
	5/16	39073	100
	3/8	39074	100
	7/16	39075	100
	1/2	39076	100
	5/8	39077	100
	3/4	39078	100
	1	39080	100
<b>1/4</b> - 20	1-1/4	39081	50
	1-1/2	39082	50
	1-3/4	39083	50
	2	39084	50
	3/8	39088	100
	1/2	39090	100
	5/8	39091	100
	3/4	39092	100
	7/8	39093	100
1	39094	100	
	1-1/4	39095	50
	1-1/2	39096	50
	1-3/4	39097	50
	2	39098	50

# MACHINE SCREWS

## PHILLIPS TRUSS HEAD

Plating: Zinc

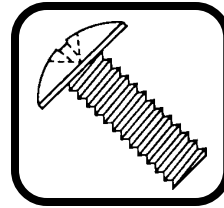

3

Dia	Length	Part #	Qty
<b># 4</b> -40	1/4	<b>39305</b>	100
	3/8	<b>39306</b>	100
	1/2	<b>39307</b>	100
	5/8	<b>39308</b>	100
	3/4	<b>39309</b>	100
<b># 6</b> -32	1/4	<b>39312</b>	100
	3/8	<b>39313</b>	100
	1/2	<b>39314</b>	100
	5/8	<b>39315</b>	100
	3/4	<b>39316</b>	100
	1	<b>39317</b>	100
<b># 8</b> -32	1/4	<b>39322</b>	100
	3/8	<b>39323</b>	100
	1/2	<b>39324</b>	100
	5/8	<b>39325</b>	100
	3/4	<b>39326</b>	100
	1	<b>39327</b>	100
<b># 10</b> -24	3/8	<b>39332</b>	100
	1/2	<b>39333</b>	100
	5/8	<b>39334</b>	100
	3/4	<b>39335</b>	100
	1	<b>39336</b>	100
<b># 10</b> -32	3/8	<b>39341</b>	100
	1/2	<b>39342</b>	100
	5/8	<b>39343</b>	100
	3/4	<b>39344</b>	100
	1	<b>39345</b>	100
<b>1/4</b> -20	1/2	<b>39350</b>	100
	5/8	<b>39351</b>	100
	3/4	<b>39352</b>	100
	1	<b>39353</b>	100
	1-1/4	<b>39354</b>	100
	1-1/2	<b>39355</b>	100
	2	<b>39356</b>	100

# MACHINE SCREWS

## INDENTED HEX WASHER HEAD

Plating: Zinc

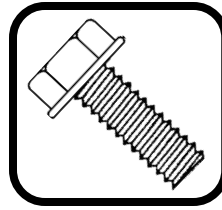

3

Dia	Length	Part #	Qty
<b># 6</b> - 32	1/4	02966	100
	5/16	02967	100
	3/8	02968	100
	1/2	02969	100
	5/8	02970	100
	3/4	02971	100
	1	02972	100
<b># 8</b> - 32	1/4	02973	100
	5/16	02974	100
	3/8	02975	100
	1/2	02976	100
	5/8	02977	100
	3/4	02978	100
	1	02979	100

Dia	Length	Part #	Qty
<b># 10</b> - 24	3/8	02980	100
	1/2	02981	100
	5/8	02982	100
	3/4	02983	100
	1	02984	100
<b># 10</b> - 32	3/8	02985	100
	1/2	02986	100
	5/8	02987	100
	3/4	02988	100
	1	02989	100

# THUMB SCREWS

Plating: Zinc

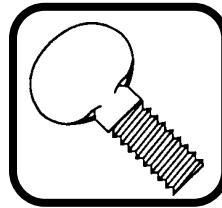

Dia	Length	Part #	Qty
<b># 6</b> - 32	1/2	37821	100
<b># 8</b> - 32	1/2	37822	100
<b># 10</b> - 24	1/2	37823	100
	3/4	37824	100
	1	37825	100

Dia	Length	Part #	Qty
<b># 10</b> - 32	1/2	37826	100
	3/4	37827	100
	1	37828	100
<b>1/4</b> - 20	1/2	37829	100
	3/4	37830	100
	1	37831	100
	1-1/2	37832	100
<b>5/16</b> - 18	1	37833	100
	1-1/2	37834	100



# SHEET METAL SCREWS

## SLOTTED & PHILLIPS PAN HEAD

Plating: Bright Zinc

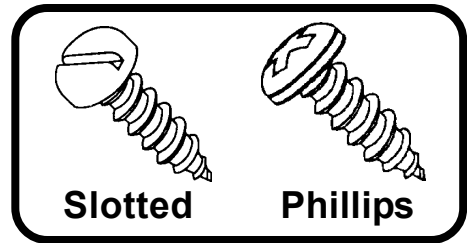

3

Dia	Length	Part #		Qty
		Slotted	Phillips	
<b># 4</b>	1/4	03115	03125	100
	3/8	03116	03126	100
	1/2	03117	03127	100
	5/8	01965	02069	100
	3/4	03118	03128	100
	1	03119	03129	100
<b># 6</b>	1/4	00845	01177	100
	3/8	00601	01200	100
	1/2	00602	01201	100
	5/8	00603	01202	100
	3/4	00604	01203	100
	7/8	00605	01204	100
	1	00606	01205	100
	1-1/4	00841	01178	100
	1-1/2	01969	01179	100
2	35686	02070	100	
<b># 8</b>	1/4	00607	01206	100
	3/8	00608	01207	100
	1/2	00609	01208	100
	5/8	00610	01209	100
	3/4	00611	01210	100
	7/8	00612	01211	100
	1	00613	01212	100
	1-1/4	00614	01213	100
	1-1/2	00846	01180	100
	1-3/4	—	01181	50
	2	35687	01182	50
	2-1/2	35688	02071	50
	3	35689	02072	50

Dia	Length	Part #		Qty
		Slotted	Phillips	
<b># 10</b>	3/8	00615	01214	100
	1/2	00616	01215	100
	5/8	00617	01216	100
	3/4	00618	01217	100
	7/8	00619	01218	100
	1	00620	01219	100
	1-1/4	00621	01220	100
	1-1/2	00849	01183	100
	1-3/4	00847	01184	50
	2	00842	01185	50
	2-1/2	35690	35696	50
	3	35691	35697	50
	<b># 12</b>	1/2	00622	01221
5/8		00623	01222	100
3/4		00624	01223	100
7/8		00625	01224	100
1		00626	01225	100
1-1/4		00627	01226	100
1-1/2		00628	01227	100
1-3/4		01978	01187	50
2		01979	01188	50
2-1/2		35692	35698	50
3	35693	35699	50	
<b># 14</b>	1/2	00629	01228	100
	5/8	00630	01229	100
	3/4	00631	01230	100
	7/8	00632	01231	100
	1	00633	01232	100
	1-1/4	00634	01233	100
	1-1/2	00635	01234	100
	1-3/4	00843	01189	50
	2	00844	01190	50
	2-1/2	35694	01192	50
	3	35695	35700	50

# SHEET METAL SCREWS

## COMBO DRIVE PAN HEAD

Zinc Plated

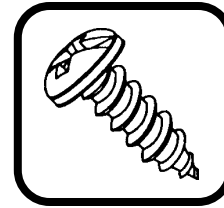

**3**

Dia	Length	Part #	Qty
<b># 6</b>	3/8	<b>02200</b>	100
	1/2	<b>02201</b>	100
	5/8	<b>02202</b>	100
	3/4	<b>02203</b>	100
	1	<b>02204</b>	100
	1-1/4	<b>02205</b>	100
	1-1/2	<b>02206</b>	100
	2	<b>02207</b>	100
<b># 8</b>	3/8	<b>02208</b>	100
	1/2	<b>02209</b>	100
	5/8	<b>02210</b>	100
	3/4	<b>02211</b>	100
	1	<b>02212</b>	100
	1-1/4	<b>02213</b>	100
	1-1/2	<b>02214</b>	100
	2	<b>02215</b>	100
<b># 10</b>	3/8	<b>02216</b>	100
	1/2	<b>02217</b>	100
	5/8	<b>02218</b>	100
	3/4	<b>02219</b>	100
	1	<b>02220</b>	100
	1-1/4	<b>02221</b>	100
	1-1/2	<b>02222</b>	100
	2	<b>02223</b>	100

Dia	Length	Part #	Qty
<b># 12</b>	1/2	<b>02224</b>	100
	3/4	<b>02225</b>	100
	1	<b>02226</b>	100
	1-1/4	<b>02227</b>	100
	1-1/2	<b>02228</b>	100
	2	<b>02229</b>	100
<b># 14</b>	1/2	<b>02230</b>	100
	3/4	<b>02231</b>	100
	1	<b>02232</b>	100
	1-1/4	<b>02233</b>	100
	1-1/2	<b>02234</b>	100

# SHEET METAL SCREWS

## SLOTTED & PHILLIPS FLAT HEAD

Plating: Bright Zinc

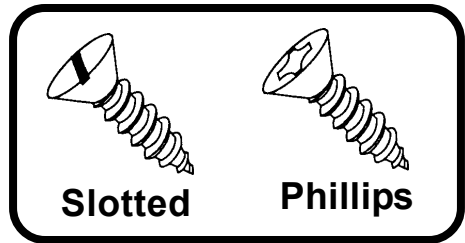

**3**

Dia	Length	Part #		Qty
		Slotted	Phillips	
<b># 4</b>	1/4	05751	07583	100
	3/8	05752	07584	100
	1/2	05753	07585	100
	5/8	05754	07586	100
	3/4	05755	07587	100
<b># 6</b>	1/4	05756	—	100
	3/8	05757	05791	100
	1/2	05758	01936	100
	5/8	05759	05792	100
	3/4	05760	05793	100
	7/8	05761	05794	100
	1	05762	01937	100
	1-1/4	35863	35875	100
1-1/2	35864	35876	100	
<b># 8</b>	3/8	05763	01938	100
	1/2	05764	01939	100
	5/8	05765	01940	100
	3/4	05766	01941	100
	7/8	05767	01942	100
	1	05768	01943	100
	1-1/4	05769	01944	100
	1-1/2	05770	01945	100
	1-3/4	35865	35877	100
	2	35866	35878	100

Dia	Length	Part #		Qty
		Slotted	Phillips	
<b># 10</b>	3/8	05771	—	100
	1/2	05772	01946	100
	5/8	05773	01947	100
	3/4	05774	01948	100
	7/8	05775	05795	100
	1	05776	01949	100
	1-1/4	05777	01950	100
	1-1/2	05778	01951	100
	1-3/4	05779	05796	100
	2	05780	05797	100
	2-1/2	35867	35879	100
	3	35868	35880	100
	<b># 12</b>	1/2	—	01952
5/8		—	05798	100
3/4		05781	05799	100
1		05782	05801	100
1-1/4		05783	01953	100
1-1/2		00000	01954	100
1-3/4		35869	35881	100
2		35870	35882	100
2-1/2		35871	35883	100
3		35872	35884	100
<b># 14</b>	3/4	05784	05802	100
	7/8	05785	—	100
	1	05786	05804	100
	1-1/4	05787	05805	100
	1-1/2	05788	05806	100
	2	05790	05808	100
	2-1/2	35873	35885	100
	3	35874	35886	100

# SHEET METAL SCREWS

## PHILLIPS OVAL HEAD

Zinc Plated



3

Dia	Length	Part #	Qty
<b># 4</b>	3/8	<b>03121</b>	100
	1/2	<b>03122</b>	100
	3/4	<b>03123</b>	100
	1	<b>03124</b>	100
<b># 6</b>	3/8	<b>00801</b>	100
	1/2	<b>00802</b>	100
	5/8	<b>00803</b>	100
	3/4	<b>00804</b>	100
	7/8	<b>00805</b>	100
	1	<b>00806</b>	100
	1-1/4	<b>00800</b>	100
	1-1/2	<b>01982</b>	100
<b># 8</b>	3/8	<b>00808</b>	100
	1/2	<b>00809</b>	100
	5/8	<b>00810</b>	100
	3/4	<b>00811</b>	100
	7/8	<b>00812</b>	100
	1	<b>00813</b>	100
	1-1/4	<b>00807</b>	100
	1-1/2	<b>01984</b>	100
	1-3/4	<b>01985</b>	100
	2	<b>01986</b>	100

Dia	Length	Part #	Qty
<b># 10</b>	3/8	<b>01987</b>	100
	1/2	<b>00814</b>	100
	5/8	<b>00815</b>	100
	3/4	<b>00816</b>	100
	7/8	<b>00817</b>	100
	1	<b>00818</b>	100
	1-1/4	<b>00819</b>	100
	1-1/2	<b>01988</b>	100
	1-3/4	<b>01989</b>	100
<b># 12</b>	2	<b>01990</b>	100
	1/2	<b>00820</b>	100
	5/8	<b>00821</b>	100
	3/4	<b>00822</b>	100
	7/8	<b>00823</b>	100
	1	<b>00824</b>	100
	1-1/4	<b>00825</b>	100
	1-1/2	<b>00826</b>	100
<b># 14</b>	1-3/4	<b>01992</b>	100
	2	<b>01993</b>	100
	1/2	<b>01850</b>	100
	5/8	<b>01851</b>	100
	3/4	<b>01852</b>	100
	1	<b>01853</b>	100
1-1/4	<b>01854</b>	100	
1-1/2	<b>01855</b>	100	

# SHEET METAL SCREWS

## SLOTTED & UNSLOTTED HEX WASHER HEAD

Zinc Plated

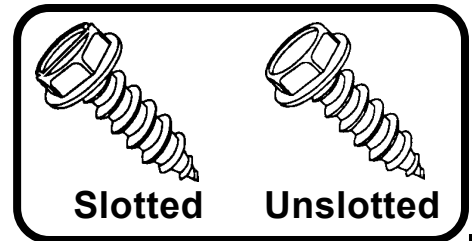

**3**

<b>Slotted</b>			
<b>Dia</b>	<b>Length</b>	<b>Part #</b>	<b>Qty</b>
<b># 8</b>	1/2	<b>00900</b>	100
	3/4	<b>00431</b>	100
	1	<b>00432</b>	100
	1-1/4	<b>00433</b>	100
	1-1/2	<b>00434</b>	100
<b># 10</b>	1/2	<b>00435</b>	100
	3/4	<b>00436</b>	100
	1	<b>00437</b>	100
	1-1/4	<b>00438</b>	100
	1-1/2	<b>00439</b>	100
<b># 12</b>	1/2	<b>00901</b>	100
	3/4	<b>00903</b>	100
	1	<b>00905</b>	100
	1-1/4	<b>00906</b>	100
	1-1/2	<b>00907</b>	100

<b>Slotted</b>			
<b>Dia</b>	<b>Length</b>	<b>Part #</b>	<b>Qty</b>
<b>1/4</b>	1/2	<b>00908</b>	100
	3/4	<b>00910</b>	100
	1	<b>00912</b>	100
	1-1/4	<b>00913</b>	100
	1-1/2	<b>00914</b>	100
	2	<b>00440</b>	100
<b>Unslotted</b>			
<b>Dia</b>	<b>Length</b>	<b>Part #</b>	<b>Qty</b>
<b>5/16</b>	3/4	<b>00916</b>	100
	1	<b>00918</b>	100
	1-1/4	<b>00919</b>	100
	1-1/2	<b>00920</b>	100
<b>3/8</b>	1	<b>00443</b>	100
	1-1/4	<b>00444</b>	100
	1-1/2	<b>00445</b>	100

# SELF PIERCING SCREWS

## SLOTTED HEX WASHER HEAD

Zinc Plated & Painted Heads



<b>Zinc Plated</b>			
<b>Dia</b>	<b>Length</b>	<b>Part #</b>	<b>Qty</b>
<b># 8</b>	1/2	<b>03810</b>	100
	3/4	<b>03812</b>	100
	1	<b>03814</b>	100
	1-1/4	<b>03816</b>	100
	1-1/2	<b>03818</b>	100

<b>Painted Head</b>			
<b>Size</b>	<b>Part #</b>		<b>Qty</b>
	<b>White</b>	<b>Brown</b>	
7 x 1/2	<b>03820</b>	<b>03823</b>	100
8 x 3/4	<b>03821</b>	<b>03824</b>	100
8 x 1"	<b>03822</b>	<b>03825</b>	100

# SELF-DRILLING SCREWS

## PHILLIPS PAN HEAD

Zinc Plated

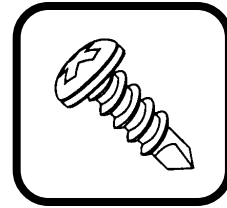

3

**Drill Point Size** determines the Metal Thickness Drillable.

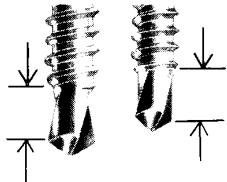

**# 2** : from .036 to .100

**# 3** : from .036 to .175

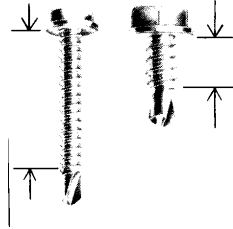

Thread length limits the combined thickness of material that may be gripped. The dimension is shown under the heading **Material Grip Max.**

Dia	Length	Drill Point Size	Material Grip Maximum	Part #	Qty
<b># 6</b>	3/8	# 2	.100	02150	100
	1/2	# 2	.309	02151	100
	5/8	# 2	.313	02152	100
	3/4	# 2	.483	02153	100
	1	# 2	.688	02154	100
	1-1/2	# 2	1.184	02155	50
<b># 8</b>	1/2	# 2	.289	02157	100
	5/8	# 2	.313	02158	100
	3/4	# 2	.539	02159	100
	1	# 2	.789	02160	100
	1-1/4	# 2	.938	02161	50
	1-1/2	# 2	1.289	02162	50
	2	# 2	1.175	02163	50
<b># 10</b>	1/2	# 2	.250	02165	100
	5/8	# 3	.313	02166	100
	3/4	# 3	.438	02167	100
	1	# 3	.688	02168	100
	1-1/4	# 3	.938	02169	50
	1-1/2	# 3	1.209	02170	50
	2	# 3	1.750	02171	50
<b># 12</b>	1	# 3	.688	02173	50

- » Drill, tap, fasten in one operation!
- » For Assembly of wood to metal or metal to metal.
- » Use air or electric drivers equipped with standard clutches which disengage the Torque output when the screw is properly seated.

# SELF-DRILLING SCREWS

## HEX WASHER HEAD

Zinc Plated

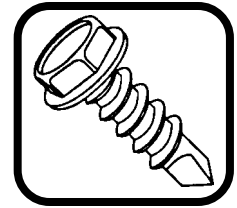

3

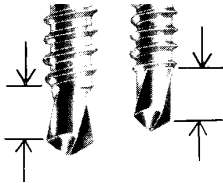

**Drill Point Size** determines the Metal Thickness Drillable.

# 2 : from .036 to .100

# 3 : from .036 to .175

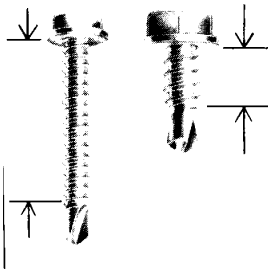

Thread length limits the combined thickness of material that may be gripped. The dimension is shown under the heading **Material Grip Max.**

Dia	Length	Drill Point Size	Material Grip Maximum	Part #	Qty
<b># 6</b> 1/4 Hex Head	3/8	# 2	.100	02100	100
	1/2	# 2	.309	02101	100
	3/4	# 2	.483	02102	100
	1	# 2	.688	02103	100
	1-1/2	# 2	1.184	02104	50
<b># 8</b> 1/4 Hex Head	1/2	# 2	.289	02106	100
	3/4	# 2	.539	02108	100
	1	# 2	.789	02109	100
	1-1/4	# 2	.938	02110	50
	1-1/2	# 2	1.289	02111	50
<b># 10</b> 5/16 Hex Head	2	# 2	1.750	02112	50
	1/2	# 2	.250	02115	100
	5/8	# 3	.313	02116	100
	3/4	# 3	.438	02117	100
	1	# 3	.688	02118	100
<b># 12</b> 5/16 Hex Head	1-1/4	# 3	.938	02119	50
	1-1/2	# 3	1.209	02120	50
	2	# 3	1.750	02121	50
	3/4	# 3	.438	02124	50
	1	# 3	.688	02125	50
<b># 14</b> 3/8 Hex Head	1-1/4	# 3	.938	02126	50
	1-1/2	# 3	1.209	02127	25
	2	# 3	1.750	02128	25
	3	# 3	2.750	02130	25
	3/4	# 3	.366	02132	50
<b># 14</b> 3/8 Hex Head	1	# 3	.616	02134	50
	1-1/4	# 3	.938	02135	25
	1-1/2	# 3	1.209	02136	25
	2	# 3	1.750	02138	25
	2-1/2	# 3	2.375	02139	25
3	# 3	2.750	02140	25	

- » Drill, tap, fasten in one operation!
- » For Assembly of wood to metal or metal to metal.
- » Use air or electric drivers equipped with standard clutches which disengage the Torque output when the screw is properly seated.

# SPECIALTY SELF-DRILLING SCREWS

ZINC PLATED STEEL

3



**Hex Washer  
Head**



**Phillips Flat  
Head w/wings**

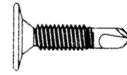

**Phillips  
Wafer Head**

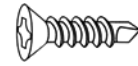

**Phillips  
Flat Head**

Size	Head Style	Drill Point Size	Drill & Tap Capacity	Maximum Material Attachment	Part #	Qty
12-24 x 7/8	Hex Washer	# 4	.125 - .250	.325	03850	100
12-24 x 1-1/4	Hex Washer	# 4.5	.125 - .375	.575	03851	100
12-24 x 2	Hex Washer	# 5	.125 - .500	1.125	03852	100
1/4-28 x 3	Hex Washer	# 5	.125 - .500	2.150	03853	100
12-24 x 2-1/2	Phillips Flat w/wings	# 4	.125 - .250	1.375	03860	100
1/4-20 x 3	Phillips Flat w/wings	# 4	.125 - .250	2.000	03862	100
10-24 x 3/4	Phillips Wafer	# 3	.036 - .175	.375	03865	100
10-24 x 1	Phillips Wafer	# 3	.036 - .175	.500	03866	100
10-24 x 1-1/4	Phillips Wafer	# 3	.036 - .175	.750	03867	100
12-24 x 1-1/2	Phillips Wafer	# 3	.036 - .175	1.000	03868	100
10-24 x 1-7/16	Phillips Wafer w/wings	# 3	.036 - .175	.750	03870	100
8-18 x 3/4	Phillips Flat	# 2	.036 - .100	.539	03900	100
8-18 x 1	Phillips Flat	# 2	.036 - .100	.789	03902	100
10-16 x 3/4	Phillips Flat	# 3	.036 - .175	.438	03910	100
10-16 x 1	Phillips Flat	# 3	.036 - .175	.688	03912	100
1/4-14 x 1	Phillips Flat	# 3	.036 - .210	.366	03924	100

## LATH SCREWS

ZINC PLATED STEEL

FOR WIRE LATH & OTHER MATERIALS

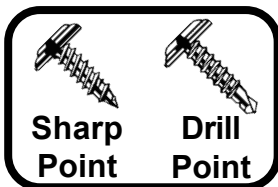

**Sharp  
Point**

**Drill  
Point**

Size	Style	Part #	Qty
#8 x 9/16	Sharp Point	03840	100
#8 x 1/2	Drill Point	03835	100
#8 x 3/4	Drill Point	03836	100
#8 x 1-1/4	Drill Point	03837	100

## DOOR HARDWARE

ZINC OR NICKEL PLATED STEEL



**Hinge &  
Strike**

**Glazing  
Bead**

**Phillips  
Pan**

Size	Style	Part #	Qty
12-24 x 5/8	Hinge & Strike (nickel)	03960	100
14-24 x 7/8	Hinge & Strike (nickel)	03962	100
8 x 1-1/4	Glazing Bead (zinc)	03964	100
12-24 x 3/4	Phillips Pan (zinc)	03970	100



# WOODGRIP SEALING SCREWS

## HEX WASHER HEAD

With Bonded Neoprene Sealing Washer

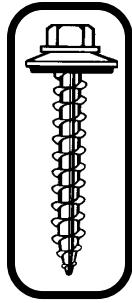

Dia	Length	Part #	Qty
<b># 9</b>	1	<b>03800</b>	100
	1-1/2	<b>03802</b>	100
	2	<b>03804</b>	100
	2-1/2	<b>03806</b>	100
	3	<b>03808</b>	100

**3**

# TIEMASTER™ LANDSCAPE SCREW

## TORX DRIVE FLAT HEAD

Self Drilling Point

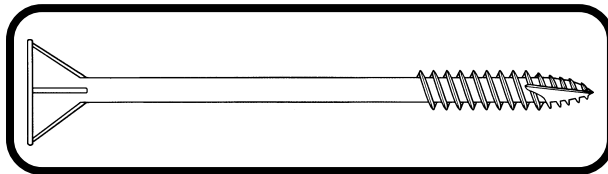

Length	Part #	Qty
<b>6"</b>	<b>03830</b>	50
<b>8"</b>	<b>03831</b>	50

# INSULATION FASTENERS

## SCREWS & PLATES

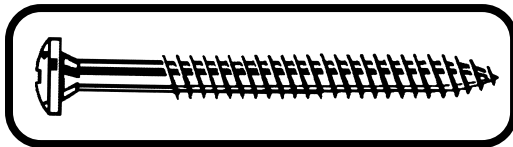

Part # 03890

**DEKFAST #14 X 5" ROOFING  
SCREW WITH SENTRI COATING**

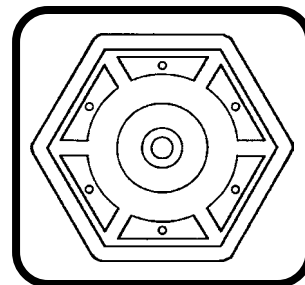

Part # 03885

**DEKFAST GALVALUME STEEL  
2-7/8 HEX INSULATION PLATE**

# WOOD SCREWS

## SLOTTED & PHILLIPS FLAT HEAD

Zinc Plated

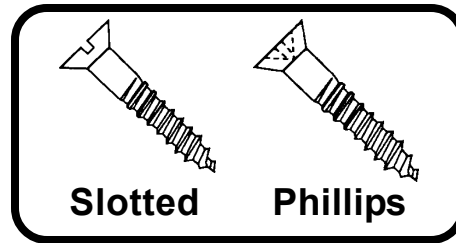

**3**

Dia	Length	Part #		Qty
		Slotted	Phillips	
# 4	1/2	06272	39682	100
	3/4	06274	39683	100
	1	06275	39684	100
# 5	1/2	06279	39685	100
	3/4	06281	39686	100
	1	06282	39687	100
# 6	1/2	06287	39688	100
	3/4	06289	39689	100
	1	06291	39690	100
	1-1/4	06292	39691	100
	1-1/2	06293	39692	100
	2	06295	39693	100
# 7	3/4	06298	39694	100
	1	06300	39695	100
	1-1/4	06301	39696	100
	1-1/2	06302	39697	100
# 8	1/2	06305	39698	100
	3/4	06307	39699	100
	1	06309	39700	100
	1-1/4	06310	39701	100
	1-1/2	06311	39702	100
	1-3/4	06312	39703	100
	2	06313	39704	100
2-1/2	06314	39705	100	

Dia	Length	Part #		Qty
		Slotted	Phillips	
# 9	3/4	06316	39706	100
	1	06318	39707	100
	1-1/4	06319	39708	100
	1-1/2	06320	39709	100
	2	06322	39710	100
# 10	3/4	06325	39711	100
	1	06327	39712	100
	1-1/4	06328	39713	100
	1-1/2	06329	39714	100
	1-3/4	06330	39715	100
	2	06331	39716	100
	2-1/2	06332	39717	100
	3	06333	39718	100
3-1/2	06334	39719	100	
# 12	3/4	06335	39720	100
	1	06337	39721	100
	1-1/4	06338	39722	100
	1-1/2	06339	39723	100
	2	06341	39724	100
	2-1/2	06342	39725	100
# 14	3	06343	39726	100
	1	06347	39727	100
	1-1/4	06348	39728	100
	1-1/2	06349	39729	100
	2	06351	39730	100
	2-1/2	06353	39731	100
	3	06354	39732	100
3-1/2	06355	39733	100	

# WOOD SCREWS

## SLOTTED ROUND HEAD

Plating: Zinc

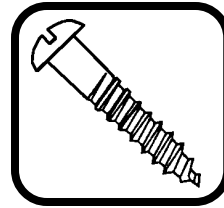

**3**

Dia	Length	Part #	Qty
<b># 2</b>	1/4	<b>06165</b>	100
	3/8	<b>06166</b>	100
	1/2	<b>06167</b>	100
<b># 4</b>	3/8	<b>06171</b>	100
	1/2	<b>06172</b>	100
	5/8	<b>06173</b>	100
	3/4	<b>06174</b>	100
	1	<b>06175</b>	100
	1-1/4	<b>06176</b>	100
<b># 6</b>	1/2	<b>06187</b>	100
	5/8	<b>06188</b>	100
	3/4	<b>06189</b>	100
	1	<b>06191</b>	100
	1-1/4	<b>06192</b>	100
	1-1/2	<b>06193</b>	100
	2	<b>06195</b>	100
<b># 7</b>	5/8	<b>06197</b>	100
	3/4	<b>06198</b>	100
	7/8	<b>06199</b>	100
	1	<b>06200</b>	100
	1-1/4	<b>06201</b>	100

Dia	Length	Part #	Qty
<b># 8</b>	1/2	<b>06205</b>	100
	5/8	<b>06206</b>	100
	3/4	<b>06207</b>	100
	7/8	<b>06208</b>	100
	1	<b>06209</b>	100
	1-1/4	<b>06210</b>	100
	1-1/2	<b>06211</b>	100
	1-3/4	<b>06212</b>	100
	2	<b>06213</b>	100
	2-1/4	<b>06257</b>	100
	2-1/2	<b>06214</b>	100
<b># 10</b>	3/4	<b>06225</b>	100
	1	<b>06227</b>	100
	1-1/4	<b>06228</b>	100
	1-1/2	<b>06229</b>	100
	1-3/4	<b>06230</b>	100
	2	<b>06231</b>	100
	2-1/2	<b>06232</b>	100
	3	<b>06233</b>	100

Dia	Length	Part #	Qty
<b># 12</b>	3/4	<b>06235</b>	100
	1	<b>06237</b>	100
	1-1/4	<b>06238</b>	100
	1-1/2	<b>06239</b>	100
	1-3/4	<b>06240</b>	100
	2	<b>06241</b>	100
	2-1/2	<b>06242</b>	100
3	<b>06243</b>	100	
<b># 14</b>	7/8	<b>06247</b>	100
	1	<b>06248</b>	100
	1-1/4	<b>06249</b>	100
	1-1/2	<b>06250</b>	100
	2	<b>06252</b>	100
	2-1/2	<b>06253</b>	100
3	<b>06254</b>	100	

# DRYWALL SCREWS

**PHILLIPS BUGLE HEAD**  
Hardened Steel Black Phosphate Coated

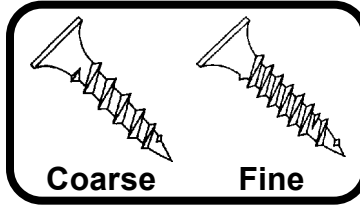

**SCORPION**  
Brand Products

**3**

## Coarse Thread

Dia	Length	Part #				Pieces Per Pound	Pieces Per Bulk Carton
		# / each	1 lb. Box	5 lb. Box	Bulk Carton		
# 6	1	01250	02350	02405	02453	334	10,000
	1-1/8	01251	02351	02406	02454	317	10,000
	1-1/4	01252	02352	02407	02455	280	8,000
	1-5/8	01253	02353	02408	02456	224	5,000
	2	01254	02354	02409	02457	193	3,500
	2-1/4	01255	02355	02410	02458	167	3,000
# 8	2-1/2	01256	02356	02411	02459	115	2,500
	3	01257	02357	02412	02460	97	2,000
# 10	3-1/2	01258	02358	02413	02461	58	1,000
	4	01259	02359	02414	02462	50	1,000

## Fine Thread

Dia	Length	Part #				Pieces Per Pound	Pieces Per Bulk Carton
		# / each	1 lb. Box	5 lb. Box	Bulk Carton		
# 6	1	01260	02360	02415	02463	322	10,000
	1-1/8	01261	02361	02416	02464	306	10,000
	1-1/4	01262	02362	02417	02465	278	8,000
	1-5/8	01263	02363	02418	02466	205	5,000
	2	01264	02364	02419	02467	177	3,500
	2-1/4	01265	02365	02420	02468	153	3,000
# 8	2-1/2	01266	02366	02421	02469	117	2,500
	3	01267	02367	02422	02470	96	2,000
# 10	3-1/2	01268	02368	02423	02471	56	1,000
	4	01269	02369	02424	02472	48	1,000
	4-1/2	01270	02370	02425	02473	44	1,000
	5	01271	03271	02426	02474	41	1,000
	6	01272	02372	02427	02475	34	1,000

## Heavy Duty Laminating Screws

Dia	Length	Part #				Pieces Per Pound	Pieces Per Bulk Carton
		# / each	1 lb. Box	5 lb. Box	Bulk Carton		
# 10	1-1/2	01370	01371	01372	01373	135	5,000



# DRYWALL SCREWS

**SELF DRILLING**  
Phillips Bugle Head

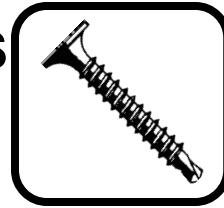

**3**

Dia	Length	Part #				Pieces Per Pound	Pieces Per Bulk Carton
		# / each	1 lb. Box	5 lb. Box	Bulk Carton		
<b># 6</b>	1	01275	02375	02430	02478	323	10,000
	1-1/4	01276	02376	02431	02479	262	8,000
	1-5/8	01277	02377	02432	02480	202	5,000
	1-7/8	01278	02378	02433	02481	172	4,000
<b># 8</b>	2-3/8	01279	02379	02434	02482	110	3,000
	2-5/8	01280	02380	02435	02483	98	2,500
	3	01281	02381	02436	02484	86	2,000



# DRYWALL SCREWS

**TRIM HEAD**  
Square Drive — Sharp-Point



Dia	Length	Part #				Pieces Per Pound	Pieces Per Bulk Carton
		# / each	1 lb. Box	5 lb. Box	Bulk Carton		
<b># 6</b>	1-5/8	01282	02382	02437	02485	266	5,000
	2-1/4	01283	02383	02438	02486	186	3,000
<b># 8</b>	3	01284	02384	02439	02487	104	2,000

# FRAMING (PEANUT) SCREWS

**FOR METAL FRAMING**  
Phillips Drive - Black Phosphate

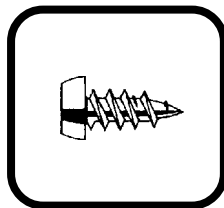

**Sharp-Point**



**SCORPION**  
Brand Products

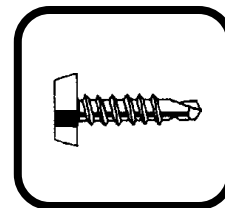

**Drill-Point**

Dia	Length	Part #		Bulk Qty
		# / each	Bulk Carton	
<b>#7</b>	7/16	02385	02387	15000

Dia	Length	Part #		Bulk Qty
		# / each	Bulk Carton	
<b>#6</b>	7/16	02386	02388	15000

# EXTERIOR DECKING SCREWS

## SQUARE DRIVE FLAT HEAD

Self-Drilling Cutter Point

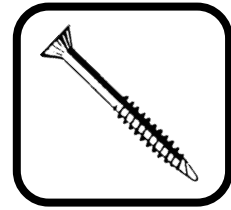

Type XT Ceramic Coated Screws

3

Dia	Length	Part #				Pieces Per Pound	Pieces Per Bulk Carton
		# / each	1 lb. Box	5 lb. Box	Bulk Carton		
# 6	1-1/4	01290	02390	02440	02488	267	8,000
	1-1/2	01291	02391	02441	02489	227	5,000
# 7	2	01292	02392	02442	02490	152	3,500
# 8	2-1/2	01293	02393	02443	02491	109	2,500
	3	01294	02394	02444	02492	87	2,000
# 10	3-1/2	01295	02395	02445	02493	56	1,000
	4	01296	02396	02446	02494	50	1,000
# 10	5	01296A	02396X	02446A	02494A		



**SCORPION**  
Brand Products

### Scorpion XT Coated Screws:

- » High threads for greater holding power.
- » Neat, flush finish.
- » Tested to 500 hours salt spray (ASTM B-117).
- » Maximum corrosion protection for longer life.

# STAINLESS STEEL DECK SCREWS

## SQUARE DRIVE FLAT HEAD

Self-Drilling Cutter Point

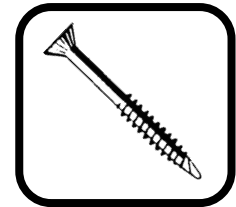

**SCORPION**  
Brand Products

Dia	Length	Part #			Pieces Per Contr. Pak	Pieces Per Bulk Carton
		# / each	Contr. Pak	Bulk Carton		
# 8	1-1/4	01297	02397	02495	500	5,000
	1-1/2	01298	02398	02496	400	4,000
	2	01299	02399	02497	300	3,000
# 10	2-1/2	01300	02400	02498	200	2,000
	3	01301	02401	02499	150	1,500
	3-1/2	01302	02402	02500	100	1,000
	4	01303	02403	02501	100	1,000

# TAPCON™ MASONRY SCREW ANCHORS

## HEX WASHER HEAD & PHILLIPS FLAT HEAD

Fluorocarbon

» Packed 100 screw anchors and 1 carbide tipped drill bit per box.

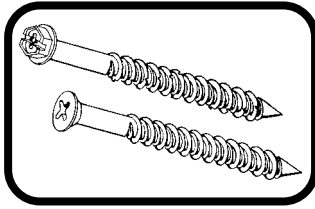

Dia	Length	Drill Bit Size	Fastens Material up to:	Part #	
				Hex Washer	Phillips Flat
<b>3/16</b>	1-1/4	5/32 x 3-1/2	1/4	<b>03350</b>	<b>03365</b>
	1-3/4	5/32 x 3-1/2	3/4	<b>03351</b>	<b>03366</b>
	2-1/4	5/32 x 4-1/2	1-1/4	<b>03352</b>	<b>03367</b>
	2-3/4	5/32 x 4-1/2	1-3/4	<b>03353</b>	<b>03368</b>
	3-1/4	5/32 x 5-1/2	2-1/4	<b>03354</b>	<b>03369</b>
	3-3/4	5/32 x 5-1/2	2-3/4	<b>03355</b>	<b>03370</b>
<b>1/4</b>	1-1/4	3/16 x 3-1/2	1/4	<b>03356</b>	<b>03371</b>
	1-3/4	3/16 x 3-1/2	3/4	<b>03357</b>	<b>03372</b>
	2-1/4	3/16 x 4-1/2	1-1/4	<b>03358</b>	<b>03373</b>
	2-3/4	3/16 x 4-1/2	1-1/2	<b>03359</b>	<b>03374</b>
	3-1/4	3/16 x 5-1/2	2-1/4	<b>03360</b>	<b>03375</b>
	3-3/4	3/16 x 5-1/2	2-3/4	<b>03361</b>	<b>03376</b>
	4	3/16 x 5-1/2	3	<b>03362</b>	<b>03377</b>
	6	3/16 x 7-1/2	5		<b>03378</b>

**3**

### CARBIDE TIPPED MASONRY BITS

For Tapcon™ Masonry Screw Anchors

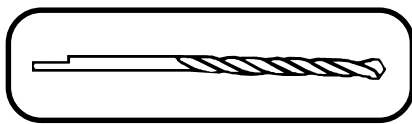

Dia	Length	Part #	Qty
<b>5/32</b>	3-1/2	<b>03380</b>	1
	4-1/2	<b>03381</b>	1
	5-1/2	<b>03382</b>	1
<b>3/16</b>	3-1/2	<b>03383</b>	1
	4-1/2	<b>03384</b>	1
	5-1/2	<b>03385</b>	1

### TAPCON™ CONDRIVE 1000 INSTALLATION TOOL KIT

Part # 03390

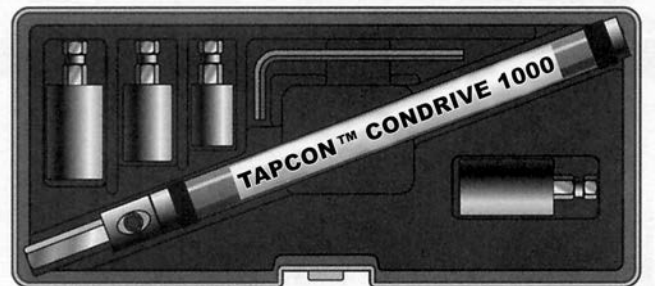

Kit consists of:

- Drill adapter
- Drill adapter sleeve
- #2 Phillips bit
- #3 Phillips bit
- Phillips socket
- 1/4" socket
- 5/16" socket
- 1/8" hex key
- Handy storage box

# FLOOR BOARD SCREWS

## TORX DRIVE FLAT HEAD

Phosphate & Oil Finish



**3**

Recommended Drill Size 7/32

Dia	Length	Drive Size	Part #	Qty
<b>1/4</b> -20 USS Thread	1	T-30	<b>02250</b>	100
	1-1/4	T-30	<b>02251</b>	100
	1-1/2	T-30	<b>02252</b>	100
	1-3/4	T-30	<b>02253</b>	100
	2	T-30	<b>02254</b>	50
	2-1/4	T-30	<b>02255</b>	50
	2-1/2	T-30	<b>02256</b>	50
	2-3/4	T-30	<b>02257</b>	50
	3	T-30	<b>02258</b>	50
	3-1/2	T-30	<b>02259</b>	25
	4	T-30	<b>02260</b>	25
	4-1/2	T-30	<b>02261</b>	25
	5	T-30	<b>02262</b>	25
	6	T-30	<b>02263</b>	25

Recommended Drill Size 9/32

Dia	Length	Drive Size	Part #	Qty
<b>5/16</b> -18 USS Thread	1	T-40	<b>02265</b>	50
	1-1/4	T-40	<b>02266</b>	50
	1-1/2	T-40	<b>02267</b>	50
	1-3/4	T-40	<b>02268</b>	50
	2	T-40	<b>02269</b>	50
	2-1/4	T-40	<b>02270</b>	25
	2-1/2	T-40	<b>02271</b>	25
	3	T-40	<b>02272</b>	25
	3-1/2	T-40	<b>02273</b>	25
	4	T-40	<b>02274</b>	25
	6	T-40	<b>02278</b>	25

- » Type F thread forming.
- » Flat head.



# THREAD CUTTING SCREWS

## HEX WASHER HEAD - TYPE "F"

Bright Zinc Chromate

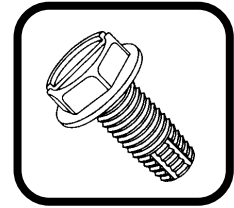

3

Dia	Length	Hex Size	Part #	Qty
<b># 6</b>	3/8	1/4	<b>A5759</b>	100
	1	1/4	<b>A5764</b>	100
<b># 8</b> - 32	3/8	1/4	<b>A5766</b>	100
	1/2	1/4	<b>A5767</b>	100
	5/8	1/4	<b>A5768</b>	100
	3/4	1/4	<b>A5769</b>	100
<b># 10</b> - 24	3/8	5/16	<b>A5773</b>	100
	1/2	5/16	<b>A5774</b>	100
	5/8	5/16	<b>A5775</b>	100
	3/4	5/16	<b>A5776</b>	100
	1	5/16	<b>A5778</b>	100
<b># 12</b> - 24	1/2	5/16	<b>A8437</b>	100
	3/4	5/16	<b>A8438</b>	100
	1	5/16	<b>A8439</b>	100
<b>1/4</b> - 20	3/8	3/8	<b>A5781</b>	100
	1/2	3/8	<b>A5782</b>	100
	5/8	3/8	<b>A5783</b>	100
	3/4	3/8	<b>A5784</b>	100
	1	3/8	<b>A5786</b>	100
	1-1/4	3/8	<b>A5787</b>	100
	1-1/2	3/8	<b>A15354</b>	100
<b>5/16</b> - 18	1/2	1/2	<b>A8441</b>	100
	3/4	1/2	<b>A8442</b>	100
	1	1/2	<b>A8443</b>	100
	1-1/4	1/2	<b>A8444</b>	100
	1-1/2	1/2	<b>A15355</b>	50
	1-3/4	1/2	<b>A15356</b>	50
<b>3/8</b> - 16	3/4	9/16	<b>A11294</b>	50
	1	9/16	<b>A11295</b>	50
	1-1/4	9/16	<b>A11296</b>	25
	1-1/2	9/16	<b>A11297</b>	25
	1-3/4	9/16	<b>A15357</b>	25
	2	9/16	<b>A15358</b>	25

# AUTOMOTIVE SHEET METAL SCREWS

## BLACK OXIDE SHEET METAL SCREWS

Phillips Oval, Flat & Pan Heads

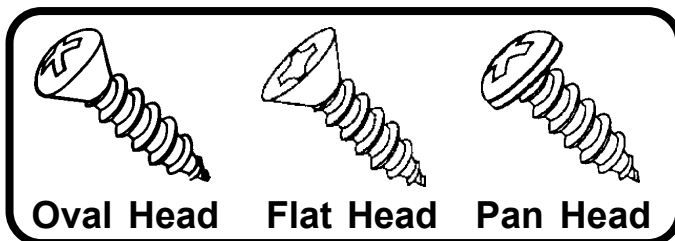

Dia	Head Size	Length	Oval Hd Part #	Qty	Flat Hd Part #	Qty	Pan Hd Part #	Qty
<b># 4</b>	—	1/4	—	—	—	—	A12902	100
	—	3/8	A12893	100	A12899	100	A12903	100
	—	1/2	A12894	100	A12900	100	A12904	100
	—	5/8	A12895	100	—	—	—	—
	—	3/4	A12896	100	—	—	A12905	100
	—	1	A12897	100	—	—	—	—
<b># 6</b>	—	3/8	—	—	—	—	A16889	100
	—	1/2	A12795	100	A12801	100	A11917	100
	—	3/4	A12796	100	A12802	100	A11918	100
	—	1	A12797	100	A12803	100	A11919	100
	—	1-1/4	A12798	100	—	—	A11920	100
<b># 8</b>	6 Hd	1/2	A10162	100	A10173	100	—	—
	—	1/2	A10163	100	A10172	100	A10180	100
	6 Hd	3/4	A10164	100	A10174	100	—	—
	—	3/4	A10165	100	A10175	100	A10181	100
	6 Hd	1	A10166	100	A10176	100	—	—
	—	1	A10167	100	A10177	100	A10182	100
	6 Hd	1-1/4	A10168	100	A10178	100	—	—
	—	1-1/4	A10169	100	A10179	100	A10183	100
	6 Hd	1-1/2	A10170	100	A12805	50	—	—
—	1-1/2	A10171	100	A12806	50	A12799	50	
<b># 10</b>	8 Hd	1/2	A11085	100	—	—	—	—
	—	1/2	A11084	100	A12807	100	A11921	100
	8 Hd	3/4	A11087	100	—	—	—	—
	—	3/4	A11086	100	A12809	100	A11922	100
	8 Hd	1	A11089	100	—	—	—	—
	—	1	A11088	100	A12811	50	A11923	50
	8 Hd	1-1/4	A11091	100	—	—	—	—
	—	1-1/4	A11090	100	—	—	A11924	50
	8 Hd	1-1/2	A11093	100	—	—	—	—
—	1-1/2	A11092	100	—	—	A12800	50	

# AUTOMOTIVE SHEET METAL SCREWS

## PHILLIPS OVAL COUNTERSUNK WASHER HEAD

Chrome or Black Phosphate Finish

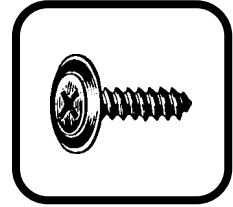

3

Dia	Head Size	Length	Chrome Part #	Qty	Black Part #	Qty
<b># 6</b>	—	5/8	<b>A3537</b>	100	<b>A11784</b>	100
	—	3/4	<b>A3538</b>	100	<b>A11785</b>	100
	—	1	<b>A3539</b>	100	<b>A11786</b>	100
<b># 8</b>	6 Hd	1/2	—	—	<b>A16930</b>	100
	6 Hd	5/8	<b>A2771</b>	100	<b>A11787</b>	100
	6 Hd	3/4	<b>A2751</b>	100	<b>A11788</b>	100
	6 Hd	1	<b>A2772</b>	100	<b>A11789</b>	100
	6 Hd	1-1/4	<b>A2773</b>	100	<b>A11790</b>	100
	6 Hd	1-1/2	<b>A14970</b>	100	—	—
<b># 10</b>	8 Hd	5/8	<b>A3465</b>	100	<b>A14972</b>	100
	8 Hd	3/4	<b>A3466</b>	100	<b>A11791</b>	50
	8 Hd	1	<b>A3467</b>	100	<b>A11792</b>	50
	8 Hd	1-1/4	<b>A3468</b>	100	<b>A14973</b>	50

# AUTOMOTIVE SHEET METAL SCREWS

## PHILLIPS OVAL FLUSH WASHER HEAD

Chrome or Black Phosphate Finish

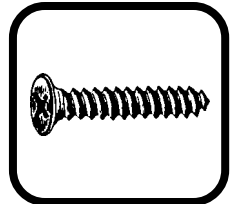

Dia	Head Size	Length	Chrome Part #	Qty	Black Part #	Qty
<b># 8</b>	6 Hd	1/2	—	—	<b>A12956</b>	100
	6 Hd	5/8	<b>A2774</b>	100	<b>A10652</b>	100
	6 Hd	11/16	—	—	<b>A10653</b>	100
	6 Hd	7/8	<b>A2775</b>	100	—	—
	6 Hd	1	—	—	<b>A12957</b>	100
	6 Hd	1-1/4	—	—	<b>A10654</b>	100
<b># 10</b>	8 Hd	1	—	—	<b>A17657</b>	50

# AUTOMOTIVE SHEET METAL SCREWS

## PHILLIPS OVAL HEAD SELF DRILLING FINISHING SCREW

Chrome, Phosphate or Statuary Bronze Finish

Countersunk

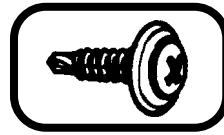
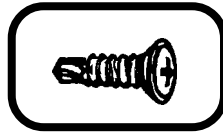

Flush

3

Dia	Length	Washer Type	Chrome Part #	Qty	Phos. Part #	Qty	Bronze Part #	Qty
# 8	5/8	Flush	A11448	100	A11453	100	—	—
	5/8	Ctrsnk	A11449	100	A11454	100	—	—
	3/4	Ctrsnk	A11450	100	A11455	100	A11460	100
	1	Ctrsnk	A11451	50	A11456	50	—	—
	1-1/4	Ctrsnk	A11452	50	A11457	50	—	—

» With number 2 drill point.

## PHILLIPS FLAT TOP WASHER HEAD

Zinc or Black Oxide Finish

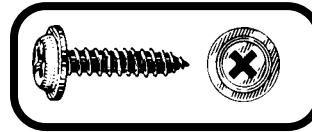

Dia	Length	Washer Head O.D.	Zinc Part #	Qty	Black Part #	Qty
# 6	1/2	3/8	—	—	A12950	100
	3/4	3/8	—	—	A12951	100
	1	3/8	—	—	A12952	100
# 8	1/2	13/32	A14589	100	A12213	100
	5/8	13/32	A14860	100	A12214	100
	3/4	13/32	A14861	100	A12215	100
	1	13/32	A14862	100	A12216	100
	1-1/4	13/32	—	—	A12217	50
	1-1/2	13/32	—	—	A12218	50
	2	13/32	—	—	A19798	50
# 10	3/4	15/32	—	—	A12953	50
	1	15/32	—	—	A12954	50
	1-1/4	15/32	—	—	A12955	50

## PHILLIPS PAN HEAD SEMS®

Black Phosphate Finish

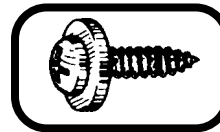

Dia	Length	Washer O.D.	Part #	Qty
# 8	1/2	1/2	A12818	50
	3/4	1/2	A12820	50
	1	1/2	A12821	50

# AUTOMOTIVE SHEET METAL SCREWS

## METRIC TORX® HEAD 300 Stainless Steel

3

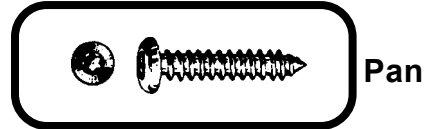
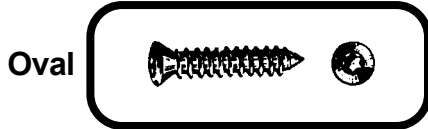

Size	Head Style	Finish	Part #	Qty
4.2 x 13mm	M8 Pan	Chrome	A14572	50
4.2 x 16mm	M8 Pan	Black	A14052	50
4.2 x 20mm	M7 Oval	Chrome	A11937	50
4.2 x 20mm	M7 Oval	Black Ox	A11938	50
4.2 x 20mm	M8 Oval	Chrome	A14950	50
4.2 x 20mm	M8 Pan	Chrome	A11943	50
4.2 x 20mm	M8 Pan	Black Ox	A11944	50
4.2 x 20mm	M8 Pan	Black Ox	A14051*	50
4.2 x 25mm	M8 Pan	Black Ox	A14046	50
4.2 x 25mm	M8 Pan	Chrome	A14049	50
4.2 x 25mm	M7 Oval	Black	A14053	50
4.2 x 25mm	M7 Oval	Chrome	A14569	50
4.2 x 30mm	M7 Oval	Chrome	A11939	50
4.2 x 30mm	M7 Oval	Black Ox	A11940	50
4.2 x 30mm	M8 Pan	Black Ox	A14050	50
4.2 x 35mm	M8 Pan	Chrome	A11945	25
4.2 x 35mm	M7 Oval	Black	A14047	50
4.2 x 40mm	M7 Oval	Chrome	A11941**	25
4.2 x 55mm	M8 Pan	Black Ox	A14952**	50

\* 12mm Washer O.D. Sems

\*\* Not fully threaded



# FAS-KIT<sup>®</sup> SCREW ASSORTMENTS



3

Plastic Box Assortments		
Part Number	Description	Number of Pieces
FK01000	Phillips Pan Head Sheet Metal Screws - Zinc Plated	310
FK01010	Phillips Pan Head Sheet Metal Screws - Zinc Plated	540
FK01050	Combo Pan Head Sheet Metal Screws - Zinc Plated	310
FK01100	Phillips Flat Head Sheet Metal Screws - Zinc Plated	310
FK01110	Sl. Hex Washer Head Sheet Metal Screws - Zinc Plated	310
FK01130	Phillips Oval Washer Hd Sheet Metal Scr - Chrome Plated	180
FK01200	Phillips Pan Head Self Drilling Screws - Zinc Plated	276
FK01300	Hex Washer Head Self Drilling Screws - Zinc Plated	255
FK01350	Phillips Coarse Thread Drywall Screws	330
FK01355	Square Drive Exterior Decking Screws	280
FK01400	Phillips Flat Head Wood Screws - Zinc Plated	300
FK01500	Slotted Round Head Machine Screws - Zinc Plated	515
FK01600	Phillips Pan Head Machine Screws - Zinc Plated	596

Metal Tray Assortments			
Small Drawer	Large Drawer	Description	Number of Pieces
FK10000	FK50000	Slotted Pan Head Sheet Metal Screws - Zinc Plated	1275
FK10050	FK50050	Phillips Pan Head Sheet Metal Screws - Zinc Plated	1275
FK10100	FK50100	Phillips Pan Head Sheet Metal Screws - Zinc Plated	1125
FK10150	FK50150	Combo Pan Head Sheet Metal Screws - Zinc Plated	700
FK10250	FK50250	Phillips Flat Head Sheet Metal Screws - Zinc Plated	1275
FK10350	FK50350	Phillips Oval Head Sheet Metal Screws - Zinc Plated	650
FK10450	FK50450	Phillips Pan Head Self Drilling Screws - Zinc Plated	851
FK10500	FK50500	Hex Washer Head Self Drilling Screws - Zinc Plated	703
FK10550	FK50550	SI Hex Washer Head Sheet Metal Screws - Zinc Plated	660
FK10600	FK50600	SI Hex Washer Head Sheet Metal Screws - Zinc Plated	750
FK10620	FK50620	SI Hex Washer Head Thread Cutting Screws - Zinc Plated	640
FK10640	FK50640	Phillips Coarse Thread Drywall Screws	8 lbs.
FK10660	FK50660	Phillips Fine Thread Drywall Screws	8 lbs.
FK10670	FK50670	Phillips Self Drilling Drywall Screws	8 lbs.
FK10680	FK50680	Square Drive Exterior Decking Screws	8 lbs.
FK10700	FK50700	Slotted Flat Head Wood Screw - Zinc Plated	950
FK10850	FK50850	Phillips Flat Head Wood Screw - Zinc Plated	950
FK11050	FK51050	SI Round Head Machine Screws - Zinc Plated	1330
FK11100	FK51100	SI Round Head Machine Screws - Zinc Plated	1950
FK11150	FK51150	SI Round Head Machine Screws - Zinc Plated	1700
FK11200	FK51200	SI Round Head Machine Screws - Zinc Plated	2075
FK11250	FK51250	SI Round Head Machine Screws - Zinc Plated	1925



# FAS-KIT<sup>®</sup> SCREW ASSORTMENTS



Metal Tray Assortments - cont'd			
Small Drawer	Large Drawer	Description	Number of Pieces
FK11400	FK51400	SI Pan Head Machine Screws - Zinc Plated	1815
FK11450	FK51450	Phillips Flat Head Machine Screws - Zinc Plated	1375
FK11500	FK51500	Phillips Pan Head Machine Screws - Zinc Plated	1715
FK11550	FK51550	SI Flat Head Machine Screws - Zinc Plated	1150
FK11700	FK51700	Thumb Screws - Zinc Plated	200
FK11800	FK51800	Indented Hex Head Machine Screws - Zinc Plated	1400
FK17100	FK57100	Phillips Flat Head Tapcon™ Screws	404
FK17150	FK57150	Hex Washer Head Tapcon™ Screws	404
-	FK57170	Phillips Flat & Hex Washer Head Tapcon™ Screws	408
FK18800	FK58800	Phillips Pan Head Sheet Metal Screws - Black Oxide	555
FK18850	FK58850	Phillips Oval Head Sems Screws - Chrome Plated	300
FK18900	FK58900	Phillips Flat Washer Head Tapping Screws - Black Oxide	475





# Section 4: Pins, Rings & Rivets

## Table of Contents

### Pins

Cotter Pins, <i>Extended Prong Zinc Plated</i> .....	3
Roll Pins (Spring Pins) .....	4
Dowel Pins .....	5-6
Hitch Pin Clips, <i>Zinc Plated</i> .....	7-9
External Hitch Pin Clips, <i>Zinc Plated</i> .....	10
S-Hooks, <i>Zinc Plated</i> .....	11
Universal Clevis Pins .....	12
Standard Clevis Pins .....	12
Hitch Pins .....	13
Snapper Pins .....	14
Lynch Pins .....	14

### Machinery Parts

Woodruff Keys .....	15
Square Key Stock & Keys .....	15
Shaft Collars, <i>One Piece Set Screw Style</i> .....	16
Bronze Bushings .....	16
Machinery Bushings, <i>Plain Steel</i> .....	17
Roller Chain Links .....	17
Precision Steel Balls .....	18

### Retaining Rings

Internal .....	19
External .....	19
E-Type .....	19

### Blind Rivets

Dome Head, <i>Aluminum, Steel &amp; Stainless</i> .....	20
Countersunk Head, <i>Aluminum, Steel &amp; Stainless</i> .....	21
Large Flange, <i>Aluminum, Steel &amp; Stainless</i> .....	21
Painted Dome Head, <i>White, Brown &amp; Black</i> .....	22
Copper Dome Head .....	22
Rivet Washers, <i>Aluminum &amp; Steel</i> .....	22
Peel Type Automotive Rivets .....	23
Rivet Guns .....	23

<b>Faskit Assortments</b> .....	24
---------------------------------	----



# COTTER PINS

## EXTENDED PRONG

Zinc Plated

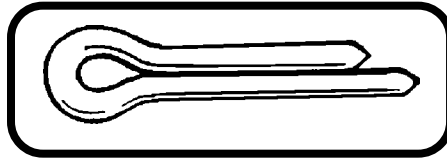

4

Dia	Length	Part #	Qty
<b>1/16</b>	1/2	00385	100
	3/4	00386	100
	1	00387	100
	1-1/4	01134	100
	1-1/2	01135	100
	2	01140	100
<b>3/32</b>	1/2	00388	100
	3/4	00389	100
	1	00390	100
	1-1/4	00391	100
	1-1/2	00392	100
	2	01138	100
<b>1/8</b>	2-1/2	01141	100
	1	00394	100
	1-1/4	01136	100
	1-1/2	00395	100
	1-3/4	00396	100
	2	00397	100
<b>5/32</b>	2-1/2	01830	50
	3	01831	50
	1	00398	100
	1-1/4	01137	100
	1-1/2	00399	100
	1-3/4	00400	100
<b>3/16</b>	2	00401	50
	2-1/2	01470	50
	3	01471	50
	1	01832	50
	1-1/4	01833	50
	1-1/2	01472	50
<b>1/2</b>	1-3/4	01473	50
	2	01474	50
	2-1/2	01475	50
	3	01476	50
	3-1/2	01477	50
	4	01834	50

Dia	Length	Part #	Qty
<b>1/4</b>	1	01835	50
	1-1/4	01836	50
	1-1/2	01837	50
	1-3/4	01838	50
	2	01839	50
	2-1/2	01840	50
<b>5/16</b>	3	01841	50
	3-1/2	01842	50
	4	01843	50
	1	01899	50
	1-1/2	01900	50
	2	01901	50
<b>3/8</b>	2-1/2	01902	25
	3	01903	25
	3-1/2	01904	25
	4	01906	25
	5	01907	25
	1-1/2	01908	25
<b>1/2</b>	2	01909	25
	2-1/2	01910	25
	3	01911	25
	3-1/2	01912	25
	4	01913	25
	5	01914	25
<b>3/4</b>	6	01915	25
	2	01139	25
	3	01875	25
	4	01876	20
	5	01877	20
	6	01878	20

# ROLL (SPRING) PINS

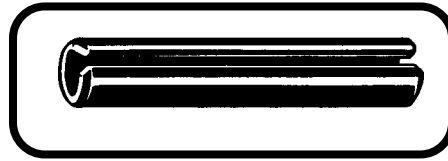

**4**

Dia	Length	Part #	Qty
<b>1/16</b>	3/16	<b>02518</b>	50
	5/16	<b>02519</b>	50
	1/2	<b>02520</b>	50
	5/8	<b>02521</b>	50
	3/4	<b>02522</b>	50
	7/8	<b>02523</b>	50
	1	<b>02524</b>	50
<b>5/64</b>	1/4	<b>02525</b>	50
	1/2	<b>02526</b>	50
	9/16	<b>02527</b>	50
	3/4	<b>02528</b>	50
	1	<b>02529</b>	50
	1-1/4	<b>02530</b>	50
1-1/2	<b>02531</b>	50	
<b>3/32</b>	5/16	<b>02532</b>	50
	1/2	<b>02533</b>	50
	5/8	<b>02534</b>	50
	3/4	<b>02535</b>	50
	7/8	<b>02536</b>	50
	1	<b>02537</b>	50
	1-1/4	<b>02538</b>	50
	1-1/2	<b>02539</b>	50
<b>1/8</b>	3/8	<b>02540</b>	50
	1/2	<b>02541</b>	50
	5/8	<b>02542</b>	50
	3/4	<b>02543</b>	50
	7/8	<b>02544</b>	50
	1	<b>02545</b>	50
	1-1/4	<b>02546</b>	50
	1-1/2	<b>02547</b>	50
	1-3/4	<b>02548</b>	50
	2	<b>02549</b>	50
<b>5/32</b>	1/2	<b>02550</b>	50
	5/8	<b>02551</b>	50
	3/4	<b>02552</b>	50
	1	<b>02553</b>	50
	1-1/4	<b>02554</b>	50
	1-1/2	<b>02555</b>	50

Dia	Length	Part #	Qty
<b>3/16</b>	1/2	<b>02556</b>	50
	5/8	<b>02557</b>	50
	3/4	<b>02558</b>	50
	1	<b>02559</b>	50
	1-1/4	<b>02560</b>	25
	1-1/2	<b>02561</b>	25
	1-3/4	<b>02562</b>	25
2	<b>02563</b>	25	
<b>7/32</b>	5/8	<b>02564</b>	25
	1-3/8	<b>02565</b>	25
	1-3/4	<b>02566</b>	25
<b>1/4</b>	5/8	<b>02567</b>	25
	3/4	<b>02568</b>	25
	7/8	<b>02569</b>	25
	1	<b>02570</b>	25
	1-1/4	<b>02571</b>	25
	1-1/2	<b>02572</b>	25
	1-3/4	<b>02573</b>	25
	2	<b>02574</b>	25
	2-1/4	<b>02575</b>	25
	2-1/2	<b>02576</b>	25
<b>5/16</b>	3/4	<b>02577</b>	25
	7/8	<b>02578</b>	25
	1	<b>02579</b>	25
	1-1/2	<b>02580</b>	25
	1-3/4	<b>02581</b>	25
	2	<b>02582</b>	25
	2-1/2	<b>02583</b>	25
<b>3/8</b>	3/4	<b>02584</b>	25
	1	<b>02585</b>	25
	1-1/2	<b>02586</b>	25
	2	<b>02587</b>	25
	2-1/2	<b>02588</b>	25

# DOWEL PINS

## ALLOY STEEL

Chamfered Ends

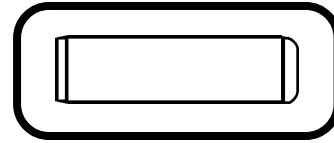

Dia	Length	Part #	Qty
<b>1/16</b>	3/16	<b>01600</b>	50
	1/4	<b>01601</b>	50
	5/16	<b>01602</b>	50
	3/8	<b>01603</b>	50
	7/16	<b>01604</b>	50
	1/2	<b>01605</b>	50
	5/8	<b>01606</b>	50
	3/4	<b>01607</b>	50
	7/8	<b>01608</b>	50
1	<b>01609</b>	50	
<b>3/32</b>	3/16	<b>01610</b>	50
	1/4	<b>01611</b>	50
	5/16	<b>01612</b>	50
	3/8	<b>01613</b>	50
	7/16	<b>01614</b>	50
	1/2	<b>01615</b>	50
	5/8	<b>01616</b>	50
	3/4	<b>01617</b>	50
7/8	<b>01618</b>	50	
<b>1/8</b>	3/8	<b>01619</b>	50
	1/2	<b>01620</b>	50
	5/8	<b>01621</b>	50
	3/4	<b>01622</b>	50
	7/8	<b>01623</b>	50
	1	<b>01624</b>	50
	1-1/4	<b>01625</b>	50
	1-1/2	<b>01626</b>	50
	1-3/4	<b>01627</b>	50
2	<b>01628</b>	50	
<b>3/16</b>	1/2	<b>01629</b>	50
	5/8	<b>01630</b>	50
	3/4	<b>01631</b>	50
	7/8	<b>01632</b>	50
	1	<b>01633</b>	50
	1-1/4	<b>01634</b>	25
	1-1/2	<b>01635</b>	25
	1-3/4	<b>01636</b>	25
	2	<b>01637</b>	25

Dia	Length	Part #	Qty
<b>1/4</b>	3/8	<b>01638</b>	25
	1/2	<b>01639</b>	25
	5/8	<b>01640</b>	25
	3/4	<b>01641</b>	25
	7/8	<b>01642</b>	25
	1	<b>01643</b>	25
	1-1/4	<b>01644</b>	25
	1-1/2	<b>01645</b>	25
	1-3/4	<b>01646</b>	25
2	<b>01647</b>	25	
2-1/4	<b>01648</b>	25	
2-1/2	<b>01649</b>	25	
<b>5/16</b>	1/2	<b>01650</b>	25
	5/8	<b>01651</b>	25
	3/4	<b>01652</b>	25
	7/8	<b>01653</b>	25
	1	<b>01654</b>	25
	1-1/4	<b>01655</b>	25
	1-1/2	<b>01656</b>	25
	1-3/4	<b>01657</b>	25
	2	<b>01658</b>	25
2-1/4	<b>01659</b>	25	
2-1/2	<b>01660</b>	20	
3	<b>01661</b>	20	
<b>3/8</b>	1/2	<b>01662</b>	25
	5/8	<b>01663</b>	25
	3/4	<b>01664</b>	25
	7/8	<b>01665</b>	25
	1	<b>01666</b>	25
	1-1/4	<b>01667</b>	25
	1-1/2	<b>01668</b>	25
	1-3/4	<b>01669</b>	25
	2	<b>01670</b>	25
2-1/4	<b>01671</b>	20	
2-1/2	<b>01672</b>	20	
3	<b>01673</b>	10	

# DOWEL PINS

## ALLOY STEEL

Chamfered Ends

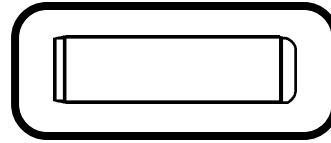

**4**

Dia	Length	Part #	Qty
<b>7/16</b>	1	<b>01674</b>	25
	1-1/4	<b>01675</b>	25
	1-1/2	<b>01676</b>	25
	1-3/4	<b>01677</b>	25
	2	<b>01678</b>	25
	2-1/2	<b>01679</b>	10
	3	<b>01680</b>	10
<b>1/2</b>	3/4	<b>01681</b>	25
	1	<b>01682</b>	25
	1-1/4	<b>01683</b>	25
	1-1/2	<b>01684</b>	25
	1-3/4	<b>01685</b>	25
	2	<b>01686</b>	25
	2-1/4	<b>01687</b>	10
	2-1/2	<b>01688</b>	10
	3	<b>01689</b>	10
	3-1/2	<b>01690</b>	10
4	<b>01691</b>	10	
<b>5/8</b>	1	<b>01692</b>	10
	1-1/4	<b>01693</b>	10
	1-1/2	<b>01694</b>	10
	1-3/4	<b>01695</b>	10
	2	<b>01696</b>	5
	2-1/4	<b>01697</b>	5
	2-1/2	<b>01698</b>	5
	3	<b>01699</b>	5
	3-1/2	<b>01700</b>	1
	4	<b>01701</b>	1
	4-1/2	<b>01702</b>	1
5	<b>01703</b>	1	

Dia	Length	Part #	Qty
<b>3/4</b>	2	<b>01704</b>	5
	2-1/2	<b>01705</b>	5
	3	<b>01706</b>	1
	3-1/2	<b>01707</b>	1
	4	<b>01708</b>	1
	4-1/2	<b>01709</b>	1
	5	<b>01710</b>	1
6	<b>01711</b>	1	
<b>7/8</b>	2	<b>01712</b>	1
	2-1/2	<b>01713</b>	1
	3	<b>01714</b>	1
	3-1/2	<b>01715</b>	1
	4	<b>01716</b>	1
	4-1/2	<b>01717</b>	1
	5	<b>01718</b>	1
6	<b>01719</b>	1	
<b>1"</b>	2	<b>01720</b>	1
	2-1/2	<b>01721</b>	1
	3	<b>01722</b>	1
	3-1/2	<b>01723</b>	1
	4	<b>01724</b>	1
	4-1/2	<b>01725</b>	1
5	<b>01726</b>	1	

# HITCH PIN CLIPS

Zinc Plated Steel

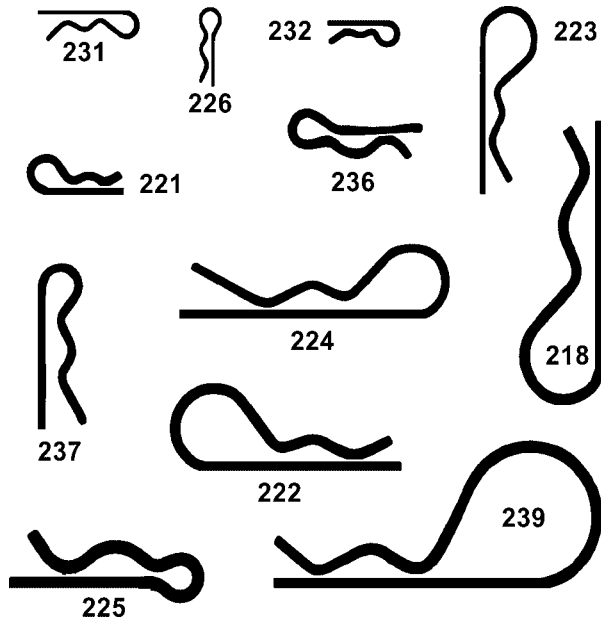

Wire Dia	Drill Hole Size	Min Shaft Dia	Max Shaft Dia	Overall Length	Inside Dia of Eye	Part #	Qty
.028	1/32	1/8	5/32	.600	.093	WW231	100
.035	.40	7/64	9/64	7/16	.078	WW226	100
.042	.047	1/16	1/8	7/16	.080	WW232	100
.042	3/64	3/16	1/4	1	1/4	WW223	100
.047	1/16	1/8	3/16	19/32	1/8	WW221	100
.047	1/16	1/4	3/8	1-9/16	5/16	WW224	100
.054	1/16	3/16	1/4	3/4	1/8	WW236	100
.054	1/16	1/4	3/8	7/8	9/64	WW237	100
.062	5/64	1/4	1/2	1-5/16	5/16	WW222	100
.062	5/64	3/8	1/2	1-9/16	5/16	WW218	100
.072	5/64	5/16	3/8	1-3/32	9/64	WW225	100
.072	5/64	3/8	1/2	1-7/8	5/8	WW239	100

4

Wire Dia	Drill Hole Size	Min Shaft Dia	Max Shaft Dia	Overall Length	Inside Dia of Eye	Part #	Qty
.080	3/32	1/4	3/8	1-3/16	1/4	WW213	100
.080	3/32	3/8	1/2	1-9/16	5/16	WW217	100
.093	7/64	1/4	1/2	1-5/8	3/8	WW203	100
.093	7/64	1/4	5/8	2-5/16	5/8	WW207	100
.093	7/64	3/8	1/2	2	5/8	WW287	100
.093	7/64	3/8	3/4	2-1/2	7/16	WW214	100
.093	7/64	1/4	1/2	1-1/8	1/4	WW233	100
.102	.125	5/16	5/16	1-1/4	1/8	WW230	100

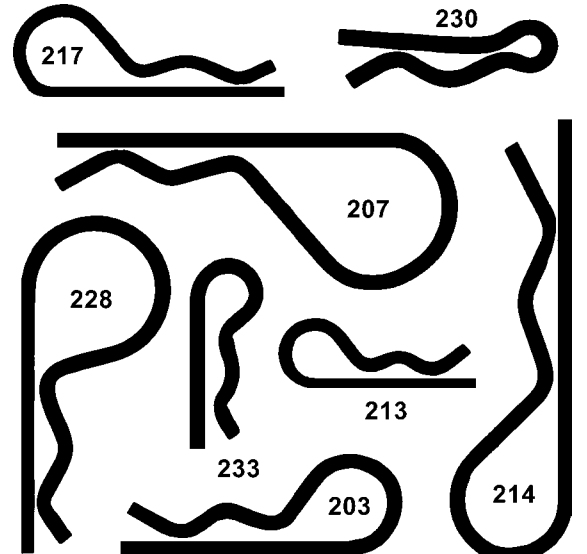

# HITCH PIN CLIPS

Zinc Plated Steel

4

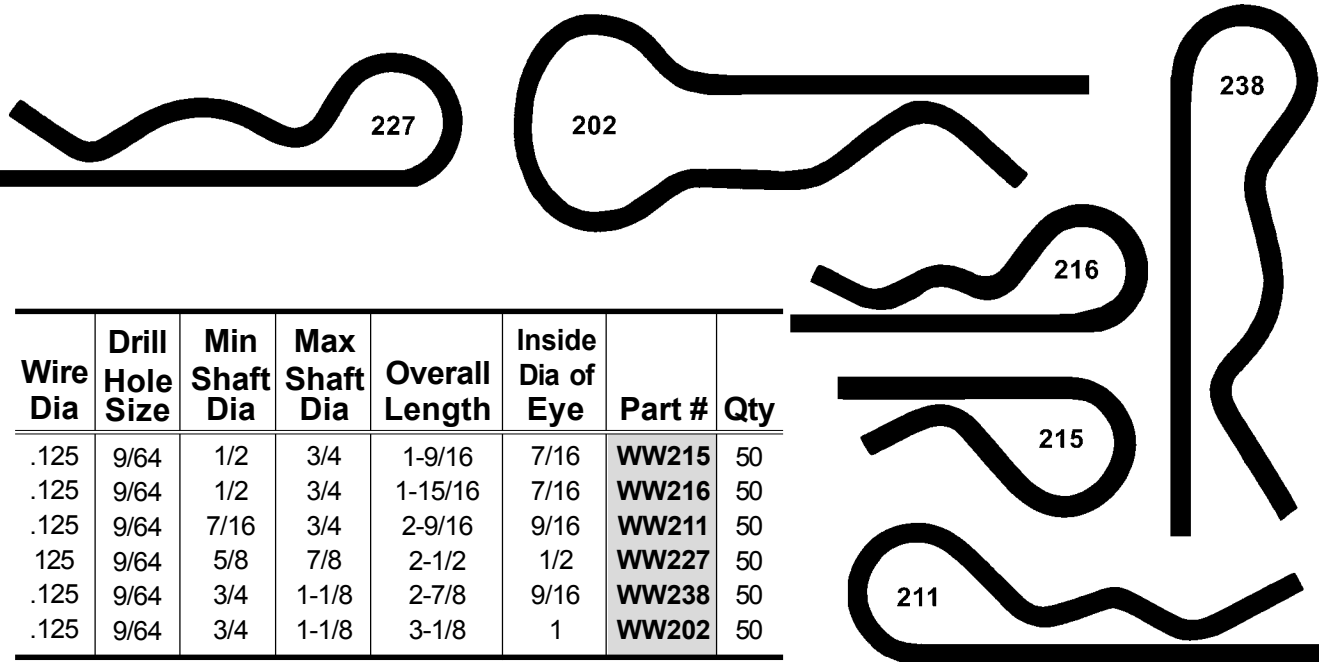

Wire Dia	Drill Hole Size	Min Shaft Dia	Max Shaft Dia	Overall Length	Inside Dia of Eye	Part #	Qty
.125	9/64	1/2	3/4	1-9/16	7/16	WW215	50
.125	9/64	1/2	3/4	1-15/16	7/16	WW216	50
.125	9/64	7/16	3/4	2-9/16	9/16	WW211	50
.125	9/64	5/8	7/8	2-1/2	1/2	WW227	50
.125	9/64	3/4	1-1/8	2-7/8	9/16	WW238	50
.125	9/64	3/4	1-1/8	3-1/8	1	WW202	50

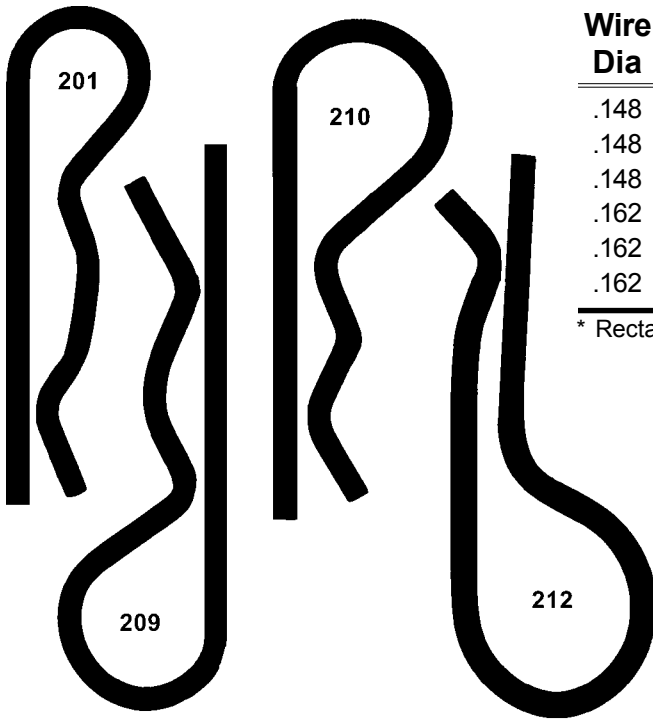

Wire Dia	Drill Hole Size	Min Shaft Dia	Max Shaft Dia	Overall Length	Inside Dia of Eye	Part #	Qty
.148	5/32	1/2x5/8	5/8x1*	3	1/2	WW201	25
.148	5/32	3/4	1-1/8	3-5/16	3/4	WW209	25
.148	5/32	5/8	1	2-15/16	3/4	WW210	25
.162	3/16	7/8	1-1/16	2-3/16	7/8	WW205	25
.162	3/16	1/2x3/4	5/8x1*	3	5/8	WW204	25
.162	11/64	1/2x1	7/8x1*	3-7/16	7/8	WW212	25

\* Rectangular shaft

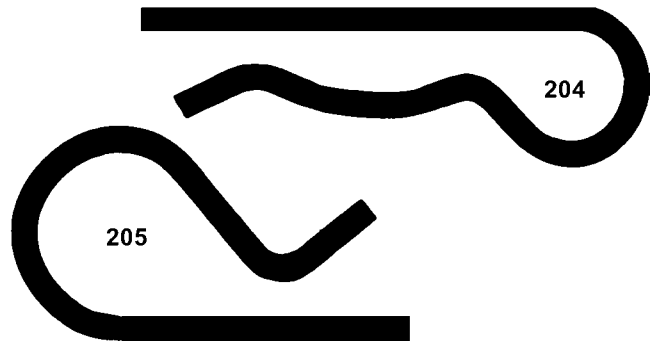



# HITCH PIN CLIPS

Zinc Plated Steel

Wire Dia	Drill Hole Size	Min Shaft Dia	Max Shaft Dia	Overall Length	Inside Dia of Eye	Part #	Qty
.177	3/16	3/4	1-1/16	3-1/2	1	WW229	10
.177	3/16	5/8	1	3-1/4	7/8	WW206	10
.177	3/16	7/8	1-1/4	3-3/4	7/8	WW208	10
.243	17/64	3/4	1	4	15/16	WW219	10
.243	17/64	1-1/4	1-1/2	5-1/4	1-3/8	WW235	10
.250	17/64	3/4	1	3-1/4	3/4	WW234*	10
.310	21/64	7/8	1	3-15/16	7/8	WW220	10

\* Not Plated

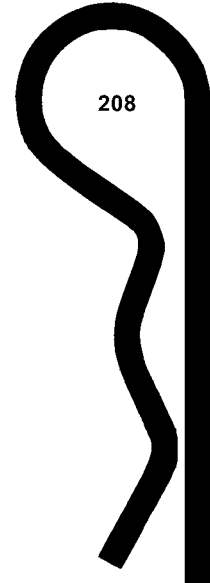

4

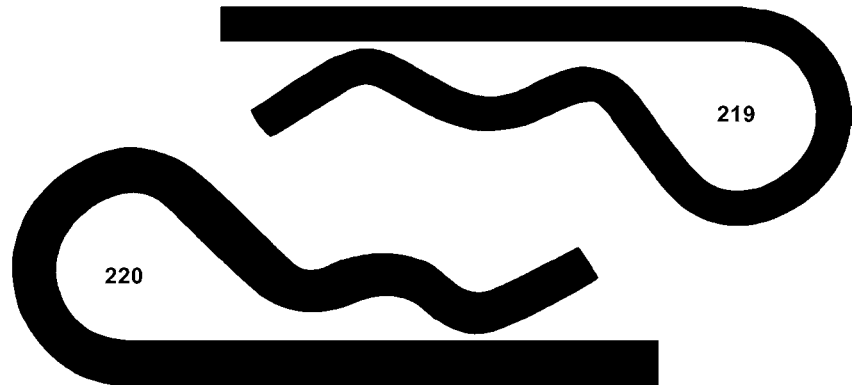
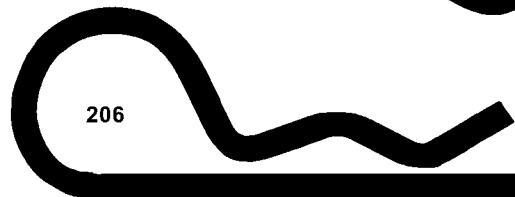
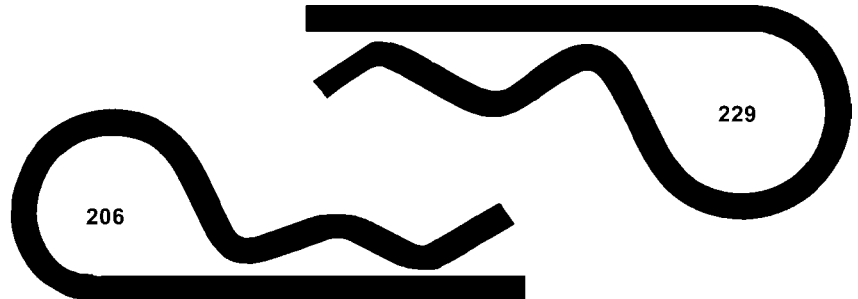
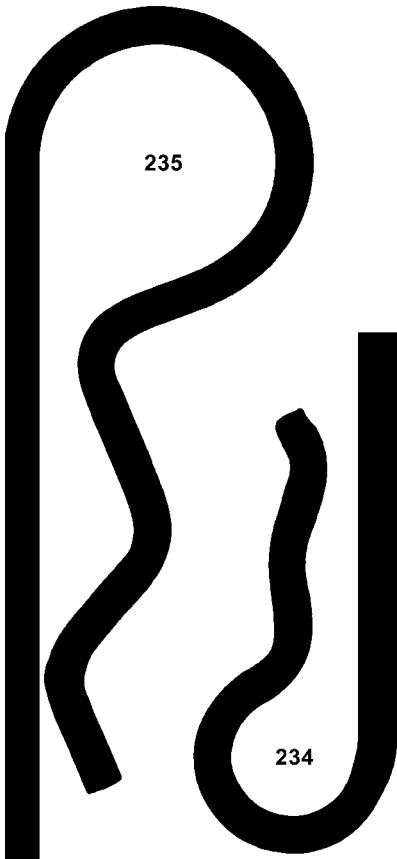

# EXTERNAL HITCH PIN CLIPS

Zinc Plated Steel

4

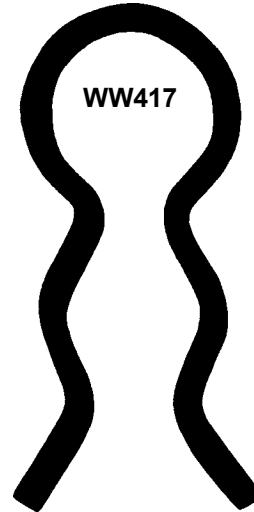
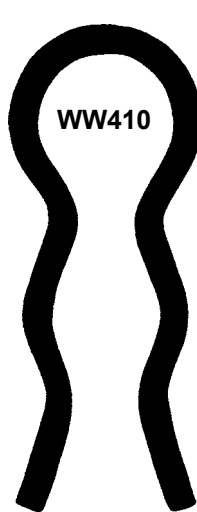
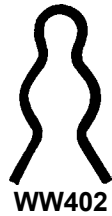

Wire Dia	Inside Eye Dia	Grove Dia	Overall Length	Part #	Qty
.026	1/16	3/32	3/8	WW415	50
.028	3/32	1/8	7/16	WW418	50
.028	1/16	3/32	1/2	WW409	50
.028	1/16	5/64	9/32	WW413	50
.035	3/32	7/32	5/8	WW411	50
.035	3/32	5/32	15/32	WW401	50
.035	1/8	5/32	1/2	WW405	50
.047	3/32	1/8	7/16	WW422	50
.047	7/64	3/16	19/32	WW416	50
.047	1/8	1/4	7/8	WW404	50
.062	3/16	3/8	1	WW402	50
.062	1/8	1/4	11/16	WW403	50
.062	5/32	5/16	3/4	WW412	50
.105	7/16	25/32	2-1/16	WW407	50
.125	7/16	25/32	2-1/16	WW414	50
.177	3/4	11/16	2-3/4	WW410	50
.187	7/8	3/4	2-7/8	WW417	50

» A general purpose snap-on clip made of MB spring wire for countless commercial and industrial requirements

# “S” HOOKS

## FOR LIGHTING FIXTURES - CANVAS TIEDOWNS

Zinc Plated

Dia	Length	Part #	Qty
.080	1-1/16	S-1	100
.093	7/8	S-5	100
.105	1-3/32	S-2	100
.120	1-5/16	S-3	100
.120	2-1/8	S-7	50
.135	1-9/16	S-4	50
.148	2	S-9	50
.162	1-7/16	S-8	50
.177	2	S-6	25
.177	2-7/8	S-13	25
.188	2-7/8	S-10	25
.250	2-1/2	S-11	25
.312	2-5/8	S-12	25

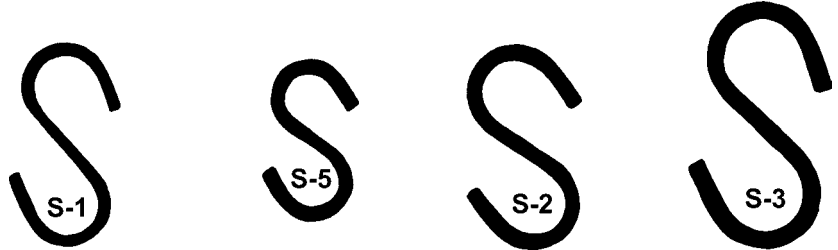

4



# CLEVIS PINS

## UNIVERSAL & STANDARD TYPES

Heat Treated

### Universal Type



Dia	Length	Part #	Qty
1/4	2	08329	25
5/16	2	08427	25
3/8	2	08421	25
7/16	2	08828	25
7/16	2-1/2	09035	25
7/16	3	10057	25
1/2	2	08829	25
1/2	2-1/2	09036	25
1/2	3	10058	25
5/8	3	10059	10
3/4	3	10060	10

### Standard Type

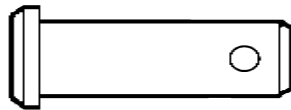

Dia	Length	Part #	Qty
3/16	1/2	08200	20
3/16	3/4	08201	20
3/16	1	08203	20
1/4	3/4	08210	20
1/4	1	08211	20
1/4	1-1/4	08212	20
1/4	1-1/2	08213	20
1/4	1-3/4	08214	20
1/4	2	08215	20
5/16	1	08220	20
5/16	1-1/4	08221	20
5/16	1-1/2	08222	20
5/16	1-3/4	08223	20
5/16	2	08224	20
3/8	1	08230	20

Dia	Length	Part #	Qty
3/8	1-1/4	08231	20
3/8	1-1/2	08232	20
3/8	1-3/4	08233	20
3/8	2	08234	20
3/8	2-1/2	08236	20
7/16	1	08240	10
7/16	1-1/4	08241	10
7/16	1-1/2	08242	10
7/16	2	08243	10
1/2	1	08250	10
1/2	1-1/4	08251	10
1/2	1-1/2	08252	10
1/2	1-3/4	08253	10
1/2	2	08254	10
1/2	2-1/2	08256	10

# HITCH PINS

Zinc Dichromate Plated

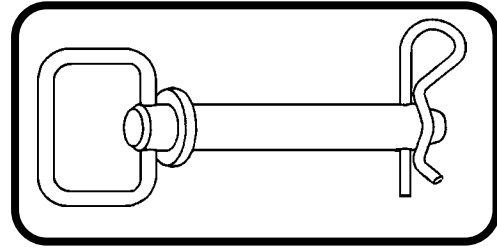

Dia	Length	Part #	Qty
<b>3/8</b>	4-3/8	<b>05850</b>	1
<b>1/2</b>	4-3/4	<b>05851</b>	1
	6-1/2	<b>05852</b>	1
<b>5/8</b>	4-3/4	<b>05853</b>	1
	5-3/4	<b>05854</b>	1
	6-1/2	<b>05855</b>	1
	6-3/4	<b>05856</b>	1
<b>3/4</b>	4-3/4	<b>05857</b>	1
	5	<b>05858</b>	1
	6	<b>05859</b>	1
	7	<b>05860</b>	1

Dia	Length	Part #	Qty
<b>7/8</b>	5-1/4	<b>05861</b>	1
	7-1/2	<b>05862</b>	1
	8	<b>05863</b>	1
<b>1</b>	5-3/4	<b>05864</b>	1
	7-3/4	<b>05865</b>	1
	8	<b>05866</b>	1
<b>1-1/8</b>	7-3/4	<b>05867</b>	1
<b>1-1/4</b>	7-3/4	<b>05868</b>	1
<b>1-3/8</b>	9	<b>05869</b>	1
<b>1-1/2</b>	9	<b>05870</b>	1

**4**

# HITCH PINS

**WITH LYNCH PINS ATTACHED**  
Pins-Zinc Dichromate Plated / Chains-Zinc Plated

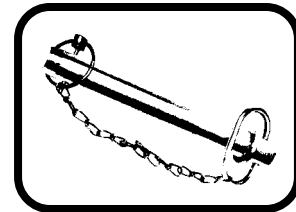

Dia	Length	Part #	Qty
<b>1/2</b>	4-3/4	<b>05875</b>	1
	6-1/2	<b>05876</b>	1
<b>5/8</b>	4-3/4	<b>05877</b>	1
	6-1/2	<b>05878</b>	1

Dia	Length	Part #	Qty
<b>3/4</b>	4-3/4	<b>05879</b>	1
	7	<b>05880</b>	1
<b>7/8</b>	8	<b>05881</b>	1
<b>1</b>	8	<b>05882</b>	1

# SNAPPER PINS

Zinc Plated

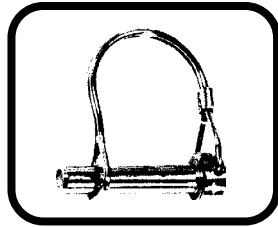

28-01  
28-03

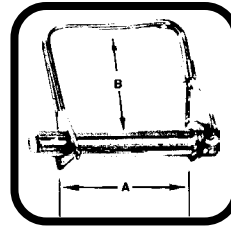

28-02  
28-04  
28-07

Pin Dia	Useable Length (A)	Clearance (B)	Part #	Qty
1/4	1-3/4	1-1/2	28-01	1
5/16	2-1/2	1-5/8	28-02	1
3/8	1-1/2	1-1/2	28-03	1
3/8	2-1/4	1-1/2	28-04	1
1/4	2-1/2	1-3/4	28-07	1

# LYNCH PINS

Zinc Dichromate Plated

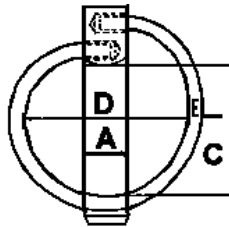
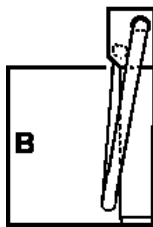

Product Size (A x B)	Description	C	D	E	Part #	Qty
3/16 x 1- 9/16	3/16 Standard Ring	1-1/4	1-13/32	9/64	63-01	1
1/4 x 1-9/16	1/4 Standard Ring	1-1/4	1-13/32	9/64	63-02	1
7/16 x 1-31/32	7/16 Long - HD Ring	1-1/2	1-43/64	3/16	63-07	1
7/16 x 1-31/32	7/16 Long - Chain & Cotter	1-11/32	1-17/32	9/64	63-12	1

# WOODRUFF KEYS

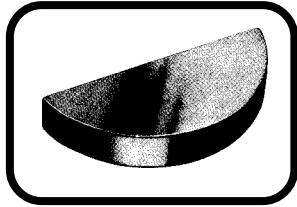

Diameter	Length	Trade Size	Part #	Qty
<b>3/32</b>	1/2	#2	05039	25
	5/8	#4	05041	25
<b>1/8</b>	1/2	#3	05040	25
	5/8	#5	05051	25
<b>5/32</b>	5/8	#6	05042	25
	3/4	#8	05043	25
	7/8	#10	05045	25
<b>3/16</b>	3/4	#9	05044	25
	7/8	#11	05052	25
	1	#13	05046	25
	1-1/8	#16	05060	25
<b>1/4</b>	3/4	#97	05055	25
	7/8	A	05053	25
	1	#15	05047	25
	1-1/8	#18	05048	25
	3/16	SPECIAL	05049	25
<b>5/16</b>	1-1/4	#21	05054	25
	1	B	05056	25
	1-1/8	C	05057	25
	1-1/4	D	05050	25
<b>3/8</b>	1	#152	05058	25
	1-1/4	E	05059	25

4

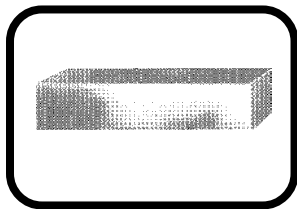

# SQUARE KEY STOCK

## 12" LENGTHS

Squared Dia	Length	Part #	Qty
1/8 x 1/8	12"	05069-A	1
3/16 x 3/16	12"	05069	1
1/4 x 1/4	12"	05070	1
5/16 x 5/16	12"	05071	1
3/8 x 3/8	12"	05075	1
7/16 x 7/16	12"	05076-A	1
1/2 x 1/2	12"	05076	1
9/16 x 9/16	12"	05072	1
5/8 x 5/8	12"	05073	1
3/4 x 3/4	12"	05074	1
7/8 x 7/8	12"	05068	1
1 x 1	12"	05068-A	1

## CUT LENGTHS

Squared Dia	Length	Part #	Qty
1/8 x 1/8	3/4"	050620	10
1/8 x 1/8	1"	050621	10
3/16 x 3/16	3/4"	050624	10
3/16 x 3/16	1"	050625	10
3/16 x 3/16	1-1/4"	050626	10
1/4 x 1/4	3/4"	050631	10
1/4 x 1/4	1-1/4"	050633	10
1/4 x 1/4	1-1/2"	050634	10
5/16 x 5/16	1-1/4"	050640	5
5/16 x 5/16	1-1/2"	050641	5
3/8 x 3/8	1-1/4"	050644	5
3/8 x 3/8	1-1/2"	050645	5
1/2 x 1/2	1-1/2"	050648	5

# SHAFT COLLARS

## ONE PIECE - SET SCREW STYLE

Zinc Plated Steel

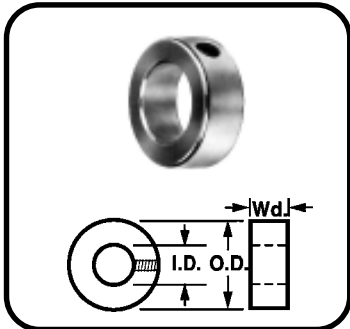

I.D.	O.D.	Width	Set Screw	Part #	Qty
1/4	1/2	5/16	10-32	05085	10
5/16	5/8	5/16	10-32	05086	10
3/8	3/4	3/8	1/4-20	05087	8
1/2	1"	7/16	1/4-20	05088	5
5/8	1-1/8	1/2	5/16-18	05089	3
3/4	1-1/4	9/16	5/16-18	05090	3
7/8	1-1/2	9/16	5/16-18	05091	2
1"	1-5/8	5/8	5/16-18	05092	2

- » Slide the collar on the shaft and tighten the hex head cup-point set screw to secure.
- » Set screws are manufactured from alloy steel.

# BRONZE BUSHINGS

SAE 841

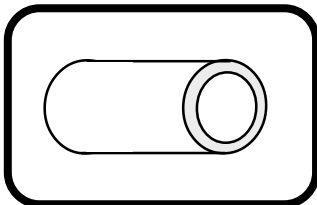

I.D.	O.D.	Length	Part #	Qty
1/4	5/16	3/4	04501	6
1/4	3/8	1/2	04502	6
1/4	3/8	1"	04503	6
5/16	7/16	3/4	04504	6
3/8	1/2	1/2	04505	5
3/8	1/2	1"	04506	5
7/16	9/16	1"	04507	4
1/2	5/8	5/8	04508	4
1/2	5/8	1-1/8	04509	4
1/2	11/16	1-1/8	04510	4
1/2	3/4	1-1/8	04511	4
5/8	3/4	1"	04512	3
5/8	3/4	1-1/8	04513	3
3/4	1"	1-7/8	04514	2
7/8	1-1/8	2"	04515	2
1"	1-1/4	2"	04516	2

- » Similar to Oilite-style bushings with an alloy of copper, tin, and carbon, these porous bronze bearings are vacuum-impregnated with 8-20% SAE-30 oil.
- » Heat created by shaft movement draws the oil to bearing surface.
- » The oil acts as a cushion between the shaft and bearing, reducing wear and increasing resistance to shock loads.



# MACHINERY BUSHINGS

Low-Carbon Mild Steel

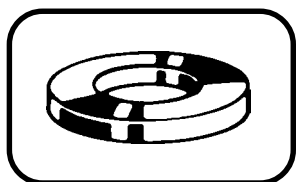

» Reduces friction and wear between moving parts.

I.D.	O.D.	Thickness	Part #	Qty
1/2	7/8	14 Gauge	50000	25
9/16	15/16	14 Gauge	50005	25
5/8	1"	14 Gauge	50010	25
3/4	1-1/4	14 Gauge	50015	25
7/8	1-3/8	14 Gauge	50020	20
1"	1-1/2	14 Gauge	50025	20
1-1/8	1-3/4	14 Gauge	50030	10
1-1/4	1-7/8	14 Gauge	50035	10
1-3/8	2-1/8	14 Gauge	50040	10
1-1/2	2-1/4	14 Gauge	50045	5
1-5/8	2-3/8	14 Gauge	50050	5
1-3/4	2-1/2	14 Gauge	50055	5
1-7/8	2-7/8	14 Gauge	50060	5
2	3	14 Gauge	50065	5
2-1/8	3-1/8	14 Gauge	50070	5
2-1/4	3-1/4	14 Gauge	50075	5
2-3/8	3-3/8	14 Gauge	50080	5
2-1/2	3-1/2	14 Gauge	50085	5

4

# ROLLER CHAIN LINKS

ANSI Standard Sizes

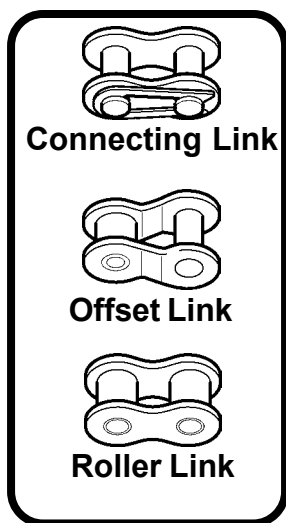

ANSI Number	Type	Part #	Qty
35	Connecting Link	14000	6
40	Connecting Link	14001	6
41	Connecting Link	14002	4
50	Connecting Link	14003	4
60	Connecting Link	14004	2
35	Offset Link	14010	6
40	Offset Link	14011	6
41	Offset Link	14012	4
50	Offset Link	14013	4
60	Offset Link	14014	2
35	Roller Link	14020	6
40	Roller Link	14021	6
41	Roller Link	14022	4
50	Roller Link	14023	4
60	Roller Link	14024	2

» **Connecting Link**—A special pin link that's easily disassembled; use to join the ends of a length of chain to make a continuous strand and to splice lengths together.

» **Roller Link**—Add to chain to lengthen it.

» **Offset Link**—A combination of a pin link and roller link. Standard chain has an even number of pitches; use an offset link to make a strand with an odd number of pitches.

# PRECISION STEEL BALLS

ASTM A295 Chrome Steel

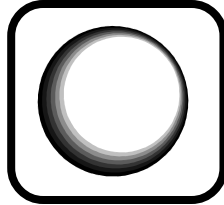

- » Conform to ASTM A295. Made from AISI Type 52100 steel. Widely used in precision ball bearings as well as other applications, these balls are through hardened for maximum strength.
- » Balls have a diameter tolerance of  $\pm .0001$ " and a sphericity of  $.000025$ ".

Size	Part #	Qty
3/32	10101	25
1/8	10102	25
5/32	10103	25
3/16	10104	25
7/32	10105	25
1/4	10106	25
9/32	10107	25
5/16	10108	25
11/32	10109	20
3/8	10110	20
7/16	10112	15
1/2	10114	15
9/16	10115	10
5/8	10118	10
11/16	10120	6
3/4	10122	6
7/8	10125	6
1"	10127	6

# INTERNAL RETAINING RINGS

Size	Part #	Qty
1/4	09850	100
5/16	09851	100
3/8	09852	100
7/16	09853	50
1/2	09854	50
9/16	09855	50
5/8	09856	50
11/16	09857	50
3/4	09858	50
13/16	09859	25
7/8	09860	25
15/16	09861	25

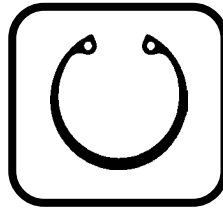

Size	Part #	Qty
1	09862	25
1-1/8	09864	25
1-3/16	09865	25
1-1/4	09866	25
1-5/16	09867	25
1-3/8	09868	25
1-1/2	09870	25
1-5/8	09872	25
1-3/4	09874	25
1-7/8	09876	25
2	09878	25

4

# EXTERNAL RETAINING RINGS

Size	Part #	Qty
1/8	09900	100
3/16	09901	100
1/4	09902	100
5/16	09903	100
3/8	09904	100
7/16	09905	50
1/2	09906	50
9/16	09907	50
5/8	09908	50
11/16	09909	50
3/4	09910	50
13/16	09911	25
7/8	09912	25

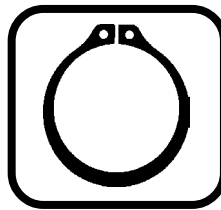

Size	Part #	Qty
15/16	09913	25
1	09914	25
1-1/8	09915	25
1-3/16	09916	25
1-1/4	09917	25
1-5/16	09918	25
1-3/8	09919	25
1-1/2	09921	25
1-5/8	09923	25
1-3/4	09925	25
1-7/8	09927	25
2	09929	25

# “E” TYPE RETAINING RINGS

Size	Part #	Qty
1/16	09950	100
3/32	09951	100
1/8	09952	100
5/32	09953	100
3/16	09954	100
7/32	09955	100
1/4	09956	100
5/16	09957	100



Size	Part #	Qty
3/8	09958	100
7/16	09959	50
1/2	09960	50
5/8	09961	50
3/4	09962	50
7/8	09963	25
1	09964	25

# BLIND RIVETS

## DOMEHEAD

Aluminum, Steel and Stainless Steel

4

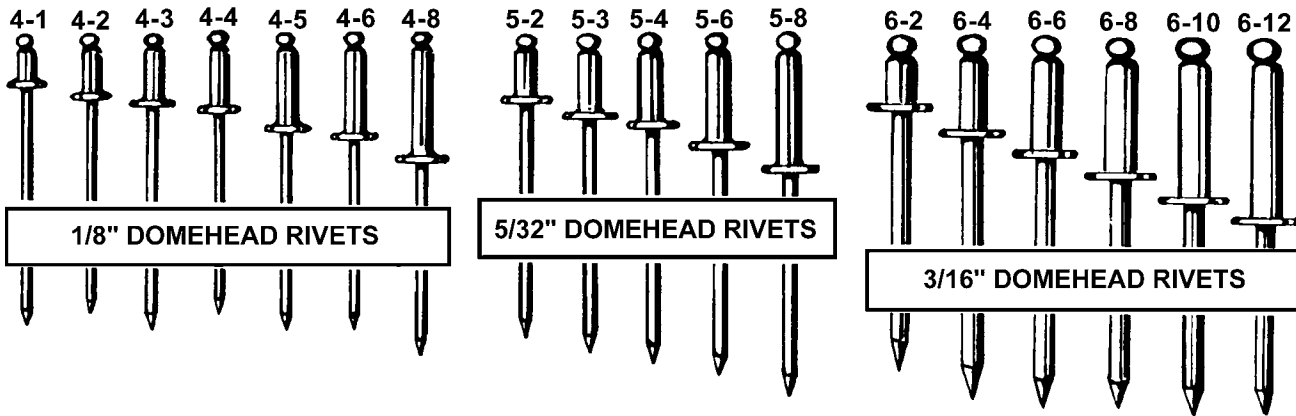

Dia	Rivet Code	Thickness of Material to Fasten	All Aluminum Part #	All Steel Part #	Stainless Steel Part #	Qty
<b>1/8</b>	4-1	up to 1/16	14397	14422	—	100
	4-2	up to 1/8	14398	14423	14351	100
	4-3	1/8 to 3/16	14399	14424	14352	100
	4-4	3/16 to 1/4	14400	14425	14353	100
	4-5	1/4 to 5/16	14401	14426	14354	100
	4-6	1/4 to 3/8	14402	14427	14355	100
	4-8	3/8 to 1/2	14403	14428	14356	100
<b>5/32</b>	5-2	up to 1/8	14404	14429	14357	100
	5-3	1/8 to 3/16	14405	14430	14358	100
	5-4	1/8 to 1/4	14406	14431	14359	100
	5-6	1/4 to 3/8	14407	14432	14360	100
	5-8	3/8 to 1/2	14408	14433	14361	100
<b>3/16</b>	6-2	up to 1/8	14409	14434	14362	50
	6-4	1/8 to 1/4	14410	14435	14363	50
	6-6	1/4 to 3/8	14411	14436	14364	50
	6-8	3/8 to 1/2	14412	14437	14365	50
	6-10	1/2 to 5/8	14413	14438	14366	50
	6-12	5/8 to 3/4	35466	14439	14367	50

» To fasten together two elements when only one side is accessible.

# BLIND RIVETS

## COUNTERSUNK & LARGE FLANGE

Aluminum, Steel and Stainless Steel

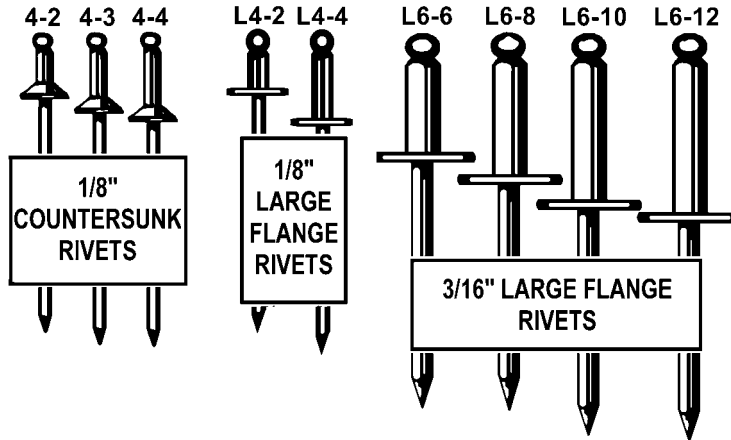

4



### COUNTERSUNK

Dia	Rivet Code	Thickness of Material to Fasten	All Aluminum Part #	All Steel Part #	Stainless Steel Part #	Qty
1/8	C4-2	up to 1/8	14414	14440	14368	100
	C4-4	1/8 to 1/4	14415	14442	14370	100

### LARGE FLANGE

Dia	Rivet Code	Thickness of Material to Fasten	All Aluminum Part #	All Steel Part #	Stainless Steel Part #	Qty
1/8	L4-2	up to 1/8	14416	14443	14371	100
	L4-4	3/16 to 1/4	14417	14444	14372	100
3/16	L6-6	1/4 to 3/8	14418	14445	14373	50
	L6-8	3/8 to 1/2	14419	14446	14374	50
	L6-10	1/2 to 5/8	14420	14447	14375	50
	L6-12	5/8 to 3/4	14421	14448	14376	50

# PAINTED BLIND RIVETS

WHITE, BROWN & BLACK  
Aluminum and Steel

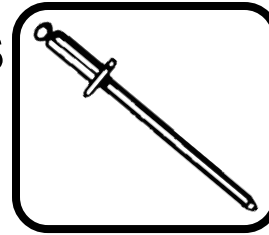

## ALUMINUM

Dia	Rivet Code	Thickness of Material to Fasten	White Part #	Brown Part #	Black Part #	Qty
<b>1/8</b>	4-2	up to 1/8	14300	14305	14310	100
	4-3	1/8 to 3/16	14301	14306	14311	100
	4-4	3/16 to 1/4	14302	14307	14312	100

## STEEL

Dia	Rivet Code	Thickness of Material to Fasten	White Part #	Brown Part #	Black Part #	Qty
<b>1/8</b>	4-2	up to 1/8	14315	14320	14325	100
	4-3	1/8 to 3/16	14316	14321	—	100
	4-4	3/16 to 1/4	14317	14322	14327	100

# COPPER BLIND RIVETS

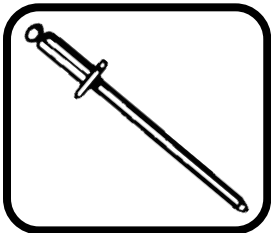

Dia	Rivet Code	Thickness of Material to Fasten	Part #	Qty
<b>1/8</b>	4-2	up to 1/8	14330	100
	4-4	3/16 to 1/4	14332	100

# BACK-UP PLATES

## ROUND

Aluminum and Steel

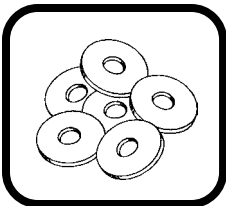

» For holes too large to support rivets alone, and in materials which are too soft to hold rivets.

Hole Size	O.D.	Aluminum Part #	Steel Part #	Qty
1/8	3/8	04476	04471	100
5/32	7/16	04477	04472	100
3/16	1/2	04478	04473	100

# “PEEL-TYPE” SPECIALTY RIVETS

Aluminum Rivet / Steel Mandrel



## A11620

Peel-Type Rivet  
1/4" Diameter  
Grip: 1/32" - 9/64"  
Flange Diameter: 1/2"  
Window Regulators  
GM, Ford & Chrysler  
1971 - On

### OEM #'s:

GM - 9436175  
Ford - 385189-S100  
Chrys - 6031115

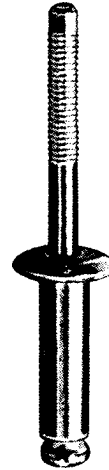

## A11621

Peel-Type Rivet  
1/4" Diameter  
Grip: 33/64" - 19/32"  
Flange Diameter: 1/2"  
Window Regulators  
GM, Ford & Chrysler  
1976 - On

### OEM #'s:

GM - 9437938  
Ford - 385323-S100  
Chrys - 6031091

4

## MARSON HAND RIVET TOOL KIT

Part # FK91040



The deluxe hand riveter kit includes the MAR-39000 tool and 200 assorted Klik-Fast rivets in popular sizes. The molded plastic case houses and protects the tool, rivets and mandrel key.



## MARSON THREAD-SETTER™ TOOL

Part # MAR-39000



The 39000 is the largest selling hand rivet tool in the industry. Known and trusted for durability, quality and performance. Quality features include: precision die-cast, high-strength aluminum alloy body; drop-forged carbon steel upper handle; and thick, cushion-molded vinyl grips for comfort. The 39000 sets up to 3/16" steel rivets and comes with four mounted nosepieces (3/32", 1/8", 5/32" and 3/16") and a service wrench.

## 1/4" HEAVY DUTY RIVET GUN

Part # AST-1426



Extra long handles provide excellent leverage. Includes 5 nosepieces: 1/8", 5/32", 3/16", 7/32", 1/4". Tool length 20-3/4".



# FAS-KIT<sup>®</sup> PIN, RING & RIVET ASSORTMENTS



4

Plastic Box Assortments		
Part Number	Description	Number of Pieces
FK02500	Cotter Pins - Extended Prong, Zinc Plated	170
FK02600	Spring Pins (Roll Pins) - Zinc Plated	327
FK02700	Retaining Rings - Internal & External	360
FK02800	Retaining Ring - "E"-Type	403
FK02900	Woodruff Keys (Half Moon)	109
FK03000	Hitch Pins - Zinc Plated	91
FK03050	External Hair Pin Cotters - Zinc Plated	300

Metal Tray Assortments			
Small Drawer	Large Drawer	Description	Number of Pieces
FK14100	FK54100	Cotter Pins - Extended Prong, Zinc Plated	920
—	FK54110	Cotter Pins - Extended Prong, Zinc Plated	940
FK14120	FK54120	Dowel Pins, Alloy Steel	675
FK14150	FK54150	Spring Pins (Roll Pins)	775
FK14200	FK54200	Spring Pins (Roll Pins)	710
FK14220	FK54220	Roller Chain Links	66
FK14250	FK54250	Internal Retaining Rings	410
FK14300	FK54300	External Retaining Rings	425
FK14350	FK54350	Internal & External Retaining Rings	630
FK14400	FK54400	"E"-Type Retaining Rings	950
FK14450	FK54450	Clevis Pins, Universal Type	60
FK14500	FK54500	Clevis Pins, Standard Type	124
FK14550	FK54550	Woodruff Keys (Half Moon)	270
FK14600	FK54600	Hitch Pins, Zinc Plated	295
FK14650	FK54650	Shaft Collars, Zinc Plated	43
FK14670	FK54670	Machinery Bushings, Plain Steel	185
FK14700	FK54700	Bronze Bushings	66
FK14720	FK54720	Precision Steel Balls	314
—	FK54800	Square Key Stock, Zinc Plated Steel (3/16 - 1/2)	30
—	FK54820	Square Key Stock, Zinc Plated Steel (9/16 - 1")	8
FK14860	FK54860	Blind Rivets, Zinc Plated Steel	700
FK14910	FK54910	Blind Rivets, Aluminum	700
FK14930	FK54930	Blind Rivets, Stainless Steel	700

Miscellaneous Assortments		
Part Number	Description	Number of Pieces
FK90175	Square Key Stock Assortment in Wall Mount Bin	38



# Section 5: Construction Fasteners

## Table of Contents

### Nails

Common, <i>Bright</i> .....	3
Common, <i>Galvanized</i> .....	3
Finishing, <i>Bright</i> .....	3
Roofing, <i>Galvanized</i> .....	3
Spikes, <i>Galvanized</i> .....	3

### Mechanical Anchors

Wedge Type, <i>Zinc Plated Steel</i> .....	4
Wedge Type, <i>Stainless Steel</i> .....	4
Sleeve Type, <i>Zinc Plated Steel</i> .....	5
Titan HD™ Threaded Anchor .....	5
Tapcon™ Screws, <i>Hex Washer Head</i> .....	6
Tapcon™ Screws, <i>Phillips Flat Head</i> .....	6
Tapcon™ Installations Tool Kit .....	6
Tapcon™ Masonry Bits .....	7
Drop-In Anchors .....	7
Double Expansion Shields .....	8
Machine Screw Anchors .....	8
Lag Screw Shields .....	9
Lead Wood Screw Anchors .....	9
E-Z Anchors, <i>Nylon &amp; Zinc</i> .....	10
Conical Plastic Anchors .....	11
Plastic Anchor Kits .....	11
Vinyl Sleeve Screw Anchors .....	11
Toggle Bolts, <i>Round Head &amp; Flat Head</i> .....	12
Kaptoggle™ Anchors .....	12
Versatoggle™ Drywall Anchors .....	13
Hollow Wall Anchors, <i>Standard &amp; Drive Point</i> .....	13
Hollow Wall Anchor Tool .....	13
Hammer Drive Anchors, <i>Nylon &amp; Zinc</i> .....	14

### Chemical Anchors

Acrylic Tie Adhesive .....	15
Epoxy Tie Adhesive .....	16
Glass Capsule Adhesive .....	17
Crack Repair Epoxy .....	17

### Powder Actuated Fasteners

Powder Actuated Tool Kit .....	18
Loads, <i>.22 Caliber Single Shot</i> .....	19
Loads, <i>.25 Caliber Disc &amp; Strip</i> .....	19
Loads, <i>.27 Caliber Single &amp; Strip</i> .....	19
Pins, <i>Standard</i> .....	20
Pins, <i>with Washer</i> .....	20
Pins, <i>with Ceiling Clips</i> .....	20
Pins, <i>with Threaded Studs</i> .....	20

### Strut & Accessories

Strut, <i>Galvanized &amp; Green</i> .....	21
Strut Nuts, <i>with Spring</i> .....	21
Strut Nuts, <i>without Spring</i> .....	21
Twirl Nuts .....	21
Strut Connection Fittings .....	22
Strut Mounting Fittings .....	23
End Caps .....	23
Beam Clamps, <i>for Threaded Rod</i> .....	24
Beam Clamps, <i>Strut to Beam</i> .....	24
Pipe Clamps, <i>for Conduit</i> .....	25
Pipe Clamps, <i>for Steel &amp; Copper Tubing</i> .....	26

### Sammy™ Super Screws

Drivers .....	27
Wood Mounting, <i>Vertical</i> .....	27
Wood Mounting, <i>Horizontal</i> .....	27
Steel Mounting, <i>Vertical</i> .....	28
Steel Mounting, <i>Horizontal</i> .....	28
Steel Mounting, <i>Drop Ceilings</i> .....	28
Concrete Mounting, <i>Vertical</i> .....	29
Concrete Mounting, <i>Horizontal</i> .....	29
Concrete Mounting, <i>Eyelet &amp; S-Hook</i> .....	29

Faskit Assortments .....	30
--------------------------	----

**FAS-KIT**®

**TAPCON™**

**B-Line** 

**SIMPSON**  
**Strong-Tie**  
ANCHOR SYSTEMS

  
**ITW Buildex**  
Building Ideas That Work®

**5**





# NAILS

Bright Finish and Galvanized



## Bright Common Nails

Penny Size	Length	Part #		Qty / Lb.
		1 lb. Box	5 lb. Box	
4d	1-1/2	NAIL-4C1	NAIL-4C5	294
6d	2	NAIL-6C1	NAIL-6C5	167
8d	2-1/2	NAIL-8C1	NAIL-8C1	101
10d	3	NAIL-10C1	NAIL-10C5	66
12d	3-1/4	NAIL-12C1	NAIL-12C5	61
16d	3-1/2	NAIL-16C1	NAIL-16C5	47

## Bright Finishing Nails

Penny Size	Length	Part #		Qty / Lb.
		1 lb. Box		
3d	1-1/4	NAIL-3F1		880
4d	1-1/2	NAIL-4F1		630
6d	2	NAIL-6F1		288
8d	2-1/2	NAIL-8F1		193

5

## Galvanized Common Nails

Penny Size	Length	Part #		Qty / Lb.
		1 lb. Box		
6d	2	NAIL-6HGC1		167
8d	2-1/2	NAIL-8HGC1		101
10d	3	NAIL-10HGC1		66
16d	3-1/2	NAIL-16HGC1		47

## Galvanized Roofing Nails

Size	Gauge	Part #		Qty / Lb.
		5 lb. Box		
1-1/4	11	NAIL-114HGRFG5		210
1-1/2	11	NAIL-112HGRFG5		180
2	11	NAIL-2HGRFG5		138
3-1/2	11	NAIL-312HGRFG5		87

## Galvanized 12" Spikes

Size	Diam.	Part #		Qty / Lb.
		5 lb. Box		
12"	3/8"	NAIL-12HGSPK5		3

# WEDGE TYPE CONCRETE ANCHORS

Zinc Plated Steel and Stainless Steel

5

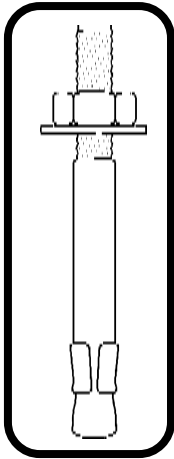

- » Anchor diameter equals hole diameter.
- » One piece stainless steel expander clip resists corrosion.
- » 360° contact with concrete assures full expansion for reliable working loads.
- » Non bottom-bearing, may be used in hole depth exceeding anchor length.
- » Supplied complete with nut and washer.
- » Can be installed through the work fixture, eliminating hole spotting.
- » Heavy duty pull-out and shear capacities.

## INSTALLATION STEPS

1. Using a bit whose diameter equals the anchor diameter, drill hole to any depth exceeding minimum embedment. Clean hole.
2. Assemble anchor with nut and washer so that the top of the nut is flush with the top of the anchor. Drive anchor through material to be fastened so that nut and washer is flush with surface of material.
3. Expand anchor by tightening nut 3 to 5 turns, or to the specified torque requirements.

Dia	Overall Length	Thread Length	Hole Size	Minimum Depth in Concrete	Part #	Qty
<b>1/4</b> -20	1-3/4	3/4	1/4	1-1/8	<b>14462</b>	100
	2-1/4	3/4	1/4	1-1/8	<b>14463</b>	100
	3-1/4	3/4	1/4	1-1/8	<b>14464</b>	100
<b>3/8</b> -16	2-1/4	7/8	3/8	1-3/4	<b>14464-1</b>	50
	2-3/4	1-1/8	3/8	1-3/4	<b>14465</b>	50
	3	1-1/8	3/8	1-3/4	<b>14466</b>	50
	5	1-1/8	3/8	1-3/4	<b>14467</b>	50
<b>1/2</b> -13	2-3/4	1-1/8	1/2	2-1/4	<b>14468</b>	50
	3-3/4	1-1/4	1/2	2-1/4	<b>14469</b>	50
	4-1/4	1-1/4	1/2	2-1/4	<b>14469-1</b>	25
	5-1/2	1-1/4	1/2	2-1/4	<b>14470</b>	25
<b>5/8</b> -11	3-1/2	1-1/2	5/8	2-3/4	<b>14471</b>	25
	4-1/2	1-1/2	5/8	2-3/4	<b>14472</b>	20
	5	1-1/8	5/8	2-3/4	<b>14472-1</b>	25
	6	1-1/2	5/8	2-3/4	<b>14473</b>	20
	7	1-1/4	5/8	2-3/4	<b>14473-1</b>	25
<b>3/4</b> -10	8-1/2	1-1/2	5/8	2-3/4	<b>14473-2</b>	25
	4-1/4	1-1/2	3/4	3-3/8	<b>14474</b>	20
	4-3/4	1-1/2	3/4	3-3/8	<b>14474-1</b>	20
	5-1/2	1-1/2	3/4	3-3/8	<b>14474-2</b>	20
	7	1-1/2	3/4	3-3/8	<b>14475</b>	20
	8-1/2	1-1/2	3/4	3-3/8	<b>14476</b>	10
<b>7/8</b> -9	10	1-1/2	3/4	3-3/8	<b>14476-1</b>	10
	6	2-1/4	7/8	3-7/8	<b>14476-2</b>	10
	8	2-1/4	7/8	3-7/8	<b>14476-3</b>	5
	10	2-1/4	7/8	3-7/8	<b>14476-4</b>	5
<b>1</b> -8	6	2-1/4	1	4-1/2	<b>14477</b>	5
	9	2-1/4	1	4-1/2	<b>14478</b>	5
	12	2-1/4	1	4-1/2	<b>14478-1</b>	5
<b>1-1/4</b> -7	9	3-1/4	1-1/4	5-5/8	<b>14479</b>	5
	12	3-1/4	1-1/4	5-5/8	<b>14480</b>	5

## STAINLESS STEEL SIZES

<b>1/4 -20</b>	2-1/4	3/4	1/4	1-1/8	<b>14481</b>	100
<b>3/8 - 16</b>	3	1-1/8	3/8	1-1/2	<b>14482</b>	50
<b>1/2 - 13</b>	4-1/4	1-1/4	1/2	2-1/4	<b>14483</b>	50
<b>5/8 - 11</b>	5	1-1/2	5/8	2-3/4	<b>14484</b>	20
<b>3/4 - 10</b>	5-1/2	1-1/2	3/4	3-1/4	<b>14485</b>	10

# SLEEVE TYPE CONCRETE ANCHORS

## ACORN, HEX & FLAT HEADS

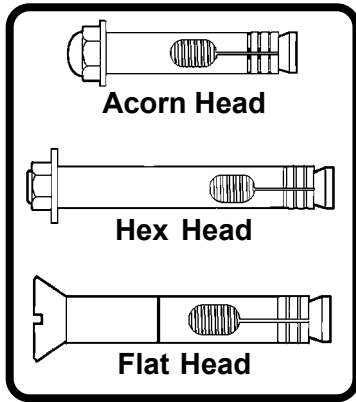

Sleeve anchors are pre-assembled expanding anchors for use in all types of hollow and solid base materials.

### Sleeve Anchor Installation Sequence

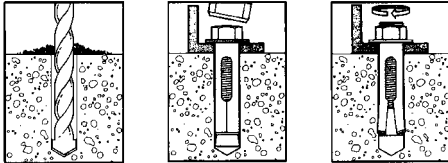

Dia	Overall Length	Thread Size	Hole Size	Maximum Fixture Thickness	Part #	Qty
<b>Acorn Head</b>						
<b>1/4</b>	1-3/8	3/16-24	1/4	1/4	<b>14501</b>	100
	2-1/4	3/16-24	1/4	1-1/8	<b>14502</b>	100
<b>Hex Head</b>						
<b>3/8</b>	1-7/8	1/4-20	3/8	3/8	<b>14507</b>	50
	3	1/4-20	3/8	1-1/2	<b>14509</b>	50
	4	1/4-20	3/8	2-1/4	<b>14510</b>	50
<b>1/2</b>	3	3/8-16	1/2	3/4	<b>14513</b>	25
	4	3/8-16	1/2	1-3/4	<b>14514</b>	25
	6	3/8-16	1/2	3-3/8	<b>14515</b>	25
<b>Flat Head</b>						
<b>1/4</b>	3	3/16-24	1/4	1-7/8	<b>14522</b>	50
<b>3/8</b>	4	1/4-20	3/8	2-1/2	<b>14526</b>	50
	5	1/4-20	3/8	3-1/2	<b>14527</b>	50
	6	1/4-20	3/8	4-1/2	<b>14528</b>	50

**5**

**SIMPSON**

**Strong-Tie**  
ANCHOR SYSTEMS

## TITEN HD™ CONCRETE ANCHOR

### HIGH STRENGTH THREADED MASONRY ANCHOR

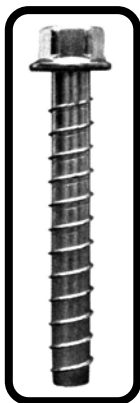

Dia	Length	Hole Size	Part #	Qty
<b>3/8</b>	3	3/8	<b>14555</b>	50
	4	3/8	<b>14556</b>	50
	5	3/8	<b>14557</b>	50
	6	3/8	<b>14558</b>	50
<b>1/2</b>	3	1/2	<b>14562</b>	25
	4	1/2	<b>14563</b>	20
	5	1/2	<b>14564</b>	20
	6	1/2	<b>14565</b>	20

Dia	Length	Hole Size	Part #	Qty
<b>5/8</b>	4	5/8	<b>14570</b>	10
	5	5/8	<b>14571</b>	10
	6	5/8	<b>14572</b>	10
	4	3/4	<b>14577</b>	10
<b>3/4</b>	5	3/4	<b>14578</b>	5
	6	3/4	<b>14579</b>	5

The Titen is a high-strength threaded anchor for concrete and masonry. It is the ideal anchor for structural applications, even under reduced spacing conditions. The proprietary cutting teeth enable the Titen to be installed in 1/4 of the time when compared to traditional expansion anchors.

\*\* Recommended for use in dry interior applications. Temporary exterior applications may be acceptable in some cases.

### Titen HD™ Installation

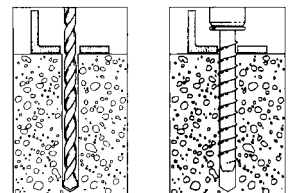

# TAPCON™ MASONRY SCREW ANCHORS

## HEX WASHER HEAD & PHILLIPS FLAT HEAD

Fluorocarbon Coated

» Packed 100 screw anchors and 1 carbide tipped drill bit per box.

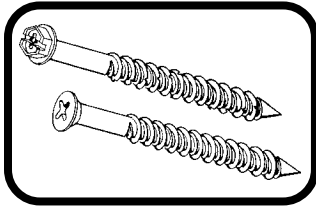

5

Dia	Length	Drill Bit Size	Fastens Material up to:	Part #	
				Hex Washer	Phillips Flat
<b>3/16</b>	1-1/4	5/32 x 3.5	1/4	<b>03350</b>	<b>03365</b>
	1-3/4	5/32 x 3.5	3/4	<b>03351</b>	<b>03366</b>
	2-1/4	5/32 x 4.5	1-1/4	<b>03352</b>	<b>03367</b>
	2-3/4	5/32 x 4.5	1-3/4	<b>03353</b>	<b>03368</b>
	3-1/4	5/32 x 5.5	2-1/4	<b>03354</b>	<b>03369</b>
	3-3/4	5/32 x 5.5	2-3/4	<b>03355</b>	<b>03370</b>
<b>1/4</b>	1-1/4	3/16 x 3.5	1/4	<b>03356</b>	<b>03371</b>
	1-3/4	3/16 x 3.5	3/4	<b>03357</b>	<b>03372</b>
	2-1/4	3/16 x 4.5	1-1/4	<b>03358</b>	<b>03373</b>
	2-3/4	3/16 x 4.5	1-1/2	<b>03359</b>	<b>03374</b>
	3-1/4	3/16 x 5.5	2-1/4	<b>03360</b>	<b>03375</b>
	3-3/4	3/16 x 5.5	2-3/4	<b>03361</b>	<b>03376</b>
	4	3/16 x 5.5	3	<b>03362</b>	<b>03377</b>

### CARBIDE TIPPED MASONRY BITS

For Tapcon™ Masonry Screw Anchors

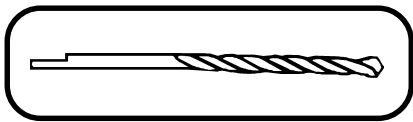

Dia	Length	Part #	Qty
<b>5/32</b>	3-1/2	<b>03380</b>	1
	4-1/2	<b>03381</b>	1
	5-1/2	<b>03382</b>	1
<b>3/16</b>	3-1/2	<b>03383</b>	1
	4-1/2	<b>03384</b>	1
	5-1/2	<b>03385</b>	1

### TAPCON™ CONDRIVE 1000 INSTALLATION TOOL KIT

Part # 03390

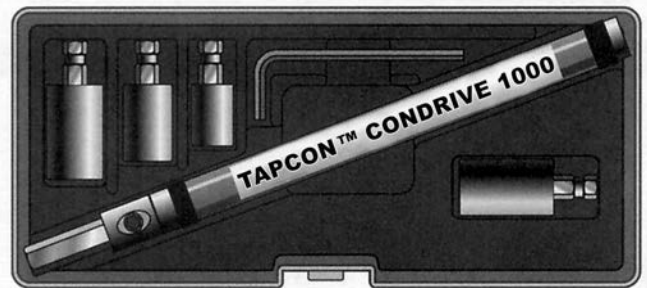

Kit consists of:

- Drill adapter
- Drill adapter sleeve
- #2 Phillips bit
- #3 Phillips bit
- Phillips socket
- 1/4" socket
- 5/16" socket
- 1/8" hex key
- Handy storage box

# DROP-IN ANCHORS

## STANDARD, SHORT & STAINLESS STEEL

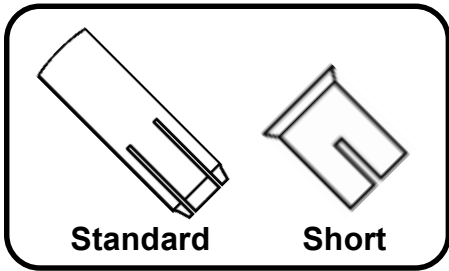

## 3 Quick & Easy Steps

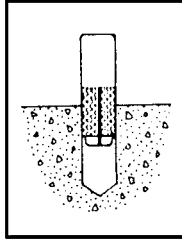

1. Drill hole to a depth equal to anchor length. Insert anchor & tap flush with surface.

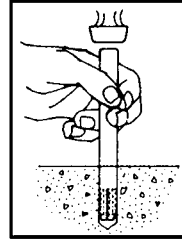

2. Using setting tool, set the anchor with several hammer blows.

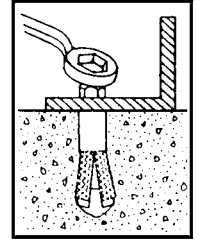

3. Position fixture. Insert screw or bolt through fixture and tighten.

- » Pre Assembled, one-piece design eliminates lost plugs and wasted anchors.
- » Expansion end is tapered to match the taper of the plug assuring uniform expansion and 360° holding power along the walls of the concrete holes.
- » Lip designed to allow for maximum expansion and hold.
- » Smooth, flawless top allows wither flush or countersunk installation for deeper embedment in concrete and greater holding power.
- » Extruded body - body is formed and compressed in high impact molds for superior holding power and longer installation life.

Bolt Size	Anchor Length	Drill O.D. Required	Average Max* Load 4000 psi	Anchor Part #	Qty	Setting Tool Part #
<b>Standard</b>						
1/4	1	3/8	1840	3315-03	100	3315-007
3/8	1-9/16	1/2	3960	3325-03	50	3325-007
1/2	2	5/8	6100	3335-03	50	3335-007
5/8	2-1/2	7/8	8680	3345-03	25	3345-007
3/4	3-3/16	1	10760	3355-03	25	3355-007
<b>Short</b>						
3/8	3/4	1/2	2781	3325-03S	50	n/a
<b>Stainless Steel</b>						
1/4	1	3/8	1840	3315-03SS	100	3315-007
3/8	1-9/16	1/2	3960	3325-03SS	50	3325-007
1/2	2	5/8	6100	3335-03SS	50	3335-007

Sarjo Drop-In Setting Tools are available free with quantity purchases. Additional tools are available individually.

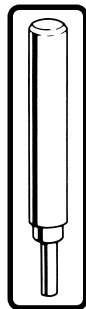

- » \* Average Maximum Proof Test Loads: An anchor properly installed in good grade concrete of 4000 psi compressive strength and subjected to a specified tension test load in an axial direction.
- » Safe Working Loads: Most Standards recommend one-fourth (1/4) of the average maximum proof test loads as safe working loads.

# DOUBLE EXPANSION SHIELDS

## FOR SOLID LOADS OR EXTREME VIBRATION

Die Cast Zinc Alloy

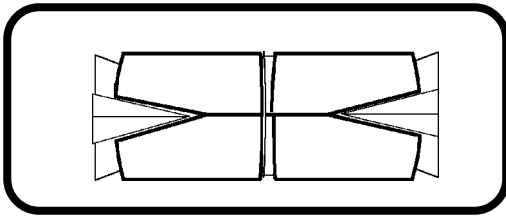

- » Die cast zinc alloy shields for heavy loads.
- » Expand entire length of shield.
- » For solid masonry.

Bolt Diameter	Drill Size	Part #	Qty
1/4-20	1/2	<b>09784</b>	100
5/16-18	5/8	<b>35315</b>	100
3/8-16	3/4	<b>09785</b>	50
1/2-13	7/8	<b>09786</b>	50
5/8-11	1	<b>09787</b>	25
3/4-10	1-1/4	<b>09788</b>	25

5

Drill hole of recommended diameter (same as length of shield.) Insert shield into hole (threaded end first.)

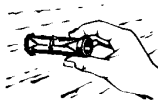

Shield should be flush or slightly below surface of masonry. Place fixture. Insert machine bolt and tighten.

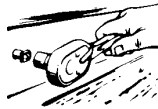

Load distributed full length of shield - increasing holding power of wall materials.

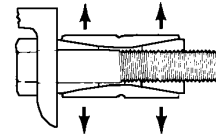

# MACHINE SCREW ANCHORS

## FOR ALL MASONRY, GLASS, MARBLE AND TILE MATERIALS

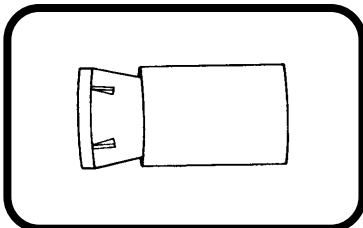

- » Incorporate zinc cones and antimonial lead sleeves.
- » Ideal for applications requiring shallow hole installations.

Screw Size	Anchor Length	Drill Size	Part #	Qty
8-32	1/2	5/16	<b>09789</b>	100
10-24	5/8	3/8	<b>09790</b>	100
1/4-20	7/8	1/2	<b>09791</b>	100
5/16-18	1	5/8	<b>35314</b>	50
3/8-16	1-1/4	3/4	<b>09792</b>	50
1/2-13	1-1/2	7/8	<b>09793</b>	50

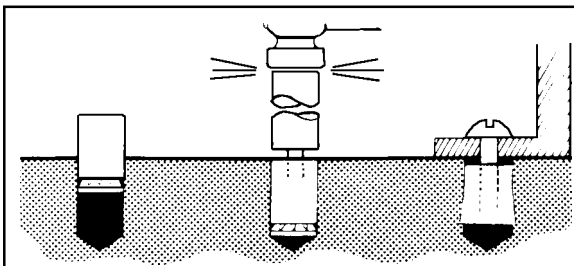

Anchors are expanded by a few hammer blows on the setting tool. The lead sleeve is driven back and packed firmly around the tapered expander nut, producing a quick and secure anchorage. The anchor installs easily yet develops maximum holding power.



# LAG SCREW EXPANSION SHIELDS

## FOR EXTRA HOLDING POWER AND EASIER INSTALLATION

Zinc Alloy

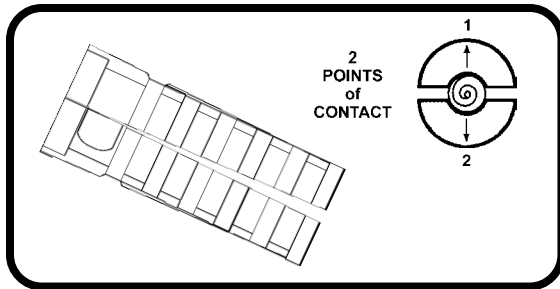

Fits Lag Screw Dia	Shield Length	Drill Size	Part #	Qty
1/4	short	1/2	9813-S	100
1/4	long	1/2	9813-L	100
5/16	short	1/2	9814-S	100
5/16	long	1/2	9814-L	100
3/8	short	5/8	9815-S	50
3/8	long	5/8	9815-L	50
1/2	short	3/4	9816-S	50
1/2	long	3/4	9816-L	50

- » Improved design permits use of smaller shield to achieve greater holding power.
- » Non-skid rings prevent creeping.
- » Screw size and drill size shown on every shield.
- » Special construction provides positive grip even if hole is drilled over-size.

5

# LEAD SCREW ANCHORS

## USE WITH WOOD OR SHEET METAL SCREWS IN CONCRETE, PLASTER, TILE & MASONRY

Lead Alloy

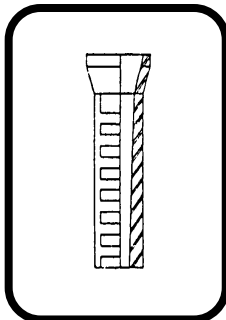

Screw Size	Anchor Length	Drill Size*	Safe Work Load lbs.**	Part #	Qty
6 - 8	1	1/4	20 - 22	09765	100
6 - 8	1-1/2	1/4	25 - 48	09766	100
10 - 14	1	5/16	40 - 49	09767	100
10 - 14	1-1/2	5/16	135 - 136	09768	100

- » \* For hard material: concrete, concrete block, tile & similar material, use 1/16" larger size than shown.
- » \*\* Tested holding power is 10 times safe working load.
- » Lead alloy contains antimony for extra strength.

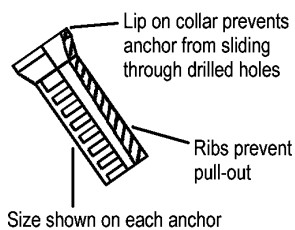

**Compare The Difference**

This	Not This
<p>Expand 2 ways</p> <p>4 POINTS of CONTACT</p>	<p>Expand only 1 way</p> <p>ONLY 2 POINTS of CONTACT</p>

# E-Z ANCHORS

## SELF-DRILLING GYPSUM WALLBOARD ANCHORS

Zinc or White Nylon

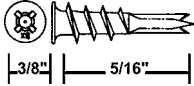
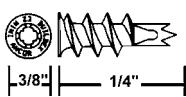
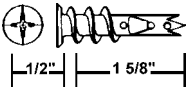
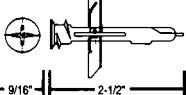

5

			Anchor Material	Maximum Fixture Thickness	Screw Size	Part #	Quantity
Light Duty	E-Z Anchor Life™		White Nylon	3/4"	# 6	09742	100
	E-Z Mini Anchor™		Zinc	3/4"	# 6, # 7, or # 8	09743	100
Medium Duty	E-Z Anchor®		White Nylon	3/4"	# 6, # 7, or # 8	09740	100
			Zinc	3/4"	# 6, # 7, or # 8	09741	100
Heavy Duty	E-Z Toggle™		Zinc	3/4"	# 8	09744	50 Toggles 50 #8x2-1/8" Pan SMS
					# 8	09745	50 Toggles 50 #8x2-1/8" Lge. Washer Face SMS

- » No hole preparation necessary; pre-drills own small precise hole in gypsum wallboard.
- » Replaces plastic plugs and toggles.
- » Deep thread provides strong engagement in 3/8", 1/2" and 5/8" gypsum wallboard.

- » Installs Quickly and easily with a #2 phillips screwdriver or power-driver.
- » Available in corrosion resistant nonconductive white nylon.
- » Can be easily backed-out.
- » Low profile head.

### Light Duty E-Z Ancor Lite, E-Z Mini Ancor & Medium Duty E-Z Ancor

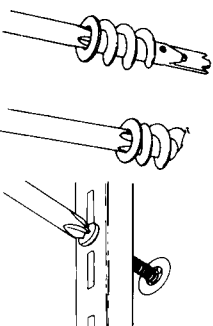

1. Place #2 Phillips screwdriver into recess of E-Z Ancor Lite, E-Z Mini Ancor or E-Z Ancor.
2. Press into drywall while turning the anchor clockwise until it is seated flush with wall.
3. Place fixture in position over installed E-Z Ancor Lite, E-Z Mini Ancor or E-Z Ancor. Insert screw with screw driver. Tighten fixture in place.

### Heavy Duty E-Z Toggle

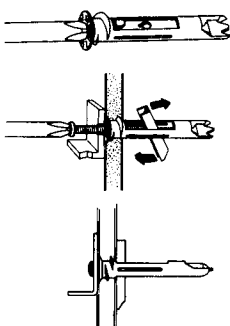

1. Place #2 Phillips screwdriver into recess of E-Z Toggle. Press into drywall while turning the anchor clockwise until it is seated flush with wall and arrows on head are parallel to stud.
2. Place fixture in position over installed E-Z Toggle. Insert screw and push through E-Z Toggle to engage clamp.
3. Continue turning screw until tight. The clamp will move back against the drywall as the screw turned.

# CONICAL PLASTIC ANCHOR

## FOR WOOD OR SHEET METAL SCREWS



### NON-RIBBED

Size	Part #	Qty
6-8 x 3/4	<b>35089</b>	100
8-10 x 7/8	<b>35090</b>	100
10-12 x 1	<b>35091</b>	100
14-16 x 1-3/8	<b>35092</b>	100



### RIBBED

Size	Part #	Qty
6-8 x 3/4	<b>35089R</b>	100
10-12 x 1	<b>35091R</b>	100
14-16 x 1-3/8	<b>35092R</b>	100



### ANCHOR KITS

Size	Part #
6-8	<b>FK91010</b>
10-12	<b>FK91015</b>
14-16	<b>FK91020</b>

Each Kit Contains  
 » 100 Non-Ribbed Anchors.  
 » 100 Screws.  
 » 1 Masonry bit.

**5**



# VINYL SCREW ANCHORS

## BEST ANCHORING DEVICE OF ITS KIND

### Vinyl Anchor Features

- » Does not turn in the hole - Maintains full contact permanently.
- » Not affected by moisture, acids or extreme temperatures.
- » Will not fray or flatten out when driven in hole.
- » No Lip - Permits flush mounting.

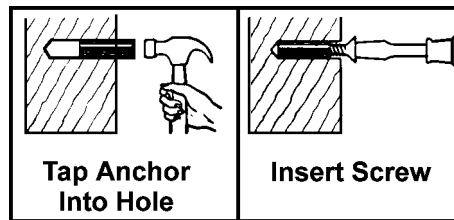

### FOR USE WITH:

- Wood Screws
- Screw Nails
- Sheet Metal Screws
- Lag Screws

Fits Screw Sizes	Anchor Length	Drill Size		Color	Safe Working Loads (lbs.)	Part #	Qty
		Plaster	Concrete				
4-5-6	1	13/64	3/16	white	85	<b>09662</b>	100
7-8-9	1	15/64	1/4	red	136	<b>09663</b>	100
10-11-12 & 3/16"	1	9/32	1/4	green	223	<b>09665</b>	100
	1-1/4	9/32	1/4	green	223	<b>09666</b>	100
	1-1/2	9/32	1/4	green	223	<b>09667</b>	100
	2	9/32	1/4	green	223	<b>09589</b>	100
13-14-15 & 1/4"	1-1/2	5/16	5/16	blue	267	<b>09670</b>	100
	2	5/16	5/16	blue	267	<b>09590</b>	100
16-18 & 5/16"	1-1/2	—	3/8	orange	392	<b>09585</b>	100
	2	—	3/8	orange	392	<b>09586</b>	100
20-22-24 & 3/8"	2	—	7/16	gray	537	<b>09587</b>	100
	2-1/2	—	7/16	gray	537	<b>09588</b>	100

# TOGGLE BOLTS

## ROUND & FLAT

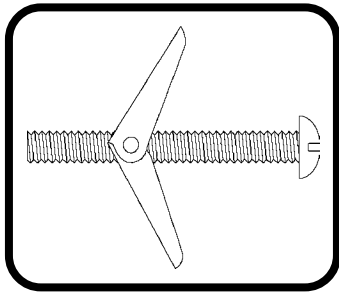

Round

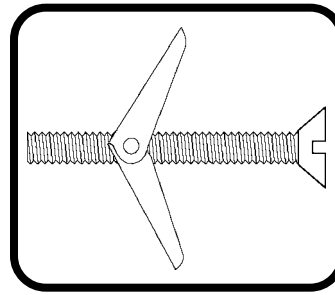

Flat

5

Dia	Length	Drill Size*	Matched Sets		Screws Only		Toggle Only Part #	Qty
			Round Part #	Flat Part #	Round Part #	Flat Part #		
<b>1/8</b> (6 - 32)	3	3/8	09726	35050	09729	35067	09725	50
	4		09727	35051	09730	35068		50
<b>3/16</b> (10-24)	3	1/2	09690	35052	09705	35069	09721	50
	4		09691	35053	09706	35060		50
	5		09692	35054	09707	35071		50
	6		09693	35055	09708	35072		50
<b>1/4</b> - 20	3	5/8	09694	35056	09709	35073	09722	50
	4		09695	35057	09710	35074		50
	5		09696	35058	09711	35075		50
	6		09697	35059	09712	35076		50
<b>5/16</b> - 18	3	3/4	09698	35060	09713	35077	09723	25
	4		09699	35061	09714	35078		25
	5		09700	35062	09715	35079		25
	6		09701	35063	09716	35080		25
<b>3/8</b> - 16	4	7/8	09702	35064	09717	35081	09724	25
	5		09703	35065	09718	35082		25
	6		09704	35066	09719	35083		25

» \* For hard material: Concrete block, tile and similar material, use drill 1/16" larger than size shown above.

## KAPTOGGLE™ ANCHORS

Screw Size	Drill Size	Part #	Qty
1/8 (6-32)	3/8	03955	50
3/16 (10-24)	1/2	03956	50
1/4-20	5/8	03957	50

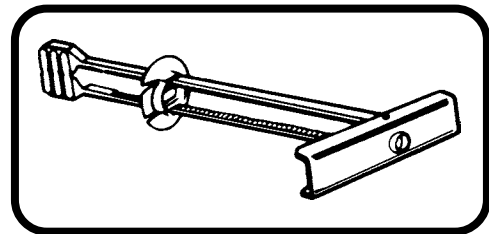

# VERSA TOGGLE® DRY WALL ANCHORS

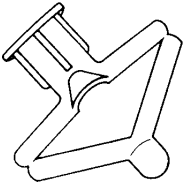

Size (Length)	Fits Wall Thickness	Drill Size	Screw Size	Part #	Qty
Extra Short	3/8	5/16	8-12	14886	100
Short	1/2	5/16	8-12	14887	100
Long	5/8	5/16	8-12	14888	100

- Drill 5/16" hole in dry wall.
- Squeeze fastener at mid section and insert into drilled hole.
- Tap Head of fastener flush to wall. Insert a No. 10 x 1" screw. Turn until firm grip is felt.

## HOLLOW WALL ANCHORS

5

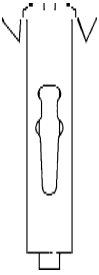

**Standard**



**Drive Point**

**FOR SECURE FASTENING IN:**

Wallboard	Hollow Tile
Plasterboard	Plywood
Lath	Cinder Block
Plaster	Metal Plate

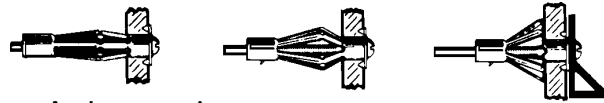

Anchor expands behind wall

- Reinforces wall
- Cannot pull through

- Fixtures can be removed and replaced in same anchor

Anchor Size	Fits Wall Thickness	Drill Size	Overall Length	Assembly Part #	Qty
1/8 XS	1/16 to 1/4	1/4	3/4	09816	100
1/8 S	1/8 to 1/2	1/4	1-1/4	09817	100
1/8 L	5/8 to 7/8	1/4	1-5/8	09818	100
3/16 S	1/8 to 5/8	3/8	2-1/6	09819	50
3/16 L	5/8 to 1-3/16	3/8	2-1/2	09820	50
1/4 S	1/8 to 5/8	1/2	2-1/16	09821	50
1/4 L	5/8 to 1-3/16	1/2	2-1/2	09822	50
1/8 SD*	1/8 to 1/2	1/4	1-1/4	09825	100
1/8 LD*	5/8 to 7/8	1/4	1-3/4	09826	100

\* Drive Point

## WALL SETTER TOOL

USE ON ALL SURFACE TYPES

Part No. 16165

**FOR USE WITH  
HOLLOW WALL  
ANCHORS**

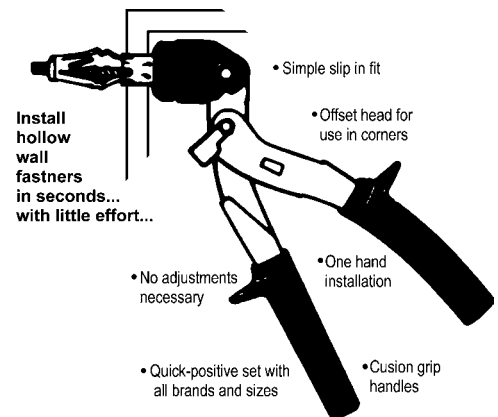

Install hollow wall fasteners in seconds... with little effort...

• Simple slip in fit

• Offset head for use in corners

• No adjustments necessary

• One hand installation

• Quick-positive set with all brands and sizes

• Cushion grip handles

# HAMMER DRIVE ANCHORS

## COMPLETE WITH DRIVE SCREWS OR PINS

Nylon or Zinc

5

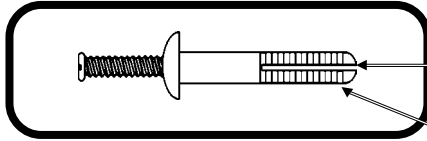

**Truss Head  
Nylon Anchor**

Slotted for maximum expansion.  
Serrated for positive permanent grip

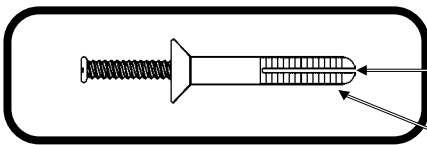

**Flat Head  
Nylon Anchor**

Slotted for maximum expansion.  
Serrated for positive permanent grip

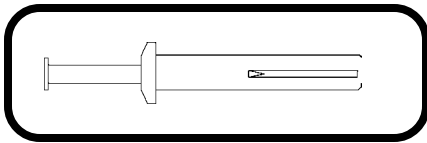

**Truss Head  
Zinc Alloy Anchor**

- » Nylon anchors are Reusable! Just screw it out to remove the anchor.
- » Nylon anchors are vibration and shock proof - Won't loosen, pull out or fracture.
- » Nylon anchors are nonconductive of electricity.
- » Nylon anchors will not rust or corrode.
- » Resistant to fungus, alkalies and chemicals.

### FOR USE WITH:

Concrete	Metal
Cinder Blocks	Stone
Brick	Marble
Wood	Tile
Glass	Slate
Plaster	Plastic

Style	Anchor Size	Drive-Screw Size	Drill Size	Holding Power	Part #	Qty
<b>Truss Head Nylon Anchor</b>	3/16 x 1	1/8 x 1-1/8	3/16	249	<b>09720</b>	100
	3/16 x 1-1/2	1/8 x 1-5/8	3/16	297	<b>09681</b>	100
	1/4 x 1	1/8 x 1-1/8	1/4	262	<b>09682</b>	100
	1/4 x 1-1/2	1/8 x 1-5/8	1/4	320	<b>09683</b>	100
<b>Truss Head Zinc Alloy Anchor</b>	3/16 x 7/8	1/8 x 1	3/16	1560	<b>09630</b>	100
	1/4 x 1	1/8 x 1-1/8	1/4	1560	<b>09631</b>	100
	1/4 x 1-1/4	1/8 x 1-3/8	1/4	1560	<b>09632</b>	100
	1/4 x 1-1/2	1/8 x 1-5/8	1/4	1560	<b>09633</b>	100
	1/4 x 2	1/8 x 2-1/8	1/4	1560	<b>09634</b>	100
<b>Flat Head Nylon Anchor</b>	3/16 x 1	1/8 x 1-1/8	3/16	249	<b>09684</b>	100
	1/4 x 1	1/8 x 1-1/8	1/4	261	<b>09685</b>	100
	1/4 x 1-1/2	1/8 x 1-1/8	1/4	320	<b>09686</b>	100

# ACRYLIC TIE ADHESIVE

## ACRYLIC-BASED ANCHORING ADHESIVE



Acrylic-Tie is a two component, 10:1 ratio acrylic based adhesive for use as a high strength, anchor grouting material. Resin and initiator are dispensed and mixed simultaneously through the mixing nozzle. AT meets the physical requirements of ASTM C881 for a Type I & IV, Grade 3, Classes A, B, & C, except Acrylic-Tie is a non-epoxy product formulated for fast cure time.

Adhesive Part #	Tube Size	Simpson Reference Number	Carton Qty	Dispensing Tool	Mixing Nozzle Part #
14600	5 oz.	ATPAC05KT	12	Standard Caulk Gun(BNT-500)	14620
14601	8 oz.	AT08	10	14626	14620
14602	13 oz.	AT13	10	14626	14620
14603	30 oz.	AT30	5	14628 or 14630	14621

### Uses:

- Threaded rod Anchoring
- Rebar dowelling
- Paste-over for crack injection
- Pick proof sealant

5

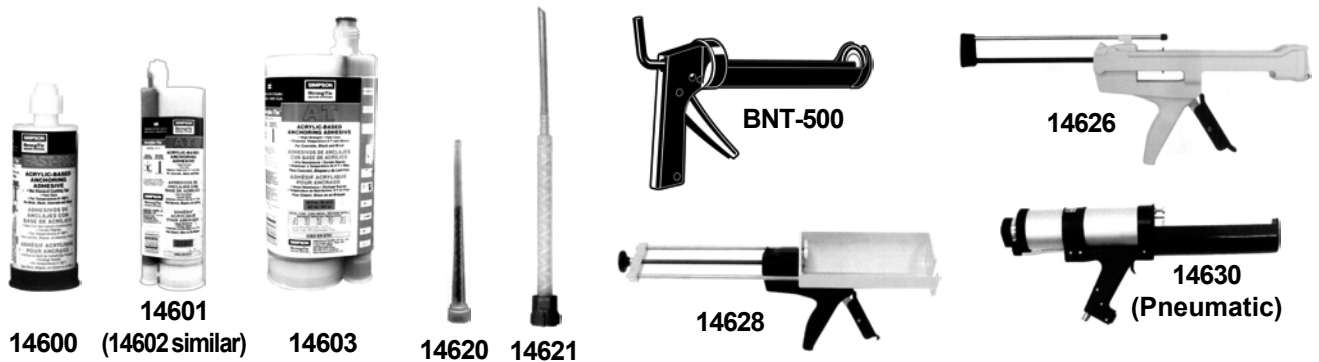

### Installation Instructions:

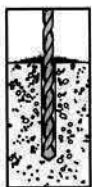

**1. Drill** - Drill hole to specified diameter and depth.



**2. Clean** - Remove dust from hole with oil-free compressed air. Clean with nylon brush and blow out remaining dust. **Note: Dust left in hole can reduce the adhesive's holding capacity.**

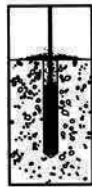

**3. Cut open top of cartridge.** (AT FAST-PAC has removable plugs)



**4. Attach clean mixing nozzle.**



**5. Fill** - Dispense bead of adhesive off to the side to check for proper mixture (a uniform gray color) before using. Fill hole halfway, starting from bottom of hole to prevent air pockets. Withdraw nozzle as hole fills up.

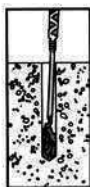

**6. Insert** - Anchors must be clean and oil free. Insert anchor, turning slowly until the anchor contacts the bottom of the hole. Do not disturb during cure time.

**SIMPSON****Strong-Tie**  
ANCHOR SYSTEMS™

# HIGH STRENGTH EPOXY TIE ADHESIVE

## 2-PART EPOXY ANCHORING ADHESIVE

Epoxy-Tie SET epoxy is a two-component, low odor, 1:1 ratio, 100% solids epoxy-based adhesive for use as a high strength, non-shrink anchor grouting material. Resin and hardener are dispensed and mixed simultaneously through the mixing nozzle. SET meets the ASTM C-881 specification for Type I, IV and V, Grade 3, Class B, C and D.

### Uses:

- Anchor grouting and rebar dowelling
- Bonding hardened concrete to hardened concrete
- Pressure injection of wide width cracks 3/16" - 3/4"
- As a pick proof sealant around doors, windows and fixtures

**5**

14605



14607



14608



14609



14621



14622

Adhesive Part #	Tube Size	Simpson Reference Number	Carton Qty	Dispensing Tool	Mixing Nozzle Part #
14605	1.7 oz.	SET1.7KT	24	None Needed	14619
14606	1.7 oz.	SET1.7KTA	12	Standard Caulk Gun(BNT-500)	14619 (included)
14607	10 oz.	SETPAC10	12	Standard Caulk Gun(BNT-500)	none needed
14608	22 oz.	SET22	10	14627 or 14629	14621
14609	56 oz.	SET56	6	14631	14622



14627

14629  
(Pneumatic)14631  
(Pneumatic)

### Installation Instructions:



**1. Drill** - Drill hole to specified diameter and depth.



**2. Clean** - Remove dust from hole with oil-free compressed air. Clean with nylon brush and blow out remaining dust. **Note: Dust left in hole can reduce the adhesive's holding capacity.**



**3. Cut open top of cartridge.** (SET56 has removable plugs)

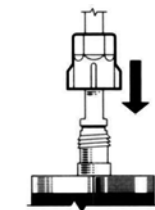

**4. Attach clean mixing nozzle.**



**5. Fill** - Dispense bead of adhesive off to the side to check for proper mixture (a uniform gray color) before using. Fill hole halfway, starting from bottom of hole to prevent air pockets. Withdraw nozzle as hole fills up.

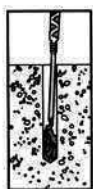

**6. Insert** - Anchors must be clean and oil free. Insert anchor, turning slowly until the anchor contacts the bottom of the hole. Do not disturb during cure time.



# VGC - GLASS CAPSULE EPOXY ANCHOR

The VGC system is a two component, vinylester based adhesive contained within a glass capsule. The capsule is placed in the hole and the resin and initiator components are combined when the rod or rebar is driven to the bottom of the hole through the capsule.



Rod Dia. or Rebar Size	Capsule Size	Hole Dia.	Part #	Qty
3/8" or #3	7/16 x 3-1/2	7/16	14635	10
1/2" or #4	1/2 x 3-7/8	9/16	14636	10
5/8" or #5	5/8 x 3-7/8	11/16	14637	10
3/4" or #6	3/4 x 7	7/8	14638	5
7/8" or #7	7/8 x 8	1"	14639	5
1" or #8	7/8 x 8	1-1/8	14639	5

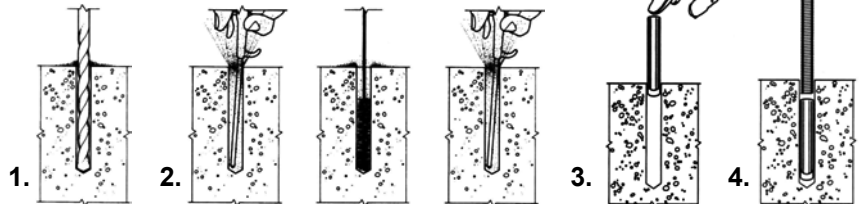

5

## CRACK REPAIR EPOXY SYSTEMS FOR CONCRETE



**Crack-Pac** single tube crack injection epoxy mixes in the tube and dispenses from a standard caulking gun. The Crack-Pac contains a two-part, low viscosity 100% epoxy solids crack injection formula. The resin is contained in the cartridge and the hardener is contained in the nozzle. Once mixed, the adhesive has the viscosity of a light oil and a low surface tension which allows it to penetrate fine to medium width cracks (*suggested width range: 1/64" - 1/4"*).

**ETI Injection Epoxies** are specially designed formulations for the injection of cracks in concrete. ETI epoxies are two-component, 1:1 ratio, 100% epoxy solids formulations. They are available in 22 ounce side-by-side cartridges and are dispensed through a static mixing nozzle using a manual or pneumatic dispensing tool. ETI is available in two viscosities: **ETI-LV** (*low viscosity*) and **ETI-GV** (*gel viscosity*) to handle a wide range of crack widths. Properly applied, they provide a repair that is both waterproof and high strength (*structural*).



Adhesive Part #	Tube Size	Simpson Reference Number	Carton Qty	Dispensing Tool	Mixing Nozzle Part #
14612	9 oz.	ETIPAC10KT (Crack-Pac™)	2	Standard Caulk Gun(BNT-500)	Included
14615	22 oz.	ETILV22	10	14627 or 14629	14623
14616	22 oz.	ETIGV22	10		14623



**SIMPSON**

**Strong-Tie**  
ANCHOR SYSTEMS

# POWDER ACTUATED GUN KIT

27 CALIBER STRIP LOADS

Part # 04750

**World's Most Versatile Powder Actuated Tool!**



Part # 04750

## Features

- Simple to maintain: patented modular design allows for field maintenance and repairs in minutes.
- Semiautomatic firing.
- Operator comfort: shock absorbing Zytel handle.



## Specifications

- Fastener Length: 1/2" thru 3"
- Fastener Type: .300 inch or 8mm Diameter
- Firing Action: Semi-Automatic
- Load Caliber: .27 Strip Loads, Brown thru Red (Levels 2-5)
- Length: 13 1/4"
- Weight: 5 lbs., 2 oz.

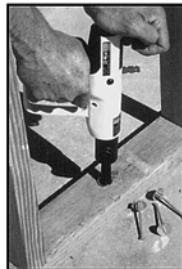

Tool is sold in a rugged tool box



## Tool Box Comes Complete With

- Operator's Manual
- Spall Suppressor
- Tools for Disassembly
- Safety Glasses/Ear Plugs
- Tool Lubricant
- Cleaning Brushes
- Operator's Exam and Caution Sign

## Key Fastening Applications

- General Purpose
- Fastening Drywall and Hat Track
- Sill Plate and Forming Work
- HVAC and Electrical Applications

5

# POWDER ACTUATED LOADS



## .22 CALIBER SINGLE SHOT CRIMP LOADS

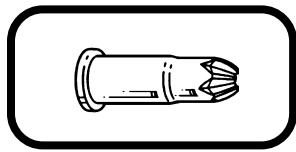

Color	Part #	Qty
Gray	04600	100
Brown	04601	100
Green	04602	100
Yellow	04603	100

## .25 CALIBER LOADS

5

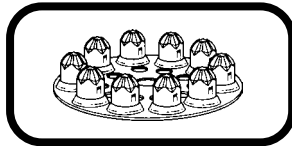

10-Shot Metal Disc Load

Color	Part #	Qty
Brown	04605	100
Green	04606	100
Yellow	04607	100
Red	04608	100

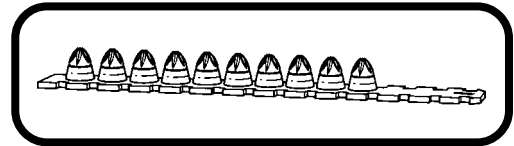

10-Shot Plastic Strip Load

Color	Part #	Qty
Green	04610	100
Yellow	04611	100
Red	04612	100

## .27 CALIBER LOADS

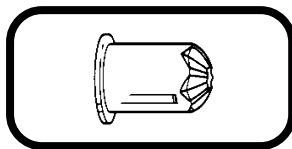

Single Shot Crimp Loads

Color	Part #	Qty
Green	04615	100
Yellow	04616	100
Red	04617	100
Purple	04618	100

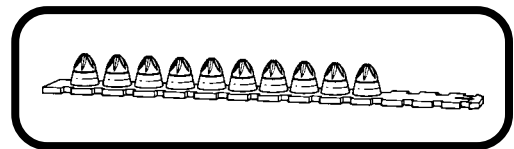

10-Shot Plastic Strip Load

Color	Part #	Qty
Green	04620	100
Yellow	04621	100
Red	04622	100
Purple	04623	100

# POWDER ACTUATED PINS

## .300 HEADED FASTENERS

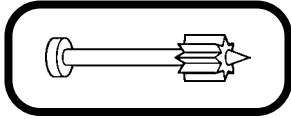

**.300 Headed**

Length	Part #	Qty
1/2	04630	100
1/2 *	04631	100
5/8 *	04632	100
3/4	04633	100
1"	04634	100
1-1/4	04635	100
1-1/2	04636	100
1-3/4	04637	100
2"	04638	100
2-1/2	04640	100
3"	04641	100

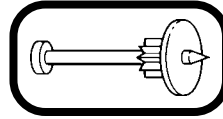

**.300 Headed with 3/4" Washer**

Length	Part #	Qty
3/4	04650	100
1"	04651	100
1-1/4	04652	100
1-1/2	04653	100
2"	04655	100
2-1/2	04656	100
3"	04657	100

\* Knurled for steel applications

## .300 HEADED TOPHAT FASTENERS

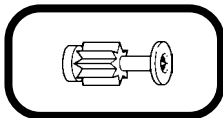

Length	Part #	Qty
3/4"	04681	100

## PRE-ASSEMBLED CEILING CLIPS

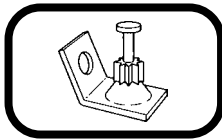

Length	Part #	Qty
1-1/4"	04710	100

# POWDER ACTUATED STUDS

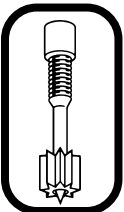

**1/4-20 Threaded Studs**

Length	Overall Length	Part #	Qty
1/4-20 x 3/4	1-3/4	04730	100

**3/8-16 Threaded Studs**

Length	Overall Length	Part #	Qty
3/8-16 x 1	2-1/16	04731	100

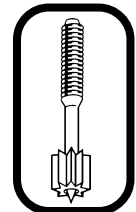

# METAL FRAMING CHANNEL (STRUT)

Pre-Galvanized and Green Finishes

**B-Line** 

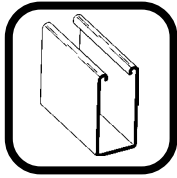

Gauge	Length	Dimensions		Finish	Part #	Qty
		Height	Width			
12	10'	3-1/4	1-5/8	Pre-Galvanized	B11-Galv	1
12	10'	3-1/4	1-5/8	Green	B11-Green	1

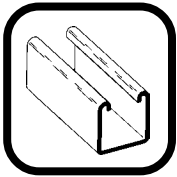

Gauge	Length	Dimensions		Finish	Part #	Qty
		Height	Width			
12	10'	1-5/8	1-5/8	Pre-Galvanized	B22-Galv	1
12	10'	1-5/8	1-5/8	Green	B22-Green	1
12	10'	1-5/8	1-5/8	Pre-Galvanized	B22SH-Galv*	1
12	10'	1-5/8	1-5/8	Green	B22SH-Green*	1

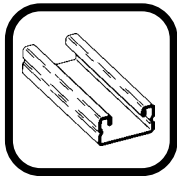

Gauge	Length	Dimensions		Finish	Part #	Qty
		Height	Width			
16	10'	13/16	1-5/8	Pre-Galvanized	B56SH-Galv*	1
16	10'	13/16	1-5/8	Green	B56SH-Green*	1

\* **Slotted Channel** - Hole patterns provide an economical alternative to costly field drilling required for many applications.

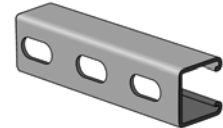
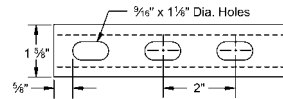

5

# STRUT NUTS

Spring Nuts, Nuts without Springs, Twirl® Nuts

**B-Line** 

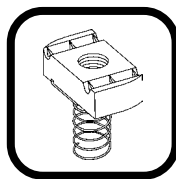

Spring Nut

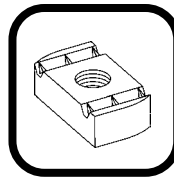

Nut w/o Spring

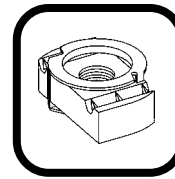

Twirl® Nut

Thread Size	Part #			Qty
	Spring Nut	Nut w/o Spring	Twirl® Nut	
1/4-20	N224-ZINC	N224WO-ZINC	TN224-ZINC	100
3/8-16	N228-ZINC	N228WO-ZINC	TN228-ZINC	100
1/2-13	N225-ZINC	—	TN225-ZINC	100
5/8-11	N255-ZINC	—	—	100

# STRUT FITTINGS

Zinc and Green



## Square Washer

Zinc and Green

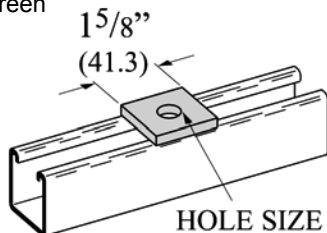

Bolt Size	Hole Size	Style	Part #	Qty
3/8	7/16	Green	<b>B201-Green</b>	100
3/8	7/16	Zinc	<b>B201-Zinc</b>	100
1/2	9/16	Green	<b>B202-Green</b>	100
1/2	9/16	Zinc	<b>B202-Zinc</b>	100

5

## Two Hole Splice Plate

Zinc and Green

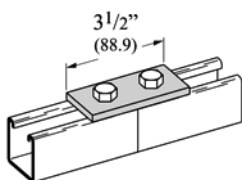

Part #	Qty
<b>B129-Green</b>	50
<b>B129-Zinc</b>	50

## Three Hole Splice Plate

Zinc and Green

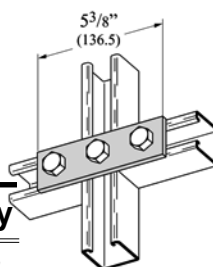

Part #	Qty
<b>B141-Green</b>	25
<b>B141-Zinc</b>	25

## Four Hole Splice Plate

Zinc and Green

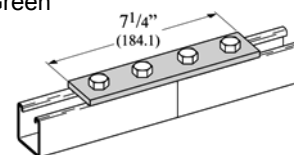

Part #	Qty
<b>B341-Green</b>	25
<b>B341-Zinc</b>	25

## Three Hole Swivel Plate

Zinc and Green

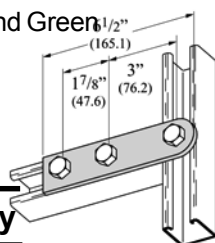

Part #	Qty
<b>B139-Green</b>	25
<b>B139-Zinc</b>	25

## Three Hole Corner Plate

Zinc and Green

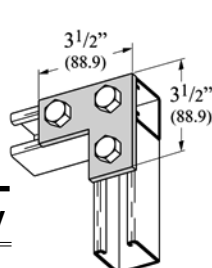

Part #	Qty
<b>B140-Green</b>	25
<b>B140-Zinc</b>	25

## Four Hole Corner Plate

Zinc and Green

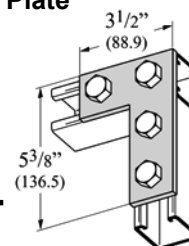

Part #	Qty
<b>B143-Green</b>	25
<b>B143-Zinc</b>	25

## Four Hole Tee Plate

Zinc and Green

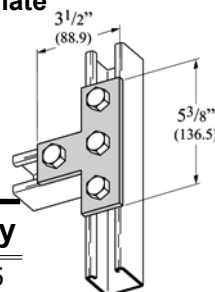

Part #	Qty
<b>B133-Green</b>	25
<b>B133-Zinc</b>	25

## Five Hole Cross Plate

Zinc and Green

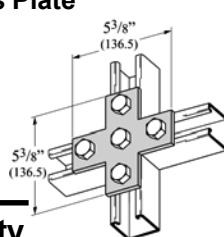

Part #	Qty
<b>B132-Green</b>	20
<b>B132-Zinc</b>	20

## Two Hole Corner Angle

Zinc and Green

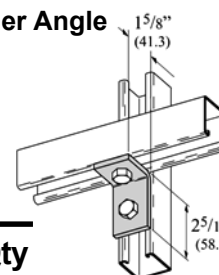

Part #	Qty
<b>B101-Green</b>	50
<b>B101-Zinc</b>	50

# STRUT FITTINGS

Zinc and Green



## Four Hole Corner Angle

Zinc and Green

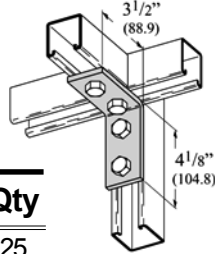

Part #	Qty
B104-Green	25
B104-Zinc	25

## Four Hole Open Angle

Zinc and Green

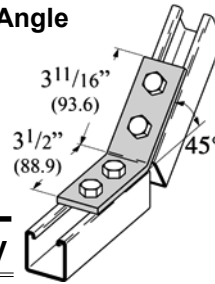

Part #	Qty
B248-Green	25
B248-Zinc	25

## Four Hole Splice Clevis for B22

Zinc and Green

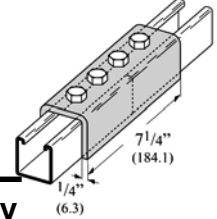

Part #	Qty
B172-Green	10
B172-Zinc	10

## Five Hole U-Support

Zinc and Green

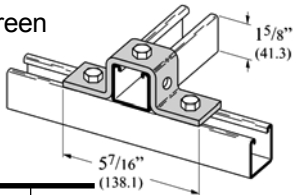

Part #	Qty
B107-Green	25
B107-Zinc	25

## Ten Hole Double Wing Connection

Zinc and Green

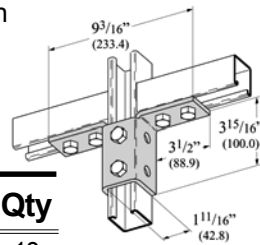

Part #	Qty
B273-Green	10
B273-Zinc	10

## Post Base for B22

Zinc and Green

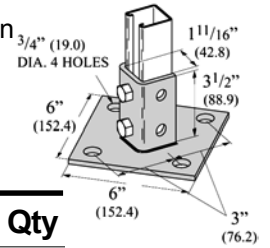

Part #	Qty
B280-Green	5
B280-Zinc	5

## Post Base for B22

Zinc and Green

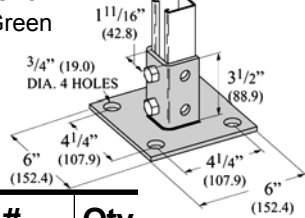

Part #	Qty
B280SQ-Green	5
B280SQ-Zinc	5

## Post Base for B22A, B, C, etc.

Zinc and Green

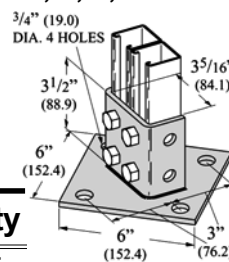

Part #	Qty
B281-Green	5
B281-Zinc	5

## Strut End Cap for B22

Zinc and Green

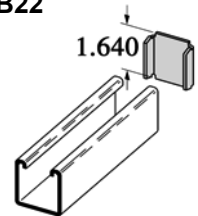

Part #	Qty
B205-Green	100
B205-Zinc	100

## Strut End Cap for B11

Zinc and Green

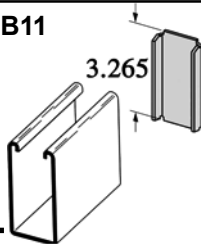

Part #	Qty
B222-Green	25
B222-Zinc	25

## Plastic End Cap for B22

Zinc and Green

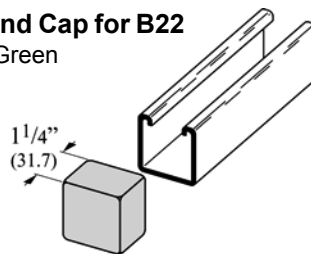

Part #	Qty
B822	100

5

# BEAM CLAMPS

## STEEL C-CLAMP

Zinc

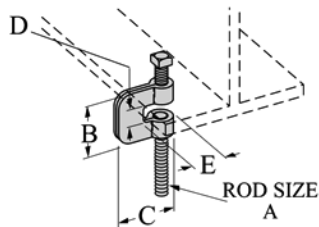

Rod Size A	B	C	D	E	Part #	Qty
3/8 -16	2-3/8	2-3/8	3/4	1-3/8	<b>B351-3/8</b>	50
1/2-13	2-3/8	2-3/8	3/4	1-3/8	<b>B351-1/2</b>	50

- » Safety factor of 5.
- » Setscrew included.

## THREADED ROD SUPPORT

Zinc

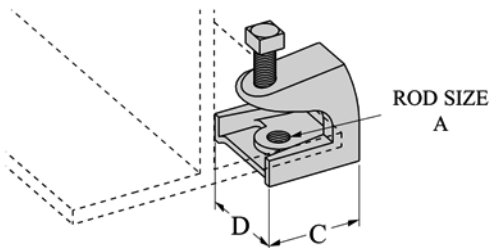

Rod Size A	C	D	Part #	Qty
1/4-20	1-3/8	1-3/16	<b>B444-1/4</b>	50

- » Safety factor of 5.
- » Setscrew included.
- » 1/2" (12.7) max. flange thickness.

## STRUT TO BEAM CLAMP FOR B22

Zinc

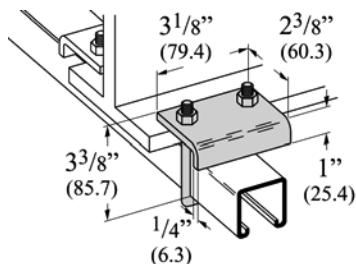

Part #	Qty
<b>B441-22</b>	25

- » Design load 1200 lbs. when used in pairs.
- » Safety factor of 5.
- » 3/4" (19.0) max. flange thickness.
- » Recommended torque: 150 in-lbs.



# PIPE CLAMPS

THINWALL CONDUIT (EMT) CLAMPS, RIGID CONDUIT OR PIPE CLAMPS  
Zinc

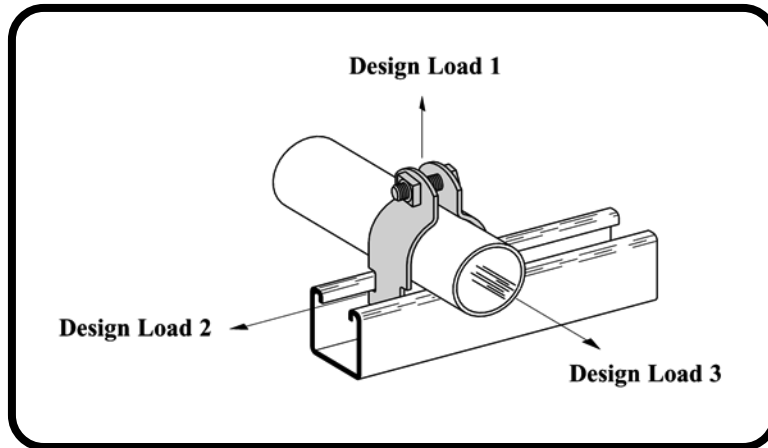

**5**

- » Safety factor of 5.
- » Includes slotted hex head, machine screw and square nut.

## Thinwall Conduit (EMT) Clamps

Conduit Size	Material Thickness	Design Load 1	Design Load 2	Design Load 3	Part #	Qty
1/2	16 Gauge	400 lbs.	50 lbs.	50 lbs.	B2001-Zinc	100
3/4	16 Gauge	400 lbs.	50 lbs.	50 lbs.	B2002-Zinc	100

## Rigid Conduit or Pipe Clamps

Conduit Size	Material Thickness	Design Load 1	Design Load 2	Design Load 3	Part #	Qty
3/8	16 Gauge	400 lbs.	50 lbs.	50 lbs.	B2007-Zinc	100
1/2	16 Gauge	400 lbs.	50 lbs.	50 lbs.	B2008-Zinc	100
3/4	14 Gauge	600 lbs.	75 lbs.	75 lbs.	B2009-Zinc	100
1"	14 Gauge	600 lbs.	75 lbs.	75 lbs.	B2010-Zinc	100
1-1/4	14 Gauge	600 lbs.	75 lbs.	75 lbs.	B2011-Zinc	50
1-1/2	12 Gauge	800 lbs.	125 lbs.	125 lbs.	B2012-Zinc	50
2"	12 Gauge	800 lbs.	125 lbs.	125 lbs.	B2013-Zinc	50

# PIPE CLAMPS

## TUBING CLAMPS

Zinc and Copper



» Safety Factor of 5.

» Includes slotted hex head, machine screw and square nut.

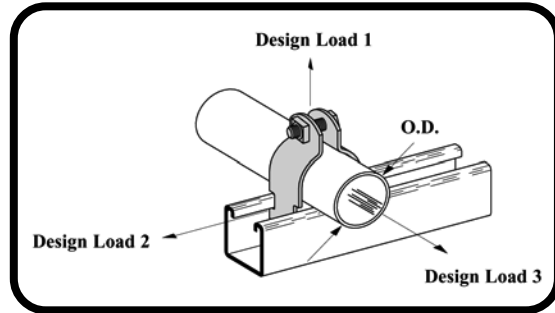

### O.D. Tubing Clamps - Zinc

O.D. Size (in.)	Material Thickness	Design Load 1	Design Load 2	Design Load 3	Part #	Qty
1/2	16 Gauge	400 lbs.	50 lbs.	50 lbs.	B2025-Zinc	100
5/8	16 Gauge	400 lbs.	50 lbs.	50 lbs.	B2026-Zinc	100
3/4	16 Gauge	400 lbs.	50 lbs.	50 lbs.	B2027-Zinc	100
1"	14 Gauge	500 lbs.	75 lbs.	75 lbs.	B2029-Zinc	100
1-1/8	14 Gauge	600 lbs.	75 lbs.	75 lbs.	B2030-Zinc	100
1-1/4	14 Gauge	600 lbs.	75 lbs.	75 lbs.	B2031-Zinc	100
1-3/8	14 Gauge	600 lbs.	75 lbs.	75 lbs.	B2032-Zinc	100
1-1/2	14 Gauge	600 lbs.	75 lbs.	75 lbs.	B2033-Zinc	100
1-5/8	14 Gauge	600 lbs.	75 lbs.	75 lbs.	B2034-Zinc	50
1-3/4	12 Gauge	800 lbs.	125 lbs.	125 lbs.	B2035-Zinc	50
1-7/8	12 Gauge	800 lbs.	125 lbs.	125 lbs.	B2036-Zinc	50
2"	12 Gauge	800 lbs.	125 lbs.	125 lbs.	B2037-Zinc	50
2-1/8	12 Gauge	800 lbs.	125 lbs.	125 lbs.	B2038-Zinc	50
2-1/4	12 Gauge	800 lbs.	125 lbs.	125 lbs.	B2039-Zinc	50
2-1/2	12 Gauge	800 lbs.	125 lbs.	125 lbs.	B2041-Zinc	50
2-3/4	12 Gauge	800 lbs.	125 lbs.	125 lbs.	B2043-Zinc	50
3"	12 Gauge	800 lbs.	125 lbs.	125 lbs.	B2045-Zinc	50

### Copper Tubing Clamps

Tubing Size	Material Thickness	O.D. Size (in.)	Design Load 1	Design Load 2	Design Load 3	Part #	Qty
1/4	16 Gauge	.375	400 lbs.	50 lbs.	50 lbs.	B2024-DCU	100
3/8	16 Gauge	.500	400 lbs.	50 lbs.	50 lbs.	B2025-DCU	100
1/2	16 Gauge	.625	400 lbs.	50 lbs.	50 lbs.	B2026-DCU	100
3/4	16 Gauge	.875	400 lbs.	50 lbs.	50 lbs.	B2028-DCU	100
1"	16 Gauge	1.125	600 lbs.	75 lbs.	75 lbs.	B2030-DCU	100
1-1/4	14 Gauge	1.375	600 lbs.	75 lbs.	75 lbs.	B2032-DCU	100
1-1/2	14 Gauge	1.625	600 lbs.	75 lbs.	75 lbs.	B2034-DCU	50
2"	12 Gauge	2.125	800 lbs.	125 lbs.	125 lbs.	B2038-DCU	50

# SAMMY SUPER SCREW™

## NUT DRIVERS

Black, Red & Blue



**ITW Buildex**  
Building Ideas That Work®

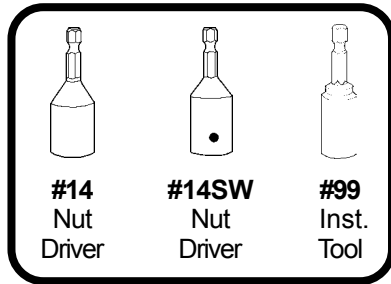

Description	Color	Part #	Qty
#14 Nut Driver	Red	<b>SAM-14</b>	1
#14SW Nut Driver	Blue	<b>SAM-14SW</b>	1
#99 Installation Tool	Black	<b>SAM-99</b>	1

5

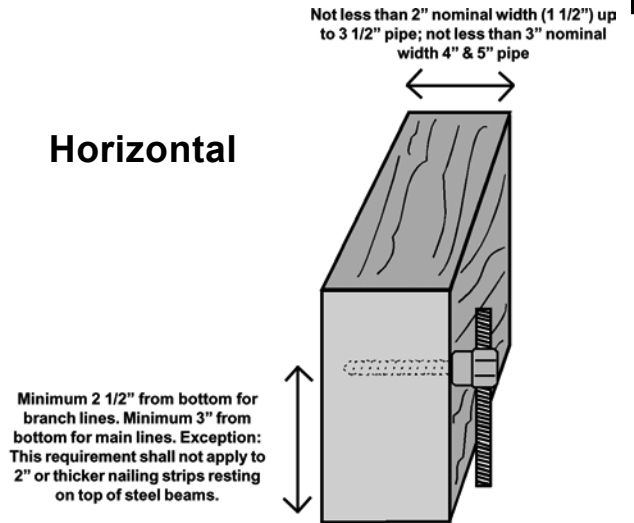
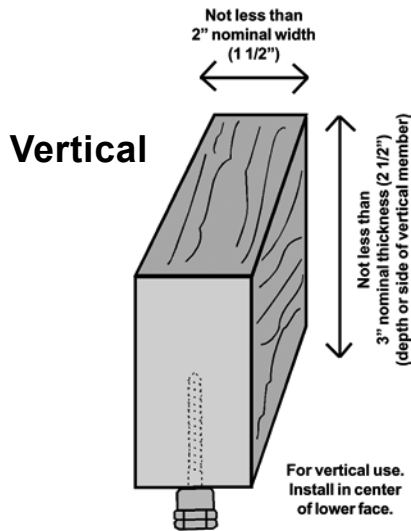

## VERTICAL MOUNT SCREWS FOR WOOD

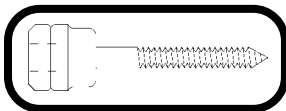

Rod	Shank Length	Driver #	Part #	Qty
1/4-20	2	#14	<b>SAM-GST200</b>	1
3/8-16	2	#14	<b>SAM-GST20</b>	1
1/2-13	2	#14	<b>SAM-GST2</b>	1
1/2-13	2-1/2	#14SW	<b>SAM-GST2.5-380</b>	1

## HORIZONTAL MOUNT SCREWS FOR WOOD

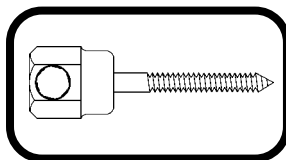

Rod	Shank Length	Driver #	Part #	Qty
1/4-20	2	#14SW	<b>SAM-SWG200</b>	1
3/8-16	2	#14SW	<b>SAM-SWG20</b>	1
3/8-16	2-1/2	#14SW	<b>SAM-SWG25-380</b>	1

# SAMMY SUPER SCREW™ FOR STEEL

**5**

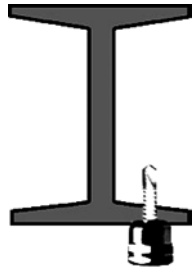

**Vertical**



**Horizontal**

## VERTICAL MOUNT SCREWS FOR STEEL

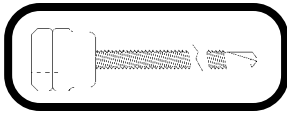

Rod	Screw Description	Driver #	Part #	Qty
1/4-20	1/4-14 x 1-1/2	#14	SAM-DST150	1
3/8-16	1/4-14 x 1-1/2	#14	SAM-DST15	1
3/8-16	12-24 x 1-1/2	#14	SAM-TEK50	1
1/2-13	1/4-14 x 2-1/2	#14SW	SAM-DST2.5	1

## HORIZONTAL MOUNT SCREWS FOR STEEL

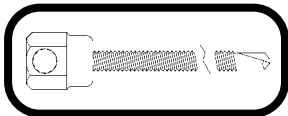

Rod	Screw Description	Driver #	Part #	Qty
3/8-16	1/4-14 x 1-1/2	#14SW	SAM-SWD15	1

## DROP CEILING SCREWS FOR STEEL

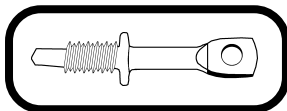

Shank Length	Driver #	Part #	Qty
1"	#99	SAM-CWS1	1

# SAMMY SUPER SCREW™

## FOR CONCRETE



**TW Buildex**  
Building Ideas That Work®



**Vertical**

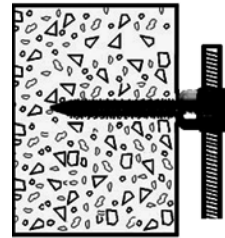

**Horizontal**

**5**

### VERTICAL MOUNT SCREWS FOR CONCRETE

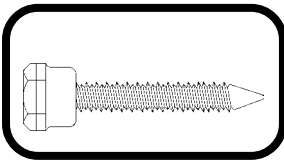

Rod	Shank Length	Driver #	Part #	Qty
1/4-20	1-1/2	#14	SAM-CST200	1
3/8-16	1-1/2	#14	SAM-CST20	1
1/2-13	1-1/2	#14SW	SAM-CST2	1

### HORIZONTAL MOUNT SCREWS FOR CONCRETE

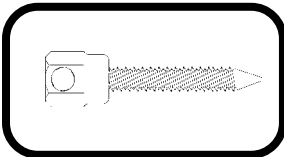

Rod	Shank Length	Driver #	Part #	Qty
3/8-16	1-1/2	#14SW	SAM-SWC20	1



# FAS-KIT<sup>®</sup> ANCHOR ASSORTMENTS



## Plastic Box Assortments

Part Number	Description	Number of Pieces
FK05000	Toggle Bolts with Wings	80

5

## Metal Tray Assortments

Small Drawer	Large Drawer	Description	Number of Pieces
FK17000	FK57000	Plastic Anchors & Screws w/ Masonry Bits	704
FK17050	FK57050	Vinyl Sleeve Screw Anchors	575
FK17100	FK57100	Tapcon™ Concrete Screws, Phillips Flat Head	404
FK17150	FK57150	Tapcon™ Concrete Screws, Hex Washer Head	404
—	FK57170	Tapcon™ Concrete Screws, Flat Head & Hex Head	408
FK17200	FK57200	Wall Anchors, Assorted Styles	235
FK17250	FK57250	Toggle Bolts, Round Head w/ Wings	215
FK17300	FK57300	Drop-In & Expansion Shields	194

# Section 6: Stainless Steel

## Table of Contents

### Stainless Cap Screws

Hex Head, <i>USS</i> .....	3-4
Hex Head, <i>SAE</i> .....	4

### Stainless Nuts

Finished Hex Nuts .....	5
Nylon Insert Lock Nuts .....	5
Machine Screw Nuts .....	5
Acorn Nuts .....	5
Keps Nuts .....	5
Wing Nuts .....	5

### Stainless Washers

Flat Washers .....	6
Split Lock Washers .....	6
External Star Washers .....	6
Internal Star Washers .....	6
Fender Washers .....	6
Finishing Washers .....	6

### Stainless Machine Screws

Slotted Round Head .....	7
Slotted Flat Head .....	8
Phillips Flat Head .....	9
Phillips Oval Head .....	9
Phillips Pan Head .....	10
Phillips Truss Head .....	10

### Stainless Sheet Metal Screws

Phillips Pan Head .....	11
Slotted Pan Head .....	11
Phillips Flat Head .....	12
Phillips Oval Head .....	12
Phillips Truss Head .....	13

### Stainless Tek Screws

Hex Head .....	13
----------------	----

### Stainless Socket Screws

Socket Head Cap .....	14
Button Head Cap .....	15
Flat Head Cap .....	15
Socket Set Screws .....	16

### Stainless Pins & Rings

Cotter Pins .....	17
Blind Rivets .....	18

### Stainless Bolts

Carriage Bolts .....	19
Hex Lag Bolts .....	19
Threaded Rods .....	20

### Stainless Metric

Cap Screws, Hex Head .....	21
Hex Nuts .....	22
Nylon Insert Locknuts .....	22
Acorn Nuts .....	22
Flat Washers .....	22
Lock Washers .....	22
Cap Screws, <i>Socket Head</i> .....	23
Cap Screws, <i>Flat Head</i> .....	24
Cap Screws, <i>Button Head</i> .....	24
Socket Set Screws, <i>Cup Point</i> .....	25
Machine Screws, <i>Phillips Pan Head</i> .....	26
Machine Screws, <i>Phillips Flat Head</i> .....	26

Stainless Faskit Assortments .....	27-28
------------------------------------	-------





# HEX HEAD CAP SCREWS

## 18-8 STAINLESS STEEL

USS Coarse Thread

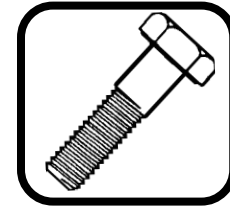

Dia	Length	Part #	Qty
<b>1/4</b> -20 USS Thread	1/2	33601	100
	5/8	33602	100
	3/4	33603	100
	1"	33605	100
	1-1/4	33606	100
	1-1/2	33607	100
	1-3/4	33608	50
	2"	33609	50
	2-1/4	33610	50
	2-1/2	33611	50
	2-3/4	33612	50
	3"	33613	25
	3-1/2	33614	25
	4"	33615	25
	4-1/2	33616	25
	5"	33617	25
	5-1/2	33618	25
	6"	33619	25
	<b>5/16</b> -18 USS Thread	1/2	33620
5/8		33621	50
3/4		33622	50
1"		33624	50
1-1/4		33625	50
1-1/2		33626	50
1-3/4		33627	25
2"		33628	25
2-1/4		33629	25
2-1/2		33630	25
2-3/4		33631	25
3"		33632	25
3-1/2		33633	25
4"		33634	10
4-1/2		33635	10
5"	33636	10	
5-1/2	33637	10	
6"	33638	10	
<b>3/8</b> -16 USS Thread	1/2	33640	50
	5/8	33641	50
	3/4	33642	50
	1"	33644	50
	1-1/4	33645	50

Dia	Length	Part #	Qty	
<b>3/8</b> -16 USS Thread	1-1/2	33646	50	
	1-3/4	33647	50	
	2"	33648	25	
	2-1/4	33649	25	
	2-1/2	33650	25	
	2-3/4	33651	25	
	3"	33652	25	
	3-1/2	33653	25	
	4"	33654	25	
	4-1/2	33655	10	
	5"	33656	10	
	5-1/2	33657	10	
	6"	33658	10	
	7"	33658A	1	
	<b>7/16</b> -14 USS Thread	3/4	33660	25
		1"	33661	25
		1-1/4	33662	25
1-1/2		33663	25	
1-3/4		33664	25	
2"		33665	25	
2-1/4		33666	25	
2-1/2		33667	25	
3"		33668	25	
3-1/2		33669	10	
4"		33670	10	
4-1/2		33671	10	
5"		33672	10	
5-1/2		33673	10	
6"		33674	10	
<b>1/2</b> -13 USS Thread	3/4	33675	25	
	1"	33676	25	
	1-1/4	33677	25	
	1-1/2	33678	25	
	1-3/4	33679	25	

Dia	Length	Part #	Qty
<b>1/2</b> -13 USS Thread	2"	33680	25
	2-1/4	33681	25
	2-1/2	33682	25
	2-3/4	33683	25
	3"	33684	10
	3-1/2	33685	10
	4"	33686	10
	4-1/2	33687	10
	5"	33688	10
	5-1/2	33689	10
<b>5/8</b> -11 USS Thread	1"	33691	20
	1-1/4	33692	20
	1-1/2	33693	20
	1-3/4	33694	20
	2"	33695	20
	2-1/4	33696	20
	2-1/2	33697	20
	2-3/4	33698	20
	3"	33699	20
	3-1/2	33700	20
<b>3/4</b> -10 USS Thread	4"	33701	10
	4-1/2	33702	10
	5"	33703	10
	5-1/2	33704	10
	6"	33705	10
	1"	33706	20
	1-1/4	33707	20
	1-1/2	33708	20
	1-3/4	33709	20
	2"	33710	20
2-1/4	33711	20	
2-1/2	33712	20	
2-3/4	33713	20	
3"	33714	10	
3-1/2	33715	10	
4"	33716	10	
4-1/2	33717	10	
5"	33718	10	
5-1/2	33719	10	
6"	33720	10	

6

# HEX HEAD CAP SCREWS

## 18-8 STAINLESS STEEL

USS Coarse Thread

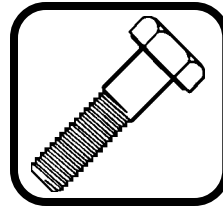

Dia	Length	Part #	Qty
<b>7/8</b> -9 USS Thread	1-1/2	3372	10
	1-3/4	33726	10
	2"	33727	10
	2-1/2	33728	10
	3"	33729	10
	3-1/2	33730	10
	4"	33731	10
	4-1/2	33732	10
	5"	33733	10
	5-1/2	33734	10
6"	33735	10	

Dia	Length	Part #	Qty
<b>1"</b> -8 USS Thread	2"	33737	10
	2-1/2	33738	10
	3"	33739	10
	3-1/2	33740	10
	4"	33741	10
	4-1/2	33742	10
	5"	33743	10
	5-1/2	33744	10
	6"	33745	10

6

# HEX HEAD CAP SCREWS

## 18-8 STAINLESS STEEL

SAE Fine Thread

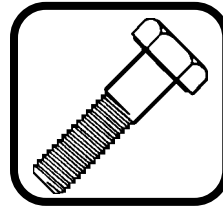

Dia	Length	Part #	Qty
<b>1/4</b> -28 SAE Thread	1/2	33750	50
	3/4	33751	50
	1"	33752	50
	1-1/4	33753	50
	1-1/2	33754	50
	2"	33755	50

Dia	Length	Part #	Qty
<b>5/16</b> -24 SAE Thread	1/2	33760	50
	3/4	33761	50
	1"	33762	50
	1-1/4	33763	50
	1-1/2	33764	25
	2"	33765	25

Dia	Length	Part #	Qty
<b>3/8</b> -24 SAE Thread	3/4	33770	50
	1"	33771	50
	1-1/4	33772	50
	1-1/2	33773	25
	2"	33774	25

# NUTS

## 18-8 STAINLESS STEEL

Finished Hex, Nylon Insert Lock, Machine Screw, Acorn, Wing & Kep



**Finished Hex Nuts**

Size	Part #	Qty
1/4-20	<b>33800</b>	100
1/4-28	<b>33810</b>	100
5/16-18	<b>33801</b>	100
5/16-24	<b>33811</b>	100
3/8-16	<b>33802</b>	100
3/8-24	<b>33812</b>	100
7/16-14	<b>33803</b>	50
7/16-20	<b>33813</b>	50
1/2-13	<b>33804</b>	50
1/2-20	<b>33814</b>	50
5/8-11	<b>33805</b>	25
5/8-18	<b>33815</b>	25
3/4-10	<b>33806</b>	25
3/4-16	<b>33816</b>	25
7/8-9	<b>33807</b>	10
7/8-14	<b>33817</b>	10
1"-8	<b>33808</b>	10
1"-14	<b>33818</b>	10

*SAE Sizes in Italics*

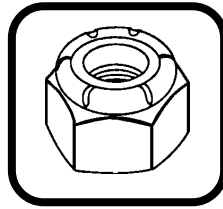

**Nylon Insert Lock Nuts**

Size	Part #	Qty
4-40	<b>33820</b>	100
6-32	<b>33821</b>	100
8-32	<b>33822</b>	100
10-24	<b>33823</b>	100
10-32	<b>33833</b>	100
1/4-20	<b>33824</b>	100
1/4-28	<b>33834</b>	50
5/16-18	<b>33825</b>	50
5/16-24	<b>33835</b>	50
3/8-16	<b>33826</b>	50
3/8-24	<b>33836</b>	25
7/16-14	<b>33827</b>	25
7/16-20	<b>33837</b>	25
1/2-13	<b>33828</b>	25
1/2-20	<b>33838</b>	10
5/8-11	<b>33829</b>	10
3/4-10	<b>33830</b>	10
7/8-9	<b>33831</b>	10
1"-8	<b>33832</b>	10

*SAE Sizes in Italics*

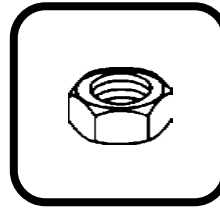

**Machine Screw Nuts**

Size	Part #	Qty
2-56	<b>33840</b>	100
4-40	<b>33841</b>	100
6-32	<b>33842</b>	100
8-32	<b>33843</b>	100
10-24	<b>33844</b>	100
10-32	<b>33845</b>	100
12-24	<b>33846</b>	100

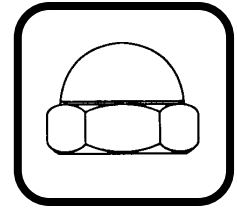

**Acorn Nuts**

Size	Part #	Qty
4-40	<b>33849</b>	100
6-32	<b>33850</b>	100
8-32	<b>33851</b>	100
10-24	<b>33852</b>	100
10-32	<b>33853</b>	100
1/4-20	<b>33854</b>	50
5/16-18	<b>33855</b>	25
3/8-16	<b>33856</b>	25
1/2-13	<b>33857</b>	25

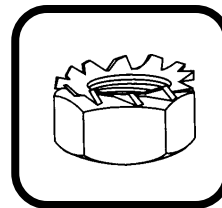

**Kep Nuts**

Size	Part #	Qty
4-40	<b>33866</b>	100
6-32	<b>33867</b>	100
8-32	<b>33868</b>	100
10-24	<b>33869</b>	100
10-32	<b>33870</b>	50
1/4-20	<b>33871</b>	50

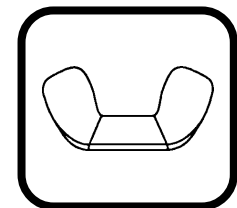

**Wing Nuts**

Size	Part #	Qty
6-32	<b>33858</b>	100
8-32	<b>33859</b>	100
10-24	<b>33860</b>	100
10-32	<b>33861</b>	100
1/4-20	<b>33862</b>	50
5/16-18	<b>33863</b>	25
3/8-16	<b>33864</b>	25
1/2-13	<b>33865</b>	10

Checkout our full line of **Stainless Steel** **FAS-KIT** Assortments



# WASHERS

## STAINLESS STEEL

Flat, Split Lock, External Star, Internal Star, Fender & Finishing

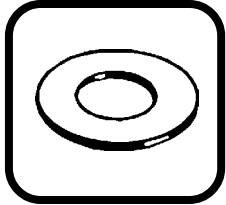

**Flat Washers**

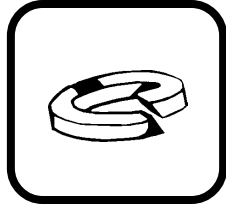

**Split Lock Washers**

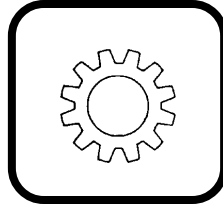

**External Star Washers**

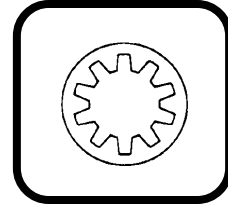

**Internal Star Washers**

**6**

Size	Part #	Qty
#0	33898	100
#1	33899	100
#2	33900	100
#3	33901	100
#4	33902	100
#5	33903	100
#6	33904	100
#8	33905	100
#10	33906	100
#12	33907	100
1/4	33908	100
5/16	33909	100
3/8	33910	50
7/16	33911	50
1/2	33912	50
5/8	33913	25
3/4	33914	25
7/8	33915	25
1"	33916	25

Size	Part #	Qty
#0	33918	100
#1	33919	100
#2	33920	100
#3	33921	100
#4	33922	100
#5	33923	100
#6	33924	100
#8	33925	100
#10	33926	100
#12	33927	100
1/4	33928	100
5/16	33929	100
3/8	33930	50
7/16	33931	50
1/2	33932	50
5/8	33933	25
3/4	33934	25
7/8	33935	25
1"	33936	25

Size	Part #	Qty
#4	33940	100
#6	33941	100
#8	33942	100
#10	33943	100
1/4	33944	100
5/16	33945	50
3/8	33946	50

Size	Part #	Qty
#4	33950	100
#6	33951	100
#8	33952	100
#10	33953	100
1/4	33954	100
5/16	33955	50
3/8	33956	50

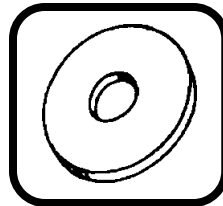

**Fender Washers**

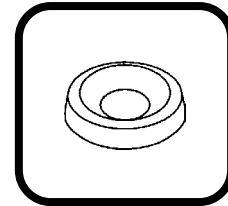

**Finishing Washers**

Size	Part #	Qty
3/16 x 1	33960	50
1/4 x 1	33961	50
1/4 x 1-1/4	33962	50
1/4 x 1-1/2	33963	50
5/16 x 1-1/2	33964	50
3/8 x 1-1/2	33965	50
1/2 x 2	33966	50

Size	Part #	Qty
#6	33970	100
#8	33971	100
#10	33972	100
#12	33973	50
1/4	33974	50

Checkout our full line of

**FAS-KIT**

**Stainless Steel Assortments**



# MACHINE SCREWS

18-8 STAINLESS STEEL

Slotted Round Head

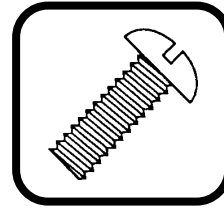

Dia	Length	Part #	Qty
<b># 4</b> - 40	1/4	<b>34000</b>	100
	3/8	<b>34001</b>	100
	1/2	<b>34002</b>	100
	5/8	<b>34003</b>	100
	3/4	<b>34004</b>	100
	1"	<b>34005</b>	100
	1-1/4	<b>34006</b>	100
1-1/2	<b>34007</b>	100	
<b># 6</b> - 32	1/4	<b>34010</b>	100
	3/8	<b>34011</b>	100
	1/2	<b>34012</b>	100
	5/8	<b>34013</b>	100
	3/4	<b>34014</b>	100
	1"	<b>34015</b>	100
	1-1/4	<b>34016</b>	100
1-1/2	<b>34017</b>	100	
2"	<b>34018</b>	50	
<b># 8</b> - 32	1/4	<b>34020</b>	100
	3/8	<b>34021</b>	100
	1/2	<b>34022</b>	100
	5/8	<b>34023</b>	100
	3/4	<b>34024</b>	100
	1"	<b>34025</b>	100
	1-1/4	<b>34026</b>	10
	1-1/2	<b>34027</b>	100
	2"	<b>34028</b>	50
2-1/2	<b>34029</b>	50	
3"	<b>34030</b>	50	
<b># 10</b> - 32	3/8	<b>34033</b>	100
	1/2	<b>34034</b>	100
	5/8	<b>34035</b>	100
	3/4	<b>34036</b>	100
	1"	<b>34037</b>	100
	1-1/4	<b>34038</b>	100
	1-1/2	<b>34039</b>	100
	1-3/4	<b>34040</b>	50
	2"	<b>34041</b>	50
	2-1/2	<b>34042</b>	50
3"	<b>34043</b>	50	

Dia	Length	Part #	Qty
<b># 10</b> - 24	3/8	<b>34045</b>	100
	1/2	<b>34046</b>	100
	5/8	<b>34047</b>	100
	3/4	<b>34048</b>	100
	1"	<b>34049</b>	100
	1-1/4	<b>34050</b>	100
	1-1/2	<b>34051</b>	100
	1-3/4	<b>34052</b>	50
	2"	<b>34053</b>	50
	2-1/2	<b>34054</b>	50
3"	<b>34055</b>	50	
<b># 12</b> - 24	1/2	<b>34058</b>	50
	3/4	<b>34059</b>	50
	1"	<b>34060</b>	50
	1-1/4	<b>34061</b>	50
	1-1/2	<b>34062</b>	25
	1-3/4	<b>34063</b>	25
2"	<b>34064</b>	25	
<b>1/4</b> - 20	1/2	<b>34067</b>	50
	5/8	<b>34068</b>	50
	3/4	<b>34069</b>	50
	1"	<b>34070</b>	50
	1-1/4	<b>34071</b>	50
	1-1/2	<b>34072</b>	25
	1-3/4	<b>34073</b>	25
	2"	<b>34074</b>	25
	2-1/2	<b>34075</b>	25
3"	<b>34076</b>	25	

# MACHINE SCREWS

18-8 STAINLESS STEEL

Slotted Flat Head

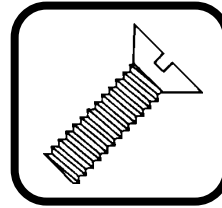

6

Dia	Length	Part #	Qty
<b># 4</b> - 40	1/4	34100	100
	3/8	34101	100
	1/2	34102	100
	5/8	34103	100
	3/4	34104	100
	1"	34105	100
	1-1/4	34106	100
<b># 6</b> - 32	1-1/2	34107	100
	1/4	34110	100
	3/8	34111	100
	1/2	34112	100
	5/8	34113	100
	3/4	34114	100
	1"	34115	100
	1-1/4	34116	100
<b># 8</b> - 32	1-1/2	34117	100
	2"	34118	50
	3/8	34120	100
	1/2	34121	100
	5/8	34122	100
	3/4	34123	100
	1"	34124	100
	1-1/4	34125	100
	1-1/2	34126	100
<b># 10</b> - 32	2"	34127	100
	2-1/2	34128	50
	3"	34129	50
	1/4	34130	50
	3/8	34133	100
	1/2	34134	100
	5/8	34135	100
<b># 10</b> - 32	3/4	34136	100
	1"	34137	100
	1-1/4	34138	100
	1-1/2	34139	100
	1-3/4	34140	50
	2"	34141	50
	2-1/2	34142	50
	3"	34143	50

Dia	Length	Part #	Qty
<b># 10</b> - 24	3/8	34145	100
	1/2	34146	100
	5/8	34147	100
	3/4	34148	100
	1"	34149	100
	1-1/4	34150	100
	1-1/2	34151	100
	1-3/4	34152	50
	2"	34153	50
	2-1/2	34154	50
<b># 12</b> - 24	3"	34155	50
	1/2	34158	50
	3/4	34159	50
	1"	34160	50
	1-1/4	34161	50
	1-1/2	34162	25
<b>1/4</b> - 20	1-3/4	34163	25
	2"	34164	25
	1/2	34167	50
	5/8	34168	50
	3/4	34169	50
	1"	34170	50
	1-1/4	34171	50
	1-1/2	34172	25
	1-3/4	34173	25
	2"	34174	25
2-1/2	34175	25	
3"	34176	25	

# MACHINE SCREWS

## 18-8 STAINLESS STEEL

Phillips Flat & Oval Head

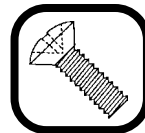
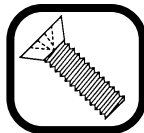

Phillips Flat Head

Dia	Length	Part #	Qty
<b># 4</b> - 40	1/4	34200	100
	3/8	34201	100
	1/2	34202	100
	5/8	34203	100
	3/4	34204	100
<b># 6</b> - 32	1/4	34207	100
	3/8	34208	100
	1/2	34209	100
	5/8	34210	100
	3/4	34211	100
	1"	34212	100
<b># 8</b> - 32	3/8	34215	100
	1/2	34216	100
	5/8	34217	100
	3/4	34218	100
	1"	34219	100
	1-1/4	34220	50
<b># 10</b> - 32	1-1/2	34221	50
	3/8	34224	100
	1/2	34225	100
	5/8	34226	100
	3/4	34227	100
<b># 10</b> - 24	1"	34228	100
	1-1/4	34229	50
	1-1/2	34230	50
	3/8	34233	100
	1/2	34234	100
	5/8	34235	100
<b>1/4</b> - 20	3/4	34236	100
	1"	34237	100
	1-1/4	34238	50
	1-1/2	34239	50
	1/2	34243	100
<b>1/4</b> - 20	5/8	34244	100
	3/4	34245	100
	1"	34246	100
	1-1/4	34247	50
	1-1/2	34248	50
	1-3/4	34249	50
	2"	34250	50

Phillips Oval Head

Dia	Length	Part #	Qty
<b># 4</b> - 40	1/4	34260	100
	3/8	34261	100
	1/2	34262	100
	5/8	34263	100
	3/4	34264	100
<b># 6</b> - 32	1/4	34268	100
	3/8	34269	100
	1/2	34270	100
	5/8	34271	100
	3/4	34272	100
<b># 8</b> - 32	1"	34273	100
	3/8	34277	100
	1/2	34278	100
	5/8	34279	100
	3/4	34280	100
	1"	34281	100
<b># 10</b> - 32	1-1/4	34282	50
	1-1/2	34283	50
	3/8	34286	100
	1/2	34287	100
	5/8	34288	100
<b># 10</b> - 24	3/4	34289	100
	1"	34290	100
	1-1/4	34291	50
	1-1/2	34292	50
	3/8	34295	100
	1/2	34296	100
<b>1/4</b> - 20	5/8	34297	100
	3/4	34298	100
	1"	34299	100
	1-1/4	34300	50
	1-1/2	34301	50
	1/2	34305	100
	5/8	34306	100
3/4	34307	100	
<b>1/4</b> - 20	1"	34308	100
	1-1/4	34309	50
	1-1/2	34310	50
	1-3/4	34311	50
	2"	34312	50

6

# MACHINE SCREWS

## 18-8 STAINLESS STEEL

Phillips Pan Head

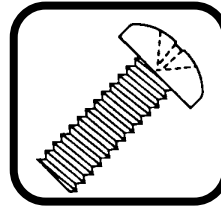

Dia	Length	Part #	Qty
<b># 4</b> -40	1/4	34330	100
	3/8	34331	100
	1/2	34332	100
	5/8	34333	100
	3/4	34334	100
	1"	34335	100
<b># 6</b> -32	1/4	34338	100
	3/8	34339	100
	1/2	34340	100
	5/8	34341	100
	3/4	34342	100
	1"	34343	100
	1-1/4	34344	100
	1-1/2	34345	100

Dia	Length	Part #	Qty
<b># 8</b> -32	1/4	34348	100
	3/8	34349	100
	1/2	34350	100
	5/8	34351	100
	3/4	34352	100
	1"	34353	100
	1-1/4	34354	100
	1-1/2	34355	100
<b># 10</b> -32	1/4	34358	100
	3/8	34359	100
	1/2	34360	100
	5/8	34361	100
	3/4	34362	100
	1"	34363	100
	1-1/4	34364	50
	1-1/2	34365	50
	2"	34366	50

Dia	Length	Part #	Qty
<b># 10</b> -24	1/4	34370	100
	3/8	34371	100
	1/2	34372	100
	5/8	34373	100
	3/4	34374	100
	1"	34375	100
	1-1/4	34376	50
	1-1/2	34377	50
	2"	34378	50
<b>1/4</b> -20	3/8	34381	100
	1/2	34382	100
	5/8	34383	100
	3/4	34384	100
	1"	34385	100
	1-1/4	34386	50
	1-1/2	34387	50
	2"	34388	50

6

# MACHINE SCREWS

## 18-8 STAINLESS STEEL

Phillips Truss Head

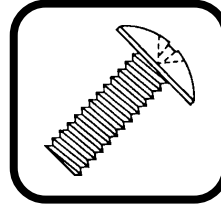

Dia	Length	Part #	Qty
<b># 6</b> -32	3/8	34400	100
	1/2	34401	100
	3/4	34402	100
	1"	34403	100
<b># 8</b> -32	3/8	34406	100
	1/2	34407	100
	3/4	34408	100
	1"	34409	100
<b># 10</b> -32	3/8	34412	100
	1/2	34413	100
	3/4	34414	100
	1"	34415	100
	1-1/4	34416	50
	1-1/2	34417	50

Dia	Length	Part #	Qty
<b># 10</b> -24	3/8	34420	100
	1/2	34421	100
	3/4	34422	100
	1"	34423	100
	1-1/4	34424	50
	1-1/2	34425	50
<b>1/4</b> -20	1/2	34429	100
	3/4	34430	100
	1"	34431	100
	1-1/4	34432	50
	1-1/2	34433	50
	2"	34434	50



# SHEET METAL SCREWS

18-8 STAINLESS STEEL

Slotted & Phillips Pan Head

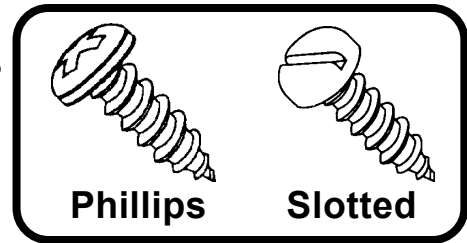

Dia	Length	Part #		Qty
		Slotted	Phillips	
<b># 4</b>	1/4	32450	34450	100
	3/8	32451	34451	100
	1/2	32452	34452	100
	5/8	—	34453	100
	3/4	—	34454	100
	1"	—	34455	100
<b># 6</b>	1/4	32458	34458	100
	3/8	32459	34459	100
	1/2	32460	34460	100
	5/8	32461	34461	100
	3/4	32462	34462	100
	1"	32463	34463	100
	1-1/4	—	34464	50
	1-1/2	—	34465	50
<b># 8</b>	3/8	32469	34469	100
	1/2	32470	34470	100
	5/8	32471	34471	100
	3/4	32472	34472	100
	1"	32473	34473	100
	1-1/4	32474	34474	50
	1-1/2	32475	34475	50
	2"	—	34476	50
<b># 10</b>	3/8	—	34479	100
	1/2	32480	34480	100
	5/8	32481	34481	100
	3/4	32482	34482	100

Dia	Length	Part #		Qty
		Slotted	Phillips	
<b># 10</b>	1"	32483	34483	100
	1-1/4	32484	34484	50
	1-1/2	32485	34485	50
	1-3/4	—	34486	50
	2"	—	34487	50
	2-1/2	—	34488	50
	3"	—	34489	50
<b># 12</b>	1/2	—	34491	100
	5/8	—	34492	100
	3/4	—	34493	100
	1"	—	34494	100
	1-1/4	—	34495	50
	1-1/2	—	34496	50
	2"	—	34497	50
	2-1/2	—	34498	50
	3"	—	34499	50
<b># 14</b>	1/2	—	34501	100
	5/8	—	34502	100
	3/4	32503	34503	100
	1"	32504	34504	50
	1-1/4	32505	34505	50
	1-1/2	32506	34506	50
	2"	—	34507	50
	2-1/2	—	34508	50
	3"	—	34509	50

6

# SHEET METAL SCREWS

## 18-8 STAINLESS STEEL

Phillips Flat & Oval Head



Phillips Oval Head

Dia	Length	Part #	Qty
<b># 4</b>	3/8	34515	100
	1/2	34516	100
	5/8	34517	100
	3/4	34518	100
	1"	34519	100
<b># 6</b>	3/8	34522	100
	1/2	34523	100
	5/8	34524	100
	3/4	34525	100
	1"	34526	100
	1-1/4	34527	50
	1-1/2	34528	50
<b># 8</b>	1/2	34531	100
	5/8	34532	100
	3/4	34533	100
	1"	34534	100
	1-1/4	34535	50
	1-1/2	34536	50
	2"	34537	50
<b># 10</b>	1/2	34540	100
	5/8	34541	100
	3/4	34542	100
	1"	34543	100
	1-1/4	34544	50
	1-1/2	34545	50
	2"	34546	50
<b># 12</b>	1/2	34549	100
	3/4	34550	100
	1"	34551	100
	1-1/4	34552	50
	1-1/2	34553	50
	2"	34554	50
<b># 14</b>	3/4	34557	100
	1"	34558	100
	1-1/4	34559	100
	1-1/2	34560	50
	2"	34561	50
	2-1/2	34562	50
	3"	34563	50



Phillips Flat Head

Dia	Length	Part #	Qty
<b># 4</b>	3/8	34570	100
	1/2	34571	100
	5/8	34572	100
	3/4	34573	100
<b># 6</b>	3/8	34576	100
	1/2	34577	100
	5/8	34578	100
	3/4	34579	100
	1"	34580	100
	1-1/4	34581	100
	1-1/2	34582	50
<b># 8</b>	1/2	34585	50
	5/8	34586	100
	3/4	34587	100
	1"	34588	100
	1-1/4	34589	100
	1-1/2	34590	50
	2"	34591	50
<b># 10</b>	1/2	34593	100
	5/8	34594	50
	3/4	34595	100
	1"	34596	100
	1-1/4	34597	100
	1-1/2	34598	100
	2"	34599	50
<b># 12</b>	1/2	34602	50
	3/4	34603	50
	1"	34604	100
	1-1/4	34605	50
	1-1/2	34606	50
	2"	34607	50
<b># 14</b>	3/4	34610	50
	1"	34611	50
	1-1/4	34612	50
	1-1/2	34613	50
	2"	34614	50

# SHEET METAL SCREWS

## 18-8 STAINLESS STEEL

Phillips Truss Head

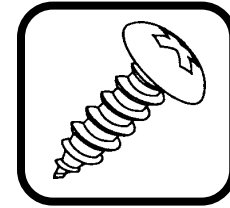

Dia	Length	Part #	Qty
<b># 6</b>	3/8	32401	100
	1/2	32402	100
	3/4	32404	100
<b># 8</b>	3/8	32409	100
	1/2	32410	100
	3/4	32412	100
	1	32413	100
<b># 10</b>	1/2	32418	100
	3/4	32420	100
	1"	32421	100
	1-1/4	32422	100
	1-1/2	32423	100

Dia	Length	Part #	Qty
<b># 12</b>	3/4	32427	100
	1"	32428	100
	1-1/4	32429	100
	1-1/2	32430	100
	3/4	32434	100
<b># 14</b>	1"	32435	100
	1-1/4	32436	100
	1-1/2	32437	100

6

# TEKS<sup>®</sup> SCREWS

## STAINLESS STEEL

Hex Washer Head

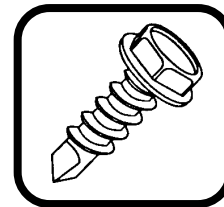

Dia	Length	Part #	Qty
<b># 6</b> 1/4 Hex Head	3/8	35150	100
	1/2	35151	100
	3/4	35152	100
	1	35153	100
<b># 8</b> 1/4 Hex Head	1/2	35155	100
	3/4	35156	100
	1	35157	100
	1-1/4	35158	100
<b># 10</b> 5/16 Hex Head	1-1/2	35159	100
	1/2	35161	100
	3/4	35163	100
<b># 12</b> 5/16 Hex Head	1"	35164	100
	1-1/4	35165	100
	1-1/2	35166	100
	1"	35173	100
<b># 14</b> 3/8 Hex Head	1"	35174	100
	1-1/4	35175	100
	1-1/2	35176	100
	2"	35177	100

Dia	Length	Part #	Qty
<b># 12</b> 5/16 Hex Head	3/4	35168	100
	1"	35169	100
	1-1/4	35170	100
	1-1/2	35171	100
	2"	35172	100
<b># 14</b> 3/8 Hex Head	3/4	35173	100
	1"	35174	100
	1-1/4	35175	100
	1-1/2	35176	100
	2"	35177	100

# SOCKET HEAD CAP SCREWS

18-8 STAINLESS STEEL

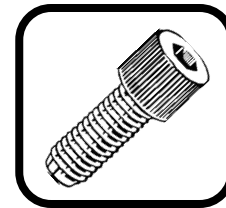

6

Dia	Length	Part #		Qty
		USS	SAE	
<b># 2</b> - 56 USS 5/64 Key	1/4	34630	—	00
	3/8	34631	—	100
	1/2	34632	—	100
<b># 4</b> -40 USS Thread 3/32 Key	1/4	34650	—	100
	3/8	34651	—	100
	1/2	34652	—	100
	5/8	34653	—	100
	3/4	34654	—	100
<b># 6</b> -32 USS Thread 7/64 Key	1/4	34657	—	100
	3/8	34658	—	100
	1/2	34659	—	100
	5/8	34660	—	100
	3/4	34661	—	100
	1"	34662	—	100
<b># 8</b> -32 USS Thread 9/64 Key	1/4	34665	—	100
	3/8	34666	—	100
	1/2	34667	—	100
	5/8	34668	—	100
	3/4	34669	—	100
	1"	34670	—	50
	1-1/4	34671	—	100
<b># 10</b> -24 USS -32 SAE Thread 5/32 Key	1-1/2	34672	—	100
	1/4	34675	34685	100
	3/8	34676	34686	100
	1/2	34677	34687	100
	5/8	34678	34688	100
	3/4	34679	34689	100
	1"	34680	34690	100
	1-1/4	34681	34691	50
	1-1/2	34682	34692	50
<b>1/4</b> -20 USS -28 SAE Thread 3/16 Key	2"	34683	34693	50
	1/2	34698	35501	100
	3/4	34699	35502	100
	1"	34700	35503	100
	1-1/4	34701	35504	50
	1-1/2	34702	35505	50
	1-3/4	34702A	35506	50
	2"	34703	35507	50

Dia	Length	Part #		Qty
		USS	SAE	
<b>1/4</b> -20 USS -28 SAE 3/16 Key	2-1/4	34703A	—	25
	2-1/2	34704	—	25
	3"	34704A	—	25
	3-1/2	34704B	—	25
	4"	34704C	—	25
<b>5/16</b> -18 USS -24 SAE 1/4 Key	1/2	34705	35510	50
	3/4	34706	35511	50
	1"	34707	35512	50
	1-1/4	34708	35513	50
	1-1/2	34709	35514	50
	1-3/4	—	35515	50
	2"	34710	35516	25
	2-1/4	34711	—	25
	2-1/2	34712	—	25
	3"	34712A	—	25
<b>3/8</b> -16 USS -24 SAE Thread 5/16 Key	3/4	34713	35519	25
	1"	34714	35520	25
	1-1/4	34715	35521	25
	1-1/2	34716	35522	25
	2"	34717	35523	25
	2-1/4	34718	—	25
	2-1/2	34718A	35524	25
	3"	34718B	35525	25
	3-1/2	34718C	—	25
	4"	34718D	—	25
<b>7/16</b> -14 USS Thread 3/8 Key	1"	34640	—	25
	1-1/4	34641	—	25
	1-1/2	34642	—	25
	2"	34643	—	25
	2-1/2	34644	—	25
<b>1/2</b> -13 USS Thread 3/8 Key	3"	34645	—	25
	1"	34720	—	25
	1-1/4	34721	—	25
	1-1/2	34722	—	25
	2"	34723	—	10
	2-1/2	34724	—	10
	3"	34725	—	10
	3-1/2	34726	—	10
	4"	34727	—	10

# SOCKET CAP SCREWS

## BUTTON HEAD & FLAT HEAD

18-8 Stainless Steel

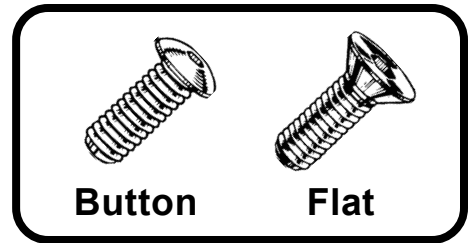

Dia	Length	Part #		Qty
		Button	Flat	
<b># 4</b> - 40 USS Thread 1/16 Key	1/4	34740	34800	100
	3/8	34741	34801	100
	1/2	34742	34802	100
	3/4	34743	—	100
<b># 6</b> -32 USS Thread 5/64 Key	1/4	34744	34805	100
	3/8	34745	34806	100
	1/2	34746	34807	100
	5/8	34747	34808	100
<b># 8</b> -32 USS Thread 3/32 Key	3/4	34748	34809	100
	1/4	34750	34811	100
	3/8	34751	34812	100
	1/2	34752	34813	100
<b># 10</b> -24 USS Thread 1/8 Key	5/8	34753	34814	100
	3/4	34754	34815	100
	1	34755	34816	100
	1/4	34756	—	100
<b># 10</b> -32 SAE Thread 1/8 Key	3/8	34757	34818	100
	1/2	34758	34819	100
	5/8	34759	34820	100
	3/4	34760	34821	100
<b># 10</b> -32 SAE Thread 1/8 Key	1/4	34763	—	100
	3/8	34764	34826	100
	1/2	34765	34827	100
	5/8	34766	34828	100
	3/4	34767	34829	100
	1	34768	34830	100
1-1/4	—	34831	100	

Dia	Length	Part #		Qty
		Button	Flat	
<b>1/4</b> -20 USS Thread 5/32 Key	1/2	34770	34832	100
	3/4	34771	34834	100
	1	34772	34835	100
	1-1/4	34773	34836	100
<b>5/16</b> -18 USS Thread 3/16 Key	1-1/2	34774	34837	100
	1/2	34778	34840	100
	3/4	34779	34841	100
	1	34780	34842	100
<b>3/8</b> -16 USS Thread 7/32 Key	1-1/4	34781	34843	100
	1-1/2	34782	34844	100
	3/4	34785	34846	100
	1	34786	34847	100
<b>1/2</b> - 13 USS Thread 5/16 Key	1-1/4	34787	34848	100
	1-1/2	34788	34849	100
	1	—	34852	100
	2	—	34855	100
		—	34854	100

6

# SOCKET SET SCREWS

18-8 STAINLESS STEEL

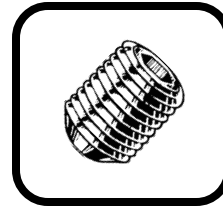

Dia	Length	Part #	Qty
<b># 4</b> - 40 USS Thread .050 Key	1/8	<b>34860</b>	100
	1/4	<b>34861</b>	100
	3/8	<b>34862</b>	100
	1/2	<b>34863</b>	100
<b># 6</b> - 32 USS Thread 1/16 Key	1/8	<b>34866</b>	100
	1/4	<b>34867</b>	100
	3/8	<b>34868</b>	100
	1/2	<b>34869</b>	100
<b># 8</b> - 32 USS Thread 5/64 Key	1/8	<b>34872</b>	100
	1/4	<b>34873</b>	100
	3/8	<b>34874</b>	100
	1/2	<b>34875</b>	100
<b># 10</b> - 24 USS Thread 3/32 Key	1/4	<b>34879</b>	100
	3/8	<b>34880</b>	100
	1/2	<b>34881</b>	100
	3/4	<b>34882</b>	100
<b># 10</b> - 32 USS Thread 3/32 Key	1"	<b>34883</b>	100
	1/4	<b>34886</b>	100
	3/8	<b>34887</b>	100
	1/2	<b>34888</b>	100
<b>1/4</b> - 20 USS Thread 1/8 Key	3/4	<b>34889</b>	100
	1"	<b>34890</b>	100
	1/4	<b>34893</b>	100
	3/8	<b>34894</b>	100
<b>5/16</b> - 18 USS Thread 5/32 Key	1/2	<b>34895</b>	100
	3/4	<b>34896</b>	50
	1"	<b>34897</b>	50
	3/8	<b>34900</b>	50
<b>3/8</b> - 16 USS Thread 3/16 Key	1/2	<b>34901</b>	50
	3/4	<b>34902</b>	50
	1"	<b>34903</b>	50
	3/8	<b>34906</b>	25
<b>3/8</b> - 16 USS Thread 3/16 Key	1/2	<b>34907</b>	25
	3/4	<b>34908</b>	25
	1"	<b>34909</b>	25

6

# COTTER PINS

18-8 STAINLESS STEEL

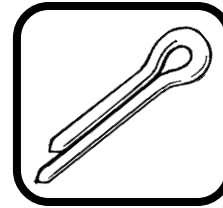

Dia	Length	Part #	Qty
<b>1/16</b>	1/2	<b>34920</b>	100
	3/4	<b>34921</b>	100
	1"	<b>34922</b>	100
	1-1/4	<b>34923</b>	100
	1-1/2	<b>34924</b>	100
<b>3/32</b>	1/2	<b>34927</b>	100
	3/4	<b>34928</b>	100
	1"	<b>34929</b>	100
	1-1/4	<b>34930</b>	50
	1-1/2	<b>34931</b>	50
	2"	<b>34932</b>	50
<b>1/8</b>	1"	<b>34935</b>	50
	1-1/4	<b>34936</b>	50
	1-1/2	<b>34937</b>	50
	1-3/4	<b>34938</b>	50
	2"	<b>34939</b>	50
	2-1/2	<b>34940</b>	25
	3"	<b>34941</b>	25
<b>5/32</b>	1"	<b>34944</b>	50
	1-1/4	<b>34945</b>	50
	1-1/2	<b>34946</b>	50
	1-3/4	<b>34947</b>	50
	2"	<b>34948</b>	50
	2-1/2	<b>34949</b>	2
	3"	<b>34950</b>	25
<b>3/16</b>	1-1/2	<b>34952</b>	25
	2"	<b>34953</b>	25
	2-1/2	<b>34954</b>	25
	3"	<b>34955</b>	25
<b>1/4</b>	1-1/2	<b>34957</b>	25
	2"	<b>34958</b>	25
	3"	<b>34959</b>	25
	4"	<b>34960</b>	25
<b>5/16</b>	2"	<b>34962</b>	10
	3"	<b>34963</b>	10
	4"	<b>34964</b>	10
<b>3/8</b>	3"	<b>34966</b>	10
	4"	<b>34967</b>	10

# BLIND RIVETS

## 18-8 STAINLESS STEEL

Domehead, Countersunk and Large Flange

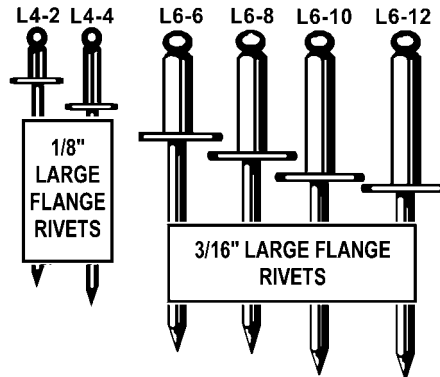
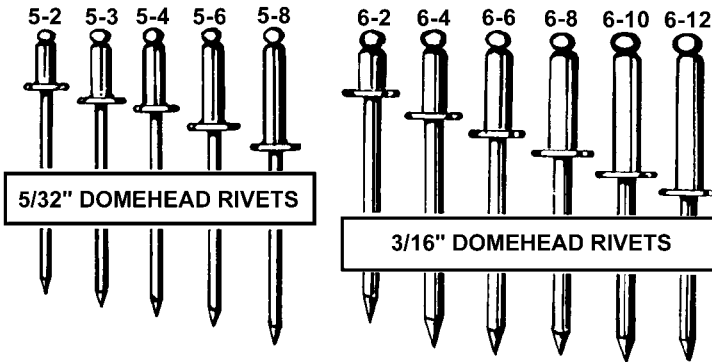
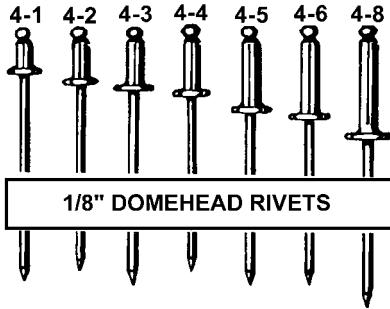

### DOMEHEAD

Dia	Rivet Code	Thickness of Material to Fasten	Stainless Steel Part #	Qty
<b>1/8</b>	4-1	up to 1/16	—	100
	4-2	up to 1/8	14351	100
	4-3	1/8 to 3/16	14352	100
	4-4	3/16 to 1/4	14353	100
	4-5	1/4 to 5/16	14354	100
	4-6	1/4 to 3/8	14355	100
	4-8	3/8 to 1/2	14356	100
<b>5/32</b>	5-2	up to 1/8	14357	100
	5-3	1/8 to 3/16	14358	100
	5-4	1/8 to 1/4	14359	100
	5-6	1/4 to 3/8	14360	100
	5-8	3/8 to 1/2	14361	100
<b>3/16</b>	6-2	up to 1/8	14362	50
	6-4	1/8 to 1/4	14363	50
	6-6	1/4 to 3/8	14364	50
	6-8	3/8 to 1/2	14365	50
	6-10	1/2 to 5/8	14366	50
	6-12	5/8 to 3/4	14367	50

### COUNTERSUNK

Dia	Rivet Code	Thickness of Material to Fasten	Stainless Steel Part #	Qty
<b>1/8</b>	C4-2	up to 1/8	14368	100
	C4-4	1/8 to 1/4	14370	100

### LARGE FLANGE

Dia	Rivet Code	Thickness of Material to Fasten	Stainless Steel Part #	Qty
<b>1/8</b>	L4-2	up to 1/8	14371	100
	L4-4	3/16 to 1/4	14372	100
<b>3/16</b>	L6-6	1/4 to 3/8	14373	50
	L6-8	3/8 to 1/2	14374	50
	L6-10	1/2 to 5/8	14375	50
	L6-12	5/8 to 3/4	14376	50



# CARRIAGE BOLTS

18-8 STAINLESS STEEL

USS Coarse Thread

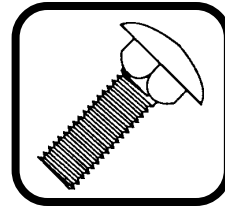

Dia	Length	Part #	Qty
<b>1/4</b> - 20 USS Thread	3/4	36101	25
	1"	36102	25
	1-1/4	36103	25
	1-1/2	36104	25
	2"	36105	25
	2-1/2	36106	25
	3"	36107	25
	3-1/2	36108	25
	4"	36110	25
	5"	36112	25

Dia	Length	Part #	Qty
<b>5/16</b> - 18 USS Thread	1"	36116	25
	1-1/4	36117	25
	1-1/2	36118	25
	2"	36119	25
	2-1/2	36121	25
	3"	36122	25
	4"	36124	25
	5"	36126	25

Dia	Length	Part #	Qty
<b>3/8</b> - 16 USS Thread	1"	36129	25
	1-1/4	36130	25
	1-1/2	36131	25
	2"	36132	25
	2-1/2	36133	25
	3"	36135	25
	4"	36137	25
	5"	36139	25
	6"	36141	25

**6**

# HEX LAG BOLTS

18-8 STAINLESS STEEL

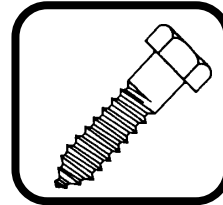

Dia	Length	Part #	Qty
<b>1/4</b>	1"	36150	25
	1-1/4	36151	25
	1-1/2	36152	25
	2"	36153	25
	2-1/2	36154	25
	3"	36155	25
	4"	36157	25
<b>5/16</b>	1-1/2	36160	25
	2"	36161	25
	2-1/2	36162	25
	3"	36163	25
	3-1/2	36164	25
4"	36165	25	

Dia	Length	Part #	Qty
<b>3/8</b>	1-1/2	36168	25
	2"	36169	25
	2-1/2	36170	25
	3"	36171	25
	3-1/2	36172	25
	4"	36173	25
	5"	36175	25
	6"	36177	25
<b>1/2</b>	2"	36180	25
	2-1/2	36181	25
	3"	36182	25
	4"	36184	25
	5"	36186	25
6"	36188	25	

# THREADED ROD

## 18-8 STAINLESS STEEL

Size	Part #		Qty
	3 feet	6 feet	
6-32	36200	36215	1
8-32	36201	36216	1
10-24	36202	36217	1
10-32	36203	36218	1
1/4-20	36204	36219	1
5/16-18	36205	36220	1
3/8-16	36206	36221	1
7/16-14	36207	36222	1
1/2-13	36208	36223	1
5/8-11	36209	36224	1
3/4-10	36210	36225	1
7/8-9	36211	36226	1
1"-8	36212	36227	1

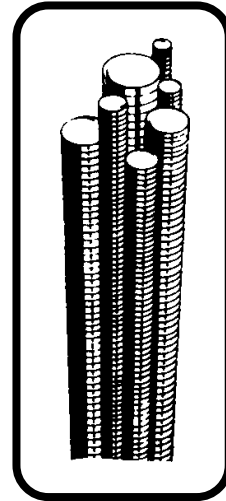

# METRIC CAP SCREWS

## 18-8 STAINLESS STEEL

Hex Head

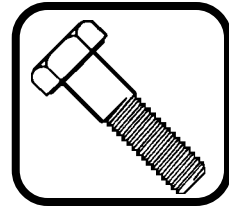

Dia	Length	Part #	Qty
<b>3 mm</b> - .50	6	70000	100
	8	70001	100
	10	70002	100
	12	70003	100
	16	70004	100
	20	70005	100
	25	70006	100
<b>4 mm</b> - .70	8	70010	100
	10	70011	100
	12	70012	100
	16	70013	100
	20	70014	100
	25	70015	100
<b>5 mm</b> - .80	30	70016	100
	8	70020	100
	10	70021	100
	12	70022	100
	16	70023	100
	20	70024	100
	25	70025	100
	30	70026	100
	35	70027	50
	40	70028	50
	45	70029	50
50	70030	50	
<b>6 mm</b> - 1.00	10	70035	100
	12	70036	100
	16	70037	100
	20	70038	100
	25	70039	100
	30	70040	100
	35	70041	50
	40	70042	50
	45	70043	50
	50	70044	50

Dia	Length	Part #	Qty
<b>8 mm</b> - 1.25	10	70050	50
	12	70051	50
	16	70052	50
	20	70053	50
	25	70054	50
	30	70055	50
	35	70056	50
	40	70057	50
	45	70058	50
<b>10 mm</b> - 1.50	50	70059	50
	16	70065	25
	20	70066	25
	25	70067	25
	30	70068	25
	35	70069	25
	40	70070	25
	45	70071	25
	50	70072	25
	60	70074	25
<b>12 mm</b> - 1.75	25	70080	25
	30	70081	25
	35	70082	25
	40	70083	25
	45	70084	25
	50	70085	25
	60	70087	25
	70	70089	25
80	70091	25	

6

# METRIC HEX NUTS

18-8 STAINLESS STEEL



Size(mm)	Part #	Qty
3 x .50	70201	100
4 x .70	70202	100
5 x .80	70203	100
6 x 1.00	70204	100
8 x 1.25	70206	100
10 x 1.50	70207	50
12 x 1.75	70208	50
14 x 2.00	70209	25
16 x 2.00	70210	25

# METRIC NYLON INSERT LOCKNUTS

18-8 STAINLESS STEEL



Size(mm)	Part #	Qty
5 x .80	70232	100
6 x 1.00	70233	100
8 x 1.25	70234	50
10 x 1.50	70235	25

# METRIC ACORN NUTS

18-8 STAINLESS STEEL

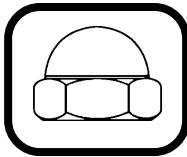

Size(mm)	Part #	Qty
5 x .80	70245	100
6 x 1.00	70246	100
8 x 1.25	70247	50
10 x 1.50	70248	25

# METRIC STAINLESS STEEL WASHERS

## FLAT WASHERS

Size(mm)	Part #	Pkg
2	70300	100
3	70301	100
4	70302	100
5	70303	100
6	70304	100
8	70305	100
10	70306	50
12	70307	50
14	70308	25
16	70309	25

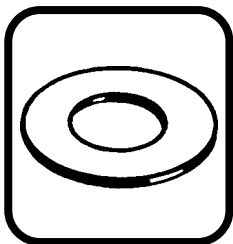

## LOCKWASHERS

Size(mm)	Part #	Pkg
2	70320	100
3	70321	100
4	70322	100
5	70323	100
6	70324	100
8	70325	100
10	70326	50
12	70327	50
14	70328	25
16	70329	25

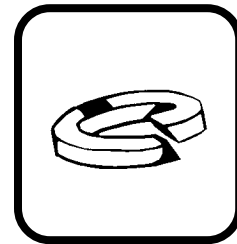

# METRIC SOCKET HEAD CAP SCREWS

18-8 STAINLESS STEEL

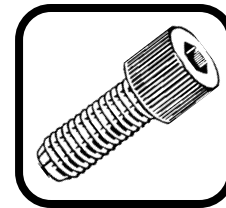

Dia	Length	Part #	Qty
<b>3 mm</b> - .50 2.5mm Key	6	<b>62197</b>	100
	8	<b>62198</b>	100
	10	<b>62199</b>	100
	12	<b>62200</b>	100
	14	<b>62200A</b>	100
	16	<b>62201</b>	100
	20	<b>62201A</b>	100
	25	<b>62201B</b>	100
<b>4 mm</b> - .70 3.0mm Key	6	<b>62202</b>	100
	8	<b>62203</b>	100
	10	<b>62204</b>	100
	12	<b>62205</b>	100
	16	<b>62206</b>	100
	20	<b>62207</b>	100
	25	<b>62208</b>	100
	30	<b>62209</b>	100
<b>5 mm</b> - .80 4.0mm Key	8	<b>62210</b>	100
	10	<b>62211</b>	100
	12	<b>62212</b>	100
	16	<b>62213</b>	100
	20	<b>62214</b>	100
	25	<b>62215</b>	100
	30	<b>62216</b>	100
	35	<b>62217</b>	100
	40	<b>62218</b>	100
	50	<b>62218B</b>	100
<b>6 mm</b> - 1.00 5.0mm Key	10	<b>62219</b>	100
	12	<b>62220</b>	100
	16	<b>62221</b>	100
	20	<b>62222</b>	100
	25	<b>62223</b>	100
	30	<b>62224</b>	100
	35	<b>62225</b>	100
	40	<b>62226</b>	100
	50	<b>62227</b>	100
	60	<b>62228</b>	100

Dia	Length	Part #	Qty
<b>8 mm</b> - 1.25 6.0mm Key	16	<b>62229</b>	100
	20	<b>62230</b>	100
	25	<b>62231</b>	100
	30	<b>62232</b>	100
	35	<b>62233</b>	100
	40	<b>62234</b>	100
	45	<b>62235</b>	100
	50	<b>62236</b>	100
	55	<b>62237</b>	50
	60	<b>62238</b>	50
	65	<b>62238A</b>	50
	70	<b>62238B</b>	25
	75	<b>62238C</b>	25
<b>10 mm</b> - 1.50 8.0mm Key	20	<b>62239</b>	50
	25	<b>62240</b>	50
	30	<b>62241</b>	50
	35	<b>62242</b>	50
	40	<b>62243</b>	50
	45	<b>62244</b>	50
	50	<b>62245</b>	50
	55	<b>62246</b>	25
	60	<b>62247</b>	25
	70	<b>62248</b>	25
	80	<b>62249</b>	25
<b>12 mm</b> - 1.75 10.0mm Key	20	<b>62250</b>	50
	25	<b>62251</b>	50
	30	<b>62252</b>	50
	35	<b>62253</b>	50
	40	<b>62254</b>	50
	45	<b>62255</b>	25
	50	<b>62256</b>	25
	55	<b>62257</b>	25
	60	<b>62258</b>	25
	70	<b>62259</b>	10
	80	<b>62260</b>	10
90	<b>62261</b>	10	
100	<b>62262</b>	10	

**6**

# METRIC FLAT HEAD SOCKET CAP SCREWS

18-8 STAINLESS STEEL



Dia	Length	Part #	Qty
<b>3 mm</b>	6	35200	100
	8	35201	100
	10	35202	100
	- .50	35203	100
	2.0mm Key	35204	100
<b>4 mm</b>	20	35205	100
	25	35206	100
	8	35210	100
	10	35211	100
	- .70	35212	100
<b>2.5mm Key</b>	16	35213	100
	20	35214	100
	25	35215	100

Dia	Length	Part #	Qty
<b>5 mm</b>	10	35222	100
	12	35223	100
	16	35224	100
	- .80	35225	100
	3.0mm Key	35226	100
	30	35227	100
	35	35228	100
	40	35229	100
<b>6 mm</b>	10	35235	100
	12	35236	100
	16	35237	100
	20	35238	100
	- 1.00	35239	100
	4.0mm Key	35240	100
	35	35241	100
	40	35242	100
	45	35243	100
	50	35244	100

Dia	Length	Part #	Qty
<b>8 mm</b>	12	35248	100
	16	35249	100
	20	35250	100
	- 1.25	35251	100
	5.0mm Key	35252	100
	35	35253	100
	40	35254	100
<b>10 mm</b>	45	35255	100
	20	35260	50
	25	35261	50
	- 1.50	35262	50
	6.0mm Key	35263	50
	40	35264	50

# METRIC BUTTON HEAD SOCKET CAP SCREWS

18-8 STAINLESS STEEL

Dia	Length	Part #	Qty
<b>3 mm</b>	6	35320	100
	8	35321	100
	- .50	35322	100
	2.0mm Key	35323	100
	16	35324	100
<b>4 mm</b>	6	35328	100
	8	35329	100
	- .70	35330	100
	2.5mm Key	35331	100
	16	35332	100
<b>5 mm</b>	10	35337	100
	12	35338	100
	- .80	35339	100
	3.0mm Key	35340	100
	25	35341	100



Dia	Length	Part #	Qty
<b>6 mm</b>	10	35345	100
	12	35346	100
	- 1.00	35347	100
	4.0mm Key	35348	100
	25	35349	100
<b>8 mm</b>	30	35350	100
	12	35355	100
	16	35356	100
	- 1.25	35357	100
	5.0mm Key	35358	100
30	35359	100	

# METRIC SOCKET SET SCREWS - CUP POINT

## 18-8 STAINLESS STEEL

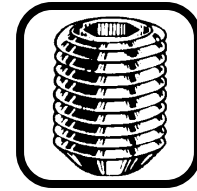

Dia	Length	Part #	Qty
<b>3 mm</b> - .50 1.5mm Key	3	<b>62320</b>	100
	4	<b>62321</b>	100
	5	<b>62322</b>	100
	6	<b>62323</b>	100
	8	<b>62324</b>	100
	10	<b>62325</b>	100
	12	<b>62326</b>	100
<b>4 mm</b> - .70 2.0mm Key	4	<b>62327</b>	100
	5	<b>62328</b>	100
	6	<b>62329</b>	100
	8	<b>62330</b>	100
	10	<b>62331</b>	100
	12	<b>62332</b>	100
	16	<b>62333</b>	100
<b>5 mm</b> - .80 2.5mm Key	5	<b>62334</b>	100
	6	<b>62335</b>	100
	8	<b>62336</b>	100
	10	<b>62337</b>	100
	12	<b>62338</b>	100
	16	<b>62339</b>	100
	20	<b>62340</b>	100
<b>6 mm</b> - 1.00 3.0mm Key	6	<b>62341</b>	100
	8	<b>62342</b>	100
	10	<b>62343</b>	100
	12	<b>62344</b>	100
	16	<b>62345</b>	100
	20	<b>62346</b>	100
	25	<b>62347</b>	100

Dia	Length	Part #	Qty
<b>8 mm</b> - 1.25 4.0mm Key	8	<b>62348</b>	100
	10	<b>62349</b>	100
	12	<b>62350</b>	100
	16	<b>62351</b>	100
	20	<b>62352</b>	100
	25	<b>62353</b>	100
	30	<b>62354</b>	100
	35	<b>62354A</b>	100
<b>10 mm</b> - 1.50 5.0mm Key	10	<b>62355</b>	50
	12	<b>62356</b>	50
	16	<b>62357</b>	50
	20	<b>62358</b>	50
	25	<b>62359</b>	50
	30	<b>62360</b>	50
	35	<b>62361</b>	50
	40	<b>62362</b>	50
<b>12 mm</b> - 1.75 6.0mm Key	12	<b>62363</b>	50
	16	<b>62364</b>	50
	20	<b>62365</b>	50
	25	<b>62366</b>	50
	30	<b>62367</b>	50
	35	<b>62368</b>	50
	40	<b>62369</b>	50

**6**

# METRIC MACHINE SCREWS

## 18-8 STAINLESS STEEL

Phillips Pan Head

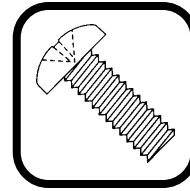

Dia	Length	Part #	Qty
<b>3 mm</b> - .50	6	<b>62100</b>	100
	8	<b>62101</b>	100
	10	<b>62102</b>	100
	12	<b>62103</b>	100
	16	<b>62104</b>	100
	20	<b>62105</b>	100
	25	<b>62106</b>	100
<b>4 mm</b> - .70	8	<b>62110</b>	100
	10	<b>62111</b>	100
	12	<b>62112</b>	100
	16	<b>62113</b>	100
	20	<b>62114</b>	100
	25	<b>62115</b>	100

Dia	Length	Part #	Qty
<b>5 mm</b> - .80	10	<b>62120</b>	100
	12	<b>62121</b>	100
	16	<b>62122</b>	100
	20	<b>62123</b>	100
	25	<b>62124</b>	100
<b>6 mm</b> - 1.00	12	<b>62130</b>	100
	16	<b>62131</b>	100
	20	<b>62132</b>	100
	25	<b>62133</b>	100
	30	<b>62134</b>	100
	35	<b>62135</b>	100
	40	<b>62136</b>	100
	45	<b>62137</b>	100

6

# METRIC MACHINE SCREWS

## 18-8 STAINLESS STEEL

Phillips Flat Head

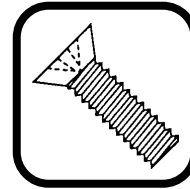

Dia	Length	Part #	Qty
<b>2 mm</b> - .40	6	<b>62050</b>	100
	8	<b>62051</b>	100
	10	<b>62052</b>	100
	12	<b>62053</b>	100
	16	<b>62054</b>	100
<b>3 mm</b> - .50	8	<b>62058</b>	100
	10	<b>62059</b>	100
	12	<b>62060</b>	100
	16	<b>62061</b>	100
<b>4 mm</b> - .70	10	<b>62066</b>	100
	12	<b>62067</b>	100
	16	<b>62068</b>	100
	20	<b>62069</b>	100
	25	<b>62070</b>	100

Dia	Length	Part #	Qty
<b>5 mm</b> - .80	10	<b>62075</b>	100
	12	<b>62076</b>	100
	16	<b>62077</b>	100
	20	<b>62078</b>	100
	25	<b>62079</b>	100
<b>6 mm</b> - 1.00	12	<b>62084</b>	100
	16	<b>62085</b>	100
	20	<b>62086</b>	100
	25	<b>62087</b>	100





# STAINLESS **FAS-KIT**<sup>®</sup> ASSORTMENTS



Plastic Box Assortments		
Part Number	Description	Number of Pieces
FK06000	Stainless Hex Head Cap Screws - With Nuts & Washers	252
FK06100	Stainless SI Round Head Mach Screws - With Nuts	490
FK06150	Stainless Ph Pan Head Mach Screws - With Nuts	596
FK06170	Stainless Ph Flat Head Mach Screws - With Nuts	596
FK06200	Stainless Ph Pan Head Sheet Metal Screws	295
FK06300	Stainless Ph Oval Head Sheet Metal Screws	305
FK06320	Stainless Hex Washer Head Self Drilling Screws	255
FK06325	Stainless Square Drive Deck Screws	280
FK06350	Stainless Socket Head Cap Screws	400
FK06353	Stainless Flat Socket Head Cap Screws	400
FK06356	Stainless Button Head Cap Screws	400
FK06359	Stainless Socket Set Screws	550
FK06400	Stainless Cotter Pins	116
FK06500	Stainless Metric Hex Cap Screws - With Nuts & Washers	280
FK06550	Stainless Metric Ph Pan Head Mach Screws - With Nuts	275
FK06600	Stainless Metric Socket Head Cap Screws	187

Metal Tray Assortments			
Small Drawer	Large Drawer	Description	Number of Pieces
-	FK57400	Stainless Hex Head Cap Screws	345
FK17450	FK57450	Stainless Hex Nuts, Flat Washers & Lock Washers	1000
FK17500	FK57500	Stainless Machine Screw Nuts & Washers	1900
FK17550	FK57550	Stainless Wing Nuts	155
FK17600	FK57600	Stainless Acorn Nuts	175
FK17650	FK57650	Stainless Fender Washers	300
FK17700	FK57700	Stainless Nylon Insert Lock Nuts	395
FK17750	FK57750	Stainless SI Round Head Mach Screws	1415
FK17755	FK57755	Stainless SI Flat Head Mach Screws	1465
FK17760	FK57760	Stainless Ph Flat Head Mach Screws	1040
FK17770	FK57770	Stainless Ph Pan Head Mach Screws - With Nuts	1595
FK17775	FK57775	Stainless Ph Truss Head Mach Screws - With Nuts	590
FK17780	FK57780	Stainless Hex Washer Head Self Drilling Screws	703
FK17790	FK57790	Stainless Square Drive Decking Screws	7
FK17800	FK57800	Stainless Phillips Pan Head Sheet Metal Screws	1165
FK17850	FK57850	Stainless Phillips Oval Head Sheet Metal Screws	905
FK17870	FK57870	Stainless Phillips Flat Head Sheet Metal Screws	655
FK11820	FK51820	Stainless Tamper Resistant Screws	579
FK17880	FK57880	Stainless Carriage Bolts - With Nuts	325
FK17890	FK57890	Stainless Hex Lag Bolts	200



# STAINLESS **FAS-KIT**<sup>®</sup> ASSORTMENTS



## Metal Tray Assortments - cont'd

Small Drawer	Large Drawer	Description	Number of Pieces
FK17900	FK57900	Stainless Socket Head Cap Screws	655
FK17950	FK57950	Stainless Flat Socket Head Cap Screws	700
FK18000	FK58000	Stainless Button Head Cap Screws	965
FK18050	FK58050	Stainless Socket Set Screws	1205
FK18100	FK58100	Stainless Cotter Pins	535
FK14930	FK54930	Stainless Blind Rivets	700
-	FK58150	Stainless Metric Hex Cap Screws - With Nuts & Washers	655
FK18160	FK58160	Stainless Metric Socket Head Cap Screws	380
FK18165	FK58165	Stainless Metric Flat Socket Head Cap Screws	390
FK18170	FK58170	Stainless Metric Socket Set Screws	385
FK18180	FK58180	Stainless Metric Ph Pan Head Mach Screws With Nuts	750

## 40 Hole Bin Assortments

Part Number	Description	Number of Pieces
FK90090	Stainless Hex Head Cap Screws - With Nuts & Washers	2150

6

# Section 7: Brass Fasteners

## Table of Contents

### Nuts

Finished Hex Nuts .....	3
Machine Screw Nuts .....	3
Acorn Nuts .....	3
Wing Nuts .....	3

### Washers

Flat Washers .....	3
Split Lock Washers .....	3
Finishing Washers .....	3

### Wood Screws

Slotted Round Head .....	4-5
Slotted Flat Head .....	4-5
Phillips Flat Head .....	4-5

### Machine Screws

Slotted Round Head .....	6
Slotted Flat Head .....	6

<b>Brass Faskit Assortments .....</b>	<b>7</b>
---------------------------------------	----------



# NUTS & WASHERS

## BRASS



**Finished  
Hex Nuts**

Size	Part #	Qty
1/4-20	33200	100
1/4-28	33210	100
5/16-18	33201	100
5/16-24	33211	100
3/8-16	33202	100
3/8-24	33212	100
7/16-14	33203	50
7/16-20	33213	50
1/2-13	33204	50
1/2-20	33214	50

*SAE Sizes in Italics*

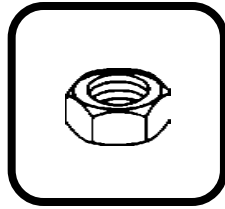

**Machine Screw  
Nuts**

Size	Part #	Qty
2-56	33275X	100
4-40	33276	100
6-32	33277	100
8-32	33278	100
10-32	33279	100
10-24	33280	100
12-24	33281	100

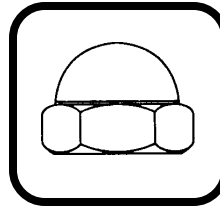

**Acorn  
Nuts**

Size	Part #	Qty
6-32	33290	100
8-32	33291	100
10-24	33292	100
10-32	33293	100
1/4-20	33294	50
5/16-18	33295	25
3/8-16	33296	25
1/2-13	33297	10

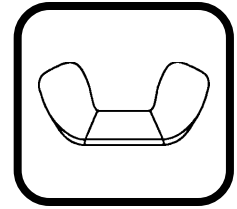

**Wing Nuts**

Size	Part #	Qty
6-32	33300	100
8-32	33301	100
10-24	33302	100
10-32	33303	100
1/4-20	33304	50
5/16-18	33305	25
3/8-16	33306	25
1/2-13	33307	10

**7**

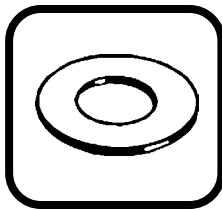

**Flat  
Washers**

Size	Part #	Qty
#2	11966	100
#4	11967	100
#6	11968	100
#8	11969	100
#10	11970	100
1/4	11972	100
5/16	39773	50
3/8	39774	50
1/2	39775	25
5/8	39776	25
3/4	39777	10

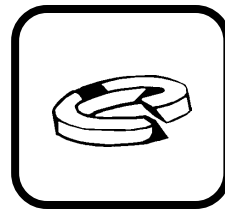

**Silicon Bronze  
Split Lock Washers**

Size	Part #	Qty
#2	33320	100
#4	33321	100
#6	33322	100
#8	33323	100
#10	33324	100
1/4	33325	100
5/16	33326	50
3/8	33327	50
1/2	33328	25
5/8	33329	25
3/4	33330	10

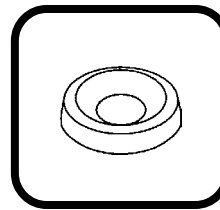

**Finishing  
Washers**

Size	Part #	Qty
#4	33340	100
#6	33341	100
#8	33342	100
#10	33343	100
#12	33344	100
1/4	33345	100

**Checkout our  
full line of  
Brass**

**FAS-KIT**

**Assortments**



# WOOD SCREWS

## BRASS

Round Head & Flat Head

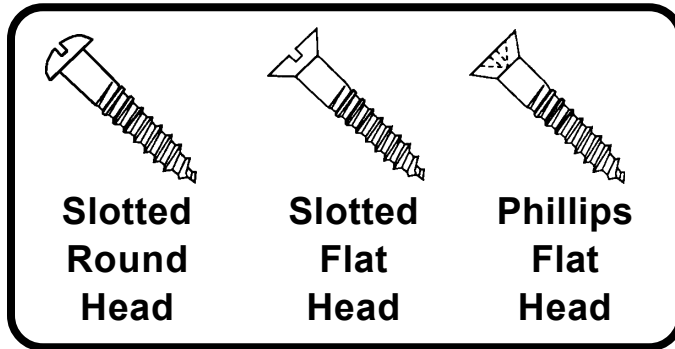

Dia	Length	Slotted Round Head	Slotted Flat Head	Phillips Flat Head	Qty
# 4	1/2	11898	06129	06401	100
	3/4	11899	06130	06403	100
	1	11900	06131	06404	100
# 5	1/2	33385	33375	06405	100
	5/8	33386	33376	06406	100
	3/4	33387	33377	06407	100
	1	33388	33378	06408	100
# 6	1/2	11900X	06132	06409	100
	5/8	11901	06132A	06410	100
	3/4	11902	06133	06411	100
	1	11903	06134	06412	100
	1-1/4	11904	06135	06413	100
	1-1/2	11904A	06135A	06414	100
# 7	3/1	—	33381	—	100
	1	—	33382	—	100
# 8	1/2	11905	06136	06416	100
	5/8	11905A	06136A	06417	100
	3/4	11906	06137	06418	100
	1	11907	06138	06419	100
	1-1/4	11908	06139	06420	100
	1-1/2	11909	06140	06421	100
	1-3/4	11910	06141	06421A	100
	2	11910A	06141A	06422	100

# WOOD SCREWS

## BRASS

Round Head & Flat Head

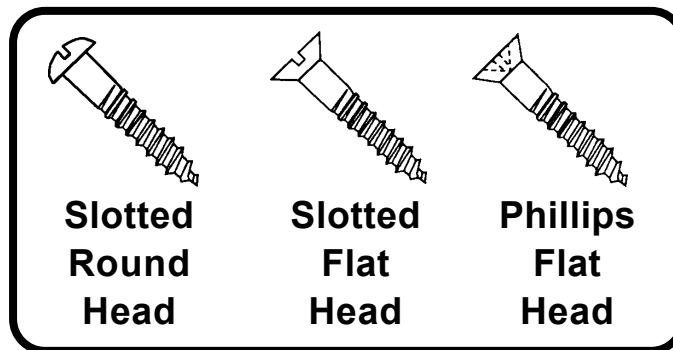

Dia	Length	Slotted Round Head	Slotted Flat Head	Phillips Flat Head	Qty
<b># 10</b>	3/4	11911	06142	06425	100
	1	11912	06143	06426	100
	1-1/4	11913	06144	06427	100
	1-1/2	11914	06145	06428	100
	1-3/4	11915	06146	06428A	100
	2	11916	06147	06429	100
	2-1/2	11916A	06147A	06430	100
	3	11916B	06147B	06431	100
<b># 12</b>	3/4	—	06148	06431X	100
	1	11918	06149	06432	100
	1-1/4	11919	06150	06433	100
	1-1/2	11920	06151	06434	100
	1-3/4	—	06152	06434A	100
	2	11922	06153	06435	100
	2-1/2	11923	06154	06436	100
<b># 14</b>	1	11924	06155	06438	100
	1-1/4	11925	06156	06439	100
	1-1/2	11926	06157	06440	100
	1-3/4	—	06158	06440A	100
	2	11928	06159	06441	100
	2-1/2	11929	06160	06442	100
3	—	—	06443	100	

# MACHINE SCREWS

## BRASS

Round Head & Flat Head

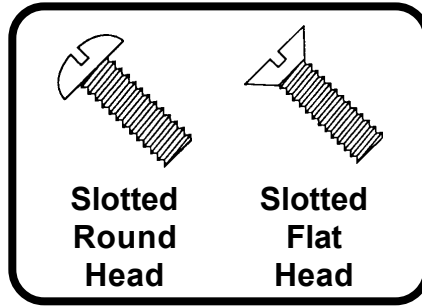

**7**

Dia	Length	Slotted Round Head	Slotted Flat Head	Qty
<b># 4</b> -40	1/4	13870	13859	100
	3/8	13871	13860	100
	1/2	33245	33217	100
	5/8	33245A	—	100
	3/4	33246	33218	100
	1	33247	33219	100
<b># 6</b> -32	1/4	13861	13850	100
	3/8	33248	13851	100
	1/2	33249	33220	100
	5/8	33249A	33220A	100
	3/4	33250	33221	100
	1	33251	33222	100
	1-1/4	33251A	33222A	100
	1-1/2	33252	33223	100
2	33252A	33223A	100	
<b># 8</b> -32	1/4	13863	13852	100
	3/8	13864	13853	100
	1/2	33253	33224	100
	5/8	33253A	33224A	100
	3/4	33254	33225	100
	1	33255	33226	100
	1-1/4	33255A	33226A	100
	1-1/2	33256	33227	100
	2	33257	33228	100

Dia	Length	Slotted Round Head	Slotted Flat Head	Qty
<b># 10</b> -32	1/4	13865	13854	100
	3/8	13866	13855	100
	1/2	33258	33229	100
	3/4	33259	33230	100
	1	33260	33231	100
	1-1/4	33261	33231A	100
	1-1/2	33262	33232	100
2	33263	33233	100	
<b># 10</b> -24	1/4	13867	13856	100
	3/8	13868	13857	100
	1/2	33264	33234	100
	3/4	33265	33235	100
	1	33266	33236	100
	1-1/4	33267	33236A	100
	1-1/2	33268	33237	100
	2	33269	33238	100
<b># 12</b> -24	1/2	33450	33460	100
	3/4	33451	33461	100
	1	33452	33462	100
	1-1/2	33454	33464	100
	2	33455	33465	100
<b>1/4</b> -20	3/8	13869	—	100
	1/2	33270	33239	100
	3/4	33271	33240	100
	1	33272	33241	100
	1-1/4	33273	33242	100
	1-1/2	33274	33243	100
	2	33275	33244	100





# BRASS **FAS-KIT**<sup>®</sup> ASSORTMENTS



<b>Plastic Box Assortments</b>		
Part Number	Description	Number of Pieces
FK01750	Brass & Nickel Plated Finishing Washers	300

<b>Metal Tray Assortments</b>			
Small Drawer	Large Drawer	Description	Number of Pieces
FK17320	FK57320	Brass Slotted Round Head Wood Screws	635
FK17340	FK57340	Brass Slotted Flat Head Wood Screws	635
FK17350	FK57350	Brass Phillips Flat Head Wood Screws	635
FK17360	FK57360	Brass Slotted Round Head Machine Screws	1185



# Section 8: Metric

## Table of Contents

### Hex Head Cap Screws

Coarse .....	3-5
Fine & Extra Fine .....	6

### Nuts

Hex Nuts .....	7
Nylon Insert Lock Nuts .....	7
Wing Nuts .....	8
Keps Nuts .....	8
Left Hand Hex Nuts .....	8

### Washers

Flat Washers .....	9
Lock Washers .....	9
External Star Washers .....	9
Internal Star Washers .....	9
Spring Washers .....	10
Copper Washers .....	10

### Socket Cap Screws

Socket Head .....	11
Flat Head .....	12
Button Head .....	12
Socket Set Screws, <i>Cup Point</i> .....	13

### Machine Screws

Slotted Pan Head .....	14
Phillips Pan Head .....	15
Phillips Oval and Flat Head .....	16

### Bolts

Studs .....	17
Threaded Rods .....	17

### Pins & Rings

Cotter Pins .....	18
Retaining Rings, <i>Internal</i> .....	19
Retaining Rings, <i>External</i> .....	19
Retaining Rings, <i>E-Ring Circlips</i> .....	20
Grease Fittings .....	21

Faskit Assortments .....	22
--------------------------	----





# METRIC HEX CAP SCREWS

## COARSE THREAD

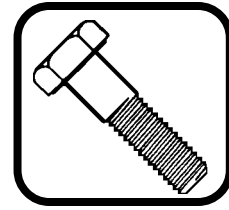

Dia	Length	Part #	Qty
<b>3</b> mm -.50	10	<b>33090</b>	100
	12	<b>33091</b>	100
	16	<b>33092</b>	100
	20	<b>33093</b>	100
	25	<b>33094</b>	100
	30	<b>33095</b>	100
<b>4</b> mm -.70	8	<b>33106</b>	100
	10	<b>33107</b>	100
	12	<b>33108</b>	100
	16	<b>33109</b>	100
	18	<b>33110</b>	100
	20	<b>33111</b>	100
	22	<b>33112</b>	100
	25	<b>33113</b>	100
	30	<b>33114</b>	100
	35	<b>33114A</b>	100
40	<b>33114B</b>	100	
45	<b>33114C</b>	100	
50	<b>33114D</b>	100	
<b>5</b> mm -.80	10	<b>33115</b>	100
	12	<b>33116</b>	100
	16	<b>33117</b>	100
	18	<b>33118</b>	100
	20	<b>33119</b>	100
	22	<b>33120</b>	100
	25	<b>33121</b>	100
	30	<b>33122</b>	100
	35	<b>66001</b>	50
	40	<b>66002</b>	50
	45	<b>66003</b>	50
	50	<b>66004</b>	50
60	<b>66005</b>	25	
70	<b>66006</b>	25	
<b>6</b> mm -1.00	10	<b>14640</b>	100
	12	<b>14641</b>	100
	16	<b>14642</b>	100
	20	<b>14643</b>	100
	22	<b>14644</b>	100

Dia	Length	Part #	Qty
<b>6</b> mm -1.00	25	<b>14645</b>	100
	30	<b>14646</b>	100
	35	<b>14647</b>	50
	40	<b>14648</b>	50
	45	<b>14649</b>	50
	50	<b>14650</b>	50
	60	<b>66007</b>	25
	70	<b>66008</b>	25
	80	<b>66009</b>	25
	90	<b>66010</b>	25
	100	<b>66011</b>	25
<b>7</b> mm -1.00	12	<b>14651</b>	50
	16	<b>14652</b>	50
	20	<b>14653</b>	50
	25	<b>14655</b>	50
	30	<b>14656</b>	50
	35	<b>14657</b>	50
	40	<b>14658</b>	50
	45	<b>14659</b>	50
	50	<b>14660</b>	50
<b>8</b> mm -1.25	12	<b>14661</b>	50
	16	<b>14662</b>	50
	20	<b>14663</b>	50
	22	<b>14664</b>	50
	25	<b>14665</b>	50
	30	<b>14666</b>	50
	35	<b>14667</b>	50
	40	<b>14668</b>	50
	45	<b>14669</b>	50
	50	<b>14670</b>	50
	55	<b>66012</b>	25
	60	<b>66013</b>	25
	70	<b>66014</b>	25
	75	<b>66015</b>	25
	80	<b>66016</b>	25
90	<b>66017</b>	25	
100	<b>66018</b>	25	
110	<b>66018A</b>	25	
120	<b>66018B</b>	25	

# METRIC HEX CAP SCREWS

## COARSE THREAD

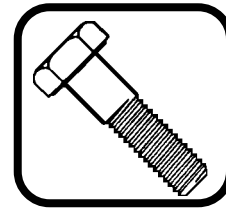

Dia	Length	Part #	Qty
<b>10 mm</b> - 1.50	16	14672	25
	20	14673	25
	22	14674	25
	25	14675	25
	30	14676	25
	35	14677	25
	40	14678	25
	45	14679	25
	50	14680	25
	55	14680A	25
	60	66019	25
	65	66019A	25
	70	66020	25
	75	66021	25
	80	66022	25
	90	66023	25
	100	66024	25
110	66024A	25	
120	66024B	25	
130	66024C	25	
140	66024D	25	
150	66024E	25	
<b>12 mm</b> - 1.75	20	14681	25
	25	14682	25
	30	14683	25
	35	14684	25
	40	14685	25
	45	14686	25
	50	14687	25
	55	14688	25
	60	14689	25
	65	66025	25
	70	66026	25
	75	66027	25
	80	66028	25
	90	66029	25
	100	66030	25
	110	66031	10
	120	66032	10
130	66033	10	
140	66034	10	
150	66034A	10	

Dia	Length	Part #	Qty
<b>14 mm</b> - 2.00	20	14690	25
	25	14691	25
	30	14692	25
	35	14693	25
	40	14694	25
	45	14695	25
	50	14696	25
	55	14697	25
	60	14698	25
	65	14699	25
	70	14700	25
	75	14701	25
	80	66035	25
	90	66036	25
	100	66037	25
	110	66038	10
	120	66039	10
<b>16 mm</b> - 2.00	20	14702	25
	25	14703	25
	30	14704	25
	35	14705	25
	40	14706	25
	45	14707	25
	50	14708	25
	55	14709	25
	60	14710	25
	65	14711	25
	70	14712	25
	75	14713	25
	80	66040	25
	90	66041	25
	100	66042	25
110	66043	10	
120	66044	10	
130	66045	10	
140	66046	10	
150	66047	10	

8

# METRIC HEX CAP SCREWS

## COARSE THREAD

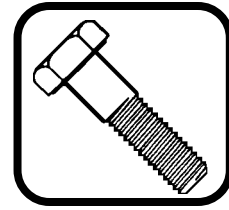

Dia	Length	Part #	Qty
<b>18 mm</b> - 2.50	30	<b>66091</b>	25
	35	<b>66092</b>	25
	40	<b>66093</b>	25
	45	<b>66094</b>	25
	50	<b>66095</b>	20
	55	<b>66096</b>	20
	60	<b>66097</b>	20
	65	<b>66098</b>	20
	70	<b>66099</b>	15
	75	<b>66100</b>	15
	80	<b>66101</b>	15
	85	<b>66102</b>	15
	90	<b>66103</b>	15
	100	<b>66104</b>	15
	110	<b>66105</b>	10
	120	<b>66106</b>	10
	130	<b>66107</b>	10
140	<b>66108</b>	10	
150	<b>66109</b>	10	
<b>20 mm</b> - 2.50	40	<b>66113</b>	20
	45	<b>66114</b>	20
	50	<b>66115</b>	20
	55	<b>66116</b>	20
	60	<b>66117</b>	20
	65	<b>66118</b>	20
	70	<b>66119</b>	15

Dia	Length	Part #	Qty
<b>20 mm</b> - 2.50	75	<b>66120</b>	15
	80	<b>66121</b>	15
	85	<b>66122</b>	15
	90	<b>66123</b>	10
	100	<b>66124</b>	10
	110	<b>66125</b>	10
	120	<b>66126</b>	10
	130	<b>66127</b>	10
	140	<b>66128</b>	10
	150	<b>66129</b>	10
<b>24 mm</b> - 3.00	45	<b>66134</b>	10
	50	<b>66135</b>	10
	55	<b>66136</b>	10
	60	<b>66137</b>	10
	65	<b>66138</b>	10
	70	<b>66139</b>	10
	75	<b>66140</b>	10
	80	<b>66141</b>	10
	90	<b>66143</b>	10
	100	<b>66144</b>	5
110	<b>66145</b>	5	
120	<b>66146</b>	5	
130	<b>66147</b>	5	
140	<b>66148</b>	5	
150	<b>66149</b>	5	

# METRIC HEX CAP SCREWS

FINE THREAD  
Plain Steel - Grade 8.8

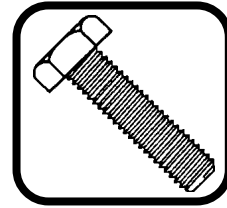

**8**

Dia	Length	Part #	Qty
<b>8 mm</b> - 1.00	16	14768A	25
	20	14768B	25
	25	14769	25
	30	14770	25
	35	14771	25
	40	14772	25
	45	14773	25
	50	14774	25
	60	14810	25
<b>10 mm</b> - 1.25	16	14815	25
	20	14774A	25
	25	14775	25
	30	14776	25
	35	14777	25
	40	14778	25
	45	14779	25
	50	14780	25
	60	66066	25
	70	66067	25
	80	66068	25
90	66069	25	
100	66070	25	
<b>10 mm</b> - 1.00 EXTRA FINE	16	14820	25
	20	14789A	25
	25	14790	25
	30	14791	25
	35	14792	25
	40	14793	25
	45	14794	25
	50	14795	25
60	14823	25	
<b>12 mm</b> - 1.50	20	14781	25
	25	14782	25
	30	14783	25
	35	14784	25
	40	14785	25
	45	14786	25
	50	14787	25

Dia	Length	Part #	Qty
<b>12 mm</b> - 1.50	55	14788	25
	60	14789	25
	65	66071	25
	70	66072	25
	75	66073	25
	80	66074	25
	90	66075	25
	100	66076	25
<b>12 mm</b> - 1.25 EXTRA FINE	20	14796	25
	25	14797	25
	30	14798	25
	35	14799	25
	40	14800	25
	45	14801	25
	50	14802	25
	55	14803	25
	60	14804	25
	65	66077	25
	70	66078	25
75	66079	25	
80	66080	25	
90	66081	25	
100	66082	25	
<b>14 mm</b> - 1.50	50	66083	25
	60	66084	25
	70	66085	25
	75	66086	25
	80	66087	25
	90	66088	25
	100	66089	25
<b>16 mm</b> - 1.50	50	66180	25
	60	66181	25
	70	66182	25
	75	66183	25
	80	66184	25
	90	66185	25
	100	66186	25



# METRIC HEX NUTS

## COARSE, FINE & EXTRA FINE THREAD

Plating: Zinc

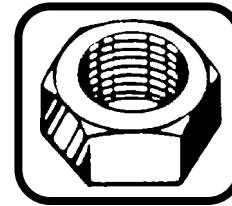

COARSE		
Size(mm)	Part #	Qty
2 x .40	14852	100
2.5 x .45	14853	100
3 x .50	35662	100
4 x .70	33123	100
5 x .80	33124	100
6 x 1.00	14714	100
7 x 1.00	14715	100
8 x 1.25	14716	100
9 x 1.25	14717	100
10 x 1.50	14718	50
11 x 1.50	14718A	50
12 x 1.75	14719	50
14 x 2.00	14720	25
16 x 2.00	14721	25
18 x 2.50	66151	15
20 x 2.50	66152	10
22 x 2.50	14857	5
24 x 3.00	66153	5

### FINE & EXTRA FINE

Size(mm)	Part #	Qty
8 x 1.00	14764	25
10 x 1.25	14765	25
10 x 1.00	14766	25
12 x 1.50	14767	25
12 x 1.25	14768	25
14 x 1.50	66090	25
16 x 1.50	14854	25
18 x 1.50	14854A	10
20 x 2.00	14855	10
20 x 1.50	14856	10

- » Engineered especially to match high torque requirements of 8.8 strength cap screws.
- » Manufactured on automatic nut forgers.
- » Cold formed for more dense grain structure.
- » Special high carbon steel.
- » Double heat treated.

REF: DIN 934

# METRIC NYLON INSERT LOCKNUTS

Plating: Zinc



- » Manufactured from approved nut steel.
- » Nylon compression locking action.
- » Rustproof positive locking action.
- » Vibration proof.
- » Can be reused.
- » Class 2B thread before plating.

REF: DIN 985

### COARSE

Size(mm)	Part #	Qty
3 x .50	15000	100
4 x .70	15001	100
5 x .80	15002	100
6 x 1.00	15003	100
8 x 1.25	15004	100
10 x 1.50	15005	50
12 x 1.75	15006	50
14 x 2.00	15007	50
16 x 2.00	15008	50

### FINE & EXTRA FINE

Size(mm)	Part #	Qty
8 x 1.00	15009	25
10 x 1.25	15010	25
10 x 1.00	15014	25
12 x 1.50	15011	25
12 x 1.25	15015	25
14 x 1.50	15012	25
16 x 1.50	15013	25

# METRIC ALL STEEL LOCKNUTS

Plating: Zinc

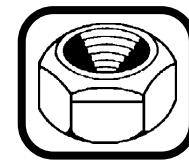

### COARSE

Size(mm)	Part #	Qty
6 x 1.00	15050	100
8 x 1.25	15051	100
10 x 1.50	15052	50
12 x 1.75	15053	50

REF: DIN 980 V

## METRIC WING NUTS

Plating: Zinc

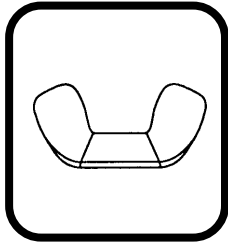

Size(mm)	Part #	Qty
5 x .800	03530	25
6 x 1.00	03531	25
8 x 1.25	03532	25
10 x 1.50	03533	25
12 x 1.75	03534	25

REF: DIN 315

## METRIC KEP NUTS

Plating: Zinc

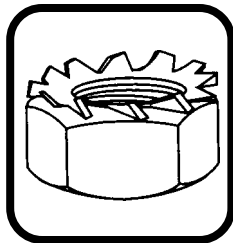

Size(mm)	Part #	Qty
3 x .50	03540	100
4 x .70	03541	100
5 x .80	03542	100
6 x 1.00	03543	100
8 x 1.25	03544	50
10 x 1.50	03545	50

REF: DIN 934 TW

## METRIC LEFT HAND HEX NUT



Size(mm)	Part #	Qty
5 x .80	03325	25
6 x 1.00	03326	25
8 x 1.25	03327	25
10 x 1.50	03329	25
10 x 1.25	03330	25
10 x 1.00	03331	25
12 x 1.75	03332	25
12 x 1.50	03333	25
12 x 1.25	03334	25

REF: DIN 934 L

# METRIC FLAT & LOCK WASHERS

Plating: Zinc

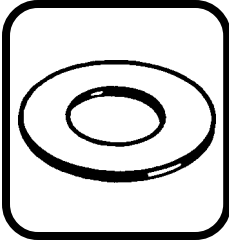

## FLAT WASHERS

Size(mm)	Part #	Pkg
2	66170	100
3	35664	100
4	33127	100
5	33128	100
6	14730	100
7	14731	100
8	14732	100
10	14734	100
12	14735	50
14	14736	25
16	14737	25
18	66154	25
20	66155	25
24	66156	25
30	66165	25

REF: DIN 125

## LOCKWASHERS

Size(mm)	Part #	Pkg
2	66171	100
3	35663	100
4	33125	100
5	33126	100
6	14722	100
7	14723	100
8	14724	100
10	14726	100
12	14727	50
14	14728	25
16	14729	25
18	66157	25
20	66158	25
24	66159	25
30	66160	25

REF: DIN 127 B

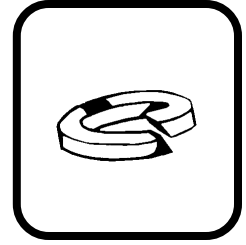

# STAR LOCK WASHERS

Spring Steel - Zinc Plated

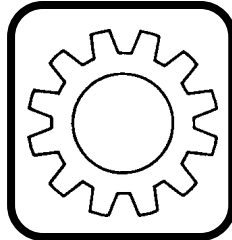

## EXTERNAL

Size(mm)	Part #	Thickness	Qty
3	03282	.0048	100
4	03283	.005	100
5	03284	.006	100
6	03285	.0078	100
8	03287	.01544	100
10	03288	.01976	50
12	03289	.0272	50

REF: DIN 6797A (EXTERNAL)

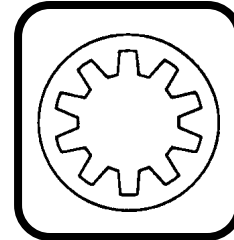

## INTERNAL

Size(mm)	Part #	Thickness	Qty
3	03262	.0062	100
4	03263	.007	100
5	03264	.00784	100
6	03265	.0088	100
8	03267	.01544	100
10	03268	.02532	50
12	03269	.03068	50

REF: DIN 6797J (INTERNAL)

# SPRING WASHERS

Spring Steel

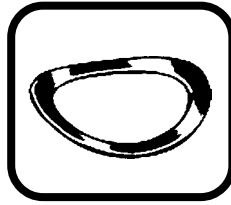

Size(mm)	Part #	Thickness	Qty
3	03300	.00815	100
4	03302	.009	100
5	03303	.009	100
6	03304	.01	100
8	03306	.0165	100
10	03307	.03375	50
12	03308	.054	50
14	03309	.1045	25
16	03310	.10945	25
18	03311	.17065	25
20	03312	.1806	25
22	03313	.29005	25

REF: DIN 137

8

# METRIC COPPER WASHERS

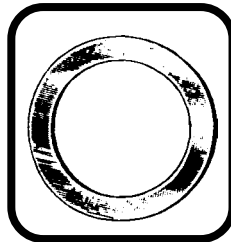

Bolt Size	ID (mm)	OD (mm)	Thickness (mm)	Part #	Qty
m6	6.2	9.8	0.8	A14865	50
m8	8.2	11.8	0.8	A14866	50
m10	10.2	15.8	0.8	A14867	50
m12	12.2	17.8	1.4	A14868	25
m14	14.2	17.8	1.4	A14869	25
m14	14.2	19.8	1.4	A14870	25
m16	16.2	19.8	1.4	A14871	25

REF: DIN 7603

# METRIC SOCKET HEAD CAP SCREWS

Alloy Steel

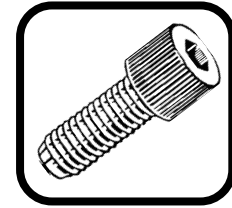

Dia	Length	Part #	Qty
<b>3 mm</b> - .50 2.5mm Key	5	66200	100
	6	66201	100
	8	66202	100
	10	66203	100
	12	66204	100
	14	66205	100
	16	66206	100
	20	66207	100
	25	66208	100
	30	66209	100
<b>4 mm</b> - .70 3.0mm Key	6	66210	100
	8	66211	100
	10	66212	100
	12	66213	100
	14	66214	100
	16	66215	100
	18	66216	100
	20	66217	100
	25	66218	100
	30	66219	100
<b>5 mm</b> - .80 4.0mm Key	35	66220	100
	40	66221	100
	45	66222	100
	50	66223	100
	6	66224	100
	8	66225	100
	10	66226	100
	12	66227	100
	14	66228	100
	15	66229	100
16	66230	100	
18	66231	100	
20	66232	100	
22	66233	100	
25	66234	100	
30	66235	100	
35	66236	100	
40	66237	100	
45	66238	100	
50	66240	100	

Dia	Length	Part #	Qty
<b>6 mm</b> -1.00 5.0mm Key	10	66241	100
	12	66242	100
	14	66243	100
	16	66244	100
	20	66245	100
	22	66246	100
	25	66247	100
	30	66248	100
	35	66249	100
	40	66250	100
	45	66251	100
	50	66252	100
	55	66253	100
	60	66254	100
	65	66255	100
	70	66256	100
	75	66257	100
80	66258	100	
90	66259	100	
100	66260	100	
<b>8 mm</b> -1.25 6.0mm Key	12	66261	100
	16	66262	100
	20	66263	100
	25	66264	100
	30	66265	100
	35	66266	100
	40	66267	100
	45	66268	100
	50	66269	100
	55	66270	100
	60	66271	100
	65	66272	100
	70	66273	100
	75	66274	100
	80	66275	100
	90	66276	100
	100	66277	100

Dia	Length	Part #	Qty
<b>10 mm</b> -1.50 8.0mm Key	16	66278	100
	20	66279	100
	25	66280	100
	30	66281	100
	35	66282	100
	40	66283	100
	45	66284	100
	50	66285	100
	55	66286	100
	60	66287	50
	65	66288	50
	70	66289	50
	75	66290	50
	80	66291	50
	90	66292	50
100	66293	50	
<b>12 mm</b> -1.75 10.0mm Key	20	66294	50
	25	66295	50
	30	66300	50
	35	66301	50
	40	66302	50
	45	66303	50
	50	66304	50
	55	66305	50
	60	66306	50
	65	66307	50
	70	66308	25
	75	66309	25
80	66310	25	
90	66311	25	
100	66312	25	

**8**

# METRIC SOCKET CAP SCREWS

FLAT HEAD & BUTTON HEAD

Alloy Steel

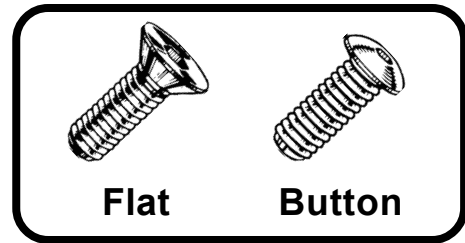

Flat

Button

Dia	Length	Part #		Qty
		Flat	Button	
<b>3 mm</b> - .50 2.0mm Key	6	66360	66330	100
	8	66361	66331	100
	10	66362	66332	100
	12	66363	66333	100
	15	66364	—	100
	16	66365	66334	100
<b>4 mm</b> - .70 2.5mm Key	8	66367	66335	100
	10	66368	66336	100
	12	66369	66337	100
	16	66370	66338	100
	20	66371	—	100
	25	66372	—	100
	30	66373	—	100
	35	66374	—	100
40	66375	—	100	
<b>5 mm</b> - .80 3.0mm Key	10	66376	66339	100
	12	66377	66340	100
	14	66378	—	100
	16	66379	66341	100
	20	66380	66342	100
	25	66381	66343	100
	30	66382	66344	100
	35	66383	—	100
	40	66384	—	100

Dia	Length	Part #		Qty
		Flat	Button	
<b>6 mm</b> - 1.00 4.0mm Key	10	66385	66345	100
	12	66386	66346	100
	14	66387	—	100
	16	66388	66347	100
	20	66389	66348	100
	25	66390	66349	100
	30	66391	66350	100
	35	66392	—	100
	40	66393	—	100
<b>8 mm</b> - 1.25 5.0mm Key	12	66394	—	100
	16	66395	66352	100
	20	66396	66353	100
	25	66397	66354	100
	30	66398	66355	100
	35	66399	—	100
	40	66400	—	100
	<b>10 mm</b> - 1.50 6.0mm Key	16	66401	—
20		66402	66356	100
25		66403	66357	100
30		66404	66358	100
35		66405	—	100
40		66406	66359	100
45		66407	—	100
50		66408	—	100

8

# METRIC SOCKET SET SCREWS - CUP POINT

Alloy Steel



Dia	Length	Part #	Qty
<b>3 mm</b> - .50 1.5mm Key	3	<b>66420</b>	100
	4	<b>66421</b>	100
	5	<b>66422</b>	100
	6	<b>66423</b>	100
	8	<b>66424</b>	100
	10	<b>66425</b>	100
	12	<b>66426</b>	100
<b>4 mm</b> - .70 2.0mm Key	4	<b>66427</b>	100
	5	<b>66428</b>	100
	6	<b>66429</b>	100
	8	<b>66430</b>	100
	10	<b>66431</b>	100
	12	<b>66432</b>	100
	16	<b>66433</b>	100
<b>5 mm</b> - .80 2.5mm Key	5	<b>66434</b>	100
	6	<b>66435</b>	100
	8	<b>66436</b>	100
	10	<b>66437</b>	100
	12	<b>66438</b>	100
	16	<b>66439</b>	100
	20	<b>66440</b>	100
	25	<b>66441</b>	100

Dia	Length	Part #	Qty
<b>6 mm</b> - 1.00 3.0mm Key	6	<b>66442</b>	100
	8	<b>66443</b>	100
	10	<b>66444</b>	100
	12	<b>66445</b>	100
	16	<b>66446</b>	100
	20	<b>66447</b>	100
	25	<b>66448</b>	100
<b>8 mm</b> - 1.25 4.0mm Key	8	<b>66449</b>	100
	10	<b>66450</b>	100
	12	<b>66451</b>	100
	16	<b>66452</b>	100
	20	<b>66453</b>	100
	25	<b>66454</b>	100
<b>10 mm</b> - 1.50 5.0mm Key	10	<b>66455</b>	100
	12	<b>66456</b>	100
	16	<b>66457</b>	100
	20	<b>66458</b>	100
	25	<b>66459</b>	100
<b>12 mm</b> - 1.75 6.0mm Key	12	<b>66460</b>	100
	16	<b>66461</b>	100
	20	<b>66462</b>	100
	25	<b>66463</b>	100
	30	<b>66464</b>	100

# METRIC MACHINE SCREWS

## SLOTTED PAN HEAD

4.8 Steel - Zinc Plated

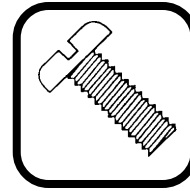

Dia	Length	Part #	Qty
<b>3 mm</b> -.50	6	<b>35705</b>	100
	8	<b>35706</b>	100
	10	<b>35707</b>	100
	12	<b>35708</b>	100
	16	<b>35709</b>	100
	20	<b>35710</b>	100
<b>4 mm</b> -.70	5	<b>35712</b>	100
	6	<b>35713</b>	100
	8	<b>35714</b>	100
	10	<b>35715</b>	100
	12	<b>35716</b>	100
	16	<b>35717</b>	100
	18	<b>35718</b>	100
	20	<b>35719</b>	100
	25	<b>35721</b>	100
	30	<b>35722</b>	100
35	<b>35723</b>	100	
<b>5 mm</b> -.80	8	<b>35725</b>	100
	10	<b>35726</b>	100
	12	<b>35727</b>	100
	16	<b>35728</b>	100
	18	<b>35729</b>	100
	20	<b>35730</b>	100
	25	<b>35732</b>	100
	30	<b>35733</b>	100
	35	<b>35734</b>	100

Dia	Length	Part #	Qty
<b>6 mm</b> -1.00	8	<b>35735</b>	100
	10	<b>35736</b>	100
	12	<b>35737</b>	100
	16	<b>35738</b>	100
	18	<b>35739</b>	100
	20	<b>35740</b>	100
	25	<b>35742</b>	100
	35	<b>35744</b>	100
	30	<b>35745</b>	100
	40	<b>35746</b>	100
45	<b>35747</b>	100	
<b>8 mm</b> -1.25	16	<b>35748</b>	100
	20	<b>35749</b>	100
	25	<b>35750</b>	100
	30	<b>35751</b>	100
	35	<b>35752</b>	100
	40	<b>35753</b>	100
	45	<b>35754</b>	100
<b>10 mm</b> -1.50	16	<b>35755</b>	100
	20	<b>35756</b>	100
	25	<b>35757</b>	100
	30	<b>35758</b>	100
	35	<b>35759</b>	100
	40	<b>35760</b>	100
	45	<b>35761</b>	100

» Manufactured to DIN 85/ISO 1580/ANSI B18.6.7.m Specifications.



# METRIC MACHINE SCREWS

## PHILLIPS PAN HEAD

4.8 Steel - Zinc Plated

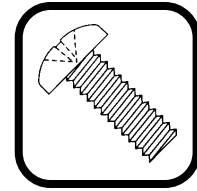

Dia	Length	Part #	Qty
<b>3 mm</b> - .50	6	<b>35605</b>	100
	8	<b>35606</b>	100
	10	<b>35607</b>	100
	12	<b>35608</b>	100
	16	<b>35609</b>	100
	20	<b>35610</b>	100
	25	<b>35611</b>	100
<b>4 mm</b> - .70	5	<b>35612</b>	100
	6	<b>35613</b>	100
	8	<b>35614</b>	100
	10	<b>35615</b>	100
	12	<b>35616</b>	100
	16	<b>35617</b>	100
	18	<b>35618</b>	100
	20	<b>35619</b>	100
	25	<b>35621</b>	100
	30	<b>35622</b>	100
	35	<b>35623</b>	100
	40	<b>35624</b>	100
	45	<b>35624A</b>	100
50	<b>35624B</b>	100	
<b>5 mm</b> - .80	8	<b>35625</b>	100
	10	<b>35626</b>	100
	12	<b>35627</b>	100
	16	<b>35628</b>	100
	18	<b>35629</b>	100
	20	<b>35630</b>	100
	25	<b>35632</b>	100
	30	<b>35633</b>	100
	35	<b>35634</b>	100

Dia	Length	Part #	Qty
<b>6 mm</b> - 1.00	8	<b>35635</b>	100
	10	<b>35636</b>	100
	12	<b>35637</b>	100
	16	<b>35638</b>	100
	18	<b>35639</b>	100
	20	<b>35640</b>	100
	25	<b>35642</b>	100
	30	<b>35644</b>	100
	35	<b>35645</b>	100
	40	<b>35646</b>	100
	45	<b>35647</b>	100
<b>8 mm</b> - 1.25	16	<b>35648</b>	100
	20	<b>35649</b>	100
	25	<b>35650</b>	100
	30	<b>35651</b>	100
	35	<b>35652</b>	100
	40	<b>35653</b>	100
	45	<b>35654</b>	100
<b>10 mm</b> - 1.50	16	<b>35655</b>	100
	20	<b>35656</b>	100
	25	<b>35657</b>	100
	30	<b>35658</b>	100
	35	<b>35659</b>	100
	40	<b>35660</b>	100
	45	<b>35661</b>	100

» Manufactured to DIN 7985/ISO 7045/ANSI B18.6.7.m Specifications.

# METRIC MACHINE SCREWS

## PHILLIPS OVAL HEAD AND FLAT HEAD

Plating: Zinc

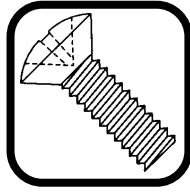

Oval Head

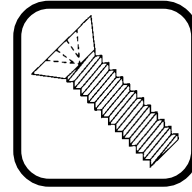

Flat Head

Dia	Length	Part #		Qty
		Oval	Flat	
<b>3</b> mm -.50	6	61000	61050	50
	8	61001	61051	50
	10	61002	61052	50
	12	61003	61053	50
	16	61004	61054	50
	20	61005	61055	50
	25	61006	61056	50
<b>4</b> mm -.70	6	61007	61057	50
	8	61008	61058	50
	10	61009	61059	50
	12	61010	61060	50
	16	61011	61061	50
	18	61012	61062	50
	20	61013	61063	50
	25	61014	61064	50
	30	61015	61065	50
	35	61016	61066	50
	40	61017	61067	50
<b>5</b> mm -.80	8	61018	61068	50
	10	61019	61069	50
	12	61020	61070	50
	16	61021	61071	50
	18	61022	61072	50
	20	61023	61073	50
	25	61024	61074	50

Dia	Length	Part #		Qty
		Oval	Flat	
<b>5</b> mm -.80	30	61025	61075	50
	35	61026	61076	50
	40	61027	61077	50
	45	61028	61078	50
	50	61029	61079	50
<b>6</b> mm -1.00	10	61030	61080	50
	12	61031	61081	50
	16	61032	61082	50
	20	61033	6103	50
	25	61034	61084	50
	35	61035	61085	50
	30	61036	61086	50
	40	61037	61087	50
	45	61038	61088	50
	50	61039	61089	50
<b>8</b> mm -1.25	60	61040	61090	50
	16	61041	61091	25
	20	61042	61092	25
	25	61043	61093	25
	30	61044	61094	25
	35	61045	61095	25
	40	61046	61096	25
	45	61047	91097	25
50	61048	61098	25	

8

# METRIC STUDS

## MILD STEEL 5.8

Regular Pitch - Plain Finish

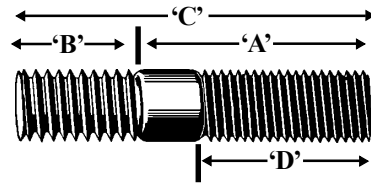

Part #	A Dia & Length	B Dia & Length	D Length (mm)	C OAL (mm)	Qty
A11973	6mm - 1.00 x 20mm	6mm - 1.00 x 7.5mm	18	27.5	10
A11974	6mm - 1.00 x 25mm	6mm - 1.00 x 7.5mm	18	32.5	10
A11980	8mm - 1.25 x 20mm	8mm - 1.25 x 10mm	22	30.0	10
A11981	8mm - 1.25 x 25mm	8mm - 1.25 x 10mm	22	35.0	10
A11982	8mm - 1.25 x 30mm	8mm - 1.25 x 10mm	22	40.0	10
A11983	8mm - 1.25 x 35mm	8mm - 1.25 x 10mm	22	45.0	10
A11984	8mm - 1.25 x 40mm	8mm - 1.25 x 10mm	22	50.0	10
A11987	8mm - 1.25 x 55mm	8mm - 1.25 x 10mm	22	65.0	10
A11989	10mm - 1.50 x 30mm	10mm - 1.50 x 12mm	26	42.0	10
A11990	10mm - 1.50 x 35mm	10mm - 1.50 x 12mm	26	47.0	10
A11991	10mm - 1.50 x 40mm	10mm - 1.50 x 12mm	26	52.0	10
A11993	10mm - 1.50 x 50mm	10mm - 1.50 x 12mm	26	62.0	10
A11995	10mm - 1.50 x 60mm	10mm - 1.50 x 12mm	26	72.0	10
A11998	12mm - 1.75 x 30mm	12mm - 1.75 x 15mm	30	45.0	10
<b>SPECIALTY STUDS</b>					
Part #	Diameter	B Dia & Length	D Length (mm)	OAL (mm)	Qty
A11403	8mm - 1.25	Volkswagon Exhaust Manifold		38	25
A11404	8mm - 1.25	Volkswagon Intake Manifold (Full Thread)		35	25
A17559	10mm - 1.25	10mm - 1.25 x 21mm	10	42	10
A17560	10mm - 1.25	10mm - 1.25 x 15mm	25	48	10
A17596	12mm - 1.25	Catalytic Converter Mazda	(Full Thread)	50	5

8

# METRIC THREAD ROD

## PLAIN STEEL

Coarse Pitch

Dia	Length	Part #	Qty
4mm - .70	1 meter -39"	07780	1
5mm - .80	1 meter -39"	07781	1
6mm -1.00	1 meter -39"	07782	1
8mm - 1.25	1 meter -39"	07784	1
10mm -1.50	1 meter -39"	07785	1
12mm - 1.75	1 meter -39"	07786	1
14mm - 2.00	1 meter -39"	07787	1
16mm -2.00	1 meter -39"	07788	1

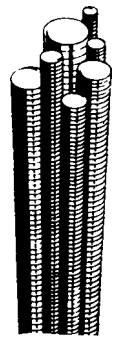

REF: DIN 975

# METRIC COTTER PINS

Steel - Zinc Plated

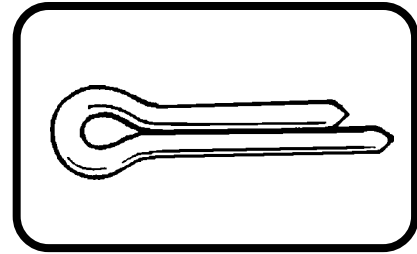

**8**

Dia	Length	Part #	Qty
<b>1.6 mm</b>	8	<b>03201</b>	100
	14	<b>03202</b>	100
	20	<b>03203</b>	100
	25	<b>03204</b>	100
	32	<b>03205</b>	100
<b>2 mm</b>	10	<b>03209</b>	100
	14	<b>03210</b>	100
	20	<b>03211</b>	100
	25	<b>03214</b>	100
	32	<b>03215</b>	100
	40	<b>03216</b>	100
<b>2.5 mm</b>	14	<b>03217</b>	100
	20	<b>03219</b>	100
	25	<b>03220</b>	100
	32	<b>03223</b>	100
	40	<b>03224</b>	100
	50	<b>03225</b>	100
<b>3.2 mm</b>	20	<b>03225A</b>	100
	25	<b>03226</b>	100
	32	<b>03227</b>	100
	40	<b>03228</b>	100
	50	<b>03229</b>	100

Dia	Length	Part #	Qty
<b>4 mm</b>	20	<b>03229A</b>	100
	25	<b>03230</b>	100
	32	<b>03232</b>	100
	40	<b>03233</b>	100
	45	<b>03234</b>	50
	50	<b>03235</b>	50
	63	<b>03236</b>	50
<b>5 mm</b>	32	<b>03237</b>	50
	40	<b>03240</b>	50
	45	<b>03241</b>	50
	50	<b>03242</b>	50
	63	<b>03243</b>	50
	71	<b>03244</b>	50
<b>6.3 mm</b>	40	<b>03245</b>	50
	45	<b>03246</b>	50
	50	<b>03247</b>	50
	63	<b>03248</b>	50
	71	<b>03248A</b>	50
	80	<b>03249</b>	50
	<b>10 mm</b>	50	<b>03251</b>
63		<b>03252</b>	25
71		<b>03253</b>	25
80		<b>03254</b>	25
90		<b>03255</b>	25
100		<b>03256</b>	25

» Manufactured to DIN 94/ISO 1234 Specifications.

# METRIC RETAINING RINGS

## INTERNAL

Spring Steel Phosphated

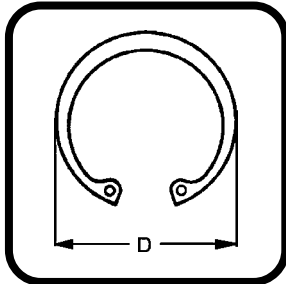

Part #	Size(mm)	D Free O.D.(mm)	Qty
10000	8	8.7	50
10001	9	9.8	50
10002	10	10.8	50
10003	11	11.8	50
10004	12	13	25
10005	14	15.1	25
10006	16	17.3	25
10007	18	19.5	25
10008	20	21.5	25
10009	24	25.9	25
10010	28	30.1	25
10011	32	32.1	25

REF: DIN 472

# METRIC RETAINING RINGS

## EXTERNAL

Spring Steel Phosphated

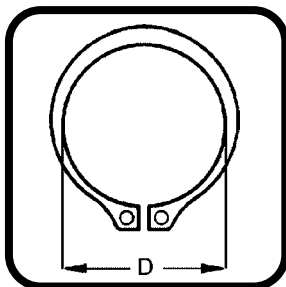

Part #	Size(mm)	D Free I.D.(mm)	Qty
10015	5	4.7	50
10016	6	5.6	50
10017	8	7.4	50
10018	9	8.4	50
10019	10	9.3	50
10020	11	10.2	50
10021	12	11	25
10022	14	12.9	25
10023	16	14.7	25
10024	18	16.5	25
10025	20	23.2	25
10026	24	23.2	25

REF: DIN 471

# METRIC RETAINING RINGS

## E-RING CIRCLIPS

Spring Steel Hardened (HRC 46 to 55)

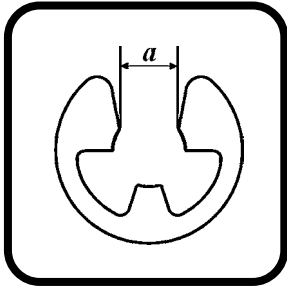

Part #	Size(mm)	a(mm)	Qty
10031	2.3	1.94	50
10032	3.2	2.70	50
10033	4	3.34	50
10034	5	4.11	50
10035	6	5.26	25
10036	7	5.84	25
10037	8	6.52	25
10038	9	7.63	25
10039	10	8.32	25
10040	12	10.45	15
10043	15	12.61	15
10047	19	15.92	10

REF: DIN 6799

# METRIC GREASE FITTINGS

Ball Check Plated



**06920**

Qty: 15

6mm - 1.00, Straight  
Overall Length: 14mm



**06921**

Qty: 15

6mm - 1.00, 45°  
Overall Length: 22mm



**06922**

Qty: 15

6mm - 1.00, 90°  
Overall Length: 18mm



**06923**

Qty: 10

8mm - 1.00, Straight  
Overall Length: 15mm



**06924**

Qty: 10

8mm - 1.00, 45°  
Overall Length: 23mm



**06925**

Qty: 10

8mm - 1.00, 90°  
Overall Length: 18mm

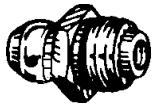

**06926**

Qty: 10

8mm - 1.25, Straight  
Overall Length: 15mm



**06927**

Qty: 10

8mm - 1.25, 45°  
Overall Length: 23mm

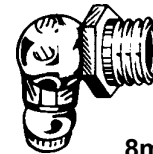

**06928**

Qty: 10

8mm - 1.25, 90°  
Overall Length: 18mm

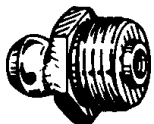

**06929**

Qty: 5

10mm - 1.00, Straight  
Overall Length: 14mm



**06930**

Qty: 5

10mm - 1.00, 45°  
Overall Length: 23mm



**06931**

Qty: 5

10mm - 1.00, 90°  
Overall Length: 14mm

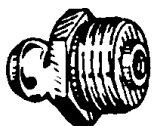

**06932**

Qty: 5

10mm - 1.50, Straight  
Overall Length: 14mm



**06933**

Qty: 5

10mm - 1.50, 45°  
Overall Length: 24mm

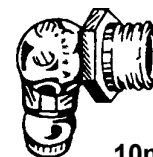

**06934**

Qty: 5

10mm - 1.50, 90°  
Overall Length: 14mm



# METRIC **FAS-KIT**<sup>®</sup> ASSORTMENTS



<b>Plastic Box Assortments</b>		
Part Number	Description	Number of Pieces
FK07000	Metric Hex Head Cap Screws - With Nuts & Washers	280
FK07100	Metric Ph Pan Head Mach Screws With Nuts	275
FK07150	Metric Socket Head Cap Screws	187
FK07200	Metric E-Type Retaining Rings	220
FK07205	Metric Internal & External Type Retaining Rings	360

<b>Metal Tray Assortments</b>			
Small Drawer	Large Drawer	Description	Number of Pieces
-	FK58200	Metric Hex Head Cap Screws - Coarse Pitch - Grade 8.8	520
FK18210	FK58210	Metric Hex Head Cap Screws - Small Sizes - Grade 8.8	805
-	FK58220	Metric Hex Head Cap Screws - With Nuts & Washers	655
FK18250	FK58250	Metric Hex Head Cap Screws - Fine Pitch - Grade 8.8	260
FK18255	FK58255	Metric Hex Head Cap Screws - Fine Pitch - With Nuts	305
FK18270	FK58270	J.I.S. Metric Hex Head Cap Screws - Grade 8.8	340
FK18300	FK58300	Metric Hex Nuts - Coarse & Fine (DIN 934 ZP)	625
FK18320	FK58320	Metric Hex Nuts & Elastic Stop Nuts - Steel Zinc Plated	340
FK18350	FK58350	Metric Elastic Stop Nuts - Steel Zinc Plated	450
FK18400	FK58400	Metric Nuts, Flat Washers & Lock Washers	925
FK18450	FK58450	Metric Flat & Lock Washers - Steel Zinc Plated	1250
FK18500	FK58500	Metric Phillips Pan Head Machine Screws - with Nuts	885
FK18550	FK58550	Metric Socket Head Cap Screws	720
FK18600	FK58600	Metric Socket Set Screws Cup Point	785
FK18610	FK58610	Metric Flat Socket Head Cap Screws	700
FK18620	FK58620	Metric Button Socket Head Cap Screws	700
FK18650	FK58650	Metric Cotter Pins - Extended Prong	770
FK18700	FK58700	Metric E-Type Retaining Rings	365
FK18750	FK58750	Metric Internal & External Type Retaining Rings	825
FK19200	FK59200	U-Nuts - USS & Metric	165
FK19450	FK59450	Metric Flange Lock Nuts	135
FK19650	FK59650	Metric Body Bolts	253
FK19950	FK59950	Metric Stud Assortment	60

<b>40 Hole Bin Assortments</b>		
Part Number	Description	Number of Pieces
FK90080	m5-m12 Hex Head Cap Screws - With Nuts & Washers	2315
FK90085	m14-m24 Hex Head Cap Screws - With Nuts & Washers	515

8



# Section 9: Chain & Wire Hardware

## Table of Contents

### Chain

Proof Coil Chain, <i>Zinc Plated</i> .....	3
Proof Coil Chain, <i>Galvanized</i> .....	3
Single Jack Chain, <i>Zinc Plated</i> .....	4

### Cable & Accessories

Aircraft Cable, <i>Galvanized</i> .....	4
Aircraft Cable, <i>Vinyl Coated</i> .....	4
Cable Swage Sleeves .....	5
Wire Rope Clamps .....	5
Wire Rope Thimbles .....	5

### Chain Hardware

Clevis Grab Hooks .....	6
Clevis Slip Hooks .....	6
Regular Grab Hooks .....	6
Regular Slip Hooks .....	6
Shackles, <i>Screw Pin Anchor</i> .....	7
Double Clevis Links .....	7
Quick Links .....	7

### Rigging Hardware

Eye Bolts, <i>Drop Forged &amp; Galvanized</i> .....	8
Machinery Lifting Eyes, <i>Drop Forged Plain Steel</i> .....	8
Turnbuckles, <i>Drop Forged &amp; Galvanized</i> .....	9
Yoke Ends, <i>Plain Steel</i> .....	9
Eye Bolts, <i>Light Duty Zinc Plated</i> .....	10
Lag Screw Eyes, <i>Light Duty Zinc Plated</i> .....	10
Acoustical Lags, <i>Zinc Plated</i> .....	10
Midget Turnbuckles, <i>Light Duty Cast Aluminum</i> .....	10

### U-Bolts

Square Bend, <i>For Leaf Springs</i> .....	11
Round Bend, <i>For Leaf Springs</i> .....	11
Round Bend, <i>Zinc Plated for Pipe Hanging</i> .....	11

### Brackets

Corner Braces .....	12
Flat Corner Braces .....	12
Flat Mending Braces .....	12
Shelf Brackets .....	12

### Steel Stock

Round Stock .....	13
Flat Stock .....	13
Perforated Angle .....	13

### Miscellaneous

Mechanics Wire .....	14
Perforated Hanger Strap .....	14
Rubber Tie Down Straps .....	14
S-Hooks .....	15
Bolt Snaps & Spring Clips .....	16
Pulleys .....	16
Bevel Washers .....	17
Bolt Cutters .....	17



# GRADE 30 PROOF COIL CHAIN

**\*\* NOT TO BE USED FOR OVERHEAD LIFTING \*\***

**100 LB. HANDY PAILS**

Zinc Plated or Hot Dipped Galvanized

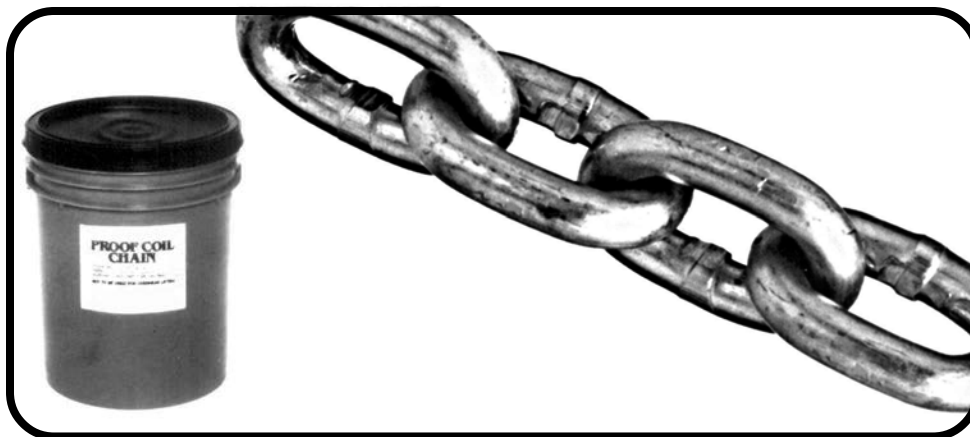

General utility low carbon steel chain used for such purposes as pulling stumps, lashing cargo, pipeline installations, logging, tow chains, mooring use, and truck tailgates.

Trade Size Inch	Material Size Inch	Nominal Inside Link Length, Inches	Nominal Inside Link Width, Inches	Feet Per Pail	Maximum Working Load Limit	Part # *
<b>ZINC PLATED</b>						
3/16	.202	.97	.40	250	750 lbs.	<b>C0193</b>
1/4	.265	1.02	.50	141	1250 lbs.	<b>C0194</b>
5/16	.312	1.24	.50	92	1900 lbs.	<b>C0195</b>
3/8	.394	1.35	.57	63	2650 lbs.	<b>C0196</b>
1/2	.512	1.70	.75	35	4500 lbs.	<b>C0197</b>
<b>HOT GALVANIZED **</b>						
3/16	.202	.97	.40	250	750 lbs.	<b>C0193-G</b>
1/4	.265	1.02	.40	141	1250 lbs.	<b>C0194-G</b>
5/16	.312	1.24	.50	92	1900 lbs.	<b>C0195-G</b>
3/8	.394	1.35	.50	63	2650 lbs.	<b>C0196-G</b>

\* **AVAILABLE BY THE FOOT:** To order just add "FT" after the part number and indicate number of feet. (Example: C0193FT would get you the number of feet of 3/16 zinc plated chain you wanted.)

\*\* **WARNING:** Hot galvanizing can reduce work load limits by up to 20 percent.

- » Do not exceed work load limits.
- » Not to be used for overhead lifting.
- » Every foot of proof coil chain has been proof tested prior to leaving the factory to insure compliance with published specifications.

# SINGLE JACK CHAIN

Bright Zinc

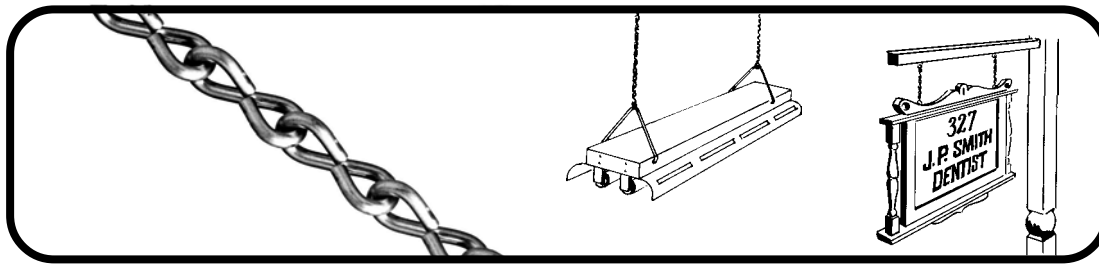

Trade Size	Wire Diameter Inch	Approximate Links Per Foot	Approximate Weight Per 100 Ft.	Maximum Working Load Limit	Part #
12	.1055	16	8.5 lbs.	29 lbs.	C6026

» Quantity: 100 feet per box.

» Ideal for hanging lighting fixtures and novelties, such as flower pots, children's toys and other general utility applications.

# AIRCRAFT CABLE

(WIRE ROPE)

Galvanized

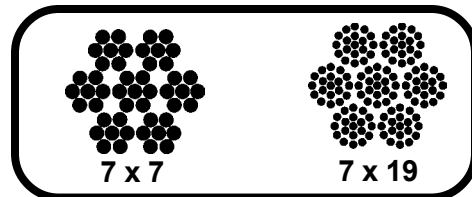

9

Diameter without Coating	Diameter with Coating	Stranding	Approximate Breaking Strength	Part #	Roll Length
<b>Galvanized</b>					
1/16	—	7 x 7	480	AC01	500'
3/32	—	7 x 7	920	AC015	500'
1/8	—	7 x 7	1700	AC02	500'
3/16	—	7 x 19	4200	AC03	250'
1/4	—	7 x 19	7000	AC04	250'
<b>Vinyl Coated</b>					
1/16	3/32	7 x 7	480	AC01VC	500'
3/32	1/8	7 x 7	902	AC015VC	500'
1/8	3/16	7 x 7	1700	AC02VC	500'
3/16	1/4	7 x 19	4200	AC03VC	250'
1/4	5/16	7 x 19	7000	AC04VC	250'

» **AVAILABLE BY THE FOOT:** To order just add "FT" after the part number and indicate number of feet. (Example: AC03VCFT would get you the number of feet of 3/16 coated cable you wanted.)

# SWAGE SLEEVES

Zinc Plated

- » Sleeves, when properly applied, are capable of holding the rated breaking strength of the cable to which they are applied.

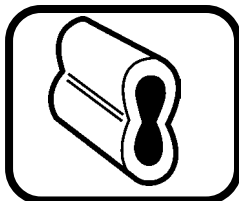

Cable Size	Part #	Qty
1/8	ACS02	100
1/8, 3/16	ACS02A	100
3/16	ACS03	100
1/4	ACS04	100

# MALLEABLE WIRE ROPE CLAMPS

Zinc Plated



- » Malleable iron base (saddle) with steel u-bolt and finished hex nuts.
- » Meets Federal Specification FF-C-450 Type 1 Class 2.

Rope Size	Part #	Qty
1/8	WRC-02	25
3/16	WRC-03	25
1/4	WRC-04	25
5/16	WRC-05	25
3/8	WRC-06	25
7/16	WRC-07	10
1/2	WRC-08	10
5/8	WRC-10	5
3/4	WRC-12	5
7/8	WRC-14	1
1	WRC-16	1

9

# WIRE ROPE THIMBLES

Hot Dip Galvanized Steel

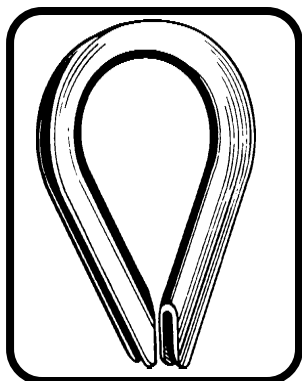

- » Meets Federal Specification FF-T-276B Type 2.

For Rope Dia. In.	Overall Length Inches	Inside Width Inches	Part #	Qty
1/8	1-15/16	11/16	WRT-02	25
3/16	1-7/8	23/32	WRT-03	25
1/4	1-7/8	23/32	WRT-04	25
5/16	2-3/16	25/32	WRT-05	25
3/8	2-1/2	15/16	WRT-06	25
1/2	2-13/16	1-1/8	WRT-08	10
5/8	3-5/8	1-1/2	WRT-10	10
3/4	4-5/16	1-7/8	WRT-12	10
7/8	5-3/16	2-3/16	WRT-14	5
1	6-1/8	2-21/32	WRT-16	5

# “CLEVIS” GRAB & SLIP HOOKS

SHOT BLASTED - RUST INHIBITED

Drop Forged Steel



Grab



Slip

Size	Inside Width at Pin	Pin Dia.	Hook Opening		Part #		Qty
			Clevis Grab	Clevis Slip	Clevis Grab	Clevis Slip	
1/4	11/32	5/16	11/32	3/4	CG-04	CS-04	1
5/16	13/32	3/8	13/32	15/16	CG-05	CS-05	1
3/8	1/2	7/16	1/2	1-3/32	CG-06	CS-06	1
1/2	21/32	9/16	21/32	1-13/32	CG-08	CS-08	1

### Grab Hooks

» Securely holds a single link of chain in narrow opening. Excellent for looping chain around a load in a choker arrangement.

### Slip Hooks

» Allow chain to slide through the throat of the hook. They are sized by the diameter of the chain they are to engage. Commonly used with chain to make a loop that will tighten around a load when pulled taut. Excellent for pulling material or securing loads.

» **WARNING:** Do not use for overhead lifting when used with chain.

» When used with wire rope, ensure that the eye diameter will accommodate the wire rope thimble.

» Clevis attach to chain links and other closed-end attachments using the clevis pin.



# DROP FORGED STEEL SHACKLES

## SCREW PIN ANCHOR

Hot Dip Galvanized

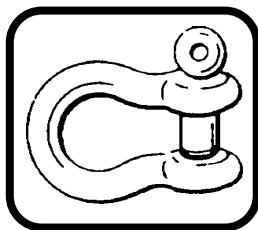

- » Screw Pin Anchor Shackles are used to attach fittings to chain and wire rope rigging lines.
- » Ideal for multiple connections.
- » Screw Pins are easy to remove without the use of tools.  
Ideal for applications where shackle is frequently removed.
- » Not for use if there will be movement or vibration of the pin.

Size	Fed Spec RR-C-271B		Part #	Qty
	Inside Width at Pin	Inside Length		
3/16	3/8	7/8	SHACK-03	1
1/4	15/32	1-1/8	SHACK-04	1
5/16	17/32	1-7/32	SHACK-05	1
3/8	21/32	1-7/16	SHACK-06	1
7/16	23/32	1-11/16	SHACK-07	1
1/2	13/16	1-7/8	SHACK-08	1
5/8	1-1/16	2-13/32	SHACK-10	1
3/4	1-1/4	2-27/32	SHACK-12	1
7/8	1-7/16	3-5/16	SHACK-14	1
1	1-11/16	3-3/4	SHACK-16	1

# DOUBLE CLEVIS LINKS

ZINC PLATED

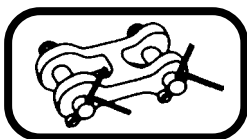

Length	Max Load	Part #	Qty
1/4 & 5/16	3900 lbs.	NAT-240879	5
3/8	5400 lbs.	NAT-240887	3

9

# QUICK LINKS

Zinc Plated

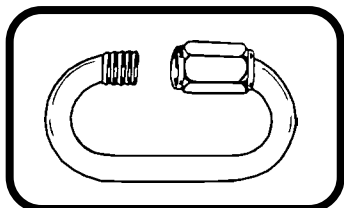

- » Connectors are reusable.
- » Threaded connectors offer a quick and easy way to attach end fittings and repair chain. To close, simply screw the nut onto the threaded end.

Size	Overall Length	Gap Opening	Average Tensile Lbs.	Part #	Qty
1/8	1-3/8	3/16	660	QL-02	5
3/16	1-7/8	1/4	2200	QL-03	5
1/4	2-1/4	9/32	3300	QL-04	5
5/16	2-15/16	3/8	7700	QL-05	5
3/8	3-1/8	7/16	8800	QL-06	5
1/2	4-1/8	19/32	14300	QL-08	5

# DROP FORGED EYE BOLTS

Hot Galvanized

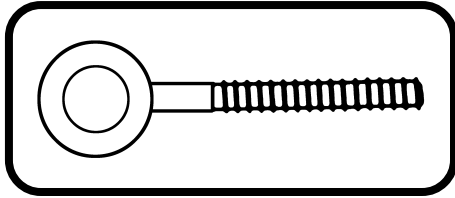

- » Machine thread eye bolts are threaded National Coarse before galvanizing and assembled with hex nuts tapped oversize.
- » Loads are based on a safety factor of 5 to 1.
- » When tested all eye bolts are pulled at a uniform rate of speed in a direct tension.
- » WARNING: Any deviations such as angular lifts, shock loads, modification of the basic forging, etc., will result in drastically reduced working load limits.

Dia	Length	Max Load	Part #	Qty
<b>1/4</b>	2"	500 lbs.	CHI-080057	1
	4"	500 lbs.	CHI-080118	1
	6"	500 lbs.	CHI-080170	1
<b>5/16</b>	2-1/4"	800 lbs.	CHI-080224	1
	3-1/4"	800 lbs.	CHI-080255	1
	4-1/4"	800 lbs.	CHI-080286	1
	5"	800 lbs.	CHI-080316	1
	6"	800 lbs.	CHI-080347	1
<b>3/8</b>	2-1/2"	1200 lbs.	CHI-080392	1
	3"	1200 lbs.	CHI-080422	1
	4-1/2"	1200 lbs.	CHI-080453	1
	6"	1200 lbs.	CHI-080514	1
<b>1/2</b>	8"	1200 lbs.	CHI-080545	1
	3-1/2"	2200 lbs.	CHI-080620	1
	4-1/2"	2200 lbs.	CHI-080651	1
	6"	2200 lbs.	CHI-080682	1
	8"	2200 lbs.	CHI-080712	1
<b>5/8</b>	10"	2200 lbs.	CHI-080743	1
	6"	3500 lbs.	CHI-080859	1
	10"	3500 lbs.	CHI-080910	1
	18"	3500 lbs.	CHI-081009	1
<b>3/4</b>	24"	3500 lbs.	CHI-081030	1
	6"	5200 lbs.	CHI-081115	1
	10"	5200 lbs.	CHI-081177	1
	18"	5200 lbs.	CHI-081269	1
	24"	5200 lbs.	CHI-081290	1

9

# MACHINERY LIFTING EYE BOLTS

Drop Forged Steel

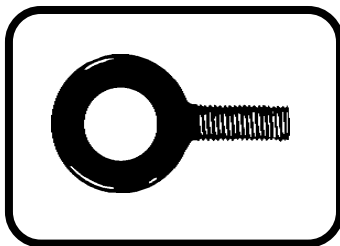

- » Heat treated after forging.
- » Self-colored.

Diameter	Length	Part #	Qty
1/4	1"	CHI-116053	1
5/16	1-1/8"	CHI-116251	1
3/8	1-1/4"	CHI-116459	1
7/16	1-3/8"	CHI-116657	1
1/2	1-1/2"	CHI-116855	1
9/16	1-5/8"	CHI-117050	1
5/8	1-3/4"	CHI-117258	1
3/4	2"	CHI-117487	1
7/8	2-1/4"	CHI-117685	1
1	2-1/2"	CHI-117883	1



# DROP FORGED TURNBUCKLES

## MARINE TYPE

Hot Dip Galvanized Steel

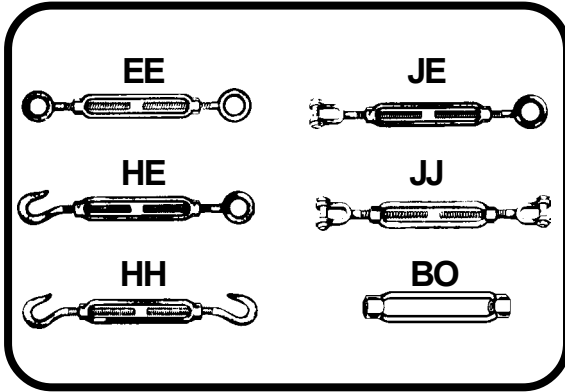

» Make sure to add:  
-EE, -HE, -HH, -JE, or -JJ to part numbers to indicate which type of turnbuckle you want.  
(Example: #TRBK-04-JJ would be 1/4" x 4" Jaw & Jaw)

» To order the body only add -BO to the part number.  
(Example: #TRBK-04-BO)

Thread Dia. & Take-Up Inches	Approximate Overall Length Closed, Inches	Part #*	Qty
1/4 x 4"	8"	TRBK-04	1
5/16 x 4-1/2"	9"	TRBK-05	1
3/8 x 6"	12"	TRBK-06	1
1/2 x 6"	13"	TRBK-07	1
1/2 x 9"	16"	TRBK-08	1
1/2 x 12"	19"	TRBK-09	1
5/8 x 6"	15-1/2"	TRBK-10	1
5/8 x 9"	18-1/2"	TRBK-11	1
5/8 x 12"	21-1/2"	TRBK-12	1
5/8 x 18"	28"	TRBK-13	1
3/4 x 6"	17"	TRBK-14	1
3/4 x 9"	20"	TRBK-15	1
3/4 x 12"	23"	TRBK-16	1
3/4 x 18"	29-3/4"	TRBK-17	1
7/8 x 12"	24-5/8"	TRBK-18	1
7/8 x 18"	33-1/4"	TRBK-19	1
1 x 6"	18"	TRBK-20	1
1 x 12"	24"	TRBK-21	1
1 x 18"	33-1/4"	TRBK-22	1

9

# YOKE ENDS

## DROP FORGED — ADJUSTABLE

Plain Finish

"T" Tap Size	A	B	C	D	E	F	G	H	K	Part #	Qty
1/4-28	2"	7/16	7/16	1-1/4	9/32	5/8	1/4	3/4	1/2	A10788	2
5/16-24	2-1/4	1/2	1/2	1-7/16	11/32	3/4	5/16	13/16	19/32	A10789	2
3/8-24	2-1/2	5/8	5/8	1-5/8	7/16	7/1	3/8	7/8	11/16	A10790	2
7/16-24	2-7/8	23/32	23/32	1-7/8	1/2	1"	7/16	1"	13/16	A10791	2
1/2-20	3"	13/16	13/16	1-7/8	9/16	1-1/8	1/2	1-1/8	15/16	A10792	2
5/8-18	4-15/16	1-1/16	1-1/16	3-11/16	11/16	1-3/8	5/8	1-1/4	1-3/16	A10793	2

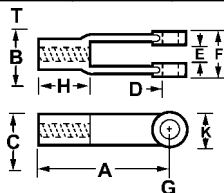

» Ideal for pivot-point linkages of shafts, rods, and other assemblies.

» Furnished with a clevis pin and a cotter pin.

# EYE BOLTS

## MACHINE THREAD OR LAG THREAD

Zinc Plated

### MACHINE THREAD

Dia.	Shank Length	Part #	Qty
3/16-24	1	C-1	10
	2	C-3	10
	2	C-3	10
1/4-20	1	E-1	10
	2	E-3	10
	3	E-5	10
	4	E-7	10
5/16-18	2	F-2	10
	3	F-4	10
	4	F-6	10
	5	F-7	10
3/8-16	2-1/2	G-3	10
	4	G-6	10
	6	G-8	10



### LAG THREAD

Dia.	Length	Part #	Qty
1/4	2-3/4	LS1	10
	4	LS2	10
5/16	2-3/4	LS3	10
	4-3/4	LS4	10
3/8	3	LS5	10
	6	LS6	10



### ACOUSTICAL LAG

Dia.	Length	Part #	Qty
1/4	3	03950	50

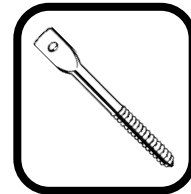

9

# MIDGET TURNBUCKLES

## EYE & EYE AND HOOK & EYE

Sand Cast Aluminum Bodies

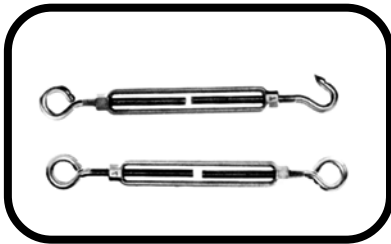

» Sand cast aluminum bodies with hex heads

» Zinc plated steel hooks or eyes.

Style	Diameter	Length	Part #	Qty
Eye & Eye	8-32	3-3/8	CHI-051057	1
Eye & Eye	10-24	4"	CHI-051088	1
Eye & Eye	12-24	4/12	CHI-051118	1
Eye & Eye	1/4-20	5-1/2	CHI-051149	1
Eye & Eye	5/16-18	6-3/4	CHI-051170	1
Eye & Eye	3/8-16	7-1/2	CHI-051200	1
Hook & Eye	10-24	4"	CHI-052085	1
Hook & Eye	1/4-20	5-1/2	CHI-052146	1
Hook & Eye	5/16-18	6-3/4	CHI-052177	1
Hook & Eye	3/8-16	7-1/2	CHI-052207	1

# U-BOLTS

## SQUARE BEND AND ROUND STYLE

Primarily used for leaf spring to axle attachment

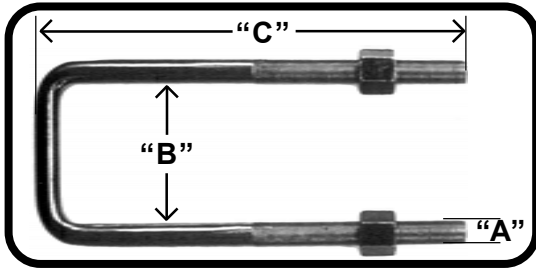

**Square Bend**

Dimensions (A x B x C)	Part #	Qty
1/2 x 1-3/4 x 6	UB-S132	1
1/2 x 2 x 6	UB-S134	1
1/2 x 2-5/8 x 1-1/2	UB-S139	1
9/16 x 2-1/2 x 8	UB-S146	1
9/16 x 2-5/8 x 8	UB-S148	1
9/16 x 3 x 11-3/4	UB-S155	1
5/8 x 2-5/8 x 12-1/4	UB-S162	1
5/8 x 3-1/8 x 7-3/4	UB-S170	1
5/8 x 4 x 11-1/4	UB-S178	1

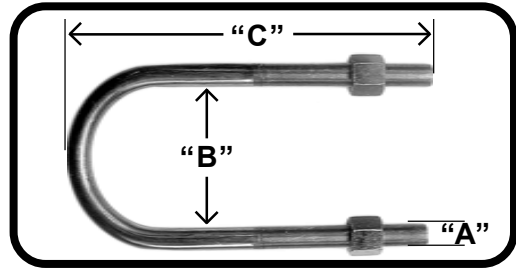

**Round Style**

Dimensions (A x B x C)	Part #	Qty
1/2 x 2-1/2 x 8-1/4	UB-R236	1
1/2 x 2-7/8 x 7	UB-R240	1
1/2 x 3 x 8	UB-R242	1
9/16 x 3 x 8-1/4	UB-R246	1
9/16 x 3-1/4 x 8	UB-R250	1
9/16 x 3-3/8 x 12	UB-R253	1
9/16 x 3-1/2 x 8	UB-R254	1
9/16 x 3-3/4 x 8	UB-R258	1
5/8 x 3 x 8-1/2	UB-R266	1
5/8 x 3-1/4 x 8-1/4	UB-R270	1

## ROUND BEND U-BOLTS

### FOR STEEL OR WROUGHT IRON PIPES

Zinc Plated

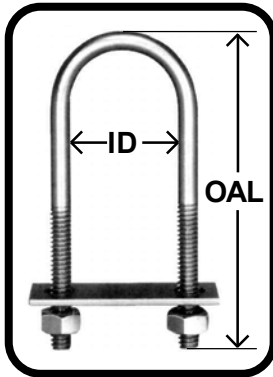

» Round bend U-bolts for steel or wrought iron pipe produced from low carbon steel and supplied with NC rolled threads, two hex nuts and U-bolt plate.

Diameter & Thread	I.D.	O.A.L	Trade Size	Part #	Qty
1/4-20	1	1-3/4	4	CHI-502146	1
1/4-20	1-1/8	2"	5	CHI-502207	1
1/4-20	1-1/8	3-1/8	5L	CHI-502238	1
1/4-20	1-1/2	2-3/4	7	CHI-502290	1
5/16-18	1-3/8	2-3/16	11	CHI-502443	1
5/16-18	1-3/8	3-5/8	11L	CHI-502474	1
5/16-18	1-3/4	2-11/16	13	CHI-502535	1
5/16-18	1-3/4	4-1/2	13L	CHI-502566	1
5/16-18	2"	2-11/16	14	CHI-502597	1
5/16-18	2"	4-3/4	14L	CHI-502627	1
5/16-18	2-1/2	3-3/16	15	CHI-502658	1
5/16-18	2-1/2	5-5/8	15L	CHI-502689	1
3/8-16	2-1/2	3-1/8	22	CHI-502894	1
3/8-16	3-1/2	4-1/8	24	CHI-502986	1

# BRACKETS

## CORNER BRACES

Zinc Plated

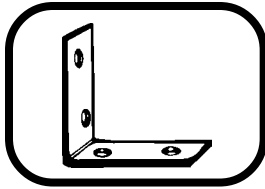

Leg Length	Width	Part #	Qty
1-1/2	5/8	NAT-113126	1
2"	5/8	NAT-113290	1
3"	3/4	NAT-113449	1

## FLAT CORNER BRACES

Zinc Plated

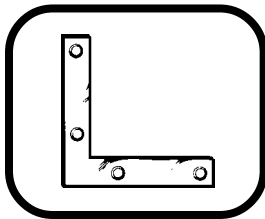

Leg Length	Width	Part #	Qty
1-1/2	3/8	NAT-113787	1
2	3/8	NAT-113837	1
2-1/2	1/2	NAT-113910	1
3	1/2	NAT-113951	1

## MENDING BRACES

Zinc Plated

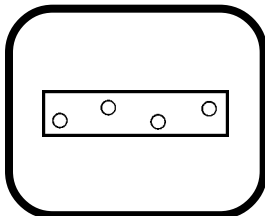

Length	Width	Part #	Qty
2"	1/2	NAT-114306	1
3"	5/8	NAT-114348	1
4"	5/8	NAT-114397	1
5"	5/8	NAT-114439	1

## SHELF BRACKETS

Gray Finish

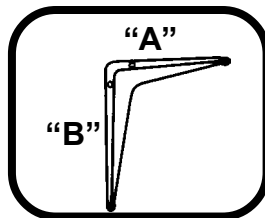

"A" Length	"B" Length	Part #	Qty
6"	8"	NAT-171066	1
8"	10"	NAT-171074	1
10"	12"	NAT-171082	1
12"	14"	NAT-172619	1

# STEEL STOCK

## ROUND, FLAT & ANGLE

Cold Rolled

### ROUND STOCK



Sold in 3 foot Lengths

Size	Part #
3/16	LAN-44093
1/4	LAN-44133
5/16	LAN-44143
3/8	LAN-44153
7/16	LAN-44163
1/2	LAN-44173
5/8	LAN-44193
3/4	LAN-44203

### FLAT STOCK



Sold in 3 foot Lengths

Size	Part #
3/4	LAN-25203
1"	LAN-25223
1-1/4	LAN-25243

« Galvanized  
« 14 Guage (.074" Thick)

### PERFORATED ANGLE STOCK

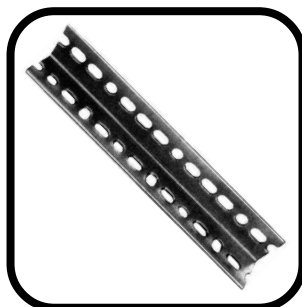

Sold in 4 foot Lengths

Size	Part #
1-1/2 x 1-1/2	LAN-29264

« Galvanized  
« 14 Guage (.074" Thick)

# MECHANICS WIRE

## 18 GAUGE & 16 GAUGE

Soft Annealed, Black Steel Wire

Size	Part #
<b>18 GAUGE</b>	
2 lb. spool	<b>A14205</b>
5 lb. spool	<b>A14207</b>
<b>16 GAUGE</b>	
2 lb. spool	<b>A14206</b>
5 lb. spool	<b>A14208</b>

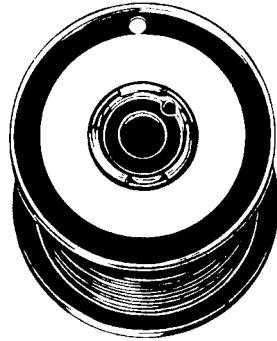

# PERFORATED HANGING STRAPING

Galvanized or Copper Plated

Size	Length	Type	Part #	Qty
24 ga	10 ft.	Galvanized	<b>WW-GAL</b>	1
24 ga	10 ft.	Copper	<b>WW-COP</b>	1



- » Safe-T-Edge hanger bar is convenient to use, speeds installation, reduces labor costs, requires less storage space and costs less per foot.
- » The Safe-T-Edge reduces accidents and because you buy in workable lengths, there are fewer waste ends.
- » Has 17/64" holes for 1/4" bolts.

# RUBBER HOLD DOWN STRAPS

## WITH HOOKS

(Bungie Cords)



Size	Span	Part #	Qty
9"	15 to 20	<b>RS-9B</b>	1
15"	20 to 30	<b>RS-15</b>	1
22"	30 to 40	<b>RS-22</b>	1
31"	40 to 55	<b>RS-31</b>	1
41"	47 to 76	<b>RS-41</b>	1

# “S” HOOKS

## FOR LIGHTING FIXTURES - CANVAS TIEDOWNS

Zinc Plated

Dia	Length	Part #	Qty
.080	1-1/16	S-1	100
.093	7/8	S-5	100
.105	1-3/32	S-2	100
.120	1-5/16	S-3	100
.120	2-1/8	S-7	50
.135	1-9/16	S-4	50
.148	2	S-9	50
.162	1-7/16	S-8	50
.177	2	S-6	25
.177	2-7/8	S-13	25
.188	2-7/8	S-10	25
.250	2-1/2	S-11	25
.312	2-5/8	S-12	25

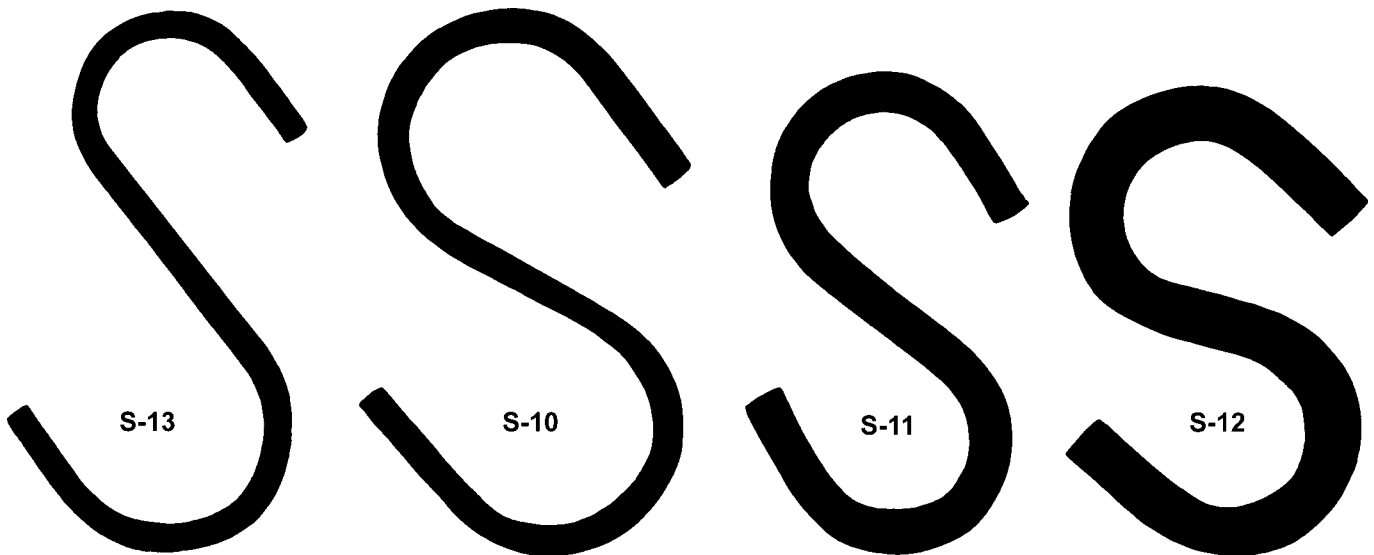
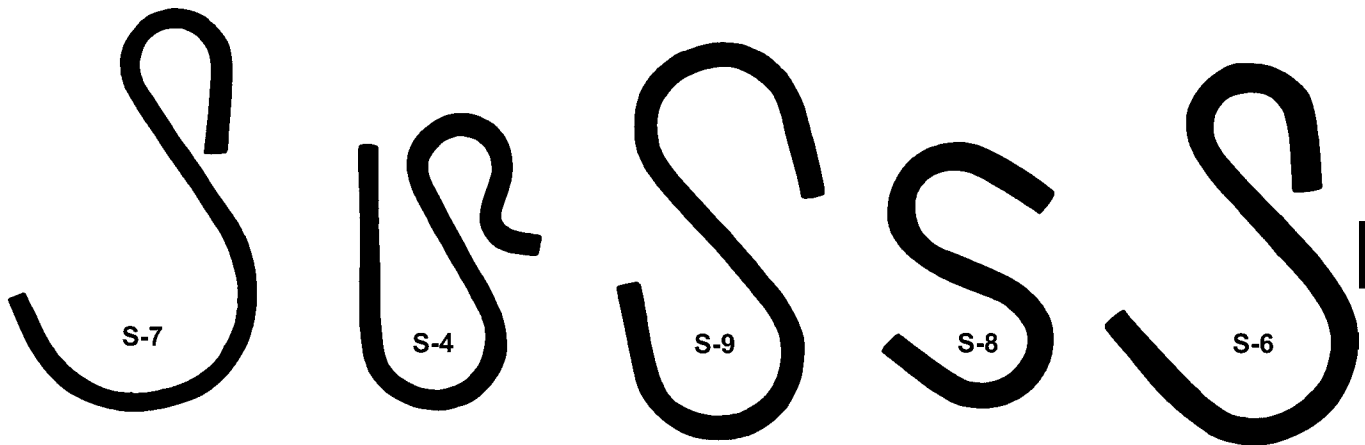
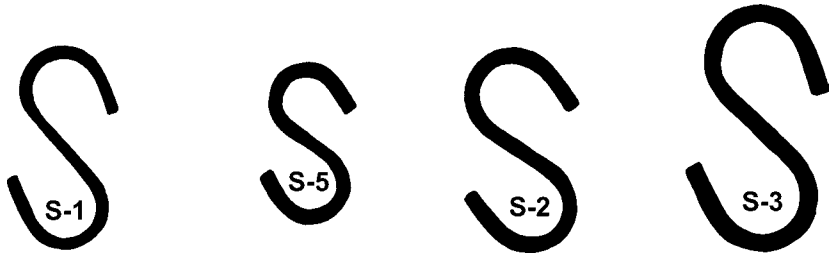

Pictures are Actual Size

# BOLT SNAPS & SPRING CLIPS



BAR-125



BAR-334



BAR-162



BAR-437

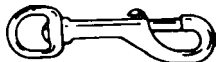

BAR-225

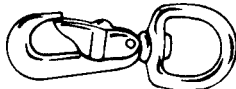

BAR-830



BAR-231  
BAR-232



BAR-2450



BAR-3142



BAR-5013



BAR-5025



BAR-5037



BAR-Z251

Description	Size	Part #	Qty
3/8 Swivel Decoy Snap	3/8	BAR-334-3/8	1
3/8 Open Swivel Snap	3/8	BAR-5037-3/8	1
3/8 Swivel Dog Lead Snap	3/8	BAR-437-3/8	1
1/4 Spring Hook	1/4	BAR-2450-1/4	1
5/16 Spring Hook	5/16	BAR-2450-5/16	1
3/8 Spring Hook	3/8	BAR-2450-3/8	1
5/8 Swivel Eye Snap	5/8	BAR-225-5/8	1
3/4 Swivel Eye Snap	3/4	BAR-225-3/4	1
1" Swivel Eye Snap	1"	BAR-225-1	1
1/2 Swivel Trigger Snap	1/2	BAR-5013-1/2	1
5/8 Round Eye Bolt Snap	5/8	BAR-125-5/8	1
1/2 Swivel Eye Leash Snap	1/2	BAR-5025-1/2	1
Double Pattern Chain	Medium	BAR-162	1
Open Eye Chain Snap	Small	BAR-231	1
Open Eye Chain Snap	Medium	BAR-232	1
3/4 Spring Swivel Snap	3/4	BAR-830-3/4	1
7/8 Swivel Eye Security Snap	7/8	BAR-3142	1
5/8 Swivel Eye Snap	5/8	BAR-Z251-5/8	1

9

# PULLEYS



BAR-0173



BAR-0174



BAR-0176



BAR-0178

Description	Size	Part #	Qty
Single Wheel Swivel Eye Pully	3/4	BAR-0173-3/4	1
Single Wheel Swivel Eye Pully	1"	BAR-0173-1	1
Single Wheel Swivel Eye Pully	1-1/2	BAR-0173-1-1/2	1
Single Wheel Swivel Eye Pully	2"	BAR-0173-2	1
Single Wheel Solid Eye Pully	3/4	BAR-0174-3/4	1
Single Wheel Solid Eye Pully	1"	BAR-0174-1	1
Single Wheel Solid Eye Pully	1-1/2	BAR-0174-1-1/2	1
Single Wheel Solid Eye Pully	2"	BAR-0174-2	1
Double Wheel Solid Eye Pully	3/4	BAR-0176-3/4	1
Double Wheel Solid Eye Pully	1"	BAR-0176-1	1
Double Wheel Swivel Eye Pully	3/4	BAR-0178-3/4	1
Double Wheel Swivel Eye Pully	1"	BAR-0178-1	1



# MALLEABLE BEVEL WASHERS

STANDARD PATTERN - SLOPE 2" IN 12" OR 9° 28'

PLATING: ZINC

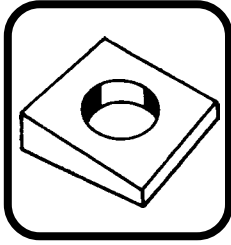

Bolt Size Inches	Diameter Across Washer	Hole Size Inches	Thickness Heavy End	Thickness Light End	Part #	Qty
1/4	11/16 x 11/16	5/16	7/32	5/64	00450	100
5/16	1 x 1	3/8	1/4	3/32	00451	100
3/8	1-1/4 x 1-1/4	7/16	11/32	5/32	00452	50
1/2	1-1/4 x 1-1/4	9/16	11/32	5/32	00453	50
5/8	1-1/2 x 1-1/2	11/16	13/32	5/32	00454	25
3/4	1-1/2 x 1-1/2	13/16	15/32	7/32	00455	25
7/8	2 x 2	15/16	9/16	7/32	00456	15
1	2 x 2	1-1/16	9/16	7/32	00457	10

## BOLT CUTTERS

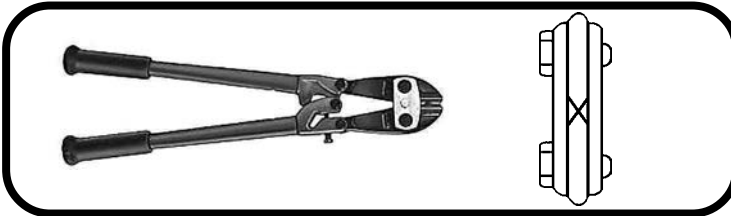

» For cutting reinforcing rods, medium tensile and soft bolts, rods, rivet bars and chain.

» Exceeds Federal Specification #GGG-C740d Type II.

Jaws	Length	Cutting Capacity	Part #	Qty
Center	18"	5/16"	BNT-821805	1
Center	24"	3/8"	BNT-821806	1



# Section 10: Electrical Accessories

## Table of Contents

### Non-Insulated Terminals

Butt Connectors .....	3
Ring Terminals .....	3
Spade Terminals .....	4
Quick Disconnects .....	4

### Vinyl Insulated Terminals

Butt Connectors .....	5
Y & X Connectors, 3-way & 4-way .....	5
Ring Terminals, 22-18 gauge thru 12-10 gauge .....	6
Ring Terminals, 8 gauge thru 4 gauge .....	7
Spade Terminals, <i>Standard</i> .....	8
Spade Terminals, <i>Flanged</i> .....	8
Hook Terminals .....	9
Quick Disconnects, <i>Fully Insulated</i> .....	9
Quick Disconnects, <i>Standard</i> .....	10
Bullet Connectors .....	10
T-Tap Connectors .....	11
Quick Splices .....	11
Push-On Terminal Adapters .....	11
Wire Nuts .....	12

### Nylon Insulated Terminals

Butt Connectors .....	13
Quick Disconnects, <i>Standard</i> .....	13
Pigtail Connectors .....	13
Ring Terminals .....	14
Spade Terminals, <i>Standard</i> .....	15
Spade Terminals, <i>Flanged</i> .....	15

### Krimp & Seal Terminals

22-18 Gauge .....	16
16-14 Gauge .....	16-17
12-10 Gauge .....	17

### Solder Sleeve Terminals

22-18 Gauge .....	18
16-14 Gauge .....	18
12-10 Gauge .....	18

<b>Crimping Tools</b> .....	19
-----------------------------	----

### Battery Accessories

Battery Terminals .....	20
Battery Bolts .....	20
Copper Battery Lugs .....	20
Battery Protectant .....	20

### Fuses & Accessories

Automotive Fuses .....	21
Fuse Taps .....	22
Fuse Holders .....	22

### Automotive Bulbs

Headlamps .....	23
Mini Bulbs .....	23-24

### Wire

Automotive Primary Wire .....	25
Mini Spool Assortment .....	25
Parallel Trailer Cable .....	26
Speaker Wire .....	26
Battery Cable .....	27

### Wire Protection & Routing

Wire Loom .....	27
Heat Shrink Tubing .....	28
Cable Ties .....	29-30
Cable Tie Mounts .....	31
Tubing Clamps .....	32-33
Rubber Grommets .....	34
Plug Buttons .....	35-37

### Electrical Accessories

Test Clips .....	37
Circuit Breakers .....	38
Flashers .....	38
Terminal Blocks .....	39
Trailer Connectors .....	40
Toggle Switches .....	41-42

# Section 10: Electrical Accessories (cont'd)

## Table of Contents

### Cords & Accesories

Extension Cords .....	43
Trouble Lights .....	43
Booster Cables .....	43
Trouble Light Replacement Parts .....	44
Extension Cord Ends .....	44
Cord Adapters .....	44
Surge Protector Power Strip .....	44
Rough Service Light Bulbs .....	44

### Flashlights & Accesories

Heavy Duty Flashlights .....	45
Alkaline Batteries .....	45
Keyless Entry Batteries.....	45
Mag-Lite™ Flashlights .....	46

### Faskit Assortments .....

	47
--	----

# SOLDERLESS TERMINALS

**NON-INSULATED**  
Butt Connectors & Ring Terminals



Made in U.S.A

<p>Butt Connectors</p> <p><b>22-18</b> GAUGE WIRE RANGE</p>					<p>D121005</p>		
<p>Butt Connectors</p> <p><b>16-14</b> GAUGE WIRE RANGE</p>					<p>D122005</p>		
<p>Butt Connectors</p> <p><b>12-10</b> GAUGE WIRE RANGE</p>					<p>D123005</p>		
<p>Ring Terminals</p> <p><b>22-18</b> GAUGE WIRE RANGE</p>	<p>6</p>	<p>8</p>	<p>Stud Size</p>	<p>10</p>	<p>1/4</p>		
	<p>D151065</p>	<p>D151085</p>		<p>D151105</p>	<p>D151145</p>		
<p>Ring Terminals</p> <p><b>16-14</b> GAUGE WIRE RANGE</p>	<p>6</p>	<p>8</p>	<p>10</p>	<p>1/4</p>	<p>5/16</p>	<p>3/8</p>	
	<p>D152065</p>	<p>D152085</p>	<p>D152105</p>	<p>D152145</p>	<p>D152565</p>	<p>D152385</p>	
<p>Ring Terminals</p> <p><b>12-10</b> GAUGE WIRE RANGE</p>	<p>6</p>	<p>8</p>	<p>10</p>	<p>1/4</p>	<p>5/16</p>	<p>3/8</p>	<p>1/2</p>
	<p>D153065</p>	<p>D153085</p>	<p>D153105</p>	<p>D153145</p>	<p>D153565</p>	<p>D153385</p>	<p>D153125</p>

10















# SOLDERLESS TERMINALS

## NON-INSULATED

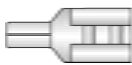
Spade Terminals & Quick Disconnects

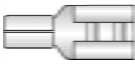

Made in U.S.A

<p>Spade Terminals</p> <p><b>22-18</b> GAUGE WIRE RANGE</p>	<p>6</p>  <p>D161065</p>	<p>Stud Size 8</p>  <p>D161085</p>	<p>10</p>  <p>D161105</p>
<p>Spade Terminals</p> <p><b>16-14</b> GAUGE WIRE RANGE</p>	<p>6</p>  <p>D162065</p>	<p>Stud Size 8</p>  <p>D162085</p>	<p>10</p>  <p>D162105</p>
<p>Spade Terminals</p> <p><b>12-10</b> GAUGE WIRE RANGE</p>	<p>6</p>  <p>D163065</p>	<p>Stud Size 8</p>  <p>D163085</p>	<p>10</p>  <p>D163105</p>
<p>Quick Disconnects</p> <p><b>22-18</b> GAUGE WIRE RANGE</p>	<p>Female</p>  <p>D191005</p>	<p>Male</p>  <p>D131005</p>	
<p>Quick Disconnects</p> <p><b>16-14</b> GAUGE WIRE RANGE</p>	 <p>D192005</p>	 <p>D132005</p>	
<p>Quick Disconnects</p> <p><b>12-10</b> GAUGE WIRE RANGE</p>	 <p>D193005</p>	 <p>D133005</p>	

10







# SOLDERLESS TERMINALS

## VINYL INSULATED

Butt Connectors & X and Y Connectors

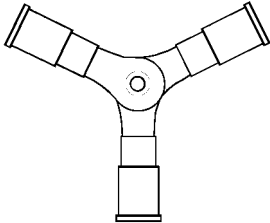
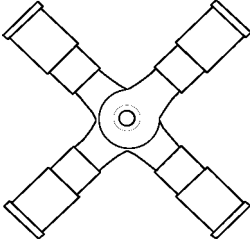

Made in U.S.A

<p><b>Red</b> Butt Connectors</p> <p><b>22-18</b> GAUGE WIRE RANGE</p>	 <p>D421005</p>	<p><b>Red</b> Butt Connectors</p> <p><b>8</b> GAUGE WIRE RANGE</p>	 <p>D424005</p>
<p><b>Blue</b> Butt Connectors</p> <p><b>16-14</b> GAUGE WIRE RANGE</p>	 <p>D422005</p>	<p><b>Blue</b> Butt Connectors</p> <p><b>6</b> GAUGE WIRE RANGE</p>	 <p>D425005</p>
<p><b>Yellow</b> Butt Connectors</p> <p><b>12-10</b> GAUGE WIRE RANGE</p>	 <p>D423005</p>	<p><b>Yellow</b> Butt Connectors</p> <p><b>4</b> GAUGE WIRE RANGE</p>	 <p>D426005</p>
<p><b>Blue</b> Y Connector</p> <p><b>16-14</b> GAUGE WIRE RANGE</p>	 <p>D411205</p>	<p><b>Blue</b> X Connector</p> <p><b>16-14</b> GAUGE WIRE RANGE</p>	 <p>D410205</p>

# SOLDERLESS TERMINALS

VINYL INSULATED  
Ring Terminals



	Stud Size							
<b>Red</b> <hr/> Ring Terminals <hr/> <b>22-18</b> GAUGE WIRE RANGE	4	6	8	10	1/4"	5/16"		
	D451045	D451065	D451085	D451105	D451145	D451145	D451565	
	<hr/>							
	<b>Blue</b> <hr/> Ring Terminals <hr/> <b>16-14</b> GAUGE WIRE RANGE	4	6	8	10	1/4"	5/16"	3/8"
		D452045	D452065	D452085	D452105	D452145	D452565	D452385
<hr/>								
<b>Yellow</b> <hr/> Ring Terminals <hr/> <b>12-10</b> GAUGE WIRE RANGE		6	8	10	1/4"	5/16"	3/8"	1/2"
		D453065	D453085	D453105	D453145	D453565	D453385	D453125

10



# SOLDERLESS TERMINALS

## VINYL INSULATED

Ring Terminals



Made in U.S.A

	Stud Size						
<b>Red</b> <hr/> Ring Terminals  <b>8</b> GAUGE WIRE RANGE	8	10	1/4"	5/16"	3/8"	1/2"	
	D454085	D454105	D454145	D454565	D454385	D454125	
	<hr/>						
	<b>Blue</b> <hr/> Ring Terminals  <b>6</b> GAUGE WIRE RANGE	10	1/4"	5/16"	3/8"	1/2"	
		D455105	D455145	D455565	D455385	D455125	
<hr/>							
<b>Yellow</b> <hr/> Ring Terminals  <b>4</b> GAUGE WIRE RANGE		1/4"	5/16"	3/8"	1/2"		
	D456145	D456565	D456385	D456125			

10

# SOLDERLESS TERMINALS

VINYL INSULATED  
Flanged Spade & Hook Terminal



Made in U.S.A

Stud Size

**Red**  
Spade Terminals  
**22-18**  
GAUGE  
WIRE RANGE

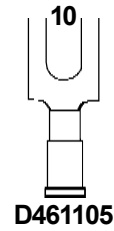
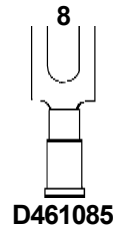
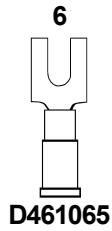

**Blue**  
Spade Terminals  
**16-14**  
GAUGE  
WIRE RANGE

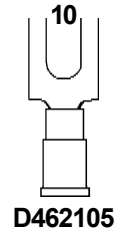
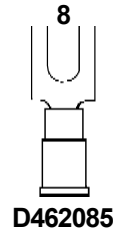
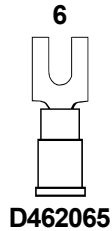

**Yellow**  
Spade Terminals  
**12-10**  
GAUGE  
WIRE RANGE

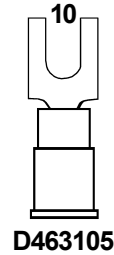
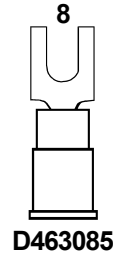
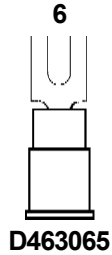

**Red**  
Flanged Spade  
Terminals  
**22-18**  
GAUGE  
WIRE RANGE

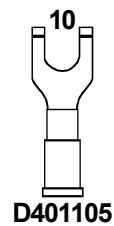
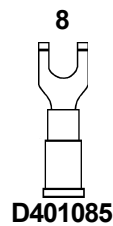
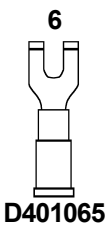

**Blue**  
Flanged Spade  
Terminals  
**16-14**  
GAUGE  
WIRE RANGE

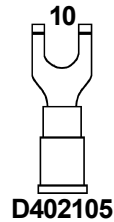
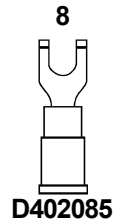
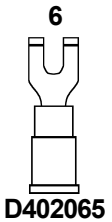

**Yellow**  
Flanged Spade  
Terminals  
**12-10**  
GAUGE  
WIRE RANGE

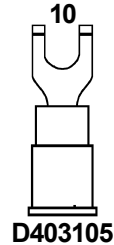
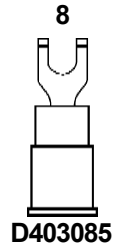
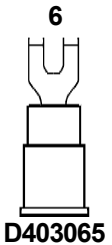

10

# SOLDERLESS TERMINALS

VINYL INSULATED  
Spade Terminal & Quick Disconnects



Made in U.S.A

<p><b>Red</b> Hook Terminals</p> <p><b>22-18</b> GAUGE WIRE RANGE</p>	Stud Size		10		D471105
<p><b>Blue</b> Hook Terminals</p> <p><b>16-14</b> GAUGE WIRE RANGE</p>			10		D472105
<p><b>Yellow</b> Hook Terminals</p> <p><b>12-10</b> GAUGE WIRE RANGE</p>			10		D473105
<p><b>Red</b> Quick Disconnects</p> <p><b>22-18</b> GAUGE WIRE RANGE</p>	Male	Female			
	D630005	D690005			
<p><b>Blue</b> Quick Disconnects</p> <p><b>16-14</b> GAUGE WIRE RANGE</p>					
	D634005	D694005			
<p><b>Yellow</b> Quick Disconnects</p> <p><b>12-10</b> GAUGE WIRE RANGE</p>					
	D635005	D695005			

10











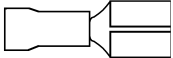

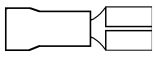
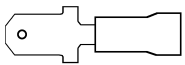
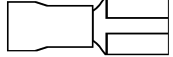

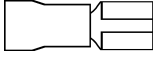
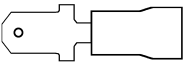

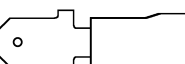

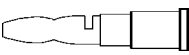
# SOLDERLESS TERMINALS

## VINYL INSULATED

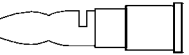
Push-on Terminals & Bullet Connectors

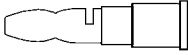

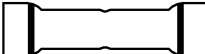
Made in U.S.A

<p><b>Red</b> Quick Disconnects <b>22-18</b> GAUGE WIRE RANGE</p>	<p><b>.250" Tab Width</b> Female Male  <b>D491005</b>  <b>D431005</b></p>		<p><b>.187" Tab Width</b> Female Male  <b>D491705</b>  <b>D431705</b></p>	
<p><b>Blue</b> Quick Disconnects <b>16-14</b> GAUGE WIRE RANGE</p>	<p><b>.250" Tab Width</b> Female Male  <b>D492005</b>  <b>D432005</b></p>		<p><b>.187" Tab Width</b> Female Male  <b>D492705</b>  <b>D432705</b></p>	
<p><b>Yellow</b> Quick Disconnects <b>12-10</b> GAUGE WIRE RANGE</p>	<p><b>.250" Tab Width</b> Female Male  <b>D493005</b>  <b>D433005</b></p>			
<p><b>Red</b> Bullet Connectors <b>22-18</b> GAUGE WIRE RANGE</p>	<p><b>.156" Standard Barrell Width</b> Female Male  <b>D800725</b>  <b>D441205</b></p>		<p><b>.180" Ford Barrell Width</b> Female Male  <b>D800925</b>  <b>D441405</b></p>	
<p><b>Blue</b> Bullet Connectors <b>16-14</b> GAUGE WIRE RANGE</p>	<p><b>.156" Standard Barrell Width</b> Female Male  <b>D800735</b>  <b>D442205</b></p>		<p><b>.180" Ford Barrell Width</b> Female Male  <b>D800935</b>  <b>D442405</b></p>	
<p><b>3-Way</b> Bullet Connectors <b>.156"</b> STANDARD BARRELL WIDTH</p>	<p><b>3-Way</b>  <b>D449005</b></p>			
<p><b>2-Way</b> Bullet Connectors <b>.156"</b> STANDARD BARRELL WIDTH</p>	<p><b>Clear</b>  <b>D829005</b></p>	<p><b>2-Way</b> Bullet Connectors <b>.180"</b> FORD BARRELL WIDTH</p>	<p><b>Green</b>  <b>D800295</b></p>	

10







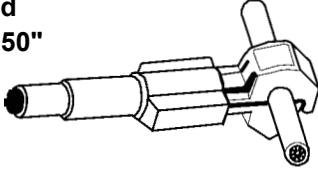

# SOLDERLESS TERMINALS

## NYLON INSULATED

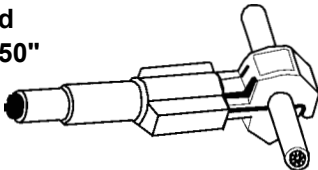
T-Tap Connectors, Quick Splices & Push-on Terminal Adapters

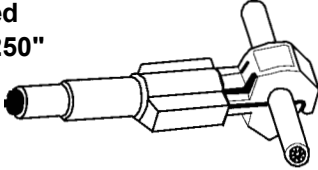
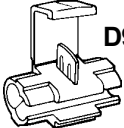
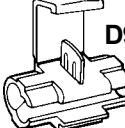
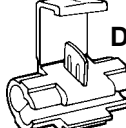
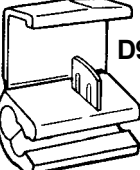

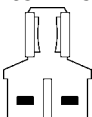
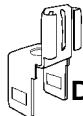
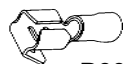
Made in U.S.A.

<p><b>Red</b> T-Tap Connectors <b>22-18</b> GAUGE WIRE RANGE</p>		<p><b>.250" Tab Width</b>  D908065</p>	<p>UL-CSA Listed Mates with .250" Male Blades</p> 		
<p><b>Blue</b> T-Tap Connectors <b>16-14</b> GAUGE WIRE RANGE</p>		<p><b>.250" Tab Width</b>  D908075</p>	<p>UL-CSA Listed Mates with .250" Male Blades</p> 		
<p><b>Yellow</b> T-Tap Connectors <b>12-10</b> GAUGE WIRE RANGE</p>		<p><b>.250" Tab Width</b>  D908085</p>	<p>UL-CSA Listed Mates with .250" Male Blades</p> 		
<p><b>Red</b> Quick Splices <b>22-18</b> GAUGE WIRE RANGE</p>	<p><b>Closed Port</b>  D905585</p>	<p><b>White</b> Quick Splices <b>18-14</b> GAUGE WIRE RANGE</p>	<p><b>Open Port</b>  D905655</p>	<p><b>Blue</b> Quick Splices <b>18-14</b> GAUGE WIRE RANGE</p>	<p><b>Closed Port</b>  D905595</p>
<p><b>Yellow</b> Quick Splices <b>12-10</b> GAUGE WIRE RANGE</p>	 D905625	<p><b>Brown</b> Quick Splices <b>Connects</b> 18-4 to 12-10 GAUGE</p>	 D905615		
<p><b>Male Adapter</b> Push-On Terminal Adapters <b>.250"</b> TAB WIDTH</p>	<p><b>No.8 Stud</b>  D900605</p>	<p><b>3-Way Adapter</b> Push-On Terminal Adapters <b>.250"</b> TAB WIDTH</p>	<p><b>One Female to Two Males</b>  D900615</p>	<p><b>Chair Adapter</b> Push-On Terminal Adapters <b>.250"</b> TAB WIDTH</p>	<p><b>One Female to Two Males</b>  D900625</p>
<p><b>Red</b> Push-On Terminal Adapters <b>22-18</b> GAUGE WIRE RANGE</p>	<p><b>Single Male</b> <b>Single Female</b>  D900665</p>	<p><b>Blue</b> Push-On Terminal Adapters <b>16-14</b> GAUGE WIRE RANGE</p>	<p><b>Single Male</b> <b>Single Female</b>  D900675</p>		

# WIRE NUT® CONNECTORS

## HARD PLASTIC

Gray, Blue, Red Yellow and Orange



Made in U.S.A

### Gray

Wire Nut®  
Connectors

JOINS  
**18 & 16**  
GAUGE WIRES

Min. of (2) 18 Gauge Wires  
Max. of (2) 6 Gauge Wires

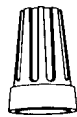

D901435

### Blue

Wire Nut®  
Connectors

JOINS  
**18 - 14**  
GAUGE WIRES

Min. of (2) 18 Gauge Wires  
Max. of (3) 6 Gauge Wires

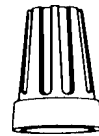

D901445

### Orange

Wire Nut®  
Connectors

JOINS  
**18 & 16**  
GAUGE WIRES

Min. of (2) 18 Gauge Wires  
Max. of (2) 6 Gauge Wires  
& (1) 18 Gauge Wire

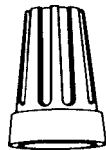

D901455

### Yellow

Wire Nut®  
Connectors

JOINS  
**18 - 12**  
GAUGE WIRES

Min. of (1) 14 Gauge Wire  
& (1) 18 Gauge Wire  
Max. of (2) 14 Gauge Wires  
& (3) 16 Gauge Wires

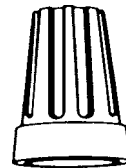

D901465

### Red

Wire Nut®  
Connectors

JOINS  
**18 - 12**  
GAUGE WIRES

Min. of (1) 12 Gauge Wire  
& (2) 18 Gauge Wires  
Max. of (2) 10 Gauge Wires  
& (1) 12 Gauge Wire

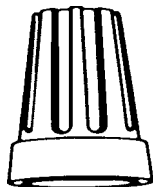

D901475

### Gray

Wire Nut®  
Connectors

JOINS  
**14 - 8**  
GAUGE WIRES

Min. of (3) 12 Gauge Wires  
Max. of (4) 10 Gauge Wires

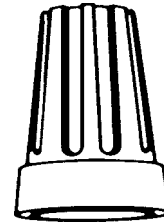

D901485

# SOLDERLESS TERMINALS

## NYLON INSULATED

Butt Connectors, Push-on Terminals and Closed End Connectors



Made in U.S.A

<p><b>Red</b> Butt Connectors <b>22-18</b> GAUGE WIRE RANGE</p>			<p>D821005</p>		
<p><b>Blue</b> Butt Connectors <b>16-14</b> GAUGE WIRE RANGE</p>			<p>D822005</p>		
<p><b>Yellow</b> Butt Connectors <b>12-10</b> GAUGE WIRE RANGE</p>			<p>D823005</p>		
<p><b>Red</b> Push-on Terminals <b>22-18</b> GAUGE WIRE RANGE</p>	<p><b>.250" Tab Width</b></p>	<p><b>.187" Tab Width</b></p>			
	<p>Female</p>	<p>Male</p>	<p>Female</p>	<p>Male</p>	
	<p>D891005</p>	<p>D831005</p>	<p>D891705</p>	<p>D831705</p>	
<p><b>Blue</b> Push-on Terminals <b>16-14</b> GAUGE WIRE RANGE</p>	<p><b>.250" Tab Width</b></p>	<p><b>.187" Tab Width</b></p>			
	<p>Female</p>	<p>Male</p>	<p>Female</p>	<p>Male</p>	
	<p>D892005</p>	<p>D832005</p>	<p>D892705</p>	<p>D832705</p>	
<p><b>Yellow</b> Push-on Terminals <b>12-10</b> GAUGE WIRE RANGE</p>	<p><b>.250" Tab Width</b></p>				
	<p>Female</p>	<p>Male</p>			
	<p>D893005</p>	<p>D833005</p>			
<p><b>White</b> Closed End Connectors <b>22-18</b> GAUGE WIRE RANGE</p>		<p><b>White</b> Closed End Connectors <b>16-14</b> GAUGE WIRE RANGE</p>		<p><b>White</b> Closed End Connectors <b>12-10</b> GAUGE WIRE RANGE</p>	
	<p>D901205</p>		<p>D901215</p>		<p>D901225</p>

# SOLDERLESS TERMINALS

## NYLON INSULATED

Ring Terminals



Made in U.S.A

	Stud Size							
<b>Red</b> <hr/> Ring Terminals  <b>22-18</b> GAUGE WIRE RANGE	4	6	8	10	1/4"	5/16"		
	D851045	D851065	D851085	D851105	D851145	D851145	D851565	
	<hr/>							
	<b>Blue</b> <hr/> Ring Terminals  <b>16-14</b> GAUGE WIRE RANGE	4	6	8	10	1/4"	5/16"	3/8"
		D852045	D852065	D852085	D852105	D852145	D852565	D852385
<hr/>								
<b>Yellow</b> <hr/> Ring Terminals  <b>12-10</b> GAUGE WIRE RANGE		6	8	10	1/4"	5/16"	3/8"	1/2"
		D853065	D853085	D853105	D853145	D853565	D853385	D853125

10



# SOLDERLESS TERMINALS

**NYLON INSULATED**  
Spade & Flanged Spade Terminal



Made in U.S.A

	Stud Size		
	6	8	10
<p><b>Red</b> Spade Terminals</p> <p><b>22-18</b> GAUGE WIRE RANGE</p>	 D861065	 D861085	 D861105
<p><b>Blue</b> Spade Terminals</p> <p><b>16-14</b> GAUGE WIRE RANGE</p>	 D862065	 D862085	 D862105
<p><b>Yellow</b> Spade Terminals</p> <p><b>12-10</b> GAUGE WIRE RANGE</p>	 D863065	 D863085	 D863105
<p><b>Red</b> Flanged Spade Terminals</p> <p><b>22-18</b> GAUGE WIRE RANGE</p>	 D801065	 D801085	 D801105
<p><b>Blue</b> Flanged Spade Terminals</p> <p><b>16-14</b> GAUGE WIRE RANGE</p>	 D802065	 D802085	 D802105
<p><b>Yellow</b> Flanged Spade Terminals</p> <p><b>12-10</b> GAUGE WIRE RANGE</p>	 D803065	 D803085	 D803105

10

# SOLDERLESS TERMINALS

## KRIMP & SEAL TERMINALS

Ring Terminals, Spade Terminals, Butt Connectors & Fully Insulated Disconnects



Made in U.S.A



- » Sarjo Krimp & Seal Terminals are fabricated from top of the line materials and the highest quality cross linked polyolefin shrink tubing available on the market today. Our terminals have unlimited storage life and are insensitive to temperature changes.
- » Easy and accurate placement of wire ends into insulated transparent tubing virtually eliminates bad connections.
- » Special tubing, when heated, shrinks with a 3:1 ratio to completely seal the entire connection, making penetration by any foreign material impossible.
- » Single unit connectors save valuable time and reduce stress and abrasion. No taping.
- » Best of all, Sarjo Krimp & Seal Terminals are simple to use:
  1. Place stripped wire ends into connector
  2. Crimp wire ends in connector with crimping unit.
  3. Rotate connector over heat (approximately 300-600°F) until tubing shrinks around center.
  4. Cool.

**Red**  
Ring Terminals

**22-18  
GAUGE  
WIRE RANGE**

Stud Size

6                      10

D951065                      D951105

**Red**  
Spade Terminals

**22-18  
GAUGE  
WIRE RANGE**

Stud Size  
10



D961105

**Red**  
Butt Connectors

**22-18  
GAUGE  
WIRE RANGE**





D921005

**Red**  
Fully Insulated  
Disconnects

**22-18  
GAUGE  
WIRE RANGE**

.250" Tab Width

Female                      Male

D964005                      D964105

**Blue**  
Ring Terminals

**16-14  
GAUGE  
WIRE RANGE**

Stud Size

6                      10                      1/4"                      5/16"                      3/8"







D952065                      D952105                      D952145                      D952565                      D952385

**Blue**  
Spade Terminals

**16-14  
GAUGE  
WIRE RANGE**

Stud Size  
10



D962105

**Blue**  
Butt Connectors

**16-14  
GAUGE  
WIRE RANGE**



D922005

10













# SOLDERLESS TERMINALS

## KRIMP & SEAL TERMINALS

Ring Terminals, Spade Terminals, Butt Connectors, Bullet Connectors, Quick Disconnects and Fully Insulated Disconnects

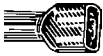

Made in U.S.A

<p><b>Blue</b> Bullet Connectors</p> <p><b>16-14</b> GAUGE WIRE RANGE</p>	<p><b>.157" Barrell Width</b></p> <p><b>Female</b>      <b>Male</b></p>   <p>D961005      D962005</p>		<p><b>Blue</b> Quick Disconnects</p> <p><b>16-14</b> GAUGE WIRE RANGE</p>	<p><b>.250" Tab Width</b></p> <p><b>Female</b>      <b>Male</b></p>   <p>D992005      D932005</p>	
<p><b>Blue</b> Fully Insulated Disconnects</p> <p><b>16-14</b> GAUGE WIRE RANGE</p>	<p><b>.250" Tab Width</b></p> <p><b>Female</b>      <b>Male</b></p>   <p>D964205      D964305</p>				
<p><b>Yellow</b> Ring Terminals</p> <p><b>12-10</b> GAUGE WIRE RANGE</p>	<p><b>Stud Size</b></p> <p><b>10</b>      <b>1/4"</b>      <b>3/8"</b></p>    <p>D953105      D953145      D953385</p>			<p><b>Yellow</b> Spade Terminals</p> <p><b>12-10</b> GAUGE WIRE RANGE</p>	<p><b>Stud Size</b> <b>10</b></p>  <p>D963105</p>
<p><b>Yellow</b> Butt Connectors</p> <p><b>12-10</b> GAUGE WIRE RANGE</p>	 <p>D923005</p>		<p><b>Yellow</b> Fully Insulated Disconnects</p> <p><b>12-10</b> GAUGE WIRE RANGE</p>	<p><b>.250" Tab Width</b></p> <p><b>Female</b>      <b>Male</b></p>   <p>D964405      D964505</p>	

10













# SOLDER SLEEVE TERMINAL

## TERMINAL WITH SOLDER AND HEAT SHRINK

Ring Terminals, Spade Terminals, Butt Connectors and Quick Disconnects



Made in U.S.A

<p><b>Red</b> Ring Terminals</p> <p><b>22-18</b> GAUGE WIRE RANGE</p>	<p>Stud Size</p> <p>8                      10</p>  <p>D966415              D966425</p>	<p><b>Red</b> Spade Terminals</p> <p><b>22-18</b> GAUGE WIRE RANGE</p>	<p>Stud Size</p> <p>10</p>  <p>D966645</p>
<p><b>Red</b> Butt Connectors</p> <p><b>22-18</b> GAUGE WIRE RANGE</p>	 <p>D966615</p>	<p><b>Red</b> Quick Disconnects</p> <p><b>22-18</b> GAUGE WIRE RANGE</p>	<p>.250" Barrell Width</p> <p>Female              Male</p>  <p>D966815              D966725</p>
<p><b>Blue</b> Ring Terminals</p> <p><b>16-14</b> GAUGE WIRE RANGE</p>	<p>Stud Size</p> <p>10              1/4"              3/8"</p>  <p>D966485              D966495              D966515</p>	<p><b>Blue</b> Spade Terminals</p> <p><b>16-14</b> GAUGE WIRE RANGE</p>	<p>Stud Size</p> <p>10</p>  <p>D966655</p>
<p><b>Blue</b> Butt Connectors</p> <p><b>16-14</b> GAUGE WIRE RANGE</p>	 <p>D966625</p>	<p><b>Blue</b> Quick Disconnects</p> <p><b>16-14</b> GAUGE WIRE RANGE</p>	<p>.250" Barrell Width</p> <p>Female              Male</p>  <p>D966835              D966745</p>
<p><b>Yellow</b> Ring Terminals</p> <p><b>12-10</b> GAUGE WIRE RANGE</p>	<p>Stud Size</p> <p>10              1/4"              3/8"</p>  <p>D966525              D966535              D966555</p>	<p><b>Yellow</b> Spade Terminals</p> <p><b>12-10</b> GAUGE WIRE RANGE</p>	<p>Stud Size</p> <p>10</p>  <p>D966665</p>
<p><b>Yellow</b> Butt Connectors</p> <p><b>12-10</b> GAUGE WIRE RANGE</p>	 <p>D966635</p>	<p><b>Yellow</b> Fully Insulated Disconnects</p> <p><b>12-10</b> GAUGE WIRE RANGE</p>	<p>.250" Tab Width</p> <p>Female              Male</p>  <p>D966855              D966765</p>

10

# CRIMPING TOOLS

## UPFRONT, SNUB NOSE & ECONO CRIMPER AND AUTOMATIC STRIPPER



**H-20601**



**H-20602**



**H-20603**



**H-20604**

Description	Length	Weight	Gauge	Part #	Qty
Upfront Crimper	8.25"	.72 lbs.	22-10	H-20601	1
Snub Nose Crimper	7.5"	.66 lbs.	22-10	H-20602	1
Econo Crimper	7.5"	.66 lbs.	22-10	H-20603	1
Automatic Stripper	8"	.66 lbs.	26-10	H-20604	1

# BATTERY ACCESSORIES

## BATTERY TERMINALS

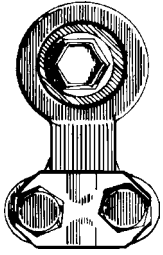

BAT110-7

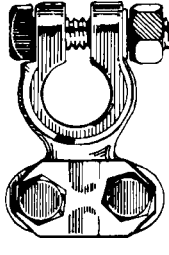

BAT105-10

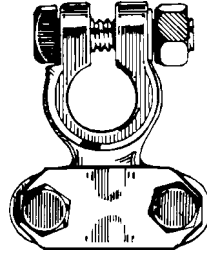

BAT100-10

Description	Part #	Qty
Side Mount	BAT110-7	7
Top Mount	BAT105-10	10
HD Top Mount	BAT100-10	10

» Sold by the card only.

## BATTERY BOLTS, NUTS & ADAPTERS

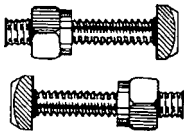

BAT115

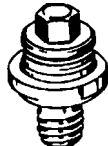

BAT120



BAT125

Description	Part #	Qty
5/16-18 x 1-1/2 Battery Bolt w/Nut	BAT115	25
3/8-16 Side Terminal Bolt	BAT120	10
Side Terminal Adapter Bolt	BAT125	10

## COPPER BATTERY LUGS

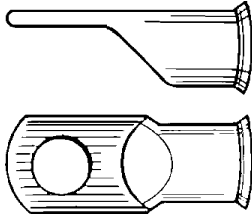

Gauge	Part # (Hole Size)				Qty
	1/4	5/16	3/8	1/2	
6	BAT130	BAT135	BAT140	—	25
4	BAT130A	BAT135A	BAT140A	—	25
2	BAT145	BAT150	BAT155	BAT160	25
1	—	BAT165	BAT170	BAT175	25
1/0	—	BAT180	BAT185	BAT190	10
2/0	—	—	BAT195	BAT200	10
3/0	—	—	BAT205	BAT210	10
4/0	—	—	BAT215	BAT220	10

- » Made from seamless copper tube.
- » Ideal for general wiring, starter or ground connections.

## BATTERY PROTECTION



Battery Protector

Description	Part #	Qty
Master Battery Protector - Aerosol	CHE135	1-6 oz. can
Master Battery Protector - Aerosol	CHE135CS	Case of 12-6 oz. cans

- » Master Battery Protector seals battery terminals with a long-lasting protective film. Eliminates corrosion and extends battery life.

# FUSES

## Glass Tube Fuses

» Box contains 5 fuses.



Amp Rating	Part #	Qty
1	AGC1	1 box
2	AGC2	1 box
3	AGC3	1 box
5	AGC5	1 box
7.5	AGC7-1/2	1 box
10	AGC10	1 box
15	AGC15	1 box
20	AGC20	1 box
25	AGC25	1 box
30	AGC30	1 box
35	AGC35	1 box
14	SFE14	1 box
20	SFE20	1 box
30	SFE30	1 box

## Maxi™ Fuses

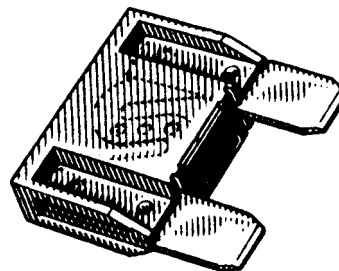

Amp Rating	Color	Part #	Qty
20	Yellow	MAX20	1
30	Green	MAX30	1
40	Orange	MAX40	1
50	Red	MAX50	1
60	Blue	MAX60	1

## ATC-Blade Fuses

» Box contains 5 fuses.

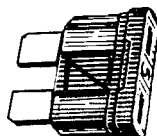

Amp Rating	Color	Part #	Qty
3	Violet	ATC3	1 box
5	Tan	ATC5	1 box
7.5	Brown	ATC7-1/2	1 box
10	Red	ATC10	1 box
15	Blue	ATC15	1 box
20	Yellow	ATC20	1 box
25	Clear	ATC25	1 box
30	Green	ATC30	1 box

## Mini™ Fuses

» Box contains 5 fuses.



Amp Rating	Color	Part #	Qty
2	Gray	ATM2	1 box
3	Purple	ATM3	1 box
4	Pink	ATM4	1 box
5	Tan	ATM5	1 box
7.5	Brown	ATM7-1/2	1 box
10	Red	ATM10	1 box
15	Blue	ATM15	1 box
20	Yellow	ATM20	1 box
25	White	ATM25	1 box
30	Green	ATM30	1 box

# FUSE ACCESSORIES

## AGC Fuse Tap-in

- » Insert 1/4" female tab over AGC fuse tap-in.
- » Makes for quick connect or disconnect.

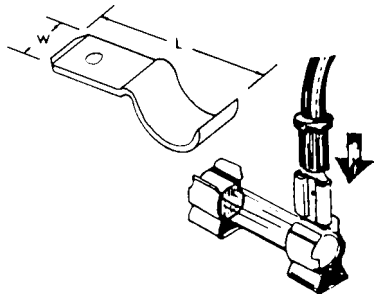

W Tab Width	Tab Thickness	L Length	Part #	Qty
.250	.030	.250	D79785	1

## Self-Stripping Fuseholder

- » Mates with most plug-in, ATC blade type fuses found in late-model domestic and some import cars.
- » For 18-14 gauge copper wire
- » 32 volts max, 20 amp max with 14 gauge wire.
- » 10 amp max with 16 gauge wire.
- » 7 amp max with 18 gauge wire.

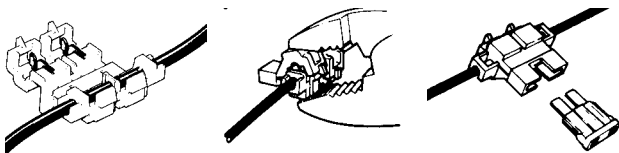
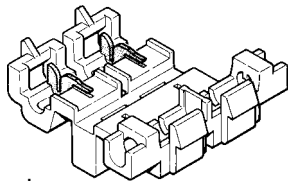

Part #	Qty
A12977	5

## Blade Type Fuse Tap

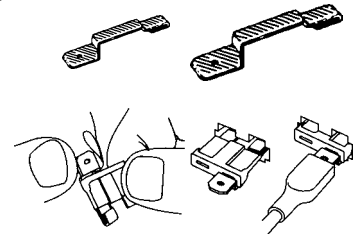

Type	Part #	Qty
Mini	A17686	50
ATC	A14474	25

## ATC Fuse Holder

- » Card contains 12 fuse holders.
- » 14 Gauge.

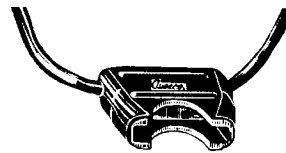

Part #	Qty
FH26	1

## HD Fuse Holder

- » With 30 amp fuse.
- » Card contains 12 fuse holders.
- » 12 Gauge.

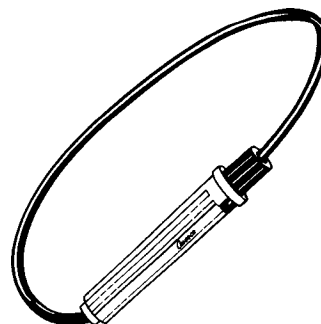

Part #	Qty
FH18	1



# MINIATURE BULBS



Type 1



Type 2



Type 3



Type 4



Type 5



Type 6



Type 7



Type 8



Type 9



Type 10



Type 11



Type 12



Type 13



Type 14



Type 15



Type 16



Type 18



Type 19



Type 20



Type 21



Type 22

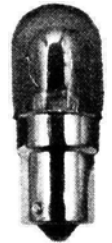

Type 23

10

## Halogen Replacement Bulbs

Description	Part #	Qty
High/Low Replacement Bulb	H-9003	1
High/Low Replacement Bulb	H-9004	1
High Replacement Bulb	H-9005	1
Low Replacement Bulb	H-9006	1
High/Low Replacement Bulb	H-9007	1



# MINIATURE BULBS

Part #	Type	Description	Qty
MB-PR2	8	—	10
MB-24	14	Marker, License	10
MB-24NA	14	Parking	10
MB-37	2	—	10
MB-53	4	Indicator	10
MB-55	4	—	10
MB-57	4	Instrument	10
MB-63	4	—	10
MB-67	4	Parking	10
MB-68	13	—	10
MB-73	2	—	10
MB-74	2	Indicator, Radio	10
MB-89	4	Dome	10
MB-90	13	—	10
MB-93	3	—	10
MB-97	4	Dome	10
MB-158	2	—	10
MB-161	18	—	10
MB-168	2	—	10
MB-192	18	—	10
MB-193	2	Instrument	10
MB-194	2	Instrument	10
MB-194NA	2	Parking	10
MB-198	1	Stop & Turn	10
MB-199	3	—	10
MB-211-2	6	Dome	10
MB-212-2	6	Dome-Courtesy	10
MB-222	20	—	10
MB-293	4	—	10
MB-558	18	—	10
MB-561	12	Dome	10
MB-562	12	—	10
MB-570	21	—	10
MB-577	11	Stop & Turn	10
MB-631	4	—	10
MB-904	10	—	10
MB-906	10	Courtesy	10
MB-912	10	3rd Light Bulb	10
MB-916	10	Parking	10
MB-916NA	10	—	10
MB-921	10	3rd Light Bulb	10
MB-922	10	—	10

Part #	Type	Description	Qty
MB-1003	3	Dome	10
MB-1004	3	Dome	10
MB-1034	1	—	10
MB-1073	3	Front Turn	10
MB-1076	1	—	10
MB-1141	3	Rear Turn	10
MB-1155	3	—	10
MB-1156	3	Front Turn	10
MB-1156NA	3	—	10
MB-1157	1	Stop & Turn	10
MB-1157NA	1	Front Turn	10
MB-1195	15	—	10
MB-1295NA	3	—	10
MB-1445	4	—	10
MB-1449	16	—	10
MB-1638	1	—	10
MB-1815	5	—	10
MB-1816	5	Instrument	10
MB-1889	5	Instrument	10
MB-1891	5	Courtesy	10
MB-1893	5	Instrument	10
MB-1895	4	Instrument	10
MB-2057	1	Stop & Turn, Late Model	10
MB-2057NA	1	Front Turn, Late Model	10
MB-2357	1	Stop & Turn	10
MB-2357NA	1	Turn & Parking	10
MB-2396	3	Turn & Parking	10
MB-3057	7	—	10
MB-3057NA	7	—	10
MB-3155	7	Hi-Mount Stop	10
MB-3156	7	Corner, Back-up	10
MB-3156NA	7	—	10
MB-3157	7	—	10
MB-3157NA	7	—	10
MB-3357	7	<b>Stop &amp; Turn</b>	10
MB-3357NA	7	<b>Stop &amp; Turn</b>	10
MB-3496	22	—	10
MB-3497	23	—	10
MB-3652	18	—	10
MB-7440	18	—	2
MB-7443	18	—	2
MB-13050	9	Dome	10
MB-12100	9	Dome	10

# GENERAL PURPOSE PRIMARY WIRE

## STRANDED



100 foot spools							
	Blue	Black	Brown	Green	Red	White	Yellow
20 ga.	—	20BL	—	—	20R	—	—
18 ga.	18B	18BL	18BR	18G	18R	18W	18Y
16 ga.	16B	16BL	16BR	16G	16R	16W	16Y
14 ga.	14B	14BL	14BR	14G	14R	14W	14Y
12 ga.	12B	12BL	—	12G	12R	12W	12Y
10 ga.	10B	10BL	—	10G	10R	10W	10Y
8 ga.	—	8BL	—	—	8R	8W	—

Mini Spools						
	Blue	Black	Green	Red	White	Yellow
18 ga. 45 ft	D8183	D8185	D8184	D8181	D8182	D8186
16 ga. 35 ft	D8163	D8165	D8164	D8161	D8162	D8166
14 ga. 25 ft	D8143	D8145	D8144	D8141	D8142	D8146
12 ga. 15 ft	D8123	D8125	D8124	D8121	D8122	D8126
10 ga. 10 ft	D8103	D8105	D8104	D8101	D8102	D8106

10

# PRIMARY WIRE ASSORTMENT

## STRANDED

Assorted Colors and Gauges



Part #	Qty
FK91030	1

- » 12 mini spools per box.
- » 14, 16, & 18 Gauge

# PARALLEL PRIMARY WIRE

## STRANDED TRAILER CABLE

2, 3 & 4 Conductor

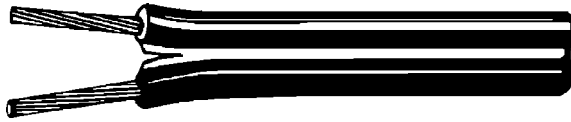



Size	Part #			Qty
	2 Conductor	3 Conductor	4 Conductor	
18 ga.	D82181	D83181	D84181	1
16 ga.	D82161	D83161	D84161	1
14 ga.	D82141	D83141	D84141	1

- » 100 feet per spool.
- » Parallel copper stranded primary wire is constructed of two, three, or four standard wall primary wires extruded together side by side so that the wires are held together by the thermoplastic insulation.
- » Each conductor is color-coded for identification purposes.
- » The wire is easily separated.
- » Parallel primary wire is economical and convenient for use in wiring assemblies and wherever a multiple conductor primary wire is needed.

### Colors Available

 → 2 Conductor: Red-Brown

 → 3 Conductor: Green-Yellow-Brown

 → 4 Conductor: Green-Yellow-Brown-White

# ALL PURPOSE SPEAKER CABLE

## STRANDED

Black



Wire Size	Part #	Qty
18/2	D19181	1
16/2	D19161	1
14/2	D19141	1
12/2	D19121	1

- » 100 feet per spool.
- » Positive identification with one wire tinned and one bare copper.

# BATTERY CABLE

## STRANDED

Red or Black

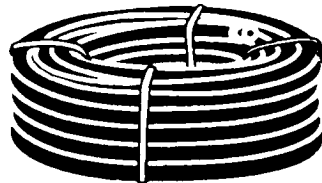
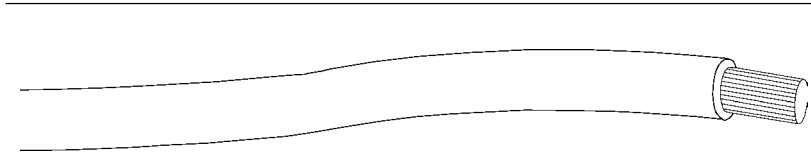

- » Copper stranded cable with a smooth polyvinylchloride insulation resistant to cracking, abrasion, weather, oil and acids.
- » Red or black cable.

25' roll

Gauge	Black #	Red #	Qty
6	BAT225-25B	BAT225-25R	1
4	BAT230-25B	BAT230-25R	1
2	BAT235-25B	BAT235-25R	1
1	BAT240-25B	BAT240-25R	1
1/0	BAT245-25B	BAT245-25R	1
2/0	BAT250-25B	BAT250-25R	1
3/0	BAT255-25B	BAT255-25R	1
4/0	BAT260-25B	BAT260-25R	1

100' roll

Gauge	Black #	Red #	Qty
6	BAT225-100B	BAT225-100R	1
4	BAT230-100B	BAT230-100R	1
2	BAT235-100B	BAT235-100R	1
1	BAT240-100B	BAT240-100R	1
1/0	BAT245-100B	BAT245-100R	1
2/0	BAT250-100B	BAT250-100R	1
3/0	BAT255-100B	BAT255-100R	1
4/0	BAT260-100B	BAT260-100R	1

# CONVOLUTED WIRE LOOM

## SPLIT FLEXIBLE TUBING

Nylon 6 - Black

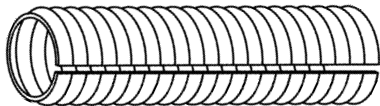

- » Holds groups of wires in position and gives wires excellent protection against abrasion and crushing.
- » Slit for easy insertion of wires, yet the slit remains basically closed when the loom is bent or twisted.
- » Can withstand maximum temperature of 345°F.

I.D.	O.D.	Part #					Qty
		1'	10'	25'	50'	100'	
1/4	3/8	D783FT	A14197	—	A14201	D783	1
3/8	9/16	D784FT	A14198	—	A14202	D784	1
1/2	11/16	D786FT	A14199	—	A14203	D786	1
3/4	15/16	D789FT	A14200	—	A14204	—	1
1"	1-1/8	D1790FT	—	A18194	—	—	1

# HEAT SHRINK TUBING

## SINGLE WALL

Black & Red



- » Flame Retardant
- » 2 to 1 Shrink Ratio
- » Meets UL-224 Specification
- » Meets Military Specification MIL-I-23053/5

### Black

Expanded Diameter	Shrunk Diameter	Typical Usage	6" Length Part #		Bulk Part #		Qty/Pack
			Ea.	Pack	Per Foot	100 ft Roll	
1/16	1/32	28-20 Ga.	56600	56600PK	56600FT	56600RL	10
3/32	3/64	24-16 Ga.	56601	56601PK	56601FT	56601RL	10
1/8	1/16	18-14 Ga.	56602	56602PK	56602FT	56602RL	10
3/16	3/32	14-10 Ga.	56603	56603PK	56603FT	56603RL	8
1/4	1/8	12-8 Ga.	56604	56604PK	56604FT	56604RL	6
3/8	3/16	10-6 Ga.	56605	56605PK	56605FT	56605RL	6
1/2	1/4	8-2 Ga.	56606	56606PK	56606FT	56606RL	6
3/4	3/8	1-2/0 Ga.	56607	56607PK	56607FT	56607RL*	3
1"	1/2	1/0-4/0 Ga.	56608	56608PK	56608FT	56608RL*	3

\* sold in 50 foot rolls

### Red

Expanded Diameter	Shrunk Diameter	Typical Usage	6" Length Part #		Bulk Part #		Qty/Pack
			Ea.	Pack	Per Foot	100 ft Roll	
1/16	1/32	28-20 Ga.	56620	56620PK	—	—	10
3/32	3/64	24-16 Ga.	56621	56621PK	—	—	10
1/8	1/16	18-14 Ga.	56622	56622PK	56622FT	56622RL	10
3/16	3/32	14-10 Ga.	56623	56623PK	56623FT	56623RL	8
1/4	1/8	12-8 Ga.	56624	56624PK	56624FT	56624RL	6
3/8	3/16	10-6 Ga.	56625	56625PK	56625FT	56625RL	6
1/2	1/4	8-2 Ga.	56626	56626PK	56626FT	56626RL	6
3/4	3/8	1-2/0 Ga.	56627	56627PK	—	—	3
1"	1/2	1/0-4/0 Ga.	56628	56628PK	56628FT	56628RL	3

# HEAT SHRINK TUBING

## ADHESIVE LINED - DUAL WALL

Black & Red - 6" pieces

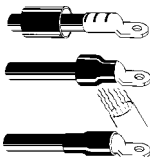

- » Protects against corrosion.
- » Identifies positive & negative polarity.
- » Acts as strain relief & prevents abrasion.

Dia	Part #		Qty
	Red	Black	
3/8	BAT270-R	BAT270-B	4
1/2	BAT275-R	BAT275-B	4
3/4	BAT280-R	BAT280-B	4
1"	BAT285-R	BAT285-B	4

# NYLON CABLE TIES

## STANDARD SINGLE LOOP

Natural, Black UV Nylon, Red, Blue, Green, Yellow, Brown, Orange, Purple and Gray Nylon



White & Black

Approx Length	Approx Width	Loop Tensile Strength	Bundle Dia		Part #		Qty
			Min	Max	Natural	Black	
3-3/4	.90	18 lbs.	1/16	3/4	D9722	D9623	100
5	.115	30 lbs.	1/16	1	D9724	D9625	100
7-1/4	.190	50 lbs.	1/16	1-3/4	D9728	D9629	100
11-1/4	.190	50 lbs.	1/16	3	D9730	D9631	50
14-1/4	.190	50 lbs.	1/16	4	D9732	D9633	50
Heavy Duty							
8	.310	120 lbs.	1/16	2	D9734	D9635	50
14-1/2	.310	120 lbs.	1/16	4	D9736	D9637	50
24	.310	120 lbs.	1/16	6	D9740	D9641	25
33	.360	175 lbs.	1/16	10	D9744	D9645	25

### Natural Nylon 6/6

General Purpose nylon is high in strength and lightweight. It is non-toxic and offers a wide temperature range. Nylon 6/6 is a hygroscopic material, which absorbs and releases moisture. This can affect the characteristics of cable ties.

### UV Stabilized Nylon 6/6

Ultraviolet Nylon offers the same features of the natural nylon but also protects against UV light. It contains well-dispersed carbon black for maximum resistance to weathering. This material is designed for outdoor applications.

### Additional Colors

Color	Approx Width	Loop Tensile Strength	Part Number		Qty
			8"	14"	
Red	.170	50 lbs.	D9342	D9344	50
Blue	.170	50 lbs.	D9347	D9349	50
Green	.170	50 lbs.	D9352	D9354	50
Yellow	.170	50 lbs.	D9357	D9359	50
Brown	.170	50 lbs.	D9362	D9364	50
Orange	.170	50 lbs.	D9367	D9369	50
Purple	.170	50 lbs.	D9372	D9374	50
Grey	.170	50 lbs.	D9377	D9379	50

- » Type 6/6 Nylon
- » Service temperature range: 40°F to 175°F.
- » Melting Point: 495°F.
- » Flammability: Self extinguishing UL 94 Class V-2.
- » Brittleness temp: -112°F (.2% H<sub>2</sub>O).

# NYLON CABLE TIES

## MOUNTING TAB

Natural & Black UV Nylon

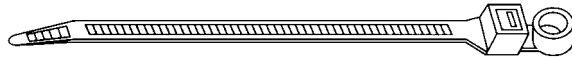

Approx Length	Approx Width	Loop Tensile Strength	Bundle Dia Max	Part #		Qty
				Natural	Black	
6-1/2	.135	40 lbs.	1-1/4	D9757	D9651	100
8	.190	50 lbs.	1-3/4	D9758	D9653	100
12	.190	50 lbs.	3	D9760	D9655	100
<b>Heavy Duty (Bundle Dia. Min 3/16)</b>						
15	.310	120 lbs.	4	D9765	D9657	100
22	.310	120 lbs.	6	D9766	D9659	50
29	.310	120 lbs.	8	D9767	D9661	25

- » Mounting tab cable ties have a molded-in screw hole for securing bundles of wire on virtually any surface that has or can accept a drilled hole.
- » Up to a 1/4-in screw size can be used, or a comparable rivet size.
- » All mounting tab cable ties are made of durable 6/6 nylon.
- » For use at temperatures not exceeding 85° C (185° F).

## WIRING HARNESS STRAP

5" Long, Nylon

Part #	Qty
A5879	25

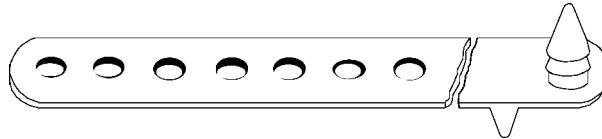

10

## CABLE TIE TOOL

- » A lightweight, durable hand tool that's perfect for installing cable ties.
- » The tool works on 18 pound, 30 pound, 40 pound and 50 pound tensile rated cable ties.
- » Measures 6-1/4" long.
- » Made of rugged plastic.



Part #	Qty
A14568	1



Feed cable ties in tool head, pull trigger to tension.

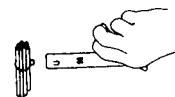

Hold trigger tension and twist tool 1/2 turn.



# CABLE TIE MOUNTING PADS

## PRESSURE SENSITIVE ADHESIVE BACKING

Natural & Black UV Nylon

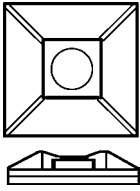

1"

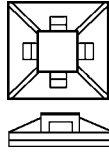

3/4"

Length	Width	Height	Slot	Hole Size	Part #		Qty
					Natural	Black	
3/4	3/4	.205	.05	#6	D9772	D9806	100
1"	1"	.215	.07	#8	D9771	D9871	100

# CABLE TIE SCREW MOUNTS

Natural Nylon

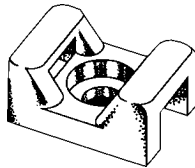

Length	Width	Height	Slot	Hole Size	Part #	Qty
					Natural	
.9	.37	.27	.19	#8	D9774	100

» Non-Conductive, Non-Corrosive; Resistant to Fuels, Lubricants and most Chemicals.

# TUBING CLAMPS

## STEEL INSULATED CLOSED CLAMPS

Furnished Open - Zinc Plated - Coated with Black Vinyl Plastic (1/32" thick)

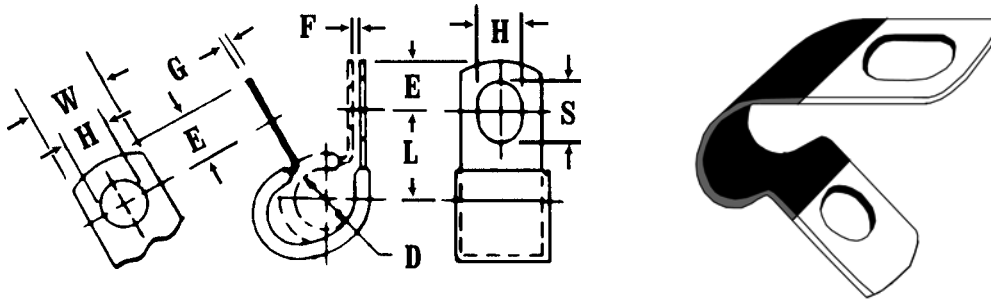

D	H	L	W	E	F	G	S		
I.D.	Hole Dia	Center to Center	Width	Hole Center to End	Gap	Gauge	Slot Length	Part #	Qty
<b>Small Hole Clamps</b>									
3/16	9/32	1/2	1/2	5/16	1/32	.032	3/8	A17087	25
1/4	9/32	17/32	1/2	5/16	1/32	.032	3/8	A9381	25
5/16	9/32	9/16	1/2	5/16	1/32	.032	3/8	A9382	25
3/8	9/32	19/32	1/2	5/16	1/16	.032	3/8	A9383	25
1/2	9/32	21/32	1/2	5/16	1/16	.048	3/8	A9384	25
5/8	9/32	23/32	1/2	5/16	1/16	.048	3/8	A9385	25
3/4	9/32	25/32	1/2	5/16	1/16	.048	3/8	A9386	25
7/8	9/32	27/32	1/2	5/16	1/16	.048	3/8	A9387	25
1	9/32	29/32	1/2	5/16	1/16	.048	3/8	A9388	25
<b>Large Hole Clamps</b>									
1/4	13/32	21/32	3/4	7/16	1/32	.032	1/2	A10598	25
5/16	13/32	11/16	3/4	7/16	1/32	.032	1/2	A10599	25
3/8	13/32	23/32	3/4	7/16	1/16	.032	1/2	A10600	25
1/2	13/32	25/32	3/4	7/16	1/16	.048	1/2	A10601	25
5/8	13/32	27/32	3/4	7/16	1/16	.048	1/2	A10602	25
3/4	13/32	29/32	3/4	7/16	1/16	.048	1/2	A10603	25
7/8	13/32	31/32	3/4	7/16	1/16	.048	1/2	A10604	25
1	13/32	1-1/32	3/4	7/16	1/16	.048	1/2	A10605	25
1-1/4	13/32	1-5/32	3/4	7/16	1/16	.048	1/2	A10606	25
1-1/2	13/32	1-9/32	3/4	7/16	1/16	.048	1/2	A10607	25
1-3/4	13/32	1-13/32	3/4	7/16	1/16	.048	1/2	A17588	10
2	13/32	1-9/16	3/4	7/16	1/16	.048	1/2	A17589	10

# INSULATED "HALF" TUBING CLAMPS

Zinc Plated - Coated with Black Vinyl Plastic (1/32" thick)

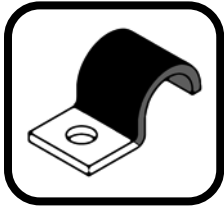

I.D.	Hole Diameter	Center to Center	Hole Center to End	Top of Radius to Base	Gauge	Width	Part #	Qty
3/16	7/32	7/16	1/4	5/32	.032	1/2	A10608	25
1/4	7/32	1/2	1/4	7/32	.048	1/2	A10609	25
5/16	9/32	17/32	5/16	9/32	.048	5/8	A10610	25
3/8	9/32	9/16	5/16	11/32	.048	5/8	A10611	25
7/16	9/32	5/8	5/16	13/32	.060	5/8	A10612	25
1/2	9/32	11/16	5/16	15/32	.060	5/8	A10613	25
5/8	9/32	13/16	5/16	9/16	.060	5/8	A10614	25
3/4	9/32	7/8	5/16	11/16	.060	5/8	A10615	25

# NYLON TUBING CLAMPS

Natural Nylon



Tube Dia	Width	Hole Dia	Part #	Qty
1/8	3/8	3/16	A15525	50
3/16	3/8	3/16	A15526	50
1/4	3/8	3/16	A9246	25
5/16	3/8	3/16	A9247	25
3/8	3/8	3/16	A9248	25
1/2	3/8	3/16	A9249	25
5/8	1/2	3/16	A9250	25
3/4	1/2	3/16	A9251	25
1"	1/2	3/16	A9252	25

10

# ALUMINUM TUBING CLAMPS

Vinyl Dipped



Tube Dia	Width	Hole Dia	Part #	Qty
1/4	3/8	5/32	A17361	15
5/16	3/8	5/32	A17362	15
3/8	3/8	5/32	A17363	15
1/2	3/8	5/32	A17364	15
5/8	3/8	5/32	A17365	15
3/4	1/2	5/32	A17366	15
7/8	1/2	5/32	A17367	15
1"	1/2	5/32	A17368	15

# RUBBER GROMMETS

Made of SBR Material

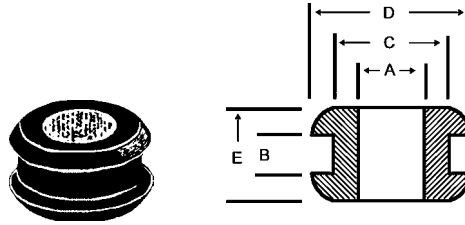

A	B	C	D	E	Part #	Qty
Bore Dia	Groove Width	Groove Dia	Outside Diameter	Overall Thickness		
<b>1/8</b>	3/32	3/8	1/2	5/16	<b>A4408</b>	25
<b>5/32</b>	1/16	1/4	3/8	3/16	<b>A4410</b>	25
	3/32	1/4	7/16	3/8	<b>A4411</b>	25
<b>3/16</b>	1/16	5/16	1/2	1/4	<b>A4413</b>	25
	3/32	9/32	3/8	5/16	<b>A4414</b>	25
	1/4	5/16	7/16	3/8	<b>A4415</b>	25
<b>1/4</b>	1/16	3/8	1/2	3/16	<b>A16454</b>	25
	1/16	7/16	5/8	3/16	<b>A4417</b>	25
	1/16	1"	1-1/4	1/4	<b>A4418</b>	25
<b>5/16</b>	1/16	7/16	9/16	3/16	<b>A4419</b>	25
	1/16	9/16	13/16	5/16	<b>A4420</b>	25
	1/16	3/4	1"	5/16	<b>A16455</b>	25
	1/8	9/16	13/16	3/8	<b>A4421</b>	25
	1/4	9/16	13/16	1/2	<b>A4422</b>	25
<b>3/8</b>	1/16	1/2	5/8	9/32	<b>A4423</b>	25
	1/16	5/8	7/8	11/32	<b>A16456</b>	25
	1/16	1"	1-1/4	1/4	<b>A4425</b>	25
	1/4	5/8	7/8	1/2	<b>A4426</b>	25
<b>7/16</b>	1/16	9/16	3/4	1/4	<b>A16457</b>	25
	3/32	3/4	31/32	9/32	<b>A4428</b>	25
<b>1/2</b>	3/32	25/32	1"	11/32	<b>A4429</b>	25
	1/8	3/4	1"	1/2	<b>A16458</b>	25
	1/4	13/16	1-1/16	1/2	<b>A4430</b>	25
<b>5/8</b>	1/8	7/8	1-1/8	3/8	<b>A4431</b>	25
	1/16	7/8	1-1/8	5/16	<b>A4432</b>	25
<b>3/4</b>	1/16	1-5/16	1-1/8	1/4	<b>A4433</b>	25
	1/16	1-1/16	1-3/8	3/8	<b>A4434</b>	25
	1/16	1-1/4	1-5/8	1/4	<b>A4435</b>	25
	1/4	1-1/4	1-5/8	7/16	<b>A4436</b>	25

# PLUG BUTTONS

## POLY PLUGS

Nylon 6/6 - Matte Finish

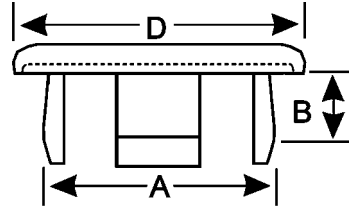

A	B	C	Head Height	Color	Part #	Qty
Hole Size	Panel Thickness	Head Size				
3/16	.031/.140	11/32	.040	Natural	A13862	100
3/16	.031/.140	11/32	.040	Black	A13863	100
1/4	.031/.062	27/64	.040	Natural	A13864	100
1/4	.031/.062	27/64	.040	Black	A13865	100
5/16	.031/.140	29/64	.050	Natural	A13866	100
5/16	.031/.140	29/64	.050	Black	A13867	100
3/8	.031/.140	37/64	.050	Natural	A13868	110
3/8	.031/.140	37/64	.050	Black	A13869	100
7/16	.031/.171	39/64	.050	Black	A13871	50
1/2	.031/.040	43/64	.062	Natural	A13872	50
1/2	.031/.040	43/64	.062	Black	A13873	50
9/16	.031/.140	47/64	.062	Black	A13875	50
5/8	.031/.072	51/64	.062	Natural	A13876	50
5/8	.031/.072	51/64	.062	Black	A13877	50
11/16	.031/.109	57/64	.062	Natural	A13878	50
11/16	.031/.109	57/64	.062	Black	A13879	50
3/4	.031/.109	63/64	.062	Natural	A13880	50
3/4	.031/.109	63/64	.062	Black	A13881	50
13/16	.031/.109	1-1/32	.062	Black	A13883	50
7/8	.031/.109	1-5/64	.062	Black	A13885	50
1	.031/.109	1-7/32	.062	Black	A13887	50

# PLUG BUTTONS

## Plastic Plug Buttons

- » Black Polyethylene
- » Depressed Center

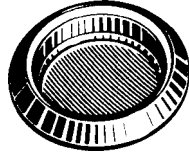

Hole Size	Head Dia	Working Thickness	Part #	Qty
1/2	7/8	.02-.07	A9288	100
3/4	1-5/32	.02-.14	A9289	100
7/8	1-1/4	.02-.10	A9290	100
1	1-3/8	.04-.10	A9291	100
1-1/4	1-5/8	.04-.10	A9292	100
1-1/2	1-7/8	.04-.10	A9293	100
1-3/4	2-1/8	.15-.17	A17207	50
2"	2-3/8	.17-.19	A17208	50
2-1/2	3"	.15-.17	A18798	25
3"	3-1/2	.18-.20	A18799	10

## Flush Sheet Metal Plugs

- » Black Polyethylene
- » Fits 14 to 26 Gauge Material



Hole Size	Head Dia	Part #	Qty
3/8	3/4	A14923	100
1/2	7/8	A11746	100
5/8	1-3/64	A18750	100
3/4	1-1/8	A11747	100
7/8	1-5/32	A11748	100
1"	1-7/16	A11749	100
1-1/4	1-5/8	A18800	50
1-1/2	1-7/8	A18801	25
1-3/4	2-1/8	A18802	25
2"	2-7/16	A18803	10
2-1/2	3"	A18804	10
3"	3-3/8	A18806	5

## STEEL PLUG BUTTONS

Nickel Plated

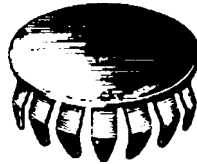

Hole Size	Head Dia	Working Thickness	Part #	Qty
1/4	13/32	.035-.062	A3750	50
3/8	1/2	.037-.078	A3751	50
7/16	21/32	.037-.047	A8013	50
1/2	21/32	.037-.062	A3752	50
5/8	13/16	.062-.078	A3753	50
3/4	15/16	.037-.093	A3754	50
7/8	1-1/16	.031-.093	A3755	50
1	1-1/8	.062-.093	A3756	50
1-1/4	1-7/16	.062-.093	A10231	10
1-1/2	1-21/32	.038-.141	A10232	10

# ELECTRICAL ACCESSORIES

## BATTERY CLAMPS

Red & Black Insulation

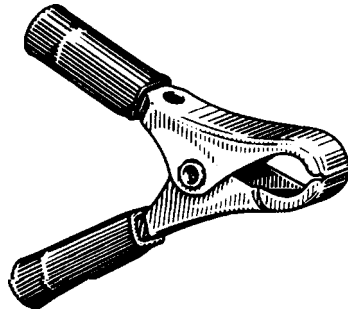

Amp	Insulation	Part #	Qty
10	Red	A16969	5
10	Black	A16970	5
10	Red & Black	A16971	1 pair
30	Red	A16972	5
30	Black	A16973	5
30	Red & Black	A16974	1 pair
50	Red	A16975	5
50	Black	A16976	5
50	Red & Black	A16977	1 pair

## TEST CLIPS

Steel



Amp	Length	Jaw Spread	Part #	Qty
10	2"	7/16	D1475	1
50	4"	13/16	D1495*	1

\*Specify Positive or Negative.

## ALLIGATOR CLIPS

Steel



Length	Jaw Spread	Part #	Qty
1-11/16	5/16	D1465	1

# ELECTRICAL ACCESSORIES

## CIRCUIT BREAKERS & AUTOMOTIVE FLASHERS

### Type 1 Automatic Metal Circuit Breaker with Mounting Bracket

Amps	Part #	Qty
10	D72105	5
15	D72115	5
20	D72125	5
30	D72135	5
35	D72145	5
40	D72165	5
50	D72175	5



### Type 1 Automatic Metal Circuit Breaker without Mounting Bracket

Amps	Part #	Qty
10	D72305	5
15	D72315	5
20	D72325	5
30	D72335	5
40	D72345	5

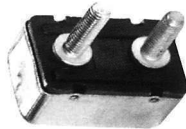

- » Two 10-32 studs
- » .66 (AUX) .50 BATT/Mounting Hole
- » .196 Dia Holes
- » Auto Reset
- » 12 Volt DC meets SAE J553 Specifications.
- » Single Pole terminal type breakers.
- » Used in diverse applications including Multiple power outlet strips, trucks, busses, portable generators, welding equipment, etc.

### Plug-in Metal Circuit Breaker

Amps	Part #	Qty
10	D72605	5
15	D72615	5
20	D72625	5
30	D72635	5

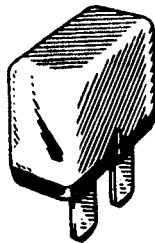

### Snap-in Metal Circuit Breaker

- » Remote reset circuit breaker replaces round glass style fuses in existing fuse blocks.
- » Opens automatically on overload.
- » Snap-in mounting in standard fuse clips
- » 1/4" diameter x 1-1/4" long.

Amps	Part #	Qty
10	D72415	5
15	D72425	5
20	D72435	5
30	D72465	5

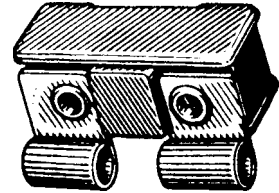

### Electro-Mechanical Automotive Flashers

- » Two prong.
- » 12 lamp flasher.
- » 25.2 amp rating.
- » 70-120 flash rate.
- » Rounded corners.
- » 1-1/2" tall.
- » Will fit in small areas with limited access.

Part #	Qty
P570	1

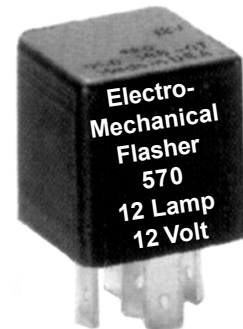



# ELECTRICAL ACCESSORIES

## TERMINAL BLOCKS AND FUSE PANELS

---

### Terminal Blocks with Screws

- » Rating 30A, 600V, UL & CSA.
- » Center spacing: 9/16".
- » Terminal size: .250
- » Distance between barriers: 0.412"
- » Maximum Temperature rating: 302°F (150°C)
- » Minimum Temperature rating: -40°F (-40°C)
- » Wire size: AWG #10 and smaller.
- » Mounting: #8 screw

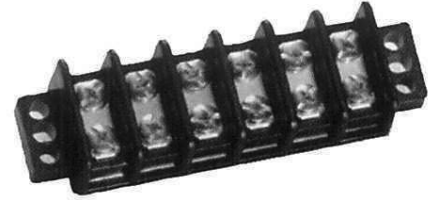

Gang	Part #	Qty
2	D70013	1
4	D70014	1
6	D70016	1
8	D70018	1
10	D70020	1

### Break Away Fuse Panels

- » Accept 1/4" fuses.
- » Rated to 300V.
- » Patented Design does not rely on fuse for solid, non wobble mount.
- » Break away design enables sub-dividing with simple finger pressure.
- » Choose screw or 1/4" quick connect terminals.
- » All tin plated.
- » UL recognized file E14853A, guide 1ZLT2
- » CSA certified.

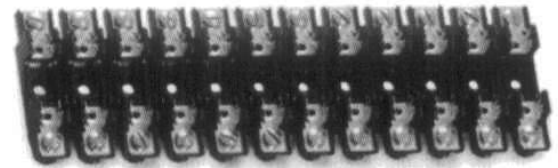

10

Description	Part #	Qty
Screws 12 Pole	D70011	1
Male Tab 12 Poles	D70012	1

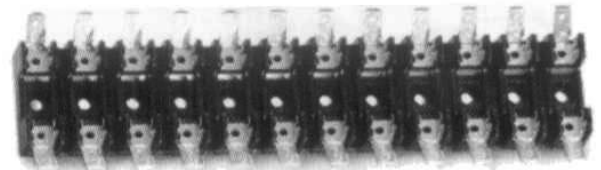

# PIGTAIL SOCKET ASSEMBLIES

## Complete 4-Way Trailer Connector

- » Polarized Four Prong.
- » Chrome plated die cast housing.
- » 2-hole flange mounting
- » 1-13/16 on center.
- » Mounting bracket available.



Part #	Qty
A13634	1

## 6-Way Trailer Connector Socket

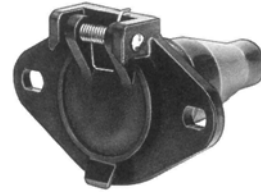

Part #	Qty
A13640	1

## Complete 6-Way Trailer Connector

- » Designed for recreational vehicles.
- » Chrome plated die cast housing.
- » Plastic moulded socket complete with plated spring loaded cover and a special moisture & dust-proof boot.



Part #	Qty
A13636	1

## 6-Way Trailer Connector Plug

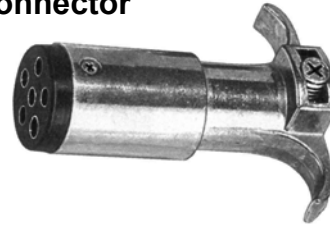

Part #	Qty
A13639	1

## Universal Bracket

- » For use with #A13641 thru #A13640.
- » For electrical connectors.
- » Designed to fit under trailer high ball.
- » Heavy gauge zinc plated steel.



Part #	Qty
A13643	2

# TOGGLE & ROCKER SWITCHES

## S.P.S.T. "Off-On" Toggle Switch

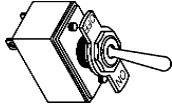

- » Rating: 35A @ 6V.  
20A @12V.
- » Furnished with nickel plated brass face nut and brass back-up nut.
- » Mounting stem 3/8" long.
- » 7/16" dia with 7/16" x 28 threads.

Part #	Qty
A13555	1

## "On-Off" Toggle Switch

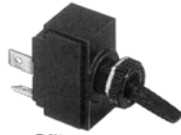

- » Rating: 15A @ 28V. DC
- » For lights, blower, pump, etc.
- » Black plastic paddle and locking ring with level seal and knurled cap nut.
- » Fits panels up to 1/4" thick; requires 15/32" mounting hold.
- » 1/4" spade terminals

Part #	Qty
A13556	1

## "On-Off-On" Toggle Switch

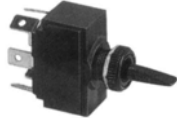

- » For running and anchor lights, wipers, manual/auto bilge pumps and dual fuel tanks.

Part #	Qty
A13557	1

## Illuminated "Off-On" Toggle Switch

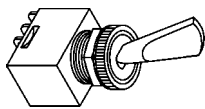

- » Rating: 16A @ 12V.
- » Handle illuminated in 'on' position.
- » Bezel nut and back-up collar for mounting in 1/2" hole.

Type	Part #	Qty
Red Illuminated Toggle	A13523	1
Green Illuminated Toggle	A13524	1
Amber Illuminated Toggle	A12236	1
Blue Illuminated Toggle	A13525	1

## S.P.D.T. "On-Off-On" Heavy Duty Toggle Switch



- » Rating: 16A @ 12V.
- » Black molded with bat handle.
- » Spring loaded for positive snap action.
- » Includes bezel nut and collar.
- » Fits 1/2" dia hole.

Part #	Qty
A13514	1

## "On-On" Heavy Duty Toggle Switch

- » Rating: 35A @ 6-12V.
- » 15/32" Stem Dia.
- » Die cast housing.
- » Chrome plated Handle



Part #	Qty
A13526	1

## "On-Off" Heavy Duty Fused Toggle Switch

- » Rating: 35A @ 6-12V.
- » 15/32" Stem Dia.
- » Die cast housing.
- » Chrome plated Handle

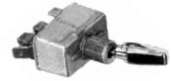

Part #	Qty
A13527	1

## "On-Off" Toggle Switch with screw terminals

- » Rating: 3A @ 250V. AC  
6A@125V. AC
- » 2 screw terminals
- » UL Approved

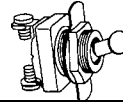

Part #	Qty
A12070	1

## "On-Off" Heavy Duty Fused Toggle Switch

- » Rating: 35A @ 6-12V.
- » 15/32" Stem Dia.
- » Voltage-High Amp Application.
- » Chrome plated Handle



Part #	Qty
A12076	1

## "On-Off" Illuminated Rocker Switches

- » Rating: 35A @ 6-12V.
- » 15/32" Stem Dia.
- » Voltage-High Amp Application.
- » Chrome plated Handle

- Terminal Coding**
1. Accessory
  2. Ground
  3. Power.

Type	Part #	Qty
Red Illuminated Rocker	A12234	1
Green Illuminated Rocker	A13529	1
Amber Illuminated Rocker	A13530	1
Blue Illuminated Rocker	A13531	1

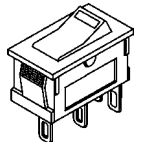

10

## "Off-On" Non-illuminated Rocker Switch

- » Rating: 16A @ 12V.
- » Fits 1-1/8" x 7/16" rectangular hole.

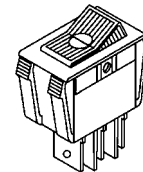

Part #	Qty
A13528	1

# TOGGLE SWITCHES

## S.P.S.T. "Off-On" Toggle Switch

- » Rating: 15A @ 125V. AC  
10A @ 250V. AC  
3/4HP 120-240V. AC

- » Phenolic housing.
- » 15/32" mounting stem.
- » Bat handle.

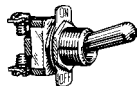

Part #	Qty
A13630	1

## S.P.D.T. "On-Off-On" Toggle Switch

- » Rating: 15A @ 125V. AC  
10A @ 250V. AC  
3/4HP 120-240V. AC

- » Phenolic housing.
- » 15/32" mounting stem.
- » 3 screw terminals.

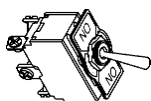

Part #	Qty
A13631	1

## Illuminated Toggle Switch Mounting Panel

- » 1/2" dia hole.

Part #	Qty
A12235	1

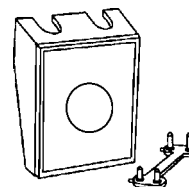

## S.P.S.T. "Off-On" Toggle Switch

- » Rating: 15A @ 125V. AC  
10A @ 250V. AC  
3/4HP 120-240V. AC

- » Two 6" wire leads
- » Nickel plated "Off-On" indicator plate assembled.
- » Mounting stem length 15/32"
- » 15/32" diameter bat handle.

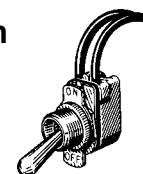

Part #	Qty
A13629	1

## Illuminated Toggle Switch Mounting Panel

- » For use with #A12234, #A13529, #A13530 & #A13531.
- » 1-1/8" x 7/16" rectangular hole

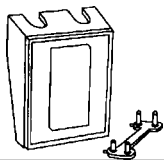

Part #	Qty
A12233	1

## "Off-On" Toggle Switch/Mounting Plate

- » Red 12 volt pilot light on mounting plate.
- » Each toggle has 2 blade terminals.



Part #	Qty
A12074	1

## Indicator Lamp



- » Has wire leads for installation.
- » Mounts into 1/2" hole.
- » 12 Volt Application.
- » Installs in A13516 & A13518.

Type	Part #	Qty
Green Lens	A13520	1
Amber Lens	A13521	1
Blue Lens	A13522	1

10

# PUSH-PULL & PUSH BUTTON SWITCHES

## "Off-On-On" Push-Pull Switch

- » 1-1/4" mounting stem.
- » 3/8" diameter.
- » Brass hex back-up nut, brass washer, chrome plated knob.
- » Suited for anchor lights and a separate circuit for running lights.

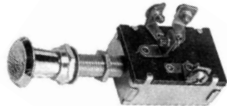

Part #	Qty
A13553	1

## "Off-On-On" Marine Switch

- » 1-1/4" mounting stem.
- » 3/8" diameter.
- » Brass hex back-up nut, brass washer, chrome plated knob.



Part #	Qty
A13552	1

## "Off-On" HD Push-Pull Switch

- » Rating: 25A @ 6V.  
15A @ 12V.
- » 2 screw terminal

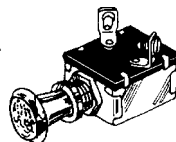

Part #	Qty
A12077	1

## Rubber Push Button Switch

- » All have 5/8"-32 threaded mounting stem



Rating	Part #	Qty
50A @ 12V.	A12761	1
60A @ 12V.	A12763	1

## Horn Button Switch

Part #	Qty
A12761	1

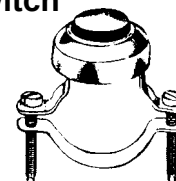

# EXTENSION CORDS & ACCESSORIES

## CORDS, LIGHTING & BOOSTER CABLES

### Vinyl Extension Cords

- » Meets OSHA requirements for outdoor use.
- » High visibility vinyl insulation resists oil, grease, moisture, abrasion and exposure to sunlight.
- » Heavy duty molded-on plugs and connectors.

Gauge	Length	Part #	Qty
<b>16</b>	25 FT	COL-02307	1
	50 FT	COL-02308	1
	100 FT	COL-02309	1
<b>14</b>	25 FT	COL-02407	1
	50 FT	COL-02408	1
	100 FT	COL-02409	1
<b>12</b>	25 FT	COL-02507	1
	50 FT	COL-02508	1

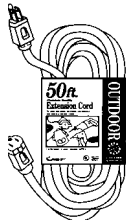
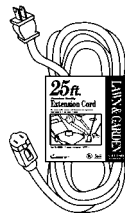

### Cube Tap Extension Cords

- » Plug and three-outlet connector polarized for convenient use.
- » Each connector has a safety cover permanently attached.

Gauge	Length	Part #	Qty
16	12 FT	COL-09403	1



### Heavy Duty Reflector Lights

- » Versatile multi-use utility lamps with polished and vented aluminum reflectors.
- » Each unit features a double ball universal joint, non-marring grips and a clamp-on bracket.
- » On-off push through switch and rugged molded-on plug.

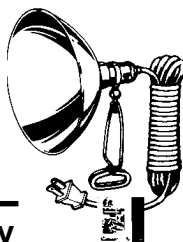

Gauge	Length	Part #	Qty
18	6 FT	COL-05932	1

### Trouble Lights w/Orange Vinyl Cord

- » Meet OSHA specifications for general use.
- » A complete line of rugged, "trouble-free" trouble lights for home and heavy duty use.
- » Grounded metal guard with switch and side outlet.

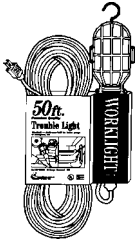

Gauge	Length	Part #	Qty
16	25 FT	COL-05427	1
16	50 FT	COL-05428	1

### Fluorescent Work Lights

- » Cool, glare-free fluorescent light that can be easily hung or held for maximum illumination and convenience.
- » Clear protective sleeve guards fluorescent tube against breakage.

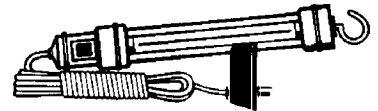

Description	Watt	Length	Part #	Qty
Compact hand held	13	25 FT	COL-05931	1
Replacement bulb	13	—	COL-05933	1

10

### Automotive Booster Cables

- » All with no tangle T\*PRENE insulation flexible to 70°C.
- » Stranded all-copper conductors.
- » Attractive four color cartons with plastic carrying handle for added convenience.

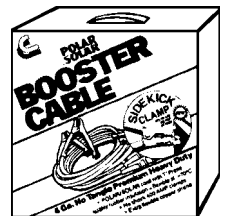

Gauge	Length	Part #	Qty
4	16 FT	COL-08665	1

# ACCESSORIES & ADAPTERS

## Replacement Trouble-light Guards

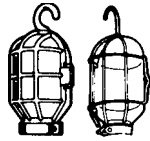

Description	Part #	Qty
White Polypropylene	COL-05905	1
Metal Swing-Open	COL-05906	1

## Replacement Trouble-light Handle

- » Trouble light replacement handle and socket.
- » 3 wire.

Part #	Qty
COL-05912	1

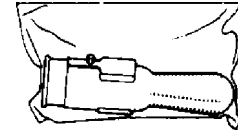

## Replacement Cord Ends

- » Armored male cap.
- » 3-wire dead front.
- » Yellow vinyl.
- » Takes 12/3 and smaller wire.

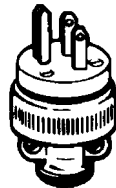

Part #	Qty
COL-05980	1

## Replacement Cord Ends

- » Armored female cap.
- » 3-wire dead front.
- » Yellow vinyl.
- » Takes 12/3 and smaller wire.

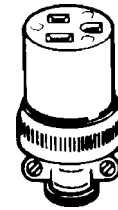

Part #	Qty
COL-05981	1

## 3 To 2 Wire Adapter

- » Grey.

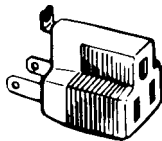

Part #	Qty
COL-09901	1

## Surge Protector Power Strip

- » Six-way outlet.

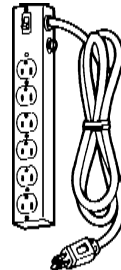

Part #	Qty
COL-04623	1

## 3 Wire Cube Tap — Rubber

- » Yellow.



Part #	Qty
COL-09903	1

## Rough Service Light Bulbs

- » Designed for use in places where the bulb may be subject to rough handling or vibration: in trouble lights, garages, workshops or beneath high traffic floor areas.
- » The extra strong filament and rugged construction gives this light bulb its impact-resistant quality.
- » 2 bulbs per pack.
- » 24 bulbs per case.

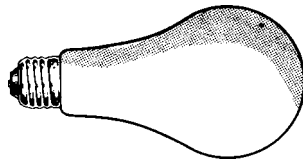

Watts	Part #	Qty
50	BU-050RS-2	pk/2
75	BU-075RS-2	pk/2
100	BU-100RS-2	pk/2
50	BU-050RS-CS	cs/24
75	BU-075RS-CS	cs/24
100	BU-100RS-CS	cs/24

## Tuff-Skin Coated Light Bulbs

- » Shatterproof
- » Bulb stays intact when broken whereas ordinary bulbs will shatter thus spraying broken glass.
- » Sold Individually.

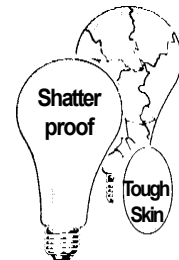

Watts	Part #	Qty
50	BU-050T	1
75	BU-075T	1
100	BU-100T	1

# HEAVY DUTY INDUSTRIAL FLASHLIGHTS

Type 1, 2 and 3, Economy and Replacement Bulb



**Type 1**

- » Parabolic reflector for spot light work with penetrating focused beam.
- » Yellow with Black ends.
- » Includes a spare bulb.
- » 8-1/2" long.



**Type 2**

- » Magna-Beam flood reflector covers 10 times the normal area.
- » Yellow with Black ends.
- » Includes a spare bulb.
- » 8-1/2" long.



**Type 3**

- » Fixed magnet plus Magna-Beam flood reflector covers 10 times the normal area.
- » Yellow with Black ends.
- » Includes a spare bulb.
- » 8-1/2" long.



**Economy Flashlight**

- » Economy flashlight with magnet.



**Replacement Flashlight Bulb**

Description	Part #	Qty
Type 1	A16166	1
Type 2	A16167	1
Type 3	A16168	1
Economy Flashlight	H22M-1	1
Replacement Bulb	MB-PR2	10

## ALKALINE BATTERIES



Description	Part #	Qty
Size D Alkaline	813-2	2
Size C Alkaline	814-2	2
Size AAA Alkaline	824-2	2
Size AA Alkaline	815-2	2
9V Alkaline	A1604-1	1

10

## KEYLESS ENTRY BATTERIES



Description	Part #	Qty
3 Volt	RAY-CR1616	1
3 Volt	RAY-CR2016	1
3 Volt	RAY-CR2025	1
3 Volt	RAY-CR2032	1
12 Volt Garage Door	RAY-23A	1

# MAG INSTRUMENT FLASHLIGHTS

## MAG-LITE™ D CELL, MINI MAG & SOLITAIRE MINI MAG



» Barrel, Head, Cap and Tail are made of sturdy aircraft grade aluminum.



» Lights are O-Ringed throughout for maximum moisture resistance.



» Each light comes with an extra bulb stored in foam in the tail cap.

» Powered by D-cell batteries (not included).

Description	Part #			Qty
	2 Cell	3 Cell	4 Cell	
Black Mag	MAG-S2D016	MAG-S3D016	MAG-S4D016	1
Red Mag	MAG-S2D036	MAG-S3D036	MAG-S4D036	1
Replacement Bulb	MAG-LMSA201	MAG-LMSA301	MAG-LMSA401	2
Vehicle Mounting Clamp	MAG-ASXD021	MAG-ASXD021	MAG-ASXD021	2

## MINI MAG-LITES

- » The Mini Mag-Lite is the ideal personal or professional flashlight.
- » Powered by two AA alkaline batteries
- » Has superior optics of 70 times more powerful than any light this size.
- » Fits Easily into a pocket purse, attache case or suitcase.
- » Weighs less than 2 ounces.
- » 5-3/4" length.



Description	Part #	Qty
Black Mini Mag with Nylon Holster and Batteries	MAG-M2A01H	1
Red Mini Mag with Batteries	MAG-M2A036	1
Mini Mag Replacement Bulb	MAG-LM2A001	2

## SOLITAIRE MINI MAG-LITE

- » Ideal for pocket or purse. Slim, non-bulging contour fits snugly and comfortably.
- » Extended key lead allows keys and light beam to be used together in the same direction.
- » Linear focusing flood to spot beam with a twist of the wrist.
- » 24' to 30' effective range for an 18" to 22" spot pattern.
- » Approximately 3 hours of operating per battery.
- » Extra long lamp life.
- » Powered by one AAA alkaline battery (included).
- » Spare lamp in tailcap.

Description	Part #	Qty
Black Solitaire Mini Mag	MAG-K3A012	1
Solitaire Replacement Bulb	MAG-LM3A001	2







# ELECTRICAL **FAS-KIT**<sup>®</sup> ASSORTMENTS



<b>Plastic Box Assortments</b>		
Part Number	Description	Number of Pieces
FK04000	Vinyl Insulated Solderless Terminals	205
FK04020	Vinyl Insulated Solderless Terminals - Large Sizes	85
FK04030	Non-Insulated Solderless Terminals	240
FK04040	Crimp & Seal Terminals	100
FK04060	Solder Sleeve Terminals	90
FK04100	Wire Nuts	215
FK04130	Glass Tube Fuses	120
FK04140	Blade Type Fuses	70
FK04200	Heat Shrink Tubing	42

<b>Metal Tray Assortments</b>			
Small Drawer	Large Drawer	Description	Number of Pieces
FK16000	FK56000	Vinyl Insulated Solderless Terminals	351
FK16050	FK56050	Vinyl Insulated Solderless Terminals	455
FK16100	FK56100	Vinyl Insulated Solderless Terminals	435
FK16150	FK56150	Vinyl Insulated Solderless Terminals	340
FK16200	FK56200	Vinyl Insulated Solderless Terminals	450
FK16220	FK56220	Vinyl Insulated Solderless Terminals - Large Sizes	195
FK16230	FK56230	Wire Nuts	215
FK16250	FK56250	Crimp & Seal Terminals	200
FK16270	FK56270	Nylon Insulated Wire Terminals	346
FK16280	FK56280	Nylon Insulated Wire Terminals	450
FK16290	FK56290	Solder Sleeve Terminals	100
FK16300	FK56300	Glass Tube Fuses	140
FK16350	FK56350	Blade Type Fuses	115
-	FK56360	Glass & Blade Fuses	255
-	FK56370	Automotive Mini Bulbs	105
FK16400	FK56400	Rubber Grommets	279
FK16450	FK56450	Rubber Grommets	67
FK16460	FK56460	Depressed Center Poly Plugs	112
FK16465	FK56465	Flush Type Poly Plugs	141
FK16470	FK56470	Depressed Center & Flush Type Poly Plugs	236
FK20100	FK60100	Nickel Plated Plug Buttons	225
FK16500	FK56500	Copper Battery Lugs	74
FK16550	FK56550	Heat Shrink Tubing - Std.	52
FK16570	FK56570	Heat Shrink Tubing - Dual Wall	32
-	FK56600	Cable Ties - Natural	625
-	FK56650	Cable Ties - Black	625
FK16700	FK56700	Tubing Clamps - Neoprene Dipped	105
FK16710	FK56710	Tubing Clamps - Nylon	200



# Section 11: Fittings, Hose & Accessories

## Table of Contents

### Fittings

Black Iron Pipe Fittings .....	3-4
Brass Pipe Fittings .....	5-7
Brass Hose Barb Fittings .....	7-8
Ball Valves & Drain Cocks .....	8
Brass SAE 45° Flare Fittings .....	9-11
Brass SAE 45° Inverted Flare Fittings .....	12-13
Special Brake Line Fittings .....	13
Brass Compression Fittings .....	14-15
Brass Air Brake Fittings - Copper Tubing .....	16
Brass Air Brake Fittings - Nylon Tubing .....	17-18
Brass Push-to-Connect Fittings .....	18

### Vacuum Fittings

Vacuum Caps .....	19
Nylon Vacuum Fittings .....	19-22
Rubber Vacuum Fittings .....	23
High Density Vacuum Fittings .....	23

### O Rings

Buna-N .....	24-27
Viton .....	24-27
O-Ring Kits .....	27
Splicing Kits .....	27

### Lubrication

Grease Fittings .....	28
Grease Guns .....	29
Oil Can .....	29
Grease Gun Couplers, Hoses, Etc .....	30

### Air Line Accessories

Couplers & Nipples .....	31-32
Blo-Guns .....	33
Regulators & Gauges .....	34
Air Tool Oil .....	34
Air Chucks .....	34

### Tire Accessories

Valve Tools .....	35
-------------------	----

### Tire Accessories - cont'd.

Pressure Gages .....	35
Tire Valve Stems .....	36
Valve Cores, Caps & Extensions .....	36
Wheel Balancing Weights - <i>Standard</i> .....	37
Wheel Balancing Weights - <i>Metric</i> .....	38
Wheel Balancing Weights - <i>Two Piece</i> .....	38
Wheel Balancing Weights - <i>Truck</i> .....	39
Wheel Balancing Weights - <i>Adhesive</i> .....	40

### Muffler Clamps

Standard & Heavy Duty .....	40
Swivel Hanger .....	40

### Tubing & Hose

Copper Tubing .....	41
Nylon Air Brake Tubing .....	41
Steel Tubing .....	42
Vinyl (PVC) Tubing .....	42
Heater Hose .....	42
Fuel Line Hose .....	43
Windshield Washer & Vacuum Tubing .....	43
Fuel Injection Hose .....	43
Air Line Hose .....	44

### Water Hose & Accessories

Hose .....	45
Spray Nozzles .....	45
Hose Menders .....	45

### Clamps

Standard Hose Clamps .....	46
Type G Miniature Hose Clamps .....	46
Norma Torro Clamps .....	47
Crimp Type Clamps .....	47
Spring Type Clamps .....	48
Tubing Clamps .....	49-50

Faskit Assortments .....	51-52
--------------------------	-------



# BLACK IRON PIPE FITTINGS

## Hex Bushing

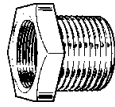

Size	Part #	Qty
1/4 x 1/8	12700	1
3/8 x 1/4	12701	1
3/8 x 1/8	12702	1
1/2 x 3/8	12703	1
1/2 x 1/4	12704	1
1/2 x 1/8	12705	1
3/4 x 1/2	12706	1
3/4 x 3/8	12707	1
3/4 x 1/4	12708	1
3/4 x 1/8	12709	1
1" x 3/4	12710	1
1" x 1/2	12711	1
1" x 3/8	12712	1
1" x 1/4	12713	1
1-1/4 x 1"	12715	1
1-1/4 x 3/4	12716	1
1-1/4 x 1/2	12717	1
1-1/4 x 3/8	12718	1
1-1/2 x 1-1/4	12721	1
1-1/2 x 1"	12722	1
1-1/2 x 3/4	12723	1
1-1/2 x 1/2	12724	1
1-1/2 x 3/8	12725	1
2" x 1-1/2	12728	1
2" x 1-1/4	12729	1
2" x 1"	12730	1
2" x 3/4	12731	1
2" x 1/2	12732	1

## Hex Socket Pipe Plugs



Size	Part #	Qty
1/16	12669	1
1/8	12670	1
1/4	12671	1
3/8	12672	1
1/2	12673	1
3/4	12674	1
1	12675	1

## Pipe Coupling

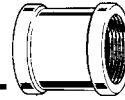

Size	Part #	Qty
1/8	12760	1
1/4	12761	1
3/8	12762	1
1/2	12763	1
3/4	12764	1
1"	12765	1
1-1/4	12766	1
1-1/2	12767	1
2"	12768	1

## Reducing Coupling

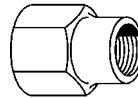

Size	Part #	Qty
1/4 x 1/8	12775	1
3/8 x 1/4	12776	1
3/8 x 1/8	12777	1
1/2 x 3/8	12778	1
1/2 x 1/4	12779	1
1/2 x 1/8	12780	1
3/4 x 1/2	12781	1
3/4 x 3/8	12782	1
3/4 x 1/4	12783	1
1" x 3/4	12785	1
1" x 1/2	12786	1
1" x 3/8	12787	1
1-1/4 x 1"	12790	1
1-1/4 x 3/4	12791	1
1-1/4 x 1/2	12792	1
1-1/2 x 1-1/4	12796	1
1-1/2 x 1"	12797	1
1-1/2 x 3/4	12798	1
1-1/2 x 1/2	12799	1
2" x 1-1/2	12803	1
2" x 1-1/4	12804	1
2" x 1"	12805	1
2" x 3/4	12806	1
2" x 1/2	12807	1

## Pipe Union

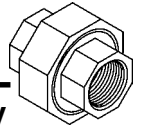

Size	Part #	Qty
1/8	12840	1
1/4	12841	1
3/8	12842	1
1/2	12843	1
3/4	12844	1
1"	12845	1
1-1/4	12846	1
1-1/2	12847	1
2"	12848	1

## 90° Street Elbow

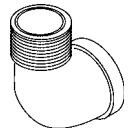

Size	Part #	Qty
1/8	12855	1
1/4	12856	1
3/8	12857	1
1/2	12858	1
3/4	12859	1
1"	12860	1
1-1/4	12861	1
1-1/2	12862	1
2"	12863	1

## 45° Street Elbow



Size	Part #	Qty
1/8	12870	1
1/4	12871	1
3/8	12872	1
1/2	12873	1
3/4	12874	1
1"	12875	1
1-1/4	12876	1
1-1/2	12877	1
2"	12878	1

# BLACK IRON PIPE FITTINGS

## 90° Female Elbow



Size	Part #	Qty
1/8	12885	1
1/4	12886	1
3/8	12887	1
1/2	12888	1
3/4	12889	1
1"	12890	1
1-1/4	12891	1
1-1/2	12892	1
2"	12893	1

## Female Tee

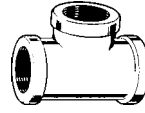

Size	Part #	Qty
1/8	12915	1
1/4	12916	1
3/8	12917	1
1/2	12918	1
3/4	12919	1
1"	12920	1
1-1/4	12921	1
1-1/2	12922	1
2"	12923	1

## Pipe Cap

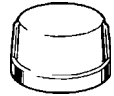

Size	Part #	Qty
1/8	12945	1
1/4	12946	1
3/8	12947	1
1/2	12948	1
3/4	12949	1
1"	12950	1
1-1/4	12951	1
1-1/2	12952	1
2"	12953	1

## 45° Female Elbow



Size	Part #	Qty
1/8	12900	1
1/4	12901	1
3/8	12902	1
1/2	12903	1
3/4	12904	1
1"	12905	1
1-1/4	12906	1
1-1/2	12907	1
2"	12908	1

## Square Plug



Size	Part #	Qty
1/8	12930	1
1/4	12931	1
3/8	12932	1
1/2	12933	1
3/4	12934	1
1"	12935	1
1-1/4	12936	1
1-1/2	12937	1
2"	12938	1

## Close Nipple

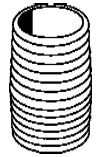

Size	Part #	Qty
1/8	12960	1
1/4	12961	1
3/8	12962	1
1/2	12963	1
3/4	12964	1
1"	12965	1
1-1/4	12966	1
1-1/2	12967	1
2"	12968	1

## Pipe Nipples

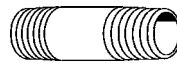

Size	Part #									Qty
	1/8	1/4	3/8	1/2	3/4	1"	1-1/4	1-1/2	2"	
1-1/2	12975	12995	13015	13035	13055	—	—	—	—	1
2"	12976	12996	13016	13036	13056	13075	13095	13115	—	1
2-1/2	12977	12997	13017	13037	13057	13076	13096	13116	13135	1
3"	12978	12998	13018	13038	13058	13077	13097	13117	13136	1
3-1/2	12979	12999	13019	13039	13059	13078	13098	13118	13137	1
4"	12980	13000	13020	13040	13060	13079	13099	13119	13138	1
4-1/2	12981	13001	13021	13041	13061	13080	13100	13120	13139	1
5"	12982	13002	13022	13042	13062	13081	13101	13121	13140	1
5-1/2	12983	13003	13023	13043	13063	13082	13102	13122	13141	1
6"	12984	13004	13024	13044	13064	13083	13103	13123	13142	1
8"	12985	13005	13026	13046	13066	13085	13105	13125	13144	1
10"	12986	13006	13028	13048	13068	13087	13107	13127	13146	1
12"	12987	13007	13030	13050	13070	13089	13109	13129	13148	1

# BRASS PIPE FITTINGS

All fittings can be ordered individually

## Coupling

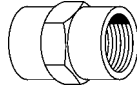

Pipe	Part #	Qty
1/8	103-A	1
1/4	103-B	1
3/8	103-C	1
1/2	103-D	1
3/4	103-E	1
1	103-H	1

## Reducing Coupling

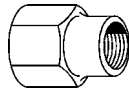

Pipe	Part #	Qty
1/4 x 1/8	119-BA	1
3/8 x 1/8	119-CA	1
3/8 x 1/4	119-CB	1
1/2 x 1/4	119-DB	1
1/2 x 3/8	119-DC	1
3/4 x 1/2	119-ED	1

## Adapter

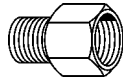

Pipe	Part #	Qty
1/8 x 1/8	120-AA	1
1/4 x 1/4	120-BB	1
3/8 x 3/8	120-CC	1
1/2 x 1/2	120-DD	1

## Reducing Adapter

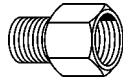

Pipe	Part #	Qty
1/8 x 1/16	120-A1	1
1/4 x 1/8	120-BA	1
3/8 x 1/8	120-CA	1
3/8 x 1/4	120-CB	1
1/2 x 1/4	120-DB	1
1/2 x 3/8	120-DC	1
3/4 x 1/2	120-ED	1

## Long Nipple

» Longer Lengths available upon request.



Pipe	Length	Part #	Qty
<b>1/8 Diameter</b>			
1/8	1-1/2	113-A1-1/2	1
1/8	2"	113-A2	1
1/8	2-1/2	113-A2-1/2	1
1/8	3"	113-A3	1
<b>1/4 Diameter</b>			
1/4	1-1/2	113-B1-1/2	1
1/4	2"	113-B2	1
1/4	2-1/2	113-B2-1/2	1
1/4	3"	113-B3	1
<b>3/8 Diameter</b>			
3/8	1-1/2	113-C1-1/2	1
3/8	2"	113-C2	1
3/8	2-1/2	113-C2-1/2	1
3/8	3"	113-C3	1
<b>1/2 Diameter</b>			
1/2	1-1/2	113-D1-1/2	1
1/2	2"	113-D2	1
1/2	2-1/2	113-D2-1/2	1
1/2	3"	113-D3	1
<b>3/4 Diameter</b>			
3/4	1-1/2	113-E1-1/2	1
3/4	2"	113-E2	1
3/4	2-1/2	113-E2-1/2	1
3/4	3"	113-E3	1
<b>1" Diameter</b>			
1"	2"	113-H2	1
1"	2-1/2	113-H2-1/2	1
1"	3"	113-H3	1

## Close Nipple

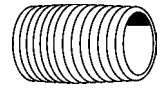

Pipe	Part #	Qty
1/8	112-A	1
1/4	112-B	1
3/8	112-C	1
1/2	112-D	1
3/4	112-E	1
1	112-H	1

## Hex Nipple

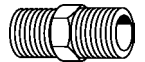

Pipe	Part #	Qty
1/8	122-A	1
1/4	122-B	1
3/8	122-C	1
1/2	122-D	1
3/4	122-E	1
1	122-H	1

## Reducing Hex Nipple

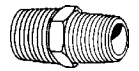

Pipe	Part #	Qty
1/4 x 1/8	122-BA	1
3/8 x 1/8	122-CA	1
3/8 x 1/4	122-CB	1
1/2 x 1/4	122-DB	1
1/2 x 3/8	122-DC	1
3/4 x 1/2	122-ED	1

## Lock Nut



Tube	Part #	Qty
1/8	111-A	1
1/4	111-B	1
3/8	111-C	1
1/2	111-D	1
3/4	111-E	1

# BRASS PIPE FITTINGS

All fittings can be ordered individually

## Reducing Bushing

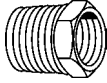

Pipe	Part #	Qty
1/4 x 1/8	110-BA	1
3/8 x 1/8	110-CA	1
3/8 x 1/4	110-CB	1
1/2 x 1/8	110-DA	1
1/2 x 1/4	110-DB	1
1/2 x 3/8	110-DC	1
3/4 x 1/8	110-EA	1
3/4 x 1/4	110-EB	1
3/4 x 3/8	110-EC	1
3/4 x 1/2	110-ED	1
1" x 3/8	110-HC	1
1" x 1/2	110-HD	1
1" x 3/4	110-HE	1

## Pipe Plug

» Slotted



Pipe	Part #	Qty
1/8	117-A	1
1/4	117-B	1
3/8	117-C	1

## Extruded 90° Elbow

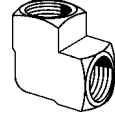

Pipe	Part #	Qty
1/8	X100-A	1
1/4	X100-B	1
3/8	X100-C	1
1/2	X100-D	1

## Pipe Plug

» Hex Counter Sunk



Tube	Part #	Qty
1/8	118-A	1
1/4	118-B	1
3/8	118-C	1
1/2	118-D	1
3/4	118-E	1

## Extruded 45° Street Elbow

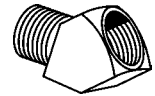

Pipe	Part #	Qty
1/8	X124-A	1
1/4	X124-B	1
3/8	X124-C	1
1/2	X124-D	1

## Pipe Plug

» Square Head

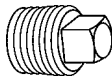

Pipe	Part #	Qty
1/8	109-A	1
1/4	109-B	1
3/8	109-C	1
1/2	109-D	1
3/4	109-E	1
1	109-H	1

## Pipe Cap

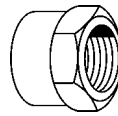

Tube	Part #	Qty
1/8	108-A	1
1/4	108-B	1
3/8	108-C	1
1/2	108-D	1
3/4	108-E	1

## Extruded 45° Elbow

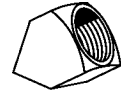

Pipe	Part #	Qty
1/8	X105-A	1
1/4	X105-B	1

## Pipe Plug

» Hex Head

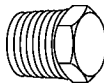

Pipe	Part #	Qty
1/8	121-A	1
1/4	121-B	1
3/8	121-C	1
1/2	121-D	1
3/4	121-E	1
1	121-H	1

## Extruded 90° Street Elbow

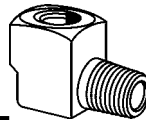

Pipe	Part #	Qty
1/8	X115-A	1
1/4	X115-B	1
3/8	X115-C	1
1/2	X115-D	1

### Reducing

1/4x 1/8	X115-BA	1
----------	---------	---

## Extruded Tee

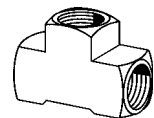

Pipe	Part #	Qty
1/8	X101-A	1
1/4	X101-B	1
3/8	X101-C	1
1/2	X101-D	1



# BRASS PIPE FITTINGS

All fittings can be ordered individually

## Extruded Cross

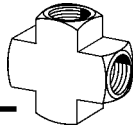

Pipe	Part #	Qty
1/8	X102-A	1
1/4	X102-B	1
3/8	X102-C	1
1/2	X102-D	1

## Extruded Male Branch Tee

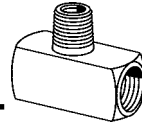

Pipe	Part #	Qty
1/8	X106-A	1
1/4	X106-B	1
3/8	X106-C	1

## Extruded Street Tee

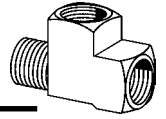

Pipe	Part #	Qty
1/8	X107-A	1
1/4	X107-B	1
3/8	X107-C	1

# BRASS HOSE BARB FITTINGS

All fittings can be ordered individually

## Male Adapter



» Hose Barb to Male Pipe

Hose ID	Pipe	Part #	Qty
1/8	1/8	125-2A	1
1/8	1/4	125-2B	1
3/16	1/8	125-3A	1
3/16	1/4	125-3B	1
1/4	1/8	125-4A	1
1/4	1/4	125-4B	1
1/4	3/8	125-4C	1
1/4	1/2	125-4D	1
5/16	1/8	125-5A	1
5/16	1/4	125-5B	1
5/16	3/8	125-5C	1
3/8	1/8	125-6A	1
3/8	1/4	125-6B	1
3/8	3/8	125-6C	1
3/8	1/2	125-6D	1
1/2	1/4	125-8B	1
1/2	3/8	125-8C	1
1/2	1/2	125-8D	1
1/2	3/4	125-8E	1
5/8	3/8	125-10C	1
5/8	1/2	125-10D	1
5/8	3/4	125-10E	1
3/4	1/2	125-12D	1
3/4	3/4	125-12E	1

## Female Adapter

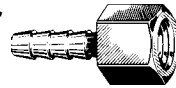

» Hose Barb to Female Pipe

Hose ID	Pipe	Part #	Qty
1/8	1/8	126-2A	1
1/8	1/4	126-2B	1
3/16	1/8	126-3A	1
3/16	1/4	126-3B	1
1/4	1/8	126-4A	1
1/4	1/4	126-4B	1
1/4	3/8	126-4C	1
5/16	1/8	126-5A	1
5/16	1/4	126-5B	1
5/16	3/8	126-5C	1
3/8	1/8	126-6A	1
3/8	1/4	126-6B	1
3/8	3/8	126-6C	1
3/8	1/2	126-6D	1

## Splicer



» Hex Shoulder

Hose ID	Part #	Qty
3/16	129-3	1
1/4	129-4	1
5/16	129-5	1
3/8	129-6	1
1/2	129-8	1

## 90° Male Elbow

» Hose Barb to Male Pipe

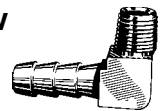

Hose ID	Pipe	Part #	Qty
1/4	1/8	139-4A	1
1/4	1/4	139-4B	1
5/16	1/8	139-5A	1
5/16	1/4	139-5B	1
3/8	1/8	139-6A	1
3/8	1/4	139-6B	1
3/8	3/8	139-6C	1
1/2	1/4	139-8B	1
1/2	3/8	139-8C	1
5/8	3/8	139-10C	1
5/8	1/2	139-10D	1

# BRASS GRIP-TITE REUSABLE HOSE FITTINGS

## HOSE SPLICER

All fittings can be ordered individually

### Hose Splicer Assembly Instructions

Lubricate Hose and barb.

Push hose on fitting until seated under protective cap.

No clamps required when used with grip-tite hose.

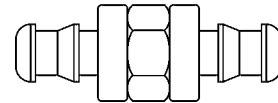
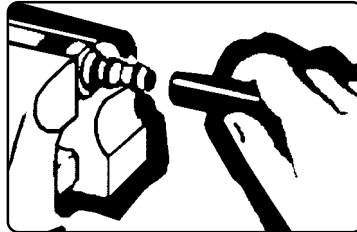

Hose ID	Part #	Qty
1/4	729-4	1
3/8	729-6	1
1/2	729-8	1
5/8	729-10	1
3/4	729-12	1

# BRASS SHUT-OFF & DRAIN COCKS

All fittings can be ordered individually

### Spring Bottom Shut-Off

- » Female to Male.
- » This series is not recommended to be used to convey liquids.

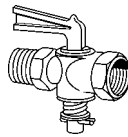

Pipe	Part #	Qty
1/8	2120-A	1
1/4	2120-B	1
3/8	2120-C	1

### Back Seating Type Drain Cock

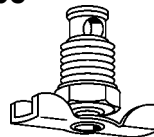

Hose ID	Part #	Qty
1/8	240-A	1
1/4	240-B	1
3/8	240-C	1
1/2	240-D	1

### Ground Key Plug Type Drain Cock

- » Lever Handle.

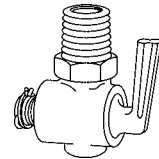

Hose ID	Part #	Qty
1/8	241-A	1
1/4	241-B	1
3/8	241-C	1
1/2	241-D	1

# FORGED BRASS BALL VALVES

All fittings can be ordered individually

### Spring Bottom Shut-Off

- » Female Pipe Ends.
- » Full port (100%).
- » UL \* FM approved waterservice ball valve.
- » \*WOG = water, oil and gas.
- » \*\*WSP = working stream pressure.



Pipe	WOG*	WSP**	Part #	Qty
1/4	500	150	BV2103-B	1
3/8	500	150	BV2103-C	1
1/2	500	150	BV2103-D	1
3/4	500	150	BV2103-E	1
1"	500	150	BV2103-H	1

# BRASS SAE 45° FLARE FITTINGS

All fittings can be ordered individually

## Forged Nut

» Long Type

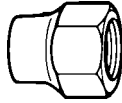

Tube	Part #	Qty
1/4	39-4	1
5/16	39-5	1
3/8	39-6	1
1/2	39-8	1
5/8	39-10	1
3/4	39-12	1

## Milled Nut

» Short Type

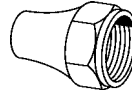

Tube	Length	Part #	Qty
1/8	1/2	41S-2	1
3/16	5/8	41S-3	1
1/4	3/4	41S-4	1
5/16	7/8	41S-5	1
3/8	7/8	41S-6	1
1/2	7/8	41S-8	1

## Connector

» Female Flare to Male Pipe

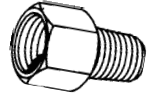

Tube	Pipe	Part #	Qty
1/4	1/8	33-4A	1
1/4	1/4	33-4B	1
3/8	1/4	33-6B	1
3/8	3/8	33-6C	1
1/2	3/8	33-8C	1
1/2	1/2	33-8D	1

## Forged Nut

» Short Type

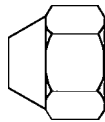

Tube	Part #	Qty
3/16	40-3	1
1/4	40-4	1
5/16	40-5	1
3/8	40-6	1
1/2	40-8	1
5/8	40-10	1
3/4	40-12	1

## Tube Coupling

» Female Flare to Female Flare

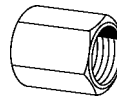

Tube	Part #	Qty
1/4	32-4	1
3/8	32-6	1

## Connector

» Tube to Male Pipe

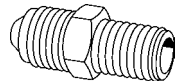

Tube	Pipe	Part #	Qty
1/8	1/8	48-2A	1
3/16	1/8	48-3A	1
1/4	1/8	48-4A	1
1/4	1/4	48-4B	1
1/4	3/8	48-4C	1
1/4	1/2	48-4D	1
5/16	1/8	48-5A	1
5/16	1/4	48-5B	1
5/16	3/8	48-5C	1
3/8	1/8	48-6A	1
3/8	1/4	48-6B	1
3/8	3/8	48-6C	1
3/8	1/2	48-6D	1
3/8	3/4	48-6E	1
7/16	1/4	48-7B	1
1/2	1/4	48-8B	1
1/2	3/8	48-8C	1
1/2	1/2	48-8D	1
1/2	3/4	48-8E	1
5/8	3/8	48-10C	1
5/8	1/2	48-10D	1
5/8	3/4	48-10E	1
3/4	1/2	48-12D	1
3/4	3/4	48-12E	1

## Milled Nut

» Long Type

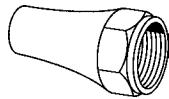

Tube	Length	Part #	Qty
1/8	3/4	41-2	1
3/16	13/16	41-3	1
1/4	15/16	41-4	1
5/16	1-1/8	41-5	1
3/8	1-5/16	41-6	1
1/2	1-5/8	41-8	1
5/8	1-7/8	41-10	1
3/4	2-3/16	41-12	1

## Union Coupling

» Tube to Tube

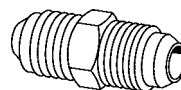

Tube	Part #	Qty
1/8	42-2	1
3/16	42-3	1
1/4	42-4	1
5/16	42-5	1
3/8	42-6	1
1/2	42-8	1
5/8	42-10	1
3/4	42-12	1

# BRASS SAE 45° FLARE FITTINGS

All fittings can be ordered individually

## Connector

» Tube to Female Pipe

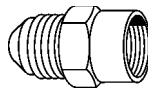

Tube	Pipe	Part #	Qty
3/16	1/8	46-3A	1
1/4	1/8	46-4A	1
1/4	1/4	46-4B	1
1/4	3/8	46-4C	1
5/16	1/8	46-5A	1
5/16	1/4	46-5B	1
5/16	3/8	46-5C	1
3/8	1/8	46-6A	1
3/8	1/4	46-6B	1
3/8	3/8	46-6C	1
3/8	1/2	46-6D	1
1/2	1/4	46-8B	1
1/2	3/8	46-8C	1
1/2	1/2	46-8D	1
1/2	3/4	46-8E	1
5/8	3/8	46-10C	1
5/8	1/2	46-10D	1
5/8	3/4	46-10E	1
3/4	1/2	46-12D	1
3/4	3/4	46-12E	1

## 90° Male Elbow

» Tube to Male Pipe

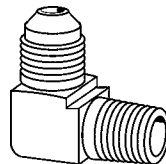

Tube	Pipe	Part #	Qty
1/8	1/8	49-2A	1
3/16	1/8	49-3A	1
3/16	1/4	49-3B	1
1/4	1/8	49-4A	1
1/4	1/4	49-4B	1
1/4	3/8	49-4C	1
1/4	1/2	49-4D	1
5/16	1/8	49-5A	1
5/16	1/4	49-5B	1
5/16	3/8	49-5C	1
5/16	1/2	49-5D	1
3/8	1/8	49-6A	1
3/8	1/4	49-6B	1
3/8	3/8	49-6C	1
3/8	1/2	49-6D	1
3/8	3/4	49-6E	1
1/2	1/4	49-8B	1
1/2	3/8	49-8C	1
1/2	1/2	49-8D	1
1/2	3/4	49-8E	1
5/8	3/8	49-10C	1
5/8	1/2	49-10D	1
5/8	3/4	49-10E	1
3/4	1/2	49-12D	1
3/4	3/4	49-12E	1

## 90° Female Elbow

» Tube to Female Pipe



Tube	Pipe	Part #	Qty
3/16	1/8	50-3A	1
1/4	1/8	50-4A	1
1/4	1/4	50-4B	1
1/4	3/8	50-4C	1
5/16	1/8	50-5A	1
5/16	1/4	50-5B	1
3/8	1/8	50-6A	1
3/8	1/4	50-6B	1
3/8	3/8	50-6C	1
3/8	1/2	50-6D	1
1/2	1/4	50-8B	1
1/2	3/8	50-8C	1
1/2	1/2	50-8D	1

## 45° Male Elbow

» Tube to Male Pipe

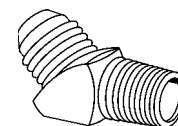

Tube	Pipe	Part #	Qty
1/4	1/8	54-4A	1
1/4	1/4	54-4B	1
5/16	1/8	54-5A	1
5/16	1/4	54-5B	1
3/8	1/4	54-6B	1
3/8	3/8	54-6C	1
3/8	1/2	54-6D	1
1/2	3/8	54-8C	1
1/2	1/2	54-8D	1
5/8	1/2	54-10D	1
3/4	1/2	54-12D	1
3/4	3/4	54-12E	1

## 90° Elbow

» Tube to Tube

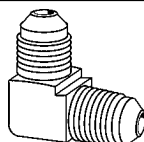

Tube	Part #	Qty
1/4	55-4	1
5/16	55-5	1
3/8	55-6	1
1/2	55-8	1
5/8	55-10	1
3/4	55-12	1

# BRASS SAE 45° FLARE FITTINGS

All fittings can be ordered individually

## Tee

- » Three Ends Tube

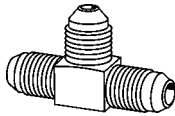

Tube	Part #	Qty
1/8	44-2	1
3/16	44-3	1
1/4	44-4	1
5/16	44-5	1
3/8	44-6	1
1/2	44-8	1
5/8	44-10	1
3/4	44-12	1

## Tee

- » Ends Tube
- » Center Pipe

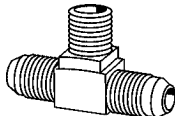

Tube	Pipe	Part #	Qty
3/16	1/8	45-3A	1
1/4	1/8	45-4A	1
1/4	1/4	45-4B	1
1/4	3/8	45-4C	1
5/16	1/8	45-5A	1
5/16	1/4	45-5B	1
3/8	1/8	45-6A	1
3/8	1/4	45-6B	1
3/8	3/8	45-6C	1
3/8	1/2	45-6D	1
1/2	1/4	45-8B	1
1/2	3/8	45-8C	1
1/2	1/2	45-8D	1
5/8	3/8	45-10C	1
5/8	1/2	45-10D	1
3/4	1/2	45-12D	1

## Tee

- » Ends Tube and Pipe
- » Center Tube

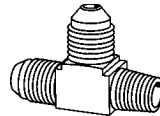

Tube	Pipe	Part #	Qty
1/4	1/8	51-4A	1
1/4	1/4	51-4B	1
1/4	3/8	51-4C	1
5/16	1/8	51-5A	1
5/16	1/4	51-5B	1
3/8	1/8	51-6A	1
3/8	1/4	51-6B	1
3/8	3/8	51-6C	1
3/8	1/2	51-6D	1
1/2	3/8	51-8C	1
1/2	1/2	51-8D	1
5/8	1/2	51-10D	1
3/4	1/2	51-12D	1

## Sealing Cap Nut



Tube	Part #	Qty
3/16	56-3	1
1/4	56-4	1
5/16	56-5	1
3/8	56-6	1
1/2	56-8	1
5/8	56-10	1
3/4	56-12	1

## Sealing Plug

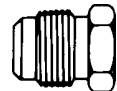

Tube	Part #	Qty
1/4	58-4	1
5/16	58-5	1
3/8	58-6	1
1/2	58-8	1
5/8	58-10	1

# BRASS SAE 45° INVERTED FLARE

All fittings can be ordered individually

## Brass Nut

Tube	Part #	Qty
1/8	141-2	1
3/16	141-3	1
1/4	141-4	1
5/16	141-5	1
3/8	141-6	1
1/2	141-8	1
5/8	141-10	1



## Coupling

» Tube to Tube

Tube	Part #	Qty
1/8	142-2	1
3/16	142-3	1
1/4	142-4	1
5/16	142-5	1
3/8	142-6	1
1/2	142-8	1

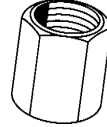

## 90° Elbow

» Tube to Tube

Tube	Part #	Qty
1/4	155-4	1

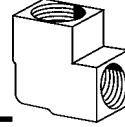

## Steel Nut

Tube	Part #	Qty
1/8	S141-2	1
3/16	S141-3	1
1/4	S141-4	1
5/16	S141-5	1
3/8	S141-6	1
7/16	S141-7	1
1/2	S141-8	1
5/8	S141-10	1
3/4	S141-12	1

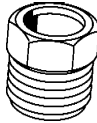

## Connector

» Tube to Female Pipe

Tube	Part #	Qty
3/16	146-3A	1
1/4	146-4A	1
5/16	146-5A	1
3/8	146-6B	1

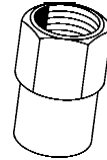

## 90° Male Elbow

» Tube to Male Pipe

Tube	Pipe	Part #	Qty
1/8	1/8	149-2A	1
3/16	1/8	149-3A	1
1/4	1/8	149-4A	1
1/4	1/4	149-4B	1
5/16	1/8	149-5A	1
5/16	1/4	149-5B	1
3/8	1/8	149-6A	1
3/8	1/4	149-6B	1
3/8	3/8	149-6C	1
7/16	1/4	149-7B	1
1/2	1/4	149-8B	1
1/2	3/8	149-8C	1
1/2	1/2	149-8D	1
5/8	3/8	149-10C	1
5/8	1/2	149-10D	1

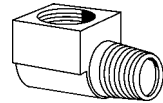

## Steel Nut

» Long Style

Tube	Part #	Qty
3/16	SL141-3	1
1/4	SL141-4	1

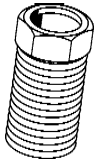

## Connector

» Tube to Male Pipe

Tube	Pipe	Part #	Qty
1/8	1/8	148-2A	1
3/16	1/8	148-3A	1
1/4	1/8	148-4A	1
1/4	1/4	148-4B	1
5/16	1/8	148-5A	1
5/16	1/4	148-5B	1
3/8	1/8	148-6A	1
3/8	1/4	148-6B	1
3/8	3/8	148-6C	1
7/16	1/4	148-7B	1
1/2	1/4	148-8B	1
1/2	3/8	148-8C	1
1/2	1/2	148-8D	1

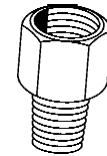

## Sealing Plug

Tube	Part #	Qty
3/16	PL141-3	1
1/4	PL141-4	1
5/16	PL141-5	1
3/8	PL141-6	1



# BRASS SAE 45° INVERTED FLARE

All fittings can be ordered individually

## 45° Male Elbow

» Tube to Male Pipe

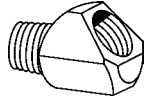

Tube	Pipe	Part #	Qty
3/16	1/8	154-3A	1
1/4	1/8	154-4A	1
5/16	1/8	154-5A	1
3/8	1/4	154-6B	1
1/2	3/8	154-8C	1

## Tee

» Three Ends Tube

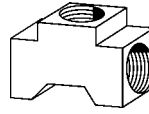

Tube	Part #	Qty
1/8	144-2	1
3/16	144-3	1
1/4	144-4	1
5/16	144-5	1
3/8	144-6	1
1/2	144-8	1

## Tee

» Ends Tube  
» Center Male Pipe

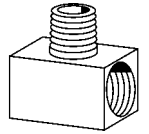

Tube	Pipe	Part #	Qty
3/16	1/8	145-3A	1
1/4	1/8	145-4A	1
5/16	1/8	145-5A	1
3/8	1/4	145-6B	1
1/2	3/8	145-8C	1

# SPECIAL BRAKE LINE FITTINGS

## Bubble Flare Tube Nut

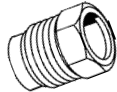

Tube	Metric Thread Size	Part #	Qty
3/16	10mm x 1.0	SE141-3	1
3/16	11mm x 1.5	SE141-3-11MM	1
3/16	12mm x 1.0	SE141-3-12MM	1
3/16	13mm x 1.5	SE141-3-13MM	1

## Fuel Line (GM) Nut

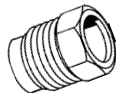

Tube	Metric Thread Size	Part #	Qty
5/16	14mm x 1.5	SFL-5-16MM	1
3/8	16mm x 1.5	SFL-6-14MM	1

## Steel Tube Nut

\*Metric

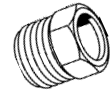

Tube	Thread Size	Color	Part #	Qty
3/16	7/16-24	Red	S141-3-7/16	1
3/16	1/2-20	Green	S141-3-1/2	1
3/16	9/16-18	Olive	S141-3-9/16	1
1/4	9/16-18	Blue	S141-4-1/4	1
1/4	1/2-20	Gold	S141-4-1/2	1
*3/16	10mm x 1.0	Violet	SLJ141-3	1

## Steel Nut

» Long Style



\*Metric

Tube	Part #	Qty
3/16	SL141-3	1
1/4	SL141-4	1
*3/16 x10mm x 1.0	SJ141-3	1

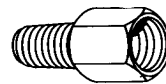

## Adapters & Unions

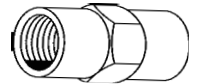

Tube	Metric Thread Size	Description	Part #	Qty
3/16	10mm x 1.0	Bubble Flare Adapter	SE143-3	1
3/16	10mm x 1.0	Bubble Flare Union	142EU-3	1
3/16	10mm x 1.0	Japanese Adapter	SJ143-3	1
3/16	10mm x 1.0	Japanese Union	142JA-3	1

# BRASS COMPRESSION FITTINGS

All fittings can be ordered individually

## Union Coupling

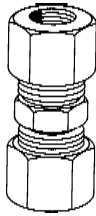

Tube	Part #	Qty
1/8	62-2	1
3/16	62-3	1
1/4	62-4	1
5/16	62-5	1
3/8	62-6	1
7/16	62-7	1
1/2	62-8	1
5/8	62-10	1
3/4	62-12	1

## Long Nut



Tube	Part #	Qty
1/8	161-2	1
1/4	161-4	1
5/16	161-5	1
3/8	161-6	1
7/16	161-7	1
1/2	161-8	1
5/8	161-10	1
3/4	161-12	1

## Female Connector

» Tube to Female Pipe

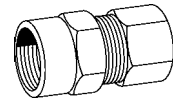

Tube	Pipe	Part #	Qty
1/8	1/8	66-2A	1
3/16	1/8	66-3A	1
1/4	1/8	66-4A	1
1/4	1/4	66-4B	1
1/4	3/8	66-4C	1
5/16	1/8	66-5A	1
5/16	1/4	66-5B	1
3/8	1/8	66-6A	1
3/8	1/4	66-6B	1
3/8	3/8	66-6C	1
3/8	1/2	66-6D	1
1/2	3/8	66-8C	1
1/2	1/2	66-8D	1

## Standard Sleeve



Tube	Part #	Qty
1/8	60-2	1
3/16	60-3	1
1/4	60-4	1
5/16	60-5	1
3/8	60-6	1
7/16	60-7	1
1/2	60-8	1
5/8	60-10	1
3/4	60-12	1

## Male Connector

» Tube to Male Pipe

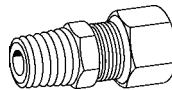

Tube	Pipe	Part #	Qty
1/8	1/16	68-2-1	1
1/8	1/8	68-2A	1
3/16	1/8	68-3A	1
3/16	1/4	68-3B	1
1/4	1/16	68-4-1	1
1/4	1/8	68-4A	1
1/4	1/4	68-4B	1
1/4	3/8	68-4C	1
1/4	1/2	68-4D	1
5/16	1/8	68-5A	1
5/16	1/4	68-5B	1
5/16	3/8	68-5C	1
5/16	1/2	68-5D	1
3/8	1/8	68-6A	1
3/8	1/4	68-6B	1
3/8	3/8	68-6C	1
3/8	1/2	68-6D	1
3/8	3/4	68-6E	1
7/16	1/4	68-7B	1
7/16	3/8	68-7C	1
1/2	1/4	68-8B	1
1/2	3/8	68-8C	1
1/2	1/2	68-8D	1
5/8	3/8	68-10C	1
5/8	1/2	68-10D	1
3/4	1/2	68-12D	1

## 45° Male Elbow

» Tube to Male Pipe

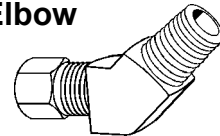

Tube	Pipe	Part #	Qty
3/16	1/8	74-3A	1
1/4	1/8	74-4A	1
1/4	1/4	74-4B	1
5/16	1/8	74-5A	1
3/8	1/4	74-6B	1
1/2	3/8	74-8C	1

## Standard Nut

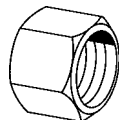

Tube	Part #	Qty
1/8	61-2	1
3/16	61-3	1
1/4	61-4	1
5/16	61-5	1
3/8	61-6	1
7/16	61-7	1
1/2	61-8	1
5/8	61-10	1
3/4	61-12	1

## 90° Male Elbow

» Tube to Tube

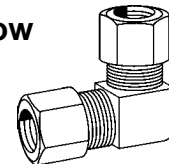

Tube	Part #	Qty
3/16	65-3	1
1/4	65-4	1
1/4	65-4	1
5/16	65-5	1
3/8	65-6	1
1/2	65-8	1



# BRASS COMPRESSION FITTINGS

All fittings can be ordered individually

## 90° Male Elbow

» Tube to Male Pipe

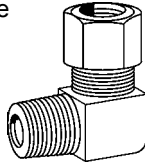

Tube	Pipe	Part #	Qty
1/8	1/8	69-2A	1
3/16	1/8	69-3A	1
3/16	1/4	69-3B	1
1/4	1/8	69-4A	1
1/4	1/4	69-4B	1
1/4	3/8	69-4C	1
1/4	1/2	69-4D	1
5/16	1/8	69-5A	1
5/16	1/4	69-5B	1
5/16	3/8	69-5C	1
5/16	1/2	69-5D	1
3/8	1/8	69-6A	1
3/8	1/4	69-6B	1
3/8	3/8	69-6C	1
3/8	1/2	69-6D	1
7/16	1/4	69-7B	1
7/16	3/8	69-7C	1
1/2	1/4	69-8B	1
1/2	3/8	69-8C	1
1/2	1/2	69-8D	1
5/8	3/8	69-10C	1
5/8	1/2	69-10D	1
5/8	3/4	69-10E	1
3/4	1/2	69-12D	1

## 90° Female Elbow

» Tube to Female Pipe

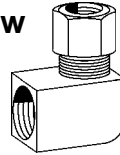

Tube	Pipe	Part #	Qty
3/16	1/8	70-3A	1
1/4	1/8	70-4A	1
1/4	1/4	70-4B	1
1/4	3/8	70-4C	1
5/16	1/8	70-5A	1
5/16	1/4	70-5B	1
3/8	1/8	70-6A	1
3/8	1/4	70-6B	1
3/8	3/8	70-6C	1
3/8	1/2	70-6D	1
1/2	1/4	70-8B	1
1/2	3/8	70-8C	1
1/2	1/2	70-8D	1

## Tee

» Three Ends Tube

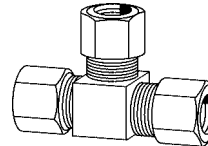

Tube	Part #	Qty
1/8	64-2	1
3/16	64-3	1
1/4	64-4	1
5/16	64-5	1
3/8	64-6	1
7/16	64-7	1
1/2	64-8	1

## Tee

» Ends Tube and Pipe  
» Center Tube

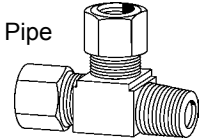

Tube	Pipe	Part #	Qty
3/16	1/8	71-3A	1
1/4	1/8	71-4A	1
1/4	1/4	71-4B	1
5/16	1/8	71-5A	1
5/16	1/4	71-5B	1
3/8	3/8	71-6A	1
3/8	1/4	71-6B	1
3/8	3/8	71-6C	1
1/2	3/8	71-8C	1
1/2	1/2	71-8D	1

## Tee

» Ends Tube  
» Center Pipe

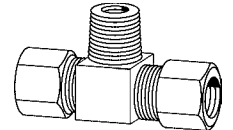

Tube	Pipe	Part #	Qty
3/16	1/8	72-3A	1
1/4	1/8	72-4A	1
1/4	1/4	72-4B	1
5/16	1/8	72-5A	1
5/16	1/4	72-5B	1
3/8	3/8	72-6A	1
3/8	1/4	72-6B	1
3/8	3/8	72-6C	1
1/2	3/8	72-8C	1
1/2	1/2	72-8D	1

# BRASS AIR BRAKE FITTINGS FOR COPPER TUBING — D.O.T. APPROVED

All fittings can be ordered individually

## Sleeve

Tube	Part #	Qty
1/4	1160-4	1
3/8	1160-6	1
1/2	1160-8	1
5/8	1160-10	1
3/4	1160-12	1



## Nut

Tube	Part #	Qty
1/4	1161-4	1
3/8	1161-6	1
1/2	1161-8	1
5/8	1161-10	1
3/4	1161-12	1

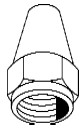

## Union Coupling

Tube	Part #	Qty
1/4	1162-4	1
3/8	1162-6	1
1/2	1162-8	1
5/8	1162-10	1
3/4	1162-12	1



## Female Connector

» Tube to Female Pipe

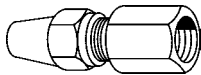

Tube	Pipe	Part #	Qty
1/4	1/8	1166-4A	1
1/4	1/4	1166-4B	1
3/8	1/8	1166-6A	1
3/8	1/4	1166-6B	1
3/8	3/8	1166-6C	1
1/2	3/8	1166-8C	1
1/2	1/2	1166-8D	1
5/8	3/8	1166-10C	1
5/8	1/2	1166-10D	1
3/4	1/2	1166-12D	1

## Male Connector

» Tube to Male Pipe

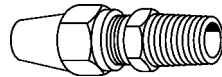

Tube	Pipe	Part #	Qty
1/4	1/8	1168-4A	1
1/4	1/4	1168-4B	1
3/8	1/8	1168-6A	1
3/8	1/4	1168-6B	1
3/8	3/8	1168-6C	1
3/8	1/2	1168-6D	1
1/2	1/4	1168-8B	1
1/2	3/8	1168-8C	1
1/2	1/2	1168-8D	1
1/2	3/4	1168-8E	1
5/8	3/8	1168-10C	1
5/8	1/2	1168-10D	1
5/8	3/4	1168-10E	1
3/4	1/2	1168-12D	1
3/4	3/4	1168-12E	1

## 90° Male Elbow

» Tube to Male Pipe

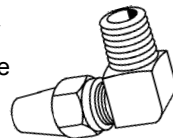

Tube	Pipe	Part #	Qty
1/4	1/8	1169-4A	1
1/4	1/4	1169-4B	1
3/8	1/8	1169-6A	1
3/8	1/4	1169-6B	1
3/8	3/8	1169-6C	1
3/8	1/2	1169-6D	1
1/2	1/4	1169-8B	1
1/2	3/8	1169-8C	1
1/2	1/2	1169-8D	1
1/2	3/4	1169-8E	1
5/8	3/8	1169-10C	1
5/8	1/2	1169-10D	1
5/8	3/4	1169-10E	1
3/4	1/2	1169-12D	1
3/4	3/4	1169-12E	1

## 90° Elbow

» Tube to Tube

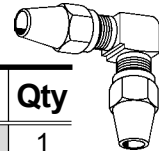

Tube	Part #	Qty
1/4	1165-4	1
3/8	1165-6	1
1/2	1165-8	1
5/8	1165-10	1
3/4	1165-12	1

## Tee

» Tube  
Three Ends

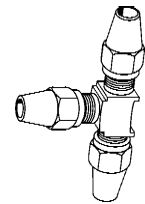

Tube	Part #	Qty
1/4	1164-4	1
3/8	1164-6	1
1/2	1164-8	1

## 45° Male Elbow

» Tube to Male Pipe

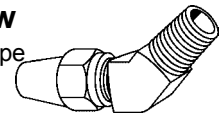

Tube	Pipe	Part #	Qty
1/4	1/8	1174-4A	1
1/4	1/4	1174-4B	1
3/8	1/4	1174-6B	1
3/8	3/8	1174-6C	1
1/2	3/8	1174-8C	1
1/2	1/2	1174-8D	1
5/8	1/2	1174-10D	1

## 90° Female Elbow

» Tube to  
Female Pipe

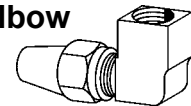

Tube	Pipe	Part #	Qty
1/4	1/8	1170-4A	1
1/4	1/4	1170-4B	1
3/8	1/8	1170-6A	1
3/8	1/4	1170-6B	1
3/8	3/8	1170-6C	1
1/2	3/8	1170-8C	1
1/2	1/2	1170-8D	1

# BRASS AIR BRAKE FITTINGS FOR S.A.E. J844D NYLON TUBING

All fittings can be ordered individually

## Brass Insert



Tube	Part #	Qty
1/8	1481-2	1
1/4	1481-4	1
3/8	1481-6	1
1/2	1481-8	1
5/8	1481-10	1
3/4	1481-12	1

## Sleeve



Tube	Part #	Qty
1/4	1460-4	1
3/8	1460-6	1
1/2	1460-8	1
5/8	1460-10	1
3/4	1460-12	1

## Nut



Tube	Part #	Qty
1/4	1461-4	1
3/8	1461-6	1
1/2	1461-8	1
5/8	1461-10	1
3/4	1461-12	1

## Union Coupling

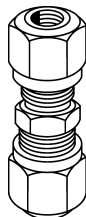

Tube	Part #	Qty
1/4	1462-4	1
3/8	1462-6	1
1/2	1462-8	1
5/8	1462-10	1
3/4	1462-12	1

## Female Connector

» Tube to Female Pipe

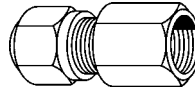

Tube	Pipe	Part #	Qty
1/4	1/8	1466-4A	1
1/4	1/4	1466-4B	1
3/8	1/8	1466-6A	1
3/8	1/4	1466-6B	1
3/8	3/8	1466-6C	1
1/2	3/8	1466-8C	1
1/2	1/2	1466-8D	1

## Connector

» Tube to Male Pipe

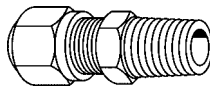

Tube	Pipe	Part #	Qty
1/4	1/8	1468-4A	1
1/4	1/4	1468-4B	1
3/8	1/8	1468-6A	1
3/8	1/4	1468-6B	1
3/8	3/8	1468-6C	1
3/8	1/2	1468-6D	1
1/2	1/4	1468-8B	1
1/2	3/8	1468-8C	1
1/2	1/2	1468-8D	1
1/2	3/4	1468-8E	1
5/8	3/8	1468-10C	1
5/8	1/2	1468-10D	1
5/8	3/4	1468-10E	1
3/4	1/2	1468-12D	1
3/4	3/4	1468-12E	1

## 90° Male Elbow

» Tube to Male Pipe

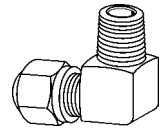

Tube	Pipe	Part #	Qty
1/4	1/8	1469-4A	1
1/4	1/4	1469-4B	1
3/8	1/8	1469-6A	1
3/8	1/4	1469-6B	1
3/8	3/8	1469-6C	1
3/8	1/2	1469-6D	1
1/2	1/4	1469-8B	1
1/2	3/8	1469-8C	1
1/2	1/2	1469-8D	1
1/2	3/4	1469-8E	1
5/8	3/8	1469-10C	1
5/8	1/2	1469-10D	1
5/8	3/4	1469-10E	1
3/4	1/2	1469-12D	1
3/4	3/4	1469-12E	1

## 90° Elbow

» Tube to Tube

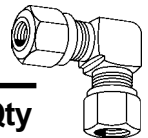

Tube	Part #	Qty
1/4	1465-4	1
3/8	1465-6	1
1/2	1465-8	1
5/8	1465-10	1
3/4	1465-12	1

## 45° Male Elbow

» Tube to Male Pipe

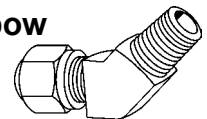

Tube	Pipe	Part #	Qty
1/4	1/8	1474-4A	1
1/4	1/4	1474-4B	1
3/8	1/4	1474-6B	1
3/8	3/8	1474-6C	1
1/2	3/8	1474-8C	1
1/2	1/2	1474-8D	1
5/8	1/2	1474-10D	1

# BRASS AIR BRAKE FITTINGS FOR S.A.E. J844D NYLON TUBING

All fittings can be ordered individually

## Tee

» Tube Three Ends

Tube	Part #	Qty
1/4	1464-4	1
3/8	1464-6	1
1/2	1464-8	1
5/8	1464-10	1
3/4	1464-12	1

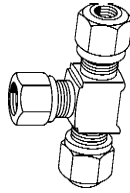

## Tee

» Ends Tube  
Center Male Pipe

Tube	Pipe	Part #	Qty
1/4	1/8	1472-4A	1
1/4	1/4	1472-4B	1
3/8	1/8	1472-6A	1
3/8	1/4	1472-6B	1
3/8	3/8	1472-6C	1
1/2	3/8	1472-8C	1
1/2	1/2	1472-8D	1

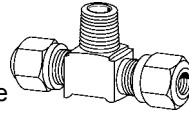

## Tee

» Ends Tube  
and Male Pipe  
Center Tube

Tube	Pipe	Part #	Qty
1/4	1/8	1471-4A	1
1/4	1/4	1471-4B	1
3/8	1/4	1471-6B	1
3/8	3/8	1471-6C	1
1/2	3/8	1471-8C	1
1/2	1/2	1471-8D	1

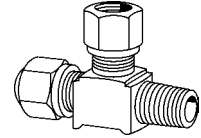

# BRASS PUSH-TO-CONNECT FITTINGS

## FOR USE WITH S.A.E J844D NYLON TUBE

All fittings can be ordered individually

## Union Coupling

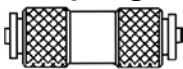

Tube	Part #	Qty
5/32	PC1462-5/32	1
1/4	PC1462-4	1
3/8	PC1462-6	1
1/2	PC1462-8	1
3/4	PC1462-10	1

## Male Adapter

» Tube to Male Pipe

Tube	Pipe	Part #	Qty
5/32	1/8	PC1468-5/32A	1
1/4	1/8	PC1468-4A	1
1/4	1/4	PC1468-4B	1
3/8	1/8	PC1468-6A	1
3/8	1/4	PC1468-6B	1
3/8	3/8	PC1468-6C	1
1/2	1/4	PC1468-8B	1
1/2	3/8	PC1468-8C	1
1/2	1/2	PC1468-8D	1

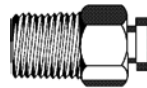

## 90° Male Elbow

» Tube to Male Pipe

Tube	Pipe	Part #	Qty
5/32	1/8	PC1469-5/32A	1
1/4	1/8	PC1469-4A	1
1/4	1/4	PC1469-4B	1
3/8	1/8	PC1469-6A	1
3/8	1/4	PC1469-6B	1
3/8	3/8	PC1469-6C	1
1/2	1/4	PC1469-8B	1
1/2	3/8	PC1469-8C	1
1/2	1/2	PC1469-8D	1

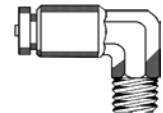

# VACUUM CONNECTORS

## VINYL VACUUM AND RUBBER CAPS

### Rubber Caps

- » Ford - GM - Chrysler
- » Special Heat Resistant EPDM Rubber.
- » Can be used for capping lines and hoses while testing carburetors, emission control systems, vacuum lines, etc.

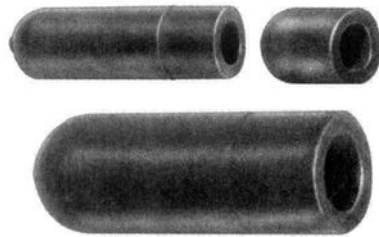

Fits Tube O.D.	Length	Part #	Qty
1/8	9/16	A12209	25
3/16	9/16	A4440	25
3/16	9/16	A16264	100
3/16	1-1/4	A19000	25
1/4	9/16	A4439	25
1/4	1-1/4	A19001	25
5/16	9/16	A19002	25
5/16	1-1/4	A12907	25
3/8	31/32	A12210	25
3/8	1-1/2	A19003	25
1/2	11/16	A12908	10

### Vinyl Vacuum Caps

- » Can be used for capping lines and hoses while testing carburetors, emission control systems, vacuum lines, etc.
- » Color coded for size identifications.



I.D.	Fits Tube O.D.	Color	Length	Part #	Qty
1/8	3/16	Blue	5/8	A18202	50
3/16	1/4	Red	5/8	A18203	50
1/4	5/16	White	5/8	A18204	50
5/16	3/8	Black	5/8	A18205	50

# VACUUM CONNECTORS

## NYLON

### Connector

» 1/8 x 1/8



**A12929**

Qty: 10

### Connector

» 1/8 x 1/4

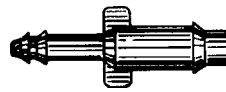

**A12936**

Qty: 10

### Connector

» 3/16 x 1/4

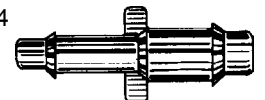

**A12935**

Qty: 10

### Connector

» 1/8 x 3/16

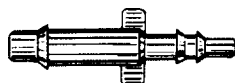

**A12930**

Qty: 10

### Connector

» 3/16 x 3/16



**A12937**

Qty: 10

### Connector

» 1/4 x 1/4



**A12931**

Qty: 10

# VACUUM CONNECTORS

## NYLON

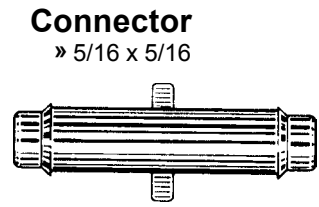

**A12946**  
Qty: 10

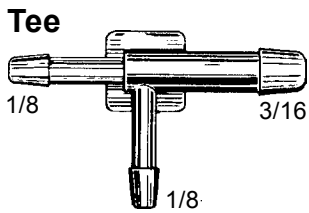

**A12916**  
Qty: 10

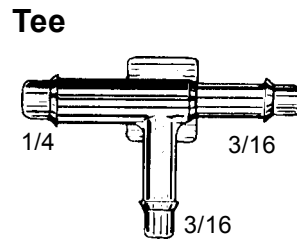

**A12919**  
Qty: 10

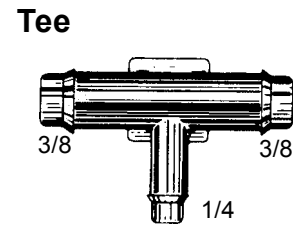

**A12921**  
Qty: 10

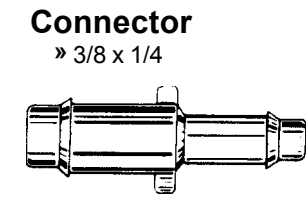

**A12938**  
Qty: 10

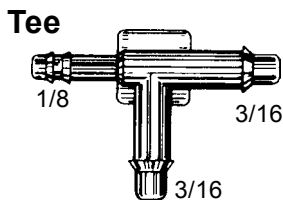

**A12924**  
Qty: 10

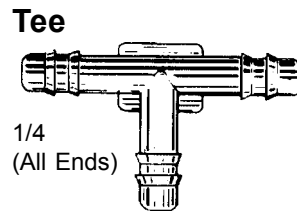

**A17629**  
Qty: 10

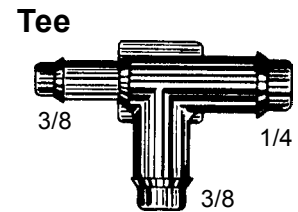

**A12922**  
Qty: 10

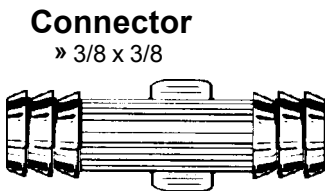

**A12934**  
Qty: 10

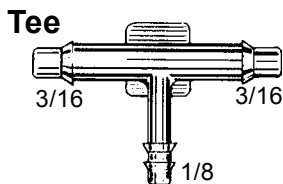

**A12926**  
Qty: 10

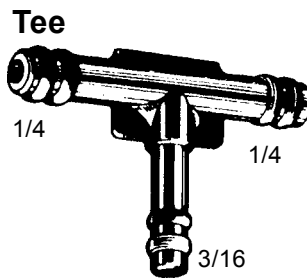

**A11738**  
Qty: 10

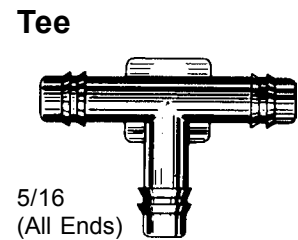

**A12920**  
Qty: 10

**Emissions Harness Connector Ford**  
» E1ZE-9E499-EA Nylon  
3/16 (Both)



**A18835**  
Qty: 10

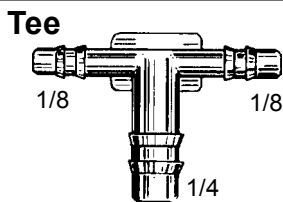

**A12917**  
Qty: 10

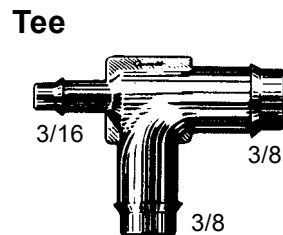

**A12941**  
Qty: 10

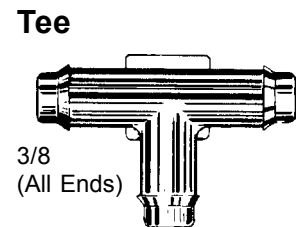

**A12925**  
Qty: 10

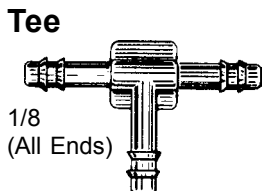

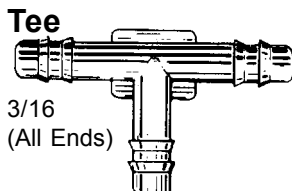

**A12923**  
Qty: 10



**A12918**  
Qty: 10

# VACUUM CONNECTORS

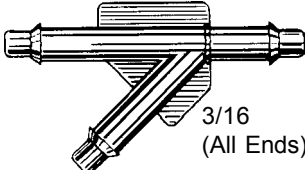
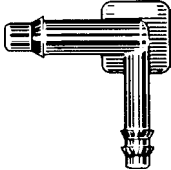
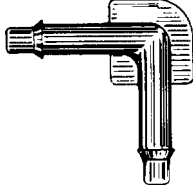
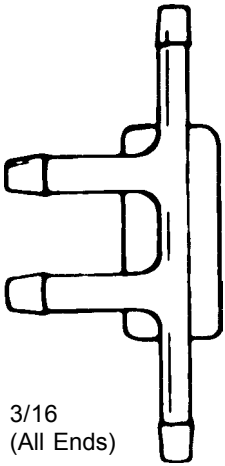
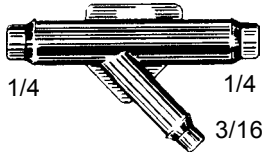
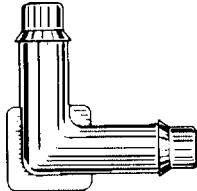
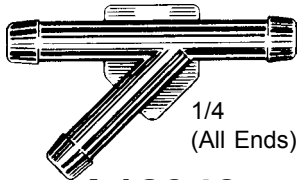
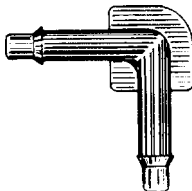
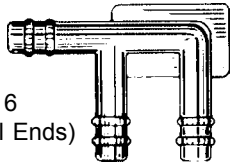
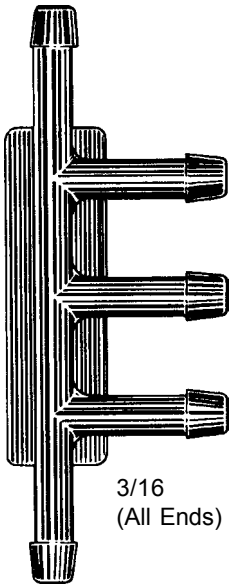
## NYLON

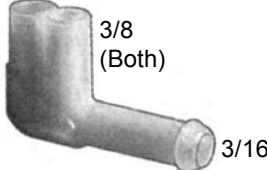
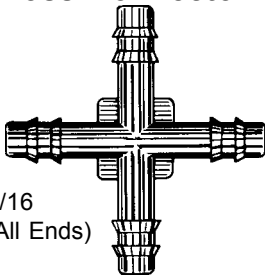
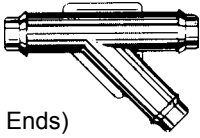
<p><b>Y Connector</b>              3/16            (All Ends)  <b>A12927</b>            Qty: 10</p>	<p><b>Elbow</b>            » 1/8 x 3/16    <b>A12947</b>            Qty: 10</p>	<p><b>Elbow</b>            » 3/16 x 1/4    <b>A12948</b>            Qty: 10</p>	<p><b>4 Way Tee</b>              3/16            (All Ends)  <b>A11419</b>            Qty: 25</p>
<p><b>Y Connector</b>              1/4 1/4            3/16  <b>A12945</b>            Qty: 10</p>	<p><b>Elbow</b>            » 1/4 x 1/4    <b>A12933</b>            Qty: 10</p>		
<p><b>Y Connector</b>              1/4            (All Ends)  <b>A12943</b>            Qty: 10</p>	<p><b>Elbow</b>            » 3/16 x 3/16    <b>A12932</b>            Qty: 10</p>	<p><b>F Connector</b>              3/16            (All Ends)  <b>A12940</b>            Qty: 10</p>	<p><b>5 Way Tee</b>              3/16            (All Ends)  <b>A12949</b>            Qty: 5</p>
<p><b>Y Connector</b>              5/16            (All Ends)  <b>A12944</b>            Qty: 10</p>	<p><b>Emissions Harness            Elbow Connector            Ford</b>            » E1ZE-9E499-CA              3/8            (Both)  <b>A18836</b>            Qty: 25</p>	<p><b>Cross Connector</b>              3/16            (All Ends)  <b>A12939</b>            Qty: 5</p>	
<p><b>Y Connector</b>              3/8            (All Ends)  <b>A12928</b>            Qty: 5</p>			

# VACUUM CONNECTORS

## UNIVERSAL

### Hose Connectors

- » Barbed on all sides.
- » \*Single barb on each end.



Hose Size	Part #	Qty
1/8 x 1/8	A10101*	10
3/16 x 3/16	A10102	10
1/4 x 1/4	A10103	10
5/16 x 5/16	A10104	10
3/8 x 3/8	A10105	10
1/2 x 1/2	A16961	10

### Reducer Connectors

- » Barbed on all sides.

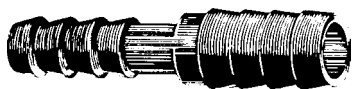

Hose Size	Part #	Qty
1/4 x 3/16	A10106	10
3/8 x 1/4	A10107	10

### Tubing & Hose Tee Connectors

- » Barbed on all sides.

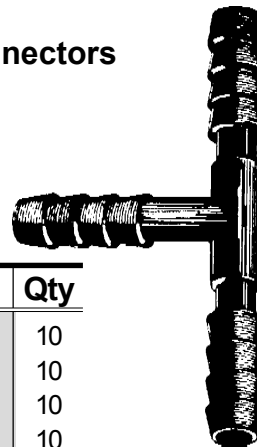

Hose Size I.D.	Part #	Qty
5/16 x 5/32 x 5/32	A10108	10
3/16 x 3/16 x 3/16	A10109	10
1/4 x 1/4 x 1/4	A10110	10
5/16 x 5/16 x 5/16	A14813	10
3/8 x 3/8 x 3/8	A11228	10
1/2 x 1/2 x 1/2	A11229	10

### Tee Connector

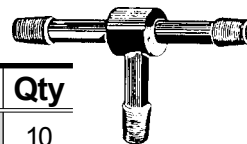

Hose Size I.D.	Part #	Qty
1/8 x 1/8 x 1/8	10697	10

### 4-Way Universal Break-Off Connector

- » Shown actual size.
- » For 1/8, 1/4, and 3/8 tubing.
- » Not for fuel line.

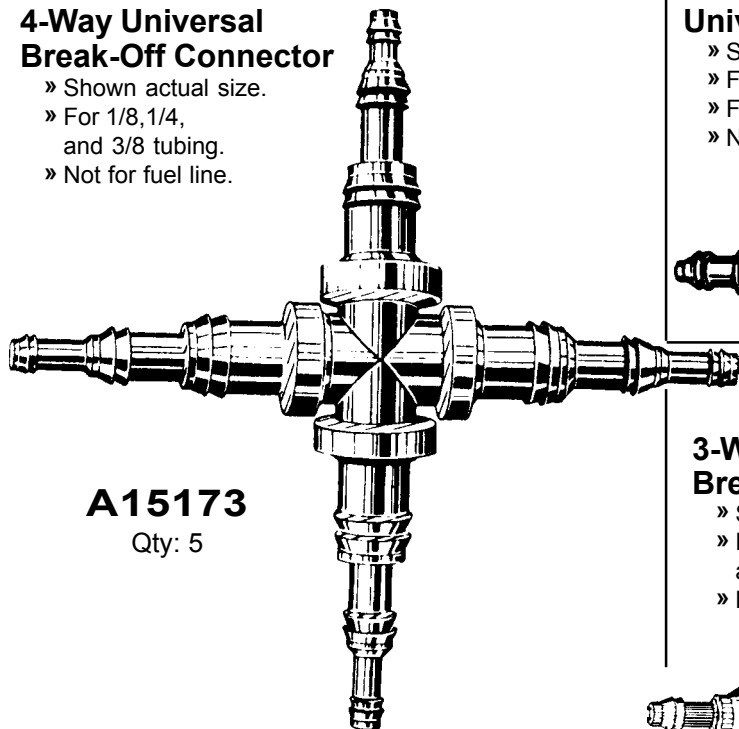

**A15173**

Qty: 5

### Universal Tubing Connector

- » Shown actual size.
- » For 1/8, 1/4, and 3/8 tubing.
- » For use with vacuum and windshield washer tubing.
- » Not for fuel line.

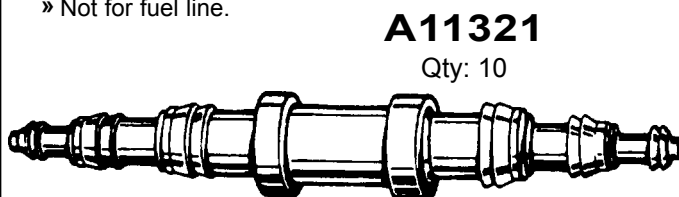

**A11321**

Qty: 10

### 3-Way Universal Break-Off Tee

- » Shown actual size.
- » For 1/8, 1/4, and 3/8 tubing.
- » Not for fuel line.

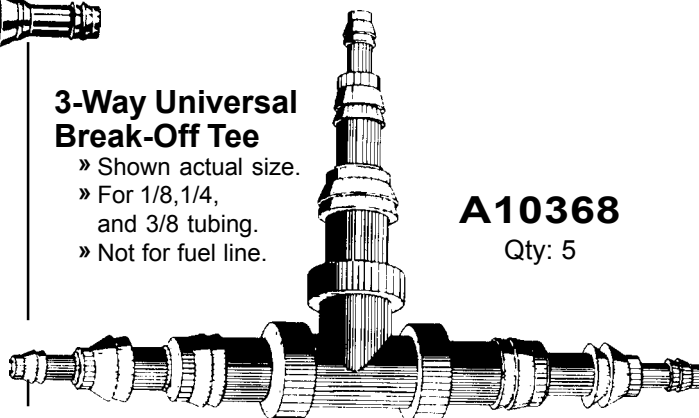

**A10368**

Qty: 5



# VACUUM CONNECTORS

## UNIVERSAL

### Santoprene Rubber

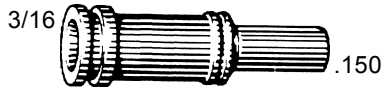

**A16652**

Qty: 25

### Santoprene Rubber

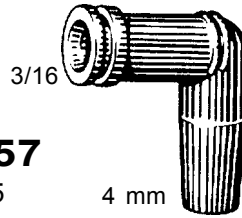

**A16657**

Qty: 25

### Santoprene Rubber

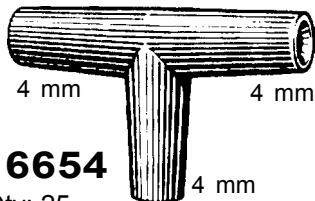

**A16654**

Qty: 25

### EPDM Rubber

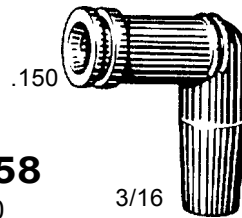

**A16658**

Qty: 10

### Santoprene Rubber

» GM: 4179397

**A18840**

Qty: 15



# VACUUM CONNECTORS

## HIGH-DENSITY BLACK POLYETHYLENE

### Tubing & Hose Adapters

» Non-Corrosive



Pipe Thread	Hose Size I.D.	Part #	Qty
1/8	3/16	A11209	10
1/8	1/4	A11210	10
1/4	3/16	A11211	10
1/4	1/4	A11212	10
1/4	3/8	A11213	10
3/8	3/8	A11214	10
3/8	1/2	A11215	10
1/2	1/2	A11216	10

### Tubing & Hose Elbows

» Non-Corrosive

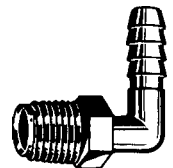

Pipe Thread	Hose Size I.D.	Part #	Qty
1/8	3/16	A11217	10
1/8	1/4	A11218	10
1/4	1/4	A11219	10
1/4	3/8	A11220	10
3/8	3/8	A11221	10
3/8	1/2	A12222	10

### Tubing & Hose Elbows

» Non-Corrosive

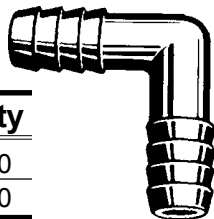

Hose Size I.D.	Part #	Qty
3/8 x 3/8	A11224	10
1/2 x 1/2	A11225	10

### Tubing & Hose Tee Connectors

» Non-Corrosive

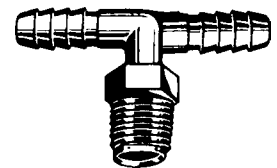

Pipe Thread	Hose Size I.D.	Part #	Qty
1/4	1/4 x 1/4	A11226	10

# “O” RINGS

## BUNA-N AND VITON®

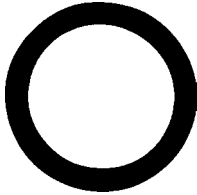

### Buna-N / Nitrile

» -30° to 250° F (-34° to 121° C)

Chemical resistance: aliphatic hydrocarbons (propane, butane, petroleum oil, mineral oil and grease, diesel fuel, fuel oils), vegetable and mineral oils and greases; HFA, HFB and HFC fluids; dilute acids, alkali and salt solutions at low temperatures; water (special compounds up to 212°F (100°C)).

» Not compatible with: fuels of high aromatic content (for flex fuels a special compound must be used); aromatic hydrocarbons (benzene); chlorinated hydrocarbons (trichloroethylene); polar solvents (ketone, acetone, acetic acid, ethylene-ester); strong acids; brake fluid with glycol base; ozone, weather and atmospheric aging.

### Viton® / Fluorocarbon

» -15° to 400° F (-26° to 205° C)

Chemical resistance: mineral oil and grease, low swelling in ASTM oil no. 1 and IRM 902 and IRM 903 oils; non-flammable hydraulic fuels in the group HFD; silicone oil and grease; mineral and vegetable oil and grease; aliphatic hydrocarbons (fuel, butane, propane, natural gas); aromatic hydrocarbons (benzene, toluene); chlorinated hydrocarbons (trichloroethylene and carbon tetrachloride); fuels, also fuels with methanol content; high vacuum; very good ozone, weather and aging resistance.

» Not compatible with: glycol-based brake fluids; ammonia gas, amines, alkalis; superheated steam; low-molecular-weight organic acids (formic and acetic acids).

Properties	Buna-N	Viton®
Abrasion Resistance	Good	Good
Acid Resistance	Fair	Excellent
Chemical Resistance	Fair/Good	Excellent
Cold Resistance	Good	Poor/Fair
Dynamic Properties	Good/Excellent	Good/Excellent
Electrical Properties	Fair	Fair
Flame Resistance	Poor	Excellent
Heat Resistance	Good	Excellent
Impermeability	Good	Good
Oil Resistance	Excellent	Excellent
Ozone Resistance	Poor	Excellent
Set Resistance	Good/Excellent	Good/Excellent
Tear Resistance	Fair/Good	Fair
Tensile Strength	Good/Excellent	Good/Excellent
Water/Steam Resistance	Fair/Good	Fair/Good
Weather Resistance	Fair	Excellent

Thickness	I.D.	O.D.	Part #		Qty
			Buna-N	Viton®	
<b>1/32</b>	1/32	3/32	<b>BUN-001</b>	<b>VIT-001</b>	50
	<b>3/64</b>	3/64	<b>BUN-002</b>	<b>VIT-002</b>	50
<b>1/16</b>	1/16	3/16	<b>BUN-003</b>	<b>VIT-003</b>	50
	5/64	13/64	<b>BUN-004</b>	<b>VIT-004</b>	50
	3/32	7/32	<b>BUN-005</b>	<b>VIT-005</b>	50
	1/8	1/4	<b>BUN-006</b>	<b>VIT-006</b>	50
	5/32	9/32	<b>BUN-007</b>	<b>VIT-007</b>	50
	3/16	5/16	<b>BUN-008</b>	<b>VIT-008</b>	50
	7/32	11/32	<b>BUN-009</b>	<b>VIT-009</b>	50
	1/4	3/8	<b>BUN-010</b>	<b>VIT-010</b>	50
	5/16	7/16	<b>BUN-011</b>	<b>VIT-011</b>	50
	3/8	1/2	<b>BUN-012</b>	<b>VIT-012</b>	50
	7/16	9/16	<b>BUN-013</b>	<b>VIT-013</b>	50
	1/2	5/8	<b>BUN-014</b>	<b>VIT-014</b>	50
	9/16	11/16	<b>BUN-015</b>	<b>VIT-015</b>	50
	5/8	3/4	<b>BUN-016</b>	<b>VIT-016</b>	50
	11/16	13/16	<b>BUN-017</b>	<b>VIT-017</b>	50
	3/4	7/8	<b>BUN-018</b>	<b>VIT-018</b>	50

# “O” RINGS

## BUNA-N AND VITON®

Thk.	I.D.	O.D.	Part #		Qty
			Buna-N	Viton®	
<b>1/16</b>	13/16	15/16	BUN-019	VIT-019	50
	7/8	1	BUN-020	VIT-020	50
	15/16	1-1/16	BUN-021	VIT-021	50
	1	1-1/8	BUN-022	VIT-022	50
	1-1/16	1-3/16	BUN-023	VIT-023	25
	1-1/8	1-1/4	BUN-024	VIT-024	25
	1-3/16	1-5/16	BUN-025	VIT-025	25
	1-1/4	1-3/8	BUN-026	VIT-026	25
	1-5/16	1-7/16	BUN-027	VIT-027	25
	1-3/8	1-1/2	BUN-028	VIT-028	25
	1-1/2	1-5/8	BUN-029	VIT-029	25
	1-5/8	1-3/4	BUN-030	VIT-030	25
	1-3/4	1-7/8	BUN-031	VIT-031	25
	1-7/8	2	BUN-032	VIT-032	25
	2	2-1/8	BUN-033	VIT-033	25
	2-1/8	2-1/4	BUN-034	VIT-034	25
	2-1/4	2-3/8	BUN-035	VIT-035	25
	2-3/8	2-1/2	BUN-036	VIT-036	25
	2-1/2	2-5/8	BUN-037	VIT-037	25
	2-5/8	2-3/4	BUN-038	VIT-038	10
	2-3/4	2-7/8	BUN-039	VIT-039	10
	2-7/8	3	BUN-040	VIT-040	10
	3	3-1/8	BUN-041	VIT-041	10
	3-1/4	3-3/8	BUN-042	VIT-042	10
	3-1/2	3-5/8	BUN-043	VIT-043	10
	3-3/4	3-7/8	BUN-044	VIT-044	10
	4	4-1/8	BUN-045	VIT-045	10
	4-1/4	4-3/8	BUN-046	VIT-046	10
	4-1/2	4-5/8	BUN-047	VIT-047	10
	4-3/4	4-7/8	BUN-048	VIT-048	10
5	5-1/8	BUN-049	VIT-049	10	
5-1/4	5-3/8	BUN-050	VIT-050	10	
<b>3/32</b>	3/16	3/8	BUN-106	VIT-106	50
	7/32	13/32	BUN-107	VIT-107	50
	1/4	7/16	BUN-108	VIT-108	50
	5/16	1/2	BUN-109	VIT-109	50
	3/8	9/16	BUN-110	VIT-110	50
	7/16	5/8	BUN-111	VIT-111	50
	1/2	11/16	BUN-112	VIT-112	50
	9/16	3/4	BUN-113	VIT-113	50
	5/8	13/16	BUN-114	VIT-114	50

Thk.	I.D.	O.D.	Part #		Qty
			Buna-N	Viton®	
<b>3/32</b>	11/16	5/8	BUN-115	VIT-115	50
	3/4	15/16	BUN-116	VIT-116	50
	13/16	1	BUN-117	VIT-117	50
	7/8	1-1/16	BUN-118	VIT-118	50
	15/16	1-1/8	BUN-119	VIT-119	50
	1	1-3/16	BUN-120	VIT-120	50
	1-1/16	1-1/4	BUN-121	VIT-121	25
	1-1/8	1-5/16	BUN-122	VIT-122	25
	1-3/16	1-3/8	BUN-123	VIT-123	25
	1-1/4	1-7/16	BUN-124	VIT-124	25
	1-5/16	1-1/2	BUN-125	VIT-125	25
	1-3/8	1-9/16	BUN-126	VIT-126	25
	1-7/16	1-5/8	BUN-127	VIT-127	25
	1-1/2	1-11/16	BUN-128	VIT-128	25
	1-9/16	1-3/4	BUN-129	VIT-129	25
	1-5/8	1-13/16	BUN-130	VIT-130	25
	1-11/16	1-7/8	BUN-131	VIT-131	25
	1-3/4	1-15/16	BUN-132	VIT-132	25
	1-13/16	2	BUN-133	VIT-133	25
	1-7/8	2-1/16	BUN-134	VIT-134	25
	1-15/16	2-1/8	BUN-135	VIT-135	25
	2	2-3/16	BUN-136	VIT-136	25
	2-1/16	2-1/4	BUN-137	VIT-137	10
	2-1/8	2-5/16	BUN-138	VIT-138	10
	2-3/16	2-3/8	BUN-139	VIT-139	10
	2-1/4	2-7/16	BUN-140	VIT-140	10
	2-5/16	2-1/2	BUN-141	VIT-141	10
	2-3/8	2-9/16	BUN-142	VIT-142	10
	2-7/16	2-5/8	BUN-143	VIT-143	10
	2-1/2	2-11/16	BUN-144	VIT-144	10
2-9/16	2-3/4	BUN-145	VIT-145	10	
2-5/8	2-13/16	BUN-146	VIT-146	10	
2-11/16	2-7/8	BUN-147	VIT-147	10	
2-3/4	2-15/16	BUN-148	VIT-148	10	
2-13/16	3	BUN-149	VIT-149	10	
2-7/8	3-1/16	BUN-150	VIT-150	10	
3	3-3/16	BUN-151	VIT-151	10	
3-1/4	3-7/16	BUN-152	VIT-152	10	
3-1/2	3-11/16	BUN-153	VIT-153	10	
3-3/4	3-15/16	BUN-154	VIT-154	10	
4	4-3/16	BUN-155	VIT-155	10	

# “O” RINGS

## BUNA-N AND VITON®

Thk.	I.D.	O.D.	Part #		Qty
			Buna-N	Viton®	
<b>3/32</b>	4-1/4	4-7/16	BUN-156	VIT-156	10
	4-1/2	4-11/16	BUN-157	VIT-157	10
	4-3/4	4-15/16	BUN-158	VIT-158	10
	5	5-3/16	BUN-159	VIT-159	10
	5-1/4	5-7/16	BUN-160	VIT-160	5
	5-1/2	5-11/16	BUN-161	VIT-161	5
	5-3/4	5-15/16	BUN-162	VIT-162	5
	6	6-3/16	BUN-163	VIT-163	5
<b>1/8</b>	3/8	5/8	BUN-204	VIT-204	50
	7/16	11/16	BUN-205	VIT-205	50
	1/2	3/4	BUN-206	VIT-206	50
	9/16	13/16	BUN-207	VIT-207	50
	5/8	7/8	BUN-208	VIT-208	50
	11/16	15/16	BUN-209	VIT-209	50
	3/4	1	BUN-210	VIT-210	50
	13/16	1-1/16	BUN-211	VIT-211	50
	7/8	1-1/8	BUN-212	VIT-212	50
	15/16	1-3/16	BUN-213	VIT-213	50
	1	1-1/4	BUN-214	VIT-214	50
	1-1/16	1-5/16	BUN-215	VIT-215	25
	1-1/8	1-3/8	BUN-216	VIT-216	25
	1-3/16	1-7/16	BUN-217	VIT-217	25
	1-1/4	1-1/2	BUN-218	VIT-218	25
	1-5/16	1-9/16	BUN-219	VIT-219	25
	1-3/8	1-5/8	BUN-220	VIT-220	25
	1-7/16	1-11/16	BUN-221	VIT-221	25
	1-1/2	1-3/4	BUN-222	VIT-222	25
	1-5/8	1-7/8	BUN-223	VIT-223	25
	1-3/4	2	BUN-224	VIT-224	25
	1-7/8	2-1/8	BUN-225	VIT-225	25
	2	2-1/4	BUN-226	VIT-226	25
	2-1/8	2-3/8	BUN-227	VIT-227	10
	2-1/4	2-1/2	BUN-228	VIT-228	10
	2-3/8	2-5/8	BUN-229	VIT-229	10
	2-1/2	2-3/4	BUN-230	VIT-230	10
	2-5/8	2-7/8	BUN-231	VIT-231	10
	2-3/4	3	BUN-232	VIT-232	10
	2-7/8	3-1/8	BUN-233	VIT-233	10
	3	3-1/4	BUN-234	VIT-234	10
3-1/8	3-3/8	BUN-235	VIT-235	10	
3-1/4	3-1/2	BUN-236	VIT-236	10	

Thk.	I.D.	O.D.	Part #		Qty
			Buna-N	Viton®	
<b>1/8</b>	3-3/8	3-5/8	BUN-237	VIT-237	10
	3-1/2	3-3/4	BUN-238	VIT-238	10
	3-5/8	3-7/8	BUN-239	VIT-239	10
	3-3/4	4	BUN-240	VIT-240	10
	3-7/8	4-1/8	BUN-241	VIT-241	10
	4	4-1/4	BUN-242	VIT-242	10
	4-1/8	4-3/8	BUN-243	VIT-243	5
	4-1/4	4-1/2	BUN-244	VIT-244	5
	4-3/8	4-5/8	BUN-245	VIT-245	5
	4-1/2	4-3/4	BUN-246	VIT-246	5
	4-5/8	4-7/8	BUN-247	VIT-247	5
	4-3/4	5	BUN-248	VIT-248	5
	4-7/8	5-1/8	BUN-249	VIT-249	5
	5	5-1/4	BUN-250	VIT-250	5
	5-1/8	5-3/8	BUN-251	VIT-251	5
	5-1/4	5-1/2	BUN-252	VIT-252	5
	5-3/8	5-5/8	BUN-253	VIT-253	5
	5-1/2	5-3/4	BUN-254	VIT-254	5
	5-5/8	5-7/8	BUN-255	VIT-255	5
	5-3/4	6	BUN-256	VIT-256	5
	5-7/8	6-1/8	BUN-257	VIT-257	5
	6	6-1/4	BUN-258	VIT-258	5
	6-1/4	6-1/2	BUN-259	VIT-259	1
	6-1/2	6-3/4	BUN-260	VIT-260	1
	6-3/4	7	BUN-261	VIT-261	1
	7	7-1/4	BUN-262	VIT-262	1
	<b>3/16</b>	3/4	1-1/8	BUN-314	VIT-314
13/16		1-3/16	BUN-315	VIT-315	25
7/8		1-1/4	BUN-316	VIT-316	25
15/16		1-5/16	BUN-317	VIT-317	25
1		1-3/8	BUN-318	VIT-318	25
1-1/16		1-7/16	BUN-319	VIT-319	25
1-1/8		1-1/2	BUN-320	VIT-320	25
1-3/16		1-9/16	BUN-321	VIT-321	25
1-1/4		1-5/8	BUN-322	VIT-322	25
1-5/16		1-11/16	BUN-323	VIT-323	25
1-3/8		1-3/4	BUN-324	VIT-324	25
1-1/2		1-7/8	BUN-325	VIT-325	25
1-5/8		2	BUN-326	VIT-326	10
1-3/4		2-1/8	BUN-327	VIT-327	10
1-7/8		2-1/4	BUN-328	VIT-328	10

# “O” RINGS

## BUNA-N AND VITON®

Thk.	I.D.	O.D.	Part #		Qty
			Buna-N	Viton®	
<b>3/16</b>	2	2-3/8	BUN-329	VIT-329	10
	2-1/8	2-1/2	BUN-330	VIT-330	10
	2-1/4	2-5/8	BUN-331	VIT-331	10
	2-3/8	2-3/4	BUN-332	VIT-332	10
	2-1/2	2-7/8	BUN-333	VIT-333	10
	2-5/8	3	BUN-334	VIT-334	10
	2-3/4	3-1/8	BUN-335	VIT-335	10
	2-7/8	3-1/4	BUN-336	VIT-336	10
	3	3-3/8	BUN-337	VIT-337	10
	3-1/8	3-1/2	BUN-338	VIT-338	10
	3-1/4	3-5/8	BUN-339	VIT-339	10
	3-3/8	3-3/4	BUN-340	VIT-340	10
	3-1/2	3-7/8	BUN-341	VIT-341	10
	3-5/8	4	BUN-342	VIT-342	5
	3-3/4	4-1/8	BUN-343	VIT-343	5
	3-7/8	4-1/4	BUN-344	VIT-344	5

Thk.	I.D.	O.D.	Part #		Qty
			Buna-N	Viton®	
<b>3/16</b>	4	4-3/8	BUN-345	VIT-345	5
	4-1/8	4-1/2	BUN-346	VIT-346	5
	4-1/4	4-5/8	BUN-347	VIT-347	5
	4-3/8	4-3/4	BUN-348	VIT-348	5
	4-1/2	4-7/8	BUN-349	VIT-349	5
	4-5/8	5	BUN-350	VIT-350	5
	4-3/4	5-1/8	BUN-351	VIT-351	5
	4-7/8	5-1/4	BUN-352	VIT-352	5
	5	5-3/8	BUN-353	VIT-353	5
	5-1/8	5-1/2	BUN-354	VIT-354	5
	5-1/4	5-5/8	BUN-355	VIT-355	5
	<b>1/4</b>	4-1/2	5	BUN-425	VIT-425
4-5/8		5-1/8	BUN-426	VIT-426	5
4-3/4		5-1/4	BUN-427	VIT-427	5
4-7/8		5-3/8	BUN-428	VIT-428	5
5		5-1/2	BUN-429	VIT-429	5

## “O” RING SPLICING KIT & “O” RING ASSORTMENTS

### “O” Ring Splicing Kit

» Contains one each of the following:



- Cyanacrylate adhesive.
- 7 feet of 3/32 cord.
- 7 feet of 1/8 cord.
- 7 feet of 3/16 cord.
- 7 feet of 1/4 cord.
- Razor blade.
- Splicing tool.
- Cutting tool.

Part #	Qty
A12976	1

### O-Ring Kits

- » 30 sizes.
- » 382 pieces.



Type	Part #	Qty
Standard	FK91000	1
Metric	FK91005	1

# GREASE FITTINGS

Ball Check Plated



**06900**

Qty: 25

**1/4-28, Straight**  
Thread Length: 7/32  
Overall Length: 9/16



**06904**

Qty: 25

**1/8 Pipe, Straight**  
Overall Length: 5/8

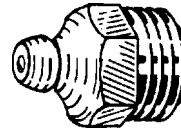

**06908**

Qty: 10

**1/4 Pipe, Straight**  
Overall Length: 27/32



**06901**

Qty: 25

**1/4-28, Straight**  
Overall Length: 15/16



**06905**

Qty: 25

**1/8 Pipe, Straight**  
Overall Length: 1-1/4

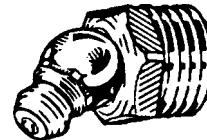

**06909**

Qty: 10

**1/4 Pipe, 65°**  
Overall Length: 1"



**06902**

Qty: 25

**1/4-28, 45°**  
Overall Length: 29/32

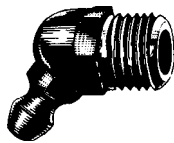

**06906**

Qty: 25

**1/8 Pipe, 45°**  
Overall Length: 1"

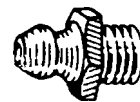

**06910**

Qty: 25

**5/16-24, Straight**  
Overall Length: 5/8

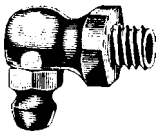

**06903**

Qty: 25

**1/4-28, 90°**  
Overall Length: 45/64

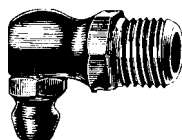

**06907**

Qty: 25

**1/8 Pipe, 90°**  
Overall Length: 53/34

For  
**Metric**  
**Grease Fittings**

See Page 8-21



**06911**

Qty: 25

**3/16 Drive Fit, Straight**  
Overall Length: 1/2



**06912**

Qty: 25

**1/4 Drive Fit, Straight**  
Overall Length: 1/2



**06913**

Qty: 25

**5/16 Drive Fit, Straight**  
Overall Length: 9/16

# LUBRICATION TOOLS

## GREASE GUNS & OIL CAN



### General Purpose Grease Gun

#### PLE-30445

- » A hard-working model with professional features.
- » 2-way loading; 14 oz. cartridge or suction.
- » Durable baked enamel finish.
- » Includes 5-3/8" pipe and coupler.
- » Develops up to 6,000 psi.
- » Delivers 1.6 oz./40 strokes.

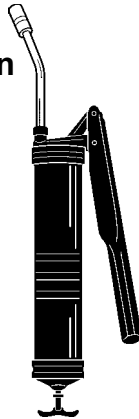

### General Purpose Mini Pistol Grease Gun Kit

#### PLE-30132

- » A compact "tool box" size grease gun perfect for hard-to-reach jobs.
- » Ideal for do-it-yourself automotive, industrial, farm, RV and marine applications.
- » Includes zinc die-cast head cap and pistol grip for easy one hand operation and 3 oz. cartridge of Lubrimatic® grease.
- » Develops up to 3,600 psi.

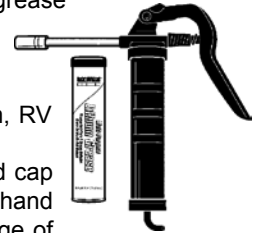

### Multi-Purpose Lithium Grease

#### CHE175

- » Long lasting, hard working formula delivers high performance in wide range of heavy-duty applications.
- » Recommended for chassis universal joints and other general purpose applications around the home, farm or shop.
- » Works best for lubricating rolling parts.
- » NLGI #1-1/2, drop point 350°.
- » 14 oz. cartridge.



### Multi-Purpose Lithium Grease Mini Cartridges

#### CHE176

- » Long lasting, hard working formula delivers high performance in wide range of heavy-duty applications.
- » Recommended for chassis universal joints and other general purpose applications around the home, farm or shop.
- » Works best for lubricating rolling parts.
- » NLGI #1-1/2, drop point 350°.
- » 3 oz. cartridge - 3/pk



### Pistol Oiler

#### PLE-50516

- » Drawn steel body with rugged epoxy finish resists rust.
- » 6 oz. capacity with base holder and 6" flex spout.
- » Flex spout is zinc plated and detachable with a base thread of 1/4-28.



# LUBRICATION TOOLS

## ACCESSORIES

### 4" Needle Nose Adapter

#### PLE-05025

- » Perfect for use on trucks, vans and RV's.
- » For converting jaw-type lube couplers to steel needle points.
- » Dispenses fine line of grease through the needle nose.
- » Both small and large sleeves fit all standard couplers.
- » Overall length 5-1/4", tip diameter .046", body diameter .250".
- » For hand operated grease guns only.



Part #	Qty
PLE-05025	1

### 3/4" Needle Nose Dispenser

#### PLE-05045

- » Dispenses a fine line of grease through needle nose. 3/4" adapter with 1/8" female NPT.
- » Use with extension or hose.
- » 19/32" needle length.
- » .046" tip diameter and .219" body diameter.
- » For hand operated grease guns only.



Part #	Qty
PLE-05045	1

### Standard Grease Gun Coupler

#### PLE-05031

- » Standard jaw-type coupler features spring loaded ball check valve.
- » For hand operated lube equipment only.
- » Fits all 1/8" NPT threads.
- » Recommended working pressure is 3,000 psi.

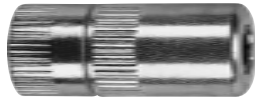

Part #	Qty
PLE-05031	1

### Grease Injector Needle

#### PLE-05037

- » Lubricates in very tight places such as universal joints and sealed bearings.
- » Stainless steel 18 gauge x 1-1/2" long needle.
- » Equipped with standard grease fitting and protective plastic holder.
- » For hand operated grease guns only.
- » Fits all 1/8" NPT threads.

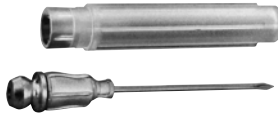

Part #	Qty
PLE-05037	1

### Standard Duty Whip Hoses

- » For use on hand operated grease guns only.
- » Steel 1/8" NPT male fittings on each end.
- » Recommended working pressure is 3,000 psi.
- » Burst pressure is 12,000 psi.
- » Meets U.S. Government Specifications MIL-L-4387C.

Part #	Qty
PLE-10212	1
PLE-10219	1

#### PLE-10212

- » 12" length.



#### PLE-10219

- » 18" length.





# AIR LINE FITTINGS AND ACCESSORIES

## AIR LINE COUPLERS & NIPPLES



### Quick Couplers and Nipples

- » Every coupler has a check valve which automatically shuts off the air the instant the unit is disconnected.
- » **Standard** couplers and nipples are for automotive tool use.
- » **Heavy duty** couplers have large air volume and nipples are case hardened.
- » **Extra heavy duty** couplers and nipples allow the largest air volume available.

» **Styles:**

- A** : Aro Interchange Series. (Standard)
- G** : Industrial Interchange Series. (Heavy Duty)
- L** : Lincoln Interchange Series. (Standard)
- M** : Milton Industrial Interchange Series. (Standard)
- P** : Tru-Flate/Parker Interchange Series. (Heavy Duty)
- T** : Tru-Flate/Parker Interchange Series. (Standard)

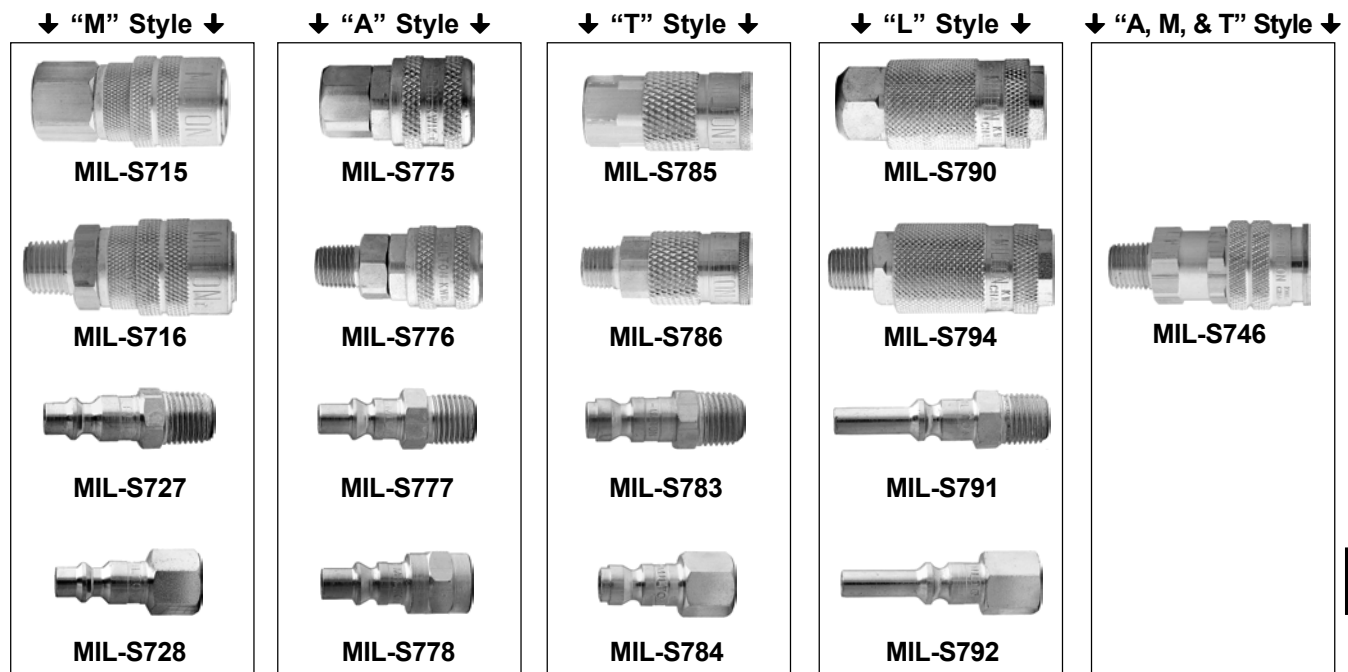

### Standard

Style	NPT Thread	Part #			
		Female Coupler	Male Coupler	Male Nipple	Female Nipple
M	1/4	MIL-S715	MIL-S716	*MIL-S727	*MIL-S728
L	1/4	MIL-S790	MIL-S794	*MIL-S791	*MIL-S792
T	1/4	MIL-S785	MIL-S786	*MIL-S783	*MIL-S784
A	1/4	MIL-S775	MIL-S776	*MIL-S777	*MIL-S778
A/M/T	1/4	—	MIL-S746	—	—

\* Sold in packages of 2 nipples.

# AIR LINE FITTINGS AND ACCESSORIES

## AIR LINE COUPLERS & NIPPLES



↓ “P” Style ↓



↓ “H” Style ↓



↓ “G” Style ↓



### Heavy Duty

Style	NPT Thread	Part #			
		Female Coupler	Male Coupler	Male Nipple	Female Nipple
P	1/4	MIL-S1803	—	*MIL-S1809	*MIL-S1810
P	3/8	MIL-S1805	MIL-S1806	*MIL-S1807	*MIL-S1808
H	1/4	MIL-S1833	—	*MIL-S1839	—
H	3/8	MIL-S1835	—	*MIL-S1837	—

\* Sold in packages of 2 nipples.

### Extra Heavy Duty

Style	NPT Thread	Part #			
		Female	Male Coupler	Male Nipple	Female Nipple
G	3/8		—	MIL-S1819	—
G	1/2		MIL-S1816	MIL-S1817	MIL-S1818

# AIR LINE FITTINGS AND ACCESSORIES

## BLO-GUNS



### Button Style Blo-Guns

#### MIL-S107

- » Indispensable for cleaning fuel and oil lines, air cleaners and car interiors; drying out wet ignition systems and spark plugs; blowing out dust, dirt filings, metal chips and hundreds of other uses.
- » Air inlet: 1/4 NPT.
- » Nozzle Thread: 1/2-27.
- » SCFM: 10.0 @ 100 PSI



Part #	Qty
MIL-S107	1

### Full Flow Safety Lever Style Blo-Guns

#### MIL-S150

- » A precision made instrument with hundreds of automotive and industrial uses in small and large industrial plants, airports, service stations or garages.
- » Lever easily controls air flow.
- » Air Inlet: 1/4" NPT.
- » Nozzle Thread: 1/2"-27.
- » SCFM: 10.0 @ 100 PSI.



Part #	Qty
MIL-S150	1

### Rubber Tip Blo-Guns

- » For positive leak-proof connection when blowing out any fluids.
- » A must where metal tip could mar delicate finish in molds or fresh paint.
- » Air Inlet: 1/4" NPT.
- » SCFM: 11.4 @ 100 PSI.

Part #	Qty
MIL-S153	1
MIL-S154	1

#### MIL-S153

- » Lever Blo-Gun with rubber tip



#### MIL-S154

- » Lever Blo-Gun with bent tube and rubber tip (for automatic transmission).



### Siphon Spray Blo-Gun Kit

#### MIL-S157

- » Excellent for degreasing engines and parts; spray livestock, plants and flowers; cleaning walls, grease bays and driveways; and rustproofing tools and machinery.
- » Complete with 8' of tubing and pouch.
- » Air Inlet: 1/4" NPT.
- » SCFM: 13.7 @ 100 PSI.



Part #	Qty
MIL-S157	1

### Deluxe Multi-Purpose Blo-Gun Kit

#### MIL-S165

- » Four Blo-Guns in one with an adjustable trigger for precise air control makes it ideal for sand blasting, spraying, cleaning, liquid transfer and air broom drying.
- » Made of strong and durable Cylolac®.
- » Handle provides storage for unused nozzles.
- » 175 Maximum PSI.
- » Air Inlet: 1/4" NPT.
- » SCFM: 10.6 to 11.4 @ 100 PSI
- » All nozzles 1/8" NPS.

Part #	Qty
MIL-S165	1



# AIR LINE FITTINGS AND ACCESSORIES

## AIR LINE ACCESSORIES

### ATD Air Regulator

#### ATD-6752

- » For air tools not originally equipped with regulators.
- » Fits any 1/4" NPT female inlet opening



Part #	Qty
ATD-6752	1

### ATD Air Control Gauge

#### ATD-6753

- » Adjusts air pressure at the air tool.
- » Ideal for spray guns to avoid costly painting errors such as poor color match, runs, poor coverage, orange peel, etc.
- » With accurate 0-160 lb. gauge.



Part #	Qty
ATD-6753	1

### Marvel Air Tool Oil

- » Lubricates & protects, removes gummy deposits.
- » For all piston-type and rotary air tools
- » Prevents rust formulation.
- » Longer tool life, smoother starting.
- » Contains antioxidants and rust inhibitors.
- » Do not use with Air Nailers.

Part #	Qty
MVL-080	1
MVL-085	1

#### MVL-080

- » 4 oz. Applicator can.
- » Mini case: 12.



#### MVL-085

- » Quart can.
- » Popular choice of mechanics.
- » Specially engineered for all piston and rotary-type air tools.



### Air Line Chucks

- » Sealing type chucks.
- » Not to be used with automatic inflator gauges.

Part #	Qty
MIL-S690	1
MIL-S691	1
MIL-S693	1
MIL-S698	1
MIL-S699	1

#### MIL-690

- » Dual head chuck.
- » Air Inlet: 1/4" female NPT.



#### MIL-S691

- » Straight head air chuck.
- » Air Inlet: 1/4" female NPT.



#### MIL-S693

- » Dual head straight foot air chuck for inner duals.
- » Lock on threads on both ends.
- » Air Inlet: 1/4" NPT.



#### MIL-S698

- » Chuck clip with female safety grip air chuck.
- » Air Inlet: 1/4" NPT.



#### MIL-S699

- » Single head female air chuck.
- » Air Inlet: 1/4" NPT.



### Air Hose Repair Kit

#### MIL-620

- » Sealing type chuck.
- » Not to be used with automatic inflator gauges.

#### Repair Kit Consists of:

- » Female air chuck (1/4" NPT)
- » Male hose end (1/4" NPT x 1/4" ID hose).
- » Hose mender (1/4" ID hose both ends).
- » Hose clamps (5/8" OD hose).



Part #	Qty
MIL-S620	1

# AIR LINE FITTINGS AND ACCESSORIES

## TIRE VALVING & GAGES



### Brass Valve Extensions

- » Dust cover design allows pressure check, inflation or deflation without removing cap.
- » Threaded for valve caps and and/or wheel cover locks.

Part #	Qty
MIL-S441	1
MIL-S442	1

#### MIL-S441

- » 3/4" effective length.



#### MIL-S442

- » 1-1/4" effective length.



### Tire Tread Depth Gauge

#### MIL-S448

- » Measures conventional tire thread depth as well as "spine threads".
- » Round aluminum indicator bar calibrated to 0 - 1" in 1/32" markings.
- » Handy pocket clip.



Part #	Qty
MIL-S448	1

### Bayonet Airline Gauge

#### MIL-S522

- » Dual head (truck) chuck.
- » Large Black numbers on jumbo white nylon indicator bar.
- » 10 lbs. To 120 lbs. in 2 lb increments.
- » Large red numbers on two sides from 80 to 840 kilo pascals in 20 kPa increments.



Part #	Qty
MIL-S522	1

### Window Inflator Gauge

- » Top quality pencil type gauge.
- » 2 sides 20 to 120 PSI in 2 lb. increments and 2 sides kilo Pascals (kPa) 120 to 820 kPa increments.
- » Made in the U.S.A.

Part #	Qty
MIL-S925	1
MIL-S927	1

#### MIL-S925

- » Used best with RV's trucks and bicycles.



#### MIL-S927

- » Dual chuck truck tire gauge.



### Valve core tool

#### MIL-S444

- » For removal or insertion of valve cores.
- » One end for large bore valve cores.
- » One end for standard valve cores.



Part #	Qty
MIL-S444	1

### Window Inflator Gauges

- » Heavy duty to withstand everyday use and abuse and provide long service life.

Part #	Qty
MIL-S506	1
MIL-S507	1
MIL-S512	1

#### MIL-S506

- » Magnifying lens allows full view of scale for accurate reading.
- » 10 lbs. To 120 lbs. in 2 lb increments.
- » Dual Head Chuck (Full Swivel).



#### MIL-S507

- » Replacement Gage Cartridge.



#### MIL-S512

- » Replacement Valve Cartridge.



### Dial Type Tire Gage

- » Rugged bronze bourdon tube and fully geared brass movement designed to stay accurate.
- » 2" face, easy to read dial with unbreakable crystal.
- » Pressure is indicated on dial until release valve is depressed.
- » Every gauge is tested and checked on a master gauge prior to packaging.
- » For passenger cars and other vehicles.
- » Made in the U.S.A.

Part #	Qty
MIL-S902	1
MIL-S903	1

#### MIL-S902

- » Angled single head chuck.
- » 0-60 PSI in 1lb. increments.

#### MIL-S903

- » Angled single head chuck.
- » 0-160 PSI in 2 lb. increments.



# TIRE ACCESSORIES

## TUBELESS TIRE VALVE STEMS



AP-TR413B



AP-TR418B



AP-TR423B



AP-TR415B



AP-TR425B

Rim Hole Dia.	Effective Length	Part #	Qty
.453"	1-1/4"	AP-TR413B	50
.453"	2"	AP-TR418B	50
.453"	2-1/2"	AP-TR423B	50
.625"	1-1/2"	AP-TR415B	50
.625"	2"	AP-TR425B	50

## CORES, CAPS & EXTENSIONS



AP-300S



AP-319



AP-317



AP-316



AP-306



MIL-434



MIL-435

Description	Part #	Qty
Valve Core	AP-300S	100
3/4" Plastic Valve Extension	AP-319	50
1-1/4" Plastic Valve Extension	AP-317	50
1-1/2" Plastic Valve Extension	AP-316	20
Plastic Valve Cap	AP-306	100
Heavy Knurl Nickel Plated Valve Cap	MIL-434	50
Hex Head Brass Chrome Plated Cap	MIL-435	50

# WHEEL BALANCING WEIGHTS

## STANDARD SIZES

---



### **P Series** : Standard Steel Type Wheel Weights

» Designed for passenger car steel rims 13" - 16", this series uses a "dovetail" clip to insure double retention. Used, also, in place of European, two piece, wheel weights.

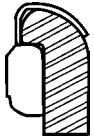

### **AAW Series**: Alloy Type Wheel Weights - Coated & Uncoated

» Designed especially for American alloy OEM wheels. By far, our most popular clip on mag wheel weight. Fits many after market wheels 13" - 17". Coated weights' polyester coating is approved by automobile OEMs to protect wheels from the electrolysis caused by lead corrosion which will permanently damage expensive alloy or mag wheels.



### **MC Series**: Alloy Type Wheel Weights - Coated & Uncoated

» Designed to fit Ford, AMC, Newer GM, and Chrysler products including some imports with alloy wheels. Coated weights' polyester coating is approved by automobile OEMs to protect wheels from the electrolysis caused by lead corrosion which will permanently damage expensive alloy or mag wheels.



### **LH Series**: Alloy Type Wheel Weights - Coated

» This series is used on the new Chrysler, Dodge, and Plymouth. Weights are coated with a polyester coating approved by automobile OEMs to protect wheels.

**All Weights Packed 25 pcs. per Box**

Size	P Series Part #	AAW Coated Part #	AAW Uncoated Part #	MC Coated Part #	MC Uncoated Part #	LH Series Part #
1/4 oz.	HAL-78025	HAL-AAW025C	HAL-AAW025U	HAL-MC025C	HAL-MC025U	HAL-LH025C
1/2 oz.	HAL-78050	HAL-AAW050C	HAL-AAW050U	HAL-MC050C	HAL-MC050U	HAL-LH050C
3/4 oz.	HAL-78075	HAL-AAW075C	HAL-AAW075U	HAL-MC075C	HAL-MC075U	HAL-LH075C
1 oz.	HAL-78100	HAL-AAW100C	HAL-AAW100U	HAL-MC100C	HAL-MC100U	HAL-LH100C
1 1/4 oz.	HAL-78125	HAL-AAW125C	HAL-AAW125U	HAL-MC125C	HAL-MC125U	HAL-LH125C
1 1/2 oz.	HAL-78150	HAL-AAW150C	HAL-AAW150U	HAL-MC150C	HAL-MC150U	HAL-LH150C
1 3/4 oz.	HAL-78175	HAL-AAW175C	HAL-AAW175U	HAL-MC175C	HAL-MC175U	HAL-LH175C
2 oz.	HAL-78200	HAL-AAW200C	HAL-AAW200U	HAL-MC200C	HAL-MC200U	HAL-LH200C
2 1/4 oz.	HAL-78225	HAL-AAW225C	HAL-AAW225U	HAL-MC225C	HAL-MC225U	HAL-LH225C
2 1/2 oz.	HAL-78250	HAL-AAW250C	HAL-AAW250U	HAL-MC250C	HAL-MC250U	HAL-LH250C
2 3/4 oz.	HAL-78275	HAL-AAW275C	HAL-AAW275U	HAL-MC275C	HAL-MC275U	HAL-LH275C
3 oz.	HAL-78300	HAL-AAW300C	HAL-AAW300U	HAL-MC300C	HAL-MC300U	HAL-LH300C

# WHEEL BALANCING WEIGHTS

## METRIC SIZES



### IAW Series: Alloy Type Wheel Weights - Coated & Uncoated

» These **metric** weights are used on many import car alloy wheels. BMW, Mercedes, Nissan, Saab, Toyota, Volvo, and many more. Coated weights' polyester coating is approved by automobile OEMs to protect wheels from the electrolysis caused by lead corrosion which will permanently damage expensive alloy or mag wheels.

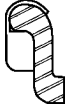

### FN Series: Alloy Type Wheel Weights - Coated

» This **metric** series is designed to fit many Japanese passenger automobiles with thicker rim factory alloy wheels and other after market wheels. Coated weights' polyester coating is approved by automobile OEMs to protect wheels from the electrolysis caused by lead corrosion which will permanently damage expensive alloy or mag wheels.



### EN Series: Alloy Type Wheel Weights - Coated

» These metric coated weights are designed for alloy wheels on early Acura, early Honda, and most Mercedes Benz. Weights are coated with a polyester coating approved by automobile OEMs to protect wheels.

All Weights Packed 25 pcs. per Box

Size	IAW Coated Part #	IAW Uncoated Part #	FN Uncoated Part #	EN Coated Part #
5 gram	HAL-IAW005C		HAL-FN005U	—
10 gram	HAL-IAW010C	HAL-IAW010U	HAL-FN010U	HAL-EN010C
15 gram	HAL-IAW015C	HAL-IAW015U	HAL-FN015U	HAL-EN015C
20 gram	HAL-IAW020C	HAL-IAW020U	HAL-FN020U	HAL-EN020C
25 gram	HAL-IAW025C	HAL-IAW025U	HAL-FN025U	HAL-EN025C
30 gram	HAL-IAW030C	HAL-IAW030U	HAL-FN030U	HAL-EN030C
35 gram	HAL-IAW035C	HAL-IAW035U	HAL-FN035U	HAL-EN035C
40 gram	HAL-IAW040C	HAL-IAW040U	HAL-FN040U	HAL-EN040C
45 gram	HAL-IAW045C	HAL-IAW045U	HAL-FN045U	HAL-EN045C
50 gram	HAL-IAW050C	HAL-IAW050U	HAL-FN050U	HAL-EN050C
55 gram	HAL-IAW055C	HAL-IAW055U	HAL-FN055U	—
60 gram	HAL-IAW060C	HAL-IAW060U	HAL-FN060U	—

11

## TWO PIECE METRIC WHEEL WEIGHTS



### MBN Series: Alloy Type Wheel Weights - Coated

» Designed to fit Mercedes Benz Wheels. OEM Two-Piece. Weights are coated with a polyester coating approved by automobile OEMs to protect wheels.



### BMN Series: Alloy Type Wheel Weights - Coated

» Designed to fit BMW Wheels. OEM Two-Piece. Weights are coated with a polyester coating approved by automobile OEMs to protect wheels.

Size	MBN Series Part #	BMN Series Part #
10 gram	HAL-MBN010C	HAL-BMN010C
15 gram	HAL-MBN015C	HAL-BMN015C
20 gram	HAL-MBN020C	HAL-BMN020C
25 gram	HAL-MBN025C	HAL-BMN025C
30 gram	HAL-MBN030C	HAL-BMN030C
35 gram	HAL-MBN035C	HAL-BMN035C
40 gram	HAL-MBN040C	HAL-BMN040C
45 gram	HAL-MBN045C	HAL-BMN045C
50 gram	HAL-MBN050C	HAL-BMN050C



# WHEEL BALANCING WEIGHTS

## TRUCK WEIGHTS



### LT1 Series: Light Truck Wheel Weights

» Designed for light truck, 3/4 and 1 ton, including some RV's. Tube and tubeless wheels. Used on rims that are too thick for our standard P series weights. Most popular of our light truck weights.

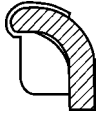

### TN Series: Light Truck Wheel Weights - Coated

» This weight is designed for 1988 and newer domestic Light Trucks. The gap between the clip and lead is made to accommodate these wheels. The special coating protects the wheel from corrosion damage, as well as being decorative.



### I7 Series: Medium Duty Truck Wheel Weights

» Used on most trucks with tube type rims. Most popular weight for medium to heavy duty trucks.



### CT Series: Medium Duty Truck Wheel Weights

» Formerly T-1 Series. Designed for Firestone duplex, Goodyear super single, Budd 7.50 & 8.25 wheels, except steel rims with curved edges. Common on tubeless rims.

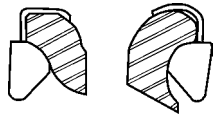

### TAL Series: Heavy Duty Truck Wheel Weights - Coated & Uncoated

» A weight for all Alcoa and Accuma aluminum tubeless heavy truck wheels. The weights will fit inside or outside of wheel. Made to replace A series truck weights.

All Weights Packed 25 pcs. per Box

Size	LT1 Series Part #	TN Series Part #	I7 Series Part #	CT Series Part #	TAL Coated Part #	TAL Uncoated Part #
1/4 oz.	—	HAL-TC025	—	—	—	—
1/2 oz.	HAL-LT050	HAL-TC050	—	—	—	—
3/4 oz.	—	HAL-TC075	—	—	—	—
1 oz.	HAL-LT100	HAL-TC100	HAL-E-01	—	—	—
1 1/4 oz.	—	HAL-TC125	—	—	—	—
1 1/2 oz.	HAL-LT150	HAL-TC150	—	—	—	—
1 3/4 oz.	—	HAL-TC175	—	—	—	—
2 oz.	HAL-LT200	HAL-TC200	HAL-E-02	HAL-CT-02	HAL-TAL-02C	—
2 1/4 oz.	HAL-LT225	HAL-TC225	—	—	—	—
2 1/2 oz.	HAL-LT250	HAL-TC250	—	—	—	—
2 3/4 oz.	HAL-LT275	HAL-TC275	—	—	—	—
3 oz.	HAL-LT300	HAL-TC300	HAL-E-03	HAL-CT-03	HAL-TAL-03C	HAL-TAL-03U
3-1/2 oz.	HAL-LT350	—	—	—	—	—
4 oz.	HAL-LT400	—	HAL-E-04	HAL-CT-04	HAL-TAL-04C	HAL-TAL-04U
4 1/2 oz.	HAL-LT450	—	—	—	—	—
5 oz.	HAL-LT500	—	HAL-E-05	—	—	—
6 oz.	HAL-LT600	—	HAL-E-06	HAL-CT-06	HAL-TAL-06C	HAL-TAL-06U
8 oz.	—	—	HAL-E-08	HAL-CT-08	HAL-TAL-08C	HAL-TAL-08U
10 oz.	—	—	HAL-E-10	HAL-CT-10	—	—
12 oz.	—	—	HAL-E-12	HAL-CT-12	—	—
14 oz.	—	—	HAL-E-14	HAL-CT-14	—	—

# WHEEL BALANCING WEIGHTS

## ADHESIVE STYLE

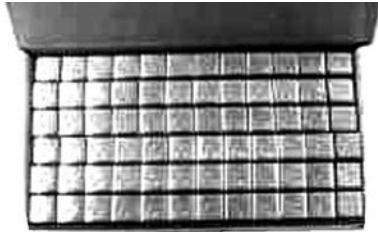

- » Holding fast with 3M acrylic tape.
- » Designed as Automotive wheel weights, but are useful for hobby uses, model construction, and is useful around the house or shop.

Increments	Part #	Qty.
1/2 oz.	<b>AW5101</b>	360
1/4 oz.	<b>AW100360</b>	360

# MUFFLER CLAMPS

## STANDARD & HEAVY DUTY

### Standard

5/16" U-Bolts, HD 13 gauge Saddle

Size	Part #	Qty
1-1/2"	<b>AP-R112</b>	1
1-5/8"	<b>AP-R158</b>	1
1-3/4"	<b>AP-R134</b>	1
1-7/8"	<b>AP-R178</b>	1
2"	<b>AP-R200</b>	1
2-1/8"	<b>AP-R218</b>	1
2-1/4"	<b>AP-R214</b>	1
2-1/2"	<b>AP-R212</b>	1

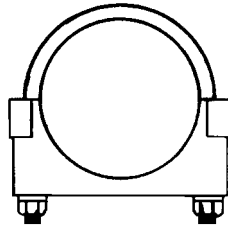

### Heavy Duty

3/8" U-Bolts, HD 11 gauge Saddle

Size	Part #	Qty
1-3/4"	<b>AP-H134</b>	1
1-7/8"	<b>AP-H178</b>	1
2"	<b>AP-H200</b>	1
2-1/4"	<b>AP-H214</b>	1
2-1/2"	<b>AP-H212</b>	1
2-3/4"	<b>AP-HD275</b>	1
3"	<b>AP-HD300</b>	1
3-1/2"	<b>AP-HD312</b>	1
4"	<b>AP-HD400</b>	1
5"	<b>AP-HD500</b>	1

## SWIVEL HANGER



Part# **AP-SWL3**

"Swivler" Heavy Duty 360° Design

# TUBING & HOSE

## COPPER TUBING

Soft-Annealed Seamless

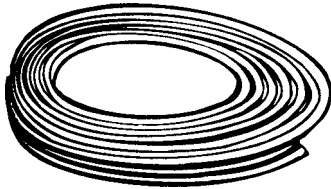

Outside Diameter	Wall Thickness	Coil Length	W.P. P.S.I.	Part #
1/8	.030	25 feet	2400	CTG-2-25
3/16	.030	25 feet	1600	CTG-3-25
1/4	.030	25 feet	12	CTG-4-25
5/16	.032	25 feet	1020	CTG-5-25
3/8	.032	25 feet	850	CTG-6-25
1/2	.032	25 feet	640	CTG-8-25
5/8	.035	25 feet	560	CTG-10-25
3/4	.035	25 feet	470	CTG-12-25

## NYLON AIR BRAKE TUBING

- » Nylon Air Brake tubing is especially designed for use on air brake systems and in-cab air controls on trucks, buses, tractors, and heavy duty road and farm equipment.
- » Conforms to S.A.E. J844D, types 3A and 3B.
- » Conforms to DOT FMVSS 571.106.



Nominal Tubing O.D.	Maximum Working Pressure psi	Min Burst Pressure at 70 ° F psi	Minimum Bend Radius at 70 ° F	Temperature Range	Tubing Length	S.A.E. Spec. J844D	Part #
1/8	250	1000	3/8	-40° to 200°F	100 ft.	3A	1485-2
1/4	300	1200	1"	-40° to 200°F	100 ft.	3A	1485-4
5/16	250	1000	1-1/4	-40° to 200°F	100 ft.	3A	1485-5
3/8	350	1400	1-1/2	-40° to 200°F	100 ft.	3B	1485-6
1/2	240	950	2"	-40° to 200°F	100 ft.	3B	1485-8
5/8	225	900	2-1/2	-40° to 200°F	100 ft.	3B	1485-10
3/4	200	800	3"	-40° to 200°F	100 ft.	3B	1485-12

# TUBING & HOSE

## STEEL TUBING

Brake Line Tubing

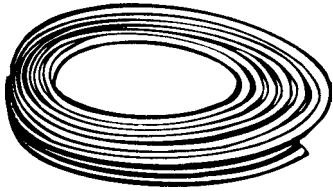

- » Temperature Range between -40° to +250° F.
- » Bendable & flareable.
- » Soft (Annealed) Temper...Low tensile strength.
- » Meets SAE J527.

» Also known as Bundyweld tubing. This tubing is neither welded nor seamless—it's rolled. A single sheet of copper-plated carbon steel is rolled into a tube, then the copper is melted to form a cohesive bond. It is coated with an aluminum-based paint for additional corrosion resistance. For use with hydraulic fluid and fuel. Also used in refrigeration lines. Ideal where line vibration is severe, such as diesel engines, refrigerators, air conditioners, and machine tools.

I.D.	O.D.	Wall Thickness	Maximum Working Pressure @ 72°F psi	Tubing Length	Part #
.1315	3/16	.028	3700	25 feet	BLT-3-25
.194	1/4	.028	2800	25 feet	BLT-4-25
.2565	5/16	.028	2250	25 feet	BLT-5-25
.319	3/8	.028	1850	25 feet	BLT-6-25

## VINYL (PVC) TUBING

Clear - Flexible

- » Resistance to a broad range of chemical acids, alkalis and solvents.
- » Ideal for use in industrial air pressure line applications, in the food industry (FDA approved), for potable water, and for various gases and chemicals.

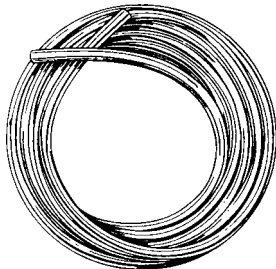

I.D.	O.D.	Wall Thickness	Maximum Working Pressure @ 72°F psi	Tubing Length	Part #
1/8	1/4	1/16	59	100 feet	A14801
3/16	5/16	1/16	51	100 feet	A14802
1/4	3/8	1/16	51	100 feet	A14803
5/16	7/16	1/16	48	100 feet	A14804
3/8	1/2	1/16	41	100 feet	A14805
3/8	5/8	1/16	55	100 feet	A14806
1/2	5/8	1/8	28	100 feet	A14807
1/2	3/4	1/16	41	100 feet	A14808

## HEATER HOSE

Premium Red

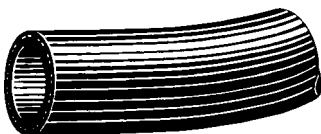

- » Meets or exceeds SAE20R3 specifications.
- » OEM grade EPDM hose that withstands the abuse of corrosive additives, heat, cold, ozone, weather and abrasion.
- » PRM = 2 ply.
- » HD = 3 ply.

Size	Boxed Length	Part #
1/2	50 feet	PRM-8
5/8	50 feet	PRM-10
3/4	50 feet	PRM-12
1"	50 feet	HD-16

# TUBING & HOSE

## FUEL LINE HOSE

25' Spools



Size	Part #
1/4	AGF-4
5/16	AGF-5
3/8	AGF-6

- » This fuel line hose is of the highest quality and meets all O.E.M. specs.
- » It has a special chemical resistant interior, a single braid, and a neoprene exterior for maximum life and durability.
- » For temperature range from -29°F to 257°F.
- » Designed for gas and diesel fuel lines (except Electronic Fuel Injection), emission control devices, and crankcase ventlation.
- » In addition to cars, this hose is widely used on lawn mowers, marine motors, tractors and construction equipment.

## WINDSHIELD WASHER & VACUUM TUBING

50' Spools



Size	Part #
1/8 (7/64)	AGW-2
3/16(5/32)	AGW-3
1/4 (7/32)	AGW-4

- » Meets SAE J1037 Type 2 Specifications
- » EDPM Rubber

## FUEL INJECTION HOSE

10' Rolls



I.D.	O.D.	Part #
1/4	1/2	FI-4
5/16	9/16	FI-5
3/8	5/8	FI-6

- » Designed for all latemodel fuel injection engines
- » A tough fluorocarbon (FKM) inner tube
- » Polyester braid reinforcement
- » Cured by lead process.
- » Handles pressures up to 450 P.S.I. and provides burst strength up to 900 P.S.I.
- » Meets OEM and S.A.E. J30R8 specifications.
- » Resists temperatures from -30°F to 302°F, oil, grease, and ozone.

# AIR LINE HOSE

## SELF-STORING AIR HOSE

Recoil



- » Abrasion resistant nylon designed to withstand temperatures between -60° to +200°F.
- » Equipped with durable brass compression swivel fittings to ensure tangle free operation.
- » Comes with spring guards for additional strain relief an 360° swivel fittings.

Hose I.D.	Length	NPT Swivel Fitting	Part #
1/4	12'	1/4 Male x Male	<b>ATD-8215</b>
1/4	25'	1/4 Male x Male	<b>ATD-8200</b>
1/4	50'	1/4 Male x Male	<b>ATD-8201</b>
3/8	25'	1/4 Male x Male	<b>ATD-8216</b>
3/8	50'	1/4 Male x Male	<b>ATD-8217</b>

## AIR HOSE

Red



- » High-quality 4-spiral reinforced construction.
- » Tough abrasion-resistant rubber cover with double reinforcement of sturdy rayon.
- » Working pressure up to 250 psi.

Hose I.D.	Length	NPT Swivel Fitting	Part #
1/4	25'	1/4 Male x Male	<b>ATD-8205</b>
1/4	50'	1/4 Male x Male	<b>ATD-8206</b>
3/8	25'	1/4 Male x Male	<b>ATD-8209</b>
3/8	50'	1/4 Male x Male	<b>ATD-8210</b>
1/2	25'	1/2 Male x Male	<b>ATD-8211</b>
1/2	50'	1/2 Male x Male	<b>ATD-8212</b>

# WATER HOSE & ACCESSORIES

## HEAVY DUTY & CONTRACTOR GRADE

### Vermont American Flexogen Water Hose

- » Constructed to last.
- » Lightweight, flexible, and kink resistant.
- » 500-lb. burst strength.

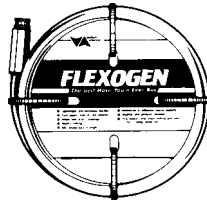

Length	I.D.	Part #
50 feet	5/8	VER-79831

### ATD Contractor's Water Hose

- » Commercial grade for heavy duty jobs.
- » Can withstand cold temperatures & hot water use
- » 600-lb. burst strength.



Length	I.D.	Part #
50 feet	3/4	ATD-8195

## WATER HOSE NOZZLES

Deluxe and Brass

### Vermont American Deluxe Water Nozzle

- » Threaded front nozzle sprays boiling hot or ice cold liquids.
- » Locks to any spray pattern.

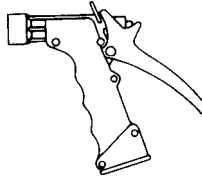

Part #	Qty
VER-79910	1

### Vermont American Brass Water Nozzle

- » Precision machined from solid brass.
- » Adjustable from fine mist to powerful rinse to dripless shutoff.



Part #	Qty
VER-79855	1

## HOSE REPAIR CLINCHER COUPLERS & MENDERS

Repairs Rubber or Plastic Hoses

### Male Replacement Clincher Coupling

- » Brass with long steel grippers that lock coupling on hose firmly.



For Hose I.D.	Part #	Qty.
5/8	4624	1
3/4	14963	1

### Female Replacement Clincher Coupling

- » Brass with long steel grippers that lock coupling on hose firmly.



For Hose I.D.	Part #	Qty.
5/8	4625	1
3/4	14964	1

### Hose Mender Clincher Coupling

- » Both halves are brass with long steel grippers that lock coupling on hose firmly.



For Hose I.D.	Part #	Qty.
5/8	4626	1
3/4	14965	1

# HOSE CLAMPS

## WORM GEAR DRIVE

Stainless Steel Band/Zinc Plated Screw and Housing & All Stainless Steel Clamps

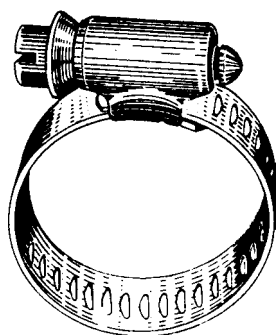

Clamp Range Min. to Max.	Ind. Std. Size	Stainless Steel Band/ Zinc Plated Screw & Housing		All Stainless Steel	Qty
		1/2" Band	9/16" Band	9/16" Band	
Mini, 5/16 to 5/8	4	*SC4	—	HCM4SS	10
Mini, 3/8 to 7/8	6	*SC6	—	HCM6SS	10
3/8 to 7/8	6	CC6	—	HC06SS	10
7/16 to 1	8	CC8	—	HC08SS	10
1/2 to 1-1/8	10	CC10	—	HC10SS	10
1/2 to 1-1/4	12	CC12	—	HC12SS	10
3/4 to 1-1/2	16	CC16	—	HC16SS	10
3/4 to 1-3/4	20	CC20	—	HC20SS	10
1 to 2	24	CC24	—	HC24SS	10
1-5/16 to 2-1/4	28	CC28	—	HC28SS	10
1-9/16 to 2-1/2	32	CC32	—	HC32SS	10
7/8 to 2-3/4	36	CC36	—	HC36SS	10
2-1/16 to 3	40	—	B40H	HC40SS	10
2-1/3 to 3-1/4	44	—	B44H	—	10
2-9/16 to 3-1/2	48	—	B48H	HC48SS	10
2-13/16 to 3-3/4	52	—	B52H	HC52SS	10
3-1/16 to 4	56	—	B56H	HC56SS	10
3-9/16 to 4-1/2	64	—	B64H	—	10
4-1/16 to 5	72	—	B72H	HC72SS	10
5 to 7	104	—	B104H	—	10
2 to 12-1/4	332	—	HC332	—	1

\* Add -1 to part # to order one clamp

\* SC4 & SC6 clamps have a 5/16" wide band

## TYPE G MINIATURE HOSE CLAMPS

Zinc Plated

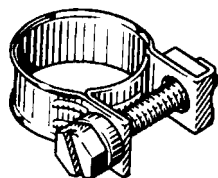

» Grips 360° around the hose.  
» \* Zinc & Black Dichomate.

Clamp Range Min. to Max.	Hose I.D.	Part #	Qty
8mm to 10mm (5/16 to 3/32)	5/13	A16766	10
9.5mm to 12mm (3/8 to 15/32)	7/32	A16767	10
10.5mm to 13mm (7/16 to 1/2)	1/4	A15860*	10
12.5mm to 15mm (1/2 to 19/32)	5/16	A15861*	10
13.5mm to 16mm (17/32 to 5/8)	3/8	A15862*	10



# HOSE CLAMPS

## NORMA TORRO® HOSE CLAMPS

European Style

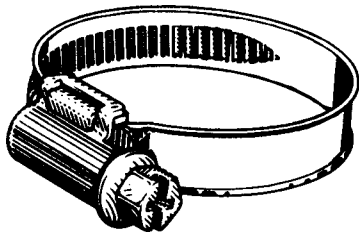

- » DIN 3017
- » Stainless Steel band & housing.
- » Zinc & yellow steel screw.

\* Phillips hex drive

Clamp Range Min. to Max.	Hex Size	Part #	Qty
8mm to 12mm (5/16 to 1/2)	6mm*	A16868	10
10mm to 16mm (3/8 to 5/8)	6mm*	A16869	10
12mm to 18mm (1/2 to 3/4)	6mm*	A16870	10
8mm to 16mm (5/16 to 5/8)	6mm	A16871	10
12mm to 20mm (1/2 to 3/4)	6mm	A16872	10
16mm to 25mm (5/8 to 1")	6mm	A16873	10
20mm to 32mm (3/4 to 1-1/4)	6mm	A16874	10
25mm to 40mm (1" to 1-5/8)	6mm	A16875	10
30mm to 45mm (1-3/16 to 1-3/4)	6mm	A16876	10
32mm to 50mm (1-1/4 to 2")	6mm	A16877	10
40mm to 60mm (1-5/8 to 2-3/8)	6mm	A16878	10
50mm to 70mm (1-31/32 to 2-3/4)	6mm	A19252	10
60mm to 80mm (2-3/8 to 3-1/8)	6mm	A19253	10
70mm to 90mm (2-3/4 to 3-9/16)	6mm	A19254	10

## CRIMP TYPE HOSE CLAMPS & TOOL

Zinc Plated Steel

- » For low pressure applications such as automotive hoses, appliance, industrial machinery, etc.
- » Easy to apply...Only one simple motion needed
- » Ideal for mass production.
- » "Full Round" clamping pressure.
- » No gap areas to leak.
- » Avoids hose cutting and abrasion.

Inner  
Width  
of Ear

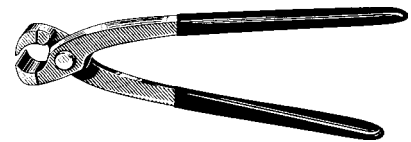
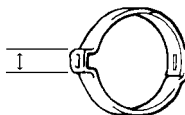

### Crimp Type Hose Clamp Tool

- » For installing and removing crimp type hose clamps.

**A18448**

Nominal Size	Closed	Open	Closed	Open	Inner Width of Ear	Part #	Qty	
3/8	.350"	.414"	8.9mm	10.5mm	197"	5mm	A18436	25
7/16	.381"	.444"	9.7mm	11.3mm	197"	5mm	A18437	25
15/32	.394"	.486"	10.4mm	12.3mm	197"	5mm	A18438	25
1/2	.453"	.524"	11.4mm	13.3mm	236"	6mm	A18439	25
35/64	.472"	.551"	12.9mm	14.0mm	256"	6.5mm	A18440	25
9/16	.496"	.571"	12.6mm	14.5mm	236"	6mm	A18441	25
5/8	.543"	.618"	13.8mm	15.7mm	236"	6mm	A18442	25
11/16	.594"	.669"	15.1mm	17.0mm	236"	6mm	A18443	25
23/32	.618"	.728"	15.7mm	18.5mm	354"	9mm	A18444	25
3/4	.669"	.779"	17.0mm	19.8mm	354"	9mm	A18445	25
7/8	.779"	.890"	19.8mm	22.6mm	354"	9mm	A18446	25
1"	.898"	1.008"	22.8mm	25.6mm	354"	9mm	A18447	25

# HOSE CLAMPS

## SELF TIGHTENING SPRING HOSE CLAMPS



- » Spring clamps automatically apply uniform clamping, and expand and contract with the hose in response to temperature and pressure changes.
- » No tightening is required.

Hose O.D.	Part #	Qty
9/16	A5354	50
5/8	A5355	50
11/16	A5356	50
3/4	A5357	50
13/16	A17086	50
15/16	A5358	50
1"	A5359	50
1-1/4	A16598	50
1-1/2	A16600	25
1-7/8	A16603	10
2"	A16604	10
2-1/8	A17078	10

## SPRING ACTION HOSE CLAMPS

Spring Steel, Heat Treated Phosphate and Paint

11

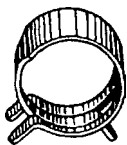

- » For use on rubber or plastic hose connectors.

Hose O.D.	Color	Max. Dia Clamp in Free Position	Width	Part #	Qty
3/8	Black	.32	5/16	A12682	100
7/16	Green	.405	5/16	A12683	100
1/2	Red	.460	5/16	A12684	100
9/16	Black	.520	5/16	A12685	100
5/8	Olive	.583	5/16	A12686	100
11/16	Red	.655	5/16	A12688	100
3/4	Black	.645	3/8	A12689	100
1"	Black	.910	3/8	A12691	50

# TUBING CLAMPS

## STEEL INSULATED CLOSED CLAMPS

Furnished Open - Zinc Plated - Coated with Black Vinyl Plastic (1/32" thick)

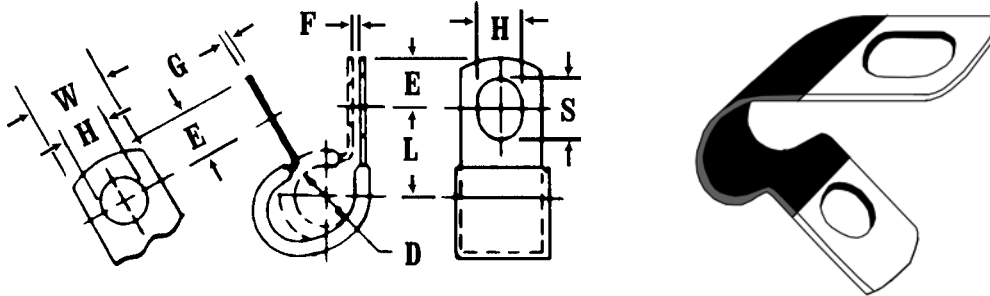

D	H	L	W	E	F	G	S	Part #	Qty
I.D.	Hole Dia	Center to Center	Width	Hole Center to End	Gap	Gauge	Slot Length		
<b>Small Hole Clamps</b>									
3/16	9/32	1/2	1/2	5/16	1/32	.032	3/8	A17087	25
1/4	9/32	17/32	1/2	5/16	1/32	.032	3/8	A9381	25
5/16	9/32	9/16	1/2	5/16	1/32	.032	3/8	A9382	25
3/8	9/32	19/32	1/2	5/16	1/16	.032	3/8	A9383	25
1/2	9/32	21/32	1/2	5/16	1/16	.048	3/8	A9384	25
5/8	9/32	23/32	1/2	5/16	1/16	.048	3/8	A9385	25
3/4	9/32	25/32	1/2	5/16	1/16	.048	3/8	A9386	25
7/8	9/32	27/32	1/2	5/16	1/16	.048	3/8	A9387	25
1	9/32	29/32	1/2	5/16	1/16	.048	3/8	A9388	25
<b>Large Hole Clamps</b>									
1/4	13/32	21/32	3/4	7/16	1/32	.032	1/2	A10598	25
5/16	13/32	11/16	3/4	7/16	1/32	.032	1/2	A10599	25
3/8	13/32	23/32	3/4	7/16	1/16	.032	1/2	A10600	25
1/2	13/32	25/32	3/4	7/16	1/16	.048	1/2	A10601	25
5/8	13/32	27/32	3/4	7/16	1/16	.048	1/2	A10602	25
3/4	13/32	29/32	3/4	7/16	1/16	.048	1/2	A10603	25
7/8	13/32	31/32	3/4	7/16	1/16	.048	1/2	A10604	25
1	13/32	1-1/32	3/4	7/16	1/16	.048	1/2	A10605	25
1-1/4	13/32	1-5/32	3/4	7/16	1/16	.048	1/2	A10606	25
1-1/2	13/32	1-9/32	3/4	7/16	1/16	.048	1/2	A10607	25
1-3/4	13/32	1-13/32	3/4	7/16	1/16	.048	1/2	A17588	10
2	13/32	1-9/16	3/4	7/16	1/16	.048	1/2	A17589	10

# INSULATED "HALF" TUBING CLAMPS

Zinc Plated - Coated with Black Vinyl Plastic (1/32" thick)

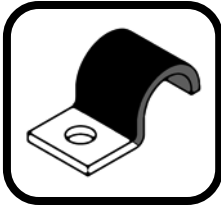

I.D.	Hole Diameter	Center to Center	Hole Center to End	Top of Radius to Base	Gauge	Width	Part #	Qty
3/16	7/32	7/16	1/4	5/32	.032	1/2	A10608	25
1/4	7/32	1/2	1/4	7/32	.048	1/2	A10609	25
5/16	9/32	17/32	5/16	9/32	.048	5/8	A10610	25
3/8	9/32	9/16	5/16	11/32	.048	5/8	A10611	25
7/16	9/32	5/8	5/16	13/32	.060	5/8	A10612	25
1/2	9/32	11/16	5/16	15/32	.060	5/8	A10613	25
5/8	9/32	13/16	5/16	9/16	.060	5/8	A10614	25
3/4	9/32	7/8	5/16	11/16	.060	5/8	A10615	25

# NYLON TUBING CLAMPS

Natural Nylon

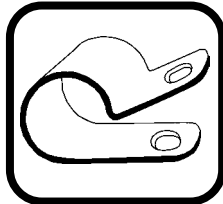

Tube Dia	Width	Hole Dia	Part #	Qty
1/8	3/8	3/16	A15525	50
3/16	3/8	3/16	A15526	50
1/4	3/8	3/16	A9246	25
5/16	3/8	3/16	A9247	25
3/8	3/8	3/16	A9248	25
1/2	3/8	3/16	A9249	25
5/8	1/2	3/16	A9250	25
3/4	1/2	3/16	A9251	25
1"	1/2	3/16	A9252	25

# ALUMINUM TUBING CLAMPS

Vinyl Dipped

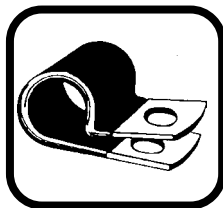

Tube Dia	Width	Hole Dia	Part #	Qty
1/4	3/8	5/32	A17361	15
5/16	3/8	5/32	A17362	15
3/8	3/8	5/32	A17363	15
1/2	3/8	5/32	A17364	15
5/8	3/8	5/32	A17365	15
3/4	1/2	5/32	A17366	15
7/8	1/2	5/32	A17367	15
1"	1/2	5/32	A17368	15



# **FAS-KIT<sup>®</sup> FITTING ASSORTMENTS**



<b>Plastic Box Assortments</b>		
Part Number	Description	Number of Pieces
FK03500	Grease Fittings - Standard	95
FK03600	Grease Fittings - Metric	80
FK03700	Vacuum Hose Connectors	95
FK03800	Rubber Vacuum Connectors	50

<b>Metal Tray Assortments</b>			
Small Drawer	Large Drawer	Description	Number of Pieces
FK12500	FK52500	"O" Rings - Small Sizes	1015
—	FK52550	"O" Rings - Large Sizes	240
—	FK52580	The Ultimate "O" Ring Assortment - Buna	1324
—	FK52590	The Ultimate "O" Ring Assortment - Viton	1324
FK15200	FK55200	Grease Fittings - Standard	90
FK15250	FK55250	Grease Fittings - Metric	95
FK15300	FK55300	Grease Fittings - Standard	105
FK15350	FK55350	Brass Compression Fittings	146
FK15410	FK55410	Brass Pipe Fittings - Nipples, Elbows & Tees	59
FK15450	FK55450	Brass Pipe Fittings - Adapters & Plugs	91
FK15500	FK55500	Brass SAE 45° Flare Fittings	100
FK15550	FK55550	Brass Inverted Flare Fittings	96
FK15570	FK55570	Brass Hose Barb Fittings	65
FK15600	FK55600	Brass Air Brake Fittings for Copper Tubing	82
FK15650	FK55650	Brass Air Brake Fittings for Nylon Tubing	79
FK15655	FK55655	Brass Air Brake Fittings for Nylon Tubing - Tees & 45's	30
FK15700	FK55700	Brass Push To Connect Fittings	61
FK15800	FK55800	Black Iron Pipe Fittings	119
FK16700	FK56700	Tubing Clamps - Neoprene Dipped	105
FK16710	FK56710	Tubing Clamps - Nylon	200
—	FK56750	Standard Stainless Steel Hose Clamps	120
—	FK56760	All Stainless Steel Hose Clamps	120



# **FAS-KIT<sup>®</sup> FITTING ASSORTMENTS**



<b>40 Hole Bin Assortments</b>		
Part Number	Description	Number of Pieces
FK90095	Black Iron Pipe Fittings	103
FK90096	Black Iron Nipples, Plugs & Caps	142

<b>Miscellaneous Assortments</b>		
Part Number	Description	Number of Pieces
FK90180	Fuel Line & Windshield Washer Hose	6
FK90200	Stainless Steel Hose Clamps - Standard Sizes	100
FK90205	Stainless Steel Hose Clamps - Large Sizes	50
FK90210	All Stainless Steel Hose Clamps - Standard Sizes	100
FK90215	All Stainless Steel Hose Clamps - Large Sizes	50
FK90250	Precision Wheel Weight Assortment	900
FK91000	"O" Ring Assortment in Blow Molded Plastic Box - Standard	382
FK91005	"O" Ring Assortment in Blow Molded Plastic Box - Metric	382

# CUTTING TOOLS & ACCESSORIES

## Jobber Length Twist Drills

Fractional, Numbers, Letters, Cobalt



## Reduced Shank Drill Bits

1/2" Shank, 3/8" Shank



## Stub Length Drill Bits



## Extra Length Drill Bits



## Double Ended Drill Bits



## Combined Drill & Countersinks

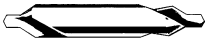

## Single Flute Countersink



## Masonry Drill Bits

Rotary, SDS Hammer



## Wood Bits

Spade, Auger



## Reamers



## Varibits



## Hole Saws

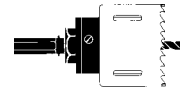

## Saw Blades

Hacksaw, Reciprocating Saw, Jig Saw



## Taps & Dies



## Screw Extractors



## Helical Thread Repair



## Razor Knives & Accessories

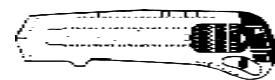
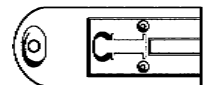

# Section 12: Cutting Tools

## Table of Contents

### Drill Bits & Accessories

Empty Drill Indexes .....	3
Cutting Fluid, <i>Brute Lube</i> .....	3
High Speed Drill Bits, <i>XL5's Fractional</i> .....	4
High Speed Drill Bits, <i>XL5's Wire Gage</i> .....	5
High Speed Drill Bits, <i>XL5's Letter Sizes</i> .....	6
Cobalt Drill Bits, <i>Fractional</i> .....	7
Reduced Shank Drill Bits, <i>1/2 Shank</i> .....	8
Reduced Shank Drill Bits, <i>3/8 Shank</i> .....	8
Extra Length Drill Bits, <i>6", 12" 18"</i> .....	9
Double Ended Drill Bits, <i>High Speed Steel</i> .....	10
Combined Drill & Countersinks .....	10
Single Flute Countersinks .....	11
Reamers, <i>Straight Shank</i> .....	11
Grinding Burs, <i>Tungsten Carbide</i> .....	12
Locksmith Drills, <i>Carbide Tipped</i> .....	12
Masonry Drill Bits, <i>Straight Shank</i> .....	13
Masonry Drill Bits, <i>12" Long</i> .....	13
Masonry Drill Bits, <i>SDS Shank</i> .....	14
Wood Bits, <i>Spade Style</i> .....	15
Wood Auger Bits, <i>17"</i> .....	15
Vari-Bits, <i>Step Drill Bits</i> .....	16

### Hole Saws & Accessories

Hole Saws, <i>Bi-Metal</i> .....	17
Arbors .....	17
Pilot Bits .....	17
Arbor Adapter .....	17
12" Extension .....	17
Hole Saw Kits .....	18

### Saw Blades

Hacksaw Blades, <i>Bi-metal</i> .....	19
Hacksaw Frames .....	19
Reciprocating Saw Blades, <i>Bi-metal</i> .....	20-21
Jig Saw Blades, <i>Bi-metal</i> .....	22
Band Saw Blades, <i>Bi-metal</i> .....	23

### Thread Restoration

Hand Taps, <i>Standard</i> .....	24
Hand Taps, <i>Metric</i> .....	25
Hand Taps, <i>Pipe Thread</i> .....	25
Die Nuts, <i>Standard</i> .....	25
Die Nuts, <i>Pipe Thread</i> .....	25
Die Nuts, <i>Metric</i> .....	25
Tap & Die Sets .....	26
Tap & Die Handles .....	26
Screw Pitch Gages, <i>Standard &amp; Metric</i> .....	26
Screw Extractors, <i>Spiral Flute</i> .....	27
Helical Thread Repair .....	28

### Razor Knives & Accessories

Utility Knives .....	29
Utility Knife Blades .....	29
Razor Scrapers .....	29
Razor Blades, <i>Single Edge</i> .....	29
Hobby Knives & Blades .....	30
Snap Blade Knives & Blades .....	30
Tape Measures .....	30





# EMPTY DRILL INDEXES

FOR JOBBER LENGTH FRACTIONAL, LETTER AND NUMBER SIZE BITS

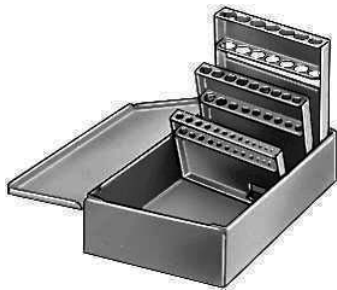

## Fractional Index

	part #
1/16" thru 1/2" by 64ths. - holds 29 bits.....	CH-129-MT
1/16" thru 3/8" by 64ths. - holds 21 bits.....	CH-121-MT
1/16" thru 1/2" by 32nds. - holds 15 bits.....	CH-115-MT
1/16" thru 1/2" by 64ths. - holds 13 bits.....	CH-113-MT

## Number Index

#1 to #60 - holds 60 bits.....	CH-160-MT
--------------------------------	-----------

## Letter Index

letter A to Z - holds 26 bits.....	CH-126-MT
------------------------------------	-----------

## 1/2" Reduced Shank Index

9/16" to 1" by 16ths. - holds 8 bits.....	CH-712-8-MT
---	-------------



## 3 Drawer Cabinet

1/16" to 1/2 by 64ths.....	CH-D1
holds 29 sizes, multiples of each	

## BRUTE LUBE CUTTING FLUID

Sarjo's Brute Lube is a multi-purpose cutting and tapping fluid specially formulated to extend tool life and reduce chip welding.

Complies with OSHA regulations.

Especially effective on stainless steel, aluminum, and exotic alloys.



Size	Part #
4 oz. bottle.....	CHE225
1 case (12) 4 oz. bottles.....	CHE225CS
16 oz. bottle.....	CHE220
1 case (12) 16 oz. bottles....	CHE220CS
1 gallon jug.....	CHE227
1 case (4) gallons.....	CHE227CS

# HIGH SPEED DRILL BITS

“BRUTE PLATINUM” with NOMO BY **CHAMPION**<sup>®</sup>

CUTTING TOOL CORP.

135° Split Point - Fractional Sizes



*Our Most Popular !*

## HIGH SPEED STEEL



### 29 Piece Set

1/16 to 1/2 by 64ths  
part# CH-129C-XL5

### 21 Piece Set

1/16 to 3/8 by 64ths  
part# CH-121C-XL5

### 15 Piece Set

1/16 to 1/2 by 32ths  
part# CH-115C-XL5

### 13 Piece Set

1/16 to 1/4 by 64ths  
part# CH-113C-XL5

### 135° SPLIT POINTS

- » No Walk - Self Starting
- » Non-Skidding
- » Eliminates Center Punching
- » Surface Treated Hardened Steel

Dia.	Decimal Equiv.	Flute Length	Overall Length	Part No.
1/16	.0625	7/8	1-7/8	CH-XL5-1/16
5/64	.0781	1	2	CH-XL5-5/64
3/32	.0938	1-1/4	2-1/4	CH-XL5-3/32
7/64	.1094	1-1/2	2-5/8	CH-XL5-7/64
1/8	.1250	1-5/8	2-3/4	CH-XL5-1/8
9/64	.1406	1-3/4	2-7/8	CH-XL5-9/64
5/32	.1562	2	3-1/8	CH-XL5-5/32
11/64	.1719	2-1/8	3-1/4	CH-XL5-11/64
3/16	.1875	2-5/16	3-1/2	CH-XL5-3/16
13/64	.2031	2-7/16	3-5/8	CH-XL5-13/64
7/32	.2188	2-1/2	3-3/4	CH-XL5-7/32
15/64	.2344	2-5/8	3-7/8	CH-XL5-15/64
1/4	.2500	2-3/4	4	CH-XL5-1/4
17/64	.2656	2-7/8	4-1/8	CH-XL5-17/64
9/32	.2812	2-15/16	4-1/4	CH-XL5-9/32
19/64	.2969	3-1/16	4-3/8	CH-XL5-19/64
5/16	.3125	3-3/16	4-1/2	CH-XL5-5/16
21/64	.3281	3-5/16	4-5/8	CH-XL5-21/64
11/32	.3438	3-7/16	4-3/4	CH-XL5-11/32
23/64	.3594	3-1/2	4-7/8	CH-XL5-23/64
3/8	.3750	3-5/8	5	CH-XL5-3/8
25/64	.3906	3-3/4	5-1/8	CH-XL5-25/64
13/32	.4062	3-7/8	5-1/4	CH-XL5-13/32
27/64	.4219	3-15/16	5-3/8	CH-XL5-27/64
7/16	.4375	4-1/16	5-1/2	CH-XL5-7/16
29/64	.4531	4-3/16	5-5/8	CH-XL5-29/64
15/32	.4688	4-5/16	5-3/4	CH-XL5-15/32
31/64	.4844	4-3/8	5-7/8	CH-XL5-31/64
1/2	.5000	4-1/2	6	CH-XL5-1/2

**Order by the full pack or individually.**

1/16 thru 9/32, 12 per pack;

19/64 thru 1/2, 6 per pack.

# HIGH SPEED DRILL BITS

"BRUTE PLATINUM" WITH NOMO BY **CHAMPION**<sup>®</sup>  
CUTTING TOOL CORP.

135° Split Point - Wire Gauge Sizes 1-60

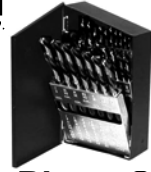

**60 Piece Set**

#1 to #60

Part# CH-160C-XL5

## HIGH SPEED STEEL



Size #	Deci. Size	Flute Lgth	Overall Lgth	Part No.	Size #	Deci. Size	Flute Lgth	Overall Lgth	Part No.
60	.0400	11/16	1-5/8	CH-705-60	30	.1285	1-5/8	2-3/4	CH-XL5-30
59	.0410	11/16	1-5/8	CH-705-59	29	.1360	1-3/4	2-7/8	CH-XL5-29
58	.0420	11/16	1-5/8	CH-705-58	28	.1405	1-3/4	2-7/8	CH-XL5-28
57	.0430	3/4	1-3/4	CH-705-57	27	.1440	1-7/8	3	CH-XL5-27
56	.0465	3/4	1-3/4	CH-705-56	26	.1470	1-7/8	3	CH-XL5-26
55	.0520	7/8	1-7/8	CH-705-55	25	.1495	1-7/8	3	CH-XL5-25
54	.0550	7/8	1-7/8	CH-705-54	24	.1520	2	3-1/8	CH-XL5-24
53	.0595	7/8	1-7/8	CH-705-53	23	.1540	2	3-1/8	CH-XL5-23
52	.0635	7/8	1-7/8	CH-XL5-52	22	.1570	2	3-1/8	CH-XL5-22
51	.0670	1	2	CH-XL5-51	21	.1590	2-1/8	3-1/4	CH-XL5-21
50	.0700	1	2	CH-XL5-50	20	.1610	2-1/8	3-1/4	CH-XL5-20
49	.0730	1	2	CH-XL5-49	19	.1660	2-1/8	3-1/4	CH-XL5-19
48	.0760	1	2	CH-XL5-48	18	.1695	2-1/8	3-1/4	CH-XL5-18
47	.0785	1	2	CH-XL5-47	17	.1730	2-3/16	3-3/8	CH-XL5-17
46	.0810	1-1/8	2-1/8	CH-XL5-46	16	.1770	2-3/16	3-3/8	CH-XL5-16
45	.0820	1-1/8	2-1/8	CH-XL5-45	15	.1800	2-3/16	3-3/8	CH-XL5-15
44	.0860	1-1/8	2-1/8	CH-XL5-44	14	.1820	2-3/16	3-3/8	CH-XL5-14
43	.0890	1-1/4	2-1/4	CH-XL5-43	13	.1850	2-5/16	3-1/2	CH-XL5-13
42	.0935	1-1/4	2-1/4	CH-XL5-42	12	.1890	2-5/16	3-1/2	CH-XL5-12
41	.0960	1-3/8	2-3/8	CH-XL5-41	11	.1910	2-5/16	3-1/2	CH-XL5-11
40	.0980	1-3/8	2-3/8	CH-XL5-40	10	.1935	2-7/16	3-5/8	CH-XL5-10
39	.0995	1-3/8	2-3/8	CH-XL5-39	9	.1960	2-7/16	3-5/8	CH-XL5-09
38	.1015	1-7/16	2-1/2	CH-XL5-38	8	.1990	2-7/16	3-5/8	CH-XL5-08
37	.1040	1-7/16	2-1/2	CH-XL5-37	7	.2010	2-7/16	3-5/8	CH-XL5-07
36	.1065	1-7/16	2-1/2	CH-XL5-36	6	.2040	2-1/2	3-3/4	CH-XL5-06
35	.1100	1-1/2	2-5/8	CH-XL5-35	5	.2055	2-1/2	3-3/4	CH-XL5-05
34	.1110	1-1/2	2-5/8	CH-XL5-34	4	.2090	2-1/2	3-3/4	CH-XL5-04
33	.1130	1-1/2	2-5/8	CH-XL5-33	3	.2130	2-1/2	3-3/4	CH-XL5-03
32	.1160	1-5/8	2-3/4	CH-XL5-32	2	.2210	2-5/8	3-7/8	CH-XL5-02
31	.1200	1-5/8	2-3/4	CH-XL5-31	1	.2280	2-5/8	3-7/8	CH-XL5-01

**Order by the full pack or individually.**

All number drills, 12 per pack

# HIGH SPEED DRILL BITS

"BRUTE PLATINUM" WITH NOMO BY **CHAMPION**<sup>®</sup>  
CUTTING TOOL CORP.

135° Split Point - Letter Sizes A to Z



**HIGH SPEED STEEL**

Letter Size	Decimal Equiv.	Flute Length	Overall Length	Part No.
A	.2340	2-5/8	3-7/8	CH-XL5-A
B	.2380	2-3/4	4	CH-XL5-B
C	.2420	2-3/4	4	CH-XL5-C
D	.2460	2-3/4	4	CH-XL5-D
E	.2500	2-3/4	4	CH-XL5-E
F	.2570	2-7/8	4-1/8	CH-XL5-F
G	.2610	2-7/8	4-1/8	CH-XL5-G
H	.2660	2-7/8	4-1/8	CH-XL5-H
I	.2720	2-7/8	4-1/8	CH-XL5-I
J	.2770	2-7/8	4-1/8	CH-XL5-J
K	.2810	2-15/16	4-1/4	CH-XL5-K
L	.2900	2-15/16	4-1/4	CH-XL5-L
M	.2950	3-1/16	4-3/8	CH-XL5-M
N	.3020	3-1/16	4-3/8	CH-XL5-N
O	.3160	3-3/16	4-1/2	CH-XL5-O
P	.3230	3-5/16	4-5/8	CH-XL5-P
Q	.3320	3-7/16	4-3/4	CH-XL5-Q
R	.3390	3-7/16	4-3/4	CH-XL5-R
S	.3480	3-1/2	4-7/8	CH-XL5-S
T	.3580	3-1/2	4-7/8	CH-XL5-T
U	.3680	3-5/8	5	CH-XL5-U
V	.3770	3-5/8	5	CH-XL5-V
W	.3860	3-3/4	5-1/8	CH-XL5-W
X	.3970	3-3/4	5-1/8	CH-XL5-X
Y	.4040	3-7/8	5-1/4	CH-XL5-Y
Z	.4130	3-7/8	5-1/4	CH-XL5-Z

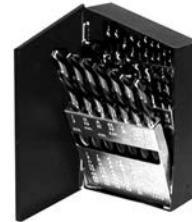

**26 Piece Set**  
Letter A thru Z  
part# **CH-126C-XL5**

**Order by the full pack or individually.**

A thru L, 12 per pack;  
M thru Z, 6 per pack.

**135° SPLIT POINTS**

- » No Walk - Self Starting
- » Non-Skidding
- » Eliminates Center Punching
- » Surface Treated Hardened Steel

# COBALT DRILL BITS

## FRACTIONAL SIZES BY **CHAMPION**<sup>®</sup>

135° Split Point Heavy Duty Drills - Gold Oxide



**29 Piece Set**  
1/16 to 1/2 by 64ths  
part# **CH-129CO**

**21 Piece Set**  
1/16 to 3/8 by 64ths  
part# **CH-121CO**

**15 Piece Set**  
1/16 to 1/2 by 32ths  
part# **CH-115CO**

**13 Piece Set**  
1/16 to 1/4 by 64ths  
part# **CH-113CO**

### COBALT BITS - TYPE J

FOR DRILLING TOUGH MATERIALS

- » Stainless Steel
- » Titanium
- » Iron Base Alloys
- » Cobalt or Nickel Alloys

### 135° SPLIT POINTS

- » No Walk - Self Starting
- » Non-Skidding
- » Eliminates Center Punching
- » Surface Treated Hardened Steel



### COBALT STEEL

Dia.	Decimal Equiv.	Flute Length	Overall Length	Part No.
1/16	.0625	7/8	1-7/8	CH-705C-1/16
5/64	.0781	1	2	CH-705C-5/64
3/32	.0938	1-1/4	2-1/4	CH-705C-3/32
7/64	.1094	1-1/2	2-5/8	CH-705C-7/64
1/8	.1250	1-5/8	2-3/4	CH-705C-1/8
9/64	.1406	1-3/4	2-7/8	CH-705C-9/64
5/32	.1562	2	3-1/8	CH-705C-5/32
11/64	.1719	2-1/8	3-1/4	CH-705C-11/64
3/16	.1875	2-5/16	3-1/2	CH-705C-3/16
13/64	.2031	2-7/16	3-5/8	CH-705C-13/64
7/32	.2188	2-1/2	3-3/4	CH-705C-7/32
15/64	.2344	2-5/8	3-7/8	CH-705C-15/64
1/4	.2500	2-3/4	4	CH-705C-1/4
17/64	.2656	2-7/8	4-1/8	CH-705C-17/64
9/32	.2812	2-15/16	4-1/4	CH-705C-9/32
19/64	.2969	3-1/16	4-3/8	CH-705C-19/64
5/16	.3125	3-3/16	4-1/2	CH-705C-5/16
21/64	.3281	3-5/16	4-5/8	CH-705C-21/64
11/32	.3438	3-7/16	4-3/4	CH-705C-11/32
23/64	.3594	3-1/2	4-7/8	CH-705C-23/64
3/8	.3750	3-5/8	5	CH-705C-3/8
25/64	.3906	3-3/4	5-1/8	CH-705C-25/64
13/32	.4062	3-7/8	5-1/4	CH-705C-13/32
27/64	.4219	3-15/16	5-3/8	CH-705C-27/64
7/16	.4375	4-1/16	5-1/2	CH-705C-7/16
29/64	.4531	4-3/16	5-5/8	CH-705C-29/64
15/32	.4688	4-5/16	5-3/4	CH-705C-15/32
31/64	.4844	4-3/8	5-7/8	CH-705C-31/64
1/2	.5000	4-1/2	6	CH-705C-1/2

**Order by the full pack or individually.**

1/16 thru 9/32, 12 per pack;  
19/64 thru 1/2, 6 per pack.

# SILVER & DEMING DRILLS - 1/2 SHANK

"BRUTE PLATINUM" WITH NOMO BY **CHAMPION**<sup>®</sup>

CUTTING TOOL CORP.

118° Split Point - Heavy Duty HSS



**HIGH SPEED STEEL**



**8 Piece Set**

9/16 thru 1" by 16ths

part# CH-XL12-8C

Dia.	Deci. Size	Flute Lgth	Overall Lgth	Part No.
33/64	.5156	3-1/8	6	CH-XL12-33/64
17/32	.5312	3-1/8	6	CH-XL12-17/32
35/64	.5469	3-1/8	6	CH-XL12-35/64
9/16	.5625	3-1/8	6	CH-XL12-9/16
37/64	.5781	3-1/8	6	CH-XL12-37/64
19/32	.5938	3-1/8	6	CH-XL12-19/32
39/64	.6094	3-1/8	6	CH-XL12-39/64
5/8	.6250	3-1/8	6	CH-XL12-5/8
41/64	.6406	3-1/8	6	CH-XL12-41/64
21/32	.6562	3-1/8	6	CH-XL12-21/32
43/64	.6719	3-1/8	6	CH-XL12-43/64
11/16	.6875	3-1/8	6	CH-XL12-11/16
45/64	.7031	3-1/8	6	CH-XL12-45/64
23/32	.7188	3-1/8	6	CH-XL12-23/32
47/64	.7344	3-1/8	6	CH-XL12-47/64
3/4	.7500	3-1/8	6	CH-XL12-3/4
49/64	.7656	3-1/8	6	CH-XL12-49/64
25/32	.7812	3-1/8	6	CH-XL12-25/32
51/64	.7969	3-1/8	6	CH-XL12-51/64
13/16	.8125	3-1/8	6	CH-XL12-13/16

Dia.	Deci. Size	Flute Lgth	Overall Lgth	Part No.
53/64	.8281	3-1/8	6	CH-XL12-53/64
27/32	.8438	3-1/8	6	CH-XL12-27/32
55/64	.8594	3-1/8	6	CH-XL12-55/64
7/8	.8750	3-1/8	6	CH-XL12-7/8
57/64	.8906	3-1/8	6	CH-XL12-57/64
29/32	.9062	3-1/8	6	CH-XL12-29/32
59/64	.9219	3-1/8	6	CH-XL12-59/64
15/16	.9375	3-1/8	6	CH-XL12-15/16
61/64	.9531	3-1/8	6	CH-XL12-61/64
31/32	.9688	3-1/8	6	CH-XL12-31/32
63/64	.9844	3-1/8	6	CH-XL12-63/64
1	1.0000	3-1/8	6	CH-XL12-1
1-1/16	1.0625	3-1/8	6	CH-XL12-1-1/16
1-1/8	1.1250	3-1/8	6	CH-XL12-1-1/8
1-3/16	1.1875	3-1/8	6	CH-XL12-1-3/16
1-1/4	1.2500	3-1/8	6	CH-XL12-1-1/4
1-5/16	1.3125	3-1/8	6	CH-XL12-1-5/16
1-3/8	1.3750	3-1/8	6	CH-XL12-1-3/8
1-1/2	1.5000	3-1/8	6	CH-XL12-1-1/2

Drills sold individually.

# REDUCED SHANK DRILLS - 3/8 SHANK

"BRUTE PLATINUM" WITH NOMO BY **CHAMPION**<sup>®</sup>

CUTTING TOOL CORP.

135° Split Point - Heavy Duty HSS

Dia.	Deci. Size	Flute Lgth	Overall Lgth	Part No.
25/64	.3906	3-1/8	6	CH-XL28-25/64
13/32	.4062	3-1/8	6	CH-XL28-13/32
27/64	.4219	3-1/8	6	CH-XL28-27/64
7/16	.4375	3-1/8	6	CH-XL28-7/16

Dia.	Deci. Size	Flute Lgth	Overall Lgth	Part No.
29/64	.4531	3-1/8	6	CH-XL28-29/64
15/32	.4687	3-1/8	6	CH-XL28-15/32
31/64	.4844	3-1/8	6	CH-XL28-31/64
1/2	.5000	3-1/8	6	CH-XL28-1/2

# EXTRA LENGTH DRILL BITS

6", 12" & 18" BY **CHAMPION**<sup>®</sup>  
CUTTING TOOL CORP.

118° Point - High Speed Steel

## 6" LENGTH



Dia.	Deci. Size	Flute Lgth	Overall Lgth	Part No.
1/8	.1250	3-1/8	6	CH-CS6X-1/8
5/32	.1562	3-1/8	6	CH-CS6X-5/32
3/16	.1875	3-1/8	6	CH-CS6X-3/16
7/32	.2188	3-1/8	6	CH-CS6X-7/32
1/4	.2500	—	6	CH-CS6X-1/4

## 12" LENGTH



Dia.	Deci. Size	Flute Lgth	Overall Lgth	Part No.
3/16	.1875	3-1/8	12	CH-CS12X-3/16
1/4	.2500	3-1/8	12	CH-CS12X-1/4
5/16	.3125	3-1/8	12	CH-CS12X-5/16
3/8	.3750	3-1/8	12	CH-CS12X-3/8
7/16	.4375	—	12	CH-CS12X-7/16
1/2	.5000	—	12	CH-CS12X-1/2

## 18" LENGTH



Dia.	Deci. Size	Flute Lgth	Overall Lgth	Part No.
3/16	.1875	13	18	CH-1800-3/16
1/4	.2500	13	18	CH-1800-1/4
5/16	.3125	13	18	CH-1800-5/16
3/8	.3750	13	18	CH-1800-3/8
7/16	.4375	13	18	CH-1800-7/16
1/2	.5000	13	18	CH-1800-1/2

12

# DOUBLE ENDED SHEETER DRILLS

BY **CHAMPION**<sup>®</sup>

CUTTING TOOL CORP.

135° Split Point - High Speed Steel - Black Oxide Treated

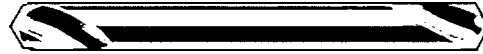

Dia.	Deci. Size	Flute Lgth	Overall Lgth	Part No.
#30	.1285	1/2	2	CH-1805-30
1/8	.1250	1/2	2	CH-1805-1/8
5/32	.1562	1/2	2	CH-1805-5/32
3/16	.1875	1/2	2	CH-1805-3/16
1/4	.2500	1/2	2	CH-1805-1/4

Order by the full pack or individually.

12 per pack

# COMBINED DRILL & COUNTERSINKS

BY **CHAMPION**<sup>®</sup>

CUTTING TOOL CORP.

Plain Style - 60° Included Angle - High Speed Steel



Dia.	Body Dia.	Drill Dia.	Drill Length	Overall Lgth	Part No.
00	1/8	.025	.030	1-1/8	CH-798-00
0	1/8	1/32	.038	1-1/8	CH-798-0
1	1/8	3/64	3/64	1-1/4	CH-798-1
2	3/16	5/64	5/64	1-7/8	CH-798-2
3	1/4	7/64	7/64	2	CH-798-3
4	5/16	1/8	1/8	2-1/8	CH-798-4
5	7/16	3/16	3/16	2-3/4	CH-798-5
6	1/2	7/32	7/32	3	CH-798-6
7	5/8	1/4	1/4	3-1/4	CH-798-7
8	3/4	5/16	5/16	3-1/2	CH-798-8

Packaged Individually.



# SINGLE FLUTE COUNTERSINKS

“BRUTE PLATINUM” BY **CHAMPION**<sup>®</sup>

CUTTING TOOL CORP.

82° - High Hook - High Speed Steel



Dia.	Shank Dia.	Overall Lgth	Part No.
1/4	1/4	1-1/2	CH-XL801-1/4x82
3/8	1/4	1-3/4	CH-XL801-3/8x82
1/2	1/4	2	CH-XL801-1/2x82
5/8	3/8	2-1/4	CH-XL801-5/8x82
3/4	1/2	2-5/8	CH-XL801-3/4x82
1”	1/2	2-3/4	CH-XL801-1x82

Packaged Individually.

# MAINTENANCE REAMERS

“BRUTE PLATINUM” BY **CHAMPION**<sup>®</sup>

CUTTING TOOL CORP.

1/2 Straight Shank - Left Hand Helix - Collar Stop



Dia.	Deci. Size	No. of Flutes	Point Dia.	Flute Lgth	Overall Lgth	Part No.
3/8	.3750	4	.188	3	5	CH-SA80-3/8
1/2	.5000	5	.230	3-15/16	5-15/16	CH-SA80-1/2
5/8	.6250	5	.259	4-1/2	6-9/16	CH-SA80-5/8
3/4	.7500	5	.453	4-15/16	7	CH-SA80-3/4
7/8	.8750	5	.580	5-3/16	7-1/4	CH-SA80-7/8
1	1.0000	5	.708	5-3/16	7-1/4	CH-SA80-1

Packaged Individually.

# GRINDING BURS

## TUNGSTEN CARBIDE BY **CHAMPION**<sup>®</sup>

CUTTING TOOL CORP.

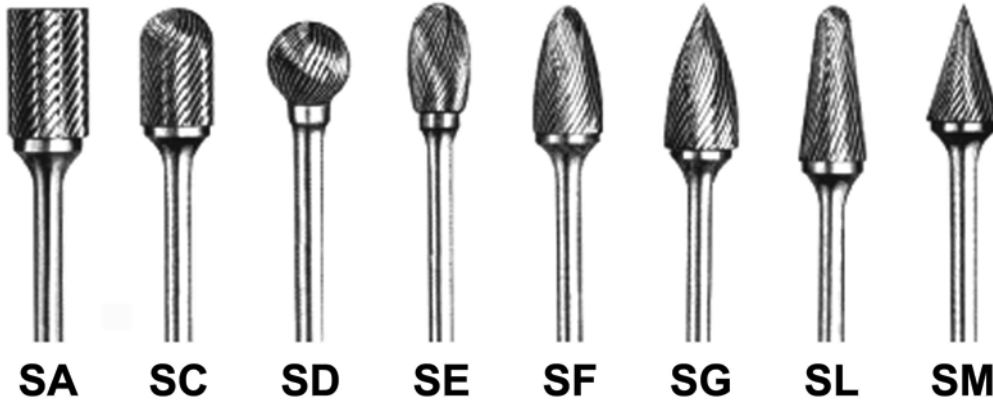

Head Dia.	Head Lgth	Shank Dia.	Part No.
1/4	5/8	1/4	CH-SA1
3/8	3/4	1/4	CH-SA3
1/2	1	1/4	CH-SA5
1/4	5/8	1/4	CH-SC1
3/8	3/4	1/4	CH-SC3
1/2	1	1/4	CH-SC5
1/4	7/32	1/4	CH-SD1
3/8	5/16	1/4	CH-SD3
1/2	7/16	1/4	CH-SD5
1/4	3/8	1/4	CH-SE1
3/8	5/8	1/4	CH-SE3
1/2	7/8	1/4	CH-SE5

Head Dia.	Head Lgth	Shank Dia.	Part No.
1/4	1/4	1/4	CH-SF1
3/8	3/8	1/4	CH-SF3
1/2	1/2	1/4	CH-SF5
1/4	1/4	1/4	CH-SG1
3/8	3/8	1/4	CH-SG3
1/2	1/2	1/4	CH-SG5
1/4	1/4	1/4	CH-SL1
3/8	3/8	1/4	CH-SL3
1/2	5/8	1/4	CH-SL5
1/4	1/4	1/4	CH-SM1
3/8	1/4	1/4	CH-SM3
1/2	1/2	1/4	CH-SM5

# LOCKSMITH DRILLS

## CARBIDE TIPPED BY **CHAMPION**<sup>®</sup>

CUTTING TOOL CORP.



Dia.	Deci. Size	Flute Lgth	Overall Lgth	Part No.
1/8	.1250	1-1/2	2-3/4	CH-CT705-1/8
3/16	.1875	1-7/8	3	CH-CT705-3/16
1/4	.2500	2-1/2	4	CH-CT705-1/4X4
5/16	.3125	2-1/2	4	CH-CT705-5/16X4
3/8	.3750	4	6	CH-CT705-3/8X6

» For non-precision drilling of hardened steel and safes.  
 » Ideal for drilling and extracting broken hardened bolts. (ie. grade 5 and grade 8).

# ROTARY MASONRY DRILLS

DEEP FLUTE - CARBIDE TIPPED BY **CHAMPION**<sup>®</sup>  
CUTTING TOOL CORP.



Dia.	Overall Lgth	Shank Dia.	Part No.	Dia.	Overall Lgth	Shank Dia.	Part No.
1/8	2-1/2	1/8	CH-CM8-1/8	1/2	6	3/8	CH-CM86-1/2X3/8
3/16	6	3/16	CH-CM86-3/16	5/8	6	1/2	CH-CM86-5/8
1/4	6	1/4	CH-CM86-1/4	3/4	6	1/2	CH-CM86-3/4
5/16	6	1/4	CH-CM86-5/16	7/8	6	1/2	CH-CM86-7/8
3/8	6	1/4	CH-CM86-3/8	1	6	1/2	CH-CM86-1
7/16	6	1/4	CH-CM86-7/16				

Sold Individually.

---

## 12" ROTARY MASONRY DRILLS

DEEP FLUTE, EXTRA LENGTH, CARBIDE TIPPED BY **CHAMPION**<sup>®</sup>  
CUTTING TOOL CORP.



Dia.	Overall Lgth	Shank Dia.	Part No.
3/16	12	3/16	CH-CM12-3/16
1/4	12	1/4	CH-CM12-1/4
5/16	12	5/16	CH-CM12-5/16
3/8	12	5/16	CH-CM12-3/8
1/2	12	3/8	CH-CM12-1/2

# SDS PLUS HAMMER BITS

CARBIDE TIPPED BY **CHAMPION**  
CUTTING TOOL CORP.



Usable Overall			Part No.
Dia.	Lgth	Lgth	
5/32	2	4	CH-CM95-5/32X2X4
5/32	4	6	CH-CM95-5/32X4X6
3/16	2	4	CH-CM95-3/16X2X4
3/16	4	6	CH-CM95-3/16X4X6
3/16	6	8	CH-CM95-3/16X6X8
3/16	10	12	CH-CM95-3/16X10X12
7/32	4	6	CH-CM95-7/32X4X6
7/32	10	12	CH-CM95-7/32X10X12
1/4	2	4	CH-CM95-1/4X2X4
1/4	4	6	CH-CM95-1/4X4X6
1/4	6	8	CH-CM95-1/4X6X8
1/4	8	10	CH-CM95-1/4X8X10
1/4	10	12	CH-CM95-1/4X10X12
5/16	4	6	CH-CM95-5/16X4X6
5/16	10	12	CH-CM95-5/16X10X12
3/8	4	6	CH-CM95-3/8X4X6
3/8	8	10	CH-CM95-3/8X8X10

Usable Overall			Part No.
Dia.	Lgth	Lgth	
3/8	10	12	CH-CM95-3/8X10X12
3/8	22	24	CH-CM95-3/8X22X24
1/2	4	6	CH-CM95-1/2X4X6
1/2	8	10	CH-CM95-1/2X8X10
1/2	10	12	CH-CM95-1/2X10X12
1/2	16	18	CH-CM95-1/2X16X18
1/2	22	24	CH-CM95-1/2X22X24
5/8	6	8	CH-CM95-5/8X6X8
5/8	10	12	CH-CM95-5/8X10X12
5/8	16	18	CH-CM95-5/8X16X18
3/4	6	8	CH-CM95-3/4X6X8
3/4	10	12	CH-CM95-3/4X10X12
7/8	6	8	CH-CM95-7/8X6X8
7/8	10	12	CH-CM95-7/8X10X12
1	8	10	CH-CM95-1X8X10
1	16	18	CH-CM95-1X16X18

Sold Individually.

# WOOD BORING BITS

## SPADE STYLE - HSS BY CHAMPION<sup>®</sup>

CUTTING TOOL CORP.

### Shank Overall

Dia.	Dia.	Lgth	Part No.
1/4	7/32	6	CH-8001-1/4
5/16	7/32	6	CH-8001-5/16
3/8	7/32	6	CH-8001-3/8
7/16	7/32	6	CH-8001-7/16
1/2	7/32	6	CH-8001-1/2
9/16	7/32	6	CH-8001-9/16
5/8	7/32	6	CH-8001-5/8
11/16	7/32	6	CH-8001-11/16
3/4	7/32	6	CH-8001-3/4
13/16	7/32	6	CH-8001-13/16
7/8	7/32	6	CH-8001-7/8
15/16	7/32	6	CH-8001-15/16
1	7/32	6	CH-8001-1
1-1/8	7/32	6	CH-8001-1-1/8
1-1/4	7/32	6	CH-8001-1-1/4
1-3/8	7/32	6	CH-8001-1-3/8
1-1/2	7/32	6	CH-8001-1-1/2



**Part# CH-8001-SET**

6 pc. Spade Bit Set Containing  
3/8, 1/2, 5/8, 3/4, 7/8, 1

### 12" WOOD BIT EXTENSION



**Part# 88601**

Add reach to power bits with this extension. Comes furnished with two set screws and a hex wrench.

## 17" AUGER DRILLS

### MONO SPUR - SINGLE FLUTE BY CHAMPION<sup>®</sup>

CUTTING TOOL CORP.



Dia.	Flute Lgth	Overall Lgth	Part No.
3/8	12	17	CH-8018-3/8
7/16	12	17	CH-8018-7/16
1/2	12	17	CH-8018-1/2
5/8	12	17	CH-8018-5/8
3/4	12	17	CH-8018-3/4
7/8	12	17	CH-8018-7/8
1	12	17	CH-8018-1

# VARI-BIT

## STEP DRILL BITS

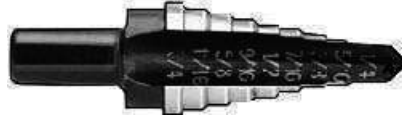

Number of Hole Sizes	Hole Sizes	Part No.
13	1/8, 5/32, 3/16, 7/32, 1/4, 9/32, 5/16, 11/32, 3/8, 13/32, 3/8, 13/32, 7/16, 15/32, 1/2	LEN-VB1
9	1/2, 9/16, 5/8, 11/16, 3/4, 13/16, 7/8, 15/16, 1	LEN-VB2
9	1/4, 5/16, 3/8, 7/16, 1/2, 9/16, 5/8, 11/16, 3/4	LEN-VB3
6	3/16, 1/4, 5/16, 3/8, 7/16, 1/2	LEN-VB4
2	3/8, 1/2	LEN-VB6
1	7/8	LEN-VB7
12	3/16, 1/4, 5/16, 3/8, 7/16, 1/2, 9/16, 5/8, 11/16, 3/4, 13/16, 7/8	LEN-VB8
2	7/8, 1-1/8	LEN-VB11
5	7/8, 1-1/8, 1-7/32, 1-1/4, 1-3/8	LEN-VB12
EXTENSION	8" Vari-Bit Extension, fits 3/8" drill chuck & larger	LEN-VBX8

**Packaged Individually.**

12

## VARI-BIT KITS

Furnished in Sturdy Plastic Case

Number of Sizes	Sizes Included	Part No.
4	VB1, VB2, VB7, VB8	LEN-VBK-4
3	VB1, VB2, VB3	LEN-889
6	VB1, VB2, VB6, VB7, VB8, VB11	LEN-VBKA-6

# HOLE SAWS

## BI-METAL - VARI-TOOTH

### 1-1/2" CUTTING DEPTH



Dia.	Pipe Tap	Pipe Clearance	Part No.
5/8	—	—	LEN-10L
3/4	1/2	3/8	LEN-12L
7/8	3/4	1/2	LEN-14L
1	—	—	LEN-16L
1-1/16	—	—	LEN-17L
1-1/8	1	3/4	LEN-18L
1-1/4	—	—	LEN-20L
1-3/8	—	1	LEN-22L
1-1/2	1-1/4	—	LEN-24L
1-5/8	—	—	LEN-26L
1-3/4	1-1/2	1-1/4	LEN-28L
1-7/8	—	—	LEN-30L
2	—	1-1/2	LEN-32L
2-1/8	—	—	LEN-34L
2-1/4	2	—	LEN-36L
2-1/2	—	2	LEN-40L
2-5/8	2-1/2	—	LEN-42L
3	—	2-1/2	LEN-48L

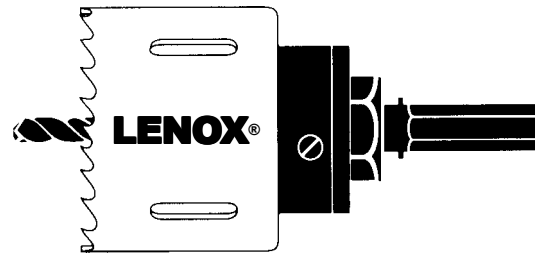

Dia.	Pipe Tap	Pipe Clearance	Part No.
3-1/4	3	—	LEN-52L
3-1/2	—	—	LEN-56L
3-5/8	—	3	LEN-58L
3-3/4	3-1/2	—	LEN-60L
4	—	—	LEN-64L
4-1/8	—	3-1/2	LEN-66L
4-1/2	—	—	LEN-72L
4-3/4	4-1/2	4	LEN-76L
5	—	—	LEN-80L
6	—	—	LEN-96L

## ARBORS

Fits Hole Saws	Shank Type	Chuck Size	Part No.
10L - 18L	Hex	1/2"+	LEN-1L
20L - 96L	Hex	1/2"+	LEN-2L
10L - 18L	Round	1/4"+	LEN-4L

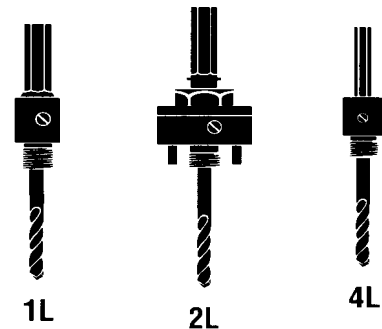

## ACCESSORIES

Description	Chuck Size	Fits Arbor#	Part No.
Pilot Drill	1/4"+	1L, 2L, 4L	LEN-4321
Arbor Adapter	—	1L, 4L	LEN-AA1
12" Extension	1/2"+	1L, 4L	LEN-12X

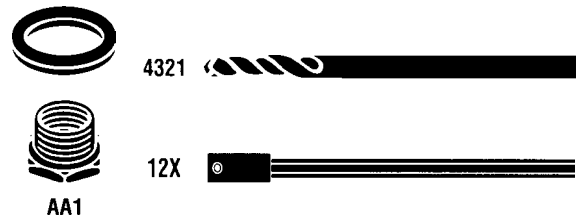

# HOLE SAW KITS



## LEN-500A AUTOMOTIVE

Five sizes used to install air conditioner hoses, door locks, sun roofs, antennas, etc. One each hole saws 3/4", 7/8", 1", 1-1/8", 1-1/4". One 5L arbor. One arbor adapter. Plastic case.

## LEN-400G GENERAL PURPOSE

Four sizes. One each hole saws 2", 3" 3-3/8", 4-1/8". Arbor: 2L. Plastic case.

## LEN-600R REFRIDGERATION

Six sizes preferred by refrigeration professionals. One each hole saws 5/8", 7/8", 1-1/8", 1-3/8", 1-5/8", 2-1/8". Arbors: 5L, 6L. One 56PD pilot drill. Plastic case.

## LEN-600P PLUMBER

Six sizes most commonly used for pipe tap and entrance. One each hole saws 3/4", 7/8", 1-1/8", 1-1/2", 1-3/4", 2-1/4". Arbors: 2L, 5L. One 4321 pilot drill. One arbor adapter. Plastic case.

## LEN-600L ELECTRICIAN

Six sizes most commonly used for pipe and conduit entrance. One each hole saws 7/8", 1-1/8", 1-3/8", 1-3/4", 2", 2-1/2". Arbors: 1L, 2L. One 4321 pilot drill. One arbor adaptor. Plastic case.

## LEN-700G GENERAL PURPOSE

Seven preferred sizes. One each hole saws 7/8", 1", 1-1/4", 1-3/8", 1-1/2", 1-3/4", 2-1/8". Arbors: 5L, 6L. One 56PD pilot drill. Plastic case.

## LEN-500G GENERAL PURPOSE

Five sizes. One each hole saws 2-1/8", 2-9/16", 3-1/4", 4-3/4". Arbor: 2L. Three 4321 pilot drills. Plastic case.



## LEN-1200G DELUXE

Twelve popular sizes. One each hole saws 5/8", 3/4", 7/8", 1", 1-1/8", 1-1/4", 1-3/8", 1-1/2", 1-3/4", 2", 2-1/2", 3". Arbors: 1L, 2L. Three 4321 pilot drills. Plastic case.

## LEN-1200L ELECTRICIAN

Twelve sizes needed to bring pipe and conduit through floors, ceilings, partitions and into junction boxes. One each hole saws 3/4", 7/8", 1-1/8", 1-3/8", 1-3/4", 1-3/4", 2", 2-1/2", 2-11/16", 3", 3-5/8", 4-1/8", 4-3/4". Arbors: 2L, 5L. Two 4321 and one 56PD pilot drills. Plastic case.

## LEN-1200P PLUMBER

Twelve sizes. One each hole saws 3/4", 7/8", 1-1/8", 1-1/2", 1-3/4", 2-1/4", 2-9/16", 3", 3-1/2", 4", 4-1/4", 4-1/2". Arbors: 2L, 5L. Two 4321 and one 56PD pilot drills. Plastic case.

## LEN-2000G BIG DADDY

Sixteen sizes handle just about all installation, maintenance and repair jobs. One each hole saws 3/4", 7/8", 1", 1-1/8", 1-3/8", 1-1/2", 1-3/4", 2", 2-1/8", 2-1/4", 2-1/2", 2-11/16", 3", 3-1/4", 3-3/8", 3-5/8", 3-3/4", 4-1/8", 4-1/2", 4-3/4". Arbors: 1L, 2L and 5L. Two 4321 pilot drills and one 56D pilot drill. Plastic case.



# HACKSAW BLADES

## BI-METAL



FEATURES	ADVANTAGES	BENEFITS
<ul style="list-style-type: none"> <li>• Bi-metal construction</li> <li>• Spring steel back</li> <li>• M-2 high speed steel cutting edge</li> <li>• Tooth hardness Rc 64-66</li> </ul>	<ul style="list-style-type: none"> <li>• Virtually unbreakable</li> <li>• Shatter resistant</li> <li>• Shock resistant</li> <li>• High heat resistance</li> </ul>	<ul style="list-style-type: none"> <li>• Lasts longer</li> <li>• Safer than soled high speed steel blades</li> <li>• Outperforms carbon steel up to 10 to 1</li> <li>• Increases blade life</li> <li>• Easier to push through the cut</li> <li>• Smoother cut</li> <li>• Freer cutting action</li> <li>• Faster cutting</li> </ul>

Length x Width x Thickness	Teeth Per Inch	Part #/ Each	Part #/ 10 Pk
10" x 1/2 x .025	18	LEN-V018HE	LEN-V018HE-10
10" x 1/2 x .025	24	LEN-V024HE	LEN-V024HE-10
12" x 1/2 x .025	18	LEN-V218HE	LEN-V218HE-10
12" x 1/2 x .025	24	LEN-V224HE	LEN-V224HE-10
12" x 1/2 x .025	32	LEN-V232HE	LEN-V232HE-10

### FRAMES

#### LEN-4012

High tension hand hacksaw frame. Includes 12" bi-metal blade.

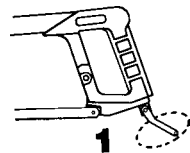

**1**  
Lever tensions the blade to 30,000 psi.



**2**  
Mount blade at 45° for flush cutting jobs.



**3**  
Use blade as jab saw.

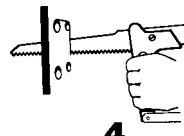

**4**  
Use as compass saw with reciprocating blade.

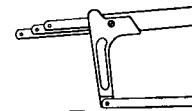

**5**  
Store spare blades inside tubular back.

#### LEN-2012

Heavy duty aluminum handle hacksaw frame with 12" bi-metal blade.



#### LEN-975

Rugged heavy duty aluminum handle. Designed for hard-to-get-at places. Cuts bolts, wire, tubing and plastic. Includes 10" bi-metal blade.



# RECIPROCATING SAW BLADES



## BLADE CONSTRUCTION

Electron Beam Weld  
High Speed Steel Edge  
Rc 65-66



Standard Tooth

Vari-Tooth®

V Tooth 60° Angle  
(Plaster Blade 636RP Only)

## TOOTH FORMS

### FEATURES

- Bi-metal construction
- Matrix II type alloy high speed steel cutting edge (8% cobalt edge)
- Tooth Hardness Rc 65-66
- Precision milled teeth
- 17° tooth back clearance angle 656R, 956R, 156R, 676RC,
- Angled tang

### ADVANTAGES

- Shatter resistant
- Shock resistant teeth
- High wear resistance
- High heat resistance
- More aggressive cut

### BENEFITS

- Cuts through tough materials including nail-embedded wood
- Longer Life
- Retains tooth sharpness longer
- Increases productivity
- Faster cutting

Length x Width x Thickness	Teeth Per Inch	Recommended Use	Pkg Qty	Part #/ Each	Part #/ Pkg	Shape
6" x 3/4 x .050	6	Rough work in wood (including nail embedded wood), fast cutting, used in remodeling and demolition work.	5	LEN-656R	LEN-656R-5	
9" x 3/4 x .050	6		5	LEN-956R	LEN-956R-5	
12" x 3/4 x .050	6		5	LEN-156R	LEN-156R-5	
6" x 7/16 x .050	6	Wood contours.	5	LEN-676RC	LEN-676RC-5	
6" x 3/4 x .035	6	Wood (including nail embedded wood), all composition materials.	5	LEN-606R	LEN-606R-5	
6" x 3/4 x .035	4	Nail free woods, fast cutting.	5	LEN-634R	LEN-634R-5	
6" x 3/4 x .035	10	Wood (including nail embedded wood), compositions, plastic, cast aluminum & non-ferrous metals.	5	LEN-610R	LEN-610R-5	
8" x 3/4 x .050	10	Wood (including nail embedded wood), compositions, plastic, cast aluminum, light non-ferrous metals, stainless steel.	5	LEN-810R	LEN-810R-5	
3" x 1/4 x .032	14	Irregular contours, wood, compositions & metal over 1/2".	5	LEN-314RC	LEN-314RC-5	
12" x 3/4 x .050	10/14	All woods (including nail embedded wood), plastic, cast aluminum, light non-ferrous metals, stainless steel.	5	LEN-110R	LEN-110R-5	

12

# RECIPROCATING SAW BLADES



## BLADE CONSTRUCTION

Electron Beam Weld  
High Speed Steel Edge  
Rc 65-66

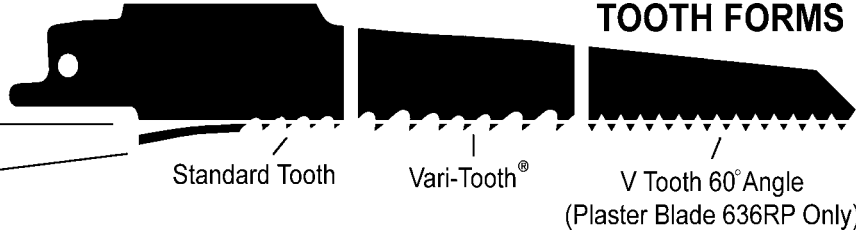

## TOOTH FORMS

Length x Width x Thickness	Teeth Per Inch	Recommended Use	Pkg Qty	Part #/ Each	Part #/ Pkg	Shape
4" x 3/4 x .035	14	Heavy gage metal 1/4"-1/2", hard rubber, fiber & angle iron.	5	LEN-414R	LEN-414R-5	
6" x 3/4 x .035	14		5	LEN-614R	LEN-614R-5	
4" x 3/4 x .035	18	Heavy gage metal 1/8"-1/4", conduit & tubing, opening wood crates (including nail embedded wood), removing wood siding or shingles.	5	LEN-418R	LEN-418R-5	
6" x 3/4 x .035	18		5	LEN-618R	LEN-618R-5	
8" x 3/4 x .035	18		5	LEN-818R	LEN-818R-5	
3" x 1/4 x .032	18	Contours, metals under 1/8".	5	LEN-318RC	LEN-318RC-5	
4" x 3/4 x .035	24	Metal & galvanized pipe 18 gage & under	5	LEN-424R	LEN-424R-5	
6" x 3/4 x .035	24		5	LEN-624R	LEN-624R-5	
6" x 3/4 x .050	6	Plaster, plaster board.	5	LEN-636RP	LEN-636RP-5	
8" x 3/4 x .042	Medium Carbide Grit	Hard to cut abrasive materials, fiberglass, ceramic tiles, cast iron pipe.	2	LEN-800RG	LEN-800RG-2	
9" x 7/8 x .062	6	Rough work in wood (including nail embedded wood), straight cutting, demolition work, rescue operations.	2	LEN-966R	LEN-966R-2	
9" x 7/8 x .062	10	Heavy gage metal 1/4" & above, straight cutting, demolition work and rescue work.	2	LEN-960R	LEN-960R-2	
6" x 3/4 x .050	10/14	Heavy gage metal 1/8"-1/2". Situations including rescue operations.	2	LEN-650R	LEN-650R-2	

# JIG SAW BLADES

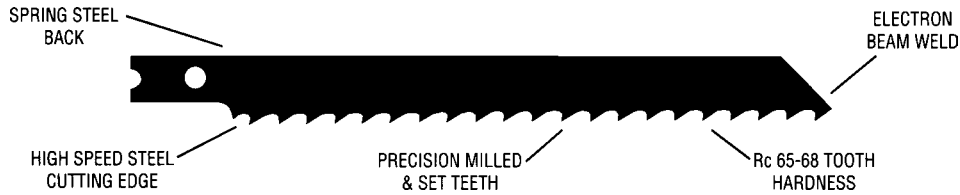

FEATURES	ADVANTAGES	BENEFITS
<ul style="list-style-type: none"> <li>• Bi-metal construction</li> <li>• 8% cobalt high speed steel cutting edge</li> <li>• Tooth Hardness Rc 65-66</li> <li>• Precision milled teeth</li> <li>• 0° tang angle</li> <li>• Tangs fit all major manufacturers of jig saw machines</li> </ul>	<ul style="list-style-type: none"> <li>• Shatter resistant</li> <li>• Shock resistant teeth</li> <li>• High wear resistance</li> <li>• High heat resistance</li> </ul>	<ul style="list-style-type: none"> <li>• Cuts through most materials including stainless steel and nail-embedded wood</li> <li>• Longer Life</li> <li>• Retains tooth sharpness longer</li> <li>• Increases productivity</li> <li>• Faster cutting</li> </ul>

Length x Width x Thickness	Teeth Per Inch	Tooth Style	Recommended Use	Pkg Qty	Part #/ Each	Part #/ Pkg
4-1/2" x 3/8 x .050	6	Milled	Wood, Fast Cut, Rough Cut	2	LEN-486J	LEN-486J-2
4-1/2" x 3/8 x .050	10	Milled	Wood, Nail Embedded	2	LEN-480J	LEN-480J-2
4-1/2" x 5/16 x .050	6	Ground	Wood, Fast Cut, Clean Cut, Plastic.	2	LEN-456J	LEN-456J-2
4" x 1/4 x .050	6	Ground	Wood/Plastic, Contour/Scroll, Clean Cut.	2	LEN-416JC	LEN-416JC-2
4" x 5/16 x .050	10	Ground	Wood, Very Smooth/Clean Cut.	2	LEN-450J	LEN-450J-2
4" x 5/16 x .050	10	Ground	Wood, Down Cutting, Reverse Tooth, Plastic, Laminates.	2	LEN-450JR	LEN-450JR-2
3" x 3/16 x .050	20	Ground V	Veneers & Laminates, Fine Finishing, Contour/Scroll, Paneling, Formica.	2	LEN-320JC	LEN-320JC-2
3" x 3/8 x .037	14	Milled	Metal Over 1/4" Thick.	2	LEN-314J	LEN-314J-2
3" x 3/8 x .037	18	Milled	Metal Over 1/8" Thick, General Purpose.	2	LEN-318J	LEN-318J-2
5-1/4" x 3/8 x .050	18	Milled	Metal, Structural & Large Cross Section.	2	LEN-518J	LEN-518J-2
3" x 3/8 x .037	24	Milled	Thin Metal, Plastic, Polys, Paneling.	2	LEN-324J	LEN-324J-2
3" x 5/16 x .032	Medium Carbide Grit	-	Ceramic Tile, Fiberglass, Plastic.	2	LEN-GT300J	LEN-GT300J-2

# PORTABLE BAND SAW BLADES

MASTER-BAND® BI-METAL



FEATURES	ADVANTAGES	BENEFITS
<ul style="list-style-type: none"> <li>• Bi-metal construction</li> <li>• Matrix II type alloy high speed steel cutting edge (8% cobalt edge)</li> <li>• Tooth Hardness Rc 65-66</li> <li>• Vari-Tooth® or standard tooth forms available</li> </ul>	<ul style="list-style-type: none"> <li>• Tough shock resistant alloy with less tooth chippage</li> <li>• Withstands higher cutting temperatures than M-2 or carbon steel blades</li> </ul>	<ul style="list-style-type: none"> <li>• Lasts longer on interrupted cuts and mild to difficult to machine materials</li> <li>• Attains higher productivity than M-2 or carbon steel blades</li> </ul>

## SOLD 3 PER BOX ONLY

Length x Width x Thickness	Teeth Per Inch	Part # Pk / 3
3' 8-7/8" x 1/2 x .020	10/14	LEN-80114
3' 8-7/8" x 1/2 x .020	14	LEN-80115
3' 8-7/8" x 1/2 x .020	18	LEN-80116
3' 8-7/8" x 1/2 x .020	24	LEN-80117

# HAND TAPS

## CARBON STEEL BY CHAMPION<sup>®</sup>

CUTTING TOOL CORP.



### Plug Style

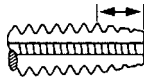

Has 3 to 5 Chamfered threads. Use in through holes as well as in blind holes with sufficient space at the bottom for chips to accumulate.

### Taper Style

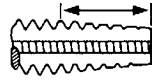

Has 7 to 10 chamfered threads. Commonly used in through holes and for starting threads.

### Bottom Style

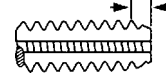

Has 1 to 2 chamfered threads. Use in blind holes where threads must come as close to the hole's bottom as possible.

Size	# of Flutes	Thread Length	Overall Length	Part # Plug Style	Part # Taper Style	Part # Bottom Style	Part # 3 pc. Set
0-80	2	5/16	1-5/8	CH-308-0-80-P	CH-308-0-80-T	CH-308-0-80-B	CH-308-0-80-S
1-64	2	3/8	1-11/16	CH-308-1-64-P	CH-308-1-64-T	CH-308-1-64-B	CH-308-1-64-S
1-72	2	3/8	1-11/16	CH-308-1-72-P	CH-308-1-72-T	CH-308-1-72-B	CH-308-1-72-S
2-56	3	7/16	1-3/4	CH-308-2-56-P	CH-308-2-56-T	CH-308-2-56-B	CH-308-2-56-S
2-64	3	7/16	1-3/4	CH-308-2-64-P	CH-308-2-64-T	CH-308-2-64-B	CH-308-2-64-S
3-48	3	1/2	1-13/16	CH-308-3-48-P	CH-308-3-48-T	CH-308-3-48-B	CH-308-3-48-S
3-56	3	1/2	1-13/16	CH-308-3-56-P	CH-308-3-56-T	CH-308-3-56-B	CH-308-3-56-S
4-40	3	9/16	1-7/8	CH-302-4-40-P	CH-302-4-40-T	CH-302-4-40-B	CH-302-4-40-S
4-48	3	9/16	1-7/8	CH-308-4-48-P	CH-308-4-48-T	CH-308-4-48-B	CH-308-4-48-S
5-40	3	5/8	1-15/16	CH-302-5-40-P	CH-302-5-40-T	CH-302-5-40-B	CH-302-5-40-S
5-44	3	5/8	1-15/16	CH-308-5-44-P	CH-308-5-44-T	CH-308-5-44-B	CH-308-5-44-S
6-32	3	11/16	2	CH-302-6-32-P	CH-302-6-32-T	CH-302-6-32-B	CH-302-6-32-S
6-40	3	11/16	2	CH-308-6-40-P	CH-308-6-40-T	CH-308-6-40-B	CH-308-6-40-S
8-32	4	3/4	2-1/8	CH-302-8-32-P	CH-302-8-32-T	CH-302-8-32-B	CH-302-8-32-S
8-36	4	3/4	2-1/8	CH-308-8-36-P	CH-308-8-36-T	CH-308-8-36-B	CH-308-8-36-S
10-24	4	7/8	2-3/8	CH-302-10-24-P	CH-302-10-24-T	CH-302-10-24-B	CH-302-10-24-S
10-32	4	7/8	2-3/8	CH-302-10-32-P	CH-302-10-32-T	CH-302-10-32-B	CH-302-10-32-S
12-24	4	15/16	2-3/8	CH-302-12-24-P	CH-302-12-24-T	CH-302-12-24-B	CH-302-12-24-S
12-28	4	15/16	2-3/8	CH-302-12-28-P	CH-302-12-28-T	CH-302-12-28-B	CH-302-12-28-S
1/4-20	4	1	2-1/2	CH-302-1/4-20-P	CH-302-1/4-20-T	CH-302-1/4-20-B	CH-302-1/4-20-S
1/4-28	4	1	2-1/2	CH-302-1/4-28-P	CH-302-1/4-28-T	CH-302-1/4-28-B	CH-302-1/4-28-S
5/16-18	4	1-1/8	2-23/32	CH-302-5/16-18-P	CH-302-5/16-18-T	CH-302-5/16-18-B	CH-302-5/16-18-S
5/16-24	4	1-1/8	2-23/32	CH-302-5/16-24-P	CH-302-5/16-24-T	CH-302-5/16-24-B	CH-302-5/16-24-S
3/8-16	4	1-1/4	2-15/16	CH-302-3/8-16-P	CH-302-3/8-16-T	CH-302-3/8-16-B	CH-302-3/8-16-S
3/8-24	4	1-1/4	2-15/16	CH-302-3/8-24-P	CH-302-3/8-24-T	CH-302-3/8-24-B	CH-302-3/8-24-S
7/16-14	4	1-7/16	3-5/32	CH-302-7/16-14-P	CH-302-7/16-14-T	CH-302-7/16-14-B	CH-302-7/16-14-S
7/16-20	4	1-7/16	3-5/32	CH-302-7/16-20-P	CH-302-7/16-20-T	CH-302-7/16-20-B	CH-302-7/16-20-S
1/2-13	4	1-21/32	3-3/8	CH-302-1/2-13-P	CH-302-1/2-13-T	CH-302-1/2-13-B	CH-302-1/2-13-S
1/2-20	4	1-21/32	3-3/8	CH-302-1/2-20-P	CH-302-1/2-20-T	CH-302-1/2-20-B	CH-302-1/2-20-S
9/16-12	4	1-21/32	3-19/32	CH-302-9/16-12-P	CH-302-9/16-12-T	CH-302-9/16-12-B	CH-302-9/16-12-S
9/16-18	4	1-21/32	3-19/32	CH-302-9/16-18-P	CH-302-9/16-18-T	CH-302-9/16-18-B	CH-302-9/16-18-S
5/8-11	4	1-13/16	3-13/16	CH-302-5/8-11-P	CH-302-5/8-11-T	CH-302-5/8-11-B	CH-302-5/8-11-S
5/8-18	4	1-13/16	3-13/16	CH-302-5/8-18-P	CH-302-5/8-18-T	CH-302-5/8-18-B	CH-302-5/8-18-S
3/4-10	4	2	4-1/4	CH-302-3/4-10-P	CH-302-3/4-10-T	CH-302-3/4-10-B	CH-302-3/4-10-S
3/4-16	4	2	4-1/4	CH-302-3/4-16-P	CH-302-3/4-16-T	CH-302-3/4-16-B	CH-302-3/4-16-S
7/8-9	4	2-7/32	4-11/16	CH-302-7/8-9-P	CH-302-7/8-9-T	CH-302-7/8-9-B	CH-302-7/8-9-S
7/8-14	4	2-7/32	4-11/16	CH-302-7/8-14-P	CH-302-7/8-14-T	CH-302-7/8-14-B	CH-302-7/8-14-S
1-8	4	2-1/2	5-1/8	CH-302-1-8-P	CH-302-1-8-T	CH-302-1-8-B	CH-302-1-8-S
1-14	4	2-1/2	5-1/8	CH-302-1-14-P	CH-302-1-14-T	CH-302-1-14-B	CH-302-1-14-S
1-1/8-7	4	2-9/16	5-7/16	CH-302-1-1/8-7-P	CH-302-1-1/8-7-T	CH-302-1-1/8-7-B	CH-302-1-1/8-7-S
1-1/8-12	4	2-9/16	5-7/16	CH-302-1-1/8-12-P	CH-302-1-1/8-12-T	CH-302-1-1/8-12-B	CH-302-1-1/8-12-S
1-1/4-7	4	2-9/16	5-3/4	CH-302-1-1/4-7-P	CH-302-1-1/4-7-T	CH-302-1-1/4-7-B	CH-302-1-1/4-7-S
1-1/4-12	6	2-9/16	5-3/4	CH-302-1-1/4-12-P	CH-302-1-1/4-12-T	CH-302-1-1/4-12-B	CH-302-1-1/4-12-S

# HAND TAPS

## METRIC & PIPE TAPS BY **CHAMPION**<sup>®</sup>

CUTTING TOOL CORP.



### Metric

<b>COARSE</b>		<b>FINE</b>	
Size	Part #	Size	Part #
m3 x .5	15200	m8 x 1.00	15220
m4 x .7	15201	m10 x 1.25	15221
m5 x .8	15202	m10 x 1.00	15222
m6 x 1.00	15203	m11 x 1.25	15223
m7 x 1.00	15204	m12 x 1.50	15224
m8 x 1.25	15205	m12 x 1.25	15225
m9 x 1.25	15206	m14 x 1.50	15226
m10 x 1.50	15207	m14 x 1.25	15226A
m11 x 1.50	15208	m16 x 1.50	15227
m12 x 1.75	15209	m18 x 2.00	15228
m14 x 2.00	15210	m18 x 1.50	15228A
m16 x 2.00	15211		
m18 x 2.50	15212		



### Pipe

Size	Part #
1/8-27 NPT	<b>CH-304-1/8-27</b>
1/4-18 NPT	<b>CH-304-1/4-18</b>
3/8-18 NPT	<b>CH-304-3/8-18</b>
1/2-14 NPT	<b>CH-304-1/2-14</b>
3/4-14 NPT	<b>CH-304-3/4-14</b>
1-11 1/2 NPT	<b>CH-304-1-11-1/2</b>



## HEX RETHREADING DIES

Carbon Steel



Size	Part #	Size	Part #
		<b>Pipe</b>	
4-40	<b>CH-CS30-4-40</b>	1/8-27 NPT	<b>CH-CS30-1/8-27-NPT</b>
6-32	<b>CH-CS30-6-32</b>	1/4-18 NPT	<b>CH-330-1/4NPT</b>
8-32	<b>CH-CS30-8-32</b>	3/8-18 NPT	<b>CH-330-3/8NPT</b>
10-24	<b>CH-CS30-10-24</b>	1/2-14 NPT	<b>CH-330-1/2NPT</b>
10-32	<b>CH-CS30-10-32</b>	3/4-14 NPT	<b>CH-330-3/4NPT</b>
12-24	<b>CH-CS30-12-24</b>	1-11-1/2 NPT	<b>CH-330-1NPT</b>
1/4-20	<b>CH-CS30-1/4-20</b>		
1/4-28	<b>CH-CS30-1/4-28</b>	<b>Metric</b>	
5/16-18	<b>CH-CS30-5/16-18</b>	m3 x .5	<b>CH-CS30M-3X.5</b>
5/16-24	<b>CH-CS30-5/16-24</b>	m4 x .7	<b>CH-CS30M-4X.7</b>
3/8-16	<b>CH-CS30-3/8-16</b>	m5 x .8	<b>CH-CS30M-5X.8</b>
3/8-24	<b>CH-CS30-3/8-24</b>	m6 x 1.00	<b>CH-CS30M-6X1</b>
7/16-14	<b>CH-CS30-7/16-14</b>	m8 x 1.25	<b>CH-CS30M-8X1.25</b>
7/16-20	<b>CH-CS30-7/16-20</b>	m8 x 1.00	<b>CH-330M-8X1</b>
1/2-13	<b>CH-CS30-1/2-13</b>	m10 x 1.50	<b>CH-CS30M-10X1.5</b>
1/2-20	<b>CH-CS30-1/2-20</b>	m10 x 1.25	<b>CH-CS30M-10X1.25</b>
9/16-12	<b>CH-CS30-9/16-12</b>	m12 x 1.75	<b>CH-CS30M-12X1.75</b>
9/16-18	<b>CH-CS30-9/16-18</b>	m12 x 1.50	<b>CH-CS30M-12X1.5</b>
5/8-11	<b>CH-CS30-5/8-11</b>	m12 x 1.25	<b>CH-330M-12X1.25</b>
5/8-18	<b>CH-CS30-5/8-18</b>	m14 x 2.00	<b>CH-CS30M-14X2</b>
3/4-10	<b>CH-CS30-3/4-10</b>	m14 x 1.50	<b>CH-330M-14X1.5</b>
3/4-16	<b>CH-CS30-3/4-16</b>	m14 x 1.25	<b>CH-CS30M-14X1.25</b>
7/8-9	<b>CH-CS30-7/8-9</b>	m16 x 2.00	<b>CH-CS30M-16X2</b>
7/8-14	<b>CH-CS30-7/8-14</b>	m16 x 1.50	<b>CH-CS30M-16X1.5</b>
1-8	<b>CH-CS30-1-8</b>	m18 x 2.50	<b>CH-CS30M-18X2.5</b>
1-14	<b>CH-CS30-1-14</b>	m18 x 1.50	<b>CH-CS30M-18X1.5</b>

# TAP & DIE SETS / ACCESSORIES

## 40 PC. TAP & DIE SETS

### part# CH-CS40P

#### Standard Sizes

Style 302 plug taps and CS30 hex dies 4-40, 6-32, 8-32, 10-24, 10-32, 12-24, 1/4-20, 1/4-28, 5/16-18, 5/16-24, 3/8-16, 3/8-24, 7/16-14, 7/16-20, 1/2-13, 1/2-20, 1/8 NPT pipe tap & die, die stock, 2 tap wrenches, screw pitch gage, and screwdriver in molded plastic case.



### part# CH-CS40MP

#### Metric Sizes

Carbon taps and hex dies 3x.5, 3x.6, 4x.7, 4x.75, 5x.8, 5x.9, 6x1.0, 7x1.0, 8x1.25, 9x1.0, 9x1.25, 10x1.25, 10x1.5, 11x1.5, 12x1.5, 12x1.75; 1/8-28 BSP pipe tap & die, die stock, 2 tap wrenches, metric screw pitch gage, and screwdriver in molded plastic case.

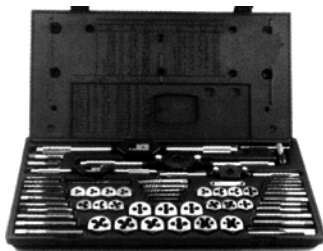

## 60 pc. TAP & DIE SET

### part# CH-CS60P

#### Standard Sizes

Style 302 plug taps and CS30 hex dies 4-40, 6-32, 8-32, 10-24, 10-32, 12-24, 1/4-20, 1/4-28, 5/16-18, 5/16-24, 3/8-16, 3/8-24, 7/16-14, 7/16-20, 1/2-13, 1/2-20, 9/16-12, 9/16-18, 5/8-11, 5/8-18, 3/4-10, 3/4-16; #1 - #5 screw extractors; 1/8 NPT & 1/4 NPT pipe taps & dies; 2 die stocks, 3 tap wrenches, screw pitch gage, and screwdriver in molded plastic case.



## 107 pc. TAP & DIE SET

### part# CH-CS107P

#### Standard/Metric Sizes

Style 302M plug taps and CS30M hex dies 3x.6, 4x.7, 4x.75, 5x.8, 5x.9, 6x1.0, 7x1.0, 8x1.25, 9x1.0, 9x1.25, 10x1.25, 10x1.5, 11x1.5, 12x1.5, 12x1.75, 14x1.25, 14x1.50, 16x1.5, 16x2.0, 18x1.5, 18x2.5; 1/8-28 BSP & 1/4-19 BSP pipe taps & dies.

Style 302 plug taps and CS30 hex dies 4-40, 6-32, 8-32, 10-24, 10-32, 12-24, 1/4-20, 1/4-28, 5/16-18, 5/16-24, 3/8-16, 3/8-24, 7/16-14, 7/16-20, 1/2-13, 1/2-20, 9/16-12, 9/16-18, 5/8-11, 5/8-18, 3/4-10, 3/4-16; #1 - #5 screw extractors; 1/8 NPT & 1/4 NPT pipe taps & dies; 2 die stocks, 3 tap wrenches, screw pitch gage, and screwdriver in molded plastic case.

12



### T-Handle Tap Wrenches

Spring tension holds T-Handle in place. Wrench jaws are adjustable and self equalizing.

**VER-21916** For tap sizes #0 - 1/4"  
**VER-21917** For tap sizes 1/4" - 1/2"



### Professional Quality Tap & Reamer Wrenches

Jaws are heat treated and hardened for long life. Precision screw adjustment.

**VER-21911** For tap sizes #4 - 1/2"  
**VER-21902** For tap sizes 1/4" - 3/4"

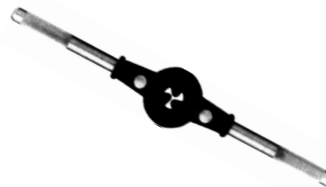

### Professional Quality Die Stocks

Three jaw, self-centering with adjustable guides. Easy starting, accurate threading.

**VER-21932** For 1" Round or Hex  
**VER-21924** For 1-1/2" Round



### Screw Pitch Gauges

Quick reference to screw pitches on V-threads.

**VER-21938** 0.45 to 2.50mm Metric  
**VER-21939** 10 to 40 U.S.



# SCREW EXTRACTORS

## LEFT HAND, SPIRAL FLUTE BY **CHAMPION**<sup>®</sup>

CUTTING TOOL CORP.



Size	Diameter Small End	Diameter Large End	Overall Length	For Bolt Sizes	For Pipe Sizes	Drill Size	Part #
1	.054	5/32	2	3/16 to 1/4	—	5/64	<b>CH-X1-1</b>
2	.80	3/16	2-3/8	1/4 to 5/16	—	7/64	<b>CH-X1-2</b>
3	1/8	1/4	2-11/16	5/16 to 7/16	—	5/32	<b>CH-X1-3</b>
4	3/16	21/64	2-7/8	7/16 to 9/16	—	1/4	<b>CH-X1-4</b>
5	1/4	7/16	3-3/8	9/16 to 3/4	1/8, 1/4	17/64	<b>CH-X1-5</b>
6	3/8	19/32	3-3/4	3/4 to 1	3/8	13/32	<b>CH-X1-6</b>
7	1/2	3/4	4-1/8	1 to 1-3/8	1/2	17/32	<b>CH-X1-7</b>
8	3/4	1	4-3/8	1-3/8 to 1-3/4	3/4	13/16	<b>CH-X1-8</b>
9	1	1-9/32	4-5/8	1-3/4 to 2-1/8	1	1-1/16	<b>CH-X1-9</b>
10	1-1/4	1-9/16	5	2-1/8 to 2-1/2	1-1/4	1-5/16	<b>CH-X1-10</b>
11	1-1/2	1-7/8	5-5/8	2-1/2 to 3	1-1/2	1-9/16	<b>CH-X1-11</b>
12	1-7/8	2-15/16	6-1/4	3 to 3-1/2	2	1-15/16	<b>CH-X1-12</b>

**Sold Individually**

Screw extractors are designed to be held in a tap wrench for the removal of broken screws, studs, bolts or pipe fittings. The left hand rotation of the tapered flutes forces out almost any right hand threaded part. Penetrating oil can be helpful in removing rusty or corroded parts.

To remove a broken screw: Drill a hole in the broken screw with the recommended diameter drill (fig. A). Insert the proper screw extractor into the hole and start a counterclockwise (left-hand) rotation (fig. B).

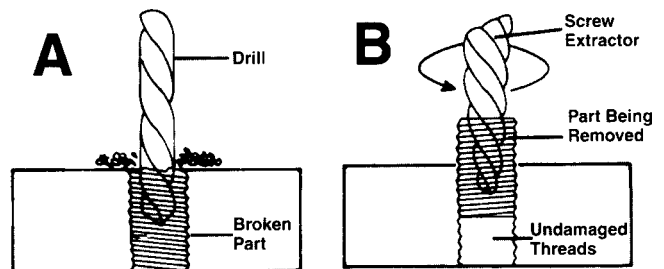

## SCREW EXTRACTOR SETS

### PACKED IN DURABLE VINYL POUCH

**CH-X1-1-5**  
**CH-X1-1-6**

5 pc. set from #1 to #5  
6 pc. set from #1 to #6

# HELICAL THREAD REPAIR

## STAINLESS STEEL REPAIR COILS

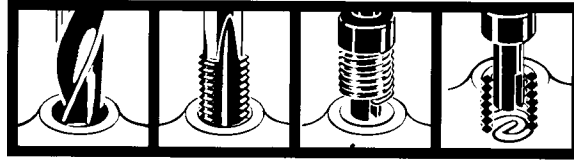

Drill Tap Install Tang Removal



Size	Complete Kit Part #	Inserts Per Kit	Drill Size	Repl. Tap Part #	Installation Tool Part #	Repl. Insert Pack Part #	Inserts Per Repl. Pack
------	---------------------	-----------------	------------	------------------	--------------------------	--------------------------	------------------------

### USS COARSE THREAD

4-40	CHY-K2104	6	#31	CHY-T6104	CHY-87004	CHY-83104	12
6-32	CHY-K2108	6	#25	CHY-T6108	CHY-87008	CHY-83108	12
8-32	CHY-K2110	6	11/64	CHY-T6110	CHY-87010	CHY-83110	12
10-24	CHY-K2112	6	13/64	CHY-T6112	CHY-87012	CHY-83112	12
1/4-20	CHY-K2116	6	17/64	CHY-T6116	CHY-87016	CHY-83116	12
5/16-18	CHY-K2118	5	21/64	CHY-T6118	CHY-87018	CHY-83118	10
3/8-16	CHY-K2120	5	25/64	CHY-T6120	CHY-87020	CHY-83120	10
7/16-14	CHY-K2122	4	29/94	CHY-T6122	CHY-87022	CHY-83122	6
1/2-13	CHY-K2124	4	17/32	CHY-T6124	CHY-87024	CHY-83124	6
9/16-12	CHY-K2127	3	19/32	CHY-T6127	CHY-87027	CHY-83127	6
5/8-11	CHY-K2129	3	21/32	CHY-T6129	CHY-87029	CHY-83129	6
3/4-10	CHY-K2131	3	25/32	CHY-T6131	CHY-87031	CHY-83131	4

### SAE FINE THREAD

10-32	CHY-K2113	6	13/64	CHY-T6113	CHY-87013	CHY-83113	12
1/4-28	CHY-K2117	6	17/64	CHY-T6117	CHY-87016	CHY-83117	12
5/16-24	CHY-K2119	5	21/64	CHY-T6119	CHY-87019	CHY-83119	10
3/8-24	CHY-K2121	5	25/64	CHY-T6121	CHY-87021	CHY-83121	10
7/16-20	CHY-K2123	4	29/64	CHY-T6123	CHY-87024	CHY-83123	6
1/2-20	CHY-K2126	4	33/64	CHY-T6126	CHY-87027	CHY-83126	6
9/16-18	CHY-K2128	3	37/64	CHY-T6128	CHY-87029	CHY-83128	6
5/8-18	CHY-K2130	3	41/64	CHY-T6130	CHY-87029	CHY-83130	6
3/4-16	CHY-K2132	3	49/64	CHY-T6132	CHY-87032	CHY-83132	4

### METRIC COARSE THREAD

m3 x .5	CHY-K2153	6	1/8	CHY-86153	CHY-87053	CHY-83153	12
m4 x .7	CHY-K2155	6	11/64	CHY-86155	CHY-87010	CHY-83155	12
m5 x .8	CHY-K2156	6	13/64	CHY-T6156	CHY-87013	CHY-83156	12
m6 x 1.00	CHY-K2157	6	1/4	CHY-T6157	CHY-87016	CHY-83157	12
m8 x 1.25	CHY-K2160	5	21/64	CHY-T6160	CHY-87019	CHY-83160	10
m9 x 1.25	CHY-K2162	5	3/8	CHY-T6162	CHY-87020	CHY-83162	10
m10 x 1.50	CHY-K2165	5	13/32	CHY-T6165	CHY-87020	CHY-83165	10
m11 x 1.50	CHY-K2168	4	29/64	CHY-T6168	CHY-87022	CHY-83168	6
m12 x 1.75	CHY-K2171	4	31/64	CHY-T6171	CHY-87024	CHY-83171	6
m14 x 2.00	CHY-K2173	4	37/64	CHY-T6173	CHY-87027	CHY-83173	6
m16 x 2.00	CHY-K2175	3	21/32	CHY-T6175	CHY-87029	CHY-83175	6

### METRIC FINE THREAD

m10 x 1.25	CHY-K2164	5	13/32	CHY-T6164	CHY-87021	CHY-83164	10
m12 x 1.50	CHY-K2170	4	31/64	CHY-T6170	CHY-87024	CHY-83170	6
m14 x 1.50	CHY-K2172	4	9/16	CHY-T6172	CHY-87027	CHY-83172	6
m16 x 1.50	CHY-K2174	3	21/32	CHY-T6174	CHY-87031	CHY-83174	6

# RAZOR KNIVES & ACCESSORIES

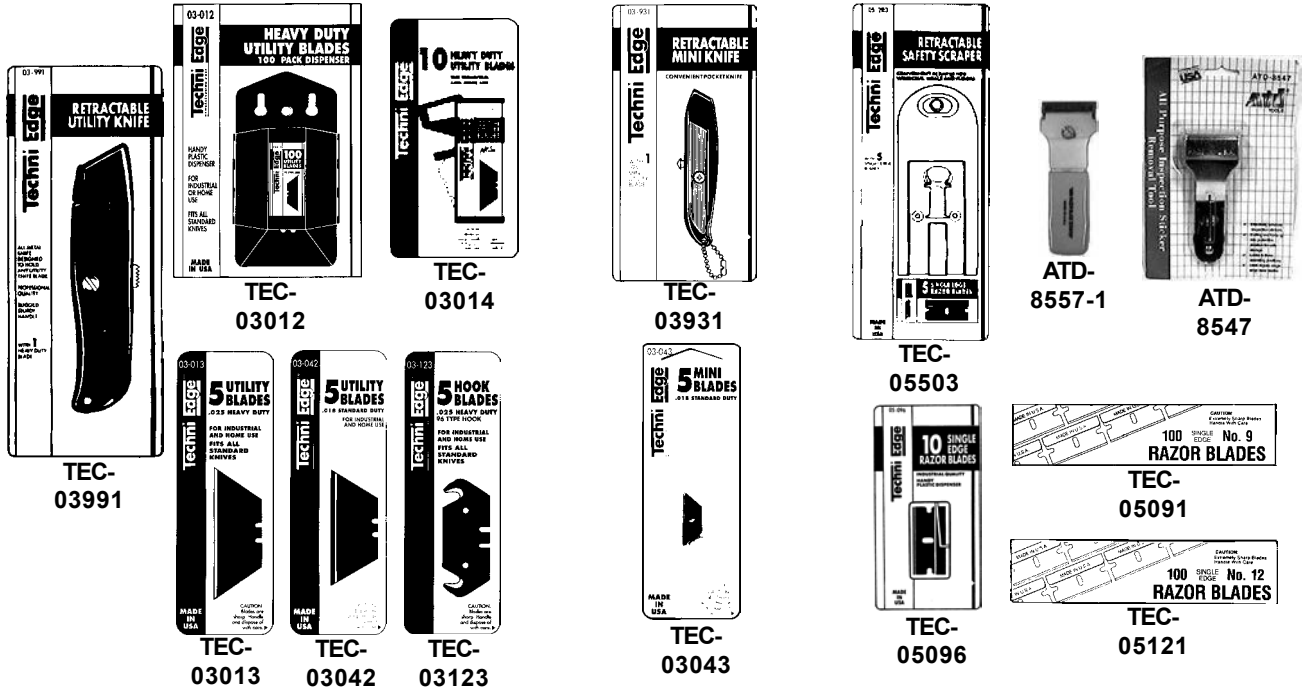

## RETRACTABLE UTILITY KNIFE

This knife has a safety overlap feature. All metal knife designed to hold any utility knife blade. Has a rugged sturdy handle and comes with 1 heavy duty blade. A professional quality knife.

part # **TEC-03991** For 1 Knife

\* **100 pk - UTILITY BLADES .025 HEAVY DUTY w/dispenser**

part # **TEC-03012** For 1 Pack

\* **10 pk - UTILITY BLADES .025 HEAVY DUTY w/dispenser**

part # **TEC-03014** For 1 Pack

\* **5 pk - UTILITY BLADES .025 HEAVY DUTY**

part # **TEC-03013** For 1 Pack

\* **5 pk - UTILITY BLADES .018 STANDARD DUTY**

part # **TEC-03042** For 1 Pack

\* **5 pk - HOOK BLADES .025 HEAVY DUTY**

part # **TEC-03123** For 1 Pack

**Techni Edge**<sup>®</sup>  
 MANUFACTURING CORP.

## RETRACTABLE MINI KNIFE

Comes with 1 .025 mini utility blade. Convenient pocket knife.

part # **TEC-03931** For 1 Knife

\* **5 pk - MINI BLADES .025 HEAVY DUTY**

part # **TEC-03043** For 1 Pack

## RETRACTABLE SAFETY SCRAPER

A convenient scraper for windows, walls and floors. Comes with 5 single edge blades.

part # **TEC-05503** For 1 Scraper

## MINI RAZOR BLADE SCRAPER

part # **ATD-8557-1** For 1 Scraper

## ALL PURPOSE INSPECTION STICKER REMOVAL TOOL

part # **ATD-8547** For 1 Scraper

\* **10 pk - SINGLE EDGE RAZOR BLADES**

part # **TEC-05096** For 1 Pack

\* **100 pk - #9 SINGLE EDGE RAZOR BLADES**

part # **TEC-05091** For 1 Box

\* **100 pk - #12 SINGLE EDGE RAZOR BLADES**

part # **TEC-05121** For 1 Box

# RAZOR KNIVES & ACCESSORIES



TEC-01801

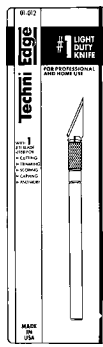

TEC-01012

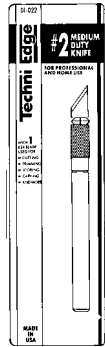

TEC-01022

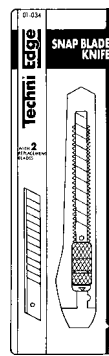

TEC-01034

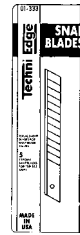

TEC-01333

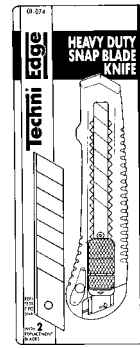

TEC-01074

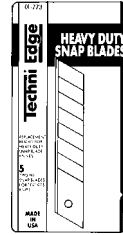

TEC-01773



TEC-01115



TEC-01215



TEC-01243

## HOBBY KNIFE & BLADE KIT

The kit contains: No. 1, 2, & 5 knives with 13 assorted blades. Comes in a wooden chest, and is for professional and home use.

part # **TEC-01801** For 1 Knife Kit

## #1 LIGHT DUTY KNIFE

Comes with 1 #11 blade used for cutting, trimming, scoring, carving, and more. For professional and home use.

part # **TEC-01012** For 1 Knife

## #2 MEDIUM DUTY KNIFE

Comes with 1 #24 blade used for cutting, trimming, scoring, carving and more. For professional and home use.

part # **TEC-01022** For 1 Knife

\* **5 ASSORTED BLADES - for light duty knife**  
part # **TEC-01115** For 1 Pack

\* **5 ASSORTED BLADES - for medium duty knife**  
part # **TEC-01215** For 1 Pack

\* **5 - #24 BLADES**  
part # **TEC-01243** For 1 Pack

## MINI SNAP BLADE KNIFE

Comes with 2 replacement blades.

part # **TEC-01034** For 1 Knife

\* **5 pk - MINI SNAP BLADES**  
part # **TEC-01333** For 1 Pack

## HEAVY DUTY SNAP BLADE KNIFE

Comes with 2 replacement blades.

part # **TEC-01074** For 1 Knife

\* **5 pk - HEAVY DUTY SNAP BLADES**  
part # **TEC-01773** For 1 Pack

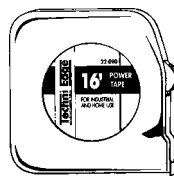

TEC-22080

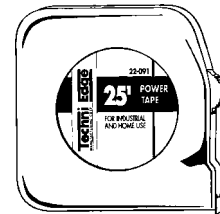

TEC-22081

## 16' & 25' POWER TAPE MEASURE

16 & 25 foot tape rule with positive locking action. Mylar protected 3/4" blade. Easy to read and is used for industrial and home use.

part # **TEC-22080** For 1 16' Tape

part # **TEC-22081** For 1 25' Tape

**Techni Edge**  
MANUFACTURING CORP

# Section 13: Abrasives

## Table of Contents

### Abrasive Wheels

Depressed Center Grinding Wheels .....	3
Challenger II Grinding/Bending Wheels .....	4
.045 Depressed Center Cutting Wheels .....	5

### Cutting Wheels

Thin High-Speed Cut-Off Wheels .....	5
Saittech Thin High Speed Cut-Off Wheels .....	5
.045 High Speed Cut-off Wheels .....	6
Chop Saw Wheels .....	7
Stationary Cut-Off Saw Wheels .....	8
Portable High Speed Cut-Off Saw Wheels .....	8

### Concrete Applications

Depressed Center Grinding Wheels .....	9
Portable High Speed Cut-Off Saw Wheels .....	9

### Coated Abrasives

Sait-Lok-R™ Laminated Discs .....	10
Sait-Lok-R™ Surface Conditioning Discs .....	10
3M Roloc™ Bristle Discs .....	11

Surface Conditioning Disc Holders .....	11
Sand-Light™ Abrasive Hand Pads .....	12
Sand Paper Sheets .....	12
Mini Shop Rolls .....	13
Saitscreen™ Rolls .....	13
Plumber Rolls .....	13
Sanding Belts .....	14
Saitlam Flap Discs .....	15
Flap Wheels .....	15

### Vitrified Bonded Abrasives

Bench Grinding Wheels .....	16
-----------------------------	----

### Wire Brushes

Bench Style .....	17
Cup Brushes .....	17
Knot Style Wire Wheels .....	17
End Brushes .....	18
Scratch Brushes .....	18
Acid Brushes .....	18



# ABRASIVE WHEELS

## TYPE 27 DEPRESSED CENTER GRINDING WHEELS

BY  **UNITED  
ABRASIVES, INC.**

- Virgin aluminum oxide grain assures consistent high stock removal for tough applications.
- All sizes are made with uniform grain throughout, no filler grain used in the backing.
- All wheels internally reinforced with the highest quality fiberglass for maximum safety.
- Super-Lock™ Hub on all 5/8-11 threaded wheels is the safest, vibration-free design.



### A24N

- » Aluminum oxide grain.
- » Soft bond for fast stock removal.
- » For applications on ferrous metals (steel, iron, welds, etc.) and low grade stainless steel.

### A24R

- » Aluminum oxide grain.
- » Our most popular wheel.
- » For general purpose grinding.
- » Longer life for fewer wheel changes.
- » For applications on ferrous metals (iron, steel, welds, etc.)

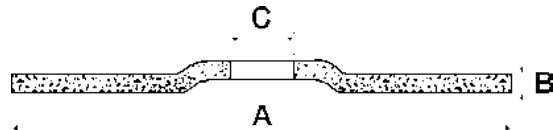

Size			Max RPM	Hub or No Hub	Part #		Qty
A Dia	B Width	C Bore			A24N	A24R	
4	3/16	3/8	13,500	No Hub	UA20010	—	25
4	1/4	5/8	13,500	No Hub	UA20015	—	25
4-1/2	3/16	7/8	13,300	No Hub	UA20050	—	25
4-1/2	1/4	7/8	13,300	No Hub	UA20060	UA20063	25
5	1/4	7/8	12,200	No Hub	UA20070	—	25
6	1/4	7/8	10,200	No Hub	UA20078	—	25
7	1/4	7/8	8,500	No Hub	—	UA20080	25
7	1/4	5/8-11	8,500	Hub	—	UA20086	10
9	1/4	7/8	6,600	No Hub	—	UA20090	25
9	1/4	5/8-11	6,600	Hub	—	UA20096	10

# ABRASIVE WHEELS

## CHALLENGER II FLEXIBLE GRINDING/BLENDING WHEELS

BY  **UNITED ABRASIVES, INC.**

- Up to two times the life of the Challenger for tough applications.
- Type 29 shape (see diagram below) allows easy control in grinding and blending applications.
- Honeycomb, dimpled pattern on face allows for greater cooling action and longer life.
- Grinds welds and blends in one-step, no need for multiple steps and products.
- Available in many grits for all your grinding and blending needs.



### Challenger II

- » Aluminum oxide grain.
- » Open pattern on wheel for cool grinding and blending.
- » Safe for use in the nuclear industry.
- » For use on steel, iron, aluminum, brass, bronze, stainless steel, plastic, fiberglass, and masonry.

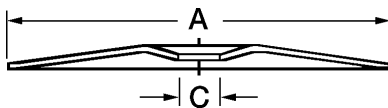

### Proper Clamping Procedures

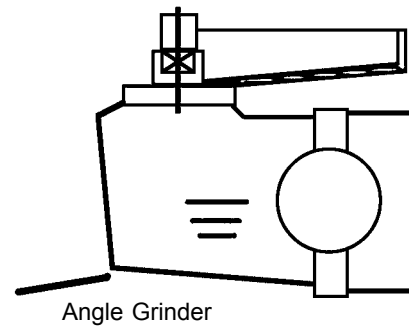
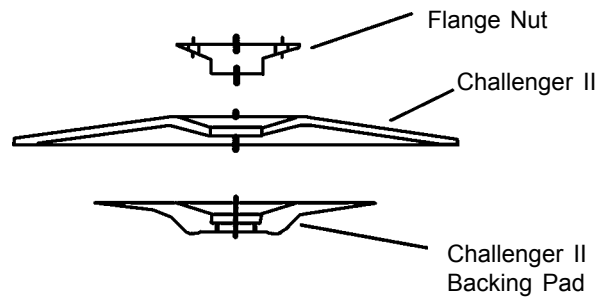

13

Size		Max RPM	Part #	Qty
A Dia	C Bore			
7	7/8	8,600	UA27511	25



# CUTTING WHEELS

## TYPE 1 THIN HIGH SPEED CUT-OFF WHEELS

BY  **UNITED ABRASIVES, INC.**

- Type 1 shape for square, burr-free cutting.
- Externally reinforced with fiberglass layers to provide ultimate safety in a thin wheel.
- Wide range of grit sizes available.

### A36T

- » Aluminum oxide grain.
- » Hard bond for aggressive cutting.
- » For applications on ferrous metals (iron, steel, welds, etc.) and on stainless steel.



Size			Max RPM	Part #	Qty
A Dia	B Width	C Bore			
2	1/16	1/4	30,558	UA23004	50
3	1/16	3/8	25,000	UA23040	50
3	.035	3/8	25,000	UA23050	100
4	1/16	5/8	19,000	UA23061	50

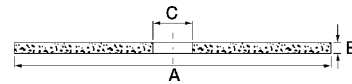

# CUTTING WHEELS

## SAITECH™ THIN HIGH SPEED CUT-OFF WHEELS

BY  **UNITED ABRASIVES, INC.**

- Type 1 shape for square, burr-free cutting.
- Patented 3M Cubitron grain formulation out lasts standard aluminum oxide wheels.
- Externally reinforced with fiberglass layers to provide ultimate safety in a thin wheel.

### Saitech Ultimate Performance™

- » Combines fast cutting with extremely long life.
- » For use on stainless steel, high tensile alloys, ferrous and/or non-ferrous metals.



Size			Max RPM	Part #	Qty
A Dia	B Width	C Bore			
3	1/16	3/8	25,000	UA23140	50
3	.035	3/8	25,000	UA23150	100
4	.035	3/8	19,000	UA23169	100

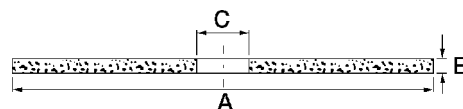

# CUTTING WHEELS

## TYPE 27 DEPRESSED CENTER .045 CUTTING WHEELS

BY  **UNITED ABRASIVES, INC.**

- Unique thin Type 27 shape can be used on all right angle grinders in accordance with ANSI B7.1.
- Special Aluminum Oxide formulation offers the fastest cutting, longest lasting thin wheels.
- Externally reinforced with fiberglass layers to provide ultimate safety in a thin wheel.

### A60S

- » Hard bond for extremely long life.
- » Fast, burr-free cutting.
- » For use on ferrous and/or non-ferrous metals (iron, steel, welds, etc.).



Size			Max RPM	Part #	Qty
A Dia	B Width	C Bore			
4-1/2	.045	7/8	13,300	UA22021	50

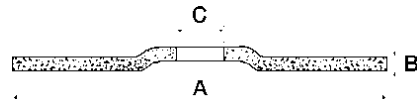

# CUTTING WHEELS

## TYPE 1 .045 HIGH SPEED CUT-OFF WHEELS

BY  **UNITED ABRASIVES, INC.**

- Type 1 shape for square, burr-free cutting.
- Special Aluminum Oxide formulation offers the fastest cutting, longest lasting thin wheels.
- Externally reinforced with fiberglass layers to provide ultimate safety in a thin wheel.
- Wide range of sizes available to fit both right angle grinders and circular saws.

### A60S

- » Use with reusable 5/8-11 adaptor to fit right angle grinders.
- » For use on ferrous and/or non-ferrous metals (iron, steel, welds, etc).



Size			Max RPM	Part #	Qty
A Dia	B Width	C Bore			
4-1/2	.045	7/8	13,300	UA23101	50

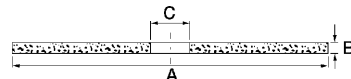

# CUTTING WHEELS

## CHOP SAW WHEELS

BY  **UNITED ABRASIVES, INC.**

- Specially formulated for use on low horsepower chop saw machines for fast cutting with minimal pressure.
- Three specialty formulas give you the exact wheel for your cutting application.
- Externally reinforced with the highest quality fiberglass to withstand the toughest applications.



### Stud King®

- » Aluminum oxide grain.
- » General purpose cool cutting on thin metals.
- » Burr-free finish.
- » Metal studding, thin rebar, light gauge metals.

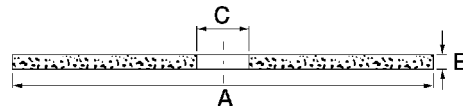

### Iron Worker™

- » Aluminum oxide grain.
- » Fast cutting.
- » Excellent for use on angle iron, channel iron, heavy rebar, and other ferrous metals.

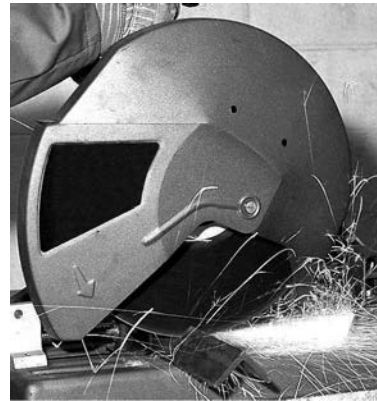

### Saitech Steel Worker™

- » New & Improved Formula for 14".
- » Formulated with 3M Cubitron grain
- » Extremely fast, burr-free cutting.
- » For applications on stainless steel, high tensile alloys and for use on ferrous metals (steel, iron, welds, etc.).

Size			Max RPM	Part #			Qty
A Dia	B Width	C Bore		S.K.	I.W.	Saitech®	
10	3/32	5/8	6,100	UA24035	—	—	25
12	3/32	1	5,100	—	UA24031	—	10
12	3/32	1	5,100	—	—	UA24033	10
14	3/32	1	4,400	UA24050	UA24051	—	10
14	3/32	1	4,400	—	—	UA24053	10

# CUTTING WHEELS

## WHEELS FOR STATIONARY CUT-OFF SAWS

BY  **UNITED ABRASIVES, INC.**

- Type 1 shape for square, burr-free cutting.
- Maximum grain exposure to cut through large diameter solid stock.
- Internal fiberglass reinforcement/dual external mounting area reinforcement for controlled performance.

### A24R

- » Aluminum oxide grain.
- » General purpose, long life.
- » For use on ferrous metals (iron, steel, angle iron, etc.).

Size			Max RPM	Part #	Qty
A Dia	B Width	C Bore			
12	1/8	1"	5,100	UA24020	10

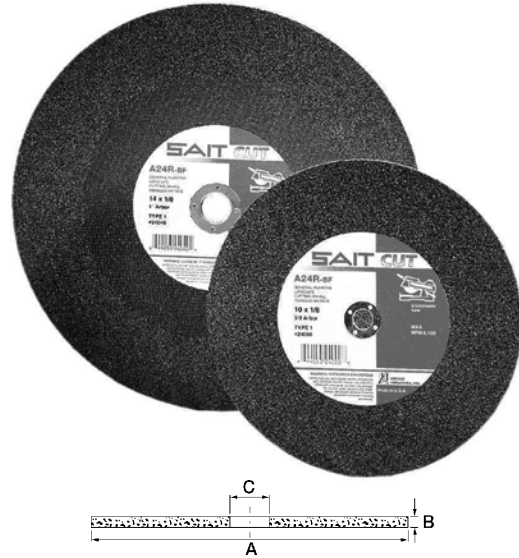

# CUTTING WHEELS

## HIGH SPEED CUT-OFF WHEELS FOR PORTABLE SAWS

BY  **UNITED ABRASIVES, INC.**

- Type 1 shape for square, burr-free cutting.
- Externally reinforced with the highest quality fiberglass to withstand the toughest applications.

### A24R

- » Aluminum oxide grain.
- » Provides consistent performance with long life.
- » For use on ferrous metals (steel, angle iron, rebar).

Size			Max RPM	Part #	Qty
A Dia	B Width	C Bore			
7	3/32	5/8	8,500	UA23234	25
12	1/8	1	6,300	UA23410	10
12	1/8	20mm	6,300	UA23420	10
14	1/8	20mm	5,460	UA23455	10



# MASONRY ABRASIVE WHEELS

## DEPRESSED CENTER GRINDING WHEELS

BY  **UNITED ABRASIVES, INC.**

- Special Silicon Carbide grain formula is excellent for grinding masonry, concrete, stone and aggregate.
- All sizes reinforced with the highest quality fiberglass for maximum safety and performance.

### C24N

- » Silicon carbide grain.
- » Soft bond for fast stock removal.
- » For use on masonry, concrete, stone, cast iron and other ferrous metals.



Size			Max RPM	Part #	Qty
A Dia	B Width	C Bore			
4	1/4	5/8	13,500	UA20017	25
4-1/2	1/4	7/8	13,300	UA20061	25

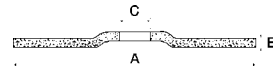

# MASONRY CUTTING WHEELS

## HIGH SPEED CUT-OFF WHEELS FOR PORTABLE SAWS

BY  **UNITED ABRASIVES, INC.**

- External fiberglass reinforcement withstands offhand lateral pressure for added safety and controlled performance.
- Special Silicon Carbide grain formula provides excellent cutting action on masonry, concrete, stone and aggregate.

### C24R

- » Silicon carbide grain.
- » For use on stone, brick, soft aggregate, masonry, concrete.



C24R

Big M.A.C.

Size			Max RPM	Part #		Qty
A Dia	B Width	C Bore		C24R	M.A.C.	
7	3/32	5/81	8,500	UA23233	—	25
12	1/8	20mm	6,300	—	UA23460	10
12	1/8	20mm	6,300	—	UA23463	10
14	1/8	20mm	5,400	UA23451	UA23464	10

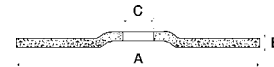

### Big M.A.C.

- » Special silicon carbide grain.
- » Superior cutting action.
- » 40% longer life than general purpose concrete wheels.
- » For use on masonry, asphalt, and concrete.

# COATED ABRASIVES

## SAIT-LOK-R™ LAMINATED DISCS

- 2-ply construction is rugged enough for contoured surfaces or flat surfaces.
- Quick-change backings for fast easy disc changes.
- Universal backings fit most major backing pad brands on the market.
- For use with stainless steel, high tensile steel, titanium, ferrous and/or non-ferrous metals.

Size	Grit	Part #	Qty
2	36	UA50271	100
2	50	UA50273	100
2	80	UA50275	100
2	120	UA50277	100
3	36	UA50278	50
3	50	UA50280	50
3	80	UA50282	50
3	120	UA50284	50



 **UNITED  
ABRASIVES, INC.**

# NON-WOVEN ABRASIVES

## SAIT-LOK-R™ & 3M™ SURFACE CONDITIONING DISCS

- Non-woven synthetic fiber coated with aluminum oxide grain resists loading for long life.
- Flexible construction for use on contoured surfaces.
- Non-woven disc can be switched to laminated disc using same backing pads for less downtime.
- Nylon screw type threaded hub for easy mounting to backing pad.

### Maroon

- » General purpose.
- » Excellent for deburring, blending, cleaning, polishing.
- » For use on stainless steel, ferrous and/or non-ferrous materials, fiberglass and gaskets.

### Brown

- » Heavy duty.
- » Excellent for deburring, blending, cleaning, polishing.
- » For use on stainless steel, ferrous and/or non-ferrous materials, fiberglass and gaskets.



Size	Color	Part #	3M Part #	Qty
2	Brown	UA77306	MMM-07480	25
2	Maroon	UA77308	MMM-07481	25
3	Brown	UA77312	MMM-07485	25
3	Maroon	UA77314	MMM-07486	25

# 3M ROLOC™ BRISTLE DISCS

## SURFACE CONDITIONING DISCS

---

- High maximum operating speed discs efficiently clean or strip many substances from metal surfaces without damaging the work piece.
- Quickly and easily achieves a quality, consistent finish with light pressure.
- Gasket removal in engine repair.
- Remove paint, rust, and dirt from machinery.
- Deburr and finish metal products.
- Paint and rust removal.
- Clean and remove light defects from aluminum.



Size	Grit	Color	Part #	Qty
2	50	Green	MMM-07524	1
2	80	Yellow	MMM-07525	1
3	50	Green	MMM-07526	1
3	80	Yellow	MMM-07527	1

---

## SURFACE CONDITIONING DISC HOLDERS

2" & 3"

### Disc Holders

(To be used with Sait-Lok-R Discs)

Size	Part #	Qty
2	ATD-3119	1
3	ATD-3120	1



# COATED ABRASIVES

## SAND-LIGHT™ ABRASIVE HAND PADS

- Non-woven synthetic fiber impregnated with abrasive grain for surface conditioning without damage to or removal of base material.
- Wet/dry construction for use in a wide range of applications.
- Reusable and long lasting design for economical use.



### By The Box

Size	Color	Part #	Qty
6 x 9	Brown	UA77440	20
6 x 9	Black	UA77446	20
6 x 9	Maroon	UA77447	20
6 x 9	Gray	UA77448	20
6 x 9	White	UA77486	20
6 x 9	Green	UA77496	20

### Individually

Size	Color	Part #	Qty
6 x 9	Brown	UA77440-1	1
6 x 9	Black	UA77446-1	1
6 x 9	Maroon	UA77447-1	1
6 x 9	Gray	UA77448-1	1
6 x 9	White	UA77486-1	1
6 x 9	Green	UA77496-1	1

### Brown

- » Heavy duty.
- » Excellent for removing heavy rust and cleaning welds.
- » For use on ferrous and/or non-ferrous metals.

### Black

- » For blending and finishing.
- » Excellent for paint removal.
- » For use on stainless steel, ferrous and/or non-ferrous metals.

### Maroon

- » General purpose.
- » For removing light rust.
- » Excellent for cleaning and brightening.
- » For use on ferrous and/or non-ferrous metals.

### Gray

- » Ultra fine.
- » For light finishing.
- » Excellent for sanding before/between finish coats.
- » For use on non-ferrous metals and wood.

### White

- » Light duty.
- » For light cleaning and polishing.
- » For use on fiberglass, vinyl, plastic, formica and ceramic.

### Green

- » General cleaning.
- » Excellent for stripping paint and varnish.
- » For use on ferrous and/or non-ferrous metals, paint and varnish.



**UNITED  
ABRASIVES, INC.**

## SAIT PAK™ 9 x 11 Sandpaper Sheets

Sold by the Pak

13

### All Purpose Aluminum Oxide Sheets

Grit	Grade	Part #	Sheets Per Pak
150	Fine	UA10010	5
100	Medium	UA10008	5
60	Coarse	UA10006	3
—	Assorted - 2VF, 1F, 1M	UA10015	5

### Waterproof Silicon Carbide Sheets

Grit	Grade	Part #	Sheets Per Pak
600	Ultra Fine	UA10034	5
320	Extra Fine	UA10031	5



# COATED ABRASIVES

## MINI SHOP ROLLS

- Resin over resin construction for a strong bond resistant to heat and moisture.
- Egyptian cotton cloth backing for superior durability.
- Open coat structure prevents loading.
- For hand applications.
- For use on ferrous and/or non-ferrous metals, wood, fiberglass, etc.

Size		Grit	Part #	Qty
Width	Length			
1-1/2	10 yards	60	UA80607	1
1-1/2	10 yards	80	UA80807	1
1-1/2	10 yards	120	UA81207	1
1-1/2	10 yards	180	UA81807	1



 **UNITED ABRASIVES, INC.**

## SAITSCREEN™ ROLLS

- Double sided for long life.
- Silicon carbide grain.
- Waterproof.
- For use on ferrous and/or non-ferrous metals (steel, solder, copper), ceramic, wood, paint, etc.

Size		Grit	Part #	Qty
Width	Length			
1-1/2	5 yards	120	UA84092	1
1-1/2	10 yards	80	UA84090	1
1-1/2	10 yards	120	UA84093	1
1-1/2	10 yards	180	UA84096	1



 **UNITED ABRASIVES, INC.**

## PLUMBER ROLLS

- Resin over glue construction for resistance to heat.
- Cloth backed for durability and flexibility.
- Aluminum oxide grain.
- Open coat structure prevents loading.
- Use dry only.
- Excellent for cleaning pipe ends.
- For use on ferrous and/or non-ferrous materials, and copper piping.

Size		Grit	Part #	Qty
Width	Length			
1-1/2	25 yards	120	UA80000	1



 **UNITED ABRASIVES, INC.**

# COATED ABRASIVES

## SILICON CARBIDE WET/DRY ABRASIVE BELTS

Sold by the Box

---

- Resin over resin construction for a strong bond that is resistant to heat and moisture.
- Waterproof backing for wet/dry use.

### C-W Material

- » Industrial quality silicon carbide grain.
- » Closed coat structure for more material removal.
- » X-weight backing - average weight & flexibility.
- » Waterproof backing
- » For use on glass, hard cast iron, ceramics, marble, stone, plastic, rubber, etc.



Size	Grit	Part #	Belts Per Box
4 x 24	60	UA58850	10

 **UNITED ABRASIVES, INC.**

# COATED ABRASIVES

## SAITLAM FLAP DISCS

- Offers combination of grinding/blending through the use of thick layers of industrial quality abrasive cloth bound to a backing.
- Nylon 6/6 backing — a non-scratching, high strength backing resistant to temperature extremes, common chemicals, and solvents.
- Combines the work of a depressed center grinding wheel and fiber discs to eliminate the need of two separate operations.
- For use on ferrous and/or non-ferrous metals (iron, steel, aluminum, brass, copper etc.).



Size		Grit	Part #	Qty
Dia	Arbor			
4-1/2	7/8	60	UA73460	10



# COATED ABRASIVES

## FLAP WHEELS

- Resin over resin construction for a strong bond resistant to heat and moisture.
- Closed coat structure for more material removal.
- High quality Egyptian cotton cloth backing provides superior durability.
- Excellent for cleaning, deburring, polishing, blending.
- For use with ferrous and/or non-ferrous metals (iron, steel, aluminum, copper, etc.) wood, plastic, fiberglass.



Size		Grit	Part #	Qty
Dia	Width			
2	1	60	UA70050	5
2	1	120	UA70052	5



# ABRASIVE WHEELS

## BENCH GRINDING WHEELS

Type 1



- Vitrified bond for long life.
- Individually packaged for safety and convenience.

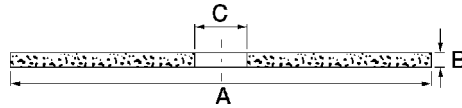

### Aluminum Oxide

- » Aluminum oxide grain.
- » General purpose.
- » For sharpening tools and light stock removal
- » For use with ferrous metals (carbon steel, steel, iron, forgings, etc.)

Size			Max RPM	Part #			Qty
A Dia	B Width	C Bore		A36	A60	A80	
6	3/4	1	4,138	UA28000	UA28001	UA28002	1
7	1	1	3,600	UA28013	—	UA28015	1
8	1	1	3,600	—	UA28024	—	1

# WIRE BRUSHES

## BENCH STYLE

For Bench or Straight Shaft Grinders

- Dense, compact crimped steel wire brush face.
- May be stacked to achieve wider work face.
- Primary application: For general scale removal, cleaning and surface preparation.
- Standard 2" arbor, with adaptor to listed arbor.
- Includes bushing pairs to adapt to variety of arbors.



Size			Face Width	Trim Length	Max RPM	Part #	Qty
Dia	Wire	Arbor					
6	.014	5/8, 1/2	Wide	1-1/16	6,000	UA09557	1
6	.014	5/8, 1/2	Narrow	1-3/16	6,000	UA09558	1
7	.014	5/8	Wide	1-9/16	6,000	UA09559	1
8	.014	5/8	Wide	1-1/2	4,000	UA01411	1

 **UNITED ABRASIVES, INC.**

## CUP BRUSHES

For Small Grinders

- Available in the following wire types:
  - Knot wire for low to medium flexibility and aggressive cutting action.
  - Crimped carbon steel wire for light cleaning and where greater flexibility is required.
  - Stainless steel knot wire for use on stainless, aluminum, and high strength alloys.
- Variety of threaded arbors available



Size			Wire Style	Matl Type	Max RPM	Part #	Qty
Dia	Wire	Arbor					
2-3/4	.014	M14 x 2.0	Knot	Stainless	12,500	UA06423	1
2-3/4	.014	M14 x 2.0	Crimped	Carbon	12,500	UA06401	1

 **UNITED ABRASIVES, INC.**

## KNOT & CRIMPED WIRE WHEELS

For Small Grinders

- For use on small grinders.
- Regular twist covers more surface area in a single pass.



Size			Matl Type	Max RPM	Part #	Qty
Dia	Wire	Arbor				
4	.014	M14 x 2.0	Stainless	20,000	UA06435	1

 **UNITED ABRASIVES, INC.**

# WIRE BRUSHES

## END BRUSHES

For Use On Portable Power Tools

- Excellent for use in cleaning and finishing recessed areas or pipes.
- Available in the following wire types:
  - Knot wire provides aggressive cutting action.
  - Circular flared end brush excellent for side cleaning action.
  - Crimped wire for high flexibility
- 1/4" shank diameter.



Size		Wire Style	Trim Length	Overall Length	Max RPM	Part #	Qty
Dia	Wire						
1	.020	Knot	1	2-5/8	20,000	UA06701	1
1	.020	Crimped	1	2-5/8	20,000	UA06709	1
3/4	.014	Crimped	1	2-5/8	20,000	UA06702	1
3/4	.014	Knot	1-1/8	2-5/8	20,000	UA06703	1
2-1/2	.012	Circular	11/16	1-3/4	20,000	UA06705	1

 **UNITED ABRASIVES, INC.**

## SCRATCH BRUSHES

- Excellent for light scale removal.
- Available in the following wire types:
  - Carbon steel wire for general purpose cleaning.
  - Stainless steel wire is carbon free.
- Primary application: Maintenance cleaning.



Size Rows	Wire Size	Type	Part #	Qty
3 x 19	.014	Curved Handle	UA05751	12
3 x 19	.014	Curved Handle with Scraper	UA05760	12
4 x 16	.014	Shoe Handle	UA05753	12
4 x 19	.014	Curved handle	UA05752	12
3 x 7	.006	Small Cleaning Brush — Stainless	UA05759	12

 **UNITED ABRASIVES, INC.**

## ACID BRUSHES



- Quality horsehair bristles.
- Machine trimmed and crimped to specification.

Trim Width	Trim Length	Overall Length	Part #	Qty
3/8	3/4	6"	UA00501	144
7/16	3/16	6-1/2	UA00502	144
9/16	7/8	6-1/8	UA00503	144

 **UNITED ABRASIVES, INC.**

# Section 14: Chemicals & Tapes

## Table of Contents

### Cleaners

Brake Cleaner .....	3
Carb & Chake Cleaner .....	3
Fuel Injector Cleaner .....	3
Engine Cleaner .....	3
Contact Cleaner .....	3
Simple Green .....	4
Armor All .....	4
Glass Cleaner .....	4
Car Wash Powder .....	4

### Hand Cleaners

Gojo .....	4
Fast Orange .....	5
Hand Wipes .....	5

### Penetrants

WD-40 .....	6
Liquid Wrench .....	6
Rust Breaker .....	6
PB Blaster .....	6

### Lubricants

Silicone Lube .....	7
White Lithium .....	7
Moly Lube .....	7
Open Gear & Wire Rope Lube .....	7
QTL Lube .....	7
TFE Dry Lube .....	7
Dry Graphite Lube .....	7
Air Tool Conditioner .....	7
Dielectric Tune-Up Grease .....	8
Grease Gun Cartridges .....	8
3-in-1 Household Oil .....	8
Anti-Seize Lubricant .....	8
Cutting Oil .....	8

### Adhesives

Super Glue .....	9
Rear View Mirror Adhesive .....	9
O-Ring Rubber Bond Adhesive .....	9
Fast Cure Epoxy .....	9
5 Minute General Purpose Epoxy .....	9
JB Weld .....	9
Epoxy Stick .....	10
Fast Tack .....	10
Super Weatherstrip .....	10

### Thread Locker and Repair

Threadlocker .....	10
Bearing Mount .....	10
Surface Prep for Threadlockers .....	11
Thread Sealants .....	11

### Gasketing

Silicone Sealant .....	12
Caulking Gun .....	12
Silicone Gasket Maker .....	12-13
Spray-A Gasket .....	14
Gasket Remover .....	14

### Tire Products

String Plugs .....	14
Tire Sealer and Inflator .....	14
Bead Sealer .....	14

### Winter Chemicals

Fuel Dryer and Anti-freeze .....	15
Diesel Fuel Conditioner & Antigal .....	15
Starting Fluid .....	15
Windshield Washer Anti-freeze .....	15
Windshield De-icer .....	15
Spray Bottle .....	15

# Section 14: Chemicals & Tapes

## Table of Contents

### Miscellaneous Chemicals

Belt Dressing .....	16
Undercoater .....	16
Fill and Seal Foam .....	16
Liquid Electrical Tape .....	16
Radiator Stop Leak .....	16
Screw Grab .....	16
Blue Layout Fluid .....	16
Wasp & Hornet Killer .....	16
Propane Fuel .....	16

### Paint

Primer .....	17
Enamel Paint .....	17
OSHA & Flourescent Paint .....	17
Metallic Paint .....	17
Farm & Implement Paint .....	17
Engine Paint .....	18
High Heat & Radiator Paint .....	18
Rust Tough Primer .....	18
Rust Tough Paint .....	18
Galvanizing Compound .....	18
Snap & Spray Gun .....	18

### Inverted Paint

Inverted Marking Paint .....	19
Striping Paint .....	19
Spotter Hand-Held Marker Wand .....	19
Wheeler Hand-Held Marking Wand .....	19

### Paint Accessories

Pant Brushes .....	20
Chip Brushes .....	20
Foam Brushes .....	20
Acid Brushes .....	20
Paint Roller Frames .....	20-21
Roller Covers .....	20-21
Paint Trays .....	20-21
Extension Handle .....	21

### Writing Utensils

Carpenter's Pencil .....	22
Yellow Lumber Crayon .....	22
Fine Point Black Marker .....	22
Dura-Ink #70 Marker .....	22
Paint Markers .....	22

### Tape

Electrical Tape .....	23
Duct Tape .....	24
Masking Tape .....	24
Packing Tape .....	24
Packing Tape Dispensers .....	24
Teflon Tape .....	25
3M Double Sided Tape .....	25
Filament Tape .....	25
Caution Tape .....	25
Danger Tape .....	25



# CHEMICALS

## AUTOMOTIVE CLEANERS

**Part Numbers indicate one of each item.**

**Where Case Quantities are Stated, Add "CS" to the part# to order a case.**

### Engine Degreaser - 12 oz.



- » Removes dirt, grease and varnish from mechanical engines, machinery and tools.
- » Won't damage wiring, insulation, distributor caps or painted surfaces.
- » Biodegradable, non-corrosive and non-staining.
- » **Case contains 12 cans.**

*part # CHE115*

### Non-Chlorinated Brake Cleaner - 15 oz.



- » Quickly cleans and degreases drum and disc brake systems without disassembly.
- » Dissolves brake fluid, oil, grease and other contaminants without leaving residue.
- » Non-corrosive to metals and doesn't have CFC propellant.
- » An excellent CV joint cleaner.
- » **Case contains 12 cans.**

*part # CHE110*

### Gunk Heavy Duty Engine Brite - 16 oz.



- » For automobiles, power mowers, marine, tractor, farm and garden tractors, and industrial machinery.
- » Heavy-duty engine degreaser that quickly removes grease and grime.
- » Clean engines run cool and last longer.
- » **Case contains 12 cans.**

*part # CHE165*

### Carburetor & Choke Cleaner - 12 oz.



- » High-pressure spray quickly removes fuel system gum and varnish deposits without leaving any residue.
- » Cleans carburetors, automatic chokes and PCV valves in seconds.
- » Oxygen sensor and catalytic converter safe.
- » **Case contains 12 cans.**

*part # CHE100*

### Gunk Foamy Engine Brite - 18 oz.



- » Nonflammable engine cleaner that quickly removes grease, dirt and grime from auto, marine and tractor engines.
- » Safe on most underhood rubber, plastic and paint when used as directed.
- » Also for farm equipment and industrial machinery.
- » **Case contains 12 cans.**

*part # CHE170*

### Fuel Injector Cleaner - 12 oz.



- » Super concentrated.
- » One treatment quickly and safely removes power-stealing gum and accumulated deposits in fuel injection system.
- » Unclogs dirty injectors, dissolves deposits to restore lost power, smooths rough idle and increases fuel economy.
- » **Case contains 12 bottles.**

*part # CHE103*

### Environmental Contact Cleaner - 11 oz.



- » Heavy-duty degreaser and quick-drying cleaner, Leaves no residue.
- » Ideal for sensitive non-energized equipment and precision instruments such as printed circuits, office machines, vacuum tube parts and computer systems.
- » No CFCs or HCFCs.
- » **Case contains 12 cans.**

*part # CHE120*

**\*\*\* CASE QUANTITIES \*\*\***  
 — To Order By The Case Add "CS" To The Part Number (ie: CHE105CS) —

# CHEMICALS

## CLEANERS

### Simple Green Cleaner/Degreaser - 32 oz.



- » Removes oil, lubricants, grime from washable surfaces. For pressure washing and steam cleaning, maintenance, food processing and preparation, parts washing.
- » Biodegradable, nontoxic, nonabrasive, & nonflammable.
- » Strong yet safe, rinses easily and can be diluted.
- » **Case contains 12 bottles.**

part # CHE122

### Gojo® Hand Cleaner - 4.5 lb Original Formula



- » Creme-style formula contains lanolin and soothing emollients.
- » Removes heavy grease, tar and oil.
- » Use with Dispenser (CHE405).
- » **Case contains 6 cartridge tubs.**

part # CHE395

### Armor All® Protectant - 16 oz.



- » For rubber, plastic & vinyl.
- » Effective for tires, door panels, vinyl seats, consoles, window trim, bumpers, weatherstripping, engine hoses, vinyl tops.
- » Protects against discoloration and cracking.
- » Protects & shines.
- » Guards against UV damage.
- » **Case contains 12 bottles.**

part # CHE123

### Gojo® Hand Cleaner - 4.5 lb. Pumice Formula



- » No. 1 choice of Professionals
- » Creme formula with fine Italian pumice scrubbing particles for extra cleaning action.
- » For removing heavy grease, tar and oil.
- » Use with dispenser (CHE405).
- » **Case contains 6 cartridge tubs.**

part # CHE400

### Glass Cleaner - 18 oz.



- » Multi-purpose glass cleaner deodorizes and cleans window film immediately.
- » For chrome, aluminum, stainless steel and enamel, to remove the toughest grease and dirt (smudges, smoke buildup, bugs, paint overspray).
- » **Case contains 12 cans.**

part # CHE125

### Gojo Dispenser



- » For use with 3-lb., 4-lb. and 4.5-lb. cartridges, sold separately.
- » Easy to load — remove cartridge lid, turn upside down, place on top of dispenser, snap and twist.

part # CHE405

### Car Wash Powder - No. 7



- » Fast and efficient wash for entire car including vinyl top, windows and chrome.
- » Strong enough to float off dirt and grime without harming finish of waxed surfaces.
- » Also great as household cleaner for walls, wood-work, tile, windows and floors.
- » Phosphate-free & bio-degradable.
- » **Case contains 12 cans.**

part # CHE190

### Scrubs In-A-Bucket - Dymon - 72 ct.



- » Waterless hand cleaner towels, with orange fragrance.
- » Premoistened, heavy duty towel with pumice scrubbing power.
- » Works fast to loosen, dissolve and absorb dirt and grease.
- » **Case contains 6 buckets.**

part # CHE410

\*\*\* CASE QUANTITIES \*\*\*

— To Order By The Case Add "CS" To The Part Number (ie: CHE105CS)—

# CHEMICALS

## HAND CLEANERS



### Fast-Orange Hand Cleaner Smooth Lotion

- » Industrial grade, biodegradable, waterless hand cleaner that doesn't contain harsh chemicals, mineral oils or ammonia that can sting cuts and abrasions.
- » Pure, fresh-smelling natural citrus power does the cleaning while aloe, lanolin, glycerin and jojoba condition and protect skin.
- » Gently deep cleans the toughest dirt and grease.
- » Use to remove resins, oil, grease, tar, grime, soil, printers' ink, epoxies, paint, rubber cement, gasket and tile cements.
- » **Case of 15 oz. Fast-Orange Hand Cleaner contains 12 bottles.**
- » **Case of gallon Fast-Orange Hand Cleaner contains 4 bottles.**

15 oz. part # CHE375  
1 gallon part # CHE380



### Fast-Orange Hand Cleaner Pumice Lotion

- » Industrial grade, biodegradable, waterless pumice hand cleaner that doesn't contain harsh chemicals, mineral oils or ammonia that can sting cuts and abrasions.
- » Pure, fresh-smelling natural citrus power does the cleaning while aloe, lanolin, glycerin and jojoba condition and protect skin.
- » Gently deep cleans the toughest dirt and grease. Use to remove resins, oil, grease, tar, grime, soil, printers' ink, epoxies, paint, rubber cement, gasket and tile cements.
- » **Case of 15 oz. Fast-Orange Hand Cleaner contains 12 bottles.**
- » **Case of gallon Fast-Orange Hand Cleaner contains 4 bottles.**

15 oz. part # CHE385  
1 gallon part # CHE390

### Fast-Orange Hand Cleaner Wipes - 72 ct.



- » Pre-moistened wipe has a textured surface on one side that is ideal for cleaning heavy-duty soils from hands, tools and work areas.
- » Use on field service trucks, industrial work stations, utility maintenance, transportation, municipal maintenance, and warehouse personnel.
- » **Case contains 6 buckets.**

part # CHE392

### \*\*\* CASE QUANTITIES \*\*\*

— To Order By The Case Add "CS" To The Part Number (ie: CHE105CS) —

# CHEMICALS

## PENETRANTS



### WD 40 Lubricant

- » Multipurpose - cleans, penetrates, protects, and lubricates just about anything.
- » Stops squeaks.
- » Cleans and protects tools, gears and other mechanisms.
- » Removes stickers and adhesives.
- » Shine and clean scratches on eyeglass rims.
- » USDA Classification H2.
- » **Case of 11 oz. WD 40 contains 12 cans.**
- » **Case of 1 gallon WD 40 contains 4 cans.**

11 oz. part # **CHE155**  
1 gallon part # **CHE160**

### Gunk Liquid Wrench - 11 oz.



- » Super Penetrant that is a powerful blend of quick-acting, super-penetrating solvents, not to be confused with ordinary penetrating oils.
- » Stops squeaks and squeals.
- » Makes sliding windows and doors move easily.
- » Loosens rusted nuts and bolts.
- » Releases frozen, corroded parts.
- » Frees seized joints and mechanisms.
- » Lubricates locks, hinges and casters.
- » Displaces moisture and inhibits corrosion.
- » **Case contains 12 cans.**

part # **CHE200**

### Rust Breaker™ Penetrant - 12 oz.



- » For releasing rusted or frozen lugs and bolts, lubricating tight-fitting parts, general overhaul, repair work.
- » Non-flammable transparent, non-staining oil.
- » Light film displaces moisture and acts as a corrosion preventative.
- » Jet stream sprays up to two feet for safe, accurate application.
- » Flashpoint: 205°F.
- » Dielectric strength: 33,000 volts.
- » Will not harm painted surfaces.
- » **Case contains 12 cans.**

part # **CHE195**



### PB Blaster Penetrating Catalyst - 12 oz.

- » Powerful, concentrated penetrating catalyst breaks free rusted joints and frozen parts by removing surface tension.
- » Prevents rust, corrosion, squeaking, and sticking problems.
- » Non-Evaporating lubricant.
- » Protects against further rust corrosion.
- » Saves time and equipment.
- » Works where others fail.
- » **Case contains 12 cans.**

part # **CHE203**

### \*\*\* CASE QUANTITIES \*\*\*

— To Order By The Case Add “CS” To The Part Number (ie: CHE105CS)—

# CHEMICALS

## AEROSOL LUBRICANTS

---

### Premium Silicone Lube - 10 oz.



- » Stops squeaks and sticking, eliminates friction, repels water and prevents freezing.
- » Does not harden or degrade from -40°F to 400°F.
- » Apply to wood, metal, fabric, rubber or leather.
- » Keeps rubber soft and flexible.
- » **Case contains 12 cans.**

*part # CHE145*

### QTL Lube - 9 oz.



- » Heavy-duty, wet lubricant technology.
- » A blend of Teflon® dispersed into quality lubricating fluids and additives.
- » Penetrates corroded areas to clean and dissolve rust, grease and dirt.
- » Excellent choice for electrical applications.
- » **Case contains 12 cans.**

*part # CHE180*

### White Lithium Lube - 11 oz.



- » Inhibits corrosion on unpainted metal.
- » Excellent for metal-to-metal applications.
- » Will not drip or run on vertical surfaces.
- » Use on chains, gears, drives, hinges and other vertical or overhead surfaces.
- » **Case contains 12 cans.**

*part # CHE150*

### T.F.E. Dry Lube - 10 oz.



- » Dry, non-oily, non-staining lubricant.
- » Ideal where low speeds and light loads are involved.
- » Dries quickly to a white, chemically inert film.
- » Excellent for use in textile industries.
- » **Case contains 12 cans.**

*part # CHE185*

### Moly Chain & Pin Bushing Lube - 11 oz.



- » Reduces wear, increases chain life up to three times when applied regularly.
- » Use on chain drives and pins, forklifts, trucks, tractors, machinery, work stand conveyors, motorcycle and bicycle chains, sprockets, clippers, rollers, cutter bars and chain saws.
- » **Case contains 12 cans.**

*part # CHE215*

### Dry Graphite Lube - 10 oz.



- » Ideal where a dry lubricant is required or where petroleum products must be avoided.
- » Pre-assembly lubrication of moving parts, mechanisms of vending machines and parking meters, automotive and industrial gaskets, hinges, locks, springs, and bearings.
- » **Case contains 12 cans.**

*part # CHE187*

### Open Gear & Wire Rope Lube - 12 oz.



- » Penetrates to core of wire rope, minimizing internal friction.
- » Displaces water to provide rust protection.
- » Black color aids in determining coverage.
- » Won't wash, weather away or rub off.
- » **Case contains 12 cans.**

*part # CHE210*

### Blaster Air Tool Conditioner - 12 oz.



- » Restores and prolongs air tool life by cleaning, coating and lubricating while tools are in use.
- » Instantly removes built-up calcium, varnish, sludge, and water.
- » Inhibits rust and increases RPSs.
- » **Case contains 12 cans.**

*part # CHE189*

### \*\*\* CASE QUANTITIES \*\*\*

— To Order By The Case Add “CS” To The Part Number (ie: CHE105CS)—

# CHEMICALS

## LUBRICANTS

### Dielectric Tune-Up Grease



- » Good for use with Industrial, marine and automotive electrical connections, spark plug boots, trailer hitches, battery terminals.
- » Protects electrical connections and wiring from salt, dirt and corrosion.
- » Prevents voltage leakage around any electrical connection.
- » **Case of 3 oz. Tune-Up Grease contains 6 tubes.**

3 oz. *part # CHE173*

### Grease Gun Cartridges



- » Long lasting, hard working formula delivers high performance in wide range of heavy-duty applications.
- » Recommended for chassis universal joints and other general purpose applications around the home, farm or shop.
- » **3 oz. cartridges come 3 per pack.**
- » **Case of 14 oz. cartridges contains 10 tubes.**
- » **Case of 3 oz. cartridges contains 12 packs of 3 tubes.**

14 oz. *part # CHE175*

3 oz. *part # CHE176*

### 3-In-1 Household Oil - 3 oz.



- » A high-quality, multi-purpose oil that can be used anywhere a light lubricant is needed.
- » Lubricates, cleans and polishes.
- » Prevents rust and tarnish.
- » **Case contains 24 cans.**

*part # CHE178*

### Anti-Seize Lubricant - 11.25 oz. Aerosol



- » Designed to lubricate and protect metal parts under the most demanding conditions of heat, cold, pressure, steam and salt water exposure.
- » Protective film will not harden, separate or evaporate or be burned off.
- » **Case contains 12 cans.**

*part # CHE364*

### Anti-Seize Lubricant - 8 oz. Brush Top



- » Heavy duty blend of aluminum, copper and graphite lubricants in a petroleum base.
- » Prevents galling, corrosion or seizing & assures easy disassembly.
- » Inert, will not evaporate or harden in extreme temperatures.
- » **Case contains 12 bottles.**

*part # CHE365*

### Copper Anti-Seize Lubricant - 8 oz.



- » Premium quality copper anti-seize and thread lubricant that may be used to prevent seizing, corrosion and galling where high temperature conditions exist.
- » Provides good electrical conductivity.
- » **Case contains 12 bottles.**

*part # CHE366*

### Cutting Oil - 12 oz.



- » Extends tool life, reducing tool sharpening.
- » Clings to surface.
- » Jet-spray allows precision applications.
- » Includes extra actuator with extension tube.
- » **Case contains 12 cans.**

*part # CHE230*

### Brute Lube Cutting Fluid

- » Multi-purpose cutting and tapping fluid specially formulated to extend tool life and reduce chip welding.
- » Complies with OSHA regulations.
- » Especially effective on stainless steel, aluminum, and exotic alloys.
- » Formulated to cling to your tools for a continuous shield against friction and heat, thus reducing tool costs and work piece scrap.
- » **Case of 4 oz. contains 12 bottles.**
- » **Case of 16 oz. contains 12 bottles.**
- » **Case of 1 gallon contains 4 bottles.**



4 oz. *part # CHE225*

16 oz. *part # CHE220*

1 gallon *part # CHE227*

### \*\*\* CASE QUANTITIES \*\*\*

— To Order By The Case Add "CS" To The Part Number (ie: CHE105CS) —

# CHEMICALS

## ADHESIVES

### Super Glue - .07 oz.



- » This formula was specially designed for faster, long-lasting bonds.
- » They are easily applied and work on nonporous materials.
- » Suggested applications: Metal, plastics, rubber, vinyl, paper, wood, and textiles.
- » **Case contains 12 tubes.**

part # CHE310

### Fast Cure Epoxy - 1.2 oz.



- » No mess, no guess, no waste.
- » Ideal for bonding glass, hard plastics, rubber and metal.
- » Bonds in 5-15 minutes.
- » Fills porosities and can be used to build up worn parts.
- » **Case contains 10 cans.**

part # CHE320

### Super Glue Gel - .07 oz.



- » No-run, gel formula "stays put" for precise application, even on vertical surfaces.
- » Ideal for overhead or hard-to-reach surfaces and is easily applied and works on both porous and nonporous materials.
- » Fixtures in less than 75 seconds.
- » **Case contains 12 tubes.**

part # CHE311

### 5 Minute General Purpose Epoxy



- » Versatile, easy-to-use, multi-purpose epoxy adhesive for metals, fabric, fiberglass, glass, rubber, concrete and most plastics.
- » Dual dispensing syringes and tubes are a two-part adhesive and filler system that eliminates the need for welding or brazing.
- » **Case contains 24 tubes.**

part # CHE322

### Rear View Mirror Adhesive



- » Permanently remounts mirrors to windshields.
- » Achieves handling strength in seconds; mirror-mounting strength in 15 minutes.
- » Approved and used by GM, Ford and Chrysler.
- » ODC-free.
- » **Case contains 12 tubes.**

part # CHE330

### JB Weld



- » Cold weld compound that sets in 4-6 hrs.
- » Indispensable for mechanics, farmers, homemakers.
- » Use on iron, steel, aluminum, brass, bronze, and copper.
- » Package contains pair of 1 oz. tubes.
- » **Case contains 6 packs.**

part # CHE325

### O-Ring and Rubber Bond Adhesive - 1/3 oz.



- » This fast curing (30 second fixture) single component ethyl cyanoacrylate is designed specifically to bond O-rings along with other rubber and plastic substrates.
- » **Case contains 6 bottles.**

part # CHE313

### JB Kwik



- » Cold Weld Compound.
- » A lightning Kwik bond with strength.
- » Bonds in 4 minutes.
- » Package contains pair of 1 oz. tubes.
- » **Case contains 6 packs.**

part # CHE327

\*\*\* CASE QUANTITIES \*\*\*

— To Order By The Case Add "CS" To The Part Number (ie: CHE105CS) —

# CHEMICALS

## ADHESIVES & THREAD RETAINERS

### Epoxy Stick - 2 oz.

- » Cures rock hard with no shrinkage.
- » Safe on potable water systems.
- » Withstands temperatures up to 250°F.
- » Hardens in 5-10 minutes, full cure in 24 hrs.
- » After 1 hour can be drilled, tapped, filed, sawed, sanded and painted.
- » Can be applied under water.
- » **Case contains 12 sticks.**



part # CHE335

### Fast Tack Adhesive - 16.5 oz.



- » Strong, versatile adhesive.
- » Water resistant.
- » Low soak-in.
- » Permanent or temporary bonds.
- » Fast, aggressive bond.
- » **Case contains 12 cans.**

part # CHE307

### Black Super Weatherstrip Adhesive - 5 fl. oz.



- » A professional, black weatherstrip adhesive that blends with black weather stripping for less clean-up.
- » A superior adhesive for bonding foam, cut gaskets, vinyl, carpeting, and moldings.
- » **Case contains 12 tubes.**

part # CHE308

### Super Weatherstrip Adhesive - 5 oz.



- » A translucent cement and sealer for door and windshield weather stripping.
- » Dries to a tough, strong bond in minutes.
- » **Case contains 12 tubes.**

part # CHE309



### High Strength Red Threadlocker

- » High strength threadlocker for heavy-duty applications including: frame brackets, hydraulic press studs, frame bolts.
- » Especially well suited for permanently locking studs.
- » Locks against loosening due to vibration.
- » Requires extra effort or special tools for removal.
- » **Case contains 6 bottles.**

10 ml. part # CHE340

50 ml. part # CHE345



### Medium Strength Blue Threadlocker

- » All-purpose, medium strength threadlocker ideal for all nut and bolt applications 1/4" to 1" (6mm to 25mm) including: machine tools, presses, pumps, compressors, mounting bolts, and gearboxes.
- » Locks and seals while preventing parts from loosening due to vibration and corrosion.
- » **Case contains 6 bottles.**

10 ml. part # CHE350

50 ml. part # CHE355



### Bearing Mount For Close Fits

- » A low viscosity, rapid-curing anaerobic adhesive that augments the strength of press fit assemblies or slip fit assemblies up to .005" in diameter, including locks, keys and splines.
- » Adds up to 3,000 PSI holding power.
- » **Case contains 6 bottles.**

10 ml. part # CHE360

50 ml. part # CHE361

\*\*\* CASE QUANTITIES \*\*\*

— To Order By The Case Add "CS" To The Part Number (ie: CHE105CS)—



# CHEMICALS

## THREAD SEALERS AND REPAIR

### Surface Prep Activator For Threadlockers - 4.5 oz.



- » Speeds cure of threadlockers by 50%.
- » Recommended for use with threadlockers, thread sealants, retaining compounds and anaerobic gasket makers during cold weather.
- » **Case contains 6 cans.**

part # CHE338

### Thread Sealant with Teflon® - 4 oz.



- » Economical general-purpose fitting sealant that outperforms tapes and pipe dopes.
- » Seals and resists pressure in air, oil, diesel fuel and hydraulic systems.
- » Remains pliable at high and low temperatures.
- » **Case contains 12 cans.**

part # CHE373



### High Performance Thread Sealant

- » Formulated specifically for metal tapered pipe thread fittings, including: stainless steel fittings, bolts into through holes, manifolds, fill plugs, fuel fittings.
- » Cures rapidly to withstand 10,000 PSI.
- » Prevents galling and protects mated threaded areas from rust and corrosion.
- » **Case of 50 ml. Thread Sealant contains 6 tubes.**
- » **Case of 250 ml. Thread Sealant contains 2 tubes.**

50 ml. part # CHE370  
250 ml. part # CHE371

\*\*\* CASE QUANTITIES \*\*\*

— To Order By The Case Add “CS” To The Part Number (ie: CHE105CS)—

# CHEMICALS

## SILICONE SEALANTS & GASKETING



### Silicone Sealant

- » Provides a watertight seal for interior and exterior projects.
- » Flexible; will not crack, crumble, or shrink.
- » Resists moisture and mildew.
- » **Case of 10 oz. clear/white contains 12 tubes.**
- » **Case of 2.8 fl. oz. clear/white contains 12 tubes.**

10 oz. clear part # **CHE271**  
 10 oz. white part # **CHE272**  
 2.8 fl. oz. clear part # **CHE273**  
 2.8 fl. oz. white part # **CHE274**



### Sensor-Safe Blue RTV Silicone Gasket Maker

- » Makes reliable "formed-in-place" gaskets that resist shrinking, cracking and migrating.
- » Product cures to a strong, flexible rubber that seals flanges against leakage and resists oil and other shop fluids.
- » Coats pre-cut gaskets to increase reliability.
- » **Case of 3 oz. contains 12 tubes.**
- » **Case of 7.25 oz. Aerosol contains 6 tubes.**

3 oz. part # **CHE275**  
 7.25 oz. part # **CHE276**

### Caulking Guns

- » Piston rod with double friction plate.
- » Long trigger leverage.
- » Thumb pressure release.

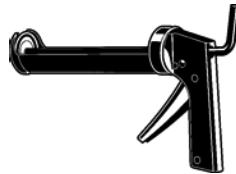

part # **BNT-500**

### Clear RTV Silicone Adhesive Sealant

- » General-purpose, clear RTV indoor/outdoor sealant.
- » Seals, bonds, repairs, mends and secures glass, metal, plastics, fabric, vinyl, weather stripping and vinyl tops.
- » May be applied to horizontal or vertical surfaces.
- » Waterproof and flexible; resists oil, water, weather, vibration, grease.
- » Use where resistance to extreme thermal cycling, ozone and UV light is required.
- » **Case of 3 oz. contains 12 tubes.**
- » **Case of 7.25 oz. Aerosol contains 6 tubes.**



3 oz. part # **CHE285**  
 7.25 oz. part # **CHE286**



### Ultra Blue® RTV Silicone Gasket Maker

- » Fills gaps up to 0.25" when fully cured.
- » Outstanding oil resistance and joint movement values.
- » Eight times more flexible than cork/composite gaskets.
- » Three times more oil resistant than conventional silicone.
- » For Pump housings, machine tools, compressors, gearboxes, valve covers, oil pans, transmission pans.
- » **Case of 3 oz. contains 12 tubes.**
- » **Case of 7.25 oz. Aerosol contains 6 tubes.**

3 oz. part # **CHE295**  
 7.25 oz. part # **CHE296**

**\*\*\* CASE QUANTITIES \*\*\***

— To Order By The Case Add "CS" To The Part Number (ie: CHE105CS) —

# CHEMICALS

## SILICONE GASKETING



### High-Temp Red Silicone Gasket Maker

- » Formulated for hi-temp applications, or heavy-duty use.
- » Replaces almost any cut gasket by making reliable “formed-in-place” gaskets that resist cracking, shrinking and migrating caused by thermal cycling.
- » Fills gaps to 0.25” when fully cured.
- » **Case of 3 oz. contains 12 tubes**
- » **Case of 7.25 oz. Aerosol contains 12 cans.**
- » **Case of 11 oz. contains 12 cartridges.**

3 oz. **part # CHE280**  
 7.25 oz. **part # CHE281**  
 11 oz. **part # CHE282**

### Sensor-Safe High-Temp Orange RTV Silicone Gasket Maker - 3 oz.



- » This enhanced version of the High-Temp Red creates strong, flexible rubber gaskets that resist cracking, shrinking and migrating caused by thermal cycling.
- » Formulated for low volatility and sensor applications.
- » **Case contains 12 tubes.**

**part # CHE278**

### Ultra Copper® Gasket Maker - 3 oz.



- » Premium silicone that can withstand operating environments to 700°F (371°C).
- » Superior adhesion with three times more oil resistance than conventional silicones; eight times more flexible than cut gaskets.
- » Fills gaps to .25” when fully cured.
- » **Case contains 12 tubes.**

**part # CHE300**

### Ultra Grey® Gasket Maker - 3.5 oz.



- » Designed for high torque applications requiring a unique RTV gasket.
- » Fills gaps of up to 0.25” when fully cured.
- » Low odor, noncorrosive.
- » Outstanding oil and coolant resistance.
- » **Case contains 12 tubes.**

**part # CHE288**



### Ultra Black® Gasket Maker

- » Fast-curing formula; low odor, noncorrosive.
- » Fills gaps of up to 0.25” when fully cured.
- » Retains high flexibility, oil resistance properties.
- » Use on pump housings, machine tools, compressors, gearboxes, valve covers, oil pans, transmission pans.
- » **Case of 3.35 oz. contains 12 tubes**
- » **Case of 8.75 oz. Aerosol contains 6 cans.**
- » **Case of 13 oz. contains 12 cartridges.**

3.35 oz. **part # CHE290**  
 8.75 oz. **part # CHE291**  
 13 oz. **part # CHE292**

### Right Stuff® Gasket Maker - 7 oz. Aerosol



- » Heavy-bodied, black, elastomeric rubber provides instant seal.
- » Superior flexibility and adhesion accommodates joint movement.
- » Excellent oil and transmission fluid resistance.
- » Noncorrosive and low volatility.
- » **Case contains 6 cans.**

**part # CHE293**

### \*\*\* CASE QUANTITIES \*\*\*

— To Order By The Case Add “CS” To The Part Number (ie: CHE105CS) —

# CHEMICALS

## GASKETING & TIRE ACCESSORIES

### High Tack™ Spray-A-Gasket® - 9 oz.



- » Red colored, all-purpose sealant that holds even the heaviest of gaskets in place during assembly.
- » Seals and bonds rubber, cork, paper, felt, metal, and asbestos gaskets.
- » Sets quickly to a very tacky film.
- » **Case contains 12 cans.**

*part # CHE305*

### String Plugs - 60 per box

- » 4" brown tire patches
- » 100% self vulcanizing into the rubber of the tire for a permanent seal.



*part # CHE420*

### Form-A-Gasket® No. 2 Sealant - 3 oz.



- » Reliable paste-like gasket sealant/dressing/coating.
- » Coating cut gaskets to improve sealing and hold in place.
- » Sets slowly to a pliable film best suited for non-rigid, vibrating assemblies.
- » **Case contains 12 tubes.**

*part # CHE302*

### Tire Sealer and Inflator - 12 oz.



- » Premium Tire Inflator.
- » Seals and inflates tube and tubeless tires in seconds.
- » For use on cars, bicycles, vans and tractors.
- » Heavy-duty formula will seal most punctures.
- » **Case contains 12 cans.**

*part # CHE427*



### Gasket Remover - 12 oz.

- » Removes gaskets from any type of assembly, including baked on gaskets and sealants, weatherstrip adhesive, dried oil, grease and paint, in 10 to 12 minutes.
- » Prepares metal parts for new gasket maker and assembly.
- » Reduces scraping and sanding of baked on gaskets.
- » Prevents damage to flanges.
- » **Case contains 12 cans.**

*part # CHE304*



### Bead Sealer - 1 quart

- » Bead Sealer is a thick, high-solid content, black sealant.
- » Forms an airtight seal between the tire and rim,
- » reducing bead leaks.
- » Brush on the beads of tubeless tires during mounting. Quick, economical and profitable way to end comebacks from bead leaks.
- » **Case contains 6 cans.**

*part # CHE425*

**\*\*\* CASE QUANTITIES \*\*\***

— To Order By The Case Add "CS" To The Part Number (ie: CHE105CS) —

# CHEMICALS

## WINTER CHEMICALS

### Isopropyl System Fuel Dryer & Anti-freeze - 12 oz.



- » Removes moisture from the fuel tank, preventing freezing and icing of gas lines and carburetors.
- » Safe for gasoline and diesel fuel systems.
- » Keeps the fuel system clean.
- » **Case contains 12 bottles.**

part # CHE240

### Starting Fluid - 11 oz.



- » Starts engines fast in any weather, even down to -65 F°.
- » Special formulation contains upper engine lubricant.
- » Use in cars, trucks, tractors, motorcycles, marine and construction equipment.
- » **Case contains 12 cans.**

part # CHE235

### Gas Line Anti-freeze & Fuel Dryer - 12 oz.



- » Keeps gas lines from freezing and carburetors from icing by absorbing water in the fuel system.
- » Prevents stalling and aids starting in cold weather.
- » **Case contains 24 bottles.**

part # CHE245

### Windshield Washer Anti-freeze Concentrate - 16 oz.



- » Concentrated solution designed to protect windshield washer systems from freezing.
- » Works at temperatures as low as -20 F°.
- » Removes road film, dirt, grime and bugs.
- » Works in all types of washers.
- » **Case contains 24 bottles.**

part # CHE250

### Siloo Diesel Fuel Conditioner - 12 oz.



- » Formulated to improve performance without the use of harmful alcohols or sulfur.
- » Cleans fuel tank lines and filters.
- » Dissolves gum and varnish.
- » Eliminates excessive smoking.
- » Retards or eliminates rust and corrosion.
- » **Case contains 12 bottles.**

part # CHE247

### Windshield De-icer - 11.5 oz.



- » Quickly melts ice on windshields and thaws frozen locks and doors.
- » Sprays at sub-zero temperatures.
- » Harmless to auto finishes.
- » Also removes ice and frost from headlights for brighter and safer driving.
- » **Case contains 12 cans.**

part # CHE255

### Siloo Diesel Fuel Antigel - 12 oz.



- » Formulated for cold weather use in all diesel equipment.
- » Assures superior performance in winter without harmful alcohol or sulphur.
- » Lowers fuel pourpoint.
- » Retards gelling or waxing during cold weather.
- » Disperses water and cleans injectors.
- » **Case contains 12 bottles.**

part # CHE248

### Spray Bottle - 24 oz.



- » Round translucent bottle.
- » Adjustable trigger.
- » Ideal for cleaners and insecticides.
- » **Case contains 12 bottles.**

part # CHE430

\*\*\* CASE QUANTITIES \*\*\*

— To Order By The Case Add "CS" To The Part Number (ie: CHE105CS) —

# CHEMICALS

## MISCELLANEOUS



### Battery Protectant - 6 oz.

- » Seals battery terminals with a long lasting protective film.
- » Eliminates corrosion and extends battery life.

Case contains 12 cans. *part # CHE135*



### Belt Dressing - 6 oz.

- » Extends life of "V" belts.
- » Penetrates to eliminate squealing and restores flexibility.
- » Case contains 12 cans.

*part # CHE130*



### Undercoater - 15.5 oz.

- » Specially formulated to cover interior and exterior surfaces, as well as being able to withstand elements faced by the undercarriage of vehicles.
- » Case contains 6 cans.

*part # CHE265*



### Fill and Seal Foam - 12 oz.

- » Expanding urethane foam designed to fill large areas or gaps that require a complete airtight and waterproof seal.
- » The foam expands approximately 3 times its original volume, is tack-free in approximately 45 minutes and fully cured in 12 hours.
- » Case contains 12 cans.

*part # CHE267*



### Liquid Electrical Tape - 4 oz.

- » Forms a protective, waterproof, UV resistant dielectric coating.
- » Prevents corrosion on wires and terminals.
- » Patented UL tested fast drying formula.
- » Case contains 12 cans.

*part # CHE432*



### Radiator Stop Leak - 20 grams

- » Cooling system sealer.
- » Water pump lubricant.
- » Rust inhibitor.
- » Case contains 24 tubes.

*part # CHE434*

### Screw Grab - 3 oz.



- » ScrewGrab is a very efficient silicon paste, full of diamond-shaped particles, which when applied to the head of a fastener or tool improves the potential torque by increasing the friction between the tool and the fastener.

- » Unlimited shelf-life.

» Case contains 12 bottles. *part # CHE436*

### Blue Layout Fluid - 12 oz.



- » Adheres to metal or glass including pattern-making, tool and die making, machining, maintenance mechanical.

- » Fast-drying, non-flaking, non-etching, won't peel.

- » Heat resistant.

- » Non-corrosive.

» Case contains 12 cans. *part # CHE270*

### Blast 'Em™ Wasp & Hornet Killer - 12 oz.



- » Contains a high amount of petroleum distillates for the best knockdown and kill rate of wasps, hornets, yellow jackets, flies, mosquitos and flying moths.

- » Residual deposit will kill returning wasps and hornets.

- » 98% knockdown, 100% kill within 24 hours.

- » Will not harm most plastics, including Noryl, ABS and Lexan.

- » Ideal on utility meters and boxes; nesting areas in eaves and shrubs; porch lighting fixtures;

» Case contains 12 cans.

*part # CHE260*



### Propane Fuel Cylinder - 14.1 oz.

- » Use with torches and most portable appliances requiring propane fuel.

» Case contains 12 cylinders.

*part # CHE440*

\*\*\* CASE QUANTITIES \*\*\*

— To Order By The Case Add "CS" To The Part Number (ie: CHE105CS)—

# CHEMICALS

## PAINT



### Krylon 5-Ball Primer - 12 oz.

- » Meets manufacturers' specifications for farm, vehicle, maintenance, lawn and garden equipment.
- » Fast drying.
- » **Case contains 6 cans.**

Color	Part #	Qty
K01314 - Platinum	CHE590	1 can
K01315 - White	CHE591	1 can
K01316 - Black	CHE592	1 can
K01317 - Ruddy Brown	CHE593	1 can
K01318 - Gray	CHE594	1 can

### Krylon 5-Ball Enamel Paint - 12 oz.



- » Superior performance, both indoors and outdoors.
- » Hard, protective, durable finish.
- » High amount of solids assures maximum uniform coverage with excellent adhesion.
- » Dries fast; in just 12 minutes to the touch.
- » Use on any metal or wood surface.
- » **Case contains 6 cans.**

Color	Part #	Qty
K01301 - Clear Acrylic	CHE625	1 can
K01310 - Dulling Spray	CHE626	1 can
K01501 - Glossy White	CHE500	1 can
K01502 - Flat White	CHE501	1 can
K01506 - Almond	CHE504	1 can
K01601 - Glossy Black	CHE507	1 can
K01602 - Ultra-Flat Black	CHE508	1 can
K01605 - Stone Gray	CHE510	1 can
K01606 - Pewter Gray	CHE511	1 can
K01608 - Smoke Gray	CHE513	1 can
K01613 - Semi-Flat Black	CHE514	1 can
K01901 - Regal Blue	CHE517	1 can
K02001 - Hunter Green	CHE525	1 can
K02101 - Cherry Red	CHE529	1 can

### Krylon OSHA & Fluorescent Paint - 12 oz.



- » High visibility cautions for helping workers' safety.
- » OSHA colors approved by the Occupational Safety and Health Act Governing Board.
- » Fluorescent increases brilliance by 200% to 400%.
- » **Case contains 6 cans.**

Color	Part #	Qty
K01813 - OSHA Safety Yellow	CHE560	1 can
K02012 - OSHA Safety Green	CHE562	1 can
K03101 - Fluores Red/Orange	CHE620	1 can



### Krylon Metallic Paint- 11 oz.

- » **Case contains 6 cans.**

Color	Part #	Qty
K01401 - Bright Silver	CHE580	1 can
K01403 - Dull Aluminum	CHE581	1 can

### Krylon Farm & Implement Paint - 12 oz.



- » Meets manufacturers' specifications for farm vehicle, maintenance, lawn and garden equipment.
- » High-gloss, durable finish.
- » Fast drying.
- » **Case contains 6 cans.**

Color	Part #	Qty
K01809 - School Bus Yellow	CHE571	1 can
K01816 - John Deere Yellow	CHE572	1 can
K01819 - Old Caterpillar Yellow	CHE575	1 can

### \*\*\* CASE QUANTITIES \*\*\*

— To Order By The Case Add "CS" To The Part Number (ie: CHE105CS) —

# CHEMICALS

## PAINT



### Krylon Engine Paints - 11 oz.

- » Fast-drying, high performance acrylic enamels.
- » Withstands temperatures up to 500°F.
- » Exact matches to OEM standards.
- » Won't blister, flake, crack or peel.
- » Oil and gas resistant.
- » **Case contains 6 cans.**

Color	Part #	Qty
K01612 - Universal Black	CHE601	1 can
K01908 - Chevrolet Blue	CHE603	1 can
K01927 - Ford Blue	CHE605	1 can
K01930 - G.M. Blue	CHE607	1 can
K02013 - G.M. Alpine Green	CHE609	1 can
K02405 - Chevrolet Orange	CHE613	1 can



### Krylon High Heat & Radiator Paint - 12 oz.

- » Withstands temperatures up to 1000°F.
- » Protects against rust; dries in minutes.
- » **Case contains 6 cans.**

Color	Part #	Qty
K01402 - Aluminum	CHE615	1 can
K01614 - Black	CHE618	1 can



### Krylon Rust Tough Aerosol Primer - 15 oz.

- » Better corrosion protection than other industrial rust-preventative spray primers.
- » Fast-drying, topcoat any time—no waiting.
- » Superior adhesion—use on rusted, bare or previously painted metal.
- » **Case contains 6 cans.**

Color	Part #	Qty
R00699 - Red Oxide	CHE677	1 can
R00829 - Gray	CHE678	1 can



### Krylon Rust Tough Aerosol Paint- 15 oz.

- » The ultimate spray paint for metal.
- » Better gloss retention, coverage and dry time than other industrial rest-preventive spray paints.
- » Maximum corrosion protection.
- » Superior resistance to chipping, cracking and peeling.
- » Higher paint solids.
- » Indoor/outdoor.
- » **Case contains 6 cans.**

Color	Part #	Qty
R00249 - Safety Blue (OSHA)	CHE652	1 can
R00439 - Safety Yellow (OSHA)	CHE657	1 can
R00639 - Safety Red (OSHA)	CHE663	1 can
R00779 - Semi-Gloss Black	CHE668	1 can
R00879 - Dark Machinery Gray	CHE672	1 can
R00929 - Gloss White	CHE675	1 can



### Sprayon Zinc-Rich Cold Galvanizing Compound - 14 oz.

- » Fast-drying, high-solids, high performance, epoxy-based coating provides maximum protection to steel exposed to severe corrosive environments.
- » **Case contains 12 cans.**

Part #	Qty
CHE679	1 can



### Snap & Spray™

- » Quickly transforms any spray can into a spray gun.
- » Snaps onto any spray can.
- » Eliminates finger fatigue.

Part #	Qty
CHE740	1

### \*\*\* CASE QUANTITIES \*\*\*

— To Order By The Case Add "CS" To The Part Number (ie: CHE105CS)—



# CHEMICALS

## PAINT



### Krylon® Industrial Quik-Mark™ Inverted Marking Paint - 17 oz.

- » Precision line spray tip for easy-to-read, bright, vivid markings.
- » Dries in less than 5 minutes.
- » Easy-to-use, spray-through cap guaranteed not to clog.
- » Can be applied down to 25°F (-4°C).
- » **Case contains 12 cans.**

Color	Part #	Qty
S03500 - Clear	CHE700	1 can
S03621 - Blue	CHE711	1 can
S03821 - High Visibility Yellow	CHE715	1 can
S03900 - Utility White	CHE717	1 can
S03613 - Flour. Safety Red	CHE720	1 can
S03614 - Flour. Neon Green	CHE721	1 can
AT3701 - Flour. Red/Orange	CHE724	1 can



### Krylon® Line-Up™ Stripping Paint - 17 oz.

- » Creates crisp and clean, long-lasting lines.
- » Use on concrete, pavement, grass, gravel and more.
- » **Case contains 12 cans.**

Color	Part #	Qty
K08300 - Highway White	CHE730	1 can
K08301 - Highway Yellow	CHE731	1 can



### Spotter Hand-Held Marking Wand

- » Constructed of durable, rugged plastic.
- » Comfortable pistol grip for easy handling.
- » 12" length.

Part #	Qty
CHE741	1

### Wheeler Hand-Held Marking Wand

- » Constructed of durable, rugged plastic.
- » Comfortable pistol grip for easy handling.
- » 34" length.



Part #	Qty
CHE-742	1

### \*\*\* CASE QUANTITIES \*\*\*

— To Order By The Case Add "CS" To The Part Number (ie: CHE105CS) —



# CHEMICALS

## RubberSet® PAINT ACCESSORIES

### One Coat Latex Paint Brushes



» Better coverage & holds more paint.

- 1" trim part # **SW-11306510**
- 1-1/2" trim part # **SW-11306515**
- 2" trim part # **SW-11306520**
- 3" wall part # **SW-11306530**
- 4" wall part # **SW-11306540**
- 1-1/2" angle sash part # **SW-11306615**
- 2" angle sash part # **SW-11306620**

### Acid Brushes

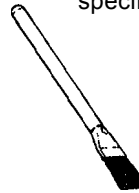

» Quality horsehair bristles.  
» Machine trimmed and crimped to specification.

- 3/8" part # **UA00501**
- 7/16" part # **UA00502**
- 9/16" part # **UA00503**

### Chip Paint Brushes - Wood Handle

» 100% natural white bristle.



- 1/2" part # **SW-99060305**
- 1" part # **SW-99060310**
- 1-1/2" part # **SW-99060315**
- 2" part # **SW-99060320**
- 3" part # **SW-99060330**
- 4" part # **SW-99060340**

### 9" Paint Roller Frame

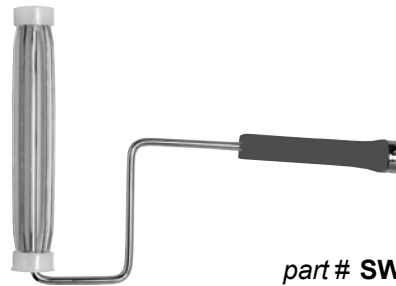

part # **SW-99076790**

### Chip Paint Brushes - Plastic Handle

» Gray, natural china bristle.



- 1" part # **SW-11101010**
- 1-1/2" part # **SW-11101015**
- 2" part # **SW-11101020**
- 3" part # **SW-11101030**
- 4" part # **SW-11101040**

### 9" One Coat Paint Roller



» For one coat results - Saves Time!  
» Better coverage and finish than ordinary rollers.  
» Reusable polypropylene plastic core.  
» For all paints.

- 1/4" part # **SW-11844090**
- 3/8" part # **SW-11844290**
- 3/4" part # **SW-11844490**

### 3 Piece Foam Paint Brush Set

» Wood handle.  
» For touch up, craft and hobby use.  
» 1", 2", & 3" brushes



part # **SW-99081603**

### Metal Paint Tray



part # **SW-11764290**



# CHEMICALS

## Rubberset® PAINT ACCESSORIES

### Plastic Paint Tray



# SW-99077399

### Trim Roller

- » For trim and small areas.
- » Reinforced cores for repeated use.



part # SW-99072434

### Paint Tray Liner



- » Sturdy tray.
- » 9" slip fit frame.
- » 9" tossaway cover.

part # SW-99355600

### Trim Roller Replacement Covers

- » For trim and small areas.
- » Reinforced cores for repeated use.  
2 per pack



part # SW-99076434

### 3 Piece Paint Roller Set



- » Sturdy tray
- » 9" slip fit frame
- » 9" tossaway cover

part # SW-99097701

### 42" 3 Piece Wood Extension Pole

- » Threaded to fit all standard roller frame handles.
- » Reuseable



part # SW-69078299

# CHEMICALS

## WRITING UTENSILS



### Carpenter's Pencil

- » Premium quality 7" pencil makes clean, accurate marks on wood and other surfaces.
- » Flat lead design for easier marking.

part # **AN-LP72**



### Yellow Lumber Crayon

- » Use on cardboard, ceramics, concrete, lumber, metal, paper, plastic, and rubber.
- » Lead-free and economical.
- » Weather-resistant, fade-resistant marks.

part # **LAC-80351**



### Quik Stik Marker

- » Smooth marking, fast drying paint marks dry in 5-7 minutes.
- » Bright, bold fade resistant colors.
- » More marks for the money, 20% longer than other brands.
- » Plastic holder with self storing cap prevents breakage, keeps hands and clothing clean.
- » Stick advances by turning twist up knob.
- » Marks on virtually any surface.
- » Metal, glass, plastic, wood, cardboard, paper, etc.

white marker part # **LAC-61051**  
 yellow marker part # **LAC-61053**  
 red marker part # **LAC-61049**  
 black marker part # **LAC-61050**



### Fine Point Black Marker

- » Extra tough tip, won't spread or mush.
- » Use on metal, cardboard, wood, paper, plastic, glass.
- » Fast-drying.
- » Smear-resistant.
- » Water-resistant.

part # **LAC-96033**



### Valve Action Paint Marker

- » Marks with real paint, dries in 3 minutes.
- » Nib releases paint as needed for continuous marking.
- » Marks on all surfaces including: metal, wood, glass, plastic, rubber, cardboard, and paper.
- » Lead-free, low halogens.
- » The fiber nib is replaceable to assure complete use of each marker.
- » Durable metal barrel.
- » Marking range: -50°F to 150°F (-46°C to 66°C).

white marker part # **LAC-96820**  
 yellow marker part # **LAC-96821**  
 red marker part # **LAC-96822**  
 black marker part # **LAC-96823**



### Dura-Ink #50 Marker

- » Water based ink dries immediately.
- » Marks on all surfaces and will not bleed.

red marker part # **LAC-96522**  
 black marker part # **LAC-96523**  
 blue marker part # **LAC-96525**

# TAPES

## ELECTRICAL TAPE

### Scotch Super 33+ Electrical Tape



- » Protects and insulates in all weather.
- » Resistant to oil, water, abrasion and chemicals.
- » Sleeve contains **10** rolls.



Part #	Qty
<b>TAPE220</b>	1 roll
<b>TAPE220SL</b>	1 sleeve

### Standard Black Electrical Tape

- » High quality 7 mil vinyl tape is excellent for electrical connections.
- » Sleeve contains **10** rolls.



Part #	Qty
<b>TAPE120</b>	1 roll
<b>TAPE120SL</b>	1 sleeve

### Highland™ Electrical Tape

- » This black, 7 mil tape is a flexible, stretchy, conformable, commercial grade vinyl, that is flame retardant.
- » Highland™ #6138 tape can be used for protective jacketing and harnessing.
- » Sleeve contains **10** rolls.



Part #	Qty
<b>TAPE225</b>	1 roll
<b>TAPE225SL</b>	1 sleeve

### Rubber Tape

- » 30 mil. semi-cured rubber.
- » Self vulcanizing—water resistant.

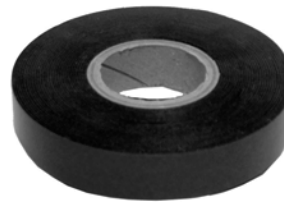

Part #	Qty
<b>TAPE240</b>	1 roll

### Standard Color Electrical Tape

- » High quality 7 mil vinyl tape is excellent for electrical connections.



Color	Part #	Qty
Red	<b>TAPE230</b>	1 roll
White	<b>TAPE231</b>	1 roll
Blue	<b>TAPE232</b>	1 roll
Green	<b>TAPE233</b>	1 roll
Gray	<b>TAPE234</b>	1 roll
Brown	<b>TAPE235</b>	1 roll
Yellow	<b>TAPE236</b>	1 roll
Orange	<b>TAPE237</b>	1 roll

### Friction Tape

- » Overwrap electrical connections — provides abrasion protection for splices and connectors.
- » Adhesive compound on both sides.



Part #	Qty
<b>TAPE245</b>	1 roll

### Liquid Electrical Tape - 4 oz.



- » Forms a protective, waterproof, UV resistant dielectric coating.
- » Prevents corrosion on wires and terminals.
- » Patented UL tested fast drying formula.

Part #	Qty
<b>CHE432</b>	1 CAN

# TAPES

## MASKING & PACKING

### Duct Tape

- » High tack, conformability, strength and easy tear make it ideal for many duct and moisture sealing, holding, protecting and bundling applications.
- » Case contains **24** rolls.



Part #	Qty
TAPE100	1 roll
TAPE100CS	1 case

### 3M Clear Packaging Tape

- » A general use packaging tape for light to medium-duty packaging applications.
- » Features strong yet conforable "Scotchpro" film backing.
- » Sleeve contains **6** rolls.



Part #	Qty
TAPE250	1 roll
TAPE250SL	1 sleeve

### Generic Masking Tape

- » Economical high quality tape for straight or lined masking.
- » Will not lift under spray pressure and won't leave adhesive residue when removed.



Size	Part #	Qty
3/4"	TAPE105	1 roll
1"	TAPE110	1 roll
1-1/2"	TAPE112	1 roll
2"	TAPE115	1 roll

### Generic Packaging Tape

- » Strong and easy to apply tape ideal for Parcel Post and U.S. Mail.
- » Sleeve contains **6** rolls.



Color	Part #	Qty
Clear	TAPE140	1 roll
Clear	TAPE140SL	1 sleeve
Tan	TAPE145	1 roll
Tan	TAPE145SL	1 sleeve

### 3M Masking Tape

- » Designed expressly for the professional auto refinish painter.
- » Conformable, hugs curves and contours.
- » Sticks at a touch and stays put.



Size	Part #	Qty
3/4"	TAPE200	1 roll
3/4"	TAPE200SL	1 sleeve
1"	TAPE205	1 roll
1"	TAPE205SL	1 sleeve
1-1/2"	TAPE210	1 roll
1-1/2"	TAPE210SL	1 sleeve
2"	TAPE215	1 roll
2"	TAPE215SL	1 sleeve

### Heavy Duty Packaging Tape Dispenser

- » Lightweight, roll-on, pistol-grip dispenser for easy center seam closure of cases.
- » Easy to load.
- » Accommodates to 1.5" and 2" tapes up to 60 yards long.

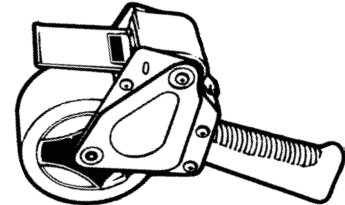

Part #	Qty
TAPE155	1

### Economy Packaging Tape Dispenser

- » Easy to use, refillable one-hand box sealing tape dispenser.
- » Adjustable braking mechanism applies tension to the tape.
- » Holds tape up to 2" wide on 3" core.

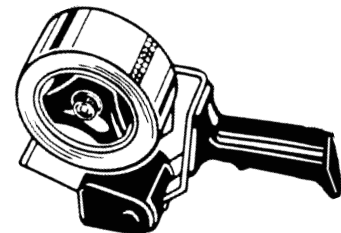

Part #	Qty
TAPE160	1

# TAPES

## MISCELLANEOUS

### Teflon Tape

- » Soft and pliable, yet tough for reliable positive sealing of pipe thread joints.
- » Has excellent cling qualities.
- » Excellent for water lines & hose bibbs.
- » 520" per roll.
- » Sleeve contains 10 rolls.



Size	Part #	Qty
1/2	TAPE125	1 roll
1/2	TAPE125SL	1 sleeve
3/4	TAPE130	1 roll
1"	TAPE135	1 roll

### 3M Double Sided Tape

- » A closed cell foam tape coated on both sides with a pressure sensitive adhesive.
- » It is designed for attaching automotive trim molding, emblems and other articles where high internal strength is required.
- » 1/2" x 20 yds.



Part #	Qty
TAPE260	1

### Filament Tape

- » Super-strong tape with fiberglass reinforcement is used for bundling and packaging where extra strength is required.
- » Will hold up under severe punishment and is resistant to oils, chemicals and corrosion.
- » 3/4" x 60 yds.



Part #	Qty
TAPE150	1

### Caution Tape

- » Highly visible yellow and black tape has the word "CAUTION" in black and is 3 inches wide.
- » Mark off important areas such as: accident sites, construction areas, sporting or other events, or any area that needs to be restricted or supervised.



Size	Part #	Qty
1000'	TAPE270	1 rolls
300'	TAPE272	1 rolls

### Danger Tape

- » Highly visible and durable red tape has the word "DANGER" in black and is 3 inches wide.
- » Mark off important areas such as: accident sites, construction areas, sporting or other events, or any area that needs to be restricted or supervised.
- » 1000' Roll



Part #	Qty
TAPE275	1





# Section 15: Safety Products

## Table of Contents

### Gloves

Jersey Knit Gloves .....	3
Lined Jersey Knit Gloves .....	3
Leather Palm Work Gloves .....	3
Lined Leather Work Gloves .....	3
Leather Driver Gloves .....	3
Lined Leather Driver Gloves .....	3
12" Rubber Gloves .....	3
Knit Wrist Rubber Gloves .....	3
Latex Gloves .....	3
Nitrile Gloves .....	3

### Safety Wear

Rainsuits .....	4
Slush Boots .....	4
Reflective Safety Vest .....	4
Back Support Belt .....	4
Hard Hats .....	4
Hard Hat Winter Liner .....	4
Knee Pads .....	4
Protective Earmuffs .....	4
Ear Plugs .....	4

### Eye and Face Masks

Industrial Faceshields .....	5
Safety Glasses & Goggles .....	5
Dust Masks .....	5
Respirators .....	5

### Miscellaneous Safety Products

First Aid Kit .....	6
Traffic Flags .....	6
Traffic Cones .....	6
Fire Extinguisher .....	6
Padlocks .....	6
Reflectors .....	6-7
Warning Triangles .....	7
Tarps .....	7
Rubber Hold Down Straps .....	7
Plastic Signs .....	8



# SAFETY PRODUCTS

## GLOVES



### Jersey Knit Gloves

- » 9 ounce, Brown Jersey, clute pattern.
- » Sleeve contains 12 pair.

*pair part #* **SPG100**  
*sleeve part #* **SPG100-12**



### Lined Jersey Gloves

- » Brown Jersey, gunn cut, red lined, slip on style.
- » Sleeve contains 12 pair.

*pair part #* **SPG105**  
*sleeve part #* **SPG105-12**



### Leather Palm Work Gloves

- » Shoulder leather.
- » 2 1/2" Rubberized safety cuff.
- » Wing thumb, full index finger, leather finger tips, elastic strap, knuckle strap and cotton lined.
- » Sleeve contains 12 pair.

*pair part #* **SPG110**  
*sleeve part #* **SPG110-12**



### Leather Lined Work Gloves

- » Rugged, select shoulder cowhide palm, canvas back.
- » ColdBlock™ poly/cotton lined for added warmth. Gunn cut.
- » Locked stitched for added strength.
- » Sleeve contains 12 pair.

*pair part #* **SPG115**  
*sleeve part #* **SPG115-12**



### Leather Driver Gloves

- » Top grain cowhide leather.
- » Gunn cuff, slip-on style and ball and tape drawstring.
- » Sleeve contains 12 pair.

*pair part #* **SPG120**  
*sleeve part #* **SPG120-12**



### Lined Leather Driver Gloves

- » Top grain cowhide leather.
- » Gunn cuff, slip-on style and ball.
- » Thermal Lining
- » Sleeve contains 12 pair.

*pair part #* **SPG125**  
*sleeve part #* **SPG125-12**



### Rubber Gloves - 12"

- » Black, 12" fully coated, smooth finish, jersey lined.
- » Sleeve contains 12 pair.

*pair part #* **SPG130**  
*sleeve part #* **SPG130-12**



### Rubber Gloves - Knit Wrist

- » Black, knit wrist, fully coated, smooth finish, interlock lined.
- » Sleeve contains 12 pair.

*pair part #* **SPG135**  
*sleeve part #* **SPG135-12**



### Latex Gloves

- » **Lightly Powdered** or **Powder-free**, medical grade, 5mil, latex.
- » Box of 100 gloves.

*powdered box part #* **SPG140**  
*powder-free box part #* **SPG145**



### Nitrile Gloves

- » Superior chemical resistance.
- » Lightly powdered/textured fingers.
- » Box of 100 gloves.

*Large box part #* **SPG150**  
*X-Large box part #* **SPG155**

# SAFETY PRODUCTS

## SAFETY WEAR



### Rainsuits - M, L, XL, XXL, XXXL

- » Full .35mm heavy-weight PVC on 100% waterproof polyester material.
- » Resists oils, acids, industrial compounds.
- » Extra strong electronically sealed seams.
- » Non corrosive, non conductive, rust proof and spark proof snaps.
- » Detachable hood with drawstring and snapped fly on bib overalls.
- » **Specify size when ordering (ie: SPO100XL)**

part # SPO100

### Hard Hats

- » Four-point Dihedral® or Sure-Lock® suspensions offers comfort, variable sizing and a snug fit.
- » Equipped with accessory slots for attachments including welding helmets, earmuffs and faceshields.



white hat part # SPO115W

yellow hat part # SPO115Y

orange hat part # SPO115O

### 17" Rubber Slush Boot

- » 17" rubber legging overshoe boot.
- » Full cut for easy fit.
- » Fully lined with extra wide elastic adjustable strap with buckle on top.
- » Heavy cleated sole.
- » Sizes: 10, 11, 12, 13, 14, 15, 16.
- » Order 2 sizes larger than your shoe size.
- » **Specify size when ordering.**



part # SPO105

### Quilted Hard Hat Winter Liners

- » Gives protection from the wind and cold to workers who have to wear hard hats.
- » Adjustable chin strap and head straps.
- » All liners available with Velcro fastener.



part # SPO120

### Reflective Safety Vest

- » 18" in width and 48" long safety vest made of 100% nylon mesh.
- » Available in orange or green with silver retro-reflective stripes front and back.
- » Velcro® front closure with side ties.
- » Cool, comfortable, lightweight and durable.
- » One size fits all.



part # SPO110O

part # SPO110G

### Stitched Swivel Knee Pads

- » Last five times longer than comparable knee pads.
- » Thick foam center padding;
- » Grooved cap prevents thread abrasion.
- » Double elastic straps.



part # SPO126

### Protective Earmuffs

- » Made of tough, lightweight, non conductive plastic,
- » Features soft, foam filled earcups that fit comfortably around ears. Universal-fit headband easily adjusts to fit all head size.



part # SPO128



### Back Belts

- » 8" wide light weight mesh back panel is designed to provide maximum abdominal and lower back muscle support.
- » Tapered front panel has Velcro® closure.
- » Small - 24" - 34" waist.
- » Medium - 32" - 42" waist.
- » Large - 42" - 52" waist.
- » X-Large - 52" - 62" waist.
- » **Specify size when ordering (ie: SPO125XL)**

part # SPO125

### Foam Ear Plugs

- » Non-allergenic ear plugs to conform to the size and shape of virtually any ear canal.



1 pair part # SPO130

box of 200 pair part # SPO130-200

3 pair w/ plastic case part # SPO132

# SAFETY PRODUCTS

## EYE AND FACE PROTECTION

### Industrial Faceshields

- » Protects against chemical splash and flying particles.
- » Large 9" x 14-1/2" windows are made of tough polycarbonate and provide heat resistance.
- » Innovative window attachment system eliminates metal snaps or bands-windows.



part # **SPO200**

replacement window part # **SPO202**

### Dust Masks

- » Disposable masks for protection against a wide range of non-toxic nuisance dusts and mists.
- » Adjustable metal nosepiece with soft, non-woven material.

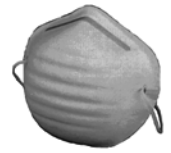

1 pack of 5 masks part # **SPO134**

1 box of 50 masks part # **SPO135**

### Safety Glasses

- » Popular and economical licorice framed glasses.
- » Complies with OSHA requirements.
- » Built-in frontal brow and side protection provide superior safety for your eyes.
- » Both clear and gray lenses provide 99.9% UV protection.



clear lens part # **SPO205**

gray lens part # **SPO210**

### Protective Eye Guards

- » Polycarbonate construction provides superior impact protection and is has 99.9% UV protection.
- » Large lens size and overlapping sideshields provide excellent wraparound coverage.
- » Complies with OSHA requirements.



part # **SPO215**

### Conventional Style Impact Goggles

- » Economical, comfortable protection.
- » Adjustable head-bands and tight fitting facial seal.
- » Fits comfortably over most glasses.
- » Direct vent system for reduced lens fogging.
- » Soft, flexible vinyl frame is lightweight.
- » Complies with OSHA requirements.



part # **SPO220**

### Professional Quality Respirator

- » Protects against organic vapors and sprays associated with paint and pesticide spraying, dusts, mists, fumes (lead and welding fumes), and asbestos-containing dusts and mists.
- » A special design allows this HEPA (High Efficiency Particulate Air) Filter Cartridge Respirator to be a lightweight and compact unit.
- » 99.97% efficient against a particle size of .3 microns.
- » NIOSH Approval No. TC-23C-413.
- » Replacement high efficiency paint/pesticide/asbestos cartridge/filters come in packs of 2.



part # **SPO225**

replacement cartridge/filter part # **SPO230**

### Economy Respirator

- » Ideal for both the professional and Do-It-Yourself.
- » Packaged in convenient polybag with header card.
- » NIOSH Approval No. TC-23C-1229.
- » Replacement organic vapor cartridges (AOS-95111) come in packs of 2.
- » Replacement paint spray prefilters (AOS-95112) come in packs of 2.



respirator part # **SPO235**

organic cartridge part # **SPO240**

paint spray prefilter part # **SPO245**

# SAFETY PRODUCTS

## MISCELLANEOUS

### First Aid Kit

- » 25 person First Aid Kit.
- » Contents: bandages, tape, antiseptic towelettes, first aid cream, aspirin, scissors, tweezers, iodine, gauze pads, cotton balls, first aid charts, rubbing alcohol, ammonia inhalents, sterile eye wash.



OSHA Approved  
Yellow  
Metal Case - Fire Rated

part # **SPO140**



### Fire Extinguisher

- » 5Lbs. with a gauge and hose.
- » Dry chemical DOT and USCG approved when used with the included metal bracket.
- » UL rating is 3A40B:C.

part # **SPO145**

### Padlocks & Hasps

- » Corrosion-resistant.
- » Heavy Duty Protection.
- » Hasp is Zinc Plated.

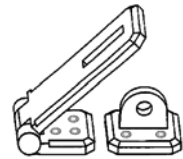

- 1-1/2" steel laminated-5 pin tumbler part # **SPO150***
- 2" steel laminated-5 pin tumbler part # **SPO155***
- 1-1/2" solid brass case-4 pin tumbler part # **SPO160***
- Safety Hasp part # **SPO162***

### Safety Flags

- » Heavy-Duty vinyl coated safety flag.
- » Well suited for all construction and traffic applications.
- » Ideal for use on moving vehicles.

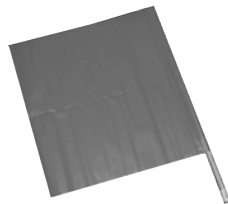

part # **SPO250**

### Reflectors

- » Adhesive backing permanently mounts reflector to any clean, flat surface.
- » Available in Red or Amber

#### Round Reflectors:

- » 3-3/16" diameter acrylic lens.
- » 2 per pack.

#### Oval Reflectors:

- » 4-3/8" x 1 7/8" acrylic lens.
- » 1 per pack .

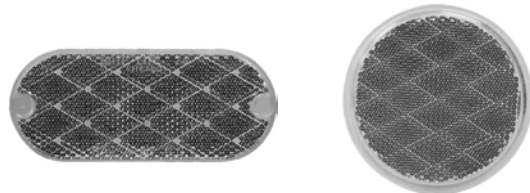

- oval amber reflector part # **SPO270***
- oval red reflector part # **SPO275***
- round amber reflector part # **SPO280***
- round red reflector part # **SPO285***

### Traffic Cones

- » Bright orange cones notify others to exercise caution.
- » Used by highway and street maintenance departments, utilities, cable TV installers, and construction companies.
- » 18" and 26".

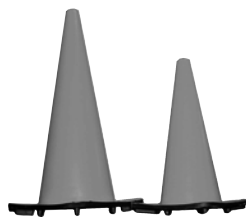

- 18" cone part # **SPO255***
- 26" cone part # **SPO260***
- 18" cone with reflective tape part # **SPO265***

# SAFETY PRODUCTS

## MISCELLANEOUS

### Reflective Red/Silver Strip Kit

- » High-brightness reflective material is rated at 1,000 candlepower and features industrial-strength adhesive to mount on various surfaces.
- » Also offers: four-times greater reflectivity, wider viewing angles, higher visibility at long range and tougher durability.
- » Kit contains eight - 18" strips packaged in a self-service, full color poly pack with a header.

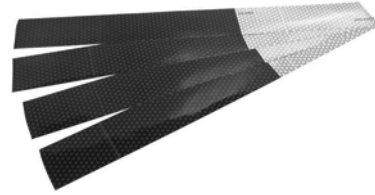

part # SPO290

### Safety Triangle Kit

- » Three triangles in heavy plastic case.
- » Meets FMVSS standards.



part # SPO295

### Tarps

- » Heavy duty double laminated coating with extra strength weave.
- » Sun and fade resistant, rot and rust proof, and no leaks, no tears.
- » Heat sealed seams with grommets every 3 feet and a rope reinforced hem.
- » Ideal for covering: construction sites, farm equipment, machinery, trucks, boats, tools, sports equipment and for other uses.

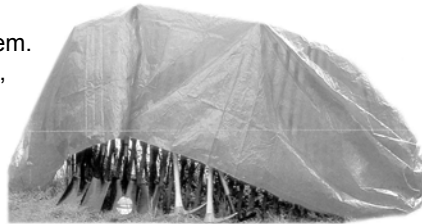

Size	Part #	Qty
8' x 10'	SPO165	1
10' x 15'	SPO170	1
10' x 20'	SPO175	1
15' x 25'	SPO180	1
15' x 30'	SPO185	1
20' x 40'	SPO190	1
40' x 40'	SPO195	1

### Rubber Hold Down Straps

- » Bungee cord.
- » Comes with hooks.



Size	Span	Part #	Qty
9"	15" to 20"	RS-9B	1
15"	20" to 30"	RS-15	1
22"	30" to 40"	RS-22	1
31"	40" to 55"	RS-31	1
41"	47" to 76"	RS-41	1

# 9" X 12" PLASTIC HY-GLO SIGNS

Durable Weather Resistant Signs In Bright Attention Getting Colors

---



part #HYK-3002



part #HYK-3005



part #HYK-3006



part #HYK-3007



part #HYK-3010



part #HYK-3011



part #HYK-3013



part #HYK-3014



part #HYK-3021



part #HYK-3023



part #HYK-3034



# Section 16: Tools

## Table of Contents

<b>Makita</b>		<b>Screwdrivers</b>	
Cordless Tools .....	3	Phillips .....	15
Cordless Accessories .....	3-4	Slotted Round Shank .....	15
Power Tools .....	5-6	Slotted Cabinet Tip .....	15
Power Tool Accessories .....	7-8	Slotted Square Shank .....	15
		Screwdriver Set .....	15
<b>Insert Bits and Drivers</b>		<b>Socket Drive Tools</b>	
Phillips .....	9	1/4" Ratchet Tools .....	16
Slotted .....	9	1/4" Sockets .....	16
Square Recess .....	9	3/8" Ratchet Tools .....	17
Torx Equivalent .....	9	3/8" Sockets .....	17-18
Magnetic Hex Insert Bit Holder .....	9	1/2" Ratchet Tools .....	18
Magnetic Power Nutsetter .....	9	1/2" Sockets .....	19
Phillips Power Bits .....	9	3/4" Ratchet Tools .....	20
Slotted Power Bits .....	9	3/4" Sockets .....	20
Socket Adapter .....	9		
<b>Tamperproof Security Drivers</b>		<b>Torque Wrenches</b>	
Spanner Bits .....	10	ATD Micrometer Torque Wrenches .....	20
Torx® Tamperproof Bits .....	10		
Spanner Driver Kits .....	10	<b>Impact Socket</b>	
		1/2" Drive Sockets .....	21
<b>Hex Keys</b>		1/2" Drive Socket Sets .....	21
Individual Hex-L® Keys .....	11		
Individual Hex-T® Keys .....	11	<b>Wrenches</b>	
Hex-L® Key Sets .....	12	Wright Combination Wrenches .....	22
Fold-Up Key Sets .....	12	Wright Combination Wrench Sets .....	22-23
Cushion Grip Hex-T® Key Sets .....	13	ATD Adjustable Wrench .....	23
Ball Hex-L® Key Sets .....	13	ATD Heavy Duty Pipe Wrench .....	23
Individual Ball Hex-L® Keys .....	13	ATD C-Clamps .....	23
<b>Other Key Sets</b>		<b>Channellock and Vice Grip Pliers</b>	
Fold-A-Ball Key Sets .....	14	Tongue and Groove Pliers .....	23
Fold-Up Torx® Key Sets .....	14	Needle Nose Pliers .....	23
Torx® L-Key Sets .....	14	Diagonal Cutting Pliers .....	23
Fold-Up Screwdriver Set .....	14	End Cutter .....	24

# Section 16: Tools

## Table of Contents

Channellock and Vice Grip Pliers - cont'd		<b>Hand Files</b>	
Lineman's Plier .....	24	Wooden File Handle .....	26
Long Nose Vise Grip .....	24	Insert-A-Grip File Handle .....	26
Straight Jaw Vise Grip .....	24	Half Round Files .....	27
Curved Jaw Vise Grip .....	24	Round Files .....	27
Curved Jaw with Wire Cutter Vise Grip .....	24	Taper Files .....	27
		Flat Bastard Files .....	27
<b>Hammers, Punches and Chisels</b>		Flat Mill Bastard Files .....	27
Rubber Mallet .....	24	Chain Saw Files .....	27
Claw Hammer .....	24		
Brass Hammer .....	24	<b>Torches &amp; Accessories</b>	
Sledge Hammer .....	24	Propane Torch .....	28
Ball Pein Hammer .....	24	Self-Ingning Torch .....	28
Center Punches .....	25	Propane Cylinders .....	28
Starter Punches .....	25	Striker .....	28
Line-Up Punches .....	25	Solder .....	28
Pin Punches .....	25	Solder Paste .....	28
Cold Chisels .....	25	Tubing Cutters .....	28
Pilot Punches .....	25		
6 Piece Punch and Chisel Set .....	25		
6 Piece Cold Chisel Set .....	25		
14 Piece Punch and Chisel Set .....	26		
4 Piece Line-Up Punch Set .....	26		
6 Piece Pilot Punch Set .....	26		

**Makita**



**Nicholson**

**FAS-KIT**

**WRIGHT TOOL**



**DURHAM**

**RIDGID**

# TOOLS

## **Makita** CORDLESS TOOLS AND ACCESSORIES

### 14.4v 1/2" Cordless Drill Kit

- » Two piece D-31 motor for power and serviceability.
- » Shift lock drive instantly changes from drill to driver.
- » 2.6 Ah Ni-MH batteries for greater capacity and longer run time.
- » Includes (2) 14.4V Ni-MH batteries, multi-voltage charger and case.



part # **MKT-6337DWDE**

### Replacement Flashlight Bulbs

- » Genuine Makita replacement bulbs.
- » 2 bulbs per card.



<i>BML240 bulb</i>	part #	<b>MKT-A90984</b>
<i>ML180 bulb</i>	part #	<b>MKT-A90261</b>
<i>ML140 &amp; ML120 bulb</i>	part #	<b>MKT-A90233</b>
<i>ML903 &amp; ML902 bulb</i>	part #	<b>MKT-1925461</b>
<i>ML900 bulb</i>	part #	<b>MKT-1922413</b>
<i>ML702 &amp; ML700 bulb</i>	part #	<b>MKT-1922405</b>

### 18v 1/2" M-FORCE Cordless Drill Kit

- » All metal gear transmission (0-400 / 0-1300 RPM)
- » Exclusive Shift-Lock™ Drive enables one-touch, quick shifting from "drill" to "driver".
- » 2.6 Ah Ni-MH batteries for greater capacity & longer run time.
- » Kit comes with 2 batteries, charger & sturdy plastic tool case.



part # **MKT-6347DWDE**

### 18v Rechargeable Batteries



Ni-MH 3.0 Ah battery part # **MKT-1937848**

Ni-Cd 2.0 Ah battery part # **MKT-1928273**

### 14.4v Cordless Flashlight

- » Up to 160 min. of continuous illumination from a single charge.
- » Four position flashlight head for angling beam in a given direction.
- » Comes with convenient carrying strap.



part # **MKT-ML140**

### 14.4v Rechargeable Batteries



Ni-MH 2.6 Ah battery part # **MKT-1931583**

Ni-Cd 2.0 Ah battery part # **MKT-1926001**

# TOOLS

## **Makita** CORDLESS TOOLS AND ACCESSORIES

### 12v Rechargeable Batteries



Ni-Cd 3.0 Ah battery part # **MKT-1936232**  
 Ni-MH 2.0 Ah battery part # **MKT-1925982**

### 9.6v Rechargeable Batteries



Ni-MH 2.6 Ah battery part # **MKT-1931567**  
 Ni-Cd 2.0 Ah battery part # **MKT-1925966**  
 Ni-Cd 1.3 Ah battery part # **MKT-1926386**  
 Ni-Cd 1.3 Ah battery part # **MKT-6320074**

### 7.2v Rechargeable Batteries



Ni-Cd 1.3 Ah stick type battery part # **MKT-6320024**

### Stubby Finder/Driver

- » The shortened model gives access into tighter work spaces.
- » Provides excellent control when starting screws.
- » Includes:
  - 1 - #2 Phillips bit
  - 1 - 6-8 slotted insert bit.
- » Overall length 3-1/8" (without insert bit).

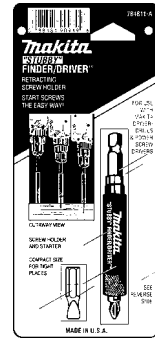

part # **MKT-784811A**

### Original Finder/Driver

- » The original retracting screw-holder is a combination bit holder, extension, bit finder and screw holder.
- » Includes:
  - 1 - #2 Phillips bit .
  - 1 - 6-8 slotted insert bit.
- » Overall length 4-5/8" (without insert bit).

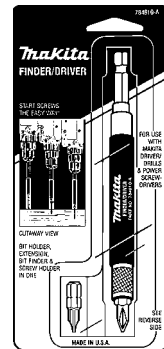

part # **MKT-784810A**

### 7 Piece Finder/Driver Set

- » Set includes the convenient "Stubby" Finder-Driver for most screws and the Original Finder-Driver for long screws.
- 1 - #1 Phillips bit
- 1 - 6-8 slotted insert bit
- 1 - 1/4" nutsetter
- 2 - #2 Phillips bits

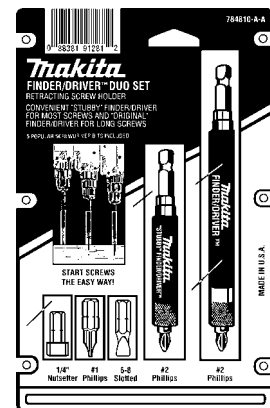

part # **MKT-784810AA**

# TOOLS

## *Makita* POWER TOOLS

### 3/8" Economy Drill

- » Powerful 4.9 AMP motor.
- » Larger trigger switch.
- » Variable speed (0-2,500 RPM).
- » Quieter operation.
- » In-line handle design for maximum power thrust.
- » Large recesses lock-on button.
- » All ball bearing construction for durability.

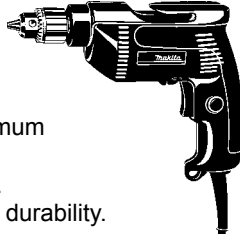

part # MKT-6407

### Drywall Screw Gun

- » Variable speed (0 -4,500 RPM).
- » Highest power-to-weight ratio on the market (6.5 AMP.)
- » Silent synchronized pin clutch.
- » Lightweight cast aluminum gear housing.
- » Large trigger switch is sealed for long tool life. Adjustable depth locator assembly with "sure lock" .

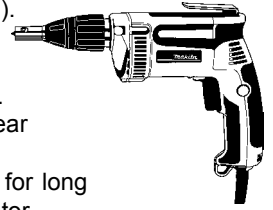

part # MKT-6824N

### 3/8" Heavy Duty Drill

- » Powerful 7 AMP motor.
- » Side handle rotates 360°.
- » Retractable belt clip.
- » Variable speed (0-1,200 RPM).
- » Lightweight cast aluminum gear.
- » Ergonomically designed rubber grips.
- » All ball and needle bearing construction.
- » Large trigger switch is sealed for long tool life.

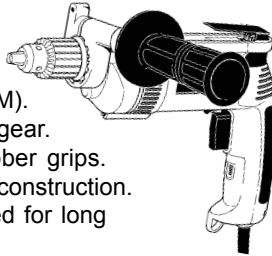

part # MKT-DP3002

### 1" Rotary Hammer Drill

- » Fastest rotary hammer drill in its class.
- » In-line positive grip handle.
- » 360° swivel side handle.
- » Has mode operation; "rotation only" or "hammering with rotation".
- » Built-in torque limiter disengages clutch if bit jams.



part # MKT-HR2455X

### 1/2" Heavy Duty Drill

- » Powerful 6.5 AMP motor.
- » Industrial metal gear housing for durability and long tool life.
- » Variable speed (0 - 550 RPM).
- » Heavy duty 1/2" drill chuck .
- » Compact and lightweight (4.8 lbs.).
- » Large recessed lock-on button.
- » Side handle can be attached to either side of tool for better control.

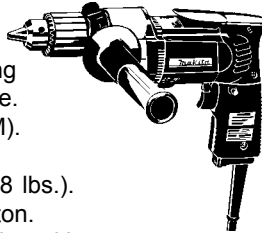

part # MKT-6302H



### 3/8" Right Angle Drill

- » Lightweight (3.5 lbs.)
- » Variable speed (0-1400 RPM).
- » Reversing feature and compact design for getting in and out of tight spots.
- » Ball and needle bearing construction.
- » Heavy duty drill chuck for positive bit retention and accurate drilling.



part # MKT-DA3010F

### 4" Angle Grinder

- » Switch is located on top of motor housing.
- » Small circumference
- » barrel grip for easy handling.
- » Labyrinth construction seals motor and bearings from contamination.
- » Shaft lock for easy wheel changes.
- » Side handle can be installed on either side of tool.

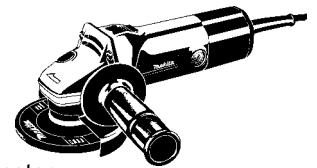

part # MKT-9553NBK

# TOOLS

## *Makita* POWER TOOLS

### 4-1/2" Angle Grinder

- » Powerful 6.4 AMP motor.
- » Switch is located on top of motor housing.
- » Labyrinth construction seals motor and bearings from contamination.
- » Side handle can be installed on either side of tool.

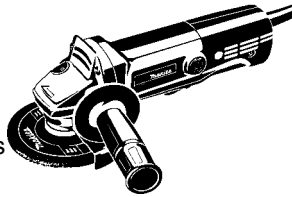

part # MKT-9557PB

### 7" Angle Grinder

- » 15 AMP motor.
- » 6,600 RPM.
- » Large trigger switch for easy operation; lock-on feature.
- » Labyrinth construction seals motor and bearings from contamination.
- » Switch handle can be rotated either 90° left or right.

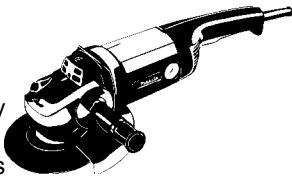

part # MKT-GA7021

### Die Grinder

- » Trim line design allows for easy handling and positive control.
- » 25,000 RPM for fast deburring, scraping, and grinding.
- » 2 AMP hi-tech motor.
- » 1/4" collet size accepts popular die grinders accessories



part # MKT-GE0600

### Reciprocating Saw

- » Variable speed. 9 Amp motor
- » Lightweight (6.4 lbs.)
- » Long 1-1/8" stroke for faster cutting.
- » All ball and needle bearings for longer tool life.
- » Accepts standard 1/2" shank blades.
- » "Tool-less" blade change and shoe adjustment.

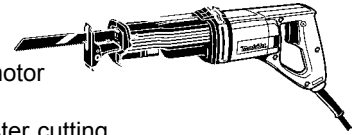

part # MKT-JR3050T

### 7-1/4" Circular Saw

- » 13 AMP heavy duty hi-tech motor
- » 5,800 RPM.
- » Cuts 2-3/8" at 90° and 1-3/4" at 45°.
- » Comes complete with carbide tipped blade for efficient cutting.
- » Electric brake for fast stopping.

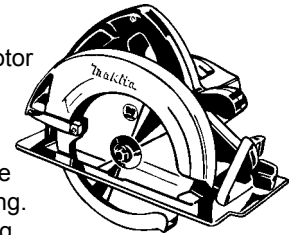

part # MKT-5007NBK

### Chop Saw

- » Lock-off button prevents accidental starting.
- » Shaft lock for easy wheel changes.
- » Guide plate adjusts 45° right and left.
- » Spark diversion guard.
- » Quick release vise.
- » Adjustable depth stop.

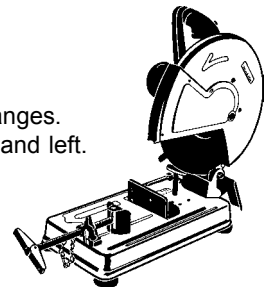

part # MKT-2414NB

### Palm Sander

- » Dust bag for clean, efficient sanding.
- » 14,000 OPM; 2.1lbs.
- » 1.6 AMP motor
- » Palm grip design for easy handling.

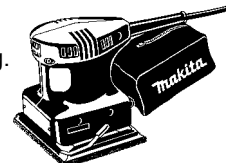

part # MKT-B04552K

### Heat Gun

- » Variable temperature control
- » 250° F - 1,100° F.
- » thermocouple control maintains temperature.
- » 2-speed blower setting; 8CFM or 14 CFM



part # MKT-HG1100

# Makita®

# TOOLS

## **Makita** POWER TOOL ACCESSORIES

### 4" Grinding Wheel

- » For metal polishing and general flat grinding.
- » Aluminum oxide abrasive grains are evenly distributed to give a smooth surface.
- » 24 grit.



part # **MKT-741402C**

### 4" Sanding Disc Rubber Backing Pad

- » For use with N9501BZ and N9514B - 4" Disc Grinders and 9523NBH - 4" Angle Grinders.



part # **MKT-7430096**

### 4" Multi-Discs

- » Zirconium Abrasive Grain provides consistent high cut rate, runs cooler and lasts longer.
- » Use for weld head blending, remove weld slag, deburring, edge blending, surface conditioning and metal fabrication.



36 grit disc part # **MKT-741810B**

60 grit disc part # **MKT-741811B**

### Crimped Wire Cup Brush

- » 3" diameter.
- » 5/8-11 arbor.
- » Carbon steel wire.
- » Flexible brushing action is excellent on wide, flat and/or irregular surfaces.



part # **MKT-7432056**

### 4" Sanding Discs

- » Superior stock removal.
- » Specially formulated resin bond coat.
- » Great for metal and wood.
- » For use on N9514B and N9514B - 4" Disc Grinders and 9523NBH - 4" Angle Grinder.

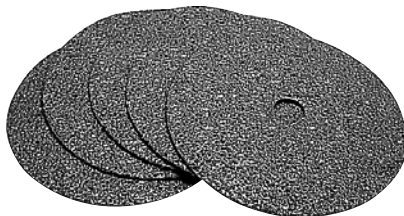

24 grit disc part # **MKT-74203603**

36 grit disc part # **MKT-74203783**

50 grit disc part # **MKT-74203863**

80 grit disc part # **MKT-74203943**

100 grit disc part # **MKT-74208733**

120 grit disc part # **MKT-74204093**

### 2-3/4" Knot Wire Cup Brushes

- » Rugged knot construction.
- » Carbon steel or stainless steel wire.
- » Cleans weld beads, angle welds, and corners.
- » Ideal for tight operations.
- » Highly corrosion-resistant eliminating the problem of contamination or rust residue.
- » MKT-743209-B is for aluminum and stainless steel.



M10 x 1.25 arbor part # **MKT-743215A**

5/8-11 arbor part # **MKT-743209A**

stainless steel 5/8-11 arbor part # **MKT-743209B**

# TOOLS

## **Makita** POWER TOOL ACCESSORIES

### Bevel Brush

- » 3-3/8" diameter.
- » 5/8-11 arbor.
- » Excellent for removing paint, scale, rust, burrs, and spatter from metal.



3-3/8" - 5/8-11 arbor wire brush part # **MKT-743210A**

### Knot Wire Wheel Brush - Standard Twist

- » 4" diameter.
- » 5/8-11 arbor.
- » Perfect for removing rust, scale, and oxidation.
- » Cleans threads and metal surfaces.
- » 1/2" face width for broader cleaning coverage.



part # **MKT-743212A**

### Stringer Bead Twist Wheel

- » 4" diameter and 5/8-11 arbor.
- » Carbon steel or stainless steel wire.
- » Ideal for cleaning of weld spatter and slag and removing rust, scale, and oxidation.



part # **MKT-743213A**  
stainless steel part # **MKT-743213B**

### Locknut

- » Sanding disc lock-nuts for Makita 4" grinders
- » Use with rubber pads.
- » Lock nut m10 x .125



part # **MKT-2245016**

### Knot Wire Wheel Brush

- » Full cable twist.
- » 4" diameter.
- » M10 x 1.25 arbor.
- » Weld cleaning and metal preparation.
- » Excellent for grooves.  
Carbon steel or stainless steel wire.



part # **MKT-7432034B**  
stainless steel part # **MKT-743214A**

### Spanner Wrench

- » Sanding disc lock-nuts for Makita 4" grinders
- » Use with rubber pads.
- » Lock nut m10 x .125



part # **MKT-7824011**

### Knot Wire Wheel Brush - Cable Twist

- » Full cable twist.
- » 4" diameter.
- » 5/8-11 arbor.
- » 1/4" face width for narrow to medium width work.
- » Excellent for grooves.
- » For Weld cleaning and metal preparation.



part # **MKT-743211A**



# TOOLS

## INSERT BITS AND DRIVERS

### Phillips Insert Bits

- » 1/4" hex shank hardened steel.
- » Sold individually.

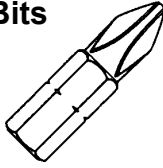

Size	Part #
#1 x 1 x 1/4	DRI100
#2 x 1 x 1/4	DRI101
#3 x 1 x 1/4	DRI102

### Slotted Insert Bits

- » 1/4" hex shank hardened steel.
- » Sold individually.

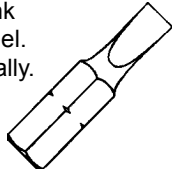

Size	Part #
#4-5 x 1 x 1/4	DRI105
#6-8 x 1 x 1/4	DRI107
#8-10 x 1 x 1/4	DRI108
#10-12 x 1 x 1/4	DRI109
#12-14 x 1 x 1/4	DRI110

### Square Recess Insert Bits

- » 1/4" hex shank hardened steel.
- » Sold individually.

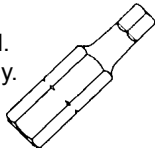

Size	Part #
#1 x 1 x 1/4	DRI115
#2 x 1 x 1/4	DRI116
#3 x 1 x 1/4	DRI117

### Torx Equivalent Insert Bits

- » 1/4" hex shank hardened steel.
- » Sold individually.

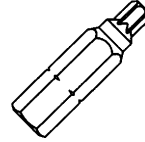

Size	Part #
T8 x 1 x 1/4	DRI120
T9 x 1 x 1/4	DRI121
T10 x 1 x 1/4	DRI122
T15 x 1 x 1/4	DRI123
T20 x 1 x 1/4	DRI124
T25 x 1 x 1/4	DRI125
T27 x 1 x 1/4	DRI126
T30 x 1 x 1/4	DRI127
T40 x 1 x 1/4	DRI128

### Magnetic Hex Insert Holders Bits

- » 1/4" hex shank hardened steel.
- » Sold individually.

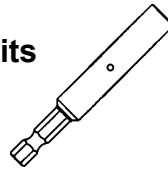

Size	Part #
2-7/8 x 1/4	DRI130

### Magnetic Power Nutsetter

- » 1/4" hex shank hardened steel.
- » For use with hex head screws.
- » Sold individually.

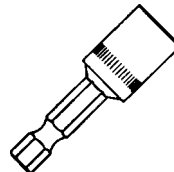

Size	Part #
1/4 x 1 5/8	DRI135
5/16 x 1 5/8	DRI136
3/8 x 1 7/8	DRI137
7/16 x 2	DRI138
1/4 x 2 9/16	DRI139
5/16 x 2 9/16	DRI140
3/8 x 2 9/16	DRI141

### Phillips Power Bits

- » 1/4" hex shank hardened steel.
- » Sold individually.

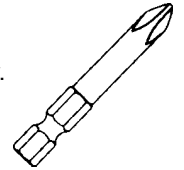

Size	Part #
#1 x 1-15/16 x 1/4	DRI145
#2 x 1-15/16 x 1/4	DRI146
#3 x 1-15/16 x 1/4	DRI147
#1 x 2-3/4 x 1/4	DRI148
#2 x 2-3/4 x 1/4	DRI149
#3 x 2-3/4 x 1/4	DRI150
#2 x 3-1/2 x 1/4	DRI151
#2 x 6 x 1/4	DRI152

### Slotted Power Bits

- » 1/4" hex shank hardened steel.
- » Sold individually.

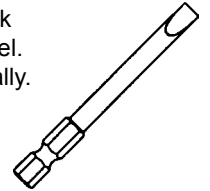

Size	Part #
#6-7 x 1 x 15/16	DRI155
#8-10 x 1 x 15/16	DRI156
#10-12 x 1 x 15/16	DRI157

### Socket Adapter

- » Converts sockets into power nutsetters.
- » Sold individually.



Drive	Part #
1/4	VER-15471
3/8	VER15475

# TOOLS

## TAMERPROOF SECURITY DRIVERS

### Spanner Bits

- » Modified high performance tool steel.
- » Natural steel finish.

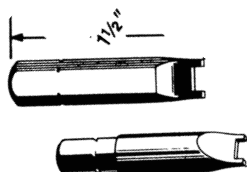

Tip Size	Hex	Part #
# 4 Bit	1/4	DRI165
# 4 Bit	5/16	DRI166
# 6 Bit	1/4	DRI167
# 6 Bit	5/16	DRI168
# 8 Bit	1/4	DRI169
# 8 Bit	5/16	DRI170
# 10 Bit	1/4	DRI171
# 10 Bit	5/16	DRI172
# 12 Bit	1/4	DRI173
# 12 Bit	5/16	DRI174
# 1/4 Bit	1/4	DRI175
# 1/4 Bit	5/16	DRI176

### Spanner Driver Kit

- » Driver Kit #SP5
- » 1 Magnetic Hand Driver
- » 5 Spanner Bits - 6, 8, 10, 12, 1/4
- » Vinyl Pouch

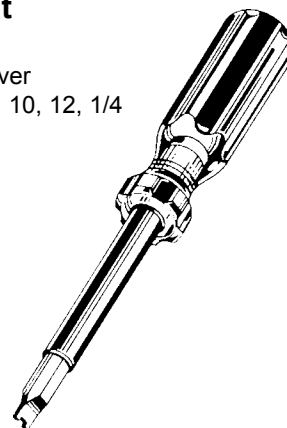

Description	Part #
#SP5 Driver Kit with 5 Bits (1/4" Hex).	DRI180
#SP5 Driver Kit with 5 Bits (5/16" Hex).	DRI181

### Torx® Tamperproof Bits

- » Fits tamper resistant Torx® fasteners found on radio mountings, exterior mirrors, carburetors and other applications.



Size	Hex	Part #
T-7 Bit	1/4	DRI185
T-8 Bit	1/4	DRI186
T-9 Bit	1/4	DRI187
T-10 Bit	1/4	DRI188
T-15 Bit	1/4	DRI189
T-20 Bit	1/4	DRI190
T-25 Bit	1/4	DRI191
T-27 Bit	1/4	DRI192
T-30 Bit	1/4	DRI193

### Torx Driver Kit

- » Driver Kit #TX7
- » 1 Magnetic Hand Driver
- » 7 Torx Tamperproof bits
- » Vinyl Pouch

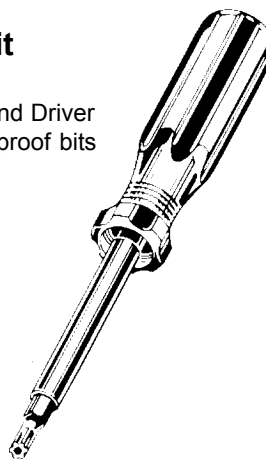

Description	Part #
#TX7 Driver Kit with 7 Bits - T8, T9, T10, T15, T20, T25, T27.	DRI195

# TOOLS

## HEX KEYS

### Individual Hex-L® Keys

#### Inch Sizes

Size	Part #	
	Short Arm	Long Arm
.028	DRI200	—
.035	DRI201	—
.050	DRI202	—
1/16	DRI203	DRI225
5/64	DRI204	DRI226
3/32	DRI205	DRI227
7/64	DRI206	DRI228
1/8	DRI207	DRI229
9/64	DRI208	DRI230
5/32	DRI209	DRI231
3/16	DRI210	DRI232
7/32	DRI211	DRI233
1/4	DRI212	DRI234
5/16	DRI213	DRI235
3/8	DRI214	DRI236
7/16	DRI215	DRI237
1/2	DRI216	DRI238
9/16	DRI217	—
5/8	DRI218	—
3/4	DRI219	—
7/8	DRI220	—
1	DRI221	—



#### Metric Sizes

Size	Part #
	Short Arm
1.5	DRI245
2.0	DRI246
2.5	DRI247
3.0	DRI248
4.0	DRI249
5.0	DRI250
6.0	DRI251
8.0	DRI252
10.0	DRI253
12.0	DRI254

### Individual Hex-T® Keys

#### Inch Sizes

Size	Part #
3/32	EKL-51606
7/64	EKL-51607
1/8	EKL-51608
9/64	EKL-51609
5/32	EKL-51610
3/16	EKL-51612
7/32	EKL-51614
1/4	EKL-51616
5/16	EKL-51620
3/8	EKL-51624

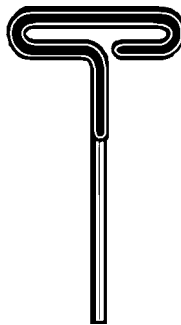

#### Metric Sizes

Size	Part #
2.0	EKL-54620
2.5	EKL-54625
3.0	EKL-54630
4.0	EKL-54640
5.0	EKL-54650
6.0	EKL-54660
8.0	EKL-54680
10.0	EKL-54690

- » Cushion grip.
- » 6" length

# TOOLS

## HEX KEY SETS

### Hex-L® Key Sets

- » Four combinations of Hex-L® Key Sets are available in popular inch and metric sizes.
- » These sets are conveniently organized into separate molded plastic holders that are color-coded, red for inch and blue for metric.



#### Inch Set Sizes

Set	Key Sizes	Part #
7 piece	5/64, 3/32, 1/8, 5/32, 3/16, 7/32, 1/4	EKL-10207
11 piece	.050, 1/16, 5/64, 3/32, 7/64, 1/8, 9/64, 5/32, 3/16, 7/32, 1/4	EKL-10211
13 piece	.050, 1/16, 5/64, 3/32, 7/64, 1/8, 9/64, 5/32, 3/16, 7/32, 1/4, 5/16, 3/8	EKL-10213

#### Metric Set Sizes

Set	Key Sizes	Part #
7 piece	1.5, 2.0, 2.5, 3.0, 4.0, 5.0, 6.0	EKL-10607
9 piece	1.5, 2.0, 2.5, 3.0, 4.0, 5.0, 6.0, 8.0, 10.0	EKL-10609

### Fold-Up Key Sets

- » Each set of keys is housed in a one-piece comfort grip handle which is designed to operate smoothly, as well as hold the keys firmly in any desired work position.



#### Inch Set Sizes

Set	Key Sizes	Part #
8 piece	.050, 1/16, 5/64, 3/32, 7/64, 1/8, 9/64, 5/32	EKL-20811
9 piece	.050, 1/16, 5/64, 3/32, 7/64, 1/8, 9/64, 5/32, 3/16	EKL-20912
9 piece	5/64, 3/32, 7/64, 1/8, 9/64, 5/32, 3/16, 7/32, 1/4	EKL-20911
8 piece	3/32, 7/64, 1/8, 9/64, 5/32, 3/16, 7/32, 1/4	EKL-20812
5 piece	3/16, 7/32, 1/4, 5/16, 3/8	EKL-20511

#### Metric Set Sizes

Set	Key Sizes	Part #
7 piece	1.5, 2.0, 2.5, 3.0, 4.0, 5.0, 6.0	EKL-20811
7 piece	2.0, 2.5, 3.0, 4.0, 5.0, 6.0, 8.0	EKL-20912
6 piece	3.0, 4.0, 5.0, 6.0, 8.0, 10.0	EKL-20911

# TOOLS

## HEX KEY SETS

### Cushion Grip Hex-T Key Sets

- » These Hex T-Keys feature a one piece loop handle for extra strength which is vinyl coated to reduce hand fatigue.
- » Pouch sets or bench sets with metal stands are available in 6" and 9" arm lengths and in inch or metric sizes.



#### Inch Set Sizes

Arm	Key Sizes	Part #
6"	3/32, 7/64, 1/8, 9/64, 5/32, 3/16, 7/32, 1/4, 5/16, 3/8	EKL-53610
9"	3/32, 7/64, 1/8, 9/64, 5/32, 3/16, 7/32, 1/4, 5/16, 3/8	EKL-53910

#### Metric Set Sizes

Arm	Key Sizes	Part #
6"	2.0, 2.5, 3.0, 4.0, 5.0, 6.0, 8.0, 10.0	EKL-55168

### Ball-Hex-L Sets & Individual Keys Inch Sizes

- » Two combinations of Ball-Hex-L™ Key Sets are available in popular inch and metric sizes.
- » Conveniently organized into separate molded plastic holders that are color-coded, red for inch and blue for metric.



#### Inch Sizes

Size	Part #	EKL-13213	EKL-13211	EKL-13207
.050"	EKL-18203	✓	✓	
1/16"	EKL-18204	✓	✓	
5/64"	EKL-18205	✓	✓	✓
3/32"	EKL-18206	✓	✓	✓
7/64"	EKL-18207	✓	✓	
1/8"	EKL-18208	✓	✓	✓
9/64"	EKL-18209	✓	✓	
5/32"	EKL-18210	✓	✓	✓
3/16"	EKL-18212	✓	✓	✓
7/32"	EKL-18214	✓	✓	✓
1/4"	EKL-18216	✓	✓	✓
5/16"	EKL-18220	✓		
3/8"	EKL-18224	✓		



#### Metric Sizes

Size	Part #	EKL-13609	EKL-13607
1.5	EKL-18603	✓	✓
2.0	EKL-18604	✓	✓
2.5	EKL-18605	✓	✓
3.0	EKL-18606	✓	✓
4.0	EKL-18608	✓	✓
5.0	EKL-18610	✓	✓
6.0	EKL-18612	✓	✓
8.0	EKL-18616	✓	
10.0	EKL-18620	✓	

# TOOLS

## OTHER KEY SETS

### Fold-A-Ball Key Sets

- » Three inch sizes and 2 metric sizes are available. This versatile tool allows 360 degrees of rotation at up to a 25 degree angle.



#### Inch Set Sizes

Set	Key Sizes	Part #
5 piece	3/16, 7/32, 1/4, 5/16, 3/8	EKL-20519
7 piece	1/16, 5/64, 3/32, 7/64, 1/8, 9/64, 5/32	EKL-20719
9 piece	5/64, 3/32, 7/64, 1/8, 9/64, 5/32, 3/16, 7/32, 1/4	EKL-20919

#### Metric Set Sizes

Set	Key Sizes	Part #
5 piece	1.5, 2.0, 2.5, 3.0, 4.0	EKL-21158
5 piece	4.0, 5.0, 6.0, 8.0, 10.0	EKL-21159

### Fold-Up Torx® Key Sets

- » Two models are available to cover a wide range of applications: Automotive headlights, taillights and trim; power tools, carbide inserts in cutting tools; and appliances and electronics.
- » Keys are made from hardened and tempered 8650 alloy and finished to resist rust.



Set	Key Sizes	Part #
7 piece	T10, T15, T20, T25, T27, T30, T40	EKL-21158
7 piece	T6, T7, T8, T9, T10, T15, T20	EKL-21159

### Torx® L- Key Sets

- » Two Torx® Key Sets are available in seven sizes and in both short or long arm series.
- » Come in a green compact molded plastic holder with size marked holes.
- » Cover a wide range of applications including automotive headlights, taillights and trim; power tools, carbide inserts in cutting tools; appliances and electronics.



Key Sizes	Part #
T10, T15, T20, T25, T27, T30, T40	EKL-10907

### Fold-Up Screwdriver Set

- » Offers various size flat blades, No. 1 Phillips, a scratch awl and the popular T15 Torx® Key which is used for replacement headlights and auto trim.
- » Easily kept in glove compartment, kitchen or desk drawers.



Key Sizes	Part #
1/8 flat blade, 3/16 flat blade, 1/4 flat blade, #1 phillips, awl, T15 Torx®	EKL-10907

# WRIGHT HAND TOOLS

## SCREWDRIVERS



### Phillips Tip Screwdrivers

» Large ergonomic grip and 3-flute handle.



Tip Size	Overall Length	Blade Length	Handle Length	Part #
# 2	3-7/16	1-1/2	1-15/16	WRI-9101
# 0	6"	3"	3"	WRI-9103
# 1	7"	3"	4"	WRI-9104
# 2	8-1/4	4"	4-1/4	WRI-9105
# 3	10-7/8	6"	4-7/8	WRI-9106
# 1	12"	8"	4"	WRI-9107
# 2	12-1/4	8"	4-1/4	WRI-9108
# 4	13"	8"	5"	WRI-9109

### Slotted Cabinet Tip Screwdrivers

» Large ergonomic grip and 3-flute handle.



Tip Size	Overall Length	Blade Length	Handle Length	Part #
1/8	6"	3"	3"	WRI-9112
1/8	8"	5"	3"	WRI-9113
3/16	7"	3"	4"	WRI-9114
3/16	8"	4"	4"	WRI-9115
3/16	10"	6"	4"	WRI-9116
3/16	12"	8"	4"	WRI-9117
1/4	14-1/4	10"	4-1/4	WRI-9118

### Slotted Round Shank Screwdrivers

» Large ergonomic grip and 3-flute handle.



Tip Size	Overall Length	Blade Length	Handle Length	Part #
1/4	3-7/16	1-1/2	1-5/16	WRI-9122
1/4	6"	4"	3"	WRI-9123
1/4	10-1/4	6"	4-1/4	WRI-9124
5/16	10-7/8	6"	4-7/8	WRI-9125
3/8	13-1/2	8"	5-1/2	WRI-9126
3/8	15-1/2	10"	5-1/2	WRI-9127
3/8	17-1/2	12"	5-1/2	WRI-9128

### Slotted Square Shank Screwdrivers

» Large ergonomic grip and 3-flute handle.



Tip Size	Overall Length	Blade Length	Handle Length	Part #
1/4	8-1/4	4"	4-1/4	WRI-9132
1/4	10-1/4	6"	4-1/4	WRI-9133
5/16	10-7/8	6"	4-7/8	WRI-9134
3/8	13-1/2	8"	5-1/2	WRI-9135
3/8	15-1/2	10"	5-1/2	WRI-9136
3/8	17-1/2	12"	5-1/2	WRI-9137

### 10 Piece Screwdriver Set

- » 4" Slotted Round Shank Screwdriver
- » 6" Slotted Round Shank Screwdriver
- » 4" Slotted Cabinet Tip Screwdriver
- » 6" Slotted Cabinet Tip Screwdriver
- » 1-1/2" Slotted Round Shank Screwdriver
- » 8" Slotted Square Shank Screwdriver
- » 1-1/2" Phillips Screwdriver
- » 3" Phillips Screwdriver
- » 4" Phillips Screwdriver
- » 6" Phillips Screwdriver



part # WRI-9476

# WRIGHT HAND TOOLS

## 1/4" DRIVE SOCKET TOOLS



### 1/4" Drive Quick Release Ratchet



part # WRI-E2426

### 1/4" Drive Flex Handle



part # WRI-E2435

### 1/4" Drive Socket Extension



1-1/2" part # WRI-E2402  
3" part # WRI-E2403  
6" part # WRI-E2406

### 1/4" Spinner Handle With Female End



part # WRI-E2442

### 1/4" Ratchet Repair Kit



part # WRI-E2426RK

### Adaptor, 1/4"F X 3/8"M



part # WRI-E2453

### 1/4" Universal Joint



part # WRI-E2475

## 1/4" Drive Sockets

### 6 Point Standard



### 6 Point Deep



#### Inch Sizes

#### Metric Sizes

#### Inch Sizes

#### Metric Sizes

Size	Part #
5/32	WRI-E2005
3/16	WRI-E2006
7/32	WRI-E2007
1/4	WRI-E2008
9/32	WRI-E2009
5/16	WRI-E2010
11/32	WRI-E2011
3/8	WRI-E2012
7/16	WRI-E2014
1/2	WRI-E2016

Size	Part #
4 mm	WRI-M2004
5 mm	WRI-M2005
6 mm	WRI-M2006
7 mm	WRI-M2007
8 mm	WRI-M2008
9 mm	WRI-M2009
10 mm	WRI-M2010
11 mm	WRI-M2011
12 mm	WRI-M2012
13 mm	WRI-M2013

Size	Part #
3/16	WRI-E2506
7/32	WRI-E2507
1/4	WRI-E2508
9/32	WRI-E2509
5/16	WRI-E2510
11/32	WRI-E2511
3/8	WRI-E2512
7/16	WRI-E2514
1/2	WRI-E2516

Size	Part #
4 mm	WRI-M2504
5 mm	WRI-M2505
6 mm	WRI-M2506
7 mm	WRI-M2507
8 mm	WRI-M2508
9 mm	WRI-M2509
10 mm	WRI-M2510
11 mm	WRI-M2511
12 mm	WRI-M2512
13 mm	WRI-M2513
14 mm	WRI-M2514





# WRIGHT HAND TOOLS

## 3/8" DRIVE SOCKET TOOLS



WRIGHT TOOL

### 3/8" Drive Quick Release Ratchet



part # WRI-E3426

### 3/8" Drive Flex Handle



part # WRI-E3435

### 3/8" Drive Socket Extension



3" part # WRI-E3403

6" part # WRI-E3405

### 3/8" Sparkplug Socket



part # WRI-E3590

### 3/8" Ratchet Repair Kit



part # WRI-E3426RK

### Adaptor, 3/8" F X 1/4" M



part # WRI-E3452

### Adaptor, 3/8" F X 1/2" M



part # WRI-E3454

### 3/8" Universal Joint



part # WRI-E3475

## 3/8" Drive Sockets

### 6 Point Standard



#### Inch Sizes

Size	Part #
1/4	WRI-E3008
5/16	WRI-E3010
3/8	WRI-E3012
7/16	WRI-E3014
1/2	WRI-E3016
9/16	WRI-E3018
5/8	WRI-E3020
11/16	WRI-E3022
3/4	WRI-E3024
13/16	WRI-E3026
7/8	WRI-E3028
1"	WRI-E3032

#### Metric Sizes

Size	Part #
6 mm	WRI-M3006
7 mm	WRI-M3007
8 mm	WRI-M3008
9 mm	WRI-M3009
10 mm	WRI-M3010
11 mm	WRI-M3011
12 mm	WRI-M3012
13 mm	WRI-M3013
14 mm	WRI-M3014
15 mm	WRI-M3015
16 mm	WRI-M3016
17 mm	WRI-M3017
18 mm	WRI-M3018
19 mm	WRI-M3019
20 mm	WRI-M3020
21 mm	WRI-M3021
22 mm	WRI-M3022

### 6 Point Deep



#### Inch Sizes

Size	Part #
3/8"	WRI-E3512
7/16	WRI-E3514
1/2	WRI-E3516
9/16	WRI-E3518
5/8	WRI-E3520
11/16	WRI-E3522
3/4	WRI-E3524
13/16	WRI-E3526
7/8	WRI-E3528

#### Metric Sizes

Size	Part #
9 mm	WRI-M3509
10 mm	WRI-M3510
11 mm	WRI-M3511
12 mm	WRI-M3512
13 mm	WRI-M3513
14 mm	WRI-M3514
15 mm	WRI-M3515
16 mm	WRI-M3516
17 mm	WRI-M3517
18 mm	WRI-M3518
19 mm	WRI-M3519



# WRIGHT HAND TOOLS

## 3/8" DRIVE SOCKET TOOLS



WRIGHT TOOL

### 3/8" Drive Sockets

#### 12 Point Standard



#### Metric Sizes

Size	Part #
8 mm	WRI-M3108
9 mm	WRI-M3109
10 mm	WRI-M3110
11 mm	WRI-M3111
12 mm	WRI-M3112
13 mm	WRI-M3113
14 mm	WRI-M3114
15 mm	WRI-M3115
16 mm	WRI-M3116
17 mm	WRI-M3117
18 mm	WRI-M3118
19 mm	WRI-M3119
21 mm	WRI-M3121

#### Inch Sizes

Size	Part #
5/16	WRI-E3110
3/8	WRI-E3112
7/16	WRI-E3114
1/2	WRI-E3116
9/16	WRI-E3118
5/8	WRI-E3120
11/16	WRI-E3122
3/4	WRI-E3124
13/16	WRI-E3126
7/8	WRI-E3128

#### 12 Point Deep



#### Inch Sizes

Size	Part #
3/8	WRI-E3612
7/16	WRI-E3614
1/2	WRI-E3616
9/16	WRI-E3618
5/8	WRI-E3620
11/16	WRI-E3622
3/4	WRI-E3624
13/16	WRI-E3626
7/8	WRI-E3628
15/16	WRI-E3630
1"	WRI-E3632

#### Metric Sizes

Size	Part #
9 mm	WRI-M3609
10 mm	WRI-M3610
11 mm	WRI-M3611
12 mm	WRI-M3612
13 mm	WRI-M3613
14 mm	WRI-M3614
15 mm	WRI-M3615
16 mm	WRI-M3616
17 mm	WRI-M3617
18 mm	WRI-M3618
19 mm	WRI-M3619

# WRIGHT HAND TOOLS

## 1/2" DRIVE SOCKET TOOLS



WRIGHT TOOL

#### 1/2" Drive Quick Release Ratchet



part # WRI-E4426

#### Adaptor, 1/2"F X 3/8"M



part # WRI-E4453

#### 1/2" Drive Flex Handle



part # WRI-E4435

#### 1/2" Universal Joint



part # WRI-E4475

#### 1/2" Drive Socket Extension



2-1/2" part # WRI-E4402  
6" part # WRI-E4406  
10" part # WRI-E4410

#### 1/2" Ratchet Repair Kit



part # WRI-E4426RK



# WRIGHT HAND TOOLS

## 1/2" DRIVE SOCKETS



WRIGHT TOOL

### 6 Point Standard



#### Inch Sizes

Size	Part #
3/8	WRI-E4012
7/16	WRI-E4014
1/2	WRI-E4016
9/16	WRI-E4018
5/8	WRI-E4020
11/16	WRI-E4022
3/4	WRI-E4024
13/16	WRI-E4026

#### Inch Sizes

Size	Part #
13/16	WRI-E4026
7/8	WRI-E4028
15/16	WRI-E4030
1"	WRI-E4032
1-1/16	WRI-E4034
1-1/8	WRI-E4036
1-1/4	WRI-E4040

### 6 Point Deep



#### Metric Sizes

Size	Part #
10 mm	WRI-M4510
11 mm	WRI-M4511
12 mm	WRI-M4512
13 mm	WRI-M4513
14 mm	WRI-M4514
15 mm	WRI-M4515
16 mm	WRI-M4516
17 mm	WRI-M4517
18 mm	WRI-M4518
19 mm	WRI-M4519
20 mm	WRI-M4520
21 mm	WRI-M4521
22 mm	WRI-M4522
23 mm	WRI-M4523
24 mm	WRI-M4524
25 mm	WRI-M4525
26 mm	WRI-M4526
27 mm	WRI-M4527

#### Inch Sizes

Size	Part #
1/2	WRI-E4516
9/16	WRI-E4518
5/8	WRI-E4520
11/16	WRI-E4522
3/4	WRI-E4524
13/16	WRI-E4526
7/8	WRI-E4528
15/16	WRI-E4530
1"	WRI-E4532
1-1/16	WRI-E4534
1-1/8	WRI-E4536

### 12 Point Standard



#### Metric Sizes

Size	Part #
9 mm	WRI-M4109
10 mm	WRI-M4110
11 mm	WRI-M4111
12 mm	WRI-M4112
13 mm	WRI-M4113
14 mm	WRI-M4114
15 mm	WRI-M4115
16 mm	WRI-M4116
17 mm	WRI-M4117
18 mm	WRI-M4119
19 mm	WRI-M4119
20 mm	WRI-M4120
21 mm	WRI-M4121
22 mm	WRI-M4122
23 mm	WRI-M4123
24 mm	WRI-M4124
25 mm	WRI-M4125
26 mm	WRI-M4126
27 mm	WRI-M4127
28 mm	WRI-M4128
30 mm	WRI-M4130
32 mm	WRI-M4132
34 mm	WRI-M4136

#### Inch Sizes

Size	Part #
3/8	WRI-E4112
7/16	WRI-E4114
1/2	WRI-E4116
9/16	WRI-E4118
5/8	WRI-E4120
11/16	WRI-E4122
3/4	WRI-E4124
13/16	WRI-E4126
7/8	WRI-E4128
15/16	WRI-E4130
1"	WRI-E4132
1-1/16	WRI-E4134
1-1/8	WRI-E4136
1-1/4	WRI-E4140
1-1/2	WRI-E4148

### 12 Point Deep



#### Inch Sizes

Size	Part #
1/2	WRI-E4616
9/16	WRI-E4618
5/8	WRI-E4620
11/16	WRI-E4622
3/4	WRI-E4624
13/16	WRI-E4626

#### Inch Sizes

Size	Part #
7/8	WRI-E4628
15/16	WRI-E4630
1"	WRI-E4632
1-1/16	WRI-E4634
1-1/8	WRI-E4636



# WRIGHT HAND TOOLS

## 3/4" DRIVE SOCKET TOOLS



WRIGHT TOOL

### 3/4" Drive Ratchet



part # WRI-6400

### 3/4" Ratchet Repair Kit



part # WRI-6402

### 3/4" Drive Flex Handle



part # WRI-6435

### 3/4" Drive Socket Extension



3-1/2" part # WRI-6403

8" part # WRI-6408

16" part # WRI-6416

### 3/4" Drive Sliding T-Handle



part # WRI-6443

### 3/4" Universal Joint



part # WRI-6475

## 3/4" Drive Sockets

### 12 Point Standard Inch Sizes



Size	Part #
1-3/8	WRI-6144
1-7/16	WRI-6146
1-1/2	WRI-6148
1-9/16	WRI-6150
1-5/8	WRI-6152
1-11/16	WRI-6154
1-3/4	WRI-6156
1-13/16	WRI-6158

### Inch Sizes

Size	Part #
1-7/8	WRI-6160
2"	WRI-6164
2-1/16	WRI-6166
2-1/8	WRI-6168
2-3/16	WRI-6170
2-1/4	WRI-6172
2-3/8	WRI-6176

### 6 Point Deep



### Inch Sizes

Size	Part #
3/4	WRI-6524
13/16	WRI-6526
7/8	WRI-6528
15/16	WRI-6530
1"	WRI-6532
1-1/16	WRI-6534
1-1/8	WRI-6536

### Inch Sizes

Size	Part #
1-3/16	WRI-6538
1-1/4	WRI-6540
1-5/16	WRI-6542
1-3/8	WRI-6544
1-7/16	WRI-6546
1-1/2	WRI-6548
1-5/8	WRI-6552

# TORQUE WRENCHES

## ATD BRAND

### Micrometer Torque Wrenches

- » Micrometer style clicks and/or releases when preset torque is reached.
- » Hardened steel body, ball bearing construction, easy grip handle.
- » Metric & English settings.
- » Furnished in a blow molded storage case.
- » Complies w/ANSI/ASME, ISO, & Federal specs.

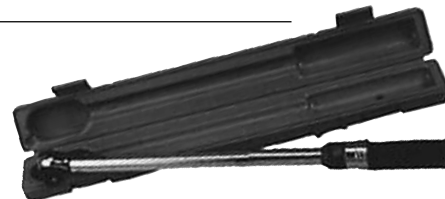

3/8" drive part # ATD-100M

1/2" drive part # ATD-101M

3/4" drive part # ATD-109

# WRIGHT HAND TOOLS

## 1/2" DRIVE IMPACT SOCKETS



WRIGHT TOOL

### 6 Point Standard



**Inch Sizes**

Size	Part #
7/16	WRI-4814
1/2	WRI-4816
9/16	WRI-4818
5/8	WRI-4820
11/16	WRI-4822
3/4	WRI-4824
13/16	WRI-4826
7/8	WRI-4828
15/16	WRI-4830
1"	WRI-4832
1-1/16	WRI-4834
1-1/8	WRI-4836
1-1/4	WRI-4840

**Metric Sizes**

Size	Part #
10 mm	WRI-48-10MM
11 mm	WRI-48-11MM
12 mm	WRI-48-12MM
13 mm	WRI-48-13MM
14 mm	WRI-48-14MM
15 mm	WRI-48-15MM
16 mm	WRI-48-16MM
17 mm	WRI-48-17MM
18 mm	WRI-48-18MM
19 mm	WRI-48-19MM
20 mm	WRI-48-20MM
21 mm	WRI-48-21MM
22 mm	WRI-48-22MM
23 mm	WRI-48-23MM
24 mm	WRI-48-24MM
27 mm	WRI-48-27MM

### 6 Point Deep



**Inch Sizes**

Size	Part #
3/8	WRI-4912
7/16	WRI-4914
1/2	WRI-4916
9/16	WRI-4918
5/8	WRI-4920
11/16	WRI-4922
3/4	WRI-4924
13/16	WRI-4926
7/8	WRI-4928
15/16	WRI-4930
1"	WRI-4932
1-1/16	WRI-4934
1-1/8	WRI-4936
1-1/4	WRI-4940

**Metric Sizes**

Size	Part #
10 mm	WRI-49-10MM
11 mm	WRI-49-11MM
12 mm	WRI-49-12MM
13 mm	WRI-49-13MM
14 mm	WRI-49-14MM
15 mm	WRI-49-15MM
16 mm	WRI-49-16MM
17 mm	WRI-49-17MM
18 mm	WRI-49-18MM
19 mm	WRI-49-19MM
20 mm	WRI-49-20MM
21 mm	WRI-49-21MM
22 mm	WRI-49-22MM
23 mm	WRI-49-23MM
24 mm	WRI-49-24MM
27 mm	WRI-49-27MM

### 11 Piece 6 Point Std Socket Set

Sizes included: 7/16, 1/2, 9/16, 5/8, 11/16, 3/4, 13/16, 7/8, 15/16, 1", 1-1/16



part # WRI-411

### 11 Piece 6 Point Deep Socket Set

Sizes included: 3/8, 7/16, 1/2, 9/16, 5/8, 11/16, 3/4, 13/16, 7/8, 15/16, 1"

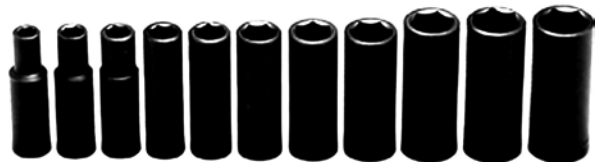

part # WRI-412

### 12 Piece Metric 6 Point Std Socket Set

Sizes included: 10mm, 11mm, 12mm, 13mm, 14mm, 15mm, 16mm, 17mm, 18mm, 19mm, 20mm, 21mm



part # WRI-460

### 12 Piece Metric 6 Point Deep Socket Set

Sizes included: 10mm, 11mm, 12mm, 13mm, 14mm, 15mm, 16mm, 17mm, 18mm, 19mm, 20mm, 21mm



part # WRI-461

# WRIGHT HAND TOOLS

## COMBINATION WRENCHES



### Combination Wrench

#### Inch Sizes

Size	Part #
1/4	WRI-1108
5/16	WRI-1110
3/8	WRI-1112
7/16	WRI-1114
1/2	WRI-1116
9/16	WRI-1118
5/8	WRI-1120
11/16	WRI-1122
3/4	WRI-1124
13/16	WRI-1126
7/8	WRI-1128
15/16	WRI-1130
1"	WRI-1132
1-1/16	WRI-1134
1-1/8	WRI-1136

#### Inch Sizes

Size	Part #
1-3/16	WRI-1138
1-1/4	WRI-1140
1-5/16	WRI-1142
1-3/8	WRI-1144
1-7/16	WRI-1146
1-1/2	WRI-1148
1-5/8	WRI-1152
1-11/16	WRI-1154
1-3/4	WRI-1156
1-13/16	WRI-1158
1-7/8	WRI-1160
2"	WRI-1164



#### Metric Sizes

Size	Part #
6 mm	WRI-11-06MM
7 mm	WRI-11-07MM
8 mm	WRI-11-08MM
9 mm	WRI-11-09MM
10 mm	WRI-11-10MM
11 mm	WRI-11-11MM
12 mm	WRI-11-12MM
13 mm	WRI-11-13MM
14 mm	WRI-11-14MM
15 mm	WRI-11-15MM

#### Metric Sizes

Size	Part #
16 mm	WRI-11-16MM
17 mm	WRI-11-17MM
18 mm	WRI-11-18MM
19 mm	WRI-11-19MM
21 mm	WRI-11-21MM
22 mm	WRI-11-22MM
24 mm	WRI-11-24MM
27 mm	WRI-11-27MM
30 mm	WRI-11-30MM
32 mm	WRI-11-32MM

### 7 Piece 12 Point Combination Wrench Set

#### Sizes included:

1/4, 5/16, 3/8, 7/16, 1/2, 9/16, 5/8



Furnished in a Denim Tool Roll

part # WRI-705

### 15 Piece 12 Point Combination Wrench Set

#### Sizes included:

5/16, 3/8, 7/16, 1/2, 9/16, 5/8, 11/16, 3/4, 13/16, 7/8, 15/16, 1", 1-1/16, 1-1/8, 1-1/4

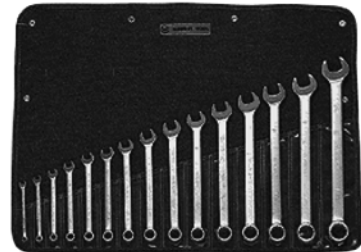

Furnished in a Denim Tool Roll

part # WRI-715

### 11 Piece 12 Point Combination Wrench Set

#### Sizes included:

3/8, 7/16, 1/2, 9/16, 5/8, 11/16, 3/4, 13/16, 7/8, 15/16, 1"



Furnished in a Denim Tool Roll

part # WRI-711

### 11 Piece Metric 12 Point Combination Wrench Set

#### Sizes included:

7mm, 8mm, 9mm, 10mm, 11mm, 12mm, 13mm, 14mm, 15mm, 17mm, 19mm



Furnished in a Denim Tool Roll

part # WRI-750

# WRIGHT HAND TOOLS

## COMBINATION WRENCHES



### 15 Piece Metric 12 Point Combination Wrench Set

**Sizes included:**

7mm, 8mm, 9mm, 10mm, 11mm, 12mm, 13mm, 14mm,  
15mm, 16mm, 17mm, 18mm, 19mm, 21mm, 22mm

Furnished in a Denim  
Tool Roll

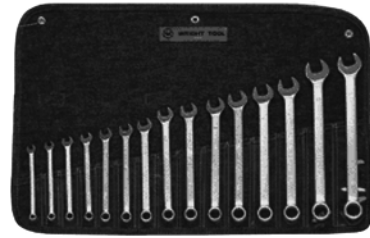

part # WRI-752

## ATD HAND TOOLS

### ADJUSTABLE WRENCHES, PIPE WRENCHES AND C-CLAMPS

#### Adjustable Wrench



6" part # ATD-426  
8" part # ATD-427  
10" part # ATD-428  
12" part # ATD-429

#### Heavy Duty Pipe Wrench



12" part # ATD-612  
14" part # ATD-614  
18" part # ATD-618  
24" part # ATD-624

#### C-Clamps

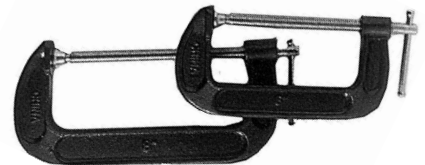

3" part # ATD-5313  
4" part # ATD-5314  
5" part # ATD-5315

## HAND TOOLS

### CHANNELLOCK® AND VISE GRIP PLIERS

#### Tongue and Groove Pliers



- » Design assures, no slip jaw action.
- » Reinforcing edge minimizes stress breakage.

6.5" part # CNL-426  
9.5" part # CNL-420  
10" part # CNL-430  
12" part # CNL-440  
16" part # CNL-460

#### Needle Nose Pliers



- » Perfectly mated cutter, heat treated to hold it's edge.
- » Cross-hatching on jaws grabs work tightly.
- » Distinctive Channellock® blue comfort grips.

6" part # CNL-326  
7.5" part # CNL-317

#### Diagonal Cutting Pliers



- » Precision made of fine polished, high carbon drop forged steel.
- » Perfectly mated cutter, heat treated to hold it's edge.
- » Distinctive Channellock® blue comfort grips.

6" part # CNL-436  
7" part # CNL-337

# HAND TOOLS

## CHANNELLOCK® AND VISE GRIP PLIERS

### End Cutter



- » Precision made of fine polished, high carbon drop forged steel.
- » Perfectly mated cutter, heat treated to hold its edge.
- » Distinctive Channellock® blue comfort grips.

7" part # **CNL-357**

### Lineman's Plier



- » Perfectly mated cutter, heat treated to hold its edge.
- » Polished high carbon drop forged steel.
- » Useful crushing area.
- » Distinctive Channellock® blue comfort grips.

8.5" part # **CNL-348**

### Long Nose Vise Grip



- » For use in narrow spaces.
- » Clamp or tighten bolts or extract items in hard-to-reach places.
- » Ideal for precision work and hobbies.
- » All models feature built-in wire cutter.

4" part # **VSG-4LN**

6" part # **VSG-6LN**

### Straight Jaw Vise Grip

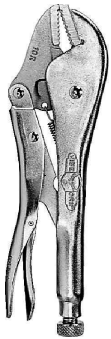

- » Allows for maximum contact on flat, square, or hex work.
- » Popular in welding and other metal work.
- » Use for safer grinding or as a portable vise.

7" part # **VSG-7R**  
10" part # **VSG-10R**

### Curved Jaw Vise Grip

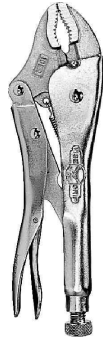

- » Curved jaws provide a better fit around round stock.
- » Use as non-slip pipe wrench, pliers, adjustable wrench, emergency handle, as added leverage to screwdrivers, or as an all-purpose clamp.

10" part # **VSG-10CR**

### Curved Jaw Vise Grip with Wire Cutter



- » Same advantages as the curved jaw style with the added feature of a built-in wire cutter.

5" part # **VSG-5WR**  
7" part # **VSG-7WR**

# HAND TOOLS

## HAMMERS

### Rubber Mallet



1 lb. part # **WRI-9021**

### Brass Hammer



1-1/2 lb. part # **WRI-9028**  
2-1/2 lb. part # **WRI-9029**

### Ball Pein Hammer



8 oz. part # **WRI-9040**  
12 oz. part # **WRI-9041**  
16 oz. part # **WRI-9042**  
20 oz. part # **WRI-9043**  
24 oz. part # **WRI-9044**  
32 oz. part # **WRI-9045**

### Claw Hammer

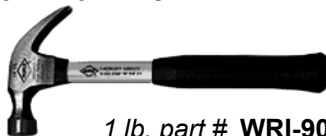

1 lb. part # **WRI-9050**

### Sledge Hammer

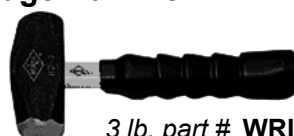

3 lb. part # **WRI-9052**





# WRIGHT HAND TOOLS

## MAYHEW PUNCHES AND CHISELS



### Center Punches

» Made of heat treated metal in the U.S.A.



*3/8" x 5" part # WRI-9538*  
*1/2" x 6" part # WRI-9539*

### Cold Chisel

» Made of heat treated metal in the U.S.A.



*1/4" x 5" part # WRI-9600*  
*5/16" x 5" part # WRI-9601*  
*1/2" x 6" part # WRI-9603*  
*5/8" x 6-1/2" part # WRI-9604*  
*3/4" x 7" part # WRI-9605*  
*7/8" x 7-1/2" part # WRI-9606*

### Starter Punches

» Made of heat treated metal in the U.S.A.



*1/8" x 5" part # WRI-9553*  
*3/16" x 5" part # WRI-9556*  
*1/4" x 5" part # WRI-9557*

### Pilot Punches

» Made of heat treated metal in the U.S.A.



*1/8" part # WRI-9670*  
*5/32" part # WRI-9671*  
*3/16" part # WRI-9672*  
*7/32" part # WRI-9673*  
*1/4" part # WRI-9674*  
*5/16" part # WRI-9675*

### Line-Up Punches

» Made of heat treated metal in the U.S.A.



*1/8" x 8" part # WRI-9581*  
*5/32" x 9" part # WRI-9582*  
*3/16" x 10" part # WRI-9583*  
*1/4" x 12" part # WRI-9584*  
*5/16" x 12" part # WRI-9585*  
*3/8" x 15" part # WRI-9586*

### 6 Piece Punch & Chisel Set



» Made of heat treated metal in the U.S.A.  
» Included:  
2 - Cold Chisels 1/2", 5/8"  
1 - Center Punch  
1 - Starter Punch  
2 - Pin Punches, 1/8", 3/16"

*part # WRI-9660*

### Pin Punches

» Made of heat treated metal in the U.S.A.



*1/8" x 4-3/4" part # WRI-9592*  
*5/32" x 5" part # WRI-9593*  
*3/16" x 5-1/4" part # WRI-9594*  
*1/4" x 5-3/4" part # WRI-9596*  
*5/16" x 6" part # WRI-9597*

### 6 Piece Cold Chisel Set



» Made of heat treated metal in the U.S.A.  
» Included:  
1 - Cold Chisel 1/4" x 5"  
1 - Cold Chisel 5/16" x 5"  
1 - Cold Chisel 3/8" x 5-1/2"  
1 - Cold Chisel 1/2" x 6"  
1 - Cold Chisel 5/8" x 6-1/2"  
Cold Chisel 3/4" x 7"

*part # WRI-9662*



# WRIGHT HAND TOOLS

## MAYHEW PUNCHES AND CHISELS



WRIGHT TOOL

### 14 Piece Mechanics Punch & Chisel Set

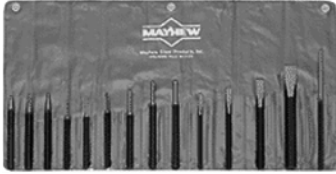

- » Made of heat treated metal in the U.S.A.
- Included:
  - » 1- Cold Chisel 1/4" x 5"
  - 1- Cold Chisel 5/16" x 5"
  - 1- Cold Chisel 3/8" x 5-1/2"
  - 1- Cold Chisel 1/2" x 6"
  - 1- Cold Chisel 5/8" x 6-1/2"
  - 1- Cold Chisel 3/4" x 7"
  - 1- Center Punch 3/8" x 5"
  - 1- Starter Punch 1/8" x 5"
  - 1- Starter Punch 3/16" x 5"
  - 1- Line-up Punch 1/8" x 8"
  - 1- Pin Punch 3/32" x 4-1/2"
  - 1- Pin Punch 1/8" x 4-3/4"
  - 1- Pin Punch 3/16" x 5"
  - 1- Pin Punch 3/16" x 5-1/4"
  - 1- Pin Punch 1/4" x 5-3/4"

part # WRI-9663

### 4 Piece Line-Up Punch Set



- » Made of heat treated metal in the U.S.A.
- » Included:
  - 1- Line-up Punch 1/8" x 8"
  - 1- Line-up Punch 5/32" x 9"
  - 1- Line-up Punch 3/16" x 10"
  - 1- Line-up Punch 1/4" x 12"

part # WRI-9664

### 6 Piece Pilot Punch Set



- » Made of heat treated metal in the U.S.A.
- » Included:
  - 1- Pilot Punch 1/8" # 4
  - 1- Pilot Punch 5/32" # 5
  - 1- Pilot Punch 3/16" # 6
  - 1- Pilot Punch 7/32" # 7
  - 1- Pilot Punch 1/4" # 8
  - 1- Pilot Punch 5/16" # 9

part # WRI-9680

## HAND TOOLS Nicholson® HAND FILES

### Wood File Handle

- » Made from close grain hardwood with nickel-plated ferrules.
- » Wax finish.
- » Handles have strong metal ferrules.

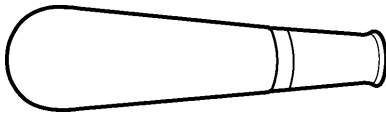

- #3 part # NIC-21522
- #2 part # NIC-21524
- #1 part # NIC-21526
- #0 part # NIC-21528

### Insert-A Grip File Handle

- » Interchangeable cushion inserts designed to fit most popular files for handyman.
- » Handle made of strong high-impact material, contoured to fit hand for straight, lathe and draw filing.
- » Non-slip textured finish for easier grip.

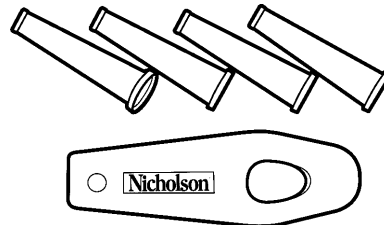

part # NIC-21474

# HAND TOOLS

## Nicholson® HAND FILES

### Half Round Files

- » Used on concave, convex and flat surfaces.
- » Rounded on 1 side, flat on opposite.



10" part # **NIC-21858**  
12" part # **NIC-05090**

### Flat Bastard Files

- » Used by machinists, machinery builders, ship and engine builders, repairman and others who require rapid removal of metal.
- » Rectangular in cross section and taper slightly towards point in width.
- » Double-cut on sides, single-cut on edges.



8" part # **NIC-21862**

### Round Files

- » Used to file circular openings or concave surfaces.
- » Round shape.
- » Tapered slightly towards point.



6" part # **NIC-21846**  
8" part # **NIC-21853**  
10" part # **NIC-21854**  
12" part # **NIC-12134**

### Flat Mill Bastard File

- » Used for sharpening mill or circular saws, and for draw-filing and finishing metals.
- » Rectangular shape.
- » Single-cut on sides and edges.
- » Two square edges.
- » Taper slightly in width.



6" part # **NIC-21825**  
8" part # **NIC-21832**  
10" part # **NIC-21839**  
12" part # **NIC-21842**

### Taper File

- » Triangular shape
- » Edges set and cut for filing gullets between saw teeth.



6" part # **NIC-21866**

### Chain Saw Files

- » Round shape.
- » Smooth-cut.



8" x 3/16" part # **NIC-01765**  
8" x 7/32" part # **NIC-01888**

# HAND TOOLS

## TORCHES & ACCESSORIES

### Propane Torch

- » Legendary Jet Torches feature solid brass construction with a patented jet venturi air intake.
- » This design ensures proper air/fuel mixture providing a hotter flame for faster work with greater fuel economy.



part # TOR100

### Striker

- » Spark without flame.
- » Lights all propane powered appliances.

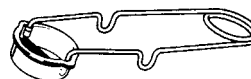

Striker ..... part # TOR105  
Replacement Flint 5/pk ..... part # TOR106

### Self-Igniting Propane Torch

- » Lights with a pull of the trigger.
- » Trigger guard protects against accidental light-ups.
- » Safety trigger lock holds flame for extended periods and prevents accidental lighting.
- » Pressure regulated with pre-set flame.
- » Comfortable "easy grip" handle made of high impact plastic for an ergonomic feel and lasting durability.
- » Stainless steel burn tube with brass tip.
- » Replaceable brass tip for ease of cleaning or repair.
- » 180° swivel tip for easy positioning.
- » Can be used with MAPP® or Propane without changing the orifice.
- » Fits any standard propane or MAPP® cylinder, CGA 600.
- » U.L. Listed.



part # TOR110

### Solder

- » Furnished in 1lb. Rolls

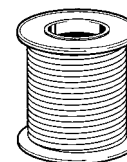

Rosin-Core ..... part # TOR115  
Acid-Core ..... part # TOR116  
40-60 Acid-Core ..... part # TOR117

### Solder Paste

- » Cleans and fluxes.
- » Effective on all metals except aluminum and stainless steel.
- » Lead-Free
- » 1.7 oz. container.



part # TOR120

### Tubing Cutters

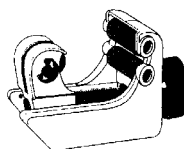

Capacity  
3/16" - 15/16"

part # TOR130

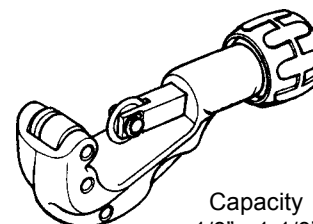

Capacity  
1/8" - 1-1/8"

part # TOR135



### Propane Fuel Cylinder - 14.1 oz.

- » Use with torches and most portable appliances requiring propane fuel.
- » Case contains 12 cylinders.

part # CHE440