



INDUSTRIAL SOLUTIONS

PRODUCT GUIDE

YOU KNOW THE WD-40® BRAND NAME...

BUT DO YOU KNOW ALL IT CAN DO FOR YOUR MRO JOBS?



Our time-tested formulas have been solving problems across a variety of industries for more than 65 years.

From metal fabrication operations to property management, MRO pros can count on WD-40® Brand products to keep their facilities moving with versatile delivery systems that offer a unique combination of safe, powerful and specialized formulas designed to increase efficiency, reduce downtime and minimize risk—everything you need to get the job done right.

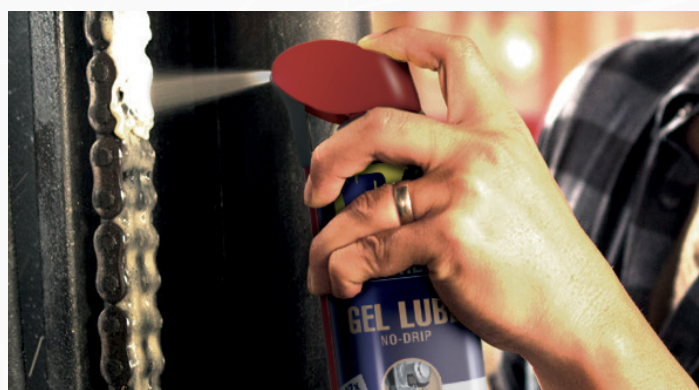

PROVEN AND EFFECTIVE FORMULAS FOR TOUGH ENVIRONMENTS

Lab testing shows that WD-40® Brand products outperform other brands in critical performance tests for dependability and value you can count on.

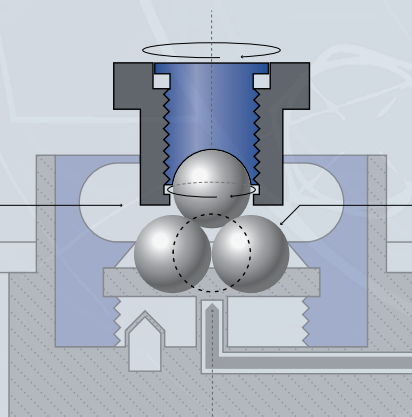

REDUCE DOWNTIME AND PROTECT YOUR FACILITY'S ASSETS

WD-40® Brand products help protect assets to promote longer equipment life, prevent unscheduled downtime due to unexpected equipment failure, and help avoid accidents and injuries caused by poorly maintained equipment.



SAFETY AND COMPLIANCE ARE OUR TOP PRIORITIES

All WD-40® Brand products are formulated to minimize the risk of harm to people, surfaces and the environment.¹ Our safer product formulations do not require warnings for cancer, birth defects or other reproductive harm.² Use of WD-40® Brand products can help reduce personal, legal and regulatory risk.



¹ When used and disposed of as directed.
² No warnings for our products are required by California Proposition 65, the Safe Drinking Water and Toxic Enforcement Act of 1986.



INDUSTRY-LEADING, INNOVATIVE SOLUTIONS MAKE YOUR JOB EASIER

WD-40® Brand has been a trusted name in maintenance products for more than 65 years. We strive to continuously improve and innovate with products designed to tackle any challenge.



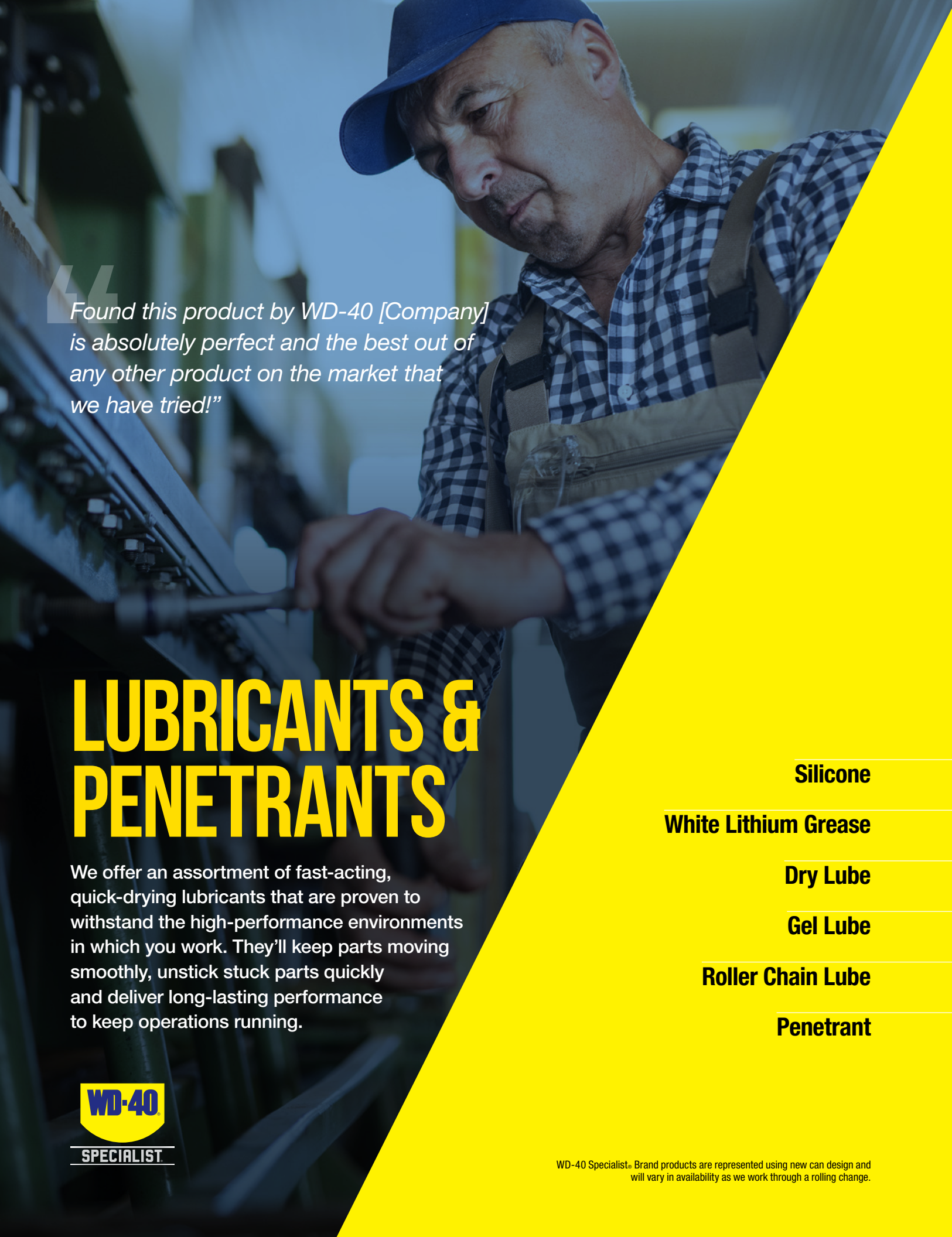

“Found this product by WD-40 [Company] is absolutely perfect and the best out of any other product on the market that we have tried!”

LUBRICANTS & PENETRANTS

We offer an assortment of fast-acting, quick-drying lubricants that are proven to withstand the high-performance environments in which you work. They'll keep parts moving smoothly, unstuck stuck parts quickly and deliver long-lasting performance to keep operations running.

- Silicone
- White Lithium Grease
- Dry Lube
- Gel Lube
- Roller Chain Lube
- Penetrant

WD-40

SPECIALIST

WD-40 Specialist® Brand products are represented using new can design and will vary in availability as we work through a rolling change.



SPECIALIST

SILICONE

It lubricates. It waterproofs. It protects surfaces from residue. What's even better? It dries quickly without leaving stickiness for you to clean.

FEATURES

- Lubricates, waterproofs and protects metal and non-metal surfaces
- Quick-drying with no stickiness or messy residue
- Safe to use on rubber, plastic and vinyl
- NSF Category H2 #146863
- Working temperature range— -100°F to 500°F

APPLICATIONS

Nuts, bolts, pins, screws, bushings, cables, pulleys, sliding mechanisms, valves, linkages, hinges, locks



Providing 5x greater wear protection than the competition, our industrial formula delivers the ultimate lubrication for less frequent reapplications.



4 BALL WEAR TEST

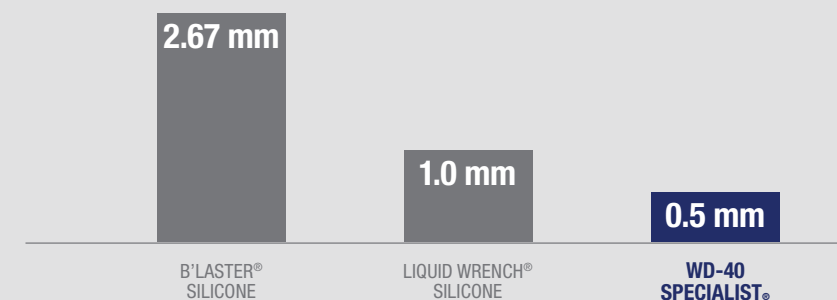

Results show width of scar after 60 minutes at 1200 RPM. Lower number means less scarring and better protection. Test Lab: WD-40 Technical Center (Pine Brook, NJ); ASTM D2266; PB B'laster is a registered trademark of B'laster Chemical Company Inc., AeroKroil is a registered trademark of Kano Laboratories Inc., Knock'er Loose is a registered trademark of CRC Industries Inc; Tested 02/2020.

ITEM #: 30001	NET WEIGHT: 11 OZ.	CASE ORDER #: 300012	CASE UNITS: 6/CASE
---------------	--------------------	----------------------	--------------------



WD-40
SPECIALIST
SILICONE
QUICK-DRYING

- Waterproofs
- Protects Against Rust
- Multi-Surface

DANGER: EXTREMELY FLAMMABLE. HARMFUL OR FATAL IF SWALLOWED. CONTENTS UNDER PRESSURE. Read carefully other cautionary information on back panel.



SPECIALIST.

WHITE LITHIUM GREASE

Have a job that requires heavy-duty lubrication? WD-40 Specialist® White Lithium Grease sprays on evenly as a liquid and sets dry for a thick, protective coating that won't run off, making it a perfect match for metal-to-metal applications.

FEATURES

- Long-lasting lubrication and protection
- Leaves a rust-inhibiting barrier
- Won't freeze, melt or run off
- NSF Category H2 #146864
- Working temperature range—0°F to 300°F

APPLICATIONS

Hinges, chains, linkages, latches, overhead door tracks, pulleys, cables and guide rails, tow bars, gear and brake mechanisms



Withstands up to 64% more pressure than the competition for less frequent reapplication and reduced downtime.



EXTREME PRESSURE TEST

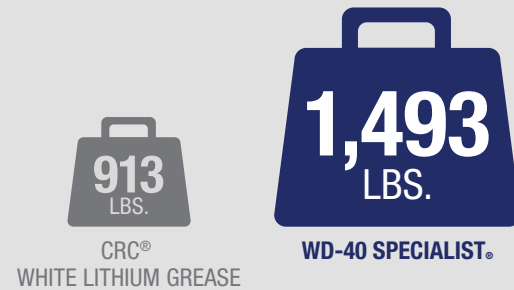

Test measures the load carrying properties of a lubricant.

Test Lab: WD-40 Technical Center (Pine Brook, NJ); ASTM D3233A; CRC is a registered trademark of CRC Industries Inc.; Tested 02/2020.

ITEM #: 30061	NET WEIGHT: 10 OZ.	CASE ORDER #: 300615	CASE UNITS: 6/CASE
---------------	--------------------	----------------------	--------------------



SPECIALIST.

DRY LUBE

Not even the highest temperatures pose a problem with WD-40 Specialist® Dry Lube. Our spray, which is safe on multiple surfaces, reduces friction while providing long-lasting lubrication and corrosion protection. It dries quickly, leaves no oily residue, and resists dirt, dust and oil.

FEATURES

- PTFE formula reduces friction and wear, and enhances performance
- Resists dust, oil and dirt accumulation
- NSF Category H2 #146856
- Working temperature range—-50°F to 500°F

APPLICATIONS

Blades and bits, tracks, slides, pulleys, hinges, machine parts, switches, conveyor belts, rollers, table saws, drills, lathes, and other power tools and equipment

Delivers 4.5x greater protection than the competition for longer lasting lubrication and reduced application frequency.



4 BALL WEAR TEST

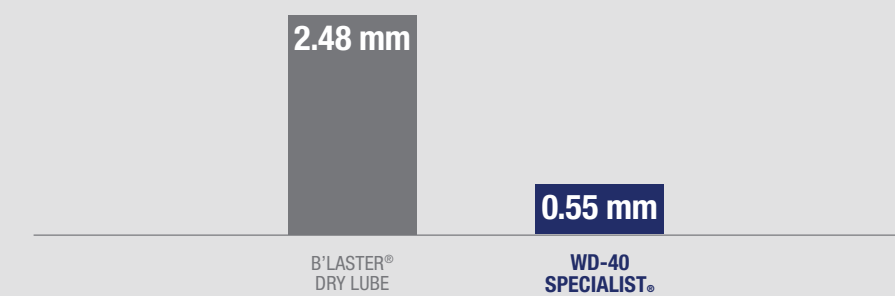

Results show width of scar after 60 minutes at 1200 RPM. Lower number means less scarring and better protection.

Test Lab: WD-40 Technical Center (Pine Brook, NJ); ASTM D2266; PB B'laster is a registered trademark of B'laster Chemical Company Inc.; Tested 05/2020.

ITEM #: 30005	NET WEIGHT: 10 OZ.	CASE ORDER #: 300059	CASE UNITS: 6/CASE
---------------	--------------------	----------------------	--------------------





SPECIALIST.

GEL LUBE

Our unique gel lubricant sprays on thick and won't run, drip or make a mess. The no-drip formula is powerful enough to provide **12x longer-lasting lubrication*** and it also prevents rust and corrosion for up to one year**—creating a more productive and efficient workplace.

FEATURES

- Thick, no drip, no mess, non-fling
- Stays where you spray it; perfect for vertical surfaces
- Self-healing characteristics
- Safe on metals, plastics and rubber
- Working temperature range—
-100°F to 500°F

APPLICATIONS

Chains, cables, gears, rollers, bearings, moving parts, vertical surfaces

Lubricates up to 30x longer than other brands and at a heavier load for less equipment breakdown and reapplication.



LONG-LASTING LUBRICATION TEST



Test measures length of lubrication under pounds of force before breakdown.

Test Lab: Petro-Lubricant Testing Labs (Lafayette, NJ); ASTM D5620; LPS is a registered trademark of Illinois Tool Works Inc., B'laster is a registered trademark of B'laster Chemical Company Inc., TRI-FLOW is a registered trademark of SWIMC LLC; Tested 04/2020

ITEM #: 30010	NET WEIGHT: 10 OZ.	CASE ORDER #: 300103	CASE UNITS: 6/CASE
---------------	--------------------	----------------------	--------------------

* Compared to WD-40® Multi-Use Product using independent lab test ASTM D5620.
** Independent lab tests conducted in humidity chamber. Results vary depending on extreme conditions.



SPECIALIST.

ROLLER CHAIN LUBE

Thickens, repels dirt, stays put—Advanced Ceramic Reinforced lubricant sprays on thin to penetrate deep into the chain and protects it from breaking prematurely. It then thickens to provide proven, long-lasting lubrication.

FEATURES

- Protects chains from premature breakage*
- Repels dirt, displaces contaminants and traps moisture
- Non-fling at high RPM
- Provides long-lasting lubrication
- Working temperature range—
-40°F to 400°F

APPLICATIONS

Chains, sprockets, chain links, O-ring chains

Penetrates inner chain links, O-rings, pins and bushings, and stays in place to protect.

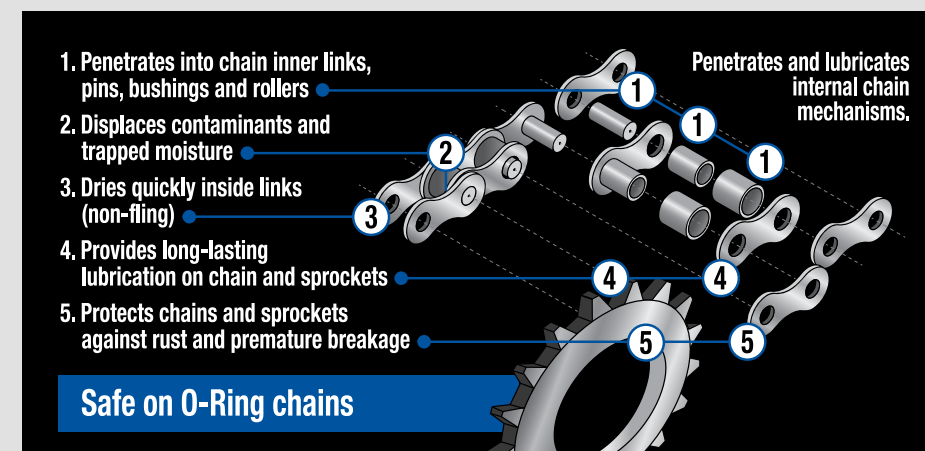

ITEM #: 30049	NET WEIGHT: 10 OZ.	CASE ORDER #: 300493	CASE UNITS: 6/CASE
---------------	--------------------	----------------------	--------------------

* Based on proper chain maintenance extending the life of the chain. Proper maintenance for roller chain is cleaning and lubricating external parts (chains and sprockets), and also the internal parts (chain links).





PENETRANT

AND

PENETRANT WITH FLEXIBLE STRAW

Innovative and proven effective, this rust-busting formula gets into tight crevices, threads, locks, chains and seams to break bonds that hold stuck parts together. To make your job easier, we took it a step further by attaching an eight-inch flexible straw that bends, keeps its shape and sprays two ways, giving you easier access to hard-to-reach spaces.

FEATURES

- Proprietary penetrating formula releases tough rusted parts with minimal effort
- Fast-acting formula penetrates deep into crevices, threads and seams
- Prevents rust and corrosion from re-forming
- Safe on metals, plastics and rubber
- Displaces water better than competitive brands
- Working temperature range—0°F to 400°F

APPLICATIONS

Rusted metal threads, nuts, bolts, pins, screws, bushings, cables, pulleys, sliding mechanisms, valves, linkages, hinges, locks, chains



Penetrates **2x faster** than competitors, which means less downtime and faster return to service.

Provides at least **2x the protection** against rust and corrosion—extending equipment life, increasing maintenance intervals and delivering time- and cost-savings.



NAIL CLIMB TEST

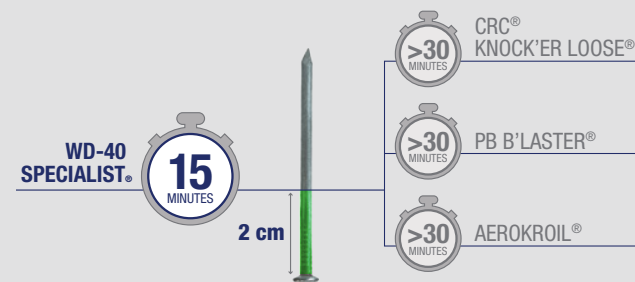

Test measures the penetrating ability of a fluid. The less time to penetrate, the better.

Test Lab: Fred Cuneo (3rd party); Knock'er Loose is a registered trademark of CRC Industries Inc.; PB B'laster is a registered trademark of B'laster Chemical Company Inc.; AeroKroil is a registered trademark of Kano Laboratories Inc.; Tested 02/2020.

SALT SPRAY CORROSION PROTECTION TEST



This test is used to measure the level of corrosion protection provided by a test fluid.

Test Lab: WD-40 Technical Center (Pine Brook, NJ); ASTM B117; PB B'laster is a registered trademark of B'laster Chemical Company Inc.; Tested 03/2020.

PENETRANT

ITEM #: 30000	NET WEIGHT: 11 OZ.
CASE ORDER #: 300004	CASE UNITS: 6/CASE

PENETRANT WITH FLEXIBLE STRAW

ITEM #: 30048	NET WEIGHT: 13.5 OZ..
CASE ORDER #: 300486	CASE UNITS: 6/CASE



- Frees Corroded Nuts+Bolts
- Penetrates Rust
- Works On Contact

DANGER: FLAMMABLE. HARMFUL OR FATAL IF SWALLOWED. CONTENTS UNDER PRESSURE. Read carefully other cautionary information on back panel.

NET WEIGHT 11 OZ./311g

- Penetrates Rust
- Works On Contact

DANGER: FLAMMABLE. HARMFUL OR FATAL IF SWALLOWED. CONTENTS UNDER PRESSURE. Read carefully other cautionary information on back panel.

DID YOU KNOW?

86% of facility professionals state that VOC compliance is an important factor when choosing an MRO product — **100% of WD-40® Brand products are 50-state VOC compliant.**

2018 B2B International Research Report

CLEANERS & DEGREASERS

Engineered to be powerful yet safe, our industrial-strength cleaners and degreasers keep your facilities and equipment running smoother, lasting longer and looking like new.



SPECIALIST

“*Exactly what you need to degrease those hard to reach spots. Eats the grease, and wipes away clean. Excellent, excellent product.*”

Contact Cleaner

Machine & Engine Degreaser

Carb/Throttle Body Cleaner

Degreaser (Aerosol)

Cleaner & Degreaser (Non-Aerosol)

WD-40 Specialist® Brand products are represented using new can design and will vary in availability as we work through a rolling change.



SPECIALIST.

CONTACT CLEANER

With this cleaner, oil, dirt, flux residue and condensation from sensitive electronics and electrical equipment are blasted away with pin-point precision. Our industry-leading Smart Straw® technology makes application accurate. The spray dries quickly, leaving no residue, and removes a wide range of contaminants, making it a top choice among facility professionals.

FEATURES

- Kb cleaning score of 250 vs. mineral spirits (Kb 25)
- Quick-drying with no residue
- Dielectric Strength >20,000 volts
- Safe on all plastics, rubber and metal
- NSF Category K2 #146857

APPLICATIONS

Circuit boards, controls, switches, tape heads, precision instruments, electric panels, generators, electric motors, armatures



Removes more than 98% of common surface contaminants for optimal performance.



REMOVES A WIDE VARIETY OF CONTAMINANTS

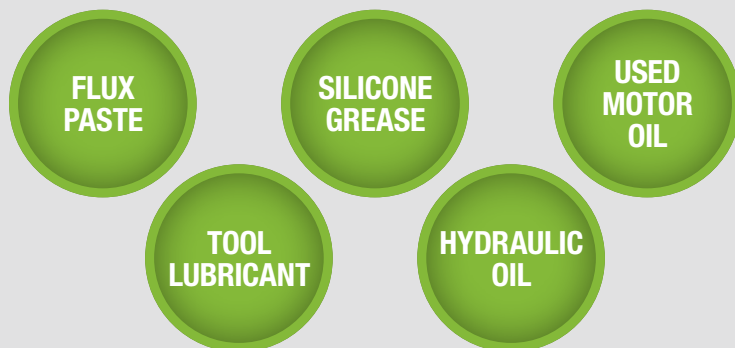

WD-40
SPECIALIST.
CONTACT CLEANER
QUICK-DRYING

Safe On Plastic



- Cleans Sensitive Electrical Parts¹
- Leaves No Residue

DANGER: EXTREMELY FLAMMABLE. HARMFUL OR FATAL IF SWALLOWED. CONTENT UNDER PRESSURE. EYE AND SKIN IRRITANT. Read carefully other cautionary information on back panel.

ITEM #: 30055	NET WEIGHT: 11 OZ.	CASE ORDER #: 300554	CASE UNITS: 6/CASE
---------------	--------------------	----------------------	--------------------



SPECIALIST.

MACHINE & ENGINE DEGREASER



Our water-based aerosol formula provides deep, foaming penetrating action and a powerful stream that sprays up to five feet to quickly and easily remove grease, oil, dirt and grime without the time and trouble of disassembly.

FEATURES

- Low odor, water-based formula
- Deep penetrating foaming action gets into cracks and crevices
- Quickly removes grease, oil, dirt and grime
- No rinsing required; low residue for a clean finish
- NSF Category C1 #146737

APPLICATIONS

Engines, forklifts, gears and chains, industrial machinery, power equipment, metal tools

Up to 25% more cleaning power than competitive brands means your equipment is up and running faster and operating more efficiently.



EXTREME CLEANING SCORE

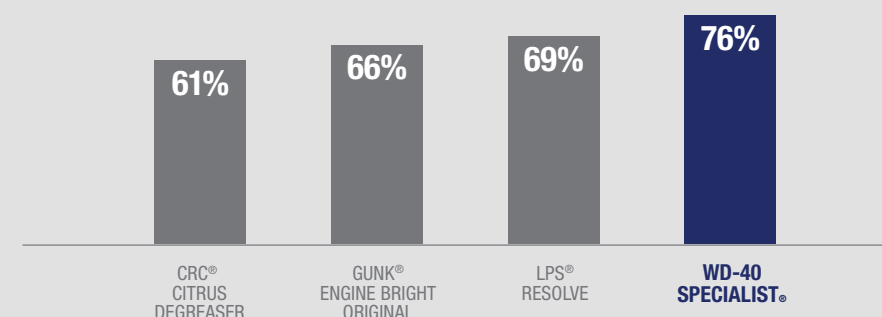

Test evaluates the cleaning ability of a fluid using a mechanical device. Score shows percent of soil removed. Test Lab: Sterling Laboratories (Sylvania, OH). LPS is a registered trademark of LPS Laboratories. Gunk is a registered trademark of Radiator Specialty Company. CRC is a registered trademark of CRC Industries, Inc.; Tested 03/2015.

ITEM #: 30007	NET WEIGHT: 18 OZ.	CASE ORDER #: 300070	CASE UNITS: 4/CASE
---------------	--------------------	----------------------	--------------------



WD-40

SPECIALIST.

MACHINE & ENGINE DEGREASER
FOAMING SPRAY



- Quickly Removes Grease, Oil, Dirt & Grime
- Deep Penetrating Action
- Low Residue



SPECIALIST.

CARB/THROTTLE BODY CLEANER



It's the only all-in-one spray you need to clean your carburetor, throttle body and unpainted metal parts. It is a powerful solvent-based cleaner that blasts away tough carbon deposits, oil and grime with a unique dual-action cleaning system that breaks it up and doesn't leave behind residue.

FEATURES

- Powerful formula breaks up and blasts away tough deposits
- Proven to improve performance at high RPMs
- Reduced splash-back and overspray
- Safe on oxygen sensors or catalytic converters upon incidental contact

APPLICATIONS

Carburetors, throttle body, gas-powered equipment, fleet maintenance, non-painted metal parts

Better engine stability and minimal stalling effects keep your equipment up and running to keep work moving.



STALLING EFFECTS AT HIGH SPEED

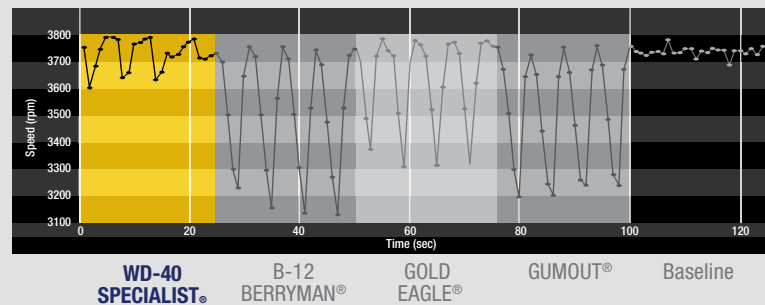

Results show average RPM after products are applied and recorded for standard deviation from the average. Closer to baseline and smaller standard deviation is better as these imply minimal stalling effects.

Test Lab: Intertek Carnot Emission Services (San Antonio, TX). Gold Eagle is a registered trademark of Gold Eagle Company. Berryman is a registered trademark of Berryman Products Inc. Gumout is a registered trademark of ITW Global Brands. Tested 05/2013.

ITEM #: 30013	NET WEIGHT: 13.5 OZ.	CASE ORDER #: 300134	CASE UNITS: 6/CASE
---------------	----------------------	----------------------	--------------------



SPECIALIST.

DEGREASER



A powerful solvent-based degreaser that quickly cleans machinery, engines and equipment to run smooth and look like new. Our fast-acting formula contains **PowerSolve Technology™**—a proprietary solvent that quickly breaks down grease, as well as oil, dirt, tar, adhesives and more.

FEATURES

- Contains fast-acting PowerSolve Technology™
- Safe on metals, plastics, rubber and glass
- High liquid flashpoint of 202°F
- No residue
- Low fumes
- NSF Category K1 #150956

APPLICATIONS

Automotive and truck engines, tire rims, gears and chains, industrial machinery, power equipment, other metal tools

Up to 2x more effective cleaning power than other brands means better product value and faster return to service.

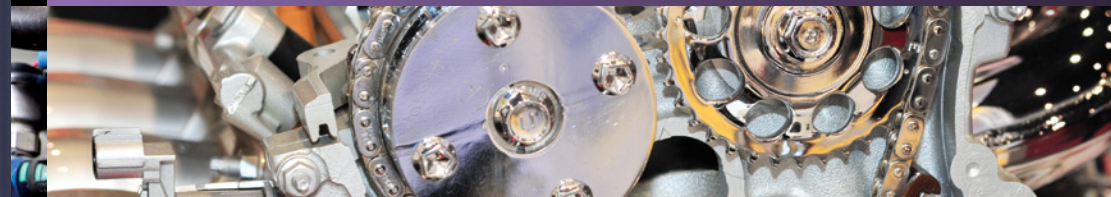

EXTREME CLEANING SCORE

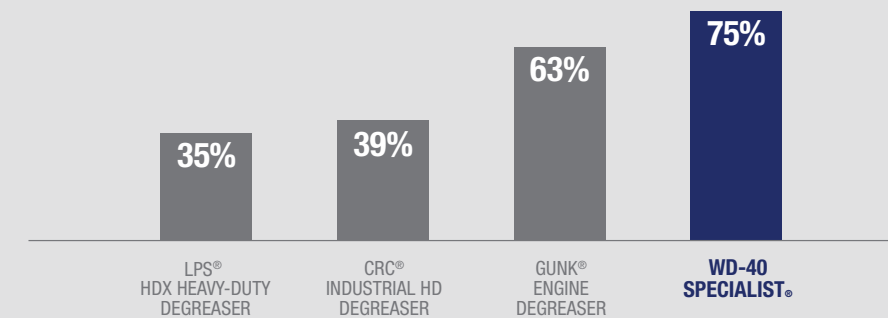

Test evaluates the cleaning ability of a fluid using a mechanical device. Score shows percent of soil removed.

Test Lab: Sterling Laboratories (Sylvania, OH). ZEP is a registered trademark of Zep Inc. LPS is a registered trademark of LPS Laboratories. Gunk is a registered trademark of Radiator Specialty Company. CRC is a registered trademark of CRC Industries, Inc. Tested on 3/6/2015.

ITEM #: 30028	NET WEIGHT: 15 OZ.	CASE ORDER #: 300280	CASE UNITS: 6/CASE
---------------	--------------------	----------------------	--------------------



- Fast Acting
- Multi-Surface
- No Residue



SPECIALIST.

CLEANER & DEGREASER

Engineered and proven to be more powerful and safer than other degreasers on the market, WD-40 Specialist® Cleaner & Degreaser is formulated with a unique bio-solvent that quickly breaks through tough grease and grime, protects against flash rust and is safe for use on sensitive surfaces—meeting the EPA’s Safer Choice Certification criteria for safety and efficacy.

FEATURES

- Formulated with a biodegradable solvent
- Safe for food-processing facilities
- Contains anti-corrosion additives to prevent flash rust
- Non-flammable, non-corrosive and non-abrasive
- Low odor/fragrance-free
- NSF Category A1, A2, A4, A8, B1 #153187



APPLICATIONS

Automotive parts, tools, shop floors, industrial machinery, commercial appliances and equipment, power washers, ultrasonic tool cleaners

Outperforms competitors’ products in surface compatibility tests. Safe for use on common application-sensitive surfaces such as aluminum, fiberglass, chrome and more.



CLEANER & DEGREASER REFILL

ITEM #: 30034	NET WEIGHT: 24 OZ.	CASE ORDER #: 300349	CASE UNITS: 6/CASE
---------------	--------------------	----------------------	--------------------

CLEANER & DEGREASER (32 OZ.)

ITEM #: 30035	NET WEIGHT: 32 OZ.	CASE ORDER #: 300356	CASE UNITS: 6/CASE
---------------	--------------------	----------------------	--------------------

CLEANER & DEGREASER GALLON

ITEM #: 30036	NET WEIGHT: 1 GAL.	CASE ORDER #: 300363	CASE UNITS: 4/CASE
---------------	--------------------	----------------------	--------------------

CLEANER & DEGREASER 5-GALLON

ITEM #: 30047	NET WEIGHT: 5 GAL.
---------------	--------------------

CLEANER & DEGREASER 55-GALLON

ITEM #: 30038	NET WEIGHT: 55 GAL.
---------------	---------------------



“For anyone who hasn’t used this, it is superb for stopping rust on items in high humidity or wet locations. Protects long after many (most) oils have failed.”

RUST MANAGEMENT

Preventing and removing rust is an important part of facility and equipment maintenance, repair and operations. Whether you are looking to prevent or remove rust, we have a product for the job.



Rust Remover Soak
Corrosion Inhibitor

WD-40 Specialist® Brand products are represented using new can design and will vary in availability as we work through a rolling change.



SPECIALIST

RUST REMOVER SOAK

WD-40 Specialist® Rust Remover Soak safely and effectively removes rust without acids or caustic chemicals. This formula is non-toxic, contains no VOCs and works without harming surrounding surfaces. It restores even intricate, hard-to-reach surfaces to clean, bare metal that is ready to paint, and brightens copper, brass and similar alloys.

FEATURES

- Removes rust and other corrosion, but safe for surrounding areas
- No need for scraping, chipping or scrubbing
- All ingredients are biodegradable
- Non-toxic and acid-free
- NSF Category P1 #146753

APPLICATIONS

Tools, metal, cast iron, chrome parts, copper, brass and other alloys



Fast-acting formula removes rust and restores surfaces to bare metal without caustic chemicals or harsh acids with minimal downtime.

SOAK TEST

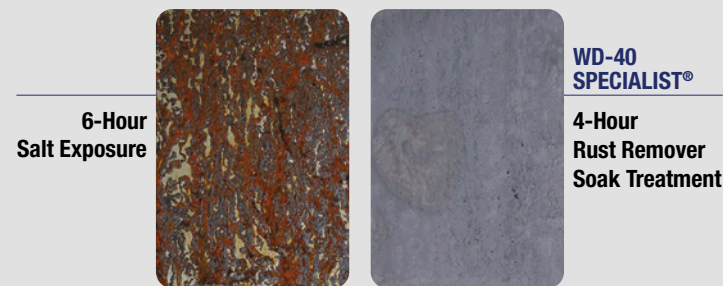

Rusty steel panels are dipped in rust-removing fluid.

Test Labs: Matco Services Inc. (Division of Valmont Industries, Pittsburgh, PA)
The Lubrizol Corporation (Wickliffe, Ohio). Tested on 9/6/2011.

ITEM #: 30004	NET WEIGHT: 1 GAL.	CASE ORDER #: 300042	CASE UNITS: 4/CASE
---------------	--------------------	----------------------	--------------------



SPECIALIST

CORROSION INHIBITOR

Get ahead of the problem with this long-lasting corrosion inhibitor that protects metal parts by blocking rust and corrosion for up to 1 year outdoors or 2 years indoors. Ideal for preventive maintenance applications in challenging environments such as high humidity and long-term storage. The non-drying formula continues to work even if some of the coating gets rubbed off, re-sealing the vulnerable surface.



FEATURES

- Vapor Corrosion Inhibitors seal and protect to block corrosion
- Works indoors and outdoors
- Protects metals up to two years
- NSF Category A7 #146726

APPLICATIONS

Machined surfaces, equipment and metal parts subjected to extended storage periods, tools, chains, cables

Only 5% rust after 1,200 hours of exposure to salt spray, meaning less frequent reapplication for time- and cost-savings, and longer protection of valuable assets.

CORROSION PROTECTION



This test is used to measure the level of corrosion protection of a test fluid under extreme conditions.

Test Lab: Matco Services Inc. (Pittsburgh, PA). B'laster is a registered trademark of B'laster Chemical Company Inc. CRC is a registered trademark of CRC Industries, Inc. Tested on 2/18/2011.

ITEM #: 30003	NET WEIGHT: 6.5 OZ.	CASE ORDER #: 300035	CASE UNITS: 6/CASE
---------------	---------------------	----------------------	--------------------



WD-40
SPECIALIST
CORROSION INHIBITOR
LONG-LASTING

Protects Metal for One Year

- Blocks Rust and Corrosion
- Long-Lasting, Protective Coating for Metals
- Ideal to Use on Equipment Before Storing

HAZARD: EXTREMELY FLAMMABLE. MAY BE HARMFUL IF SWALLOWED OR INHALED. IRRITANT. Read carefully other cautionary information on back panel.

NET WEIGHT 6.5 OZ./184g



“It’s easy to work with, whether hand applying or using a mechanical grease gun. Regardless of the temperature, it can easily be spread but it also doesn’t run—it stays put. So long other grease gun cartridges, I’ll be using WD-40 [Specialist® Greases] from now on.”

GREASES

We provide an assortment of greases that are proven to withstand extreme conditions, allowing you to protect your equipment and get your job done right.

Heavy-Duty Grease

High-Temp Grease

Extreme Pressure Grease

Marine-Grade Grease

WD-40

SPECIALIST

WD-40 Specialist® Brand products are represented using new can design and will vary in availability as we work through a rolling change.



SPECIALIST

HEAVY-DUTY GREASE

WD-40 Specialist® Heavy-Duty Grease is a versatile solution with properties even lithium greases don’t offer. With a dropping point above 650° F, it also provides marine-grade water resistance and protection against rust and corrosion. Engineered for high-speed and heavy-duty applications, Heavy-Duty Grease is an excellent choice for lubricating machinery in damp conditions.

FEATURES

- Withstands extreme temperatures
- Performs under extreme pressure
- Superior water resistance
- Long-lasting corrosion protection

Provides more than **2x the load wear protection** for superior lubrication and longer-lasting performance.



LOAD WEAR TEST



B'LASTER®
PRO GRADE MP GREASE



WD-40 SPECIALIST

Test measures the relative ability of a lubricant to prevent wear under applied loads.

Test Lab: Petro-Lubricant Testing Labs (Lafayette, NJ); ASTM D2596; B'laster is a registered trademark of B'laster Chemical Company Inc.; Tested 03/2020.

ITEM #: 30042	NET WEIGHT: 14 OZ.	CASE ORDER #: 300424	CASE UNITS: 10/CASE
---------------	--------------------	----------------------	---------------------



The Only Grease you'll ever need



SPECIALIST.

HIGH-TEMP GREASE EXTREME PRESSURE GREASE MARINE-GRADE GREASE

The WD-40 Specialist® line of greases gives surfaces the protection they need regardless of the environment. Whether your work involves high temperatures, high pressure or the need for protection from water, you can trust these products to lubricate and protect so you can fight wear and keep your equipment running smoother for longer periods of time.

FEATURES

- Excellent corrosion protection
- Outstanding performance under heavy-metal loads
- 625°F drop point
- Working temperature range— -40°F to 325°F



HIGH-TEMP GREASE

ITEM #: 30039
NET WEIGHT: 14 OZ.
CASE ORDER #: 300394
CASE UNITS: 10/CASE



- High Temperature Lubrication
- Outstanding Performance Under Heavy Mechanical Loads
- Excellent Corrosion Protection

NLGI #2

CAUTION: EYE AND SKIN IRRITANT.
MAY BE HARMFUL IF SWALLOWED.
Read carefully other cautionary information on back panel.
NET WEIGHT 14 OZ./396g
MADE IN USA

FEATURES

- Extreme pressure lubrication
- Outstanding surface protection against heavy load and wear
- 600°F drop point
- Working temperature range— -40°F to 325°F



EXTREME PRESSURE GREASE

ITEM #: 30040
NET WEIGHT: 14 OZ.
CASE ORDER #: 300400
CASE UNITS: 10/CASE



- Extreme Pressure Lubrication
- Outstanding Surface Protection Against Heavy Load & Wear
- Excellent Corrosion Protection

NLGI #2

CAUTION: EYE AND SKIN IRRITANT.
MAY BE HARMFUL IF SWALLOWED.
Read carefully other cautionary information on back panel.
NET WEIGHT 14 OZ./396g
MADE IN USA

FEATURES

- Excellent water wash-out performance
- Maximum lubrication for extreme marine applications
- 620°F drop point
- Working temperature range— -40°F to 325°F



MARINE-GRADE GREASE

ITEM #: 30041
NET WEIGHT: 14 OZ.
CASE ORDER #: 300417
CASE UNITS: 10/CASE



- Excellent Water Wash-Out Performance
- Outstanding Rust & Corrosion Protection
- Maximum Lubrication for Extreme Marine Applications

NLGI #2

CAUTION: EYE AND SKIN IRRITANT.
MAY BE HARMFUL IF SWALLOWED.
Read carefully other cautionary information on back panel.
NET WEIGHT 14 OZ./396g
MADE IN USA

All of our greases deliver up to **25% higher drop point.***

*Compared to conventional lithium-based greases.

DID YOU KNOW?

In 1953, an aerospace contractor first used WD-40® Multi-Use Product to protect the outer skin of the Atlas Missile from rust and corrosion. Today the product has more than 2,000 uses.

WD40company.com



I have used WD-40® [Multi-Use Product] for almost any rusty bolt or squeaky door. With the EZ-REACH® nozzle it now is even easier to reach those tough spots and you don't have to bend and twist all over the place to get to that last bolt."

WD-40® MULTI-USE PRODUCT

The product millions around the world know and trust, with more than 65 years of proven performance and countless applications, this is the essential product for any maintenance environment. It comes in many forms so that you have the best tools to get each job done.



WD-40®
Multi-Use Product

WD-40® Smart Straw®

WD-40® EZ-REACH®

WD-40® Big Blast®

WD-40® Industrial Size

WD-40® Trigger Pro®

WD-40® Gallon

WD-40® 5 Gallon

WD-40® 55 Gallon Drum

WD-40® Spray Applicator



MULTI-USE PRODUCT

WD-40® Multi-Use Product is the most recognized and relied upon name in its class—protecting equipment from rust and corrosion, penetrating stuck parts, displacing moisture and lubricating almost anything. Available in a variety of delivery and application methods, to make any industrial job easier, safer and more efficient.

FEATURES

- Time-saving, easy-to-use
- Patented delivery systems
- Variety of sizes for any job, big or small
- Protects against corrosion
- Penetrates rusted bonds
- Dissolves adhesives and displaces moisture to dry out electrical systems

APPLICATIONS

Moving and rusted metal parts, hinges, wheels, pulleys, rollers, chains, gears, joints, conveyors, hoists, tools and more



One product with **thousands of uses**—protects metal from rust and corrosion, penetrates stuck parts, displaces moisture and lubricates almost anything.



WD-40® MULTI-USE PRODUCT

ITEM #: 49000	NET WEIGHT: 3 OZ.	CASE ORDER #: 490002	CASE UNITS: 12/CASE
---------------	-------------------	----------------------	---------------------

WD-40® SMART STRAW®

ITEM #: 49002	NET WEIGHT: 8 OZ.	CASE ORDER #: 490026	CASE UNITS: 12/CASE
ITEM #: 49004	NET WEIGHT: 11 OZ.	CASE ORDER #: 490040	CASE UNITS: 12/CASE
ITEM #: 49005	NET WEIGHT: 12 OZ.	CASE ORDER #: 490057	CASE UNITS: 12/CASE

WD-40® EZ-REACH®

ITEM #: 49019	NET WEIGHT: 14.4 OZ.	CASE ORDER #: 490194	CASE UNITS: 6 /CASE
---------------	----------------------	----------------------	---------------------

WD-40® BIG BLAST®

ITEM #: 49009	NET WEIGHT: 18 OZ.	CASE ORDER #: 490095	CASE UNITS: 6/CASE
---------------	--------------------	----------------------	--------------------

WD-40® INDUSTRIAL SIZE

ITEM #: 49008	NET WEIGHT: 16 OZ.	CASE ORDER #: 490088	CASE UNITS: 12/CASE
---------------	--------------------	----------------------	---------------------

WD-40® TRIGGER PRO®

ITEM #: 49010	NET WEIGHT: 20 OZ.	CASE ORDER #: 490108	CASE UNITS: 6/CASE
---------------	--------------------	----------------------	--------------------

WD-40® GALLON

ITEM #: 49011	NET WEIGHT: 1 GAL.	CASE ORDER #: 490118	CASE UNITS: 4/CASE
---------------	--------------------	----------------------	--------------------

WD-40® 5-GALLON

ITEM #: 49012	NET WEIGHT: 5 GAL.
---------------	--------------------

WD-40® 55-GALLON

ITEM #: 49013	NET WEIGHT: 55 GAL.
---------------	---------------------

WD-40® SPRAY APPLICATOR

ITEM #: 10000	CASE ORDER #: 10100	CASE UNITS: 4/CASE
---------------	---------------------	--------------------

...AND THAT'S NOT ALL!

Check out some of WD-40 Company's other great products that are made tough enough for your work.

No matter your maintenance need, WD-40 Company has a product to make your day easier—and help protect your facility assets and the bottom line.



3-IN-ONE

3-IN-ONE® MULTI-PURPOSE OIL

ITEM #: 10035	NET WEIGHT: 3 OZ.
CASE ORDER #: 10135	CASE UNITS: 24/CASE

3-IN-ONE® MULTI-PURPOSE OIL

ITEM #: 10038	NET WEIGHT: 8 OZ.
CASE ORDER #: 10138	CASE UNITS: 12/CASE

3-IN-ONE® GARAGE DOOR LUBE

ITEM #: 10058	NET WEIGHT: 11 OZ.
CASE ORDER #: 100581	CASE UNITS: 6/CASE

3-IN-ONE® LOCK DRY LUBE

ITEM #: 12007	NET WEIGHT: 2.5 OZ.
CASE ORDER #: 120077	CASE UNITS: 12/CASE

3-IN-ONE® ALL-TEMP SILICONE DRIP OIL

ITEM #: 12000	NET WEIGHT: 4 OZ.
CASE ORDER #: 120008	CASE UNITS: 12/CASE

3-IN-ONE® FAST-ACTING PENETRANT DRIP OIL

ITEM #: 12001	NET WEIGHT: 4 OZ.
CASE ORDER #: 120015	CASE UNITS: 12/CASE

3-IN-ONE® DRY-TO-TOUCH LUBE DRIP OIL

ITEM #: 12002	NET WEIGHT: 4 OZ.
CASE ORDER #: 120022	CASE UNITS: 12/CASE

3-IN-ONE® MULTI-PURPOSE PTFE LUBE DRIP OIL

ITEM #: 12003	NET WEIGHT: 4 OZ.
CASE ORDER #: 120039	CASE UNITS: 12/CASE

3-IN-ONE® PROFESSIONAL-GRADE PNEUMATIC TOOL DRIP OIL

ITEM #: 12004	NET WEIGHT: 4 OZ.
CASE ORDER #: 120046	CASE UNITS: 12/CASE

3-IN-ONE® LONG-LASTING MOTOR OIL (SAE 20)

ITEM #: 10045	NET WEIGHT: 3 OZ.
CASE ORDER #: 101456	CASE UNITS: 24/CASE

3-IN-ONE® MULTI-PURPOSE OIL LOCKING SPOUT

ITEM #: 10070	NET WEIGHT: 4 OZ.
CASE ORDER #: 100703	CASE UNITS: 12/CASE



LAVA® BAR SOAP

ITEM #: 10085	NET WEIGHT: 5.75 OZ.
CASE ORDER #: 10185	CASE UNITS: 24/CASE

LAVA® BAR SOAP TWIN

ITEM #: 10086	NET WEIGHT: 5.75 OZ.
CASE ORDER #: 10186	CASE UNITS: 12/CASE

LAVA® BAR SOAP INDUSTRIAL

ITEM #: 10083	NET WEIGHT: 4 OZ.
CASE ORDER #: 10383	CASE UNITS: 48/CASE



2000 FLUSHES® CHLORINE AUTOMATIC TOILET BOWL CLEANER

ITEM #: 29007	NET WEIGHT: 1.25 OZ.
CASE ORDER #: 290071	CASE UNITS: 12/CASE

2000 FLUSHES® CHLORINE AUTOMATIC TOILET BOWL CLEANER TWIN PACK

ITEM #: 29008	NET WEIGHT: 2.5 OZ.
CASE ORDER #: 290088	CASE UNITS: 6/CASE

2000 FLUSHES® BLUE PLUS BLEACH

ITEM #: 20801	NET WEIGHT: 3.5 OZ.
CASE ORDER #: 208017	CASE UNITS: 12/CASE

2000 FLUSHES® BLUE PLUS BLEACH TWIN PACK

ITEM #: 20808	NET WEIGHT: 7 OZ.
CASE ORDER #: 208082	CASE UNITS: 6/CASE

2000 FLUSHES® BLUE PLUS DETERGENTS AUTOMATIC TOILET BOWL CLEANER

ITEM #: 20102	NET WEIGHT: 3.5 OZ.
CASE ORDER #: 201020	CASE UNITS: 12/CASE



SPOT SHOT® PROFESSIONAL INSTANT CARPET STAIN REMOVER

ITEM #: 00993	NET WEIGHT: 18 OZ.
CASE ORDER #: 009934	CASE UNITS: 12/CASE

SPOT SHOT® PROFESSIONAL INSTANT CARPET STAIN REMOVER TRIGGER SPRAY

ITEM #: 00972	NET WEIGHT: 32 OZ.
CASE ORDER #: 009729	CASE UNITS: 12/CASE

SPOT SHOT® INSTANT CARPET STAIN & ODOR ELIMINATOR TRIGGER SPRAY (NON-TOXIC & BIODEGRADABLE)

ITEM #: 00971	NET WEIGHT: 22 OZ.
CASE ORDER #: 009716	CASE UNITS: 6/CASE

SPOT SHOT® PET INSTANT CARPET STAIN & ODOR ELIMINATOR (NON-TOXIC)

ITEM #: 00920	NET WEIGHT: 14 OZ.
CASE ORDER #: 009208	CASE UNITS: 6/CASE

SPOT SHOT® PET INSTANT CARPET STAIN & ODOR ELIMINATOR TRIGGER SPRAY (NON-TOXIC)

ITEM #: 09912	NET WEIGHT: 22 OZ.
CASE ORDER #: 099126	CASE UNITS: 6/CASE



X-14® MILDEW STAIN REMOVER

ITEM #: 26001	NET WEIGHT: 16 OZ.
CASE ORDER #: 260749	CASE UNITS: 12/CASE

X-14® MILDEW STAIN REMOVER

ITEM #: 26076	NET WEIGHT: 32 OZ.
CASE ORDER #: 260760	CASE UNITS: 12/CASE

X-14® PROFESSIONAL MILDEW STAIN REMOVER

ITEM #: 26080	NET WEIGHT: 32 OZ.
CASE ORDER #: 260800	CASE UNITS: 12/CASE

X-14® INSTANT MILDEW STAIN REMOVER

ITEM #: 26003	NET WEIGHT: 1 GAL.
CASE ORDER #: 260240	CASE UNITS: 4/CASE

X-14® BLUE PLUS FRAGRANCE AUTOMATIC TOILET BOWL CLEANER

ITEM #: 26801	NET WEIGHT: 1.6 OZ.
CASE ORDER #: 268011	CASE UNITS: 12/CASE

X-14® BLEACH AUTOMATIC TOILET BOWL CLEANER

ITEM #: 26901	NET WEIGHT: 1.7 OZ.
CASE ORDER #: 269070	CASE UNITS: 12/CASE



wd40.com/industrial

WD-40 Company Customer Relations
1-888-324-7596