



**AMERICAN LUBRICATION EQUIPMENT CORPORATION**

**PRODUCT CATALOG V0120**

# CATALOG AT-A-GLANCE



DEF EQUIPMENT

2

10

OIL PUMPS  
& PACKAGES



PORTABLE OIL  
EQUIPMENT

16

20

GREASE PUMPS  
& PACKAGES



DIAPHRAGM  
PUMPS

26

38

DRUM PUMPS



HOSE REELS

40

48

CONTROL  
VALVES



FLUID INVENTORY  
CONTROL SYSTEM

64

66

WASTE OIL  
EQUIPMENT



TANK PACKAGES

74

84

AIR SYSTEM  
COMPONENTS



GREASE GUNS

95

98

GREASE  
FITTINGS



**2****DEF EQUIPMENT**

- 2 Electric Pump Packages
- 4 Air-Operated Pump Packages
- 6 Bare Pumps & Hand-Operated Drum Pumps
- 7 Hose Reel, Meter & Control Handles
- 8 Mounting Brackets, Couplers & Downtubes
- 9 Adapters & Accessories

**10****OIL PUMPS & PACKAGES**

- 10 ARO Thunder Oil Pumps
- 12 ARO 1:1 Transfer Pumps
- 13 Thunder 3:1 Tapper Pumps
- 14 ARO AFX Oil Pumps
- 16 Portable Oil Equipment

**20****GREASE PUMPS & PACKAGES**

- 20 ARO Thunder 50:1 Grease Pumps
- 22 ARO AFX Grease Pumps
- 24 Portable Grease Equipment

**26****DIAPHRAGM PUMPS**

- 27 ARO 3/8" – 2" Diaphragm Pumps
- 28 ARO Diaphragm Drum Pump Packages
- 29 Diaphragm Pump Packages

**31****PUMP ACCESSORIES**

- 31 Connecting Hose & Pressure Relief Kits
- 32 Suction Tubes & Inlet Check Valves
- 33 Bung Adapters & Air Motor Mufflers
- 34 Mounting Brackets, Kits & Siphon Tubes
- 35 Drum Covers & Drum Tie-Down Kits
- 36 Lifts, Follower Plates & Dollies

**37****DRUM ACCESSORIES****38****HAND-OPERATED DRUM PUMPS****40****HOSE REELS**

- 40 Advantage Plus Series
- 42 Advantage<sup>2</sup> Plus Series
- 44 Platinum Series Premium Double-Arm
- 46 Advantage Plus Cabinet Enclosure
- 47 Connecting Hoses & Hose Stops

**48****CONTROL VALVES & METERS**

- 48 Pro Series Digital Control Valves
- 50 Pro Series Mechanical Control Valves
- 52 900 Series Digital Preset Meters
- 54 Mechanical Preset Meters
- 55 In-Line Meters
- 56 760 Series Non-Metered Control Valves
- 58 ARO Non-Metered Control Valves
- 59 Oil Control Valve Accessories
- 60 Grease Control Valves & Swivels
- 61 Grease Couplers & Whip Hoses

**62****OIL BARS & TAPPERS****64****FLUID INVENTORY CONTROL SYSTEMS**

- 64 Fluid Inventory Control System
- 65 Accessories

**66****WASTE OIL EQUIPMENT**

- 66 Self-Evacuating Waste Oil Drains
- 67 24-Gallon Conventional Waste Oil Drain
- 68 Self-Evacuating Waste Oil Extractors
- 69 Polyethylene Drains & Replacement Bowls
- 70 Quick Lube Pit Drain & Waste Oil Packages
- 72 Accessories

**74****TANK PACKAGES**

- 74 Tank Packages
- 76 Tank Specifications
- 78 Roth Tank Packages
- 80 Tote Pumping Systems
- 81 Accessories

**83****QUICK-LUBE EQUIPMENT****84****AIR SYSTEM COMPONENTS**

- 84 Filters, Regulators, & Lubricators
- 86 Air Couplers & Connectors
- 87 Accessories

**88****INSTALLATION ACCESSORIES**

- 88 Shut-Off Valves
- 89 Steel Tubing & Connectors
- 90 Straight, 90° & 45° Union Adapters
- 91 Adapters & Reducing Bushings

**92****HOSES**

- 92 Air & Water Connecting & Delivery Hoses
- 93 Oil Connecting & Delivery Hoses
- 94 Grease Connecting & Delivery Hoses

**95****GREASE GUNS**

- 95 Hand-Operated Grease Guns
- 96 Accessories

**98****GREASE FITTINGS**

- 98 1/8" PTF, 1/4"-28 & 1/4" PTF Fittings
- 99 Stainless Steel & Metric Fittings
- 100 Thread Forming & Drive Type Fittings
- 101 Buttonhead, Vented, Relief & Leakproof Fittings
- 102 Grease Fitting Assortments

**106****WARRANTY**

## ELECTRIC PUMP PACKAGES

PUMP TECHNICAL SPECIFICATIONS		
	120 Volts	12 Volts
Working Flow Rate	9 GPM	9 GPM
Max Fluid Pressure	50 PSI	50 PSI
Watts	400	260
RPM	1400	2800
Voltage	110V/60Hz	12V
Timer	6.5 Minutes	N/A

### All Kits Includes:

- DEF Pump
- 4' Suction Hose
- 20' Delivery Hose
- Hose Tails & Clamps
- Mounting Bracket



DEF3-TM49N  
(tote and dispense coupler not included)

## 120 VOLT TOTE SYSTEMS

	DEF3-TM49N*	DEF3-TM50N	DEF3-TN49N	DEF3-TN50N	DEF3-TM57N
Nozzle	DEF-49	DEF-50	DEF-49	DEF-50	DEF-57-SS
Meter	DEF-22	DEF-22	---	---	DEF-22
Mounting Bracket	DEF3-BKT	DEF3-BKT	DEF3-BKT	DEF3-BKT	DEF3-BKT
Dispense Coupler	---	---	---	---	---

	DEF3-TM49C	DEF3-TM49E	DEF3-TM49S	DEF3-TN50C	DEF3-TM50S	DEF3-TN49S	DEF3-TN58S
Nozzle	DEF-49	DEF-49	DEF-49	DEF-50	DEF-50	DEF-49	DEF-58
Meter	DEF-22	DEF-22	DEF-22	---	DEF-22	---	---
Mounting Bracket	DEF3-BKT	DEF3-BKT	DEF3-BKT	DEF3-BKT	DEF3-BKT	DEF3-BKT	DEF3-BKT
Dispense Coupler	DEF-34PL	DEF-39	DEF-34A	DEF-34PL	DEF-34A	DEF-34A	DEF-34A

## 120 VOLT PORTABLE SYSTEMS (55-GALLON DRUM)

	DEF3-TM49N4	DEF3-TM50N4	DEF3-TN50N4
Nozzle	DEF-49	DEF-50	DEF-50
Meter	DEF-22	DEF-22	---
Mounting Bracket	DEF3-BKT	DEF3-BKT	DEF3-BKT
Heavy-Duty Cart	TIM-401	TIM-401	TIM-401

## 120 VOLT STATIONARY SYSTEMS (55-GALLON DRUM)

	DEF3-DN49N	DEF3-DN50N
Nozzle	DEF-49	DEF-50
Meter	---	---
Mounting Bracket	DEF2-BKT	DEF2-BKT

\* Most Popular



## ELECTRIC PUMP PACKAGES

## 12 VOLT TOTE SYSTEMS

	DEF6-TM49N	DEF6-TN49N	DEF6-TN50N	
Nozzle	DEF-49	DEF-49	DEF-50	
Meter	DEF-22	--	--	
Mounting Bracket	DEF3-BKT	DEF3-BKT	DEF3-BKT	
Dispense Coupler	--	--	--	

	DEF6-TM49C	DEF6-TM49E	DEF6-TM49S	DEF6-TN50C
Nozzle	DEF-49	DEF-49	DEF-49	DEF-50
Meter	DEF-22	DEF-22	DEF-22	--
Mounting Bracket	DEF3-BKT	DEF3-BKT	DEF3-BKT	DEF3-BKT
Dispense Coupler	DEF-34PL	DEF-39	DEF-34A	DEF-34PL

## 12 VOLT PORTABLE SYSTEMS (55-GALLON DRUM)

## DEF6-TM49N4

Nozzle	DEF-49
Meter	DEF-22
Mounting Bracket	DEF3-BKT
Heavy-Duty Cart	TIM-401

## 12 VOLT STATIONARY SYSTEMS (55-GALLON DRUM)

	DEF6-DM49N	DEF6-DN50N
Nozzle	DEF-49	DEF-50
Meter	DEF-22	--
Mounting Bracket	DEF2-BKT	DEF2-BKT



DEF6-TM49N4  
(drum and dispense coupler  
not included)



DEF3-TM49E  
(tote and dispense coupler not included)



DEF3-DN50N  
(drum and dispense coupler not included)

## AIR-OPERATED PUMP PACKAGES



DEF-10  
(tote and dispense coupler not included)

## PUMP TECHNICAL SPECIFICATIONS

ARO PD07P-APS-PAA	
Max Flow Rate	14.8 GPM
Working Flow Rate	6-7 GPM
Air Operating Range	30-50 PSI
Max Fluid Pressure	50 PSI
Air Inlet/Outlet (F)	1/4" NPT
Pump Inlet	3/4" NPT

## All Kits Includes:

- ARO PD07P-APS-PAA 3/4" Diaphragm Pump
- ARO P-39224-624 Filter/Regulator
- 4' Suction Hose
- 20' Delivery Hose
- Hose Tails & Clamps
- Mounting Bracket

	Tote Mount		Portable	
	DEF-10*	DEF-11	DEF-12	DEF-13
Nozzle	---	DEF-49	---	DEF-49
Nozzle w/ Meter	DEF-58	---	DEF-58	---
Mounting Bracket	TIM-463	TIM-463	TIM-463	TIM-463
Heavy-Duty Cart	---	---	TIM-401	TIM-401

\* Most Popular

# ECONOMICAL DEF PUMP

## DURABLE

Ideal to be used on applications with extended run times and frequent stopping and starting

## VERSATILE

Adjustable bung adapter allows pump to be used on 55-gallon drums and 275/330-gallon totes

## CHEMICAL COMPATIBILITY

Polypropylene pump body makes this suitable for DEF, Windshield Washer Solvent and Antifreeze

## FAST

10 GPM flow rate



**DEF-1000**

### Economical DEF Pump

Variable speed 110 volt DEF pump. Includes 16' power cord, 9.8' delivery hose with polyethylene nozzle & 2" buttress / 2" NPT bung adapter

## SPECIFICATIONS

	DEF-1000
Flow Rate	10 GPM
Fluid Outlet Size	3/4" barb
Tube Length	48"
Tube Diameter	2"
Voltage	110 Volts
Used On	55-Gallon Drums & 275/330-Gallon Totes

## FLUID COMPATIBILITY



## BARE ELECTRIC PUMPS

### DEF3A-PUMP

#### 110-Volt Electric Pump with Timer

Includes 6' electric cord. 50.75 PSI (3.5 BAR maximum pressure, 1,400 RPM, 7-9 GPM and 3/4" barbed inlet/outlet.

### DEF6-PUMP

#### 12-Volt Electric Pump

Includes only 6' cables. 2,800 RPM, 18 amp, 7-9 GPM and 3/4" barbed inlet/outlet.



DEF3A-PUMP

## DIAPHRAGM PUMPS

	Body	Ball	Diaphragm & O-Ring	Air Inlet (F)	Inlet/Outlet	Maximum PSI	GPM Max
<b>PD07P-APS-PAA</b>	Polypropylene	Santoprene	Santoprene	1/4"	3/4"	100 PSI	14.8 GPM
<b>PD10P-APS-PAA</b>	Polypropylene	Santoprene	Santoprene	1/4"	1"	120 PSI	53 GPM



PD07P-APS-PAA



PD10P-APS-PAA

## HAND-OPERATED DRUM PUMPS



**4166-DEFN**



**DEF-100AS**



**DEF-100AH**

Container Size	55-Gallon Drums	55-Gallon Drums	55-Gallon Drums
Fluid Compatibility	DEF	DEF	DEF
Downtube Type	Polypropylene	Polypropylene	Polypropylene
Body Material	Polypropylene with Teflon® Seals	Polypropylene with Teflon® Seals	Polypropylene with Teflon® Seals
Pump Type	Rotary	Lever (piston)	Lever (piston)
Delivery	8 Ounces per Revolution	1 Gallon per 10 Strokes	1 Gallon per 10 Strokes
Nozzle	Manual Nozzle	Stainless Steel Spout	Manual Nozzle
Hose Length	9.8'	9.8'	9.8'



## HOSE REEL

### DEF-52H33S

Hose Size	3/4"
Hose Length	33"
Hose Stop	Included
Inlet/Outlet	3/4" barb inlet / 3/4" hose outlet
Maximum PSI	210 PSI
Weight	53 lbs



DEF-52H33S

## METER



### DEF-22

#### Electronic DEF Meter

1" BSP(M) x 1" BSP(M). Measures in gallons, flow rate up to 31 gallons per minute.

## CONTROL HANDLES



### DEF-49

**Stainless Steel Automatic Nozzle**  
(3/4" barb inlet)



### DEF-50

**Polyethylene Manual Nozzle**  
(3/4" barb inlet)



### DEF-57

**Polyethylene Automatic Nozzle**  
with magnetic mis-filling prevention adapter  
(3/4" barb inlet)



### DEF-58

**Polyethylene Automatic Nozzle**  
with built-in digital meter (3/4" barb inlet)

## CONTROL HANDLE ACCESSORIES



### DEF-57A

**Magnetic Mis-filling Adapter**



### DEF-49-SWIVEL

**3/4"(M) Swivel**  
(for DEF-49 only)

**REUSABLE COUPLERS & DOWNTUBES**

<b>DEF-34A</b>	<b>Stainless Steel Dispense Coupler</b> with 3/4" barbed outlet
<b>DEF-34PL</b>	<b>Composite Dispense Coupler</b> with 3/4" barbed outlet
<b>DEF-40A</b>	<b>Stainless Steel Container Valve</b>
<b>DEF-40PL</b>	<b>Composite Container Valve</b>
<b>DEF-41</b>	<b>Container Valve Install/Remove Tool</b>
<b>DEF-54</b>	<b>Vapor Recovery Fill Head Coupler</b> Inlet threads, 1" -11-1/2 NPT (M), Vapor recovery outlet threads, 1/4"-18 NPT (F)
<b>DEF-TUBE55</b>	<b>Downtube for Reusable Container Valves</b> Downtube is universal and must be cut down to length and is suitable for both drums and totes. Cut the end of the tube on an angle to prevent the downtube from sealing itself (via suction) to the drum/tote; Do not straight cut.
<b>DEF-73</b>	<b>Install/Removal Tool</b>



DEF-34A



DEF-34PL



DEF-54



DEF-40A

**ONE-TIME USE COUPLERS & DOWNTUBES**

<b>DEF-39</b>	<b>Dispense Coupler</b> 3/4" barbed outlet
<b>DEF-42</b>	<b>Container Valve</b>
<b>DEF-43</b>	<b>Downtube for 55-Gallon Drum</b>
<b>DEF-44</b>	<b>Downtube for 275-Gallon IBC</b>
<b>DEF-45</b>	<b>Downtube for 330-Gallon IBC</b>



DEF-40PL

**MOUNTING BRACKETS**

<b>DEF2-BKT</b>	<b>Drum Mounting Bracket for Electric DEF Pumps</b>
<b>DEF3-BKT</b>	<b>Tote-Mounting Bracket for Electric DEF Pumps</b>
<b>TIM-463</b>	<b>IBC Tote Bracket for 1/2" &amp; 3/4" ARO Diaphragm Pumps &amp; Electric DEF Pumps</b>



DEF-39



DEF-42



TIM-463

**ADAPTERS**

<b>DEF-25</b>	<b>Plastic Fitting</b> 1"(M) BSP x 3/4"(F) BSP
<b>DEF-55</b>	<b>Plastic Hose Tail Fitting</b> 3/4" barb x 1"(F) BSP
<b>DEF-74</b>	<b>Plastic Hose Tail Fitting</b> 3/4" barb x 1"(M) BSP
<b>DEF-75</b>	<b>Plastic Fitting</b> 90° socket 3/4" barb x 1"(F) BSP
<b>DEF-75BT</b>	<b>Plastic Fitting</b> 3/4" NPT x 3/4" barb
<b>DEF-76</b>	<b>Plastic Fitting</b> 90° socket 1"(F) BSP x 1"(F) BSP
<b>DEF-78</b>	<b>Plastic Fitting</b> 1"(M) BSP with ring nut and nipple x 3/4" barb
<b>DEF-79</b>	<b>Plastic Fitting</b> 1"(M) BSP x 1"(F) BSP
<b>DEF-80</b>	<b>Plastic Fitting</b> 1"(F) BSP x 1"(F) BSP
<b>DEF-81</b>	<b>Plastic Fitting</b> 3/4"(M) BSP x 1"(F) BSP (for auto nozzle)
<b>4190</b>	<b>Nylon Buttress Thread Adapter</b> 2" NPT (F) x 2" buttress (M). Converts 2" buttress thread to 2" NPT



DEF-55



DEF-25



DEF-80



4190

**ACCESSORIES**

<b>DEF-25A</b>	<b>Adapter Kit for DEF-22 Meter with Manual Nozzle</b>
<b>DEF-31</b>	<b>3/4" ID Delivery Hose (Per Foot)</b>
<b>DEF-32</b>	<b>3/4" ID Suction Hose (Per Foot)</b>
<b>DEF-51A</b>	<b>Stainless Steel Hose Clamps for 3/4" Hose (2 Each)</b>
<b>DEF-53A</b>	<b>Adapter Kit for DEF-22 Meter with Automatic Nozzle</b>
<b>DEF-69</b>	<b>6" Center Mount Cap with 2" Buttress Threads</b>
<b>DEF-70</b>	<b>Shipping Cap</b>
<b>DEF-71</b>	<b>Dust Cover</b>
<b>DEF-72</b>	<b>Tamper Wire</b>



DEF-51A



DEF-69

# ARO THUNDER OIL PUMPS



OIL PUMPS & PACKAGES

## RELIABLE DESIGN

Thunder pumps feature a patented, ice-free air motor contained in a rugged housing that is designed to withstand the harshest working environments. ARO is so confident in this design that it is backed by a 5-year warranty

## LUBE-FREE AIR MOTOR

The air valves and the piston are pre-lubricated. Thunder pumps do not require an air line lubricator

## NO MECHANICAL ASSIST

Thunder's patented valve design uses no trip rods, push pins, or springs. Instead of one mechanical pilot valve in the air motor, Thunder has two independent 3-way spool valves which work together to change the direction of the pump piston

## IN-LINE SERVICE

Thunder pumps can be serviced in the tank or drum using just a standard wrench

## FEWER PARTS

Thunder pumps are constructed with 50% fewer parts than the majority of comparable pumps. Fewer parts means less problems

## COST-EFFECTIVE DESIGN

Most competitive pumps are too costly to repair after their warranty expires. Thunder's revolutionary design, inexpensive rebuild kits, and field serviceability all add up to a pump that has the lowest cost of ownership in the lubrication equipment market



LM2203A-11-C



LM2305A-11-B

### 3:1 SPECIFICATIONS

Ratio .....	3:1
Double-Acting .....	Yes
Air Motor Diameter .....	2"
Stroke .....	3"
Air Inlet .....	1/4"(F)
Fluid Outlet .....	1/2"(F)
Fluid Inlet (Stub) .....	3/4"(F)
Free Flow Rating .....	9 Gals/Min
Working Flow Rating .....	6 Gals/Min
Cycles per Gallon .....	37
Noise Level @ 100 PSI .....	80 db
Air Inlet Pressure .....	0 to 150 PSI
Rebuild Kit Part Number .....	637224

### 5:1 SPECIFICATIONS

Ratio .....	5:1
Double-Acting .....	Yes
Air Motor Diameter .....	3"
Stroke .....	3"
Air Inlet .....	1/4"(F)
Fluid Outlet .....	1/2"(F)
Fluid Inlet (Stub) .....	1-1/2"(F)
Free Flow Rating .....	9 Gals/Min
Working Flow Rating .....	6 Gals/Min
Cycles per Gallon .....	28
Noise Level @ 100 PSI .....	85 db
Air Inlet Pressure .....	0 to 150 PSI
Rebuild Kit Part Number .....	637226

### FLUID COMPATIBILITY



Automatic Transmission Fluid



Gear Oil



Hydraulic Oil



Motor Oil



Synthetic Oil



# ARO THUNDER OIL PUMPS



## STUB PUMP MODELS

### 3:1 Pumps

	LM2203A-11-C*	LM-2203A-C*	LM-2203A-H*	LM-2203A-HWM*
Air Coupler	---	210	210	210
Air Connector	---	2608	2608	2608
Air Hose	---	---	AIR-HP1414-3	AIR-HP1414-3
Material Hose	---	---	TIM-4418-4S	TIM-4418-4S
Wall Bracket	---	---	---	TIM-460-A
Suction Hose	---	---	---	TIM-4416-8
Filter/Regulator	---	---	---	P-39224-624

### 5:1 Pumps

	LM2305A-11-B**	LM-2305A-C**	LM-2305A-H**	LM-2305A-HWM**
Air Coupler	---	210	210	23902-210
Air Connector	---	2608	2608	MSCF22-000
Air Hose	---	---	AIR-HP1414-3	AIR-HP1414-3
Material Hose	---	---	TIM-4418-4S	TIM-4418-4S
Wall Bracket	---	---	---	TIM-460-A
Suction Hose	---	---	---	TIM-4416-8
Filter/Regulator	---	---	---	P-39224-624

OIL PUMPS & PACKAGES

## STUB PUMP INSTALLATION PACKAGES

### LM-2203A-COMP\*

#### Complete 3:1 Stub Pump Installation Kit

Includes LM-2203A-H stub pump, P-39224-624 air filter/regulator and gauge, TIM-212-1 nipple, TIM-196-C check valve and TIM-2000-4 pressure relief kit

### LM-2305A-COMP\*\*

#### Complete 5:1 Stub Pump Installation Kit

Includes LM-2305A-H stub pump, P-39224-624 air filter/regulator and gauge, TIM-212-1 nipple, TIM-166-LLC low-level cutoff and TIM-2000-4 pressure relief kit



LM-2305A-COMP

## TANK & DRUM PUMP MODELS

### 3:1 Pumps



LM-2203A-41C

### LM-2203A-31C\*

3:1 Pump for 16-Gallon Drum  
(built-in check valve)

### LM-2203A-41C\*

3:1 Pump for 55-Gallon Drum  
(built-in check valve)

### LM-2203A-51C\*

3:1 Pump for 275-Gallon Obround Horizontal Tank  
(built-in check valve)

### LM-2203AV-61C\*

3:1 Pump for 275-Gallon Obround Vertical Tank  
(built-in check valve)

### 5:1 Pumps



LM-2305A-41B

### LM-2305A-31B\*\*

5:1 Pump for 16-Gallon Drum  
(includes low-level cutoff)

### LM-2305A-41B\*\*

5:1 Pump for 55-Gallon Drum  
(includes low-level cutoff)

### LM-2305A-51B\*\*

5:1 Pump for 275-Gallon Obround Horizontal Tank  
(includes low-level cutoff)

### LM-2305AV-61B\*\*

5:1 Pump for 275-Gallon Obround Vertical Tank  
(includes low-level cutoff)

\* Includes bung adapter 67145-3-B. For weather tight applications, order bung adapter 67088-3 separately.

\*\* Includes bung adapter 67145-4-B. For weather tight applications, order bung adapter 67088-4 separately.



## ARO 1:1 TRANSFER PUMPS

### RELIABLE DESIGN

ARO 1:1 pumps feature a proven design. They are constructed with fewer parts. Fewer parts means less problems

### DOUBLE-ACTING

All ARO 1:1 piston pumps are double-acting, ensuring high flow rates

### LONG STROKE PISTON

Pumps feature a 6" long stroke design to ensure smooth delivery

### DIVORCED DESIGN

These pumps incorporate a divorced design. The air motor is isolated from the lower pumping assembly. This assures that the materials being pumped do not contaminate the air motor

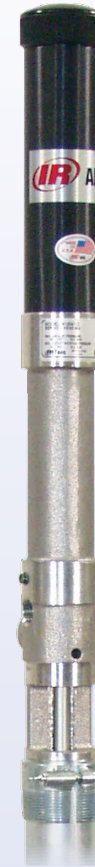

612041-3

OIL PUMPS & PACKAGES

### SPECIFICATIONS

Ratio .....	1:1
Double-Acting .....	Yes
Air Motor Diameter .....	2"
Stroke .....	6"
Air Inlet .....	1/4"(F)
Fluid Outlet .....	3/4"(F)
Pump Style .....	Divorced Design
Free Flow Rating .....	18 Gals/Min
Working Flow Rating .....	9 Gals/Min
Air Inlet Pressure .....	0 to 150 PSI

### REBUILD KIT

Air Motor .....	637084
Fluid Section .....	637083



### 612041-3

**High-Volume Air-Operated Drum Transfer Pump**  
 1:1 pump constructed of carbon steel and aluminum with Teflon® packings. Fits 16-gallon and 55-gallon drums with a 2"(F) opening. Includes air inlet needle valve and 2"(M) bung adapter.

### FLUID COMPATIBILITY



Automatic Transmission Fluid



Gear Oil



Hydraulic Oil



Motor Oil



Solvents\*



Synthetic Oil

\* This pump is compatible with many solvents. Please call American Lubrication for specific solvent compatibility recommendations.

## THUNDER 3:1 TAPPER PUMPS

### VERSATILE

If your customer's needs change, just remove the tapper and the pump can be used for pumping to remote overhead reel applications

### COMPLETE PACKAGES

All tapper pump packages include 3:1 pump, bung adapter, air filter/regulator, air coupler, air connector and tapper valve assembly

### TAPPER

All tapper packages include a rugged, heavy-duty tapper assembly with a splash-reduction adapter. Part number TIM-724-1B (tapper only)



TIM-728-2

OIL PUMPS  
PACKAGES

## STUB PUMP MODEL

**TIM-728-2\***

### Stub Pump Tapper Package

Includes Thunder 3:1 pump, bung adapter, 1/4" nipple, P-39224-624 air filter/regulator/gauge, air coupler, air connector and oil dispensing tapper

## 55-GALLON MODEL

**TIM-726-2\***

### 55-Gallon Tapper Package

Includes Thunder 3:1 pump, bung adapter, downtube, 1/4" nipple, P-39224-624 air filter/regulator/gauge, air coupler, air connector and oil dispensing tapper

## 275-GALLON MODEL

**TIM-727-2\***

### 275-Gallon Tapper Package

Includes Thunder 3:1 pump, bung adapter, downtube, 1/4" nipple, P-39224-624 air filter/regulator/gauge, air coupler, air connector and oil dispensing tapper

## TAPPER KIT

**TIM-724-1B**

Tapper Kit  
1/2"(M) end



TIM-726-2



TIM-724-1B

\* Includes bung adapter 67145-3-B. For weather tight applications, order bung adapter 67088-3 separately.

## ARO AFX OIL PUMPS

### NEW & IMPROVED DESIGN

AFX pumps feature a new innovative and simplistic design with universal parts without sacrificing the reliability of the legacy models

### HEAVY-DUTY CONSTRUCTION

The AFX Series oil pumps are designed for long distance, heavy viscosity oils, industrial installations and cold weather applications

### LUBE-FREE AIR MOTOR

AFX Series air motors are self lubricated and do not require an air line lubricator

### MUFFLER

AFX Series pumps include a muffler which can also be ported to a remote location for quieter operation

### 9:1 & 10:1 RATIO

ARO AFX 4-1/4" oil pumps are ideal in systems requiring long piping runs

### STRESS-FREE PERFORMANCE

4" stroke and easy 19.2 cycles per gallon dispensing rate lead to a long service free pump life



AF0409A13PFL1

OIL PUMPS & PACKAGES

### SPECIFICATIONS

Ratio .....	9:1
Ratio (AF0409C81BBW2) .....	10:1
Double-Acting .....	Yes
Air Motor Diameter .....	4-1/4"
Stroke .....	4"
Air Inlet .....	1/2"
Fluid Outlet .....	3/4"
Fluid Outlet (613100-1) .....	3/8"
Fluid Inlet (Stub) .....	2"(F) or 1-1/2"(M)
Fluid Inlet (613100-1) .....	Barbed
Free Flow Rating .....	18.1 Gals/Min
Working Flow Rating .....	3.9 Gals/Min
Air Inlet Pressure .....	0 to 150 PSI

### 9:1 FLUID COMPATIBILITY



### 9:1 REBUILD KIT

Packing Kit .....	637486
Air Motor Service Kit .....	637489

### 10:1 FLUID COMPATIBILITY



### 10:1 REBUILD KIT

Packing Kit .....	K1875C81BBW2
Air Motor Service Kit .....	637489



## ARO AFX 9:1 OIL PUMPS OIL PUMP MODELS



AF0409A13PFL1

### AF0409A13PFL1\*

9:1 Stub Pump

Order TIM-161 coupler separately to mount pump in tank

### AF0409A53PFL1\*

9:1 Pump for 55-Gallon Drum

(built-in check valve)

## OIL PUMP PACKAGES



### DM0409A53PFL1000\*

55-Gallon Drum Pump Package

Includes AF0409A53PFL1 pump with TIM-4258-5 air hose (5'), TIM-4418-8S material hose (8') and 60869 bung adapter

## ANTIFREEZE PUMP MODEL



### AF0409C81BBW2\*

10:1 Stainless Steel Stub Pump for Antifreeze & Antifreeze Mixtures

Pump has 3/8" hose barbed inlet for easy connection to suction hose.

When using in 55-gallon drum applications, order part number 61139-1 suction tube assembly separately.

\* Order bung adapter 60869 separately

OIL PUMPS  
& PACKAGES

# 55-GALLON AIR-OPERATED OIL DISPENSING CARTS **ARO**

## OPTIONS

55-gallon dispensing carts are available with air-operated oil pumps and diaphragm pumps

## MOBILITY

Heavy-duty three-wheel cart allows drums to be moved with ease on any shop's surface (TIM-401)

## COST EFFECTIVE

Dispensing carts are a lower cost alternative to installing overhead reels



TIM-730  
(container not included)

OIL PUMPS & PACKAGES

	TIM-729	TIM-729-P	TIM-730	NEW TIM-730-P	TIM-732	TIM-733	NEW TIM-733-50
Pump	3:1	3:1	3:1	3:1	1/2" Diaphragm Pump	3:1	3:1
Pump Mounting	Drum Mount	Drum Mount	Cart Mount	Cart Mount	Cart Mount	Drum Mount	Drum Mount
Air Coupler	Included	Included	Included	Included	Included	Included	Included
Filter/Regulator	P-39224-624	P-39224-624	P-39224-624	P-39224-624	P-39224-624	P-39224-624	P-39224-624
Delivery Hose	20'	20'	8'	8'	8'	25' Reel	50' Reel
Control Handle	TIM-601-FM	TIM-900B-1	TIM-601-FM	TIM-900B-1	Non-Metered	TIM-601-FM	TIM-601-FM
Fluid Compatibility	Oil	Oil	Oil	Oil	Oils & Antifreeze	Oil	Oil



TIM-729  
(container not included)



TIM-729-P  
(container not included)



TIM-730  
(container not included)



TIM-732  
(container not included)



TIM-733  
(container not included)

## 16-GALLON AIR-OPERATED OIL DISPENSERS

ARO®

**OPTIONS**

16-gallon air-operated oil dispensers are available with 3:1 or 5:1 pumps, with platform dollies or heavy-duty 3-wheel carts

**MOBILITY**

The dolly or cart option allows kegs to be moved with ease on any shop's surface

**COST EFFECTIVE**

Dispensing carts are a lower cost alternative to installing overhead reels



LP2100-1-ALC  
(container not included)

OIL PUMPS  
& PACKAGES

	LP2100-1-B*	LP2100-1-ALC*	LP3100-1-B*	LP3100-1-ALC*
Pump	3:1	3:1	5:1	5:1
Drum Cover	Included	Included	Included	Included
Meter	Digital Pint	Digital Pint	Digital Pint	Digital Pint
Control Handle	TIM-762-A	TIM-762-A	TIM-762-A	TIM-762-A
Material Hose	6'	6'	6'	6'
Platform Dolly	TIM-352	---	TIM-352	---
Cart	---	TIM-408	---	TIM-408



LP2100-1-ALC  
(container not included)



LP3100-1-B  
(container not included)

\* Order 210 coupler, 2608 connector and P-39224-624 filter/regulator/gauge separately

## SELF-CONTAINED OIL DISPENSERS

### AIR-CHARGED OIL DISPENSER

#### TIM-390-A1

##### Heavy-Duty "Pumpless" Metered Oil Dispenser

24-gallon capacity. Ideal for use as a synthetic oil dispenser. The unit must be filled with oil and then charged to 100 PSI. The air hose can then be disconnected and the unit will dispense oil remotely. Dispenses approximately 8 gallons on the first charge and the remaining 12 gallons on the second charge. Flow rate approximately 2 gallons per minute. Safety pop-off valve prevents over-pressurization. Includes wide-mouth filling funnel (not shown), 2608 air connector, air filter, built-in fluid gauge, 6' discharge hose and a quart digital metered control valve TIM-601-FM.

*Order 210 air coupler separately*



### PORTABLE ELECTRIC OIL TRANSFER PUMP WITH FILTER

#### TIM-307

##### Electric Oil Filter & Oil Transfer Cart

This filter cart is perfect for transferring oil and for decontaminating oil in bulk storage tanks. The oil is extracted using a 6' suction hose with an integrated inlet screen. The extracted oil is filtered through a 10 micron replaceable cartridge filter and then pumped back through a 6' discharge hose that has a 3' extension tube on the end. Unit has a pressure gauge installed on the filter head which indicates when the filter needs to be replaced. Pump requires 115 VAC and is rated at 8 gallons per minute. Replacement filter number TIM-307-FIL.

*Replacement filter TIM-307-FIL can be sold separately for TIM-307*





**GEAR OIL DISPENSERS**



**TIM-60**



**TIM-61**

Container Size	5-Gallon	16-Gallon
Fluid Compatibility	Gear Oil	Gear Oil
Meter	No	No
Accessories	Carrying Handle & Drum Cover	Drum Cover
Hose Length	4'	4'
Nozzle	Goose Neck	Goose Neck

OIL PUMPS & PACKAGES

**16-GALLON HEAVY-DUTY OIL DISPENSERS**

	<b>TIM-62-1A</b>	<b>TIM-62-2</b>	<b>TIM-62-2C</b>	<b>TIM-62-LD2</b>	<b>TIM-63-2</b>
Fluid Compatibility	Gear/Motor/ Synthetic Oils & ATF	Gear/Motor/ Synthetic Oils & ATF	Gear/Motor/ Synthetic Oils & ATF	Gear/Motor/ Synthetic Oils & ATF	Gear Oil
Meter*	No	No	No	No	Digital In-Line Quarts
Accessories	Bare Pump & Bung Adapter Only	Drum Cover & Platform Dolly	Drum Cover & 3-Wheel Cart	Drum Cover	Drum Cover & Platform Dolly
Hose Length	5'	5'	5'	5'	5'
Nozzle	90° Rigid with Manual Non-Drip Tip	90° Rigid with Manual Non-Drip Tip	90° Rigid with Manual Non-Drip Tip	90° Rigid with Manual Non-Drip Tip	90° Rigid with Manual Non-Drip Tip

	<b>TIM-63-2C</b>	<b>TIM-63-LD2</b>	<b>TIM-64-2</b>	<b>TIM-64-2C</b>	<b>TIM-64-LD2</b>
Fluid Compatibility	Gear Oil	Gear Oil	Motor/Synthetic Oils & ATF	Motor/Synthetic Oils & ATF	Motor/Synthetic Oils & ATF
Meter*	Digital In-Line Quarts	Digital In-Line Quarts	Digital In-Line Quarts	Digital In-Line Quarts	Digital In-Line Quarts
Accessories	Drum Cover & 3-Wheel Cart	Drum Cover	Drum Cover & Platform Dolly	Drum Cover & 3-Wheel Cart	Drum Cover
Hose Length	5'	5'	5'	5'	5'
Nozzle	90° Rigid with Manual Non-Drip Tip	90° Rigid with Manual Non-Drip Tip	45° Rigid with Manual Non-Drip Tip	45° Rigid with Manual Non-Drip Tip	45° Rigid with Manual Non-Drip Tip

\* Unit of measure on meter can be set for pints, quarts, liters or gallons.



TIM-62-2C  
(container not included)



TIM-63-2  
(container not included)

# ARO THUNDER 50:1 GREASE PUMPS



## RELIABLE DESIGN

Thunder pumps feature a patented, ice-free air motor contained in a rugged housing that is designed to withstand the harshest working environments. ARO is so confident in this design that it is backed by a 5-year warranty

## PROTECTED INLET TUBE

Thunder grease pumps have 5/16" inlet holes in the sides of the bottom of the pick up tube. This helps eliminate problems caused by sucking plastic grease drum liners into the pump's lower section

## LUBE-FREE AIR MOTOR

The air valves and the piston are pre-lubricated. Thunder pumps do not require an air line lubricator

## NO MECHANICAL ASSIST

Thunder's patented valve design uses no trip rods, push pins, or springs. Instead of one mechanical pilot valve in the air motor, Thunder has two independent 3-way spool valves which work together to change the direction of the pump piston

## IN-LINE SERVICE

Thunder grease pump air motors can be serviced in the drum using just a standard wrench

## FEWER PARTS

Thunder pumps are constructed with 50% fewer parts than the majority of comparable pumps. Fewer parts means less problems

## COST-EFFECTIVE DESIGN

Most competitive pumps are too costly to repair after their warranty expires. Thunder's revolutionary design, inexpensive rebuild kits, and field serviceability all add up to a pump that has the lowest cost of ownership in the lubrication equipment market

## GREASE COMPATIBILITY

Thunder pumps are compatible with NLGI 0, NLGI 1, NLGI 2 and NLGI 3 grease



GREASE PUMPS & PACKAGES

### 2" SPECIFICATIONS

Ratio .....	50:1
Double-Acting .....	Yes
Air Motor Diameter .....	2"
Stroke .....	3"
Air Inlet .....	1/4"
Material Outlet .....	3/8"
Free Flow Rating .....	9 lbs/Min
Working Flow Rating .....	2 lbs/Min
Noise Level @ 100 PSI .....	85 db
Air Inlet Pressure .....	0 to 150 PSI
Rebuild Kit Part Number .....	637332

### 3" SPECIFICATIONS

Ratio .....	50:1
Double-Acting .....	Yes
Air Motor Diameter .....	3"
Stroke .....	3"
Air Inlet .....	1/4"
Material Outlet .....	3/8"
Free Flow Rating .....	7.5 lbs/Min
Working Flow Rating .....	4 lbs/Min
Noise Level @ 100 PSI .....	85 db
Air Inlet Pressure .....	0 to 150 PSI
Rebuild Kit Part Number .....	637227-B

## BARE PUMP MODELS

- LM2250E-21-B\*** 2" 50:1 Grease Pump for 35-Pound Container
- LM2250E-31-B\*** 2" 50:1 Grease Pump for 120-Pound Container
- LM2350E-21-B\*** 3" 50:1 Grease Pump for 35-Pound Container
- LM2350E-31-B\*** 3" 50:1 Grease Pump for 120-Pound Container
- LM2350E-41-B\*** 3" 50:1 Grease Pump for 400-Pound Container

\* All pumps include bung adapter 67145-2. For weather tight applications, order seal kit 67088 separately. Order 210 coupler, 2608 connector and P-39224-624 filter/regulator/gauge separately.



LM2250E-31-B

**ARO THUNDER 50:1 GREASE PUMPS**



**STATIONARY PUMP PACKAGES**

**2" Diameter Air Motor**

	Size	Bare Pump	Drum Cover	Follower Plate	Material Hose	Air Hose	Z-Swivel	Control Handle
<b>LP2001-1-B*</b>	35-lb	LM2250E-21-B	TIM-367-1	TIM-368	---	---	---	---
<b>LP2003-1-B*</b>	120-lb	LM2250E-31-B	TIM-451-1	TIM-366	TIM-4516-4	AIR-HP1414-3	---	---
<b>LP2004-1-B*</b>	120-lb	LM2250E-31-B	TIM-451-1	TIM-366	TIM-4514-10	---	TIM-111-1	TIM-794

**3" Diameter Air Motor**

	Size	Bare Pump	Drum Cover	Follower Plate	Material Hose	Air Hose	Z-Swivel	Control Handle
<b>LP3002-1*</b>	120-lb	LM2350E-31-B	TIM-451-1	TIM-366	TIM-4516-4	AIR-HP1414-3	---	---
<b>LP3005-1*</b>	400-lb	LM2350E-41-B	TIM-369	---	TIM-4516-4	AIR-HP1414-3	---	---
<b>LP3008-1*</b>	35-lb	LM2350E-21-B	TIM-367-1	TIM-368	TIM-4514-10	---	---	---
<b>LP3009-1*</b>	400-lb	LM2350E-41-B	TIM-369	TIM-640015-1	TIM-4516-4	AIR-HP1414-3	---	---

**PORTABLE GREASE PUMP PACKAGES**

**2" Diameter Air Motor**

	Size	Bare Pump	Drum Cover	Follower Plate	Material Hose	Z-Swivel	Control Handle	Dolly/Cart
<b>LP2002-1-B*</b>	35-lb	LM2250E-21-B	TIM-367-1	TIM-368	TIM-4514-10	TIM-111-1	TIM-794	---
<b>LP2006-1-B*</b>	120-lb	LM2250E-31-B	TIM-451-1	TIM-366	TIM-4514-10	TIM-111-1	TIM-794	TIM-358
<b>LP2006-1-ALC*</b>	120-lb	LM2250E-31-B	TIM-451-1	TIM-366	TIM-4514-10	TIM-111-1	TIM-794	TIM-408

**3" Diameter Air Motor**

	Size	Bare Pump	Drum Cover	Follower Plate	Material Hose	Z-Swivel	Control Handle	Dolly/Cart
<b>LP3001-1*</b>	35-lb	LM2350E-21-B	TIM-367-1	TIM-368	TIM-4514-10	TIM-111-1	TIM-794	---
<b>LP3003-1*</b>	120-lb	LM2350E-31-B	TIM-451-1	TIM-366	TIM-4514-10	TIM-111-1	TIM-795-1	TIM-358
<b>LP3004-1*</b>	120-lb	LM2350E-31-B	TIM-451-1	TIM-366	TIM-4514-10	TIM-111-1	TIM-794	TIM-358
<b>LP3004-1-ALC*</b>	120-lb	LM2350E-31-B	TIM-451-1	TIM-366	TIM-4514-10	TIM-111-1	TIM-794	TIM-408
<b>LP3005-1-ALC*</b>	400-lb	LM2350E-41-B	TIM-369	TIM-640015-1	TIM-4514-10	TIM-111-1	TIM-794	TIM-401
<b>LP3005-1-50R</b>	400-lb	LM2350E-41B	TIM-369	TIM-640015-1	50' Reel	TIM-113	TIM-794	TIM-401

\* All pumps include bung adaptor 67145-2. For weather tight applications, order seal kit 67088 separately. Order 210 coupler, 2608 connector and P-39224-624 filter/regulator/gauge separately.



LP2002-1-B  
(container not included)

LP2004-1-B  
(container not included)

LP2006-1-B  
(container not included)

LP3005-1-ALC  
(container not included)

LP3005-1-50R  
(container not included)

## ARO AFX GREASE PUMPS



### NEW & IMPROVED DESIGN

AFX pumps feature a new innovative and simplistic design with universal parts without sacrificing the reliability of the legacy models

### HEAVY-DUTY CONSTRUCTION

The AFX Series oil pumps are designed for long distance, heavy viscosity oils, industrial installations and cold weather applications

### LUBE-FREE AIR MOTOR

AFX Series air motors are self lubricated and do not require an air line lubricator

### MUFFLER

AFX Series pumps include a muffler which can also be ported to a remote location for quieter operation

### GREASE COMPATIBILITY

AFX grease pumps are compatible with NLGI 0, NLGI 1, NLGI 2 and NLGI 3 greases

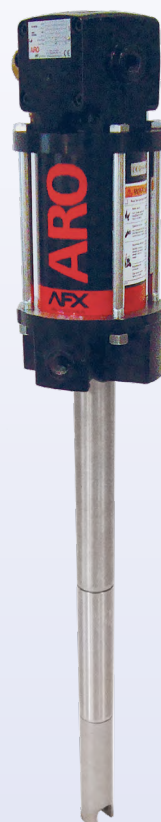

AF0450L43PKL1

### 4-1/4" SPECIFICATIONS

Ratio .....	50:1
Double-Acting .....	Yes
Air Motor Diameter .....	4-1/4"
Stroke .....	4"
Air Inlet .....	1/2"(F)
Material Outlet .....	1/2"(F)
Max Delivery .....	6 lbs
Air Inlet Pressure .....	0 to 150 PSI

### 4-1/4" REBUILD KIT

Packing Kit .....	637485
Air Motor Only .....	637489

### 4-1/4" ACCESSORIES

Follower Plate 120-Pound .....	TIM-363
Follower Plate 400-Pound .....	TIM-364
Drum Cover 120-Pound .....	66492
Drum Cover 400-Pound .....	60898
Bung Adapter .....	4148

### 6" SPECIFICATIONS

Ratio .....	100:1
Double-Acting .....	Yes
Air Motor Diameter .....	6"
Stroke .....	4"
Air Inlet .....	1/2"(F)
Material Outlet .....	1/2"(F)
Free Flow Rating .....	2.1 lbs/Min
Max Delivery .....	2.1 lbs
Air Inlet Pressure .....	0 to 150 PSI

### 6" REBUILD KIT

Air Motor Service Kit .....	637489
Packing Kit .....	65130

### 6" ACCESSORIES

Integrated Ball Valve Regulator .....	67442
Follower Plate 120-Pound .....	640152-1
Follower Plate 400-Pound .....	640015-5
Drum Cover 120-Pound .....	66715
Drum Cover 400-Pound .....	71060-AL
Bung Adapter .....	4148

GREASE PUMPS & PACKAGES

# ARO AFX GREASE PUMPS



## BARE PUMP MODELS

### 4-1/4" Diameter Air Motor Type

**AF0450L43PKL1 ‡** 4-1/4" 50:1 Grease Pump for 120-Pound Container

**AF0450L53PKL1 ‡** 4-1/4" 50:1 Grease Pump for 400-Pound Container

### 6" Diameter Air Motor Type

**AF060BL43PKL1 \*\*** 6" 100:1 Grease Pump for 120-Pound Container

**AF060BL53PKL1 \*\*** 6" 100:1 Grease Pump for 400-Pound Container

‡ Order 4148 bung adapter separately

\*\* Order 60870 bung adapter separately



AF0450L43PKL1

GREASE PUMPS & PACKAGES

## PUMP PACKAGES

### 4-1/4" Diameter Air Motor

	DM0450L53PKL1000	DC0450L53PKL1000
Size	400-Pound	400-Pound
Bare Pump	AF0450L53PKL1	AF0450L53PKL1
Drum Cover	---	60898
Follower Plate	---	---
Material Hose	TIM-4516-8	TIM-4516-8
Air Hose	TIM-4258-5	TIM-4258-5
Bung Adapter	4148	4148

### 6" Diameter Air Motor

	DC060BL53PKL1C11
Size	400-Pound
Bare Pump	AF60BL53PKL1
Drum Cover	71060-AL
Follower Plate	640015-5
Material Hose	---
Air Hose	---
Bung Adapter	60870

\*\* Order 60870 bung adapter separately



DC0450L53PKL1000



## WARNING

ARO 6" 100:1 pumps deliver pressures up to 10,000 PSI which is in excess of the rated capacity of the accessories shown in this catalog. These 100:1 pumps can only be used in permanently installed systems where the pump is connected directly to piping with a proper rating for the application.



## GREASE FILLER PUMP



### TIM-80

#### 35-Pound Hand-Operated Grease Filler Pump

Ideal for filling hand grease guns. Includes follower plate, drum cover and loader valve which is compatible with the TIM-23 grease gun loader fitting.

*Container not included.*

## 35-POUND HAND-OPERATED GREASE PUMP



### TIM-83-KM

#### 35-Pound Hand-Operated Grease Pump

Delivers up to 5,000 PSI. Includes drum cover, tapered follower plate, 1/4" x 5' delivery hose, narrow diameter grease coupler and carrying handle.

## WHEEL BEARING PACKER



### TIM-66-A

#### Drum-Mounted Wheel Bearing Packer with Pump

Mounts directly to 25-pound to 50-pound standard grease containers. Ideal for packing several bearings in a short amount of time. For all car, boat, trailer and RV bearings having an ID of 1/2" to 5", and a height of 1/4" to 2". Rugged steel construction.

*Container not included.*

## 35-POUND GREASE PACKAGES

### 2" Diameter Air Motor

#### LP2002-1-B\*

#### 35-Pound Grease Package

Includes LM2250E-21-B pump, TIM-367-1 drum cover with carry handle, TIM-368 follower plate, TIM-4514-10 10' material hose, TIM-111-1 Z-swivel and TIM-794 control handle

\* Order 210 coupler, 2608 connector and P-39224-624 filter/regulator/gauge separately

### 3" Diameter Air Motor

#### LP3001-1\*

#### 35-Pound Grease Package

Includes LM2350E-21-B pump, TIM-367-1 drum cover with carry handle, TIM-368 follower plate, TIM-4514-10 10' material hose, TIM-111-1 Z-swivel and TIM-795-1 control handle

\* Order 210 coupler, 2608 connector and P-39224-624 filter/regulator/gauge separately



LP2002-1-B  
(container not included)

## 120-POUND GREASE PACKAGES

### 2" Diameter Air Motor

#### LP2006-1-B\*

#### 120-Pound Grease Package

Includes LM2250E-31-B pump, TIM-451-1 drum cover, TIM-366 follower plate, TIM-4514-10 10' material hose, TIM-111-1 Z-swivel, TIM-794 control handle and TIM-358 band dolly

#### LP2006-1-ALC\*

#### 120-Pound Grease Package

Includes LM2250E-31-B pump, TIM-451-1 drum cover, TIM-366 follower plate, TIM-4514-10 10' material hose, TIM-111-1 Z-swivel, TIM-794 control handle and TIM-408 heavy-duty 3-wheel cart

\* Order 210 coupler, 2608 connector and P-39224-624 filter/regulator/gauge separately

### 3" Diameter Air Motor

#### LP3004-1\*

#### 120-Pound Grease Package

Includes LM2350E-31-B pump, TIM-451-1 drum cover, TIM-366 follower plate, TIM-4514-10 10' material hose, TIM-111-1 Z-swivel, TIM-794 control handle and TIM-358 band dolly

#### LP3004-1-ALC\*

#### 120-Pound Grease Package

Includes LM2350E-31-B pump, TIM-451-1 drum cover, TIM-366 follower plate, TIM-4514-10 10' material hose, TIM-111-1 Z-swivel, TIM-794 control handle and TIM-408 heavy-duty 3-wheel cart

\* Order 210 coupler, 2608 connector and P-39224-624 filter/regulator/gauge separately



LP2006-1-ALC  
(container not included)



LP3004-1  
(container not included)

## 400-POUND GREASE PACKAGE

### 3" Diameter Air Motor

#### LP3005-1-50R

#### Portable Grease Pump Package for 400-Pound Drum

Includes 50:1 ratio pump with 3" air motor, air coupler, air connector, air filter/regulator with gauge, drum cover, follower plate, material coupler, material connector, 3/8" x 50' grease reel package, 4' material connecting hose, Z swivel, control handle and heavy-duty three-wheel cart.



LP3005-1-50R  
(container not included)

GREASE PUMPS & PACKAGES

## ARO 3/8" - 2" DIAPHRAGM PUMPS

### PATENTED AIR VALVE

ARO's patented "unbalanced" air valve design eliminates stalling, a common occurrence in competitive pumps

### HI-FLOW

These pumps offer high-volume delivery of material even at low air pressures

### RUNS DRY

ARO diaphragm pumps can run dry without any damage to the pump

### BOLTED CONSTRUCTION

Pumps feature bolted construction to avoid the proven problems created by band clamp type pump fasteners

### LUBE-FREE AIR MOTOR

ARO diaphragm pumps are pre-lubricated. They do not require an air lubricator, eliminating maintenance concerns. *(The use of a lubricator is not recommended.)*

### VARIABLE FLOW RATE

Adjusting the air pressure to the pump allows precise control over the pump's flow rate without damaging the pump

### SIMPLE DESIGN

Provides trouble-free operation and virtually maintenance-free performance

### VARIETY\*

ARO diaphragm pumps are available in metallic and composite bodies, single and multiple-port designs, and many different ball, seat, and diaphragm configurations to suit your application



PD03P-ARS-PAA



666100-3C9-C



66605J-322



PD20A-AAP-GGG-B

DIAPHRAGM PUMPS

### FLUID COMPATIBILITY



Antifreeze



Automatic Transmission Fluid



Gear Oil



Hydraulic Oil



Motor Oil



Synthetic Oil



Waste Oil



Windshield Washer Fluid

### "UNSTALLABLE" AIR VALVE

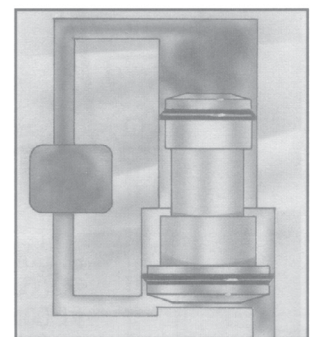
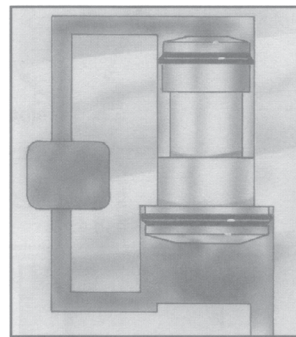

ARO's patented "unbalanced" major air valve has constant air pressure applied to its small end. This assures that the pump resets. Competitive designs lose their signal during every shift, making them vulnerable to stalling. To reverse the valve, air pressure is supplied to the larger end of the valve, allowing the valve to shift – note that constant air pressure continues to be applied to the small end.

\* ARO has a complete line of diaphragm pumps to handle most product pumping applications. Please call American Lubrication at 410-252-9300 for recommendations on fluids not listed above.

### 3/8" DIAPHRAGM PUMP

	Ball	Diaphragm & O-Ring	Body	Air Inlet (F)	Material Inlet & Outlet (F)	Maximum PSI	GPM Max
<b>PD03P-ARS-PAA</b>	Santoprene	Santoprene	Polypropylene	1/4"	3/8"	100 PSI	10.6 GPM

### 1/2" DIAPHRAGM PUMPS

	Ball	Diaphragm & O-Ring	Body	Air Inlet (F)	Material Inlet & Outlet (F)	Maximum PSI	GPM Max
<b>66605J-322*‡</b>	Nitrile	Nitrile	Polypropylene	1/4"	1/2"	100 PSI	13 GPM
<b>66605J-344*</b>	Teflon®	Teflon®	Polypropylene	1/4"	1/2"	100 PSI	13 GPM
<b>PD05P-AAS-PGG*</b>	Nitrile	Nitrile	Aluminum	1/4"	1/2"	100 PSI	13 GPM

\* Not recommended for oil use in a "closed" system (where the pump remains pressurized when not in use) without thermal relief kit model number TIM-RELIEF-KIT

‡ Use for antifreeze and windshield washer fluid

### 1" DIAPHRAGM PUMPS

	Ball	Diaphragm & O-Ring	Body	Air Inlet (F)	Material Inlet & Outlet (F)	Maximum PSI	GPM Max
<b>666100-344-C*</b>	Teflon®	Teflon®	Aluminum	1/4"	1"	120 PSI	35 GPM
<b>666100-362-C*‡</b>	Acetal	Nitrile	Aluminum	1/4"	1"	120 PSI	35 GPM
<b>666100-3C9-C*</b>	Hytrel®	Hytrel®	Aluminum	1/4"	1"	120 PSI	35 GPM

\* Not recommended for oil use in a "closed" system (where the pump remains pressurized when not in use) without thermal relief kit model number TIM-RELIEF-KIT

‡ Use for waste oil applications

### 1" 50/50 ANTIFREEZE/WATER BLENDING PUMP

	Ball	Diaphragm & O-Ring	Body	Air Inlet (F)	Material Inlet (F)	Material Outlet (F)	Maximum PSI	GPM Max
<b>650715-C</b>	Acetal	Nitrile	Aluminum	1/2"	1-1/2"	1"	120 PSI	35 GPM

### 1-1/2" DIAPHRAGM PUMP

	Ball	Diaphragm & O-Ring	Body	Air Inlet (F)	Material Inlet & Outlet (F)	Maximum PSI	GPM Max
<b>666150-362-C</b>	Acetal	Nitrile	Aluminum	1/2"	1-1/2"	120 PSI	90 GPM

### 2" DIAPHRAGM PUMP

	Ball	Diaphragm & O-Ring	Body	Air Inlet (F)	Material Inlet & Outlet (F)	Maximum PSI	GPM Max
<b>PD20A-AAP-GGG-B</b>	Nitrile	Nitrile	Aluminum	3/4"	2"	120 PSI	170 GPM

# ARO DIAPHRAGM DRUM PUMP PACKAGE

# ARO®



## MATCHED COMPONENTS

ARO drum pump package components (adapters, siphon tubes, etc.) contain pre-specified, matching materials of construction for complete fluid compatibility

## RUNS DRY

ARO diaphragm pumps can run dry without any damage to the pump

## PATENTED AIR VALVE

ARO's patented "unbalanced" air valve design eliminates stalling, a common occurrence in competitive pumps

## BOLTED CONSTRUCTION

Pumps feature bolted construction to avoid the proven problems created by band clamp type pump fasteners

## LUBE-FREE AIR MOTOR

All ARO 1/2" diaphragm pumps are pre-lubricated. They do not require an air lubricator, eliminating maintenance concerns. *(The use of a lubricator is not recommended.)*

## SIMPLE DESIGN

Provides trouble-free operation and virtually maintenance-free performance



TIM-734  
(Includes filter/regulator with gauge)

DIAPHRAGM PUMPS

## SPECIFICATIONS

Ratio .....	1:1
Double-Acting .....	Yes
Air Inlet .....	1/4"(F)
Material Outlet .....	1/2"(F)
Free Flow Rating .....	13 Gals/Min
Air Inlet Pressure .....	100 PSI Max.

	TIM-734*	TIM-734-TOTE*
Body	Polypropylene	Polypropylene
Seat	Polypropylene	Polypropylene
Ball & Diaphragm	Nitrile	Nitrile
Fluid Compatibility	Oil, Water & Antifreeze	Oil, Water & Antifreeze
Container Size	16 to 55-Gallon Drum	275 to 330-Gallon Tote

\* Package includes pump, bung adapter, siphon tube, filter/regulator with gauge, weather seal and base. Not recommended for oil use in a "closed" system (where the pump remains pressurized when not in use) without thermal relief kit model number TIM-RELIEF-KIT.

## DIAPHRAGM PUMP PACKAGES

### 55-GALLON ANTIFREEZE PUMP PACKAGES



**612999-1\*‡**

**1/2" Wall Mounted Pump Package for Pre-Blended Antifreeze**

Includes 66605J-322 pump, TIM-461-B wall mount bracket, TIM-1055 siphon tube assembly, two (2) TIM-4418-5 1/2" material hoses, AIR-HP1414-5 air hose, P-39224-624 air filter/regulator/gauge, 210 air coupler, 2608 air connector and TIM-212-1 1/4" air adapter

**612999-2\*‡**

**1/2" Wall Mounted 50/50 Antifreeze/Water Blending Pump Package**

Includes 666053-388 pump, TIM-461-B wall mount bracket, two (2) TIM-1055 siphon tube assemblies, three (3) TIM-4418-5 1/2" material hoses, AIR-HP1414-5 air hose, P-39224-624 air filter/regulator/gauge, 210 air coupler, 2608 air connector and TIM-212-1 1/4" air adapter

**612999-3\*‡**

**1" Wall Mounted 50/50 Antifreeze/Water Blending Pump Package**

Includes 650715-C pump, TIM-461-B wall mount bracket, two (2) TIM-1058 siphon tube assemblies, two (2) 612999-4H 1" material hoses, TIM-1058 material hose, P-39224-624 air line filter/regulator/gauge, and AIR-HP1414-3 1/4" air hose

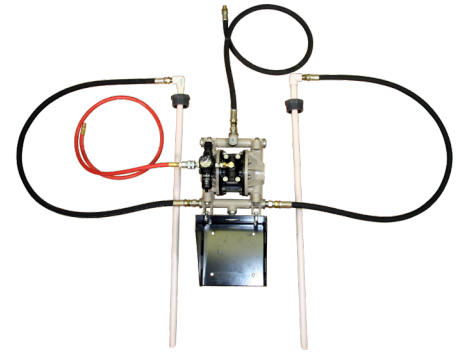

612999-2

\* Not recommended for oil use in a "closed" system (where the pump remains pressurized when not in use) without thermal relief kit model number TIM-RELIEF-KIT

‡ Only ARO pumps (66605J-322, 666053-388 and 650715-C) are covered by the ARO 5-Year Warranty, all other components are covered by standard American Lubrication warranty. For more warranty information, visit page 104.

### 55-GALLON WINDSHIELD WASHER FLUID PUMP PACKAGE

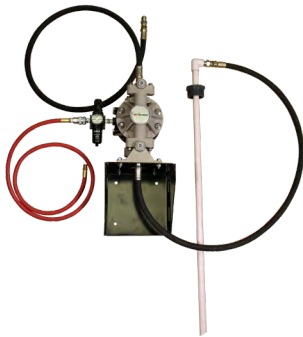

**612999-1\*‡**

**1/2" Wall Mounted Pump Package for Windshield Washer Fluid**

Includes 66605J-322 pump, TIM-461-B wall mount bracket, TIM-1055 siphon tube assembly, two (2) TIM-4418-5 1/2" material hoses, AIR-HP1414-5 air hose, P-39224-624 air filter/regulator/gauge, 210 air coupler, 2608 air connector and TIM-212-1 1/4" air adapter

\* Not recommended for oil use in a "closed" system (where the pump remains pressurized when not in use) without thermal relief kit model number TIM-RELIEF-KIT

‡ Only ARO pumps (66605J-322) are covered by the ARO 5-Year Warranty, all other components are covered by standard American Lubrication warranty. For more warranty information, visit page 104.

### 55-GALLON PLASTIC DRUM



**TIM-I-55B**

**55-Gallon Translucent Blue Poly Drum**

Ideal for 50/50 antifreeze and water applications or windshield washer solvent and water applications. TIM-I-55B is compatible with DEF Urea products.

DIAPHRAGM PUMPS



## DIAPHRAGM PUMP WASTE OIL PACKAGES



**612999-4\***

**Waste Oil Evacuation System**

Includes 666100-362-C 1" diaphragm pump, TIM-461-B wall mount bracket, 612999-4H 1" pump inlet hose assembly, 628067-3 1" pump outlet hose assembly, P-39224-624 air line filter/regulator/gauge, AIR-HP1414-3 1/4" air line hose, TIM-180 fluid coupler and TIM-250-BV air valve

**612999-5\***

**Waste Oil Evacuation System**

Includes 66605J-322 1/2" diaphragm pump, TIM-461-B wall mount bracket, 612999-5H 3/4" pump inlet hose assembly, TIM-4418-5S 1/2" pump outlet hose assembly, P-39224-624 air line filter/regulator/gauge, AIR-HP1414-3 1/4" air line hose and TIM-180 fluid coupler

\* Only ARO pumps are covered by the ARO 5-Year Warranty, all other components are covered by standard American Lubrication warranty. For more warranty information, visit page 104.



612999-4

## DIFFERENTIAL OIL EVACUATION PACKAGE

DIAPHRAGM PUMPS



**612999-6\***

**Portable 1/2" Evacuation System**

1/2" differential oil evacuation package. Includes 1/2" ported diaphragm pump, tube brackets for hanging the unit from a pit-mounted waste oil drain, 6' fluid suction line, air filter/regulator with gauge and related tubing and fittings

\* Only ARO pumps are covered by the ARO 5-Year Warranty, all other components are covered by standard American Lubrication warranty. For more warranty information, visit page 104.

## UL FUEL DIAPHRAGM PUMPS

Designed specifically for high-volume transfer, bulk-unloading, or fueling applications. These pumps meet UL 79 specification code and are compatible with gasoline, aviation fuel, diesel fuel, fuel oil, motor oil and kerosene.

To meet UL 79 specifications, pumps utilize pressure relief valves to limit dispensing line pressure to under 50 PSI. If line pressure between the pump and dispensing point exceeds 50 PSI due to thermal expansion, line compression, back pressure or gravity, the relief valve opens and bleeds off excess pressure. **The relief valve must be plumbed to return the bleed-off fuel to the storage container.**

	650717-C	650718-C
Ball	Acetal	Acetal
Seat	Kynar®	Kynar®
Diaphragm & O-Ring	Viton®	Viton®
Body	Aluminum	Aluminum
Air Inlet (F)	1/4"	1/2"
Material Inlet & Outlet (F)	1"	1-1/2"
Maximum PSI	50 PSI	50 PSI
GPM Max	29 GPM	75 GPM



650717-C

## THUNDER PUMP CONNECTING HOSE KITS



### TIM-4430

#### Connecting Hose Kit for Thunder Oil Pumps

Includes 3' air hose, 4' material hose, air coupler and connector and union adapter

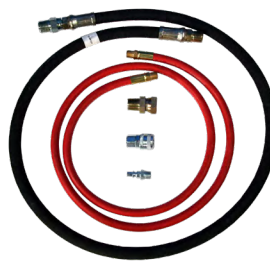

### TIM-4431

#### Connecting Hose Kit for Thunder Oil Pumps

Includes 5' air hose, 5' material hose, union adapter, air coupler and connector

## PRESSURE RELIEF KITS



### TIM-2000-4

Relief Setting

600 PSI

Description

#### Pressure Relief Kit

Relieves pressure build-up in the fluid line due to thermal expansion. Valve must be plumbed back to the oil supply tank. Kit includes everything required for hook-up: tee-connection for discharge side of pump, relief valve, rubber hose and 2" steel adapter. Use on 3:1 and 5:1 pumps.

### TIM-2000-4A

900 PSI

#### Pressure Relief Kit

Relieves pressure build-up in the fluid line due to thermal expansion. Valve must be plumbed back to the oil supply tank. Kit includes everything required for hook-up: tee-connection for discharge side of pump, relief valve, rubber hose and 2" steel adapter. Use on 9:1 pumps.

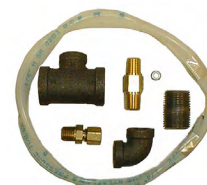

### TIM-RELIEF-KIT

100 PSI

#### Pressure Relief Kit

Used on 1/2" and 1" diaphragm pump applications to reduce pressure build-up due to thermal expansion. Must be plumbed back to the supply tank. Used on diaphragm pumps.

## FLUID Y-STRAINER



### TIM-2000-6A

Inlet/Outlet

1/2"(F)

Working Pressure

1,200 PSI

Description

#### 20 Mesh Filter

For keeping contaminants out of a fresh oil system



### TIM-2000-10

1"(F)

200 PSI

#### 20 Mesh Filter

For keeping contaminants out of a waste oil system

## STUB PUMP SUCTION TUBES

Suction tubes are made from black steel pipe. The tubes in these charts are based on using no check valve. Subtract 3" from the tube length if using a 3:1 (TIM-196-C) check valve, and subtract 5" from the tube length if using a 5:1 or 9:1 low-level cutoff (TIM-166-LLC). If using a 9:1 Series 425 pump order TIM-161 pipe coupler separately to connect the suction tube to the pump. (Used with bung adapters.)

Tank Used On	For 3:1 Pump 3/4" (M) Pipe	For 5:1 Pump 1-1/2" (M) Pipe	For 9:1 Pump 1-1/2" (M) Pipe
165-Gallon Workbench	<b>TIM-MTL75-25</b>	<b>TIM-MTL-23</b>	<b>TIM-MTL-15</b>
250-Gallon Workbench	<b>TIM-MTL75-25</b>	<b>TIM-MTL-23</b>	<b>TIM-MTL-15</b>
275-Gallon Horizontal Obround	<b>TIM-MTL75-37</b>	<b>TIM-MTL-35</b>	<b>TIM-MTL-26</b>
275-Gallon Vertical Obround	<b>TIM-MTL75-53</b>	<b>TIM-MTL-51</b>	<b>TIM-MTL-42</b>
525-Gallon Horizontal Obround	<b>TIM-MTL75-39</b>	<b>TIM-MTL-37</b>	<b>TIM-MTL-28</b>
500-Gallon Vertical Round	<b>TIM-MTL75-53</b>	<b>TIM-MTL-51</b>	<b>TIM-MTL-42</b>
Cube Style (60" Internal Depth)	<b>TIM-MTL75-53</b>	<b>TIM-MTL-51</b>	<b>TIM-MTL-42</b>



TIM-MTL75-37



TIM-MTL-35

PUMP ACCESSORIES

## PUMP INLET CHECK VALVES



**TIM-166-1**



**TIM-166-LLC**



**TIM-196-C**

Used On	Thunder 5:1 Pumps	Thunder 5:1 & Series 425 Oil Pumps	Thunder 3:1 Pumps
Description	<p><b>Inlet Check Valve</b> Installs at the bottom of the pump suction tube to help the pump maintain prime during periods of non-use. 1-1/2"(F) inlet. Check valve is 4-5/8"(L) which must be taken into consideration when ordering the suction tube.</p>	<p><b>Low-Level Cutoff &amp; Inlet Check Valve</b> Installs at the bottom of the pump suction tube to help the pump maintain prime during periods of non-use. Also helps protect the pump by slowing down the cycle rate if the pump runs dry (no oil in tank). 1-1/2"(F) inlet. Low-level cutoff is 4-5/8"(L) which must be taken into consideration when ordering the suction tube.</p>	<p><b>Inlet Check Valve</b> Installs at the bottom of the pump suction tube to help the pump maintain prime during periods of non-use. 3/4"(F) inlet. Check valve is 2-3/4"(L) which must be taken into consideration when ordering the suction tube.</p>

### BUNG ADAPTERS

	Description	Used On
<b>67145-3-B</b>	2"(M) Thread	Thunder 3:1 Oil Pumps
<b>67145-4-B</b>	2"(M) Thread	Thunder 5:1 Oil Pumps
<b>67145-2</b>	2"(M) Thread	Thunder Grease Pumps
<b>4148</b>	2"(M) Thread for Use with 1-7/8" Siphon Tube	Series 425 Grease Pumps & AFX Grease Pumps
<b>60869</b>	2"(M) Thread for Use with 2-1/8" Siphon Tube	AFX Oil Pumps
<b>60870</b>	2"(M) Thread for Use with 2-1/8" Siphon Tube	Series 200 1:1 Pumps, Series 425 Oil Pumps, Series 600 Grease Pumps & 6" AFX Grease Pumps
<b>67088</b>	<b>Water-Tight Seal Kit</b> Used in conjunction with bung adapters that come with Thunder grease pumps	Thunder Grease Pumps
<b>67088-3</b>	<b>Water-Tight Seal Kit</b> Consists of 67088 seal kit & 67145-3-B bung adapter	Thunder 3:1 Oil Pumps
<b>67088-4</b>	<b>Water-Tight Seal Kit</b> Consists of 67088 seal kit & 67145-4-B bung adapter	Thunder 5:1 Oil Pumps



67145-4-B



60869



4148



67088-3

### AIR MOTOR MUFFLERS

	Inlet	Size	Used On
<b>91790</b>	1-1/4"(M)	3-1/2" x 11-3/16"	Series 425 & Series 600 Pumps
<b>93110</b>	3/8"(M)	7/8" x 2-5/8"	1" Diaphragm Pumps
<b>93139</b>	3/4"(M)	3-1/8" x 4-1/4"	1-1/2" Diaphragm Pumps
<b>94117</b>	1-1/2"(M)	2" x 4"	2" & 3" Diaphragm Pumps
<b>96916</b>	1/2"(M)	1" x 3"	AFX Oil & Grease Pumps



93110



91790



96916

PUMP ACCESSORIES

## MOUNTING BRACKETS

	Description	Used On
<b>TIM-460-A</b>	<b>Wall-Mount Bracket with 2" Threaded Opening</b>	All Thunder Oil Pumps
<b>61113</b>	<b>Wall-Mount Bracket with 2" Threaded Opening</b> Bracket is slotted to fit over rim of open-head drum	Series 200 Pumps, all Thunder Oil Pumps, Series 425 & AFX Stub Pumps fitted with bung adapters
<b>TIM-461-B</b>	<b>Wall-Mount Bracket</b>	1/2" & 1" Diaphragm Pumps
<b>TIM-463</b>	<b>IBC Tote-Bracket for Diaphragm Pumps</b>	1/2" & 1" Diaphragm Pumps
<b>TIM-464-A</b>	<b>IBC Tote-Bracket for Oil Pump &amp; Reel-Mounting</b>	Thunder Oil Pumps, American Lubrication Reels with two (2) 2" Openings <i>Order 464-INSTL inslataion kit separately</i>

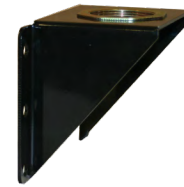

TIM-460-A



TIM-463



TIM-464-A

## MOUNTING BRACKET KITS

	Description	Used On
<b>TIM-460-3</b>	<b>Kit for Wall-Mounting 3:1 Thunder Stub Oil Pumps</b> Includes wall-mount bracket, 3/4" x 6' suction hose, double-tap bushing & adapters <i>Order 3/4" downtube &amp; check valve (TIM-196-C) separately</i>	Thunder 3:1 Stub Pumps
<b>TIM-460-5</b>	<b>Kit for Wall-Mounting 5:1 Thunder Stub Oil Pumps</b> Includes wall-mount bracket, 1" x 8' suction hose, double-tap bushing & adapters <i>Order 1-1/2" downtube &amp; check valve (TIM-166-LLC) separately</i>	Thunder 5:1 Stub Pumps
<b>TIM-465</b>	<b>Tote Mounting &amp; Siphon Kit</b> Includes tote mount bracket, suction hose & oil quick connects	Thunder 3:1 & 5:1 Pumps



TIM-465  
(pump not included)

## SIPHON TUBES FOR WALL-MOUNTED PUMPS

	TIM-1049	TIM-1052	TIM-1055	TIM-1056	TIM-1057	TIM-1058	TIM-1059	TIM-1059-V
Container Size	55-Gallon Drum	55-Gallon Drum	55-Gallon Drum	55-Gallon Drum	275-Gallon Tank	55-Gallon Drum	275-Gallon Tank	60" Height Tanks
Included Accessories	1" x 6' Suction Hose	1" x 6' Suction Hose	None	None	None	None	None	None
Tube Material	1-1/2" PVC	1-1/2" PVC	1/2" PVC	1/2" PVC	1/2" PVC	1-1/2" PVC	1-1/2" PVC	1-1/2" PVC
Foot Valve	Yes	Yes	No	No	No	Yes	Yes	Yes
Material Outlet Size	1-1/2"(M)	3/4"(M)	1/2"(F) x 90°	1/2"(M)	1/2"(M)	1"(F)	1"(F)	1"(F)
Used On	3" or 4-1/4" Stub Oil Pumps	2" Stub Oil Pumps	1/2" Diaphragm Pumps Wall-Mounted	1/2" Diaphragm Pumps Direct Drum-Mount	1/2" Diaphragm Pumps Direct Tank-Mount	Stub Pumps & 1/2" or 1" Diaphragm Pumps Wall-Mounted	Stub Pumps & 1/2" or 1" Diaphragm Pumps Wall-Mounted	Stub Pumps & 1/2" or 1" Diaphragm Pumps Wall-Mounted



TIM-1058

## DRUM COVERS

	Drum Size	# of 2" Threaded Holes	Works with Tie-Down Kits	Used On
<b>TIM-367-1</b>	35-Pound	1	No	2" & 3" Bare Grease Pumps
<b>TIM-451-1</b>	16-Gallon/ 120-Pound	1	Yes*	All Thunder 2" & 3" Pumps
<b>66492</b>	16-Gallon/ 120-Pound	1	Yes*	AFX Series 4-1/4" Oil & Grease Pumps
<b>66715</b>	120-Pound	1	No	AFX Series 6" Grease Pumps
<b>TIM-369</b>	55-Gallon/ 400-Pound	1	No	All Thunder 2" & 3" Pumps
<b>60898</b>	55-Gallon/ 400-Pound	NA	No	AFX Series 4-1/4" Grease Pumps
<b>71060-AL</b>	55-Gallon/ 400-Pound	2	Yes*	All Thunder Pumps, AFX Series 4-1/4" Grease Pumps equipped with a bung adapter, & AFX Series 6" Grease Pumps

\* Tie-down kits not included. Order tie-down kits separately.



TIM-367-1

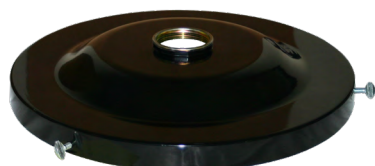

TIM-451-1

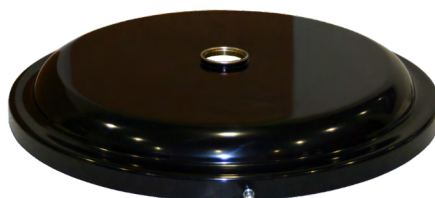

TIM-369



71060-AL

## DRUM TIE-DOWN KITS

Tie-down kits facilitate the mounting of drums on lube trucks. Tie-down rods mount to the drum cover and are attached to the truck's floor bed to prevent the drum from moving. Kit includes two (2) tie-down rods and mounting hardware.

	<b>640164</b>	<b>71027-1</b>
Drum Size	16-Gallon, 120-Pound Drum	55-Gallon, 400-Pound Drum
Cover Used With	TIM-451-1	71060-AL
Used On	All Thunder 2" & 3" Pumps	All Thunder 2" & 3" Pumps & All AFX Series Pumps



640164

PUMP ACCESSORIES



**PUMP LIFTS**

**640067**



Description	Single-Acting Cylinder Lift for 55-Gallon or 400-Pound Drum
Max. Height	92"
Required Drum Cover	71060-AL
Used On	All Thunder 2" & 3" Pumps & All AFX Pumps



640067

**GREASE FOLLOWER PLATES**

	Drum Size	Wiper Seal Material	Used On
<b>TIM-368</b>	35-Pound	Rubber	Thunder 2" & 3" Grease Pumps
<b>TIM-366</b>	120-Pound	Buna-N	Thunder 2" & 3" Grease Pumps
<b>TIM-363</b>	120-Pound	Buna-N	AFX Series, 50:1 Grease Pumps
<b>640152-1</b>	120-Pound	Buna-N	AFX Series, 100:1 Grease Pumps
<b>TIM-640015-1</b>	400-Pound	Buna-N	Thunder 3" Grease Pump
<b>TIM-364</b>	400-Pound	Buna-N	AFX Series, 50:1 Grease Pumps
<b>640015-5</b>	400-Pound	Buna-N	AFX Series, 50:1 Grease Pumps



TIM-368



TIM-363

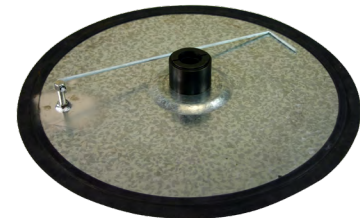

TIM-640015-1

**DRUM DOLLIES**



**TIM-353**



**TIM-358**



**TIM-352**



**TIM-355-1**

Drum Size	35-Pound	120-Pound	120-Pound	400-Pound
Used On	Band Dolly with Polypropylene Wheels	Band Dolly with Polypropylene Wheels	Platform Dolly with Polypropylene Wheels	Band Dolly

PUMP ACCESSORIES

**DRUM CARTS**

**TIM-401**

**Heavy-Duty Industrial Drum Cart**

For use with either 55-gallon or 400-pound drums. Solid polymer wheels for durability and maneuverability on rougher surfaces. Equipped with fixed front wheels and caster rear wheel with locking brake. The unit includes a drum fastening system, hose hanger and control handle storage slot.



TIM-401

**TIM-408**

**3-Wheel Drum Cart**

Includes hinged handle, swivel type front wheel and two (2) 6" diameter rubber rear wheels. Accommodates either 16-gallon or 120-pound drum.



TIM-408

**DRUM ACCESSORIES**

**TIM-351-8**

**Drum Cradle with Wheels**

This easy to use drum cradle is ideal for storing and moving 55-gallon drums. Includes four (4) 2-1/4" fixed poly wheels and an easy to use lever bar. Weight capacity is 600 pounds.

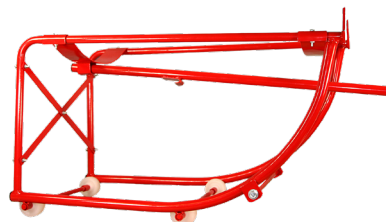

TIM-351-8

**TIM-351-8HD**

**Heavy-Duty Drum Cradle with Wheels**

This cradle has two (2) 4" fixed wheels in the front and two (2) 4" swivel wheels in the rear for maximum mobility. Has an adjustable handle and weight capacity is 1,100 pounds.



TIM-351-8HD

**TIM-351-1**

**Aluminum Drum Wrench**

Non-sparking. Opens 3/4" slotted bung and 2" cross bar bung.



TIM-351-1

**TIM-32-34A**

**Metal Drum Spigot**

Self-closing drum spigot fits 3/4" NPT opening. Spigot allows for the use of a lock.



TIM-32-34A

**TIM-32-34P**

**Polyethylene Drum Spigot**

Self-closing drum spigot fits 3/4" NPT opening. Spigot allows for the use of a lock. 10 pack.

DRUM ACCESSORIES



**TIM-75**



**TIM-77**



**TIM-79-SS**

Container Size	16 to 55-Gallon Drums	16 to 55-Gallon Drums	16 to 55-Gallon Drums
Fluid Compatibility	Oils & Non-Corrosive Fluids	Oils & Non-Corrosive Fluids	Antifreeze, Strong Chemicals & Solvents that are compatible with the materials used in the body & downtube of the pump
Downtube Type	Steel Telescoping 18" to 34.5"	Telescoping 18" to 34.5"	Nylon/Stainless Steel
Body Material	Aluminum	Aluminum	Nylon & Stainless Steel with Teflon® Seals. Bung adapter is made of polypropylene.
Pump Type	Lever	Lever	Vertical Pull
Discharge	Twisting Non-Drip Spout	Twisting Non-Drip Spout	Twisting Non-Drip Spout
Delivery	12 Ounces per Stroke	16 Ounces per Stroke	8 Ounces per Stroke



**TIM-87**



**4188**



**4162**

Container Size	5 to 55-Gallon Drums	5 to 55-Gallon Drums	5 to 55-Gallon Drums
Fluid Compatibility	Antifreeze, Windshield Washer Solvent & any product compatible with stainless steel & Teflon®	Various Chemicals, Solvents & Antifreeze	Antifreeze, Windshield Washer Fluid, Methanol, Chlorinated Solvents & some Water-Based Chemicals
Downtube Type	316 Stainless Steel & Teflon®	Polyethylene	Polyethylene
Body Material	316 Stainless Steel & Teflon®	Polyethylene/Polypropylene	Polyethylene/Polypropylene
Pump Type	Vertical Pull	Siphon	Lever
Discharge	Fixed 316 Stainless Steel Spout	5' x 8" Hose	Straight Spout
Delivery	7 Ounces per Stroke	Siphon	13 Ounces per Stroke

**BUTTRESS THREAD ADAPTER**



**4190**

**Buttress Thread Adapter**

2" NPT (F) x 2" buttress (M). Nylon adapter converts 2" buttress thread to 2" NPT. Ideal for using pumps with 2" NPT male threads on containers which have 2" buttress threads.



**TIM-74**



**TIM-74-AL**



**TIM-322**

Container Size	16 to 55-Gallon Drums	16 to 55-Gallon Drums	16 to 55-Gallon Drums
Fluid Compatibility	Oils & Antifreeze	Oils	Oil, Gasoline & Other Petroleum-based Products
Downtube Type	Adjustable Bung Adapter	Aluminum	Telescoping 22" to 40"
Body Material	Cast Iron	Aluminum	Cast Iron
Pump Type	Rotary	Rotary	Lever-pull/push-can be padlocked
Discharge	Spout with 3/4"(M)	Spout with Swing-Arm Return Drain	5/8" x 8' Delivery Hose (3/4"(M) both ends) & Nozzle
Delivery	1 Gallon per 12 Revolutions	1 Gallon per 8 Revolutions	1 Gallon per 5 Strokes



**TIM-322-A**



**TIM-323**



**4166-1**

Container Size	16 to 55-Gallon Drums	16 to 55-Gallon Drums	5 to 55-Gallon Drums
Fluid Compatibility	Oils & Diesel Fuel	Oils, Gasoline & Diesel Fuel	DEF, Antifreeze, Windshield Washer Fluid, Methanol, Chlorinated Solvents, & some Water-Based Chemicals
Downtube Type	Telescoping 22" to 40"	Telescoping 22" to 40"	Polyethylene
Body Material	Aluminum	Aluminum	Polypropylene with Teflon® Seals
Pump Type	Lever-pull/push-can be padlocked	Rotary-can be padlocked	Rotary
Discharge	5/8" x 8' Delivery Hose (3/4"(M) both ends) & Nozzle	5/8" x 8' Delivery Hose (3/4"(M) both ends) & Nozzle	Twisting Non-Drip Spout
Delivery	1 Gallon per 5 Strokes	1 Gallon per 10 Revolutions	8 Ounces per Revolution

## ADVANTAGE PLUS SERIES

### SLIDE-IN MOUNTING BRACKET

Optional slide-in bracket simplifies reel mounting. Easily allows one person to hang the reel in an overhead application

### LATCH SPRING

Heavy-duty latch spring is designed for years of trouble-free service, and can be replaced without removing or disassembling the reel

### ENCLOSED SPRING

Cartridge style spring motor is packed with grease and fully enclosed for extra safety. Springs are factory balanced for each size reel

### MOUNTING FLEXIBILITY

Multi-position guide arm is easily adjusted for ceiling, floor, wall, tank, or truck mounting

### STRENGTH BEADS

Reels are constructed with strength beads for added rigidity

### ROLLED EDGES

Hubs are constructed of heavy gauge steel with rolled edges for extra strength and maximum protection

### SELF-LUBRICATING

1" double supported steel axle with 1" self-lubricating precision bearings

### RIGID CONSTRUCTION

Base plate and support post are built from heavy 1/4" plate steel to reduce flexing and fatigue

### HI-FLOW SWIVEL

Load-free high-flow swivel allows maximum product delivery, and can be replaced without removing or disassembling the reel

### DURABLE FINISH

All Advantage Plus Series reels are powder-coated black for increased durability

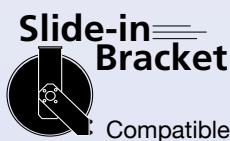

TIM-3628-50

## SIZE INDEX CHART

A	B	C	D	E	Mount L-M
8-7/16"	21-1/2"	20-5/8"	5-3/4"	9"	3-1/2" x 7-1/2"

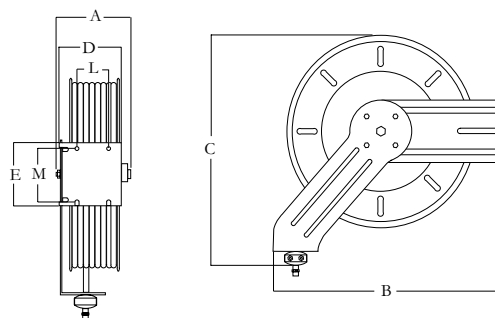

14' maximum mounting height

## AIR &amp; WATER REELS - LOW PRESSURE

	For Use On	Hose Size	Max PSI	Delivery Hose	Hose Stop	Inlet/Outlet	Weight
<b>TIM-3616-50</b>	Air, Water, WWS	3/8"(M) x 50'	300 PSI	AIR-HP3838-50F	TIM-131-3	3/8"(F)	49 lbs
<b>TIM-3616-65</b>	Air, Water, WWS	3/8"(M) x 65'	300 PSI	AIR-HP3838-65F	TIM-131-3	3/8"(F)	53 lbs
<b>TIM-3618-50A</b>	Air, Water, WWS	1/2"(M) x 50'	300 PSI	TIM-4208-50F	TIM-131-4	1/2"(F)	60 lbs
<b>TIM-3618-65A*</b>	Air, Water, WWS	1/2"(M) x 65'	300 PSI	TIM-4208-65F	TIM-131-4	1/2"(F)	64 lbs

\* These reels are equipped with a special factory-balanced spring designed specifically for 65' hose

## OIL REELS - MEDIUM PRESSURE

	For Use On	Hose Size	Max PSI	Delivery Hose	Hose Stop	Inlet/Outlet	Weight
<b>TIM-3628-25</b>	Oil, ATF, A/F	1/2"(M) x 25'	2,000 PSI	TIM-4418-25S	TIM-131-4	1/2"(F)	47 lbs
<b>TIM-3628-50</b>	Oil, ATF, A/F	1/2"(M) x 50'	2,000 PSI	TIM-4418-50S	TIM-131-4	1/2"(F)	55 lbs

## GREASE REEL - HIGH PRESSURE

	For Use On	Hose Size	Max PSI	Delivery Hose	Hose Stop	Inlet/Outlet	Weight
<b>TIM-3636-50</b>	Grease	3/8"(M) x 50'	4,000 PSI	TIM-4506-50S	TIM-131-3	3/8"(F)	60 lbs



TIM-3616-50



TIM-3628-50



TIM-3636-50

## OPTIONAL SLIDE-IN MOUNTING BRACKET

**TIM-3600-50**

12-3/4" L x 10-1/2" W slide-in mounting bracket simplifies reel mounting by allowing for one man installations. Easily mounts to Uni-Strut® using Uni-Strut® hardware (not included). Can also be mounted by drilling and fastening to an I-Beam or H-Beam (fastening hardware not included). 1/8" steel construction.



## ADVANTAGE<sup>2</sup> PLUS SERIES

### DUAL ARM DESIGN

Adds rigidity to the reel making it well suited for heavy use, high ceilings or lube truck applications

### LATCH SPRING

Heavy-duty latch spring is designed for years of trouble-free service, and can be replaced without removing or disassembling the reel

### ENCLOSED SPRING

Cartridge style spring motor is packed with grease and fully enclosed for extra safety.

### MOUNTING FLEXIBILITY

Multi-position guide arm is easily adjusted for ceiling, floor, wall, tank, or truck mounting

### STRENGTH BEADS

Reels are constructed with strength beads for added rigidity

### ROLLED EDGES

Hubs are constructed of heavy gauge steel with rolled edges for extra strength and maximum protection

### RIGID CONSTRUCTION

Base plate and support post are built from heavy 1/4" plate steel to reduce flexing and fatigue

### HI-FLOW SWIVEL

Load-free high-flow swivel allows maximum product delivery, and can be replaced without removing or disassembling the reel

### DURABLE FINISH

All Advantage Plus Series reels are powder-coated black for increased durability

# ADVANTAGE<sup>2</sup> DOUBLE-ARM REELS

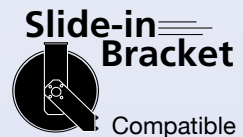

Compatible

TIM-3936-50

## SIZE INDEX CHART

A	B	C	D	E	Mount L-M
9"	20-1/2"	23"	7-1/2"	9"	3-1/2" x 7-1/2"

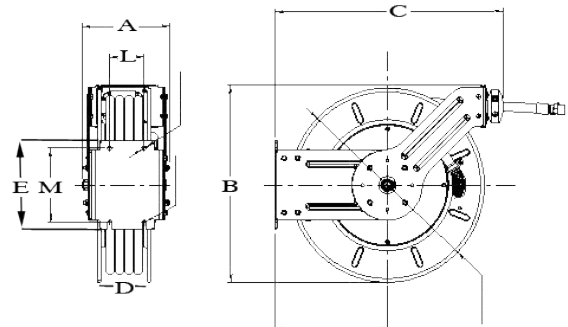

## AIR & WATER REELS - LOW PRESSURE

	For Use On	Hose Size	Max PSI	Delivery Hose	Hose Stop	Inlet/Outlet	Weight
<b>TIM-3916-50</b>	Air, Water, WWS	3/8"(M) x 50'	300 PSI	AIR-HP3838-50F	TIM-131-3	3/8"(F)	60 lbs
<b>TIM-3916-65</b>	Air, Water, WWS	3/8"(M) x 50'	300 PSI	AIR-HP3838-65F	TIM-131-3	3/8"(F)	64 lbs
<b>TIM-3918-50A</b>	Air, Water, WWS	1/2"(M) x 50'	300 PSI	TIM-4208-50F	TIM-131-4	1/2"(F)	71 lbs
<b>TIM-3918-65A*</b>	Air, Water, WWS	1/2"(M) x 65'	300 PSI	TIM-4208-65F	TIM-131-4	1/2"(F)	75 lbs

\* These reels are equipped with a special factory-balanced spring designed specifically for 65' hose

## OIL REEL - MEDIUM PRESSURE

	For Use On	Hose Size	Max PSI	Delivery Hose	Hose Stop	Inlet/Outlet	Weight
<b>TIM-3928-50</b>	Oil, ATF, A/F	1/2"(M) x 50'	2,000 PSI	TIM-4418-50	TIM-131-4	1/2"(F)	68 lbs

## GREASE REEL - HIGH PRESSURE

	For Use On	Hose Size	Max PSI	Delivery Hose	Hose Stop	Inlet/Outlet	Weight
<b>TIM-3936-50</b>	Grease	3/8"(M) x 50'	4,000 PSI	TIM-4506-50S	TIM-131-3	3/8"(F)	83 lbs



TIM-3916-50



TIM-3928-50



TIM-3936-50

## ADAPTER PLATE

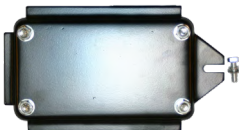

### TIM-3900-50

The TIM-3900-50 Adapter Plate makes the Advantage Plus<sup>2</sup> Double Arm reel base compatible with the TIM-3600-50 Slide-in bracket. After the adapter plate is bolted to a double arm reel base, the reels can be slid into the TIM-3600-50 bracket.

## PLATINUM SERIES PREMIUM DOUBLE-ARM

### DOUBLE-ARM CONSTRUCTION

Reel is supported on both sides by pedestal style base and arm guides

### ENCLOSED SPRING

Cartridge style spring motor is packed with grease and fully enclosed for extra safety. Springs are factory balanced for each size reel

### MOUNTING FLEXIBILITY

Multi-position guide arm is easily adjusted for ceiling, floor, wall, tank or truck mounting

### TRIPLE SUPPORT

Reel axle is independently supported in three separate places and has self-lubricating bearings

### STRENGTH BEADS

Reels are constructed with strength beads for added rigidity

### ROLLED-EDGE

Hubs are constructed of heavy gauge steel with rolled edges for extra strength and maximum protection

### RIGID CONSTRUCTION

Base plate and support post are built from heavy 1/4" plate steel to reduce flexing and fatigue

### LATCH-OUT PREVENTION

Hose reels can be installed to prevent "latch-out" or locked reel syndrome

### HI-FLOW SWIVEL

Load-free Hi-Flow swivel allows maximum product delivery. Swivel O-ring seals are supported by Teflon® backup rings for added durability

### DURABLE FINISH

All Platinum Series reels are powder-coated grey for increased durability



TIM-3208-75P

## SIZE INDEX CHART

Size Index	Reel Dimensions In Inches					Mount L-M
	A	B	C	D	E	
1	9-1/4"	25-1/2"	23"	8"	9"	7" x 8"
2	9-3/4"	25-1/2"	23"	8"	9"	7" x 8"

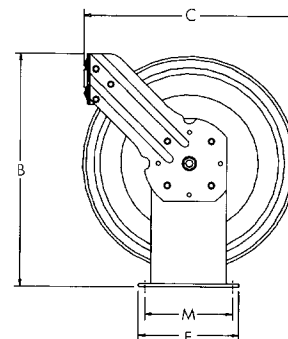
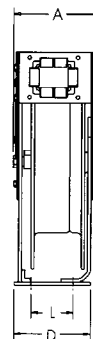

**AIR & WATER REELS - LOW PRESSURE**

	Hose Size	Maximum PSI	Delivery Hose	Hose Stop	Inlet	Delivery Hose Thread Size	Weight	Size Index
<b>TIM-3106-75P</b>	3/8" x 75'	300 PSI	TIM-4216-75F	TIM-131-3	3/8"(F)	3/8"(M)	82 lbs	1
<b>TIM-3106-100P</b>	3/8" x 100'	300 PSI	TIM-4216-100F	TIM-131-3	3/8"(F)	3/8"(M)	85 lbs	1
<b>TIM-3108-75P</b>	1/2" x 75'	300 PSI	TIM-4208-75F	TIM-131-4	1/2"(F)	1/2"(M)	82 lbs	1
<b>TIM-3108-100P</b>	1/2" x 100'	300 PSI	TIM-4208-100F	TIM-131-4	1/2"(F)	1/2"(M)	95 lbs	1

**OIL, ATF & ANTIFREEZE REELS - MEDIUM PRESSURE**

	Hose Size	Maximum PSI	Delivery Hose	Hose Stop	Inlet	Delivery Hose Thread Size	Weight	Size Index
<b>TIM-3208-75P</b>	1/2" x 75'	2,500 PSI	TIM-4418-75S	TIM-131-4	1/2"(F)	1/2"(M)	100 lbs	1
<b>TIM-3208-100P</b>	1/2" x 100'	2,500 PSI	TIM-4418-100S	TIM-131-4	1/2"(F)	1/2"(M)	106 lbs	1

**GREASE REEL - HIGH PRESSURE**

	Hose Size	Maximum PSI	Delivery Hose	Hose Stop	Inlet	Delivery Hose Thread Size	Weight	Size Index
<b>TIM-3306-75P</b>	3/8" x 75'	4,000 PSI	TIM-4506-75	TIM-131-3	3/8"(F)	3/8"(M)	98 lbs	2

**DIESEL FUEL, GASOLINE & OIL REEL**

	For Use On	Hose Size	Maximum PSI	Inlet	Weight	Size Index
<b>TIM-3412-50P</b>	Evacuation, Fuel	3/4" x 50'	300 PSI	3/4"(F)	110 lbs	2



TIM-3208-75P



TIM-3306-75P



TIM-3412-50P

## CABINET ENCLOSURES FOR ADVANTAGE PLUS REELS

### CONSTRUCTION

Cabinet enclosures and end panels are constructed of 14-gauge steel

### DURABLE FINISH

All steel parts are powder-coated with a white textured finish

### ACCESS PANELS

Removable panels for easy access to the reels

### MOUNTING CHANNEL

Included 1/4" powder-coated mounting plate attaches to 4" to 7-1/2" flange on "I" or "H" beam

### ROLLER GUIDES

Each reel cabinet includes a four-roller non-snag hose guide system that reduces hose wear



## CABINET ENCLOSURES & ACCESSORIES

### TIM-3600-CAB

#### Single Cabinet Enclosure

For Advantage Plus Series Reels only. Top, bottom, and back panels are constructed of 14-gauge steel and are painted with a textured white powder-coated finish. Each cabinet includes mounting bracket, non-snag roller outlets and reel access panel. Once the cabinet is mounted the reel slides easily into place. Order one cabinet per reel.

*Must remove hose-guide arm from reel before installing*

*An unlimited number of cabinets can be bolted tight together, side by side.*

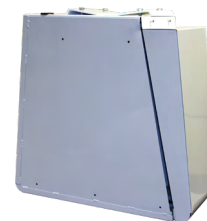

TIM-3600-CAB

### TIM-3600-PAN

#### End-Panel Kit

Includes two end panels. Design allows for end user to customize the panels with their own logo/decals. Order one kit for each bank of reels.



TIM-3600-PAN  
(decals not included)

## REQUIRED CONNECTING HOSES FOR CABINET ENCLOSURES

	AIR-HP3838-4NS	TIM-4218-4NS	TIM-4418-4NS	TIM-4516-4NS
Fluid Compatibility	Air	Air	Oil	Grease
Hose ID	3/8"	1/2"	1/2"	3/8"
Thread Size	3/8"(M) x 3/8"-90° Swivel (M)	1/2"(M) x 1/2"-90° Swivel (M)	1/2"(M) x 1/2"-90° Swivel (M)	3/8"(M) x 3/8"-90° Swivel (M)
Working PSI	300 PSI	300 PSI	2,000 PSI	4,000 PSI
Hose Length	4'	4'	4'	4'



### HOSE REEL CONNECTING HOSES

	Fluid Compatibility	Hose ID	Thread Size	Maximum PSI	Hose Length	For Use On
<b>AIR-HP3838-2</b>	Air	3/8"	3/8"(M) x 3/8"(M)	300 PSI	2'	3/8" Air/Water Reels
<b>AIR-HP3838-2N</b>	Air	3/8"	3/8"(M) x 3/8"-90° Swivel (M)	300 PSI	2'	3/8" Air/Water Reels
<b>TIM-4218-2N</b>	Air	1/2"	1/2"(M) x 1/2"-90° Swivel (M)	300 PSI	2'	1/2" Air/Water Reels
<b>TIM-4418-2NS</b>	Oil	1/2"	1/2"(M) x 1/2"-90° Swivel (M)	2,000 PSI	2'	1/2" Oil Reels
<b>TIM-4412-3</b>	Oil	3/4"	3/4"(M) x 3/4"(M)	1,250 PSI	3'	3/4" Oil Reels
<b>TIM-4412-5</b>	Oil	3/4"	3/4"(M) x 3/4"(M)	1,250 PSI	5'	3/4" Oil Reels
<b>TIM-4516-2N</b>	Grease	3/8"	3/8"(M) x 3/8"-90° Swivel (M)	4,000 PSI	2'	3/8" Grease Reels

### HOSE STOPS



**TIM-254-D**



**TIM-131-A**



**TIM-131-3**



**TIM-131-4**



**TIM-430**

Hose ID	1/2"	1/4"	3/8"	1/2"	3/4"
Outside Diameter	3-1/2"	2-1/2"	3"	3"	3-1/2"
Reel	Quick-Lube Consoles	All 1/4" ID Hose Reels	3/8" Air Reels	1/2" Oil & Air Reels	3/4" Oil Reels
Style	Donut	Donut	Donut	Donut	Donut



## PRO SERIES DIGITAL CONTROL VALVES

### EXCLUSIVE DESIGN

This meter is built exclusively for American Lubrication Equipment Corporation incorporating numerous design ideas provided by their design team

### FIELD REPAIRABLE

This design enables the user to replace the circuit board while the meter is installed under pressure

### SUPERIOR DESIGN

Fluid is completely separated from the electronic head. The entire electronics head/puck is available as a replacement part

### PROGRAMMABLE

All Pro Series digital meters are programmable to Pints, Quarts, Liters and Gallons

### BATTERIES

New AAA battery design lasts up to 3 times longer

### SHOCK-RESISTANT

Rugged shock-resistant design stands up to the harshest environments. Meter covers have a molded-in soft rubber shock-guard for added protection

### MODULAR ASSEMBLY

Swivel, control valve, meter and tip assembly are separate units which simplifies repair

### FILTER

All Pro Series digital control valves have built-in filters for added protection

### TRIGGER GUARD & LOCK

All Trigger Guard (TG) style control valves have a built-in trigger guard which helps prevent accidental dispensing as well as a built-in trigger lock for hands-free dispensing

### 3-YEAR LIMITED WARRANTY

All Pro Series digital control valves come with a 3-year limited warranty



TIM-601-RM

TIM-600-FM

Operating Pressure	Operating Temperature	Storage Temperature	Weight (TIM-600-RM)
1,000 PSI	23° to 140° F	-5° to 158° F	2.8 lbs

## SPECIFICATIONS

Meter Mechanism	Oval Gear
Measurement	Pints, Quarts, Liters, Gallons
Inlet/Outlet	1/2" NPT (F)
Flow Range (TIM-615)	.1 to 26 Qts/Min
Accuracy	± .5%
Repeatability	± .3%

## FLUID COMPATIBILITY



Automatic Transmission Fluid



Gear Oil



Hydraulic Oil



Motor Oil



Synthetic Oil

## TIM-615 COMPONENT VIEW



Cover Assembly

Electronics Section with Fluid Isolation Plate

Measuring Chamber/Oval Gear Assembly

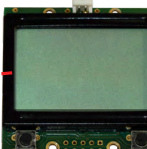

**TIM-615-4**  
"Plug and play" circuit board can be replaced while the meter is under pressure

**DIGITAL PRO SERIES TG STYLE CONTROL VALVES**

	Metered Units	Totalizer Units	Tip Assembly	Tip Assembly Description	Tip Diameter	Working Flow Rate
<b>TIM-600-FA</b>	Pts/Qts/Lts/Gals	Lts/Gals	TIM-747	Flex Automatic	1/2"	2.5 GPM
<b>TIM-600-FM</b>	Pts/Qts/Lts/Gals	Lts/Gals	TIM-743	Flex Manual	5/8"	2.5 GPM
<b>TIM-600-FMHF</b>	Pts/Qts/Lts/Gals	Lts/Gals	TIM-743-1	Flex Manual Hi-Flow	15/16"	4 GPM
<b>TIM-600-RA</b>	Pts/Qts/Lts/Gals	Lts/Gals	TIM-746	Rigid Automatic	1/2"	2.5 GPM
<b>TIM-600-RM</b>	Pts/Qts/Lts/Gals	Lts/Gals	TIM-753	Rigid Manual	1/2"	2.5 GPM
<b>TIM-600-RMGO</b>	Pts/Qts/Lts/Gals	Lts/Gals	TIM-742	90° Rigid Manual	1/2"	2.5 GPM
<b>TIM-600-RMHF</b>	Pts/Qts/Lts/Gals	Lts/Gals	TIM-752	Rigid Manual Hi-Flow	15/16"	4 GPM

Order optional colored swivel guards separately. See page 59.



TIM-600-RM

CONTROL VALVES & METERS

**DIGITAL PRO SERIES STANDARD CONTROL VALVES**

	Metered Units	Totalizer Units	Tip Assembly	Tip Assembly Description	Tip Diameter	Working Flow Rate
<b>TIM-601-FA</b>	Pts/Qts/Lts/Gals	Lts/Gals	TIM-747	Flex Automatic	1/2"	2.5 GPM
<b>TIM-601-FM</b>	Pts/Qts/Lts/Gals	Lts/Gals	TIM-743	Flex Manual	5/8"	2.5 GPM
<b>TIM-601-FMHF</b>	Pts/Qts/Lts/Gals	Lts/Gals	TIM-743-1	Flex Manual Hi-Flow	15/16"	4 GPM
<b>TIM-601-RA</b>	Pts/Qts/Lts/Gals	Lts/Gals	TIM-746	Rigid Automatic	1/2"	2.5 GPM
<b>TIM-601-RM</b>	Pts/Qts/Lts/Gals	Lts/Gals	TIM-753	Rigid Manual	1/2"	2.5 GPM
<b>TIM-601-RMGO</b>	Pts/Qts/Lts/Gals	Lts/Gals	TIM-742	90° Rigid Manual	1/2"	2.5 GPM
<b>TIM-601-RMHF</b>	Pts/Qts/Lts/Gals	Lts/Gals	TIM-752	Rigid Manual Hi-Flow	15/16"	4 GPM

Order optional colored swivel guards separately. See page 59.



TIM-601-FM

**Tip Extensions**



TIM-743

TIM-753

TIM-747

TIM-746

TIM-742

TIM-752

TIM-743-1

## PRO SERIES MECHANICAL CONTROL VALVES

### SUPERIOR DESIGN

Enables the use of manual non-drip tips

### DURABLE

No exposed pointers to break or turn backwards

### MODULAR ASSEMBLY

Swivel, control valve, meter and tip assembly are separate units which simplifies repair

### SELF-POWERED

Eliminates the headaches associated with dead batteries

### SHOCK-RESISTANT

Rugged shock-resistant design stands up to the harshest environments. Meter bodies are equipped with a soft rubber shock-guard for added protection

### FILTER

All Pro Series mechanical control valves have built-in filters for added protection

### TRIGGER GUARD

All Trigger Guard (TG) style control valves have a built-in trigger guard which helps prevent accidental dispensing

### TRIGGER LOCK

All TG style control valves have a built-in trigger lock, allowing hands-free operation

### 3-YEAR LIMITED WARRANTY

All Pro Series mechanical control valves come with a 3-year limited warranty



TIM-651-RM

TIM-650-FM

Operating Pressure

1,000 PSI

Operating Temperature

-4° to 176° F

Storage Temperature

-4° to 176° F

Weight (TIM-650-FM)

3.45 lbs

### SPECIFICATIONS

Meter Mechanism . . . . . Oval Gear/Mechanical  
 Measurement . . . . . Quarts  
 Inlet/Outlet . . . . . 1/2" NPT (F)  
 Flow Range (TIM-616) . . . . . 0.25 to 8 Gals/Min  
 Accuracy . . . . . ± 1%  
 Repeatability . . . . . ± .2%

### FLUID COMPATIBILITY



Automatic Transmission Fluid



Gear Oil



Hydraulic Oil



Motor Oil



Synthetic Oil

**MECHANICAL PRO SERIES TG STYLE CONTROL VALVES**

	Metered Units	Totalizer Units	Tip Assembly	Tip Assembly Description	Tip Diameter	Working Flow Rate
<b>TIM-650-FA</b>	Quarts	Quarts	TIM-747	Flex Automatic	1/2"	2.5 GPM
<b>TIM-650-FM</b>	Quarts	Quarts	TIM-743	Flex Manual	5/8"	2.5 GPM
<b>TIM-650-FMHF</b>	Quarts	Quarts	TIM-743-1	Flex Manual Hi-Flow	15/16"	4 GPM
<b>TIM-650-RA</b>	Quarts	Quarts	TIM-746	Rigid Automatic	1/2"	2.5 GPM
<b>TIM-650-RM</b>	Quarts	Quarts	TIM-753	Rigid Manual	1/2"	2.5 GPM
<b>TIM-650-RMHF</b>	Quarts	Quarts	TIM-752	Rigid Manual Hi-Flow	15/16"	4 GPM

Order optional colored swivel guards separately. See page 59.



TIM-650-RM

CONTROL VALVES & METERS

**MECHANICAL PRO SERIES STANDARD CONTROL VALVES**

	Metered Units	Totalizer Units	Tip Assembly	Tip Assembly Description	Tip Diameter	Working Flow Rate
<b>TIM-651-FA</b>	Quarts	Quarts	TIM-747	Flex Automatic	1/2"	2.5 GPM
<b>TIM-651-FM</b>	Quarts	Quarts	TIM-743	Flex Manual	5/8"	2.5 GPM
<b>TIM-651-FMHF</b>	Quarts	Quarts	TIM-743-1	Flex Manual Hi-Flow	15/16"	4 GPM
<b>TIM-651-RA</b>	Quarts	Quarts	TIM-746	Rigid Automatic	1/2"	2.5 GPM
<b>TIM-651-RM</b>	Quarts	Quarts	TIM-753	Rigid Manual	1/2"	2.5 GPM
<b>TIM-651-RMHF</b>	Quarts	Quarts	TIM-752	Rigid Manual Hi-Flow	15/16"	4 GPM

Order optional colored swivel guards separately. See page 59.



TIM-651-FM

**Tip Extensions**



TIM-743



TIM-753



TIM-747



TIM-746



TIM-752



TIM-743-1

## 900 SERIES DIGITAL PRESET METERS

### ERGONOMIC

900 Series meters are designed with an anatomical hand grip and a trigger that requires minimal pressure to operate

### SWIVEL EXTENSION

All digital preset meters are equipped with a patented multi-position extension that threads directly into the meters body. Units with a rigid extension are also equipped with a rotatable non-drip tip

### PROGRAMMABLE

User can store five (5) programmable preset values in the meter's memory that can be easily recalled at the time of dispense. The meter always stores the amount of the previous dispense as a sixth preset value

### VERSATILE

Digital preset meters can be set up to measure in Pints, Quarts, Liters or Gallons

### TRIGGER GUARD

Preset meters have a built-in trigger guard which helps prevent accidental dispensing

### SWIVEL GUARD

Units are equipped with a black swivel guard which prevents the swivel from damaging the vehicle's finish while being serviced

### L.E.D. DISPLAY

Large, easy to read L.E.D. display shows the dispensing amount and totalizer value at the same time

### FILTER

All 900 Series digital control valves have built-in filters for added protection

### BATTERIES

Meters use four (4) standard AA batteries which are field replaceable. The meter's memory is retained even during power loss



TIM-900B-1

Operating Pressure

1,000 PSI  
Max.

Operating  
Temperature

23° to 122° F

Storage  
Temperature

-31° to 140° F

Weight

3 lbs

### SPECIFICATIONS

Measurements . . . . . Pints, Quarts, Liters, Gallons  
Meter Mechanism . . . . . Oval Gear  
Inlet Size . . . . . 1/2"(F)  
Flow Range . . . . . 0.26 to 7.9 Gals/Min  
Accuracy . . . . . ±.5%  
Repeatability . . . . . ±.2%  
Power . . . . . Four (4) 1.5-volt AA Batteries

### FLUID COMPATIBILITY



Automatic  
Transmission Fluid



Gear Oil



Hydraulic Oil



Motor Oil



Synthetic Oil

900 SERIES DIGITAL PRESET METERS

CONTROL VALVES & METERS



	TIM-900B-1	TIM-901B-1	TIM-901B-HF
Unit of Measure	Pts/Qts/Lts/Gals	Pts/Qts/Lts/Gals	Pts/Qts/Lts/Gals
Tip Extension	TIM-758-1	TIM-756-1	TIM-755-1
Tip Extension Description	Rigid Automatic	Flex Automatic	Flex Manual Hi-Flow
Tip Diameter	1/2"	1/2"	15/16"
Working Flow Rate	2.5 GPM	2.5 GPM	4 GPM

All 900 Series meters include a black swivel guard. For other color swivel guards see page 59.

Tip Extension



\* Tips are NOT backward compatible with black TIM-900-1 and grey TIM-900A-1 handles.

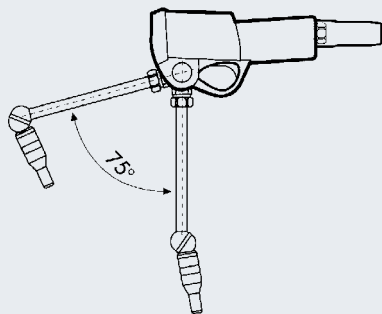

All TIM-900 Series digital preset meters have a swiveling extension. Units equipped with rigid extensions also have a rotatable automatic non-drip tip.



## MECHANICAL PRESET METERS

### BALANCED DESIGN

Preset mechanical meters have a light-weight, balanced design for ease of use

### IMPACT RESISTANT

An impact resistant nylon shroud protects the meter's knob and register dial

### TRIGGER GUARD

Built-in trigger guard which helps prevent accidental dispensing

### MANUAL TIPS

Units come equipped with manual Hi-Flow non-drip tips

### INLET SWIVEL

1/2" (F) swivel comes standard on all mechanical style meters



TIM-911-HF

Operating Pressure
1,000 PSI Max.

Operating Temperature
45° to 110° F

Weight
4 lbs

### SPECIFICATIONS

Inlet Size . . . . . 1/2"(F)  
 Flow Range . . . . . 0.4 to 3.0 Gals/Min  
 Accuracy – Preset . . . . . ±.3%  
 Accuracy – Mechanical . . . . . ±.65%

### FLUID COMPATIBILITY

Automatic Transmission Fluid	Gear Oil	Hydraulic Oil
Motor Oil	Synthetic Oil	



TIM-910-HF



TIM-911-HF



TIM-912-HF

	TIM-910-HF	TIM-911-HF	TIM-912-HF
Metered Units	16 Quarts	60 Quarts	60 Gallons
Totalizer Units	Quarts	Quarts/Gallons	Gallons
Tip Assembly	TIM-743-RHF	TIM-743-RHF	TIM-743-RHF
Description	Rigid Manual Hi-Flow	Rigid Manual Hi-Flow	Rigid Manual Hi-Flow
Tip Diameter	15/16"	15/16"	15/16"
Working Flow	3 GPM	3 GPM	3 GPM

Order optional colored swivel guards separately. See page 59.

1/2" IN-LINE METERS



**TIM-615**



**TIM-616**

Type	Digital	Mechanical
Inlet/Outlet	1/2" NPT (F)	1/2" NPT (F)
Fluid Compatibility	Fluid Lubricants	Fluid Lubricants
Metered Units	Pts/Qts/Lts/Gals	Quarts
Totalizer Units	Liters/Gallons	Quarts
Working Flow Rate	1 to 32 Qts/Min	1 to 32 Qts/Min
Maximum PSI	1,000 PSI	1,000 PSI

CONTROL VALVES & METERS

3/4" - 1-1/2" IN-LINE DIGITAL METERS

In-line fluid meters allow for easy monitoring of fluid dispensing. The following digital electronic meters include two (2) 1.5V "N" style batteries (AAA batteries). Accuracy within the flow range is ± .5%, and repeatability is ± .2%.



**TIM-717-1**



**TIM-717-2**



**TIM-717-3**

Inlet/Outlet	3/4"(F)	1"(F)	1-1/2"(F)
Fluid Compatibility	Lubricating Oils, Diesel Fuel & Antifreeze Mixtures	Lubricating Oils, Diesel Fuel & Antifreeze Mixtures	Lubricating Oils, Diesel Fuel & Antifreeze Mixtures
Metered Units	Pts/Qts/Lts/Gals	Pts/Qts/Lts/Gals	Pts/Qts/Lts/Gals
Totalizer Units	Gallons	Gallons	Gallons
Working Flow Rate	1.3 to 13 Gals/Min	2.6 to 26 Gals/Min	4 to 40 Gals/Min
Maximum PSI	1,000 PSI	435 PSI	290 PSI

## 760 SERIES NON-METERED CONTROL VALVES

### MORE CHOICES

760 Series control valves come in a wide variety of configurations. Two valve styles and seven different tips allow you to choose the valve that best fits your application

### LIGHT WEIGHT

Valve valves are made of aluminum creating a lightweight, perfectly-balanced design

### IMPACT RESISTANT

Rugged impact-resistant design stands up to the harshest environments

### FILTER

All 760 Series control valves have built-in filters for added protection

### TRIGGER GUARD

All Trigger Guard (TG) style valves have a built-in trigger guard which helps prevent accidental dispensing

### TRIGGER LOCK

All TG style valves have a built-in trigger lock, allowing hands-free operation

### NON-DRIP TIPS

Valves are available in both manual and automatic non-drip tip configurations

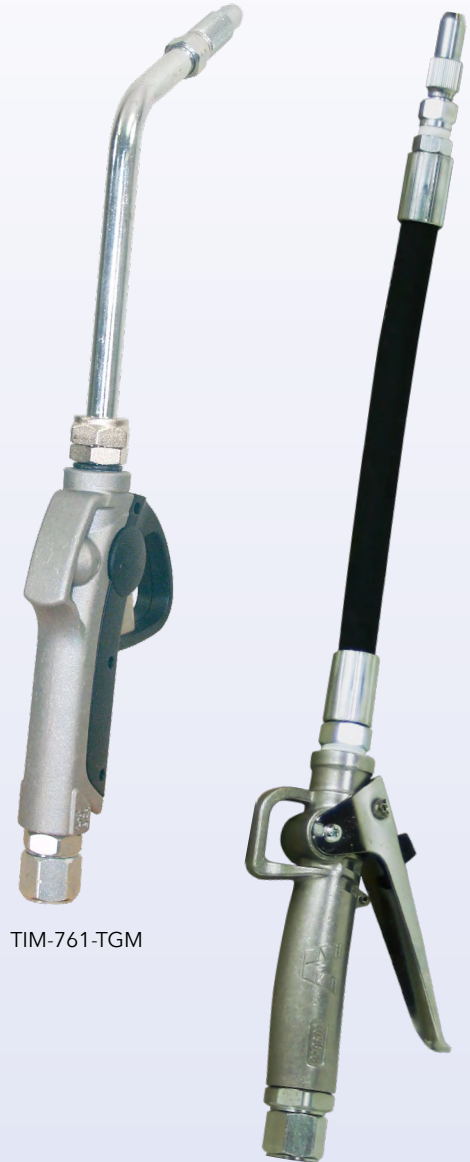

TIM-761-TGM

TIM-762

Operating Pressure
1,000 PSI

Weight (TIM-761)
1.9 lbs

Weight (TIM-761-TG)
1.6 lbs

### SPECIFICATIONS

Inlet Size . . . . . 1/2"(F)  
 Flow Range . . . . . 0.4 to 4.0 Gals/Min

### FLUID COMPATIBILITY

		
Automatic Transmission Fluid	Gear Oil	Hydraulic Oil
		
Motor Oil	Synthetic Oil	

### TG STYLE NON-METERED CONTROL VALVES

	Description	Tip Extension	Tip Diameter	Working Flow Rate
<b>TIM-761-TG</b>	Rigid Automatic	TIM-746	1/2"	2.5 GPM
<b>TIM-761-TGM</b>	Rigid Manual	TIM-753	1/2"	2.5 GPM
<b>TIM-761-TGHF</b>	Rigid Hi-Flow Manual	TIM-752	15/16"	4 GPM
<b>TIM-761-TGGO</b>	90° Rigid Manual	TIM-742	1/2"	2.5 GPM
<b>TIM-762-TG</b>	Flex Manual	TIM-743	5/8"	2.5 GPM
<b>TIM-762-TGA</b>	Flex Automatic	TIM-747	1/2"	2.5 GPM
<b>TIM-762-TGHF</b>	Flex Hi-Flow Manual	TIM-743-1	15/16"	4 GPM

Order optional colored swivel guards separately. See page 59.



TIM-762-TG

CONTROL VALVES & METERS

### STANDARD NON-METERED CONTROL VALVES

	Description	Tip Extension	Tip Diameter	Working Flow Rate
<b>TIM-761</b>	Rigid Automatic	TIM-746	1/2"	2.5 GPM
<b>TIM-761-M</b>	Rigid Manual	TIM-753	1/2"	2.5 GPM
<b>TIM-761-HF</b>	Rigid Hi-Flow Manual	TIM-752	15/16"	4 GPM
<b>TIM-761-GO</b>	90° Rigid Manual	TIM-742	1/2"	2.5 GPM
<b>TIM-762</b>	Flex Manual	TIM-743	5/8"	2.5 GPM
<b>TIM-762-A</b>	Flex Automatic	TIM-747	1/2"	2.5 GPM
<b>TIM-762-HF</b>	Flex Hi-Flow Manual	TIM-743-1	15/16"	4 GPM

Order optional colored swivel guards separately. See page 59.



TIM-761-M

#### Tip Extensions



TIM-743

TIM-753

TIM-747

TIM-746

TIM-742

TIM-752

TIM-743-1

# ARO NON-METERED CONTROL VALVES



## FILTER

All ARO non-metered control valves have built-in filters for added protection

## TRIGGER LOCK

Valves have a built-in trigger lock, allowing hands-free operation

## SWIVEL

Standard control valves include 1/2" swivel. Order swivels for Hi-Flow versions separately

## 5-YEAR WARRANTY

All ARO standard and Hi-Flow non-metered control valves come with a 5-year limited warranty



635395-2

635193

CONTROL VALVES & METERS







Weight (635392)  
**2.2 lbs**

Weight (635193)  
**3.2 lbs**

### SPECIFICATIONS

- Inlet Size (Standard) . . . . . 1/2" NPT (F)
- Inlet Size (Hi-Flow) . . . . . 3/4" NPT (F)
- Flow Range (Standard) . . . . . 0.4 to 3 Gals/Min
- Flow Range (Hi-Flow) . . . . . 0.4 to 10 Gals/Min

### FLUID COMPATIBILITY

-   
Antifreeze Mixtures
-   
Automatic Transmission Fluid
-   
Gear Oil
-   
Hydraulic Oil
-   
Motor Oil
-   
Synthetic Oil

### NON-METERED VALVES



**635392\***



**635193‡**



**635395-2‡**

Type	Standard	Hi-Flow	Hi-Flow
Used On	3:1, 5:1 & 9:1 Pumps	1:1, 3:1 & 5:1 Pumps	9:1 Pumps
Description	Flexible Manual Non-Drip	Flexible Manual Non-Drip	Flexible Manual Non-Drip
Inlet	1/2"(F)	3/4"(F)	3/4"(F)
Tip Diameter	1/2"	1-1/8"	1-1/8"
Maximum PSI	1,000 PSI	600 PSI	900 PSI

\* Order optional colored swivel separately.

‡ ARO Hi-Flow non-metered valves do not include an inlet swivel. Order optional swivel (635108) separately, see page 59.

## HI-FLOW SWIVEL

**635108**

Fluid Compatibility	Engine Oils & Antifreeze
Description	For Use on ARO Hi-Flow Non-Metered Valves
Inlet/Outlet	3/4"(M) x 3/4"(F)
Maximum PSI	1,000 PSI



635108

## HI-FLOW/MEDIUM PRESSURE OIL NOZZLE

**TIM-48-S**

Fluid Compatibility	Fluid Lubricants
Inlet	3/4" swivel (F)
Shut Off Style	Semi-Automatic
Working Flow Rate	20 GPM
Maximum PSI	1,450 PSI



TIM-48-S

## WATER & ANTIFREEZE BIBBS

Low volume dispensing valves for water or antifreeze.

**TIM-94-MI**

Spout	Neoprene
Pressure Rating	300 PSI
Inlet	1/4"(F)

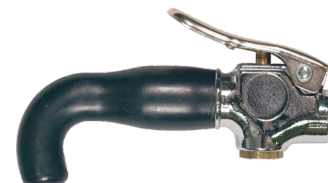

TIM-94-MI

## SWIVEL GUARDS

Ideal for color coding products. Swivel guard helps protect cars from damage. Can be used on any ARO or American Lubrication oil control valve with a 1/2" swivel inlet.



**TIM-720-BLU**



**TIM-720-YEL**



**TIM-720-BLK**



**TIM-720-GRN**



**TIM-720-RED**

Color	Blue	Yellow	Black	Green	Red
-------	------	--------	-------	-------	-----

CONTROL VALVES & METERS



STANDARD, BOOSTER & HI-FLOW CONTROL VALVES



CONTROL VALVES & METERS



TIM-794

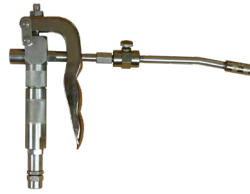

TIM-795-1



636111

Inlet/Outlet	1/4"(F)	1/4"(F)	1/8"(M) & 3/8"(F)
Maximum Inlet PSI	7,500 PSI	7,500 PSI	7,500 PSI
Description	<b>Heavy-Duty Grease Control Valve</b> Includes whip hose and coupler.	<b>Heavy-Duty Booster Control Valve</b> Built-in trigger booster feature delivers up to 7,500 PSI to break loose tough fittings. Includes manual pressure vent for easy disconnect. Do not use with whip hose.	<b>ARO Heavy-Duty Grease Control Valve</b> Standard high-pressure grease control handle with inlet filter. Shipped with adapter to allow either 1/8"(M) or 3/8"(F) inlet. Maximum working 7,500 PSI.

GREASE SWIVELS & ACCESSORIES

	Type	Thread Size	Maximum PSI	Used On
<b>TIM-111-1</b>	Z-Swivel	1/4"(M) x 1/4"(F)	6,000 PSI	Existing Balcrank, Graco & American Lube Grease Systems
<b>TIM-113</b>	Z-Swivel	3/8"(F) x 1/4"(M)	6,000 PSI	3/8" ID Grease Hoses
<b>TIM-115</b>	Z-Swivel	1/8"(F) x 3/8"(F)	6,000 PSI	3/8" ID Grease Systems
<b>TIM-116</b>	Z-Swivel	1/8"(M) x 1/8"(F)	6,000 PSI	1/4" ID Grease Hoses
<b>636088</b>	Z-Swivel	3/8"(M) x 3/8"(F)	8,000 PSI	3/8" ID High-Volume Grease Systems
<b>636075</b>	Straight	1/8"(M) x 1/8"(F)	8,000 PSI	Grease Systems
<b>636085</b>	Straight	3/8"(M) x 3/8"(F)	8,000 PSI	Grease Systems



TIM-115



636088

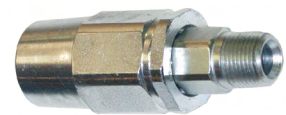

636085

## GREASE GUN COUPLERS



**TIM-100**

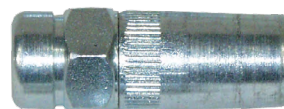

**TIM-101**

Body	Narrow Diameter	Standard Diameter
Thread Size	1/8"(F)	1/8"(F)
Ball Check	Yes	Yes
Maximum PSI	10,000 PSI	10,000 PSI

CONTROL VALVES & METERS

## GREASE WHIP HOSES

High pressure grease whip hoses can be connected to the outlet side of the rigid extension of a grease control valve to allow the service technician to access hard-to-reach fittings. These hose assemblies are constructed of two-wire braid hose and high pressure couplings giving them a working pressure of 5,000 PSI.

**Do not use whip hoses with booster control valve (TIM-795-1).**



**TIM-4360**



**TIM-4361**

Thread Size	1/8"(M) x 1/8"(M)	1/8"(M) x 1/8"(M)
Hose Length	12"	18"
Connection Info	Order TIM-1230 adapter to connect to grease gun extension	Order TIM-1230 adapter to connect to grease gun extension

## OIL BARS

Used as a dispensing option to reels, usually in conjunction with 5-quart measuring containers. Dispensing assembly now includes a custom splash-reduction adapter. Holes are pre-drilled in sides to facilitate the mounting of ready lights for use with fluid inventory control system. Available in single, double or triple spigot configurations. Units feature black powder-coated finish, non-drip spigots, flanged back for easy mounting, drip pan with bright zinc-plated grid and drain port. Shipped complete with mounting bracket and 30" connecting hose with 90° union adapter for easy connection to fluid line. All oil bars have the same dimensions: 23" H x 22" W x 15" D (above the drip pan). Metered units are equipped with TIM-615 digital quart meter.

OIL BARS



TIM-3-A

## SPIGOT REPAIR KIT

**TIM-OILSPIGOT-KIT** Spigot Repair Kit  
Oil Bar (TIM-5-A2) and taper spigot (TIM-724-1B) repair kit

	TIM-1-A	TIM-1A-DM	TIM-2-A	TIM-2A-DM	TIM-3-A	TIM-3A-DM
Number of Spigots	1	1	2	2	3	3
Metered or Non-Metered	Non-Metered	Metered	Non-Metered	Metered	Non-Metered	Metered



TIM-1-A



TIM-2-A



TIM-3A-DM

**OIL BAR ACCESSORIES**

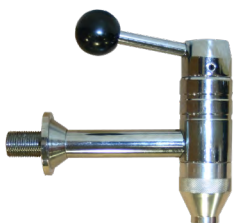

**TIM-5-A2**

**Oil Bar Spigot**

Replacement spigot for oil bars. 1/2" NPT (M) threads.



**TIM-6**

**Oil Bar Adapter Kit**

Used to connect fluid dispensing system solenoid valve to oil bar. Use one (1) kit per outlet.



**TIM-500-FV**

**Flow Control Valve**

Used in the material line that supplies the oil bar to control and adjust the delivery rate and prevent splashing

OIL BARS

**MEASURING CONTAINERS & ACCESSORIES**



**TIM-30-5A**

**6-Pack of 5-Quart Graduated Measuring Containers**

Units include an easy-open hinged lid to help protect from contaminants. Color is transparent white for easy viewing of liquid level. Box contains six (6) units.



**TIM-30-11A**

**Plastic Replacement Spout For TIM-30-5A**

**TOUCHSCREEN DESIGN**

State of the art touchscreen eliminates dated keypad design

**TWO PRODUCT CAPABILITY**

The 2003-P2 can dispense two products to 12 stations (6 stations per product)

**EASY TO OPERATE**

Touchscreen display prompts the user with operating instructions

**PRODUCT NAME DISPLAY**

Touchscreen can be set up to display any of 22 pre-programmed product descriptions with capability to add 5 additional products

**PASSWORD PROTECTION**

Programmable password protection prevents unauthorized use

**EXTREMELY ACCURATE**

Field calibrateable for the highest level of accuracy

**CHANGEABLE UNIT OF MEASURE**

Can be programmed in the field for Pints, Quarts, Gallons or Liters

**WALL MOUNTABLE/COMPACT DESIGN**

Touchscreen and expander/junction box include built-in wall mount feature for ease of installation. Wall mounted boxes take up less space and gets wiring out of the way of the user

**PRINTER CAPABLE**

Will work with any serial port printer. (Customer must purchase separately)



FLUID INVENTORY CONTROL SYSTEM

**SPECIFICATIONS**

System Capacity . . . .	Single Product, 1 to 12 Dispensing Points or 2 Products, 1 to 6 Dispensing Points Each
System Requirements . .	Properly Sized Thermal Relief Kit Required
Electrical Requirements . . . . .	120 VAC, 60HZ
Pulse Meter . . . . .	1,000 PSI Max, 1/2" NPT (F)
Fluid Solenoid . . . . .	3,000 PSI Max, 1/2" NPT (F)
Wiring Requirements . . . . .	22 Ga = <150'
	18 Ga = 151' - 250'
	16 Ga = 251' - 500'

**FLUID COMPATIBILITY**

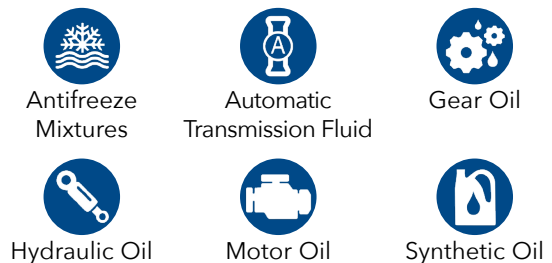

2003

**Fluid Inventory Control System**

Includes touchscreen, expander/junction box, 14' connection cable (not shown), pulse meter, 1/2" fluid solenoid valve, ready light assembly, 1/2" union adapter and power supply. Handles one product to one dispensing point. Expandable to handle up to twelve dispensing points for one product by ordering additional TIM-2000-1 add-on station kits. Can be connected to an air solenoid safety kit (order separately). Touchscreen can be wall mounted using built-in mounting feature.

*Requires either TIM-2000-4 or TIM-2000-4A pressure relief kit (order separately)*





<b>2003-P2</b>	<p><b>Fluid Inventory Control System</b>                  For two product applications. Same as 2003 except with an additional pulse meter, fluid solenoid and ready light. Expandable up to six dispensing points per product by ordering additional TIM-2000-1 add-on station kits.  <i>Requires either TIM-2000-4 or TIM-2000-4A pressure relief kit (order separately)</i></p>
<b>2003-REP</b>	<p><b>Fluid Inventory Control System</b>                  Includes touchscreen, expander/junction box, 14' connection cable (not shown) and power supply. Can be used to replace TIM-2002 Big ALEC IV.</p>



2003-REP

**ACCESSORIES**

<b>2003-14CAT</b>	<p><b>14' Connector Cable</b>                  Used to connect the touchscreen to the expander/junction box.</p>
<b>TIM-2000-1</b>	<p><b>Add-On Station Kit</b>                  For adding additional dispensing stations to the control console. Includes 3,000 PSI 1/2" fluid solenoid valve with inlet filter, 1/2" union adapter and ready light assembly.</p>
<b>TIM-2000-2</b>	<p><b>1/4" Air Solenoid Safety Kit</b>                  For pumps with 1/4" air inlets. Shuts off air flow to the pump when fluid inventory control system is inactive. Helps prevent potential oil spills. Must be connected to expander/junction wiring box.</p>
<b>TIM-2000-2A1</b>	<p><b>1/2" Air Solenoid Safety Kit</b>                  For pumps with 1/2" air inlets. Shuts off air flow to the pump when fluid inventory control system is inactive. Helps prevent potential oil spills. Must be connected to expander/junction wiring box.</p>
<b>TIM-2000-3A</b>	<p><b>Wire Spool</b>                  500' spool of 2-conductor 22-gauge wire</p>
<b>TIM-2000-4</b>	<p><b>600 PSI Pressure Relief Kit</b>                  Relieves pressure build-up in the fluid line due to thermal expansion. Must be plumbed back to oil supply tank. Use on 3:1 and 5:1 pumps.  <i>A pressure relief kit is required on all 2003 fluid inventory control systems</i></p>
<b>TIM-2000-4A</b>	<p><b>900 PSI Pressure Relief Kit</b>                  Relieves pressure build-up in the fluid line due to thermal expansion. Must be plumbed back to oil supply tank. Use on pumps with ratios above 5:1.  <i>A pressure relief kit is required on all 2003 fluid inventory control systems</i></p>
<b>TIM-2000-5</b>	<p><b>Replacement Pulse Meter</b>                  1,000 PSI maximum working pressure, 1/2" NPT (F)  <i>Not for use with antifreeze.</i></p>
<b>TIM-2000-6A</b>	<p><b>1/2" Y-Strainer</b>                  Used for keeping contaminants out of the system.</p>
<b>TIM-365-5S</b>	<p><b>Pulse Meter</b>                  1,000 PSI maximum working pressure, 1/2" NPT (F). 40 pulse per gallon old style mechanical pulse meter for older Big ALEC and Little ALEC systems. Will also work on many competitive systems which use mechanical pulse meters. Handles antifreeze and antifreeze solutions as well as oils.  <i>Should be used in place of standard pulse meter when pumping antifreeze</i></p>
<b>TIM-6</b>	<p><b>Oil Bar Adapter Kit</b>                  Used to connect fluid dispensing system solenoid valve to an oil bar. Use one kit per outlet.</p>

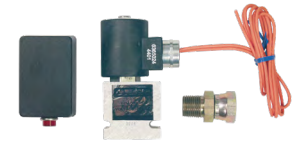

TIM-2000-1



TIM-2000-2  
TIM-2000-2A1



TIM-2000-3A



TIM-2000-4  
TIM-2000-4A



TIM-2000-5

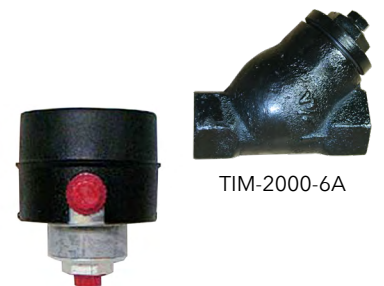

TIM-2000-6A

TIM-365-5S



TIM-6

FLUID INVENTORY CONTROL SYSTEM



## SELF-EVACUATING WASTE OIL DRAINS

### SELF-EVACUATING

Connect the house air supply directly to the preset regulator to evacuate the oil from the drain into any bulk waste oil storage tank

### HEAVY-DUTY

Heavy-duty all-steel tank stands up to the harshest environments

### LARGE CAPACITY

24-gallon capacity allows user to perform more oil changes before having to evacuate the unit

### DRAIN BOWL

Metal drain bowl has built-in filter screen to prevent foreign matter from entering the drain

### EXPANSION FUNNEL

Removable plastic drain bowl expansion funnel with built-in filter screen provides support for draining oil filters

### DRAIN HOSE

Clear discharge hose with curved nozzle simplifies evacuation

### BUILT-IN FLUID GAUGE

Allows operator see the oil level in the waste oil drain

### SAFETY

Unit incorporates a tamper resistant air regulator with air gauge and a safety pop-off valve to prevent over pressurization

### 4-WHEEL SWIVEL DESIGN

Allows easy maneuverability, including on uneven surfaces

### DRAIN PLUG

1" drain plug on the bottom of the unit for easy cleaning



TIM-317-A

#### TIM-317-A

##### Self-Evacuating "Pumpless" Waste Oil Drain

Uses standard shop air set at 8 PSI to evacuate the drain into a waste oil holding tank. 24-gallon steel tank for use with used oils. Safety pop-off valve prevents over pressurization. Includes removable storage tray, built-in fluid gauge, 7' discharge hose with curved nozzle and manual shut-off valve, articulating 15-3/4" diameter metal drain bowl (TIM-317-37C) with oil filter draining screen and 24" removable plastic drain bowl expansion funnel (TIM-317-39). Stem adjusts 51" to 78". Powder-coated black paint. Assembly required.

Order 2608 air connector and 210 air coupler separately

#### TIM-317-CAM

##### Self-Evacuating "Pumpless" Waste Oil Drain

Uses standard shop air set at 8 PSI to evacuate the drain into a waste oil holding tank. 24-gallon steel tank for use with used oils. Safety pop-off valve prevents over pressurization. Includes removable storage tray, built-in fluid gauge, 6' discharge hose with camlock connector and manual shut-off valve, articulating 15-3/4" diameter metal drain bowl with oil filter draining screen and 24" removable plastic drain bowl expansion funnel. Stem adjusts 51" to 78". Powder-coated black paint. Assembly required.

This unit is designed to work in conjunction with TIM-CONV-CAM conversion hose kit and TIM-370-3M overfill alarm which must be ordered separately

#### TIM-317-AAM

##### Self-Evacuating Transmission Drain

Same as TIM-317 except equipped with steel transmission drain pan (TIM-317-PAN) instead of drain bowl. Collecting area of pan is 32" x 21-3/4".

#### TIM-CONV-CAM

##### Hose Kit

Facilitates the connection between the TIM-317-CAM self-evacuating waste oil drain and the waste oil tank. The kit contains a 3/4" x 10' oil evacuation hose, 3/4" camlock coupler, air coupler, 1/4" x 12' recoil air hose (for connection to the TIM-370-3M overfill alarm) and a poster with operating instructions for the TIM-317-CAM drain.

## 24-GALLON CONVENTIONAL WASTE OIL DRAIN

### HEAVY-DUTY

Heavy-duty all-steel tank stands up to the harshest environments

### LARGE CAPACITY

24-gallon capacity allows user to perform more oil changes before having to evacuate the unit

### DRAIN PAN

Metal drain bowl has built-in filter screen to prevent foreign matter from entering the drain

### EXPANSION FUNNEL

Removable plastic drain bowl expansion funnel with built-in filter screen provides support for draining oil filters

### BUILT-IN FLUID GAUGE

Allows operator see the oil level in the waste oil drain

### 4-WHEEL DESIGN

Allows easy maneuverability, including on uneven surfaces

### DRAIN PLUG

1" drain plug on the bottom of the unit for easy cleaning



TIM-315-COMP2

### TIM-315-COMP2

#### Large Capacity Waste Oil Drain

24-gallon (90 liter) steel waste oil drain for use with waste oil evacuation pumps. Holds 50% more waste oil than standard 16-gallon drum-mounted waste oil drains. Unit has an articulating 15-3/4" diameter metal drain bowl with an oil filter draining screen and a 24" removable plastic drain bowl expansion funnel. Single piece holding tank prevents oil leaks commonly associated with waste oil drains that use 16-gallon drums. Includes removable storage tray, built-in fluid gauge and 3/4" fluid quick disconnect (TIM-181). Designed to work with 612999-4 and 612999-5 waste oil evacuation systems. Stem adjusts 48-1/2" to 76". Powder-coated black paint.

Replaces TIM-315-A and TIM-315-1A waste oil drains

*Assembly required*

## LABELING KITS

### TIM-LABEL-KIT

#### Antifreeze Label Kit

Includes four (4) 11" x 2" *Antifreeze Only* labels and one (1) 2" x 2" *Evacuate Drain Into Waste Antifreeze Tanks Only* labels. Ideal for use with TIM-317-A self-evacuating waste oil drains and TIM-315-COMP2 waste oil drains.

### WASTE-LABEL-KIT

#### Waste Oil Label Kit

Includes four (4) 11" x 2" *Waste Oil Only* labels and one (1) 2" x 2" *Evacuate Drain Into Waste Oil Tanks Only* labels. Ideal for use with TIM-317-A self-evacuating waste oil drains and TIM-315-COMP2 waste oil drains.



TIM-LABEL-KIT  
(labels only, container not included)

## SELF-EVACUATING WASTE OIL EXTRACTORS

### SELF-EVACUATING

Connect the house air supply directly to the preset regulator to evacuate the oil from the drain into any bulk waste oil storage tank

### LARGE CAPACITY

24-gallon capacity allows user to perform more oil changes before having to evacuate the unit

### SUCTION WANDS

Variety of flexible wands and adapters included

### VACUUM GAUGE

Robust gauge ensures peak performance

### BUILT-IN FLUID GAUGE

Allows operator see the oil level in the waste oil drain

### 4-WHEEL SWIVEL DESIGN

Allows easy maneuverability, including on uneven surfaces

### DRAIN PLUG

1" drain plug on the bottom of the unit for easy cleaning



TIM-341

#### Self-Evacuating Waste Oil Extractor

24-gallon waste oil extractor utilizes shop air to extract oil via suction probes directly into the units holding tank. Collecting waste oil can then be evacuated from the 24-gallon tank into larger waste oil tanks using shop air. Features an easy to read vacuum gauge for suction and safety pop-off valve to prevent over pressurization. Includes removable storage tray, built-in fluid gauge, 7' discharge hose, suction hose and 6-piece probe set. Power-coated black paint.

Assembly required.

TIM-340

#### Self-Evacuating Combo Waste Oil Extractor/Drain

24-gallon combination waste oil extractor/drain utilizes shop air to extract oil via suction probes directly into the units holding tank as well as the traditional method of draining oil through the drain bowl into the tank. Collected waste oil can then be evacuated from the 24-gallon tank into larger waste oil tanks using shop air. Features include 15-3/4" articulating metal drain bowl with 24" plastic expansion funnel and oil filter draining screen, easy to read vacuum gauge for suction and safety pop-off valve to prevent over pressurization. Includes removable storage tray, built-in fluid gauge, 7' discharge hose, suction hose and 6-piece probe set. Power-coated black paint.

Assembly required.

TIM-341



TIM-340

## POLYETHYLENE DRAINS



**TIM-318**

**8-Gallon Waste Oil Drain**

Drain has built-in handle, emptying spout and four (4) wheels for easy maneuvering. Oil level can be viewed through translucent body. Height adjusts from 48" to 65".



**TIM-319**

**18-Gallon Waste Oil Drain**

Drain has built-in handle, emptying spout, 2"(F) NPT opening with plug, gate valve for gravity draining and four (4) wheels for easy maneuvering. Oil level can be viewed through translucent body. Height adjusts from 55" to 73".

## LOW PROFILE TRUCK DRAIN



**TIM-310\***

**20-Gallon Waste Oil & Antifreeze Drain**

For truck maintenance facilities. Heavy-duty steel unit is powder-coated red. Drain has 5" diameter caster wheels, 38" long handle, 3/4"(M) drain connection and elbow. Designed to mate with 612999-4 or 612999-5 diaphragm pump evacuation system. 48" L x 31" W x 7-1/2" H.

\* Order TIM-181-N waste oil evacuation adapter kit separately

## REPLACEMENT BOWLS

<b>TIM-315-KIT</b>	15" Metal Replacement Bowl & Expansion Funnel for TIM-315 Series Drains
<b>TIM-316A-KIT</b>	15" Metal Replacement Bowl & Expansion Funnel for TIM-316 Series Drains
<b>TIM-315-BOWL</b>	15" Metal Replacement Bowl for TIM-315 Series Drains Can be used with TIM-FUNNEL drain expansion funnel
<b>TIM-316A-BOWL</b>	15" Metal Replacement Bowl for TIM-316 Series Drains Can be used with TIM-FUNNEL drain expansion funnel
<b>TIM-317-PAN</b>	<b>Transmission Funnel</b> Steel construction with large collection area measuring 32" x 21-3/4". Adapts to drain model number TIM-317. For use in transmission shops.
<b>TIM-317-37C</b>	15.75" center mount replacement drain bowl for TIM-317-A or TIM-317-CAM waste oil drain
<b>TIM-318-BOWL</b>	16" Replacement Bowl for TIM-318 & TIM-319 Drains



TIM-316A-KIT



TIM-317-PAN

## QUICK-LUBE PIT DRAIN



### QL-308

#### 35-Gallon Rolling Waste Oil Drain

For use in quick-lube facilities or truck maintenance shops. Heavy-duty steel unit is powder-coated yellow. Angled wheels provide easy drain movement and can be adjusted from 34" to 46". Drain bottom is sloped toward the two screened drain holes on the front and the rear of the unit. Drain holes are 1"(M). Drain includes pull handles on the front and rear of the unit, filter screen, and internal baffling. 31" L x 30-3/4" W x 11" H.

Order *TIM-4675 camlock kit*, *TIM-1001-BV ball valve* and *TIM-4416-3* or *TIM-4416-8 suction hose* separately

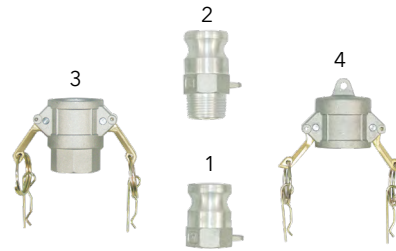

### TIM-4675

#### Waste Oil Adapter Kit

Allows TIM-308-B pit drain to be used in gravity drain or diaphragm pump evacuation systems. Includes 1"(M) camlock adapter (#2) with dust cap (#4) for pit drain, 1" camlock coupler (#3) for suction hose and 1" camlock adapter (#1) to be used as a suction hose hanger.

## DIAPHRAGM PUMP WASTE OIL PACKAGES

WASTE OIL EQUIPMENT



### 612999-4\*

#### Waste Oil Evacuation System

Includes 666100-362-C 1" diaphragm pump, TIM-461-A wall mount bracket, 612999-4H 1" pump inlet hose assembly, 628067-3 1" pump outlet hose assembly, P-39224-624 air line filter/regulator/gauge, AIR-HP1414-3 1/4" air line hose, TIM-180 fluid coupler and TIM-250-BV air valve



### 612999-5\*

Includes 66605J-322 1/2" diaphragm pump, TIM-461-A wall mount bracket, 612999-5H 3/4" pump inlet hose assembly, TIM-4418-5 1/2" pump outlet hose assembly, P-39224-624 air line filter/regulator/gauge, AIR-HP1414-3 1/4" air line hose and TIM-180 fluid coupler

\* Only ARO pumps are covered by the ARO 5-Year Warranty, all other components are covered by standard American Lubrication warranty. For more warranty information, visit page 104.

## DIFFERENTIAL OIL EVACUATION PACKAGE



### 612999-6\*

#### Portable 1/2" Evacuation System

1/2" differential oil evacuation package. Includes 1/2" ported diaphragm pump, tube brackets for hanging the unit from a pit-mounted waste oil drain, 6' fluid suction line, air filter/regulator with gauge and related tubing and fittings.

\* Only ARO pumps are covered by the ARO 5-Year Warranty, all other components are covered by standard American Lubrication warranty. For more warranty information, visit page 104.

## WASTE OIL TANK OVERFILL ALARM



### TIM-370-3M

#### Waste Oil Tank Overfill Alarm & Pump Shut-Off Assembly

Used to shut off the air supply to the pump when the tank approaches full capacity. When the unit shuts the air off to the pump, air is diverted to a whistle mounted on the unit to signal that the tank is full. The valve is automatically reset when the tank is empty and the air pressure is turned off. Mounts into a 2"(F) NPT tank opening. ULC listed under overfill protection devices, type B, for pressure fill applications. Air inlet/outlet 1/4"(F) NPT. 100 PSI maximum. Air flow capacity 20 CFM at 100 PSI.



WASTE OIL ACCESSORIES



**TIM-2000-10**  
1" Y-Strainer

Includes 30 mesh screen. Installs on suction side of waste oil system to prevent contaminants from causing costly damage to the waste oil diaphragm pump.



**TIM-WAND-1**

Waste Oil Evacuation Wand

For TIM-319 waste oil drains. 22" metal tube is coupled to a TIM-181 fluid connector and strainer. Designed to mate with ARO 612999-4 or 612999-5 diaphragm pump evacuation systems.

1" DIAPHRAGM PUMP REVERSING VALVE



**RV-1**

Reversing Valve Assembly

Used in waste oil applications to reverse the flow direction of the diaphragm pump. Inlet and outlet threads are 1"(F). For use with any 1" diaphragm pump.

WASTE OIL EQUIPMENT

WASTE OIL TANK EVACUATION KIT

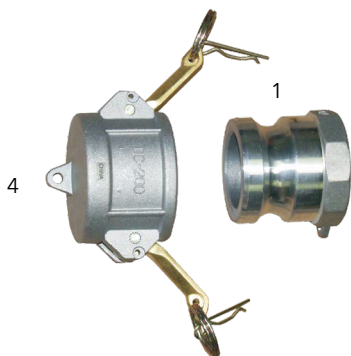

**TIM-4676**

Adapter Kit

Allows for easy evacuation of a waste oil tank. Includes TIM-4676-1 2"(F) camlock adapter (#1) and TIM-4676-4 2" camlock dust cap (#4). Adapter threads directly to a 2" contractor installed suction pipe running from ground level back to the waste oil tank.

## FLUID CONNECTOR KITS

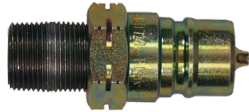

**TIM-181-N**

**Waste Oil Drain Adapter Kit**

Use with TIM-310 truck drain. Enables drains to be used with ARO wall mount oil evacuation systems. Includes 3/4" fluid connector and 3/4" nipple.

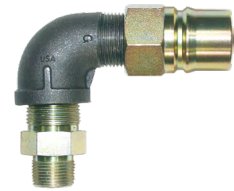

**TIM-181-G**

**Waste Oil Drain Adapter Kit**

Allows American Lubrication drains to be used with existing Graco oil evacuation systems. Includes adapter, street elbow and 1" Graco compatible fluid connector.

## FLUID COUPLERS & CONNECTORS

Used in oil evacuation system for quick disconnect of diaphragm pump and suction discharge hoses.

Thread Size	Fluid Coupler	Fluid Connector	Maximum PSI
1/2"(F)	<b>TIM-178</b>	<b>TIM-179</b>	5,000 PSI
3/4"(F)	<b>TIM-180</b>	<b>TIM-181</b>	3,625 PSI
1"(F)	<b>TIM-182</b>	<b>TIM-183</b>	4,000 PSI



TIM-178



TIM-179

## CAMLOCKS & CONNECTORS

- TIM-4670-1** 3/4" NPT (F) camlock adaptor
- TIM-4670-2** 3/4" NPT (M) camlock adaptor
- TIM-4670-3** 3/4" NPT (F) camlock coupler
- TIM-4670-4** 3/4" dust cap
- TIM-4670-5** 3/4" NPT (M) camlock coupler

- TIM-4675-1** 1" NPT (F) camlock adaptor
- TIM-4675-2** 1" NPT (M) camlock adaptor
- TIM-4675-3** 1" NPT (F) camlock coupler
- TIM-4675-4** 1" dust cap

- TIM-4676-1** 2" NPT (F) camlock adaptor
- TIM-4676-2** 2" NPT (M) camlock adaptor
- TIM-4676-3** 2" NPT (F) camlock coupler
- TIM-4676-4** 2" dust cap

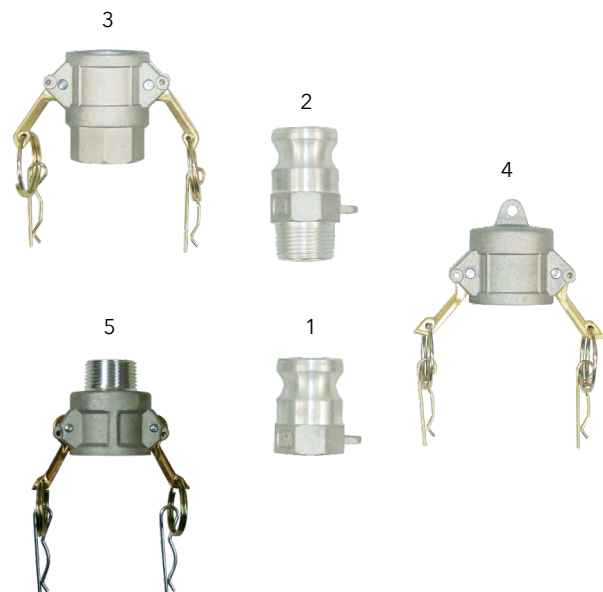

TIM-4670

## BULK OIL TANK PACKAGES

For over 99 years, American Lubrication Equipment Corporation has provided the best solutions for dispensing lubricants. Our pre-assembled tank packages are the most cost-effective way to dispense bulk lubricant in today's marketplace. Tank packages eliminate the expense associated with lubrication equipment installations. With no installation labor or piping costs, you will save hundreds—if not thousands—of dollars.

Our tank packages provide the quickest way to get a new customer up and running. Place an order today and it will leave our factory usually within 48 hours on a truck bound for the location of your choice. When it arrives, simply remove the protective packaging, connect the air hose and fill with oil. It's the fastest way to get your new customer up and running.

### **COST EFFECTIVE**

Tank packages eliminate the installation expense associated with equipment installations

### **SIMPLE**

Remove the protective packaging, connect the air hose, fill with oil, and your customer is up and running

### **FAST DELIVERY**

Large inventory enables most packages to ship within 48 hours

### **MORE CHOICES**

American Lubrication offers the broadest selection of tank packages on the market

### **PROTECTIVE PACKAGING**

Tank packages are covered with custom protective packaging to help protect them from shipping damage

### **ENAMEL PAINT**

All tank packages come standard with an enamel painted finish

### **UL 142 AND N.F.P.A. 30**

All tanks are built to UL 142 and also meet the N.F.P.A. 30 specifications

### **FRESH AND WASTE OIL PACKAGES**

American Lubrication offers single and double-wall packages for fresh oil systems and waste oil systems



275VDW-R23D



Most packages ship within 48 hours



Tanks built to UL 142 specifications



120BC-R23D



250-R25D



270VDW-R23DDT



500RVDW-RWO



165DW-R23D



275A-R23D

## MAIN APPLIES TO ALL PACKAGES

<b>120B</b>	120-Gallon Cube, White	<b>275DW</b>	275-Gallon Horizontal Obround Double-Wall
<b>120BC</b>	120-Gallon Portable Bench (on casters)	<b>275AV</b>	275-Gallon Vertical Obround
<b>120BDW</b>	120-Gallon Double-Wall Bench	<b>275VDW</b>	275-Gallon Vertical Obround Double-Wall
<b>120BCDW</b>	120-Gallon Portable Double-Wall Bench	<b>C500</b>	500-Gallon Cube
<b>150RVDW</b>	150-Gallon Double-Wall Round	<b>C500DW</b>	500-Gallon Double-Wall Cube
<b>165</b>	165-Gallon Bench	<b>500RV</b>	500-Gallon Vertical Round
<b>165DW</b>	165-Gallon Double-Wall Bench	<b>500RVDW</b>	500-Gallon Vertical Double-Wall
<b>250</b>	250-Gallon Bench	<b>525RND</b>	525-Gallon Round Skid
<b>250DW</b>	250-Gallon Double-Wall Bench	<b>525DW</b>	525-Gallon Horizontal Double-Wall
<b>270RVDW</b>	270-Gallon Double-Wall Round	<b>525RDW*</b>	525-Gallon Vertical Round Double-Wall
<b>275A</b>	275-Gallon Horizontal Obround	<b>525RND*</b>	525-Gallon Round Vertical

\* Not a typical in stock item, might have to be special ordered.

## SUFFIX PUMP, REEL & METER PACKAGES

	<b>R13D</b>	<b>R13P</b>	<b>R23D</b>	<b>R23P</b>
Pump	3:1 ARO	3:1 ARO	3:1 ARO	3:1 ARO
Oil Reel	1/2" x 25'	1/2" x 25'	1/2" x 50'	1/2" x 50'
Meter	Quart Digital Meter	Preset Digital Meter	Quart Digital Meter	Preset Digital Meter

	<b>R15D</b>	<b>R15P</b>	<b>R25D</b>	<b>R25P</b>
Pump	5:1 ARO	5:1 ARO	5:1 ARO	5:1 ARO
Oil Reel	1/2" x 25'	1/2" x 25'	1/2" x 50'	1/2" x 50'
Meter	Quart Digital Meter	Preset Digital Meter	Quart Digital Meter	Preset Digital Meter

### TAPPER PUMP PACKAGES

### WASTE OIL PACKAGES

	<b>R33</b>	<b>R33D</b>	<b>RWO</b>	<b>RWOA</b>
Pump	3:1 ARO	3:1 ARO	Diaphragm Pump	1" ARO
Accessories	Tapper	Tapper	Hose End	Non-Spill Coupler
Meter	No	Digital Quart In-Line	Overfill Alarm	No
				TIM-370-3M

## ORDERING INFORMATION

Main

Suffix

(Pick from charts above)

Example: To order a 275-gallon horizontal obround tank package with a 3:1 pump, 1/2" x 50' black Advantage Plus Series reel and digital meter you would go to the Main column and select "275A", and then go to the Suffix column and under "Pump, Reel & Meter Packages" select "R23D". The final model number would be "275A-R23D".



	Gallons	Length	Width	Height	Gauge
<b>UL Bench (Single Wall)</b>					
<b>165B</b>	170	33"	36"	37"	12
<b>250B</b>	249	60"	30"	36"	12
<b>UL Bench (Double Wall)</b>					
<b>165BDW</b>	170	45"	35"	37"	12
<b>250BDW</b>	249	69"	32"	36"	12
<b>UL Obround Tanks - Vertical &amp; Horizontal (Single Wall)</b>					
<b>275H</b>	268	60"	27"	47"	12
<b>275V</b>	268	44"	27"	62"	12
<b>UL Obround Tanks - Vertical &amp; Horizontal (Double Wall)</b>					
<b>275HDW</b>	268	61"	27"	47"	12
<b>275VDW</b>	265	45"	27-3/4"	62"	12
<b>UL Cube (Single Wall)</b>					
<b>120B*</b>	120	23"	34"	37.75"	12
<b>120BC*</b>	120	23"	34"	45"	12
<b>500C</b>	498	61"	34"	64"	10
<b>UL Cube (Double Wall)</b>					
<b>120BDW*</b>	120	34"	32"	40"	12
<b>120BCDW*‡</b>	120	34"	32"	40"	12
<b>500CDW</b>	499	72"	34"	64"	10
<b>UL Round Tanks - Vertical &amp; Horizontal (Single Wall)</b>					
<b>500RV</b>	495	50"	50"	64"	12
<b>525RH</b>	525	46"	74"	46"	12
<b>UL Round Tanks - Vertical &amp; Horizontal (Double Wall)</b>					
<b>150RVDW</b>	150	31"	31"	50"	12
<b>270RVDW</b>	264	36"	36"	60"	12
<b>500RVDW</b>	490	50"	50"	64"	12
<b>525RHDW</b>	525	46"	74"	46"	12

All tanks on these sheets are painted with red enamel and are **U.L. 142**.

\* 120-Gallon tanks are painted white.

‡ Tank is mounted on casters.

All dimensions shown reflect outside measurements including lips, reel brackets, and lifting lugs. These measurements may vary slightly.

All prices are FOB from shipping point, either Hunt Valley, MD or Anaheim, CA.

All tanks include a reel mount bracket.

Drawings available upon request.

**Warranty:** We are advised that each tank is tested by the manufacturer at the factory before shipment in accordance with applicable Underwriters Laboratories standards, NFPA 30, 30A, or 31, OSHA and Uniform Fire Code requirements. Damage may occur during shipment that is not apparent by visual inspection. National and state codes require testing at the job site by the installer BEFORE installation. Single-wall tanks should be pressurized to a maximum of 3 PSI while all welds are tested with a soap solution as stated in instructions on the tank. Double-wall tanks must be tested in accordance with Petroleum Equipment Institute recommended practice RP100 or RP200 or with the manufacturer's published procedures. Tanks must be installed in strict accordance with NFPA 30, NFPA 30A or NFPA 31.

We assume no responsibility for damages, consequential or otherwise, resulting from defects in tanks or for damage to tanks occurring during shipment or installation. Manufacturers of these tanks generally limit their responsibility to repair or replacement of the tank for defects in workmanship or material. Any manufacturer's warranties will be passed through to the purchaser.



## ROTH TANK PACKAGES

American Lubrication Equipment Corporation has partnered with Roth Tanks to offer double-wall lube tank packages. These packages are suitable for storing and dispensing engine oils, gear oils, transmission oils and hydraulic oils. Four different size tank packages are offered: 110-gallon, 165-gallon, 275-gallon and 400-gallon.



**UNIQUE DOUBLE-WALL CONSTRUCTION** The outer tank is made of leak-proof, weld-free galvanized steel and roll-seamed with an oil and fire-resistant seal. It can contain 110 percent of the capacity of the inner tank for maximum protection. The inner tank is made of blow-molded high-density, seamless polyethylene.

**RUST RESISTANT** Inner and outer wall will never rust or corrode

**LEAK INDICATOR** All Roth tanks are equipped with visible optical leak alarm

**LIGHTWEIGHT** Wide handles and lightweight design makes Roth tanks easy to move before filling with oil

**WARRANTY** Roth tanks carry a 30-year limited warranty from the manufacturer

	Gallons	Length	Width	Height	Weight
<b>110-Gallon</b>	110	29"	28"	44"	106 lbs
<b>165-Gallon</b>	165	29"	28"	61"	132 lbs
<b>275-Gallon</b>	275	43"	28"	61"	167 lbs
<b>400-Gallon</b>	400	64"	30"	72"	333 lbs

**OIL PUMP PACKAGES**

	Pump	Reel	Control Handle
<b>110-RTDW-R23N</b>	3:1	50'	Non-Metered
<b>110-RTDW-R23D</b>	3:1	50'	Digital
<b>110-RTDW-R23P</b>	3:1	50'	Preset Digital
<b>110-RTDW-R25N</b>	5:1	50'	Non-Metered
<b>110-RTDW-R25D</b>	5:1	50'	Digital
<b>110-RTDW-R25P</b>	5:1	50'	Preset Digital
<b>110-RTDW-X3X</b>	3:1	---	---
<b>110-RTDW-X5X</b>	5:1	---	---

	Pump	Reel	Control Handle
<b>275-RTDW-R23N</b>	3:1	50'	Non-Metered
<b>275-RTDW-R23D</b>	3:1	50'	Digital
<b>275-RTDW-R23P</b>	3:1	50'	Preset Digital
<b>275-RTDW-R25N</b>	5:1	50'	Non-Metered
<b>275-RTDW-R25D</b>	5:1	50'	Digital
<b>275-RTDW-R25P</b>	5:1	50'	Preset Digital
<b>275-RTDW-X3X</b>	3:1	---	---
<b>275-RTDW-X5X</b>	5:1	---	---

	Pump	Reel	Control Handle
<b>165-RTDW-R23N</b>	3:1	50'	Non-Metered
<b>165-RTDW-R23D</b>	3:1	50'	Digital
<b>165-RTDW-R23P</b>	3:1	50'	Preset Digital
<b>165-RTDW-R25N</b>	5:1	50'	Non-Metered
<b>165-RTDW-R25D</b>	5:1	50'	Digital
<b>165-RTDW-R25P</b>	5:1	50'	Preset Digital
<b>165-RTDW-X3X</b>	3:1	---	---
<b>165-RTDW-X5X</b>	5:1	---	---

	Pump	Reel	Control Handle
<b>400-RTDW-R23N</b>	3:1	50'	Non-Metered
<b>400-RTDW-R23D</b>	3:1	50'	Digital
<b>400-RTDW-R23P</b>	3:1	50'	Preset Digital
<b>400-RTDW-R25N</b>	5:1	50'	Non-Metered
<b>400-RTDW-R25D</b>	5:1	50'	Digital
<b>400-RTDW-R25P</b>	5:1	50'	Preset Digital
<b>400-RTDW-X3X</b>	3:1	---	---
<b>400-RTDW-X5X</b>	5:1	---	---

**TAPPER PUMP PACKAGE**

	Pump	Tapper & Drip Tray
<b>110-RTDW-R33T</b>	3:1	Included

**OIL BAR PUMP PACKAGE**

	Pump	Single Spigot Oil Bar
<b>165-RTDW-3BAR</b>	3:1	Included
<b>275-RTDW-3BAR</b>	3:1	Included
<b>400-RTDW-3BAR</b>	3:1	Included

**ANTIFREEZE PUMP/REEL/METER PACKAGE**

	Pump	Reel	Control Handle
<b>110-RTDW-R212D</b>	1/2" Diaphragm Pump	50'	Digital
<b>165-RTDW-R212D</b>	1/2" Diaphragm Pump	50'	Digital
<b>275-RTDW-R212D</b>	1/2" Diaphragm Pump	50'	Digital
<b>400-RTDW-R212D</b>	1/2" Diaphragm Pump	50'	Digital



400-RTDW-R23D

165-RTDW-3BAR

275-RTDW-X3X



275-RTDW-R212D

110-RTDW-R33T

*These tank packages cannot be used for gasoline, windshield washer solvent or DEF.*

*Tank packages come un-assembled.*

*One set of tie downs is supplied with each tank package - required when reel is mounted on the tank*

*Tanks must be purchased with lubrication equipment.*

*Tanks are certified to UL SU2258 which includes combustible liquids addressed by the following material classes outlined in NFPA Standards 30, 30A and 31:  
 Class IIIA Liquid – any liquid that has a flash point at or above 140° F but below 200° F.  
 Class IIIB Liquid – any liquid that has a flash point at or above 200° F.*

## TOTE PUMPING SYSTEMS

### MOUNTING PLATE

Heavy-duty steel mounting plate

### PRE-DRILLED

Pre-drilled holes for Advantage Series reels

### BUNG ADAPTER

2" NPT bung adapter for pumps

### FLEXIBILITY

Fits most totes

### VERSATILE

Turns totes into a functional tank package

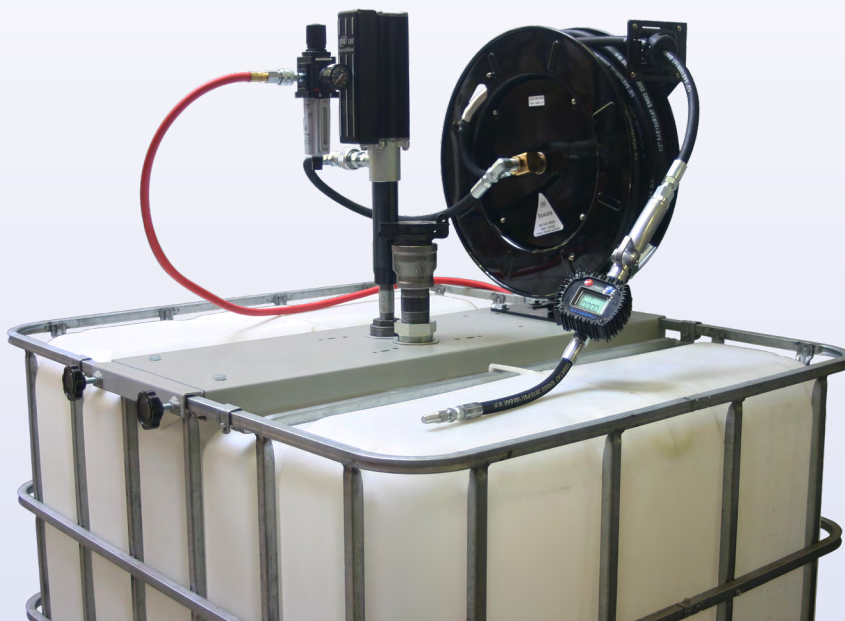

### 3:1 Pumps

	RPM-3-TM1	RPM-3-TM2	RPM-3-TM3
Pump	LM2203A-11-C	LM2203A-11-C	LM2203A-11-C
Mounting Bracket	TIM-464-A	TIM-464-A	TIM-464-A
Reel (50')	TIM-3628-50	TIM-3628-50	TIM-3628-50
Filter/Regulator/ Gauge	P-39224-624	P-39224-624	P-39224-624
Control Handle	TIM-601-FM	TIM-900B-1	TIM-762-TG
Oil Connecting Hose	TIM-4418-2NS	TIM-4418-2NS	TIM-4418-2NS
Filter/Regulator to Pump Adapter	TIM-212-1	TIM-212-1	TIM-212-1
Fluid Coupler	TIM-178	TIM-178	TIM-178
Fluid Connector	TIM-179	TIM-179	TIM-179
Air Connecting Hose	AIR-HP1414-5	AIR-HP1414-5	AIR-HP1414-5
Downtube	TIM-MTL75-33	TIM-MTL75-33	TIM-MTL75-33
Low Level Cutoff	TIM-196-C	TIM-196-C	TIM-196-C

### 5:1 Pumps

	RPM-5-TM1	RPM-5-TM2	RPM-5-TM3
Pump	LM2305A-11-B	LM2305A-11-B	LM2305A-11-B
Mounting Bracket	TIM-464-A	TIM-464-A	TIM-464-A
Reel (50')	TIM-3628-50	TIM-3628-50	TIM-3628-50
Filter/Regulator/ Gauge	P-39224-624	P-39224-624	P-39224-624
Control Handle	TIM-601-FM	TIM-900B-1	TIM-762-TG
Oil Connecting Hose	TIM-4418-2NS	TIM-4418-2NS	TIM-4418-2NS
Filter/Regulator to Pump Adapter	TIM-212-1	TIM-212-1	TIM-212-1
Fluid Coupler	TIM-178	TIM-178	TIM-178
Fluid Connector	TIM-179	TIM-179	TIM-179
Air Connecting Hose	AIR-HP1414-5	AIR-HP1414-5	AIR-HP1414-5
Downtube	TIM-MTL-35	TIM-MTL-35	TIM-MTL-35
Low Level Cutoff	TIM-166-LLC	TIM-166-LLC	TIM-166-LLC

## DOUBLE-TAP BUSHINGS

<b>TIM-160</b>	<p><b>Double-Tap Bushing</b> For mounting 5:1 or 9:1 stub pumps directly to an above-ground tank. Replaces bung adapter mounting. Extension tube of pump screws directly into the bottom of the bushing. Outside thread is 2"(M), inside thread is 1-1/2"(F)</p> <p><i>When using with an ARO 5:1 Thunder pump order TIM-211 (1-1/2" x 3" nipple) separately</i></p>
<b>TIM-164</b>	<p><b>Double-Tap Bushing</b> For converting a 4"(F) threaded tank opening to 2"(F). Enables tank mounting of oil pumps via 2" bung adapter. Outside thread is 4"(M) and inside thread is 2"(F).</p>
<b>TIM-190</b>	<p><b>Double-Tap Bushing</b> For converting a 3"(F) threaded tank opening to 2"(F). Enables tank mounting of oil pump via 2" bung adapter. Outside thread is 3"(M) and inside thread is 2"(F).</p>
<b>TIM-198</b>	<p><b>Double-Tap Bushing</b> For mounting Thunder 3:1 stub pumps directly to an above-ground tank. Replaces bung adapter mounting. Extension tube of pump screws directly into the included 3/4" x 3" nipple. Outside thread is 2"(M), inside thread is 3/4"(F).</p>



TIM-160



TIM-190

## FILL CAPS



**TIM-FILL-CAP**  
**2"(M) Vented Lockable Fill Cap**  
For above-ground tanks

## TANK VENTS

<b>TIM-MUSH-VENT</b>	<p><b>2"(F) Mushroom Vent</b> Order TIM-287 (2" close nipple) separately</p>
<b>TIM-VENT-2</b>	<p><b>2" Emergency Vent</b> For use with bulk oil storage tanks</p>
<b>TIM-VENT-3</b>	<p><b>3"(M) Emergency Vent</b> Designed for use with bulk oil storage tanks</p>
<b>TIM-VENT-4S</b>	<p><b>4"(M) Emergency Vent</b> Slim design allows for use on both single and double-wall tanks</p>
<b>TIM-VENT-6</b>	<p><b>6"(M) Emergency Vent</b> Design for use with bulk oil storage tanks</p>



TIM-MUSH-VENT



TIM-VENT-3

## 3-1/2 GALLON AST SPILL CONTAINER



**TIM-SPILL-BOX3**  
**Lockable Spill Container**  
Installed on above-ground tanks to contain small spills and drips from the fill nozzle. Removable screen allows for used filters to be drained. 2"(M) NPT riser connection. White powder-coated finish. 3-1/2 gallon capacity. ULC listed.

## TANK PLUGS

	<b>TIM-PLUG-3/4</b>	<b>TIM-PLUG-1</b>	<b>TIM-PLUG-2</b>	<b>TIM-PLUG-3</b>	<b>TIM-PLUG-4</b>	<b>TIM-PLUG-6</b>
Description	3/4" Tank Plug	1" Tank Plug	2" Tank Plug	3" Tank Plug	4" Tank Plug	6" Tank Plug
Material	Iron	Steel	Steel	Steel	Steel	Plastic

TANK PACKAGES

## LEAK DETECTION SITE GLASS



### 75-TA-INSP

#### Secondary Containment Site Glass

Brass site glass with 3/4"(M) thread to be installed in the inspection port of the secondary containment wall of either the 275VDW or 500RVDW tank to detect a primary compartment leak

## PLASTIC FLOAT & STRING GAUGES

	Metered Units	Length	Tank Used On
<b>TG-275H</b>	Gallons	44"	275-Gallon Horizontal Obround
<b>TG-32</b>	Inches	32"	Workbench Tanks
<b>TG-36</b>	Inches	36"	165 & 250-Gallon Bench Tanks with 36" Interior Height
<b>TG-44</b>	Inches	44"	275-Gallon Horizontal Obround
<b>TG-46</b>	Inches	46"	525-Gallon Horizontal Round
<b>TG-60</b>	Inches	60"	275-Gallon Vertical Obround, 500-Gallon & Larger Cube Tanks
<b>TG-72</b>	Inches	72"	Tanks with 72" Interior Height



TG-32

## METAL FLOAT & STRING GAUGES

	Metered Units	Length	Tank Used On
<b>TIM-GG-44</b>	Gallons	44"	275-Gallon Horizontal Obround
<b>TIM-GG-60</b>	Inches	60"	275-Gallon Vertical Obround, 500-Gallon Vertical Round & Larger Cube Tanks
<b>TIM-GG-72</b>	Inches	72"	Tanks with 72" Interior Height



TIM-GG-60

## PLASTIC FLOAT & STRING GAUGES

	Metered Units	Length	Tank Used On
<b>TIM-H2-32</b>	8ths of a Tank	32"	165 & 250-Gallon Bench Tanks
<b>TIM-D2-36</b>	8ths of a Tank	36"	120-Gallon Bench Tanks
<b>TIM-D2-44</b>	8ths of a Tank	44"	275-Gallon Horizontal Obround
<b>TIM-D2-48</b>	8ths of a Tank	48"	525-Gallon Horizontal Round
<b>TIM-H2-60</b>	8ths of a Tank	60"	275-Gallon Vertical Obround, 500-Gallon & Larger Cube Tanks



TIM-H2-60

TANK PACKAGES



## PIT DRAIN



### QL-308

#### 35-Gallon Rolling Waste Oil Drain

For use in quick-lube facilities or truck maintenance shops. Unit is powder-coated yellow. Angled wheels provide easy drain movement and can be adjusted from 35" to 47". Drain bottom is sloped toward the two screened drain holes on the front and the rear of the unit. Drain holes are 1"(M). Drain includes pull handles on the front and rear of the unit, filter screen, and internal baffling. Dimensions 31-1/4" L x 31" W x 11-1/4" H.

*Order TIM-4675 camlock kit, TIM-1001-BV ball valve and TIM-4416-3 or TIM-4416-8 suction hose separately*

## STEP STOOL



### QL-101

#### Step Stool

Durable lightweight aluminum construction features wide angled base with padded feet and molded non-slip surface for added safety. This stool weighs only 10 pounds. Dimensions 20-1/2" D x 20-1/2" W x 10-1/2" H.

*Order QL-101-PAD replacement feet pads separately. Sold individually*



## AIR FILTERS

	Thread Size	Series	Drain Type	Bowl Type	Air Flow
<b>F-100</b>	1/4"	ALEC	Automatic	Metal	20 CFM
<b>F35121-421</b>	1/4"	1000	Automatic	Metal	49 CFM
<b>F35221-411</b>	1/4"	1500	Automatic	Metal	73 CFM
<b>F35231-411</b>	3/8"	1500	Automatic	Metal	107 CFM
<b>F35331-410</b>	3/8"	2000	Manual	Metal	156 CFM
<b>F35341-400</b>	1/2"	2000	Manual	Polycarbonate	197 CFM
<b>F35341-410</b>	1/2"	2000	Manual	Metal	197 CFM
<b>F35351-411</b>	3/4"	2000	Automatic	Metal	216 CFM
<b>F35451-410</b>	3/4"	3000	Manual	Metal	288 CFM



F35341-400

## AIR REGULATORS

	Thread Size	Series	Pressure Range	Gauge Included	Air Flow
<b>R37121-100</b>	1/4"	1000	0 to 140 PSI	No*	59 CFM
<b>R37221-100</b>	1/4"	1500	0 to 140 PSI	No*	86 CFM
<b>R37221-200</b>	1/4"	1500	0 to 140 PSI	No*	86 CFM
<b>R-37221-600T</b>	1/4"	1500	0 to 140 PSI	Yes	86 CFM
<b>R37231-600</b>	3/8"	1500	0 to 140 PSI	Yes	113 CFM
<b>R37331-600</b>	1/2"	2000	0 to 140 PSI	Yes	179 CFM
<b>R37341-100</b>	1/2"	2000	0 to 140 PSI	No*	215 CFM
<b>R37341-600</b>	1/2"	2000	0 to 140 PSI	Yes	215 CFM
<b>R37351-100</b>	3/4"	2000	0 to 140 PSI	No*	210 CFM



R37331-600

\* For gauge selection see page 85.

## AIR LUBRICATORS

	Thread Size	Series	Bowl Capacity	Bowl Type	Air Flow
<b>L36121-100</b>	1/4"	1000	0.7 oz.	Metal*	57 CFM
<b>L36221-110</b>	1/4"	1500	1.5 oz.	Metal*	51 CFM
<b>L36331-110</b>	3/8"	2000	1.5 oz.	Metal*	85 CFM
<b>L36341-110</b>	1/2"	2000	3.7 oz.	Metal*	156 CFM
<b>L36351-110</b>	3/4"	2000	10 oz.	Metal*	222 CFM

\* Metal bowl with sight gauge



L36341-110

## LUBRICATING OIL



### 29665 Lubricating Oil

ARO lubricating oil is recommended for use with pneumatic power tools, motors, valves, cylinders and hoists. It is specially formulated for use in air line lubricators. Proper, regular lubrication helps ensure longer, trouble-free operation by reducing wear; saves power and cuts equipment maintenance costs. ARO lubricating oil is available in 1-quart containers and may be ordered by specifying part number 29665 (one [1] 1-quart container).

**NOTE:** There are twelve (12) 1-quart containers per case. **Viscosity:** 100-200 S.S.U. @ 100°F (38°C) minimum aniline point of 200°F (93°C) **Class:** II Lubricant. **Approximate SAE No:** Light SAE 10, non-detergent

### AIR FILTER/REGULATOR & GAUGE ASSEMBLIES

	Thread Size	Series	Drain Type	Bowl Type	Air Flow
<b>P39124-124*</b>	1/4"	1000	Automatic	Metal	47 CFM
<b>P-39124-624**</b>	1/4"	1000	Automatic	Metal	47 CFM
<b>P-39224-624**</b>	1/4"	1500	Automatic	Metal	72 CFM
<b>P39234-614</b>	3/8"	1500	Automatic	Metal	90 CFM
<b>P39344-614</b>	1/2"	2000	Automatic	Metal	172 CFM
<b>P39354-614</b>	3/4"	2000	Automatic	Metal	173 CFM

\* Does not include gauge

\*\* This item also available in a 25 or more bulk pricing

**ARO**



P-39224-624

### FILTER/REGULATOR/LUBRICATOR ASSEMBLIES

	Thread Size	Series	Drain Type	Bowl Type	Air Flow
<b>C38121-801*</b>	1/4"	1000	Automatic	Polycarbonate	46 CFM
<b>C38221-810*</b>	1/4"	1500	Manual	Metal	61 CFM
<b>C38221-811*</b>	1/4"	1500	Automatic	Metal	61 CFM
<b>C38331-811*</b>	3/8"	2000	Automatic	Metal	99 CFM
<b>C38341-810*</b>	1/2"	2000	Manual	Metal	150 CFM
<b>C38351-811*</b>	3/4"	2000	Automatic	Metal	171 CFM

\* All models include built-in air gauge and sight gauge



C38351-811

### AIR GAUGES

	<b>TIM-220</b>	<b>TIM-221</b>
Thread Size	1/8"(M)	1/4"(M)
Series Used On	1000, 1500 & ALEC	1500, 2000 & 3000
Porting	Back	Back
Gauge Range	0 to 160 PSI	0 to 160 PSI
Gauge Diameter	1.5"	2"



TIM-220

### AIR SYSTEM PIPE NIPPLES

	<b>TIM-212-1</b>	<b>Y-27-53C</b>	<b>Y-27-54C</b>	<b>Y-27-55C</b>
Thread Size	1/4"(M) x (M)	3/8"(M) x (M)	1/2"(M) x (M)	3/4"(M) x (M)
Used On	1/4" Components	3/8" Components	1/2" Components	3/4" Components



Y-27-54C

## ARO STYLE 1/4" CAPACITY - 210 SERIES

All couplers are "push-to-connect" providing automatic pin-type coupling. The average flow rate is 18 CFM at 90 PSI inlet pressure. Maximum inlet pressure is 250 PSI. Temperature range is -40°F to 200°F. Couplers and connectors within the 1/4" capacity 210 Series group are interchangeable.

### Couplers

	Thread Size
<b>210-212</b>	1/4" NPT (M)
<b>210</b>	1/4" NPT (F)
<b>210-25*</b>	1/4" NPT (F)
<b>210-100**</b>	1/4" NPT (F)
<b>210-300***</b>	1/4" NPT (F)

\* 25 pack  
 \*\* 100 pack  
 \*\*\* 300 pack

### Connectors

	Thread Size
<b>2607</b>	1/8" NPT (M)
<b>210-212</b>	1/4" NPT (M)
<b>2608</b>	1/4" NPT (M)
<b>2608-25*</b>	1/4" NPT (M)
<b>2608-100**</b>	1/4" NPT (M)
<b>2609</b>	1/4" NPT (F)
<b>2609-25*</b>	1/4" NPT (F)
<b>2609-100**</b>	1/4" NPT (F)
<b>2609-300***</b>	1/4" NPT (F)

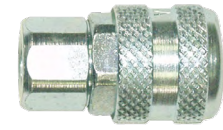

210



2608

## MS SERIES 1/4" CAPACITY - INDUSTRIAL INTERCHANGE

All couplers are "push-to-connect" providing automatic pin-type coupling. The average flow rate is 36 CFM at 90 PSI inlet pressure. Maximum inlet pressure is 250 PSI. Temperature range is -40°F to 200°F. Couplers and connectors within the 1/4" capacity Industrial Interchange group are interchangeable.

### Couplers

	Thread Size
<b>MSCF22-000</b>	1/4" NPT (F)
<b>MSCF23-000</b>	3/8" NPT (F)
<b>MSCM22-000</b>	1/4" NPT (M)

### Connectors

	Thread Size
<b>23902-210</b>	1/4" NPT (M)
<b>23902-200</b>	1/4" NPT (F)



MSCF22-000



23902-210

## HIGH FLOW SERIES 3/8" CAPACITY - INDUSTRIAL INTERCHANGE

All couplers are "push-to-connect" providing automatic pin-type coupling. The average flow rate is 72 CFM at 90 PSI inlet pressure. Maximum inlet pressure is 250 PSI. Temperature range is -40°F to 200°F. Couplers and connectors within the 3/8" capacity High Flow Series Industrial Interchange group are interchangeable.

### Couplers

	Thread Size
<b>23103-300</b>	3/8" NPT (F)
<b>23103-004</b>	1/2" NPT (F)

### Connectors

	Thread Size
<b>23903-300</b>	3/8" NPT (F)
<b>23903-310</b>	3/8" NPT (F)
<b>23903-410</b>	1/2" NPT (M)



23103-004



23903-410

## ARO-STOP® AUTOMATIC AIR SHUT-OFF

ARO-STOP® shut-off valves are designed to prevent pump "runaway". Pump runaway occurs when the material container is depleted, causing the pump to cycle fast and needlessly. The ARO-STOP® valve protects the pump by shutting off the air supply when the material container is empty or a fluid line on the outlet side of the pump is broken. Use with oil or grease pumps.



**635040**



**23644-400**

	<b>ARO-STOP® Valve Kit</b>	<b>ARO-STOP® Valve</b>
Description	Includes 1/4" x 5' air hose, 1/4" ARO coupler and air connector. Maximum flow rate is 23 CFM at 90 PSI.	Shuts off air to pump when material container is empty or fluid line is broken. Air inlet and outlet 1/2"(F).
Air Inlet/Outlet	1/4"(F)	1/2"(F)
Used On	Series 200 Pumps, All Thunder Pumps, 1/2" Diaphragm Pumps	AFX Series Pumps, 1" Diaphragm Pumps

## AIR CONTROL BOX

<b>TIM-AIR-BOX</b>	<b>Air Control Box</b> For controlling the air to a pump or pumps from a remote location. Unit includes key switch and indicator light. Unit requires the use of an air solenoid valve and wire. 110 VAC input voltage.
<b>TIM-2000-2</b>	<b>1/4" Air Solenoid Safety Kit</b> For pumps with 1/4" air inlets. Shuts off air flow to the pump when connected to the air control box (TIM-AIR-BOX). Helps prevent potential oil spills.
<b>TIM-2000-2A1</b>	<b>1/2" Air Solenoid Safety Kit</b> For pumps with 1/2" air inlets. Shuts off air flow to the pump when connected to the air control box (TIM-AIR-BOX). Helps prevent potential oil spills.
<b>TIM-2000-3A</b>	<b>Wire Spool</b> 500' spool of 2-conductor 22-gauge wire
<b>TIM-2000-3B</b>	<b>Wire Spool</b> 500' spool of 4-conductor 22-gauge wire
<b>TIM-2000-3C</b>	<b>Wire Spool</b> 500' spool of 8-conductor 22-gauge wire
<b>TIM-2000-3D</b>	<b>Wire Spool</b> 500' spool of 12-conductor 22-gauge wire



TIM-AIR-BOX

## TIRE INFLATION GAUGES & AIR CHUCKS



**TIM-88**



**TIM-89**



**TIM-90**

Inlet	1/4"(F) NPT	1/4"(F) NPT	1/4"(F) NPT
Description	<b>Bayonet Tire Inflator Gauge</b> With dual head	<b>Deluxe Tire Inflator Gauge</b> "Squeeze" trigger assembly simplifies tire filling. Unit has bleeder valve to allow quick adjustments for over pressurized tires, air gauge with protective cover, dual-head chuck and 12" hose. Pop-up gauge registers 0 to 140 PSI.	<b>Dual Head Air Chuck</b> For car and truck tires

## LOW & MEDIUM PRESSURE SHUT-OFF VALVES

	<b>TIM-250-BV</b>	<b>TIM-500-600</b>	<b>TIM-502-BV</b>
Inlet/Outlet	1/4"(F)	1/2"(F)	1/2"(F)
Working Pressure	400 PSI	600 PSI	2,000 PSI

	<b>TIM-752-BV</b>	<b>TIM-1001-BV</b>	<b>TIM-1501-BV</b>
Inlet/Outlet	3/4"(F)	1"(F)	1-1/2"(F)
Working Pressure	2,000 PSI	600 PSI	600 PSI



TIM-250-BV



TIM-1001-BV

INSTALLATION ACCESSORIES

## HIGH PRESSURE SHUT-OFF VALVES

High pressure carbon steel in-line needle valves for high pressure grease applications.



**TIM-500-HP1**

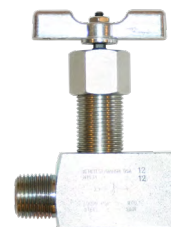

**TIM-500-HP2**

Inlet/Outlet	1/2"(F) x 1/2"(F)	1/2"(M) x 1/2"(F)
Working Pressure	8,000 PSI	8,000 PSI

## HIGH PRESSURE COUPLER & CONNECTOR

Ideal for high pressure grease applications. Used in lube truck applications for removing and storing the grease control handles. 10,000 PSI working pressure.



**TIM-192**

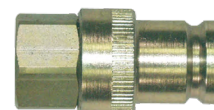

**TIM-193**

Thread Size	3/8"(F)	3/8"(F)
Type	Fluid Coupler	Fluid Connector

### SEAMLESS STEEL TUBING

5/8" O.D. seamless steel tubing for oil and grease applications. Tubing comes in 20' lengths. Tubing styles can be combined to reach the 1,000' minimum purchase quantity.

	TIM-035-100	TIM-035-1000
Application	Oil	Oil
Wall Thickness	0.035"	0.035"
Quantity	100'	1,000'

	TIM-083-100	TIM-083-1000
Application	Grease	Grease
Wall Thickness	0.083"	0.083"
Quantity	100'	1,000'

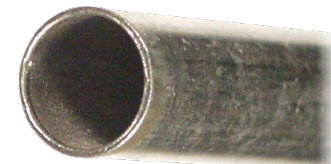

TIM-035-S



TIM-083-S

INSTALLATION ACCESSORIES

### STEEL TUBING CONNECTORS

5,000 PSI (4:1 safety factor) 5/8" O.D. steel tubing compression fittings. May be used for either oil or grease.



**SDB-10-TIM**

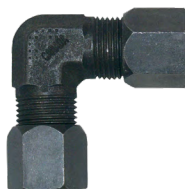

**SEB-10-TIM**



**SFB-10-TIM**

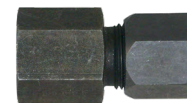

**SGB-10-TIM**

Description	1/2"(F) x Tube	Tube x Tube	1/2"(M) x Tube	1/2"(F) x Tube
Type	90° Elbow	90° Elbow	Straight	Straight



**SHB-10-TIM**



**SJB-10-TIM**



**SMB-10-TIM**



**SOB-10-TIM**

Description	Tube x Tube	Tube x Tube x Tube	Tube x 1/2"(M) x Tube	Tube x 1/2"(F) x Tube
Type	Straight	Tee	Tee	Tee



**STRAIGHT (M) X (F) UNION ADAPTERS**

	(M) x (F)	Max. PSI		(M) x (F)	Max. PSI
<b>TIM-1404-22</b>	1/8" x 1/8"	10,000 PSI	<b>TIM-1404-86</b>	1/2" x 3/8"	7,000 PSI
<b>TIM-1404-42</b>	1/4" x 1/8"	10,000 PSI	<b>TIM-1404-88</b>	1/2" x 1/2"	7,000 PSI
<b>TIM-1404-44</b>	1/4" x 1/4"	10,000 PSI	<b>TIM-1404-128</b>	3/4" x 1/2"	5,500 PSI
<b>TIM-1404-46</b>	1/4" x 3/8"	7,000 PSI	<b>TIM-1404-812</b>	1/2" x 3/4"	5,500 PSI
<b>TIM-1404-64</b>	3/8" x 1/4"	7,000 PSI	<b>TIM-1404-1212</b>	3/4" x 3/4"	5,500 PSI
<b>TIM-1404-66</b>	3/8" x 3/8"	7,000 PSI	<b>TIM-1404-1216</b>	3/4" x 1"	4,000 PSI
<b>TIM-1404-68</b>	3/8" x 1/2"	7,000 PSI	<b>TIM-1404-1612</b>	1" x 3/4"	4,000 PSI
<b>TIM-1404-84</b>	1/2" x 1/4"	7,000 PSI	<b>TIM-1404-1616</b>	1" x 1"	4,000 PSI



TIM-1404-84



TIM-1404-1212

**90° (M) X (F) UNION ADAPTERS**

	(M) x (F)	Max. PSI		(M) x (F)	Max. PSI
<b>TIM-1501-44</b>	1/4" x 1/4"	10,000 PSI	<b>TIM-1501-88</b>	1/2" x 1/2"	7,000 PSI
<b>TIM-1501-66</b>	3/8" x 3/8"	7,000 PSI	<b>Y-43-4C*</b>	1/2" x 1/2"	3,000 PSI
<b>TIM-1501-86</b>	1/2" x 3/8"	7,000 PSI	<b>TIM-1501-1212</b>	3/4" x 3/4"	5,500 PSI

\* Non-swivel



TIM-1501-88

**STRAIGHT (F) X (F) UNION ADAPTERS**

	(F) x (F)	Max. PSI		(F) x (F)	Max. PSI
<b>TIM-1405-44</b>	1/4" x 1/4"	10,000 PSI	<b>TIM-1405-128</b>	3/4" x 1/2"	5,500 PSI
<b>TIM-1405-64</b>	3/8" x 1/4"	7,000 PSI	<b>TIM-1405-1212</b>	3/4" x 3/4"	5,500 PSI
<b>TIM-1405-86</b>	1/2" x 3/8"	7,000 PSI	<b>TIM-1405-1616</b>	1" x 1"	4,000 PSI
<b>TIM-1405-88</b>	1/2" x 1/2"	7,000 PSI			



TIM-1405-88

**45° (F) X (F) UNION ADAPTERS**

	(F) x (F)	Max. PSI		(F) x (F)	Max. PSI
<b>TIM-1504-44</b>	1/4" x 1/4"	10,000 PSI	<b>TIM-1504-88</b>	1/2" x 1/2"	4,000 PSI
<b>TIM-1504-66</b>	3/8" x 3/8"	7,000 PSI			



TIM-1504-88

INSTALLATION ACCESSORIES

**(M) X (M) ADAPTERS**

	(M) x (M)	Max. PSI
<b>TIM-1200-1</b>	1/8" x 1/8"	10,000 PSI
<b>TIM-1201-1</b>	1/8" x 1/4"	10,000 PSI
<b>TIM-1202-1</b>	1/8" x 3/8"	7,000 PSI
<b>TIM-1209</b>	1/4" x 1/2"-27	5,000 PSI
<b>TIM-212-1</b>	1/4" x 1/4"	10,000 PSI
<b>TIM-1204-1</b>	1/4" x 1/2"	7,000 PSI

	(M) x (M)	Max. PSI
<b>TIM-1205-1</b>	3/8" x 3/8"	7,000 PSI
<b>TIM-1206-1</b>	3/8" x 1/2"	7,000 PSI
<b>Y-27-54C</b>	1/2" x 1/2"	7,000 PSI
<b>TIM-1208-1</b>	1/2" x 3/4"	5,500 PSI
<b>TIM-1210-1</b>	3/4" x 1"	4,000 PSI



TIM-1201-1



TIM-212-1

INSTALLATION  
ACCESSORIES

**(M) X (F) ADAPTERS**

	(M) x (F)	Max. PSI
<b>TIM-1220</b>	1/8" x 1/4"	10,000 PSI
<b>TIM-1221</b>	1/8" x 3/8"	7,000 PSI
<b>TIM-1222</b>	1/8" x 1/2"	7,000 PSI
<b>TIM-1223</b>	1/4" x 3/8"	7,000 PSI

	(M) x (F)	Max. PSI
<b>TIM-1225</b>	3/8" x 1/2"	7,000 PSI
<b>TIM-1226</b>	1/2" x 3/4"	5,500 PSI
<b>TIM-1227</b>	1/4" x 1/2"	7,000 PSI

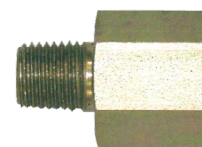

TIM-1223

**(F) X (F) ADAPTERS**

	(F) x (F)	Max. PSI
<b>TIM-1230</b>	1/8" x 1/8"	10,000 PSI
<b>TIM-1260</b>	1/8" x 1/2"-27	5,000 PSI

	(F) x (F)	Max. PSI
<b>TIM-1263</b>	1/2" x 1/2"	3,000 PSI

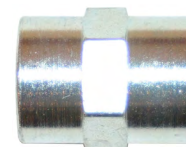

TIM-1263

**REDUCING BUSHINGS**

	(M) x (F)	Max. PSI
<b>TIM-1240</b>	1/4" x 1/8"	10,000 PSI
<b>TIM-1241</b>	3/8" x 1/8"	7,000 PSI
<b>TIM-1242</b>	3/8" x 1/4"	7,000 PSI

	(M) x (F)	Max. PSI
<b>TIM-1243</b>	1/2" x 1/8"	7,000 PSI
<b>TIM-1244</b>	1/2" x 1/4"	7,000 PSI
<b>TIM-1245</b>	1/2" x 3/8"	7,000 PSI

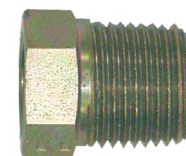

TIM-1245

## AIR & WATER CONNECTING HOSES FOR PUMPS & REELS

	Hose ID	Thread Size	Hybrid Polymer Hose	Maximum PSI	Available Length (Feet)	For Use On
<b>AIR-HP1414-___*</b>	3/8"	1/4"(M) x 1/4"(M)	Yes	300 PSI	3, 5, 10	1/4" Air Connecting Hoses for Thunder Pumps, 1/2" & 1"
<b>AIR-HP3812-2Z</b>	3/8"	3/8"(M) x 1/2"(M)	Yes	300 PSI	2	3/8" Air/Water Reels
<b>AIR-HP3838-___*</b>	3/8"	3/8"(M) x 3/8"(M)	Yes	300 PSI	2, 4	3/8" Air/Water Reels
<b>TIM-4218-2N</b>	1/2"	1/2"(M) x 1/2"-90° Swivel (M)	No	300 PSI	2	1/2" Air/Water Reels
<b>TIM-4218-4NS</b>	1/2"	1/2"(M) x 1/2"-90° Swivel (M)	No	300 PSI	4	1/2" Air/Water Reels
<b>TIM-4258-5</b>	1/2"	1/2"(M) x 1/2"(M)	No	300 PSI	5	1/2" Air Connecting Hose for AFX Series Pumps

\* Add length of hose to the model number as the suffix. For example: AIR-HP1414-5 is a 1/4" I.D. hose with 1/4"(M) ends by 5' long.

HOSES

## AIR & WATER DELIVERY HOSES FOR CONSOLES & REELS

	Hose ID	Thread Size	Hybrid Polymer Hose	Maximum PSI	Available Length (Feet)	For Use On
<b>AIR-HP1414-15</b>	3/8"	1/4"(M) x 1/4"(M)	Yes	300 PSI	15	Lube Consoles
<b>AIR-HP3800-250</b>	3/8"	Not Coupled	Yes	300 PSI	250' Spool	Air/Water Reels
<b>AIR-HP3800-___*</b>	3/8"	Not Coupled	Yes	300 PSI	250' Spool (can be cut to any length - call for pricing)	Air/Water Reels
<b>AIR-HP3838-___*</b>	3/8"	3/8"(M) x 3/8"(M)	Yes	300 PSI	50, 65	3/8" Air/Water Reels
<b>TIM-4208-___*</b>	1/2"	1/2"(M) x 1/2"(M)	No	300 PSI	50, 65, 75, 100	1/2" Air/Water Reels

\* Add length of hose to the model number as the suffix. For example: AIR-HP3838-50 is a 3/8" I.D. hose with 3/8"(M) ends by 50' long.

## REUSABLE FITTINGS FOR AIR/WATER HOSE

	Thread Size	For Use On
<b>AIR-RF3800-12</b>	1/2"(M)	Non-Coupled 3/8" Hybrid Polymer Air Hose
<b>AIR-RF3800-14</b>	1/4"(M)	Non-Coupled 3/8" Hybrid Polymer Air Hose
<b>AIR-RF3800-38</b>	3/8"(M)	Non-Coupled 3/8" Hybrid Polymer Air Hose



AIR-RF3800-14

## OIL CONNECTING HOSES FOR PUMPS &amp; REELS

	Hose ID	Thread Size	Maximum PSI	Available Length (Feet)	For Use On
<b>TIM-4418-___*</b>	1/2"	1/2"(M) x 1/2" 90° Swivel (M)	2,000 PSI	2NS, 2.5NS, 4NS	1/2" Oil Reels
<b>TIM-4418-___*</b>	1/2"	1/2"(M) x 1/2" Swivel (M)	2,000 PSI	4S, 5S, 6S, 8S	1/2" Oil Reels
<b>TIM-4412-___*</b>	3/4"	3/4"(M) x 3/4"(M)	1,250 PSI	3, 5	3/4" Oil Reels
<b>TIM-4416-___*</b>	1"	1"(M) x 1"(M)	1,000 PSI	3, 5, 8, 10	1" Oil Reels
<b>624601-4</b>	3/4"	3/4"(M) x 3/4"(M)	2,250 PSI	4	Oil Connecting Hose for AFX Series Pumps
<b>628067-3</b>	1"	1"NPT x 1"NPT	800 PSI	3	Waste Oil Evacuation System (612999-4)

\* Add length of hose to the model number as the suffix. For example: TIM-4418-5S is a 1/2" I.D. hose with 1/2"(M) ends by 5' long.

## OIL DELIVERY HOSES FOR CONSOLES &amp; REELS

	Hose ID	Thread Size	Maximum PSI	Available Length (Feet)	For Use On
<b>TIM-4418-___*</b>	1/2"	1/2"(M) x 1/2"(M)	2,000 PSI	12, 15, 18, 40	1/2" Oil Reels & Quick-Lube Consoles
<b>TIM-4418-___*</b>	1/2"	1/2"(M) x 1/2" Swivel (M)	2,000 PSI	10S, 16S, 18S, 20S, 25S, 30S, 50S, 65S, 75S, 100S	1/2" Oil Reels & Quick-Lube Consoles
<b>TIM-4412-___*</b>	3/4"	3/4"(M) x 3/4"(M)	1,250 PSI	15, 30, 50	3/4" Oil Reels
<b>TIM-4416-___*</b>	1"	1"(M) x 1"(M)	1,000 PSI	15, 30, 50	1" Oil Reels

\* Add length of hose to the model number as the suffix. For example: TIM-4418-10 is a 1/2" I.D. hose with 1/2"(M) ends by 10' long.

## GREASE CONNECTING HOSES FOR PUMPS &amp; REELS

	Hose ID	Thread Sizes	Maximum PSI	Available Length (Feet)	For Use On
<b>TIM-4516-2N</b>	3/8"	3/8"(M) x 3/8"-90° Swivel (M)	4,000 PSI	2	3/8" Grease Reels
<b>TIM-4516-4NS</b>	3/8"	3/8"(M) x 3/8"-90° Swivel (M)	4,000 PSI	4	3/8" Grease Reels
<b>TIM-4516-___*</b>	3/8"	3/8"(M) x 3/8"(M)	4,000 PSI	2, 4, 8	ARO Grease Pumps & 3/8" Grease Reels

\* Add length of hose to the model number as the suffix. For example: TIM-4516-8 is a 3/8" I.D. hose with 3/8"(M) ends by 8' long.

## GREASE DELIVERY HOSES FOR CONSOLES &amp; REELS

	Hose ID	Thread Sizes	Maximum PSI	Available Length (Feet)	For Use On
<b>TIM-4513-5</b>	1/4"	1/8"(M) x 1/8"(M)	5,000 PSI	5	TIM-83-KM Pump
<b>TIM-4514-2</b>	1/4"	1/4"(M) x 1/4"(M)	4,000 PSI	2	Portable Grease Pumps
<b>TIM-4514-___*</b>	1/4"	3/8"(M) x 1/4"(M)	4,000 PSI	10, 20, 30	Portable Grease Pumps
<b>TIM-4517-14</b>	1/4"	1/8"(F) x 1/8"(M)	5,000 PSI	14	Quick-Lube Consoles
<b>TIM-4524-___*</b>	1/4"	1/8"(F) x 1/8"(F)	5,000 PSI	2, 6, 10, 12, 15, 20, 25, 30	ARO Grease Pumps
<b>TIM-4506-___*</b>	3/8"	3/8"(M) x 3/8"(M)	4,000 PSI	15, 25S, 30F, 50S, 65S, 75S, 100	3/8" Grease Reels

\* Add length of hose to the model number as the suffix. For example: TIM-4506-50S is a 3/8" I.D. hose with 3/8"(M) ends by 50' long.

## HAND-OPERATED GREASE GUNS

**4110**

**Deluxe Heavy-Duty Grease Gun**  
10,000 PSI rated. Aluminum head. Delivers 1 ounce in 23 strokes, 3-way loader capability (loader fitting included). Full pressure on variable or short strokes for controlled grease output and easy operation in tight quarters. Takes standard 14-1/2 ounce cartridge and has a 16 ounce bulk fill capacity. Gun comes with rugged plastic handle grip, loader fitting, air release valve, hydraulic coupler with ball check and rigid extension. Packaged in a 4-color POP box. Compare to Alemite 500.

*For case quantities order  
part number 4110-10*

**4111**

**Deluxe Heavy-Duty Grease Gun  
with 18" Hose**

Same as 4110 but also includes TIM-4321 18" rubber flex hose. Packaged in a 4-color POP box. Compare to Alemite 500E.

*For case quantities order  
part number 4111-10*

**4120**

**Industrial Hi-Flow Heavy-Duty  
Grease Gun**

Generates 10,000 PSI, cast aluminum pump head. Delivers 1 ounce in 9 strokes twice the volume per stroke when compared to the best variable stroke guns, 3-way loader capability (loader fitting included). Full pressure on variable or short strokes for controlled grease output and easy operation in tight quarters. Comes with rugged plastic handle grip, loader fitting, air release valve, heavy-duty hydraulic coupler with ball check and rigid extension.

*For case quantities order  
part number 4120-10*

**4127**

**Suction Gun**

Suction gun with 11" vinyl hose. Low friction O-ring for positive sealing. Pumps approximately 1 pint of non-corrosive liquid per stroke.

*For case quantities order part  
number 4127-10*

**4130**

**Deluxe Heavy-Duty Pistol Grip  
Grease Gun**

6,000 PSI rated. Gun features unique 2-outlet port design which allows the hose or rigid extension to be mounted on the side or the top of the grease gun head. Aluminum head, 3-way loader capability (loader fitting included). Takes standard 14-1/2 ounce cartridge and has a 16 ounce bulk fill capacity. Gun comes with loader fitting, air release valve, hydraulic coupler with ball check and rigid extension. Packaged in a 4-color POP box. Compare to Alemite 525 & Lincoln 1132.

*For case quantities order  
part number 4130-10*

**4131**

**Deluxe Heavy-Duty Pistol Grip Grease  
Gun with 18" Hose**

Same as 4130 but also includes TIM-4321 18" rubber flex hose. Packaged in a 4-color POP box. Compare to Alemite 550 & Lincoln 1133.

*For case quantities order part  
number 4131-10*



## HAND GREASE GUN WHIP HOSES

<b>TIM-4320*</b>	<b>12" Whip Hose</b> 12" rubber flex hose. Coupled 1/8" NPT (M). 3,000 PSI maximum working pressure.
<b>TIM-4320-S*</b>	<b>12" Whip Hose</b> 12" flex hose. Coupled 1/8" NPT (M). Comes in clear clamshell display board packaging. 3,000 PSI maximum working pressure.
<b>TIM-4320-TP*</b>	<b>12" Whip Hose</b> 12" standard duty thermoplastic hose for hand-operated grease guns. Coupled 1/8" NPT (M). 3,000 PSI maximum working pressure.
<b>TIM-4321*</b>	<b>18" Whip Hose</b> 18" rubber flex hose. Coupled 1/8" NPT (M). 3,000 PSI maximum working pressure.
<b>TIM-4321-S*</b>	<b>18" Whip Hose</b> 18" rubber hose. Coupled 1/8" NPT (M). Comes in clear clamshell display board packaging. 3,000 PSI maximum working pressure.
<b>TIM-4321-TP*</b>	<b>18" Whip Hose</b> 18" standard duty thermoplastic hose for hand-operated grease guns. Coupled 1/8" NPT (M). 3,000 PSI maximum working pressure.
<b>TIM-4322*</b>	<b>24" Whip Hose</b> 24" rubber flex hose. Coupled 1/8" NPT (M). 3,000 PSI maximum working pressure.
<b>TIM-4323*</b>	<b>36" Whip Hose</b> 36" rubber flex hose. Coupled 1/8" NPT (M). 3,000 PSI maximum working pressure.

\* **WARNING:** For use on hand grease guns only. Do not use with air operated equipment. 3,000 PSI maximum working pressure.



TIM-4320

## HAND GREASE GUN WHIP HOSE ASSEMBLIES

<b>TIM-4340*</b>	<b>12" Whip Hose Assembly with Narrow Diameter Coupler (TIM-100)</b> Coupled 1/8" NPT (M). 3,000 PSI maximum working pressure.
<b>TIM-4341*</b>	<b>18" Whip Hose Assembly with Narrow Diameter Coupler (TIM-100)</b> Coupled 1/8" NPT (M). 3,000 PSI maximum working pressure.
<b>TIM-4342*</b>	<b>12" Whip Hose Assembly with Standard Diameter Coupler (TIM-101)</b> Coupled 1/8" NPT (M). 3,000 PSI maximum working pressure.
<b>TIM-4343*</b>	<b>18" Whip Hose Assembly with Standard Diameter Coupler (TIM-101)</b> Coupled 1/8" NPT (M). 3,000 PSI maximum working pressure.

\* **WARNING:** For use on hand grease guns only. Do not use with air operated equipment. 3,000 PSI maximum working pressure.



TIM-4340

## GREASE GUN LOADER FITTING

Used on the grease gun head for bulk loading applications using a grease filler pump. Standard 1/8" NPT (M).

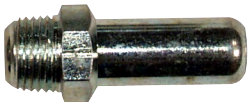

**TIM-24**  
**Filler Nipple**  
 Compatible with Lincoln style filler pumps

## HYDRAULIC & BUTTONHEAD GREASE COUPLERS

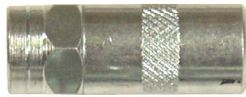

	<b>TIM-100*</b>	<b>TIM-101*</b>	<b>TIM-106</b>	<b>TIM-107</b>
<b>Size</b>	Narrow Diameter	Standard Diameter	Standard Buttonhead	Giant Buttonhead
<b>Thread Size</b>	1/8"(F)	1/8"(F)	1/8"(F)	1/8"(F)
<b>Type</b>	Ball Check	Ball Check	Pull On	Pull On
<b>Maximum PSI</b>	10,000 PSI	20,000 PSI	4,000 PSI	4,000 PSI

\* These couplers available in 25, 50 and 200 count packs

GREASE GUNS

## HYDRAULIC GREASE ADAPTERS



**TIM-124\***  
**360° Adjustable-Angle Standard Diameter Coupler**  
 Locks in place at 60° increments. Inlet thread 1/8" NPT (F). Overall length 3". 7,000 PSI maximum working pressure.



**TIM-126-1\***  
**High-Pressure Needle Point Grease Adapter**  
 Connects to grease coupler via included locking sleeve adapter. Overall length 5-1/2". 10,000 PSI maximum working pressure.



**4412\***  
**"Push-On" Grease Fitting Adapter**  
 Allows for easy greasing of standard grease fittings where access is limited or in low-height areas. Connects to grease coupler via included locking sleeve adapter.

\* **WARNING:** For use on hand-operated grease guns only

## GREASE FITTINGS

American Lubrication fittings are sold in clamshell display packs of 10 pieces and bags of 100 pieces. American Lubrication has one of the largest standing inventories of U.S. thread, metric thread, thread-forming, drive and stainless steel grease fittings. Our extensive offering of fittings covers virtually every automotive, agricultural, industrial, marine and lawn and garden application.

For fittings not listed please call American Lubrication.

### 1/8" PTF GREASE FITTINGS



**18-001\***   **18-002**   **18-003\***   **18-004\***   **18-030\***   **18-045\***   **18-065\***   **18-090\***

Type	Straight	Straight	Straight	Straight	30°	45°	65°	90°
Thread Size	1/8"	1/8"(F)	1/8"	1/8"	1/8"	1/8"	1/8"	1/8"
Length	.62"	1.00"	1.25"	1.77"	.91"	.98"	.88"	.82"

### 1/4"-28 GREASE FITTINGS



**14-28001\***   **14-28002**   **14-28003**   **14-28004**

Type	Straight	Straight	Straight	Straight
Thread Size	1/4"-28	1/4"-28	1/4"-28	1/4"-28
Length	.54"	.69"	.93"	1.08"



**14-28045**   **14-28046**   **14-28090\***   **14-28UNF**

Type	45°	45°	90°	Straight
Thread Size	1/4"-28	1/4"-28	1/4"-28	1/4"-28 UNF
Length	.88"	.97"	.69"	.49"

### 1/4" PTF GREASE FITTINGS

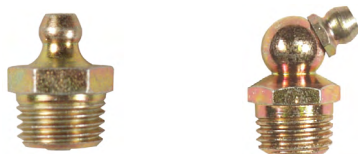

**14-001\***   **14-067\***

Type	Straight	67-1/2°
Thread Size	1/4"	1/4"
Length	.80"	.96"

### SPECIAL THREAD GREASE FITTINGS



**T-7504**   **T-7505**

Type	Straight	Straight
Thread Size	5/16"-24 UNF	3/8"-24 UNF
Length	.62"	.62"

Fittings must be purchased in quantities of 100

\* These fittings available in 10 packs

GREASE FITTINGS

### STAINLESS STEEL GREASE FITTINGS

Stainless steel grease fittings are designed to be used in harsh and highly corrosive environments. Stainless steel grease fittings use 303 stainless steel on the body and head, stainless steel stress relieving spring and a stainless steel ball. All stainless steel fittings have a single notch identification mark on the hexagonal corners.



**777-142801**



**777-142845\***



**777-142890\***



**777-1801\***



**777-1845\***

Type	Straight	45°	90°	Straight	45°
Thread Size	1/4"-28	1/4"-28	1/4"-28	1/8"	1/8"
Length	.54"	.88"	.69"	.62"	.99"



**777-1890\***



**777-1401**



**777-DR14**



**777-DR316**

Type	90°	Straight	Straight	Straight
Thread Size	1/8"	1/4"	1/4" Drive	3/16" Drive
Length	.82"	.82"	.5"	.5"

\* This fitting available in 10 packs

### METRIC THREAD GREASE FITTINGS



**M6-001**



**M6-045\***



**M6-090\***



**M8-001**



**M8-045**

Type	Straight	45°	90°	Straight	45°
Thread Size	M6 x 1	M6 x 1	M6 x 1	M8 x 1	M8 x 1
Length	.53"	.89"	.71"	.59"	.88"



**M8-090**



**M10-001\***



**M10-045\***



**M10-090\***

Type	90°	Straight	45°	90°
Thread Size	M8 x 1	M10 x 1	M10 x 1	M10 x 1
Length	.70"	.60"	.93"	.75"

\* This fitting available in 10 packs

## THREAD FORMING GREASE FITTINGS

Thread forming fittings have special hardened threads which allow the fitting to be screwed into a drilled hole which eliminates having to tap the hole. When installed, they force a rearrangement of the metal to conform with their own thread design, which is leak tight and permanent. They can easily be replaced by another thread forming fitting or standard fitting. All thread forming fittings have a yellow zinc finish and can withstand a 70-hour salt spray test.



**T-7302**



**T-7303**



**T-7305**



**T-7307**

Type	90°	Straight	90°	45°
Thread Size	1/8"	1/4"	1/4"-28	1/4"-28
Length	.69"	.56"	.68"	.78"

## DRIVE TYPE GREASE FITTINGS

Drive type fittings are most commonly used in high volume installations to avoid tapping costs. The serrated shank holds the fitting securely in place when driven into a hole. All drive fittings have a yellow zinc finish and can withstand a 70-hour salt spray test. *Actual drill size may depend upon the nature of the material into which the fitting is driven.*



**T-7603\***



**DR-316-NB2\***



**DR-316**



**DR-316-NB\***

Type	Straight	Straight	Straight	Straight
Thread Size	3/16"	3/16"	3/16"	3/16"
Length	.47"	.49"	.50"	.50"



**DR-14-NB\***



**DR-14**



**DR-516**



**T-7614**

Type	Straight	Straight	Straight	65°
Thread Size	1/4"	1/4"	5/16"	1/4"
Length	.41"	.50"	.58"	.85"



**T-7615**



**T-7616**



**T-7619\***



**T-7630\***

Type	Straight	Straight	Straight	Straight
Thread Size	6MM	8MM	1/8"	3/16"
Length	.57"	.61"	.47"	.39"

\* This fitting has no ball check

### BUTTONHEAD GREASE FITTINGS

All buttonhead fittings are straight fittings with a maximum pressure rating of 6,000 PSI. Standard buttonhead fittings are 5/8" diameter.



**BH-18**



**BH-14**



**BH-38**

Type	Standard	Standard	Standard
Thread Size	1/8"	1/4"	3/8"
Length	.76"	.83"	.98"

### VENTED, RELIEF & LEAKPROOF SPECIALTY FITTINGS

Relief fittings are designed to open at pre-determined pressures.

Leakproof fittings are equipped with a rubber seal instead of a ball check for use with light oils and heavy lubricants. Leakproof fittings are designed to handle up to 5,000 PSI of back pressure.



**T-7040**



**T-7046**



**T-7048**



**T-7049**



**T-7700**

Type	Vented	Relief	Relief	Relief	Leakproof
Relief Min.	--	1 PSI	1 PSI	1 PSI	--
Relief Max.	--	5 PSI	5 PSI	5 PSI	--
Thread Size	1/8" ‡	1/8"	1/8"	1/4"	1/8"
Length	.66"	.47"	.50"	.66"	.85"

‡ Thread is 1/8" PTF-SAE short

GREASE FITTINGS



## 110 PIECE STANDARD FITTING ASSORTMENT



**4450**

### 110 Piece Standard Grease Fitting Assortment

Includes forty (40) 14-28001, ten (10) 14-28045, ten (10) 14-28090, twenty (20) 18-001, ten (10) 18-045, ten (10) 18-065, and ten (10) 18-090.

## 110 PIECE METRIC FITTING ASSORTMENT



**4451**

### 110 Piece Metric Grease Fitting Assortment

Includes forty (40) M6-001, five (5) M6-045, five (5) M6-090, twenty (20) M8-001, five (5) M8-045, five (5) M8-090, twenty (20) M10-001, five (5) M10-045, and five (5) M10-090.

## 55 PIECE STAINLESS STEEL FITTING ASSORTMENT



**4452**

### 55 Piece Stainless Steel Grease Fitting Assortment

Includes twenty (20) 777-142801, five (5) 777-142845, five (5) 777-142890, ten (10) 777-1801, five (5) 777-1845, five (5) 777-1890, and five (5) 777-1401.

GREASE FITTINGS

## GREASE FITTING EXTRACTORS & RE-THREADING TOOLS



**TIM-151**

### Extractor & Re-Threading Tool

Used for replacing broken 1/4"-28 grease fittings



**TIM-152**

### Extractor & Re-Threading Tool

Used for replacing broken 1/8"-27 pipe thread grease fittings. PTF fittings are sometimes generically referred to as 1/8" NPT.







## AMERICAN LUBRICATION LIMITED WARRANTY

American Lubrication Equipment Corporation (ALEC) warrants to the original use purchaser for the original installation of the products depicted in this catalog. Warranty claims involving travel time and labor must be pre-approved by American Lubrication Equipment Corporation's service department. ALEC does not pay travel time to repair/replace control handles, air systems components or portable equipment.

### ALEC Products

ALEC, at its option, will repair or replace, free of charge, any product (excluding Advantage Plus and Challenger Series products) manufactured by ALEC that under normal use and service proves defective in material or workmanship, as determined by ALEC upon inspection within one year from date of purchase, 90 days from date of purchase if product is an air hose, two years from date of purchase if the product is an ESQ Series electric oil pump, DEF pump or three years from date of purchase if the product is an Electronic Digital Meter (excluding batteries) or Electronic Digital Metered Control Handle (excluding batteries), provided the product or part claimed to be defective is returned promptly to the ALEC facility or ALEC authorized service center with transportation charges prepaid, and is accompanied by original proof of purchase. This limited warranty does not cover failure of parts or components due to normal wear or damage or wear that in the judgement of ALEC results from misuse, abrasion, corrosion, negligence, accident, substitution of a non-ALEC part, faulty installation or tampering. If ALEC's inspection discloses no defect in material or workmanship, ALEC will notify the purchaser and, upon authorization by the purchaser, ALEC will repair or replace and return the product at ALEC's customary charges.

### Advantage Plus Products

ALEC will provide repair parts free of charge for any Advantage Plus product that under normal use and service proves defective in material or workmanship, as determined by ALEC upon inspection within five years from date of purchase, provided the part claimed to be defective is returned promptly to ALEC with transportation charges prepaid, and is accompanied by original proof of purchase.

During the first year, ALEC, at its option, will repair or replace, free of charge, any Advantage Plus product, that under normal use and service proves defective in material or workmanship, as determined by ALEC upon inspection within one year from date of purchase, provided the product or part claimed to be defective is returned promptly to ALEC or an ALEC authorized service center with transportation charges prepaid, and is accompanied by original proof of purchase. This limited warranty does not cover failure of parts or components due to normal wear or damage or wear that in the judgment of ALEC results from misuse, abrasion, corrosion, negligence, accident, substitution of a non-ALEC part, faulty installation or tampering. If ALEC's inspection discloses no defect in material or workmanship, ALEC will notify the purchaser and, upon authorization by the purchaser, ALEC will repair or replace and return the product at ALEC's customary charges.

The Advantage Plus Products 5 Year Limited Warranty does not cover routine maintenance, including but not limited to, normal user performed adjustments and maintenance of equipment, and the adjustment of any field adjustable packing nuts.

### Products Not Manufactured by ALEC

ALEC makes no warranty as to products, accessories or components not manufactured by ALEC. These are subject to the warranty, if any, of their manufacturer. ALEC will provide reasonable assistance to the purchaser in making such claims.

### Notice

The foregoing limited warranty supersedes, voids and is in lieu of any and all other warranties, expressed or implied. ALEC makes no warranty of merchantability or fitness for a particular purpose. ALEC's sole obligation and the original use purchaser's sole remedy is as stated above, and in no event shall ALEC be liable for any special, direct, indirect, incidental, consequential or other damages or expenses of any nature including, without limitation, loss of profits or production time incurred by the original use purchaser or any other party.

## ARO LUBRICATION EQUIPMENT WARRANTY

Ingersoll-Rand Fluid Products ("IRFP") warrants to the original use purchaser of the ARO® products depicted in this catalog that IRFP will repair or replace, free of charges, including return shipping costs within the Continental United States of America, any such product which under normal use and service proves defective in material and workmanship, as determined by IRFP inspection, within (A) 1 year from date of purchase of said products, other than the following, (B) 5 years from date of purchase of a Thunder Series Pump, (C) 5 years from date of purchase of a Diaphragm Pump, and (D) 5 years from date of purchase ARO® manufactured swivels, non-metered control handles, 4-1/4", 6" pumps, drains, follower plates, tie downs, siphon tubes, drum covers, provided the claimed defective product, or part thereof, is promptly returned to the IRFP factory or IRFP Customer Service Center with transportation charges prepaid.

This warranty does not cover failure of parts or components due to normal wear or damage or wear which in the judgement of ARO® arises from misuse, abrasion, corrosion, negligence, accident, substitution of non-ARO parts, faulty installation or tampering.

If IRFP inspection discloses no defect in material or workmanship, repair or replacement and return will be made at customary charges.

Equipment not covered by IRFP warranty: Accessories or components of equipment sold by IRFP that are not manufactured by IRFP (such as switches, hoses, meters, etc.) are subject to the warranty, if any, of their manufacturer. IRFP will provide the purchaser with reasonable assistance in making such claims.

The foregoing warranty supersedes, voids and is in lieu of all or any other warranties, expressed or implied, and no warranty of merchantability or fitness for particular purpose is intended or made. IRFP's sole obligation and the original use purchaser's sole remedy is as stated above and in no event shall IRFP be liable for any special, direct, indirect, incidental, consequential or other damages or expenses of any nature including, without limitation, loss of profits or production time incurred by the original use purchaser or any other party.

## ARO AIR SYSTEMS COMPONENTS WARRANTY

Ingersoll-Rand Fluid Products ("IRFP") warrants to the original use purchaser of the ARO® Air Systems Components depicted in this catalog that IRFP will repair or replace, free of charges, including return shipping costs within the Continental United States of America, any such product which under normal use and service proves defective in material or workmanship, as determined by IRFP inspection, two years from date of purchase, provided the claimed defective product or part thereof, is promptly returned to the IRFP Service Repair Center or a factory-authorized service repair center, with transportation charges prepaid.

If IRFP inspection discloses no defect in material or workmanship, repair or replacement and return will be made at customary charges.

The foregoing warranty supersedes, voids and is in lieu of all or any other warranties, expressed or implied, and no warranty of merchantability or fitness for particular purpose is intended or made. IRFP's sole obligation and the original use purchaser's sole remedy is as stated above and in no event shall IRFP be liable for any special, direct, indirect, incidental, consequential or other damages or expenses of any nature including, without limitation, loss of profits or production time incurred by the original use purchaser or any other party.

## AMERICAN LUBRICATION POLICY

**Returns:** No returns will be accepted without prior written authorization from American Lubrication Equipment Corporation. All items to be returned must be in the original factory carton and must be in unused re-saleable condition with transportation charges prepaid. All returned goods will be subject to inspection by American Lubrication Equipment Corporation before credit is issued. We reserve the right to charge an additional handling fee or return items to the purchaser if products are found to be in unacceptable condition upon our inspection. Customer must supply a copy of our original invoice as proof of purchase.

**Stock Adjustment:** Stock adjustments will be made with prior written authorization. A list including quantities and model numbers of items to be returned must be faxed or mailed to American Lubrication Equipment Corporation. Only active part numbers will be considered and the products must have been purchased within the last 18 months. A 15% handling charge will be assessed. The 15% handling charge will be waived if a 2:1 offsetting order accompanies the original request for stock adjustment.

**Warranty:** Warranty claims will be handled in accordance with the written warranties found in the Ingersoll-Rand ARO Fluid Products catalog and the American Lubrication Equipment Corporation lubrication equipment and supplies catalog. Contact either American Lubrication Equipment Corporation or one of our authorized warranty service centers with warranty claims.

**Defective Item(s):** Prior written authorization is required in order to return items that are defective. Fax or mail your request for authorization for return to American Lubrication Equipment Corporation. If the returned item is found not to be defective, upon our inspection, the item will be returned at the customer's expense.



Model	Page	Model	Page	Model	Page	Model	Page	Model	Page
110-RTDW-R33T	79	18-045	98	275DW	76	612041-3	12	67145-2	33
110-RTDW-R212D	79	18-065	98	275H	77	612999-1	29	67145-3-B	33
110-RTDW-R23D	79	18-090	98	275HDW	77	612999-2	29	67145-4-B	33
110-RTDW-R23N	79	2003	64	275V	77	612999-3	29	67442	22
110-RTDW-R23P	79	2003-14CAT	65	275VDW	76, 77	612999-4	30, 70	71027-1	35
110-RTDW-R25D	79	2003-P2	65	29665	84	612999-5	30, 70	71060-AL	22, 35
110-RTDW-R25N	79	2003-REP	65	400-RTDW-3BAR	79	612999-6	30, 71	75-TA-INSP	82
110-RTDW-R25P	79	210	86	400-RTDW-R212D	79	624601-4	93	777-1401	99
110-RTDW-X3X	79	210-100	86	400-RTDW-R23D	79	628067-3	93	777-142801	99
110-RTDW-X5X	79	210-212	86	400-RTDW-R23N	79	635040	87	777-142845	99
120B	76, 77	210-25	86	400-RTDW-R23P	79	635108	59	777-142890	99
120BC	77	210-300	86	400-RTDW-R25D	79	635193	58	777-1801	99
120BCDW	76, 77	23103-004	86	400-RTDW-R25N	79	635392	58	777-1845	99
120BCW	76	23103-300	86	400-RTDW-R25P	79	635395-2	58	777-1890	99
120BDW	76, 77	23644-400	87	400-RTDW-X3X	79	636075	60	777-DR14	99
14-001	98	23902-200	86	400-RTDW-X5X	79	636085	60	777-DR316	99
14-067	98	23902-210	86	4110	95	636088	60	91790	33
14-28001	98	23903-300	86	4111	95	636111	60	93110	33
14-28002	98	23903-310	86	4120	95	637083	12	93139	33
14-28003	98	23903-410	86	4127	95	637084	12	94117	33
14-28004	98	250	76	4130	95	637224	10	96916	33
14-28045	98	250B	77	4131	95	637226	10	AF0409A13PFL1	15
14-28046	98	250BDW	77	4148	22, 33	637227-B	20	AF0409A53PFL1	15
14-28090	98	250DW	76	4162	38	637332	20	AF0409C81BBW2	15
14-28UNF	98	2607	86	4166-1	39	637485	22	AF0450L43PKL1	23
150RVDW	76, 77	2608	86	4166-DEFN	6	637486	14	AF0450L53PKL1	23
165	76	2608-100	86	4188	38	637489	14, 22	AF060BL43PKL1	23
165-RTDW-3BAR	79	2608-25	86	4190	9, 38	640015-5	22, 36	AF060BL53PKL1	23
165-RTDW-R212D	79	2609	86	4412	97	640067	36	AIR-HP1414-10	92
165-RTDW-R23D	79	2609-100	86	4450	102	640152-1	22, 36	AIR-HP1414-15	92
165-RTDW-R23N	79	2609-25	86	4451	102	650715-C	27	AIR-HP1414-3	92
165-RTDW-R23P	79	2609-300	86	4452	102	650717-C	30	AIR-HP1414-5	92
165-RTDW-R25D	79	270RVDW	76, 77	500C	77	650718-C	30	AIR-HP3800-	92
165-RTDW-R25N	79	275-RTDW-3BAR	79	500CDW	77	65130	22	AIR-HP3800-250	92
165-RTDW-R25P	79	275-RTDW-R212D	79	500RV	76, 77	66492	22, 35	AIR-HP3812-2Z	92
165-RTDW-X3X	79	275-RTDW-R23D	79	500RVDW	76, 77	66605J-322	27	AIR-HP3838-2	47, 92
165-RTDW-X5X	79	275-RTDW-R23N	79	525DW	76	66605J-344	27	AIR-HP3838-2N	47
165B	77	275-RTDW-R23P	79	525RDW	76	666100-344-C	27	AIR-HP3838-4	92
165BDW	77	275-RTDW-R25D	79	525RH	77	666100-362-C	27	AIR-HP3838-4NS	46
165DW	76	275-RTDW-R25N	79	525RHDW	77	666100-3C9-C	27	AIR-HP3838-50	92
18-001	98	275-RTDW-R25P	79	525RND	76	666150-362-C	27	AIR-HP3838-65	92
18-002	98	275-RTDW-X3X	79	60869	33	66715	22, 35	AIR-RF3800-12	92
18-003	98	275-RTDW-X5X	79	60870	33	67088	33	AIR-RF3800-14	92
18-004	98	275A	76	60898	22, 35	67088-3	33	AIR-RF3800-38	92
18-030	98	275AV	76	61113	34	67088-4	33	BH-14	101

\* Tank package part numbers do not appear in the numerical index. They can be found on pages 76 through 80.

Model	Page	Model	Page	Model	Page	Model	Page	Model	Page
BH-18	101	DEF-69	9	DM0409A53PFL1000	15	LM2350E-41-B	20	QL-308	70, 83
BH-38	101	DEF-70	9	DM0450L53PKL1000	23	LP2001-1-B	21	R-37221-600T	84
C38121-801	85	DEF-71	9	DR-14	100	LP2002-1-B	21, 25	R37121-100	84
C38221-810	85	DEF-72	9	DR-14-NB	100	LP2003-1-B	21	R37221-100	84
C38221-811	85	DEF-73	8	DR-316	100	LP2004-1-B	21	R37221-200	84
C38331-811	85	DEF-74	9	DR-316-NB	100	LP2006-1-ALC	21, 25	R37231-600	84
C38341-810	85	DEF-75	9	DR-316-NB2	100	LP2006-1-B	21, 25	R37331-600	84
C38351-811	85	DEF-75BT	9	DR-516	100	LP2100-1-ALC	17	R37341-100	84
C500	76	DEF-76	9	F-100	84	LP2100-1-B	17	R37341-600	84
C500DW	76	DEF-78	9	F35121-421	84	LP3001-1	21, 25	R37351-100	84
DC0450L53PKL1000	23	DEF-79	9	F35221-411	84	LP3002-1	21	RPM-3-TM1	80
DC060BL53PKL1C11	23	DEF-80	9	F35231-411	84	LP3003-1	21	RPM-3-TM2	80
DEF-10	4	DEF-81	9	F35331-410	84	LP3004-1	21, 25	RPM-3-TM3	80
DEF-1000	5	DEF-TUBE55	8	F35341-400	84	LP3004-1-ALC	21, 25	RPM-5-TM1	80
DEF-100AH	6	DEF2-BKT	8	F35341-410	84	LP3005-1	21	RPM-5-TM2	80
DEF-100AS	6	DEF3-BKT	8	F35351-411	84	LP3005-1-50R	21, 25	RPM-5-TM3	80
DEF-11	4	DEF3-DN49N	2	F35451-410	84	LP3005-1-ALC	21	RV-1	72
DEF-12	4	DEF3-DN50N	2	K1875C81BBW2	14	LP3008-1	21	SDB-10-TIM	89
DEF-13	4	DEF3-TM49C	2	L36121-100	84	LP3009-1	21	SEB-10-TIM	89
DEF-22	7	DEF3-TM49E	2	L36221-110	84	LP3100-1-ALC	17	SFB-10-TIM	89
DEF-25	9	DEF3-TM49N	2	L36331-110	84	LP3100-1-B	17	SGB-10-TIM	89
DEF-25A	9	DEF3-TM49N4	2	L36341-110	84	M10-001	99	SHB-10-TIM	89
DEF-31	9	DEF3-TM49S	2	L36351-110	84	M10-045	99	SJB-10-TIM	89
DEF-32	9	DEF3-TM50N	2	LM-2203A-31C	11	M10-090	99	SMB-10-TIM	89
DEF-34A	8	DEF3-TM50N4	2	LM-2203A-41C	11	M6-001	99	SOB-10-TIM	89
DEF-34PL	8	DEF3-TM50S	2	LM-2203A-51C	11	M6-045	99	T-7040	101
DEF-39	8	DEF3-TM57N	2	LM-2203A-C	11	M6-090	99	T-7046	101
DEF-40A	8	DEF3-TN49N	2	LM-2203A-COMP	11	M8-001	99	T-7048	101
DEF-40PL	8	DEF3-TN49S	2	LM-2203A-H	11	M8-045	99	T-7049	101
DEF-41	8	DEF3-TN50C	2	LM-2203A-HWM	11	M8-090	99	T-7302	100
DEF-42	8	DEF3-TN50N	2	LM-2203AV-61C	11	MSCF22-000	86	T-7303	100
DEF-43	8	DEF3-TN50N4	2	LM-2305A-31B	11	MSCF23-000	86	T-7305	100
DEF-44	8	DEF3-TN58S	2	LM-2305A-41B	11	MSCM22-000	86	T-7307	100
DEF-45	8	DEF3A-PUMP	6	LM-2305A-51B	11	P-39124-624	85	T-7504	98
DEF-49	7	DEF6-DM49N	3	LM-2305AV-61B	11	P-39224-624	85	T-7505	98
DEF-49-SWIVEL	7	DEF6-DN50N	3	LM-2305A-C	11	P39124-124	85	T-7603	100
DEF-50	7	DEF6-PUMP	6	LM-2305A-COMP	11	P39234-614	85	T-7614	100
DEF-51A	9	DEF6-TM49C	3	LM-2305A-H	11	P39344-614	85	T-7615	100
DEF-52H33S	7	DEF6-TM49E	3	LM-2305A-HWM	11	P39354-614	85	T-7616	100
DEF-53A	9	DEF6-TM49N	3	LM2203A-11-C	11	PD03P-ARS-PAA	27	T-7619	100
DEF-54	8	DEF6-TM49N4	3	LM2250E-21-B	20	PD05P-AAS-PGG	27	T-7630	100
DEF-55	9	DEF6-TM49S	3	LM2250E-31-B	20	PD07P-APS-PAA	6	T-7700	101
DEF-57A	7	DEF6-TN49N	3	LM2305A-11-B	11	PD10P-APS-PAA	6	TG-275H	82
DEF-57	7	DEF6-TN50C	3	LM2350E-21-B	20	PD20A-AAP-GGG-B	27	TG-32	82
DEF-58	7	DEF6-TN50N	3	LM2350E-31-B	20	QL-101	83	TG-36	82

\* Tank package part numbers do not appear in the numerical index. They can be found on pages 76 through 80.

Model	Page	Model	Page	Model	Page	Model	Page	Model	Page
TG-44	82	TIM-1241	91	TIM-160	81	TIM-3108-100P	45	TIM-365-5S	65
TG-46	82	TIM-1242	91	TIM-164	81	TIM-3108-75P	45	TIM-366	36
TG-60	82	TIM-1243	91	TIM-166-1	32	TIM-315-BOWL	69	TIM-367-1	35
TG-72	82	TIM-1244	91	TIM-166-LLC	32	TIM-315-COMP2	67	TIM-368	36
TIM-035-100	89	TIM-1245	91	TIM-178	73	TIM-315-KIT	69	TIM-369	35
TIM-035-1000	89	TIM-126-1	97	TIM-179	73	TIM-316A-BOWL	69	TIM-370-3M	71
TIM-083-100	89	TIM-1260	91	TIM-180	73	TIM-316A-KIT	69	TIM-390-A1	18
TIM-083-1000	89	TIM-1263	91	TIM-181	73	TIM-317-37C	69	TIM-3900-50	43
TIM-1-A	62	TIM-131-3	47	TIM-181-G	73	TIM-317-A	66	TIM-3916-50	43
TIM-100	61, 97	TIM-131-4	47	TIM-181-N	73	TIM-317-AAM	66	TIM-3916-65	43
TIM-1001-BV	88	TIM-131-A	47	TIM-182	73	TIM-317-CAM	66	TIM-3918-50A	43
TIM-101	61, 97	TIM-1404-1212	90	TIM-183	73	TIM-317-PAN	69	TIM-3918-65A	43
TIM-1049	34	TIM-1404-1216	90	TIM-190	81	TIM-318	69	TIM-3928-50	43
TIM-1052	34	TIM-1404-128	90	TIM-192	88	TIM-318-BOWL	69	TIM-3936-50	43
TIM-1055	34	TIM-1404-1612	90	TIM-193	88	TIM-319	69	TIM-3A-DM	62
TIM-1056	34	TIM-1404-1616	90	TIM-196-C	32	TIM-32-34A	37	TIM-401	37
TIM-1057	34	TIM-1404-22	90	TIM-198	81	TIM-32-34P	37	TIM-408	37
TIM-1058	34	TIM-1404-42	90	TIM-1A-DM	62	TIM-3208-100P	45	TIM-4208-100	92
TIM-1059	34	TIM-1404-44	90	TIM-2-A	62	TIM-3208-75P	45	TIM-4208-50	92
TIM-1059-V	34	TIM-1404-46	90	TIM-2000-1	65	TIM-322	39	TIM-4208-65	92
TIM-106	97	TIM-1404-64	90	TIM-2000-10	31, 72	TIM-322-A	39	TIM-4208-75	92
TIM-107	97	TIM-1404-66	90	TIM-2000-2	65, 87	TIM-323	39	TIM-4218-2N	47, 92
TIM-111-1	60	TIM-1404-68	90	TIM-2000-2A1	65, 87	TIM-3306-75P	45	TIM-4218-4NS	46, 92
TIM-113	60	TIM-1404-812	90	TIM-2000-3A	65, 87	TIM-340	68	TIM-4258-5	92
TIM-115	60	TIM-1404-84	90	TIM-2000-3B	87	TIM-341	68	TIM-430	47
TIM-116	60	TIM-1404-86	90	TIM-2000-3C	87	TIM-3412-50P	45	TIM-4320	96
TIM-1200-1	91	TIM-1404-88	90	TIM-2000-3D	87	TIM-351-1	37	TIM-4320-S	96
TIM-1201-1	91	TIM-1405-1212	90	TIM-2000-4	31, 65	TIM-351-8	37	TIM-4320-TP	96
TIM-1202-1	91	TIM-1405-128	90	TIM-2000-4A	31, 65	TIM-351-8HD	37	TIM-4321	96
TIM-1204-1	91	TIM-1405-1616	90	TIM-2000-5	65	TIM-352	36	TIM-4321-S	96
TIM-1205-1	91	TIM-1405-44	90	TIM-2000-6A	31, 65	TIM-353	36	TIM-4321-TP	96
TIM-1206-1	91	TIM-1405-64	90	TIM-212-1	85, 91	TIM-355-1	36	TIM-4322	96
TIM-1208-1	91	TIM-1405-86	90	TIM-220	85	TIM-358	36	TIM-4323	96
TIM-1209	91	TIM-1405-88	90	TIM-221	85	TIM-3600-50	41	TIM-4340	96
TIM-1210-1	91	TIM-1501-1212	90	TIM-24	97	TIM-3600-CAB	46	TIM-4341	96
TIM-1220	91	TIM-1501-44	90	TIM-250-BV	88	TIM-3600-PAN	46	TIM-4342	96
TIM-1221	91	TIM-1501-66	90	TIM-254-D	47	TIM-3616-50	41	TIM-4343	96
TIM-1222	91	TIM-1501-86	90	TIM-2A-DM	62	TIM-3616-65	41	TIM-4360	61
TIM-1223	91	TIM-1501-88	90	TIM-3-A	62	TIM-3618-50A	41	TIM-4361	61
TIM-1225	91	TIM-1501-BV	88	TIM-30-11A	63	TIM-3618-65A	41	TIM-4412-15	93
TIM-1226	91	TIM-1504-44	90	TIM-30-5A	63	TIM-3628-25	41	TIM-4412-3	47, 93
TIM-1227	91	TIM-1504-66	90	TIM-307	18	TIM-3628-50	41	TIM-4412-30	93
TIM-1230	91	TIM-1504-88	90	TIM-310	69	TIM-363	22, 36	TIM-4412-5	47, 93
TIM-124	97	TIM-151	102	TIM-3106-100P	45	TIM-3636-50	41	TIM-4412-50	93
TIM-1240	91	TIM-152	102	TIM-3106-75P	45	TIM-364	22, 36	TIM-4416-10	93

\* Tank package part numbers do not appear in the numerical index. They can be found on pages 76 through 80.

Model	Page	Model	Page	Model	Page	Model	Page	Model	Page
TIM-4416-15	93	TIM-4516-4NS	46, 94	TIM-600-RA	49	TIM-720-YEL	59	TIM-795-1	60
TIM-4416-3	93	TIM-4516-8	94	TIM-600-RM	49	TIM-724-1B	13	TIM-80	24
TIM-4416-30	93	TIM-4517-14	94	TIM-600-RMGO	49	TIM-726-2	13	TIM-83-KM	24
TIM-4416-5	93	TIM-4524-10	94	TIM-600-RMHF	49	TIM-727-2	13	TIM-87	38
TIM-4416-50	93	TIM-4524-12	94	TIM-601-FA	49	TIM-728-2	13	TIM-88	87
TIM-4416-8	93	TIM-4524-15	94	TIM-601-FM	49	TIM-729	16	TIM-89	87
TIM-4418-100S	93	TIM-4524-2	94	TIM-601-FMHF	49	TIM-729-P	16	TIM-90	87
TIM-4418-10S	93	TIM-4524-20	94	TIM-601-RA	49	TIM-730	16	TIM-900B-1	53
TIM-4418-12	93	TIM-4524-25	94	TIM-601-RM	49	TIM-730-P	16	TIM-901B-1	53
TIM-4418-15	93	TIM-4524-30	94	TIM-601-RMGO	49	TIM-732	16	TIM-901B-HF	53
TIM-4418-16S	93	TIM-4524-6	94	TIM-601-RMHF	49	TIM-733	16	TIM-910-HF	54
TIM-4418-18	93	TIM-460-3	34	TIM-61	19	TIM-733-50	16	TIM-911-HF	54
TIM-4418-18S	93	TIM-460-5	34	TIM-615	55	TIM-734	28	TIM-912-HF	54
TIM-4418-2.5NS	93	TIM-460-A	34	TIM-616	55	TIM-734-TOTE	28	TIM-94-MI	59
TIM-4418-20S	93	TIM-461-B	34	TIM-62-1A	19	TIM-74	39	TIM-AIR-BOX	87
TIM-4418-25S	93	TIM-463	8, 34	TIM-62-2	19	TIM-74-AL	39	TIM-CONV-CAM	66
TIM-4418-2NS	47, 93	TIM-464-A	34	TIM-62-2C	19	TIM-742	49, 57	TIM-D2-36	82
TIM-4418-30S	93	TIM-465	34	TIM-62-LD2	19	TIM-743	49, 51, 57	TIM-D2-44	82
TIM-4418-40	93	TIM-4670-1	73	TIM-63-2	19	TIM-743-1	49, 51, 57	TIM-D2-48	82
TIM-4418-4NS	46, 93	TIM-4670-2	73	TIM-63-2C	19	TIM-746	49, 51, 57	TIM-FILL-CAP	81
TIM-4418-4S	93	TIM-4670-3	73	TIM-63-LD2	19	TIM-747	49, 51, 57	TIM-GG-44	82
TIM-4418-50S	93	TIM-4670-4	73	TIM-64-2	19	TIM-75	38	TIM-GG-60	82
TIM-4418-5S	93	TIM-4670-5	73	TIM-64-2C	19	TIM-752	49, 51, 57	TIM-GG-72	82
TIM-4418-65S	93	TIM-4675	70	TIM-64-LD2	19	TIM-752-BV	88	TIM-H2-32	82
TIM-4418-6S	93	TIM-4675-1	73	TIM-640015-1	36	TIM-753	49, 51, 57	TIM-H2-60	82
TIM-4418-75S	93	TIM-4675-2	73	TIM-650-FA	51	TIM-755-1	53	TIM-I-55B	29
TIM-4418-8S	93	TIM-4675-3	73	TIM-650-FM	51	TIM-756-1	53	TIM-LABEL-KIT	67
TIM-4430	31	TIM-4675-4	73	TIM-650-FMHF	51	TIM-758-1	53	TIM-MTL-23	32
TIM-4431	31	TIM-4676	72	TIM-650-RA	51	TIM-761	57	TIM-MTL-26	32
TIM-4506-100	94	TIM-4676-1	73	TIM-650-RM	51	TIM-761-GO	57	TIM-MTL-28	32
TIM-4506-15	94	TIM-4676-2	73	TIM-650-RMHF	51	TIM-761-HF	57	TIM-MTL-35	32
TIM-4506-25S	94	TIM-4676-3	73	TIM-651-FA	51	TIM-761-M	57	TIM-MTL-37	32
TIM-4506-30F	94	TIM-4676-4	73	TIM-651-FM	51	TIM-761-TG	57	TIM-MTL-42	32
TIM-4506-50S	94	TIM-48-S	59	TIM-651-FMHF	51	TIM-761-TGGO	57	TIM-MTL-51	32
TIM-4506-65S	94	TIM-5-A2	63	TIM-651-RA	51	TIM-761-TGHF	57	TIM-MTL75-25	32
TIM-4506-75S	94	TIM-500-600	88	TIM-651-RM	51	TIM-761-TGM	57	TIM-MTL75-37	32
TIM-451-1	35	TIM-500-FV	63	TIM-651-RMHF	51	TIM-762	57	TIM-MTL75-39	32
TIM-4513-5	94	TIM-500-HP1	88	TIM-66-A	24	TIM-762-A	57	TIM-MTL75-53	32
TIM-4514-10	94	TIM-500-HP2	88	TIM-717-1	55	TIM-762-HF	57	TIM-MUSH-VENT	81
TIM-4514-2	94	TIM-502-BV	88	TIM-717-2	55	TIM-762-TG	57	TIM-OILSPIGOT-KIT	62
TIM-4514-20	94	TIM-6	63, 65	TIM-717-3	55	TIM-762-TGA	57	TIM-PLUG-1	81
TIM-4514-30	94	TIM-60	19	TIM-720-BLK	59	TIM-762-TGHF	57	TIM-PLUG-2	81
TIM-4516-2	94	TIM-600-FA	49	TIM-720-BLU	59	TIM-77	38	TIM-PLUG-3	81
TIM-4516-2N	47, 94	TIM-600-FM	49	TIM-720-GRN	59	TIM-79-SS	38	TIM-PLUG-3/4	81
TIM-4516-4	94	TIM-600-FMHF	49	TIM-720-RED	59	TIM-794	60	TIM-PLUG-4	81

\* Tank package part numbers do not appear in the numerical index. They can be found on pages 76 through 80.

Model	Page
TIM-PLUG-6 .....	81
TIM-RELIEF-KIT .....	31
TIM-SPILL-BOX3 .....	81
TIM-VENT-2 .....	81
TIM-VENT-3 .....	81
TIM-VENT-4S .....	81
TIM-VENT-6 .....	81
TIM-WAND-1 .....	72
WASTE-LABEL-KIT ....	67
Y-27-53C .....	85
Y-27-54C .....	85
Y-27-54C .....	91
Y-27-55C .....	85
Y-43-4C .....	90

\* Tank package part numbers do not appear in the numerical index. They can be found on pages 76 through 80.

© 2019 American Lubrication Equipment Corporation. All rights reserved. AMERICAN LUBRICATION EQUIPMENT CORPORATION, the A and A ADVANTAGE PLUS logos and SUPERIOR TECHNOLOGY AT AN AFFORDABLE PRICE are registered trademarks, and AMERICAN BLUE SYSTEMS and CHALLENGER [list any other marks of American Lubrication here, e.g. INDUSTRIAL, PLATINUM, and PRO] are trademarks of American Lubrication Equipment Corporation.

General Notice: Other product names used herein are for identification purposes only and may be trademarks of their respective owners. American Lubrication Equipment Corporation disclaims any and all rights in those marks.



# AMERICAN LUBRICATION EQUIPMENT CORPORATION HISTORY

**DECEMBER 18 1918**

The Alemite Company of Maryland is founded by Charles F. Eck in Baltimore Maryland

**LATE 1920S**

Complete lines of petroleum products and lubrication equipment expand the company's product base

**1940S**

All-out effort to supply the U.S. government for the war.

Charles F. Eck served as a dollar-a-year man in Washington

**1950S & 1960S**

Solid growth years for the company, which moved 6 times to larger facilities in Baltimore

**1980**

Founder, Charles F. Eck is succeeded as president by C. Franklin Eck, Jr.

**1990S**

Company grew from a Mid-Atlantic regional operation to a major East Coast distribution center

**OCTOBER 2009**

Moved to present headquarters in Hunt Valley, MD

**1920S**

Marketing was expanded to car dealers through newly packaged automotive kits

**1930S**

Added first line of industrial lubrication equipment

**POST-WAR 1950S**

Continued to grow and expand its product base, adding a complete line of automotive, marine and industrial instruments

**1960S & 1970S**

Among one of the first companies to be fully computerized.

C. Franklin Eck, Jr presided over a major re-engineering of the company from a predominately single-source supplier to multiple supply sources

**OCTOBER 1988**

Changed name to American Lubrication Equipment Corporation

**1997**

Became a truly national distributor, opening offices and warehouse facilities on the West Coast in Anaheim, CA that allow it to fully serve national accounts in all states

**2015**

C. Franklin Eck is succeeded as president by Eben Eck





**DISTRIBUTED BY**



American Lubrication  
Equipment Corporation

Headquarters  
11212 A McCormick Road  
Hunt Valley, MD 21031

West Coast Dist. Facility  
1251 North Patt Street  
Anaheim, CA 92801

Phone 410-252-9300