

### A) Magnesium Keyhole Paver's Straightedge

Special keyhole design for strength. Sturdy, lightweight highway straightedge and checking tool. Plugged ends eliminate build-up in tool. Comes complete with braces, 10' aluminum button handle (CC291), Knucklehead® II bracket (CC296) and roller bearing collar for easy tool adjustment.

| No.     | Size |   |
|---------|------|---|
| CC721** | 10'  | Add "01" after part no. for screed without bracket, braces, bearing collar, or handle |
| CC722** | 12'  |   |
| CC723** | 16'  |   |
| CC724** | 20'  |   |

### B) Magnesium Keyhole Hand Screed (Only)

Unique shape makes it easy to grip and the perfect tool for hand screeding. Plugged ends eliminate build-up in tool.

| No.     | Size |
|---------|------|
| CC726** | 10'  |
| CC727** | 12'  |
| CC728** | 16'  |
| CC729** | 20'  |

\*\*Must ship via truck

GENUINE EXTRU-LITE™ MAGNESIUM

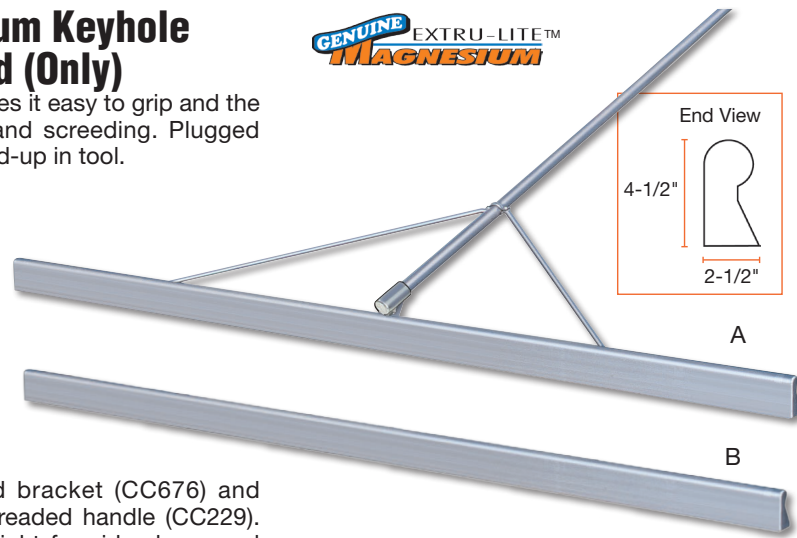

### Combination Keyhole Mag Bump Screed (not shown)

Unique straightedge design can be reversed to use the flat or curved side of the tool. Plugged ends eliminate build-up in tool.

Includes threaded bracket (CC676) and 12' magnesium threaded handle (CC229). See End View at right for side shape and measurements.

| No.     | Size |
|---------|------|
| CC730** | 12'  |

\*\*Must ship via truck

### BuckEye™ Straightedge With Level Vial Handle

One-person straightedge for striking off, leveling and bringing concrete to surface grade. Top reading spring-loaded level vial for easy on-the-job adjustments. Made of lightweight high grade aluminum alloy. Wood handle tapered for smooth comfortable grip.

| No.     | Size              |
|---------|-------------------|
| CC891   | 4'x1-1/2"x1-1/2"  |
| CC892   | 5'x1-1/2"x1-1/2"  |
| CC893   | 6'x1-1/2"x1-1/2"  |
| CC894   | 8'x1-1/2"x1-1/2"  |
| CC895** | 10'x1-1/2"x1-1/2" |
| CC896** | 12'x1-1/2"x1-1/2" |

\*\*Must ship via truck

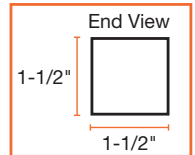

### Buckaroo™ Straightedge With Level Vial Handle

One-person straightedge for floating or striking off concrete. Smooth tapered handle includes top reading adjustable level vial for easy positioning. Base of tool comes with round edge for floating and square edge for cutting. Made from magnesium, very lightweight. Ideal for concrete and landscape construction.

| No.      | Size          |
|----------|---------------|
| CC897    | 40"x1-3/8"x2" |
| CC421L   | 4'x1-3/8"x2"  |
| CC422L   | 6'x1-3/8"x2"  |
| CC428L   | 8'x1-3/8"x2"  |
| CC423L** | 10'x1-3/8"x2" |

\*\*Must ship via truck

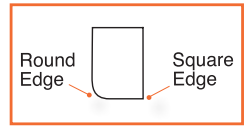

### Aluminum Curb Forming Tool

Lightweight aluminum blade is used to shape curbs. Features two comfortable wooden knob handles set 12" from each end. End caps prevent build up of material from extended use.

| No.   | Size      |
|-------|-----------|
| CC635 | 48"x1"x2" |



# DARBIES



## Extruded Magnesium Mini Bull Float and Darby

Unique T-slotted reinforcing rib (no threads to strip) adds strength and allows the threaded bracket (CC665) to be quickly set off-center to work float around obstructions. Two wood float handles can easily slide for adjusting to hand and curb work. This float is also ideal for floating lightweight concrete on roof decks. Use with threaded handles.

| No.     | Size       |           |
|---------|------------|-----------|
| CC816   | 36"x3-1/4" |           |
| CC816RE | 36"x3-1/4" | Round End |
| CC817   | 42"x3-1/4" |           |
| CC818   | 48"x3-1/4" |           |
| CC819   | 60"x3-1/4" |           |

## Tapered Magnesium Darby

The most popular lightweight 30" darby for precision finish work. Tapered design creates ease in moving across concrete with a sweeping motion. Extruded Magnesium blade is 3-1/8" wide at the heel, tapered to 1-7/8" at the toe.

### Wood Handle

| No.   | Size |
|-------|------|
| CF030 | 30"  |

### ProForm® Handle

|         |     |
|---------|-----|
| CF030PF | 30" |
|---------|-----|

See Elite Series™ Magnesium Darby on page 16



## Extruded Magnesium Darby with Knob Handle

This lightweight magnesium darby has a float-type handle and a round knob handle. The unique T-Channel design gives the finisher the option of sliding the handle position to their preference.

### Wood Handles

| No.   | Size       |
|-------|------------|
| CF032 | 30"x3-1/4" |
| CF033 | 36"x3-1/4" |

### ProForm® Handles

| No.     | Size       |
|---------|------------|
| CF032PF | 30"x3-1/4" |
| CF033PF | 36"x3-1/4" |



## Extruded Magnesium Hand and Curb Darby

Specifically designed for curb work, this lightweight tool comes with your choice of one or two float-type handles. T-Channel design gives the finisher the option of adjusting handle position to their preference.

### With 2 handles

#### Wood Handle

| No.   | Size       |
|-------|------------|
| CF041 | 36"x3-1/4" |
| CF042 | 42"x3-1/4" |
| CF043 | 48"x3-1/4" |

#### ProForm® Handle

| No.     | Size       |
|---------|------------|
| CF041PF | 36"x3-1/4" |
| CF042PF | 42"x3-1/4" |
| CF043PF | 48"x3-1/4" |

### With 1 Handle (not shown)

#### Wood Handle

| No.   | Size       |
|-------|------------|
| CF031 | 30"x3-1/4" |
| CF036 | 36"x3-1/4" |

#### ProForm® Handle

| No.     | Size       |
|---------|------------|
| CF031PF | 30"x3-1/4" |
| CF036PF | 36"x3-1/4" |



### Tapered Mahogany Darby

*Tapers from about 3-1/2" at the heel to 2-1/2" at the front*

Four sizes designed and made of clear seasoned mahogany wood. Blade is 3/4" thick. Finished smooth and comes with either a one, two, or three hole grip. Very popular with many concrete finishers.

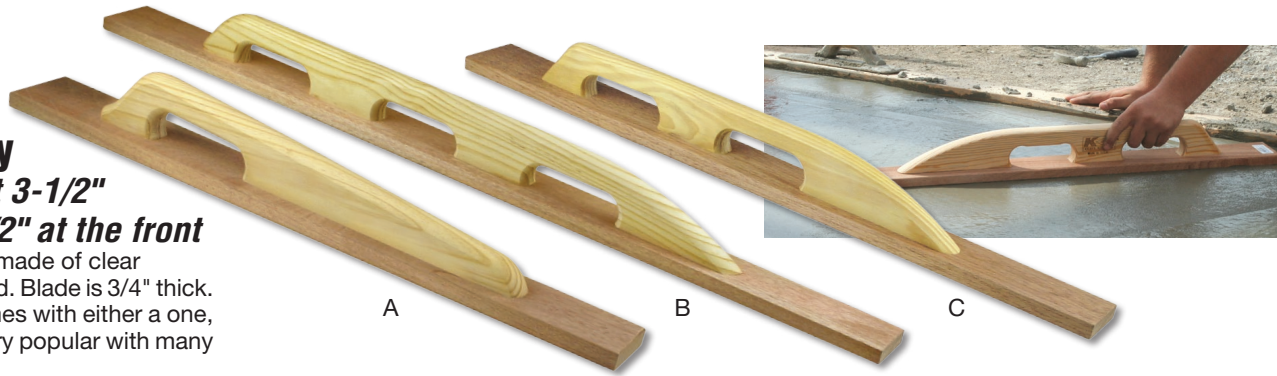

| A) No. | Sizes                           |
|--------|---------------------------------|
| CF236  | 36" (1) Hole Grip               |
| CF258  | 28" (1) Hole Grip               |
| CF254  | Replacement Handle 21" (1 Hole) |

| B) No. | Sizes                           |
|--------|---------------------------------|
| CF259  | 45" (3) Hole Grip               |
| CF253  | Replacement Handle 32" (3 Hole) |

| C) No.   | Sizes                           |
|----------|---------------------------------|
| CF237    | 36" (2) Hole Grip               |
| CF255    | 48" (2) Hole Grip (Not Tapered) |
| CF237-01 | Replacement Handle 24" (2 Hole) |

### A) Tapered Laminated Canvas-Resin Darby

Tapered, laminated canvas-resin darby is 3/8" thick. Tapers from 3-1/2" at heel to 2-1/2" at the toe to smooth for the final finish. Rounded corners, and broken-in shape make it ready to use.

| No.   | Size  |
|-------|---|
| CF510 | 45" Tapered Darby 3-Hole Handle             |
| CF509 | 30" Tapered Darby 1-Hole Handle (not shown) |



### B) Tapered Darby with Level Vial

Top reading spring-loaded vial for easy on the job adjustments.

| No.    | Size                            |
|--------|---------------------------------|
| CF510L | 45" Tapered Darby 3-Hole Handle |

### Redwood Striker™ Straightedge/Screed

*Lightweight, Rounded Edges*

Made of the finest redwood, this tool is great for striking off concrete and leveling other material. Three popular lengths with convenient hand hole spacing. Two widths with rounded edges will not dig into material. Choose with adjustable level vial for easy on the job adjustments.

**Without Level Vial**

| No.     | Size              | W   |
|---------|-------------------|-----|
| CC439   | 6'x4-1/2"x1-1/4"  | 5/4 |
| CC440   | 8'x4-1/2"x1-1/4"  | 5/4 |
| CC441** | 10'x4-1/2"x1-1/4" | 5/4 |

**With Adjustable Level Vial**

|          |               |     |
|----------|---------------|-----|
| CC442L   | 6'x4-1/2"x2"  | 8/4 |
| CC443L   | 8'x4-1/2"x2"  | 8/4 |
| CC444L** | 10'x4-1/2"x2" | 8/4 |

\*\*Must ship via truck



### Aussie Combo Darby/Screed

*With Adjustable Handles*

This innovative tool can be used as a float, screed, or check rod when you want the perfect finish. Base of tool comes with a round edge for floating and a square edge for cutting and filling. Lightweight magnesium with long handles that adjust for comfort.

| No.     | Size          | Handles |
|---------|---------------|---------|
| CC421   | 4'x1-3/8"x2"  | 1       |
| CC422   | 6'x1-3/8"x2"  | 1       |
| CC423** | 10'x1-3/8"x2" | 2       |

\*\*Must ship via truck

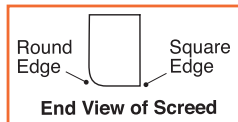

### Whiskey Stick

Magnesium blade levels and places concrete fast. Rounded edge for floating and square edge for cutting and filling. Handle tilts to the right floating angle. Fitted with heavy-duty braces and 72" long, 1-3/8" diameter button extension handle.

| No.   | Size |
|-------|------|
| CC425 | 5'   |

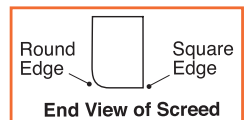
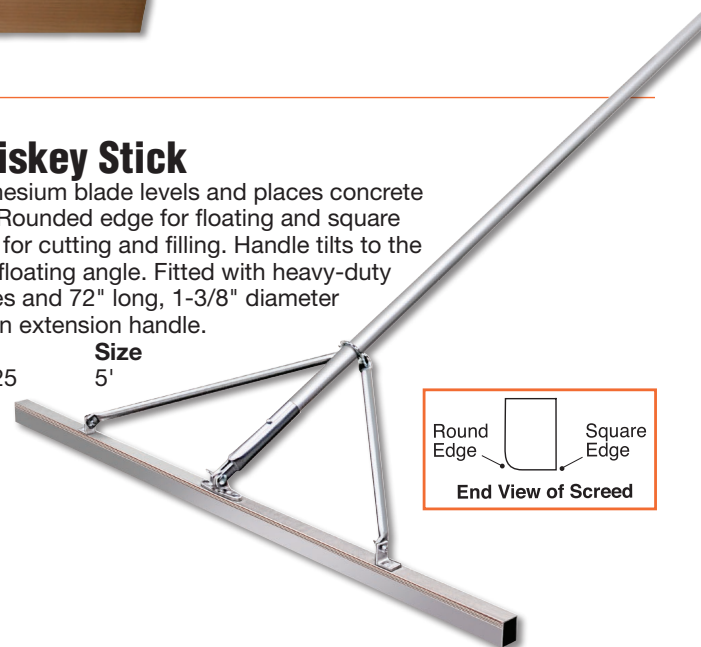

# PROFORM® POWER TROWELER REPLACEMENT BLADES



4 Blades Per Box

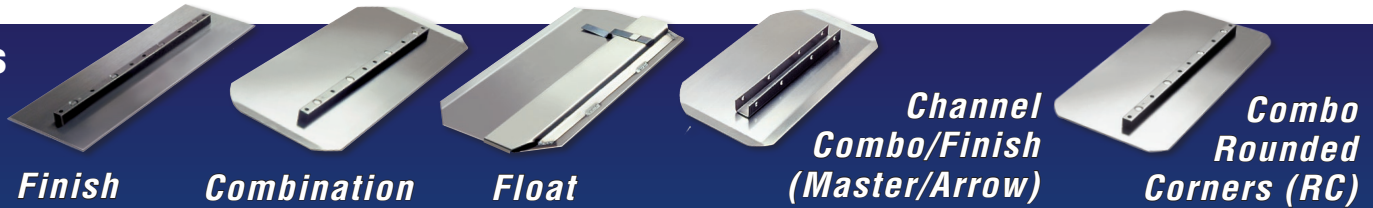

| Machine Size                  | MFG No. | Blade    | Size       | Kraft No.  |       |
|-------------------------------|---------|----------|------------|------------|-------|
| <b>Allen/Razorback</b>        |         |          |            |            |       |
| 30"                           | 41696   | Finish   | 6"x10-1/2" | SK237      |       |
|                               |         | Comb.    | 6"x10-1/2" | SK236      |       |
| 36"                           | 015890  | Finish   | 6"x14"     | SK100      |       |
|                               |         | Comb.    | 8"x14"     | SK101      |       |
|                               |         | 0282314  | Float      | 10"x14"    | SK102 |
| 46"                           | 015695  | Finish   | 6"x18"     | SK214      |       |
|                               |         | Comb.    | 8"x18"     | SK215      |       |
|                               |         | 02822318 | Float      | 10"x18"    | SK105 |
| <b>Bartell</b>                |         |          |            |            |       |
| 24"                           | 20455   | Finish   | 4-3/4"x9"  | SK238      |       |
| 30"                           | 20407   | Finish   | 4-3/4"x10" | SK239      |       |
|                               |         | 10400    | Finish     | 6"x10-1/2" | SK237 |
| 36"                           | 20414   | Finish   | 6"x14"     | SK100      |       |
|                               |         | 20479    | Comb.      | 8"x14"     | SK101 |
|                               |         | 20415    | Float      | 10"x14"    | SK102 |
| 46"                           | 20410   | Finish   | 6"x18"     | SK214      |       |
|                               |         | 20480    | Comb.      | 8"x18"     | SK215 |
|                               |         | 20411    | Float      | 10"x18"    | SK105 |
| <b>Edco (V-Notch Channel)</b> |         |          |            |            |       |
| 34" & 36"                     | F-1     | Finish   | 6"x14"     | SK300      |       |
|                               |         | C-1      | Comb.      | 8"x14"     | SK301 |
|                               |         | M-1      | Float      | 10"x14"    | SK302 |
| 42"                           |         | Finish   | 6"x16"     | SK304      |       |
|                               |         | Comb.    | 8"x16"     | SK305      |       |
|                               |         | Float    | 10"x16"    | SK306      |       |
| 44"-48"                       | F-3     | Finish   | 6"x18"     | SK307      |       |
|                               |         | C-3      | Comb.      | 8"x18"     | SK308 |
|                               |         | M-3      | Float      | 10"x18"    | SK309 |
| <b>Goldblatt</b>              |         |          |            |            |       |
| 28"                           | 19177   | Comb.    | 6"x10"     | SK177      |       |
| 36"                           | 19172   | Finish   | 6"x14"     | SK172      |       |
|                               |         | 19179    | Comb.      | 8"x14"     | SK179 |
|                               |         | 19102    | Float      | 10"x14"    | SK102 |

| Machine Size        | MFG No.   | Blade                | Size          | Kraft No. |       |
|---------------------|-----------|----------------------|---------------|-----------|-------|
| <b>Master/Arrow</b> |           |                      |               |           |       |
| 36"                 | RT36      | Channel Finish       | 6"x14"        | SK232     |       |
|                     |           | RC36                 | Channel Comb. | 8"x14"    | SK233 |
|                     |           |                      | Finish        | 6"x14"    | SK100 |
|                     |           |                      | Comb.         | 8"x14"    | SK101 |
| 46"                 | 3RT46     | Channel Finish       | 6"x18"        | SK234     |       |
|                     |           |                      | Comb.         | 8"x18"    | SK215 |
|                     |           | 3FF46                | Float         | 10"x18"   | SK105 |
|                     |           | 3RC46                | Channel Comb. | 8"x18"    | SK235 |
|                     | RC46      | Offset Channel Comb. | 8"x18"        | SK231     |       |
| <b>MBW</b>          |           |                      |               |           |       |
| 30"                 |           | Comb.                | 8"x10"        | SK242     |       |
| 36"                 | 5347      | Finish               | 6"x14"        | SK100     |       |
|                     |           | 5402                 | Comb.         | 8"x14"    | SK101 |
|                     |           | 5403                 | Float         | 10"x14"   | SK102 |
| 46"                 | 5383      | Finish               | 6"x18"        | SK214     |       |
|                     |           | 5412                 | Comb.         | 8"x18"    | SK215 |
|                     |           | 5413                 | Float         | 10"x18"   | SK105 |
| <b>Stone</b>        |           |                      |               |           |       |
| 36"                 | 34578     | Finish               | 6"x14"        | SK100     |       |
|                     |           | 34583                | Comb.         | 8"x14"    | SK101 |
|                     |           | 34586                | Float         | 10"x14"   | SK102 |
| 46"                 | 34580     | Finish               | 6"x18"        | SK214     |       |
|                     |           | 34585                | Comb.         | 8"x18"    | SK215 |
|                     |           | 34589                | Float         | 10"x18"   | SK105 |
| <b>Stow</b>         |           |                      |               |           |       |
| <b>Old Style</b>    |           |                      |               |           |       |
| 34"                 | 7394-401  | Finish               | 6"x14"        | SK186     |       |
| 36"                 | 11686-503 | Comb.                | 8"x14"        | SK187     |       |
|                     |           | 22027                | Finish        | 6"x14"    | SK100 |
| 42"                 | 22029     | Comb.                | 8"x14"        | SK101     |       |
|                     |           | 22028                | Float         | 10"x14"   | SK102 |
| 46"                 | 10937-501 | Finish               | 6"x14"        | SK186     |       |
|                     |           | 21637                | Finish        | 6"x18"    | SK214 |
| 46"                 | 21988     | Comb.                | 8"x18"        | SK215     |       |
|                     |           | 21989                | Float         | 10"x18"   | SK105 |

## Retro Adapter Bar

Mount adapter bar to power troweler and quickly change blades with snap pins. Bar fits 7/8" channel. Each bar comes with two snap clips for mounting.

| No.                                  | Size              | Fits    |
|--------------------------------------|-------------------|---------|
| SK148                                | 10" Long          | 36"     |
| <i>(Only fits SK232 &amp; SK233)</i> |                   |         |
| SK150                                | 14" Long          | 46"/48" |
| <i>(Only fits SK234 &amp; SK235)</i> |                   |         |
| SK147                                | Snap Clip for Bar |         |



## ProForm® UHMW Poly Blades

### Non-Marring Surface

Popular choice for polished and decorative application. **For walk-behind machines only. Not for use on Float Pans.**



|  |                  |       |        |        |
|--|------------------|-------|--------|--------|
|  | Fits most models | Comb. | 8"x14" | SK101P |
|  | Fits most models | Comb. | 8"x18" | SK215P |

Designed with a hard thick steel to cut down on blade changes on the job

Each blade is designed for longer life and greater performance

Long life blades are ideal for the tough demands of riding power trowelers



| Machine Size  | MFG No.        | Blade              | Size            | Kraft No.      |                  |
|---|----------------|--------------------|-----------------|----------------|------------------|
| <b>Superior / Husqvarna</b>   |                |                    |                 |                |                  |
| 36"   | 2836FL         | Comb.              | 8"x14"          | SK220          |                  |
| 44"   | 2844C          | Comb.              | 8"x16"          | SK226          |                  |
|   |                | Float              | 10-1/2"x17-1/2" | SK108          |                  |
|   |                | Float, Raised Clip | 10-1/2"x17-1/2" | SK109          |                  |
| 48"   | 2844FL         | Flat Finish RC     | 8"x16"          | SK227          |                  |
|   |                | 2848FL             | Comb.           | 8"x18"         | SK228            |
| <b>Wacker</b>   |                |                    |                 |                |                  |
| 36"   | 79638          | Finish             | 6"x14"          | SK100          |                  |
|   |                | Comb.              | 8"x14"          | SK101          |                  |
|   |                | 75061              | Float           | 10"x14"        | SK102            |
| 48"   | 79642          | Finish             | 6"x18"          | SK214          |                  |
|   |                | Comb.              | 8"x18"          | SK215          |                  |
|   |                | 112000             | Float           | 10"x18"        | SK105            |
|   |                |                    | <b>Wagman</b>   |                |                  |
| 24"   | WB47590        | Finish             | 4-3/4"x9"       | SK238          |                  |
|   | WB6105F        | Finish             | 6"x10-1/2"      | SK237          |                  |
| 30"   | WX5925M6       | Comb. Metric       | 5"x9"           | SK241          |                  |
| 36"   | WX614F         | Finish             | 6"x14"          | SK100          |                  |
|   |                | Comb.              | 8"x14"          | SK101          |                  |
|   |                | WX1014FO           | Float           | 10"x14"        | SK102            |
|   |                |                    | <b>44"</b>      |                |                  |
| WF816F  | Flat Finish RC | 8"x16"             | SK227           |                |                  |
| 46-48"  | WX618F         | Finish             | 6"x18"          | SK214          |                  |
|   |                | Comb.              | 8"x18"          | SK215          |                  |
|   |                | WX1018FO           | Float           | 10"x18"        | SK105            |
|   |                |                    | WX-818F         | Flat Finish RC | 8"x18"           |
| 60"   | WX-623F        | GOLD Finish        | 6"x23"          | SK216G         |                  |
|   | WX8230         | GOLD Comb.         | 8"x23"          | SK218G         |                  |
| <b>Whiteman / MultiQuip</b>   |                |                    |                 |                |                  |
| 24"   | C244           | Comb. Metric       | 5"x9"           | SK241          |                  |
| 36"   | F-90           | Finish             | 6"x14"          | SK100          |                  |
|   |                | Comb.              | 8"x14"          | SK101          |                  |
|   |                | CL-954F            | Float           | 10"x14"        | SK102            |
| 46-48"  | F-400          | Finish             | 6"x18"          | SK214          |                  |
|   |                | Comb.              | 8"x18"          | SK215          |                  |
|   |                | CL444F             | Float           | 10"x18"        | SK105            |
|   |                |                    | RC818           | Flat Finish RC | 8"x18"           |
|   |                | C 8160             | Finish          | 6"x16"         | <b>NEW</b> SK221 |
|   |                |                    | Comb.           | 8"x16"         | <b>NEW</b> SK222 |
| <b>Rounded Corner Combination Blades</b>                                  |                |                    |                 |                |                  |
| Flat combination blade with 2" radius corners. Offers more blade surface. |                |                    |                 |                |                  |
| Fits most popular models  | Comb. RC       | GOLD Comb. RC      | 8"x14"          | SK101R         |                  |
|   |                |                    | 8"x18"          | SK215GR        |                  |
|   |                |                    | 8"x18"          | SK215R         |                  |
| Fits Superior   | Comb. RC       | Comb. RC           | 8"x14"          | SK220R         |                  |
|   |                |                    | 8"x16"          | SK226R         |                  |
|   |                |                    | 8"x18"          | SK228R         |                  |

**ProForm® Ultra Blue**  
15-25% Longer Life

| Machine Size   | Blade     | Size   | Part No. | Mfg. Compatibility   |
|----------------|-----------|--------|----------|--|
| 36"            | Finish    | 6"x14" | SK100B   | Fits Allen, Bartell, Stone, Stow, Whiteman, Wacker & other popular styles of Trowelers |
|                | Comb.     | 8"x14" | SK101B   |  |
| 46"-48"        | Finish    | 6"x18" | SK214B   |  |
|                | Comb.     | 8"x18" | SK215B   |  |
|                | Finish RC | 8"x18" | SK217B   |  |
|                | Comb.     | 8"x16" | SK226B   |  |
| Offset Channel | Finish RC | 8"x16" | SK227B   | Fits Superior Trowelers  |
|                | Comb.     | 8"x18" | SK228B   |  |
| Offset Channel | Comb.     | 8"x18" | SK231B   | Fits Master Trowelers  |

**ProForm® Heavy-Duty Gold**  
Thick and Rugged  
25-50% Longer Life

| Machine Size              | Blade     | Size   | Part No. | Mfg. Compatibility   |
|---------------------------|-----------|--------|----------|--|
| 36"                       | Finish    | 6"x14" | SK100G   | Fits Allen, Bartell, Stone, Stow, Whiteman, Wacker & other popular styles of Trowelers |
|                           | Comb.     | 8"x14" | SK101G   |  |
|                           | Comb. RC  | 8"x14" | SK107G   |  |
| 46"-48"                   | Finish    | 6"x18" | SK214G   |  |
|                           | Comb.     | 8"x18" | SK215G   |  |
|                           | Finish RC | 8"x18" | SK217G   |  |
|                           | Comb.     | 8"x16" | SK226G   |  |
| 60"                       | Comb.     | 8"x18" | SK228G   | Fits Superior Trowelers  |
|                           | Comb.     | 8"x18" | SK231G   | Fits Master Trowelers  |
| Offset Channel            | Finish    | 6"x23" | SK216G   | Fits Allen, Wagman, Whiteman/Multi Quip Trowelers                                      |
|                           | Comb.     | 8"x23" | SK218G   |  |
| <b>Bent Blade Corners</b> |           |        |          |  |
| 36"                       | Finish    | 6"x14" | SK100GBE |  |
| 46"-48"                   | Finish    | 6"x18" | SK214GBE |  |

**Grinding Stone Holder (Only)**

Please specify troweler and make.  
SK312 (Up to 36" Machine Size)  
SK318 (Over 36" Machine Size)

**Grinding Stone Holder (With Stone)**

SK313 (Up to 36" Machine Size)  
SK319 (Over 36" Machine Size)

**Grinding Stone (Only)**

SK320 (6 Grit, 2"x2"x8")



# PROFORM® FLOAT PANS

Achieve flatter floors with less time on the job!  
Made to fit non-overlapping, "Walk Behind"  
and "Ride-On" power trowelers  
Pan fits right over power troweler blades

**STORAGE:**  
Always store pans securely  
and vertically. Pans can  
be bent or damaged if not  
stored properly.

## The best way to achieve flatter floors

- Made to fit non-overlapping "Walk-Behind" or "Ride-On" power trowelers
- Rotate pans for optimal life
- Beveled slightly to keep pan from digging into concrete
- Finish area is slightly smaller than the float pan due to beveling
- Blade slots on the float pan fit to blades on troweler
- Blade slots can be used on trowelers that run either direction

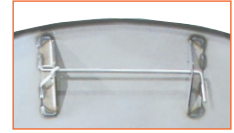

Slide rod in for secure attachment

Add "F" after part number for flat Z-Clip or Safety Rod Style float pans

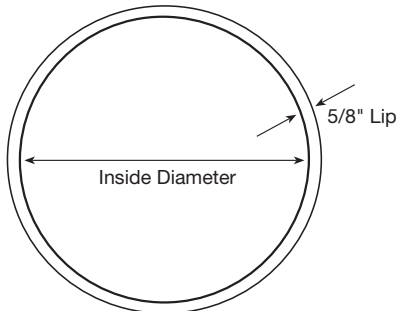
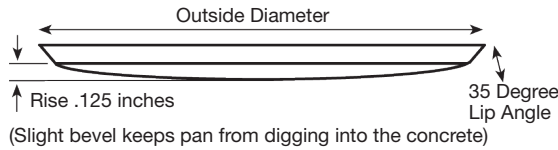

## Safety Rod Style

Please specify troweler make and size

| No.                | Pan Diameter (12-Gauge Pan)    | Steel   |
|--------------------|--------------------------------|---------|
| SK400SR            | 35-3/4" (34-3/4" Inside Diam.) | 4 Blade |
| SK401SR            | 36-1/2" (35-1/2" Inside Diam.) | 4 Blade |
| SK402SR            | 38-1/4" (37-1/4" Inside Diam.) | 4 Blade |
| SK403SR            | 45-3/4" (44-3/4" Inside Diam.) | 4 Blade |
| + SK407SR          | 45-3/4" (44-3/4" Inside Diam.) | 5 Blade |
| <b>NEW</b> SK414SR | 45-3/4" (44-3/4" Inside Diam.) | 6 Blade |
| SK404SR            | 47-3/4" (46-3/4" Inside Diam.) | 4 Blade |

| Heavy-Duty | Pan Diameter (10 Gauge Pan)    | Steel   |
|------------|--------------------------------|---------|
| SK410SR    | 45-3/4" (44-3/4" Inside Diam.) | 4 Blade |
| SK411SR    | 45-3/4" (44-3/4" Inside Diam.) | 5 Blade |
| SK406SR    | 47-3/4" (46-3/4" Inside Diam.) | 4 Blade |
| SK409SR    | 47-3/4" (46-3/4" Inside Diam.) | 5 Blade |

| Heavy-Duty | Pan Diameter (10 Gauge Pan)             | Steel   |
|------------|---|---------|
| SK408SR**  | 60" (58-1/4" Inside Diam.)<br>(90° lip) | 6 Blade |

+ Fits Whiteman B-Series and BAN Series "Ride-On" trowelers

\*\*Must ship via truck

Add "F" after part number for flat Z-Clip or Safety Rod Style float pans

## Z-Clip Style

Please specify troweler make and size

| No.              | Pan Diameter (12-Gauge Pan)    | Steel   |
|------------------|--------------------------------|---------|
| SK400            | 35-3/4" (34-3/4" Inside Diam.) | 4 Blade |
| SK401            | 36-1/2" (35-1/2" Inside Diam.) | 4 Blade |
| SK402            | 38-1/4" (37-1/4" Inside Diam.) | 4 Blade |
| SK403            | 45-3/4" (44-3/4" Inside Diam.) | 4 Blade |
| + SK407          | 45-3/4" (44-3/4" Inside Diam.) | 5 Blade |
| <b>NEW</b> SK414 | 45-3/4" (44-3/4" Inside Diam.) | 6 Blade |
| SK404            | 47-3/4" (46-3/4" Inside Diam.) | 4 Blade |

| Heavy-Duty | Pan Diameter (10 Gauge Pan)    | Steel   |
|------------|--------------------------------|---------|
| SK410      | 45-3/4" (44-3/4" Inside Diam.) | 4 Blade |
| SK411      | 45-3/4" (44-3/4" Inside Diam.) | 5 Blade |
| SK406      | 47-3/4" (46-3/4" Inside Diam.) | 4 Blade |
| SK409      | 47-3/4" (46-3/4" Inside Diam.) | 5 Blade |

+ Fits Whiteman B-Series and BAN Series "Ride-On" trowelers

## Edger Pan #14 Gauge Steel

Edger pans with 90° lip allow machine troweling and floating close to walls and obstructions.

| No.   | Pan Diameter  | Mfg. Compatibility                                  |
|-------|---------------|---|
| SK420 | 24" (90° lip) | Allen, Bartell, MBW, Wacker, and Whiteman/MultiQuip |
| SK421 | 30" (90° lip) | Allen, Wacker, and Whiteman/MultiQuip               |

## Flat Wire Texture Broom

A popular tool to create non-skid surfaces on highways, bridges, airport runways, ramps, driveways, and cattle pens. The broom produces a uniform rough groove surface on roads and bridges for maximum traction. The exposed flat wires are 5" long and 1/8" wide and spaced 1/2", 5/8", 3/4", or 1" apart. The .028" thick long-lasting tempered blue spring steel tines are replaceable for extending the life of the tool. This material provides a slight "give" as it creates traction. Check State and Federal Department of Transportation (DOT) specifications in relation to the tine spacing and length for your area. Measuring you choice of 36", 48", or 60" across, the tool provides a wide reach on projects both large and small. The lightweight aluminum base with attached bracket accepts all clevis handles (page 58) or adapters. Adapters must be used to attach threaded or button bull float handles (pages 22-24).

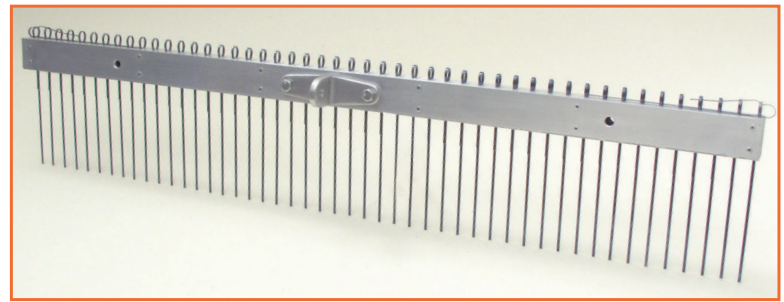

**When Ordering Please Specify:** 1/2", 5/8", 3/4" or 1" spacing on center (3/4" is the most popular size).

| No.       | Size     | Spacing           |
|-----------|----------|-------------------|
| CC196-1/2 | 36"      | 1/2"              |
| CC196-5/8 | 36"      | 5/8"              |
| CC196-3/4 | 36"      | 3/4"              |
| CC196-1   | 36"      | 1"                |
| CC198-1/2 | 48"      | 1/2"              |
| CC198-5/8 | 48"      | 5/8"              |
| CC198-3/4 | 48"      | 3/4"              |
| CC198-1   | 48"      | 1"                |
| CC199-1/2 | 60"      | 1/2"              |
| CC199-5/8 | 60"      | 5/8"              |
| CC199-3/4 | 60"      | 3/4"              |
| CC199-1   | 60"      | 1"                |
| CC200-10  | 10 Pack  | Replacement Tines |
| CC200-100 | 100 Pack | Replacement Tines |

**SPECIAL ORDERING  
AVAILABLE:**

**Special length and spacing  
needed?**

**CALL TODAY!**

Special lengths are also available for  
large paving machines.

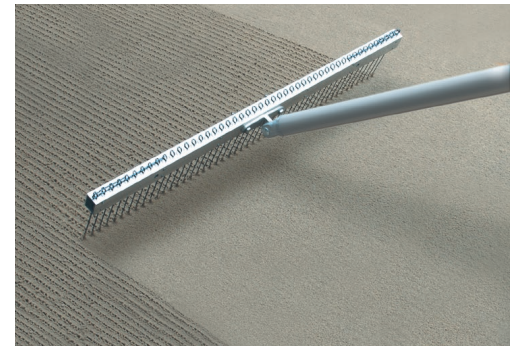

**Kraft also offers wire texture brooms  
that vary according to State or  
Federal specifications in relation to  
tine spacing and length.**

## Float and Broom Combo

**Float and broom in one pass  
Helps eliminate reaching and lifting  
Perfect tool for wide slabs**

Great tool to finish wide slabs without reaching or lifting. Adjustable broom adapter bar allows user to determine the working angle of the broom. For best results, broom should extend past end of float. Use with bull float handles and adapters (see pages 22-24).

**PARTS MUST BE ORDERED SEPARATELY.**

| No.         | Description   |
|-------------|---|
| A) CC802-01 | 48"x8" Heavy-Duty Magnesium Bull Float  |
| B) CC294    | EZY-Tilt® II 6-Hole Bracket<br>(use 1-3/8" or 1-3/4" Snap Button Bull Float Handle)   |
| C) CC181    | Combo Broom Adapter Bar with Brackets<br>(Fits Bull Floats, Big "D" Floats and Fresnos with<br>tilting brackets or adapters to use with texture brooms) |
| D) CC191    | Replacement Bracket for Adapter Bar (2 required)  |
| E) CC182    | 54" Weigh-Lite® Broom with two brackets (CC191)<br>for adapter bar  |
| F) CC190    | 54" Replacement Broom Strip for (CC182)<br>Medium Bristles  |

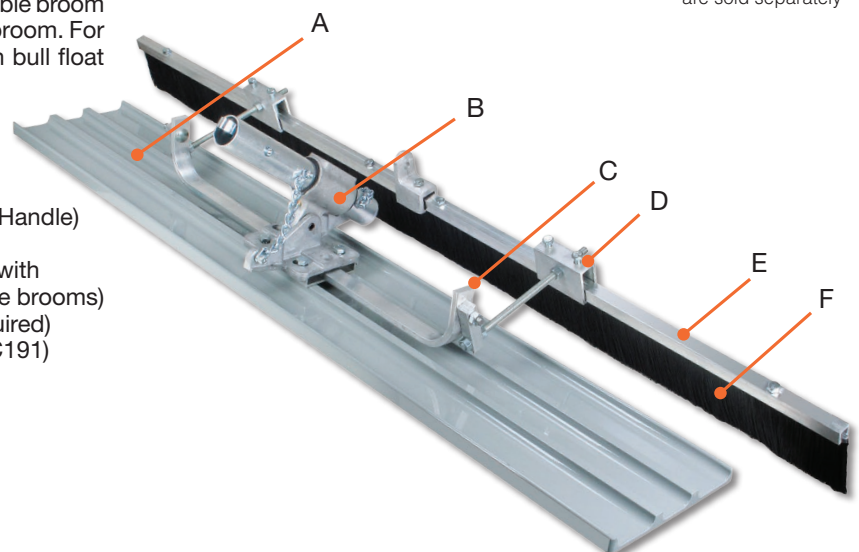

All parts for the  
Float Broom Combo  
are sold separately

## Works with other tools, too!

- Other Brooms (pg. 45)
- Flat Wire Texture Broom (pg. 43)
- Bull Floats (pg. 27-29)
- Big "D" Steel Fresno (pg. 27)
- Fresnos with 2 Hole Bracket (pg. 32-33)

### Concrete Floor Broom

All-purpose floor broom for concrete and wood floors. 3" black tampico fiber on wooden block, 60" threaded wood handle (CC163). Accepts broom threaded extension handles.

| No.   | Size |
|-------|------|
| CC183 | 18"  |
| CC184 | 24"  |
| CC186 | 36"  |

Add "01" after part no. for broom without handle



### All-Purpose Horsehair Floor & Finish Broom

All-purpose floor broom for concrete and wood floors. 2-7/8" pure 100% black horsehair on wood block with 60" threaded wood handle (CC163). Accepts broom threaded extension handles.

| No.   | Size |
|-------|------|
| CC187 | 24"  |
| CC192 | 36"  |

Add "01" after part no. for broom without handle



### Curb Brush

Curb brush for hand brushing newly laid finished concrete surfaces. 3-1/8" long soft plastic fiber bristles secured in 12" wood block. Perfect for small finishing jobs. No. CC169



### Hand Concrete Finish Brush

Curb brush with built in 4" handle for finishing newly laid concrete. 12" long, with 3" soft poly horsehair blend bristles. Great for finishing small areas. No. CC269



### Broom Cover/Protector

Designed to fit aluminum finish brooms up to 48". Open ends allow broom to dry and keep original shape. Velcro closures secure broom in place.

| No.   | Size |
|-------|------|
| CC258 | 48"  |

Broom sold separately

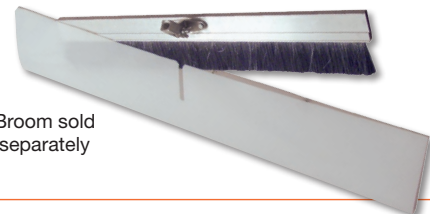

### Horsehair Hand Finish Brush

Thick 2-1/2" poly horsehair blend bristles provide a soft finish that keeps its shape with use. Use for finishing or cleaning. Smooth wood handle provides ample knuckle clearance during use.

| No.   | Size |
|-------|------|
| CC267 | 12"  |



### Pool Finish Brush

2-1/2" soft Nylex® bristles for finishing concrete and specialty materials, and for exposing aggregate in pool finishes.

| No.   | Size |
|-------|------|
| CC268 | 12"  |



### Nylex® Truck Brush

2-1/4" soft Nylex® bristles for finishing concrete and exposing aggregate in decorative finishes. White bumper protects walls and edges. Use with threaded broom handles (sold separately).

| No.   | Size |
|-------|------|
| BL437 | 10"  |



### Green Nylex® Soft Finish Broom

Soft concrete finish broom with memory resistant soft green flagged Nylex® bristles leaves a finish similar to horsehair. Easy clean up. Comes with 5' broom threaded wood handle (CC163).

| No.   | Size | Bristles |
|-------|------|----------|
| CC454 | 24"  | 2-3/8"   |
| CC456 | 36"  | 2-1/4"   |
| CC459 | 48"  | 2-1/4"   |

Add "01" after part no. for broom without handle



### All-Angle Broom Adapter

Cut out section of adapter fits over broom bracket. Adjustable angle. Accepts broom thread handle.

| No.   | Size  |
|-------|---|
| CC493 | Broom Adapter (Hardware included)                 |
| CC494 | Broom Bracket Base (Hardware <u>not</u> included) |

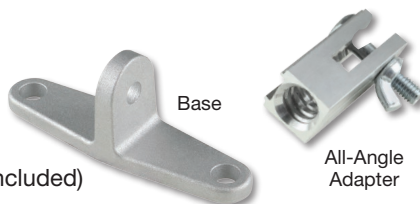

### Extension Handle Broom Adapter

Attach paint rollers, brooms, etc., to molded thread extension handles.

No. CC297







### Concrete Finishing Broom (Aluminum)

Brush down new concrete after floating with these lightweight aluminum brooms. *Three* bristles styles to choose from: medium/general purpose black poly (shown), extra soft white poly, or natural horsehair and poly blend. All bristles are epoxy set for long wear and durability. Use with threaded or button handle adapters.

| No.   | Size | Bristle Material                            |
|-------|------|---|
| CC175 | 24"  | Medium/General Purpose (Black Poly)         |
| CC177 | 36"  | Medium/General Purpose (Black Poly)         |
| CC178 | 48"  | Medium/General Purpose (Black Poly)         |
| CC189 | 60"  | Medium/General Purpose (Black Poly)         |
| CC203 | 72"  | Medium/General Purpose (Black Poly)         |
| CC179 | 36"  | Extra Soft (White Poly)                     |
| CC206 | 24"  | Natural Horsehair and Poly Blend <b>NEW</b> |
| CC180 | 36"  | Natural Horsehair and Poly Blend            |
| CC176 | 48"  | Natural Horsehair and Poly Blend            |



### Weigh-Lite® Concrete Finishing Broom

Made for brushing down newly laid concrete surface. No waiting for surface to dry. Soft, poly fibers on solid stock brush. Clevis bracket included. Use with clevis handle or threaded or button handle adapters (sold separately, see page 22-24).

#### 3-1/4" Trim, Soft Black Poly

| No.   | Size | Replacement Bristle Strip |
|-------|------|---------------------------|
| CC154 | 24"  | CC155 24"                 |
| CC156 | 36"  | CC157 36"                 |
| CC158 | 48"  | CC159 48"                 |

#### 5" Trim, .022 Bristle, Medium Coarse White Poly (not shown)

| No.   | Size | Replacement Bristle Strip |
|-------|------|---------------------------|
| CC247 | 36"  | CC247-01 36"              |
| CC248 | 48"  | CC249 48"                 |
| CC250 | 54"  | CC251 54"                 |

#### 5" Trim, .030 Bristle, Coarse Black Poly (not shown)

| No.   | Size | Replacement Bristle Strip |
|-------|------|---------------------------|
| CC246 | 36"  | CC246-01 36"              |



Replacement Bracket Only  
No. CC160



### Soft Nylon Concrete Finishing Broom

Lightweight broom with two rows of extra soft 4" nylon bristles. Made for a fine finish on newly laid concrete. Use with clevis handle, or use threaded or button handles with adapters.

| No.   | Size |
|-------|------|
| CC457 | 36"  |
| CC458 | 48"  |

# CONCRETE FINISH BROOMS



### Concrete Finishing Broom

Soft plastic bristles designed to give a fine finish on newly poured concrete. Long-wearing bristles are set solidly in wood. All brooms come with 5' broom threaded wood handle (CC163).

#### Plastic Bristles

| No.   | Size | Bristles | No.   | Size | Bristles |
|-------|------|----------|-------|------|----------|
| CC164 | 18"  | 2-3/8"   | CC166 | 36"  | 3-1/4"   |
| CC165 | 24"  | 2-3/8"   | CC188 | 48"  | 3-1/4"   |

#### Horsehair Bristles (for a softer finish)

|       |     |        |       |     |        |
|-------|-----|--------|-------|-----|--------|
| CC193 | 24" | 2-1/2" | CC194 | 36" | 2-1/2" |
|-------|-----|--------|-------|-----|--------|

CC163 5' Metal Threaded Replacement Wood Handle

Add "01" after part no. for broom without handle



### Concrete Finishing Broom (Wood)

Brush down new concrete after floating, with these poly fiber brooms. Medium-general purpose black poly bristles. All bristles are epoxy set for long wear and durability. All brooms are made from solid hardwood lacquered blocks for just the right feel and finish. Use with threaded or snap handle adapters (sold separately, pages 22-24).

#### No. Size Bristle Material

|       |     |                                     |             |
|-------|-----|-------------------------------------|-------------|
| CC170 | 24" | Medium-General Purpose (Black Poly) | Soft Finish |
| CC172 | 36" | Medium-General Purpose (Black Poly) |             |
| CC173 | 48" | Medium-General Purpose (Black Poly) |             |

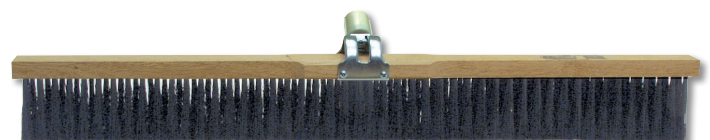

### "The Performer" Concrete Finishing Broom

Concrete finishing broom has three rows of 3" black nylon bristles. Fits any standard threaded handle. Adapter included. Accepts standard broom threaded handles, sold separately.

| No.   | Size | No.   | Size                       |
|-------|------|-------|----------------------------|
| CC254 | 24"  | CC256 | 36"                        |
| CC255 | 30"  | CC259 | Replacement Handle Adapter |



### Telescoping Extension Handle

Anodized aluminum telescoping extension handle. 1-3/8" button style attachment. Use with brackets and adapters to fit 1-3/8" diameter. Ideal for extra long reach with lighter tools such as brooms. Twist-lock holds handle at the desired length.

Packed 6 per carton

|            |                            |
|------------|----------------------------|
| <b>No.</b> | <b>Size</b>                |
| CC430      | 8'-16' Telescoping Handle  |
| CC436      | 12'-24' Telescoping Handle |
| CC430-01   | Replacement Lock Assembly  |

### 3-Piece Aluminum Handle

3-piece snap-style 5' anodized aluminum handle with broom thread tip.

**No.** CC263



### Broom Handles

#### Telescoping

#### Fiberglass® Handles

These handles fit all brooms that take a broom thread. Swivel twist lock loosens and tightens handles when extended to desired length.

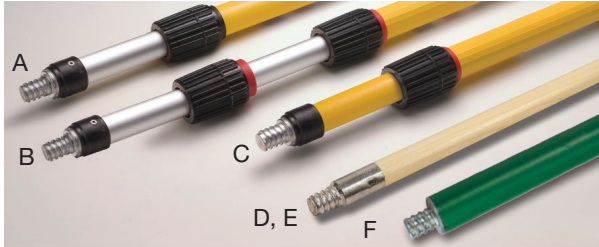

|            |  |
|------------|--|
| <b>No.</b> | <b>Size</b>                                      |
| A) CC446   | Fiberglass® with Aluminum Extensions 6'3" to 12' |
| B) CC429   | Fiberglass® with Aluminum Extensions 6'6" to 18' |
| C) CC448   | All Fiberglass® 6'3" to 12'                      |

#### Wood Handle

|            |                                   |
|------------|-----------------------------------|
| <b>No.</b> | <b>Size</b>                       |
| D) CC163   | 5' Metal Thread Wood Broom Handle |
| E) CC163L  | 6' Metal Thread Wood Broom Handle |

#### Steel Handle

60" heavy-duty coated steel handle with broom threaded tip.

F) **No.** GG232

### Flipper Tilt Bracket™

Pre-set your broom to automatically tilt at desired angle to finish during both extension and retrieval. Adjustable stops limit broom to pivot to a pre-set angle or maintain a fixed handle position. Allows for a full 105° range of motion. Use with thread or button handle adapters. Attach bracket to CC494 broom bracket base (included with most Kraft finishing brooms).

**No.** CC496

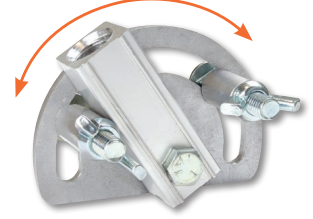

Flip to push...

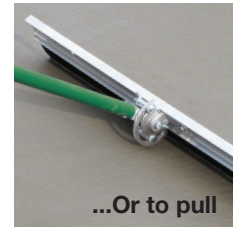

...Or to pull

### Rub Bricks

#### A) Fluted with Handle

Fluted silicon carbide rub bricks make dressing down concrete fast and easy. The fluted bricks are on a diagonal which provides sharp edges to help with stubborn materials while carrying away excess debris. Contoured plastic handle minimizes fatigue. Preferred by finishers for its ease of use.

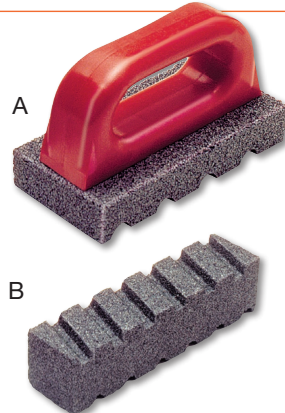

|            |                  |             |
|------------|------------------|-------------|
| <b>No.</b> | <b>Size</b>      | <b>Grit</b> |
| CF268      | 8"x3-1/2"x1-1/2" | 20          |
| CF283      | 6"x3"x1"         | 20          |
| CF282      | 6"x3"x1"         | 60          |

#### B) Fluted Less Handle

Made of silicon carbide, fluted on two sides.

|            |             |             |
|------------|-------------|-------------|
| <b>No.</b> | <b>Size</b> | <b>Grit</b> |
| CF462      | 6"x2"x2"    | 20          |
| CF482      | 8"x2"x2"    | 20          |

Replacement Handle for all Rub Bricks - CF283-01

### Round Rub Brick

Lightweight round rub brick with handle. Makes grinding easy. Use one in each hand in a circular motion. Stone is 1" thick and 6" in diameter.

|            |             |             |
|------------|-------------|-------------|
| <b>No.</b> | <b>Size</b> | <b>Grit</b> |
| CF270      | 6"x1"       | 20          |



### Broken-In Rub Brick

Already broken-in and ready for smoothing and dressing down concrete. A good value for the price.

|            |                |             |
|------------|----------------|-------------|
| <b>No.</b> | <b>Size</b>    | <b>Grit</b> |
| CF281      | 8"x3-1/2"x3/4" | 20          |



### Rub Brick Mop

Fluted Rub Brick Mop used for concrete smoothing, dressing down and removing form marks. Aluminum bracket with 5' wood clevis handle (CC386).

|            |                               |             |
|------------|-------------------------------|-------------|
| <b>No.</b> | <b>Size</b>                   | <b>Grit</b> |
| CC497      | 8"x7"                         | 20          |
| CC497-01   | 8"x7" without Handle          | 20          |
| CF268-01   | Replacement Rub Brick (2 req) | 20          |

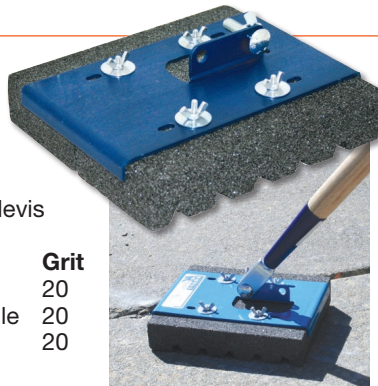

### White Rub Brick Mop

Non-marring surface is ideal for decorative applications to insure a clean finish. Two fluted rub bricks are secured to a strong aluminum bracket. Includes a 5' clevis handle (CC386).

|            |                               |             |
|------------|-------------------------------|-------------|
| <b>No.</b> | <b>Size</b>                   | <b>Grit</b> |
| CC489      | 8"x7"                         | 60          |
| CC489-01   | 8"x7" without Handle          | 60          |
| ST280-01   | Replacement Rub Brick (2 req) | 60          |



**CAUTION:** Metal extension handles/adapters should not be used near electrical wiring.

Proudly Made In The USA

# GUNITE TOOLS

## Heavy-Duty Gunite Step Trowel

Strongest trowel around. Long-wearing thicker blade adds rigidity to this extra heavy-duty trowel. ProForm® handle is centered on a 1/2" square steel bar which provides the strength needed to work with gunite material.

18" Trowel is ideal for pool steps

| No.     | ProForm® Size |
|---------|---------------|
| CF204PF | 14"x4"        |
| CF206PF | 18"x4"        |



## Gunite Trowel

Same craftsmanship as all regular Kraft concrete trowels. Rivets have not been ground off, making the trowel stronger for use on gunite.

| Camel Back Wood |        | ProForm® |        |
|-----------------|--------|----------|--------|
| No.             | Size   | No.      | Size   |
| CF208C          | 12"x4" | CF208PF  | 12"x4" |
| CF209C          | 14"x4" | CF209PF  | 14"x4" |



## Radius Bender

Radius bender is used for rounding and finishing corners of pools and other shotcrete or gunite corners that need freehand finishing. Blue steel blade measures 24"x2-1/2".  
No. CC980

## Curved Shotcrete Fresno

This fresno is specially curved for shotcrete work. The rivets are left unground for extra strength. High quality round end carbon blade with steel mounting. Single action bracket.

| No.   | Size   |
|-------|--------|
| CC914 | 24"x5" |
| CC915 | 30"x5" |



## Gunite Fresnos

This fresno is extra tough for working in rough gunite and shotcrete material. A high quality carbon blade with steel mounting. Rivets are left unground for additional strength. Single action bracket can be used with clevis handles (page 58) or adapters (page 24). The 24" round end fresno is also available with batter to prevent gouging material.

### A) With Single Action Bracket

| No.   | Size   | Description           |
|-------|--------|-----------------------|
| CC651 | 24"x5" | Round End             |
| CC652 | 30"x5" | Round End             |
| CC963 | 24"x5" | Round End with Batter |

### B) With Swivel Bracket **NEW**

| No.   | Size   | Description           |
|-------|--------|-----------------------|
| CC647 | 24"x5" | Round End with Batter |

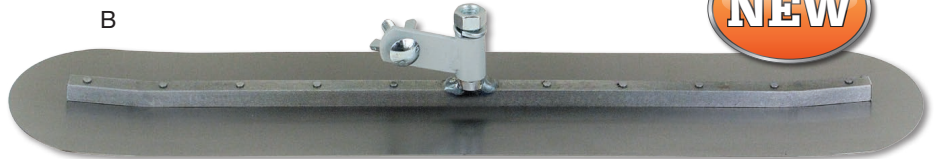
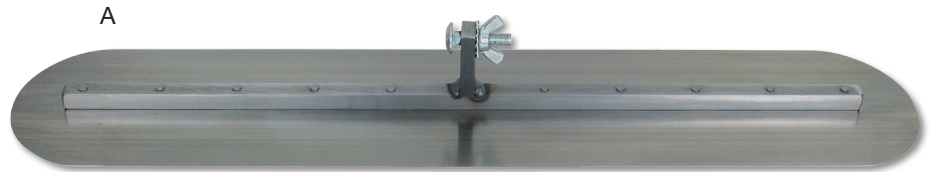

## Heavy-Duty Gunite Shoes With Spikes

Adjustable lightweight aluminum shoes. Fitted with (12) 1" steel spikes. Adjustable sole plate and heel support. Two adjustable nylon straps securely hold gunite shoe to work boot. One size fits most.  
No. CC970 (Pair)



## Flexible Gunite Shoes

Gray flexible plastic lets you work with natural ease of movements. Protect your work and bring air bubbles out of the application. (13) firmly attached 3/4" (overall length) steel spikes cover the bottom of the shoe. Two adjustable nylon straps securely hold gunite shoe to work boot. One size fits most.

| No.       | Description                  |
|-----------|------------------------------|
| HC177*    | Flexible Gunite Shoes (pair) |
| HC177-01* | 3/4" Replacement Spikes (26) |
| HC178-02* | Replacement Straps (set)     |



## Gunite Spiked Shoes

Used for Epoxy and Gunite installation. One size fits all. Fitted with (13) 1-1/2" (overall length) steel spikes. Two adjustable nylon straps with plastic clasps to securely hold gunite shoe to work boot.

| No.       | Description               |
|-----------|---------------------------|
| HC178*    | Gunite Shoes (pair)       |
| HC178-01* | 1-1/2" Replacement Spikes |
| HC178-02* | Replacement Straps        |



\*See page 178

ProForm® Trowel Handle (US Patent #6,247,204 B1)

## Concrete Step-Saver® Tools

*Cut perfect control joints and corners before removing the forms*

- Easy to use, saves time and increases the quality of your work
- Must-have tools for every concrete finisher
- Ductile iron and 6" wood handle

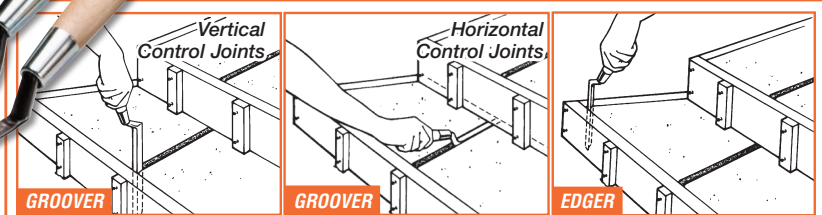
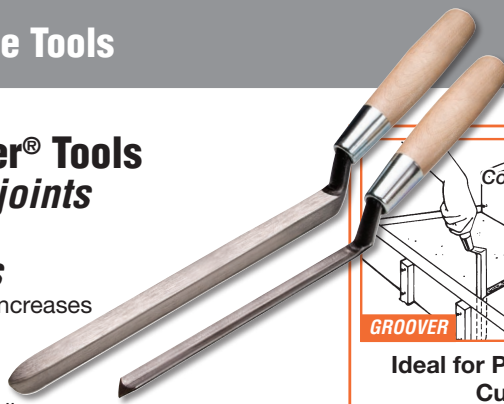

**Ideal for Parking Curbs, Step Faces, Step Corners, Control Joints, Curb & Gutter, Stadium Risers, Exposed Aggregate**

### Step-Saver® Groovers

- Used to groove vertical and horizontal control joints into the face of slabs, curbs and steps
- Simply work the groover between the form and concrete for a perfect joint every time

| No.   | Size                 |
|-------|----------------------|
| CF007 | 12"L x 3/8"W x 3/4"D |
| CF008 | 12"L x 1/2"W x 1"D   |
| CF009 | 12"L x 7/8"W x 3/4"D |
| CF010 | 6"L x 1/2"W x 1"D    |

U.S. Patent #D-333,600

### Step-Saver® Edgers

- Makes finishing step corners a breeze
- Insert and work between forms and concrete at step corners
- Once risers are stripped perfect rounded corners remain

| No.   | Size         |
|-------|--------------|
| CF001 | 10"L x 3/8"R |
| CF002 | 10"L x 1/2"R |
| CF003 | 10"L x 3/4"R |

U.S. Patent #5,098,278

## All-Steel Hand Groovers

Comfortable soft grip handle

| No.   | Size  | Radius | Depth |
|-------|-------|--------|-------|
| CF483 | 6"x6" | 1/2"   | 1"    |
| CF484 | 6"x6" | 3/4"   | 1"    |



- Available in hand and walking styles
- Extra weight of tools creates sharp clean grooves
- Easy-to-see red target sites on walking groovers for straight lines



### All-Steel Walking Angle Groovers

Cuts groove diagonally away from corners and enclosed areas. Use with fresno adapters (page 27) and extension handles (page 20).

| No.   | Size   | Radius | Depth |
|-------|--------|--------|-------|
| CC704 | 8"x10" | 3/4"   | 1"    |
| CC705 | 8"x10" | 1/2"   | 1"    |
| CC706 | 8"x10" | 3/4"   | 7/8"  |

## Handle Adapter Plates

Handle adapters for all-steel groovers and hand tools. Three styles: swivel action, 2-hole single action, or 4-hole single action.

| No.   | Description                        |
|-------|------------------------------------|
| CC653 | 4-Hole Single Action Plate Adapter |
| CC659 | 2-Hole Single Action Adapter       |
| CC660 | 2-Hole Swivel Action Adapter       |

4-Hole Single Action

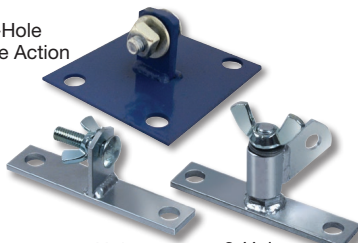

2-Hole Single Action      2-Hole Swivel Action

## All-Steel Walking Groovers

### A) For Bull Float Brackets

2 studs fit Handle Adapter Plates or Bull Float Brackets (pages 25-26), sold separately.

| No.    | Size    | Radius | Depth |
|--------|---------|--------|-------|
| CC700  | 12"x14" | 1/2"   | 1"    |
| CC701  | 12"x14" | 3/4"   | 1"    |
| CC702A | 8"x10"  | 1/2"   | 1"    |
| CC703A | 8"x10"  | 3/4"   | 1"    |

### B) For Fresno Adapters

Prong style mounting to use with Clevis Handles or with Adapters for use with Bull Float Handles (pages 22-24), sold separately.

| No.   | Size   | Radius | Depth |
|-------|--------|--------|-------|
| CC702 | 8"x10" | 1/2"   | 1"    |
| CC703 | 8"x10" | 3/4"   | 1"    |

### C) With Mounting Bar

#### For Bull Float Brackets **NEW**

Mounting Bar reinforces the top. 2 studs fit Bull Float Brackets (page 25-26), sold separately.

| No.    | Size    | Radius | Depth |
|--------|---------|--------|-------|
| CC1713 | 12"x14" | 1/4"   | 1/4"  |
| CC1714 | 12"x14" | 1/4"   | 1/2"  |
| CC1715 | 12"x14" | 1/4"   | 3/4"  |
| CC1716 | 12"x14" | 1/4"   | 1"    |
| CC1722 | 12"x14" | 3/8"   | 1/2"  |
| CC1717 | 12"x14" | 1/2"   | 1/2"  |
| CC1718 | 12"x14" | 1/2"   | 3/4"  |
| CC1719 | 12"x14" | 1/2"   | 1"    |
| CC1720 | 12"x14" | 3/4"   | 3/4"  |
| CC1721 | 12"x14" | 3/4"   | 1"    |

### D) With Mounting Bar

#### And Clevis Bracket **NEW**

Mounting bar reinforces the top. Single Action Clevis Bracket (CC659) fitted on bar. Use with Clevis Handles or with Adapters for use with Bull Float Handles (pages 22-24), sold separately.

| No.    | Size   | Radius | Depth |
|--------|--------|--------|-------|
| CC1701 | 8"x10" | 1/4"   | 1/4"  |
| CC1702 | 8"x10" | 1/4"   | 1/2"  |
| CC1703 | 8"x10" | 1/4"   | 3/4"  |
| CC1704 | 8"x10" | 1/4"   | 1"    |
| CC1708 | 8"x10" | 3/8"   | 1/2"  |
| CC1705 | 8"x10" | 1/2"   | 1/2"  |
| CC1706 | 8"x10" | 1/2"   | 3/4"  |
| CC1707 | 8"x10" | 1/2"   | 1"    |
| CC1710 | 8"x10" | 3/4"   | 3/4"  |
| CC1711 | 8"x10" | 3/4"   | 1"    |





# BRONZE GROOVERS

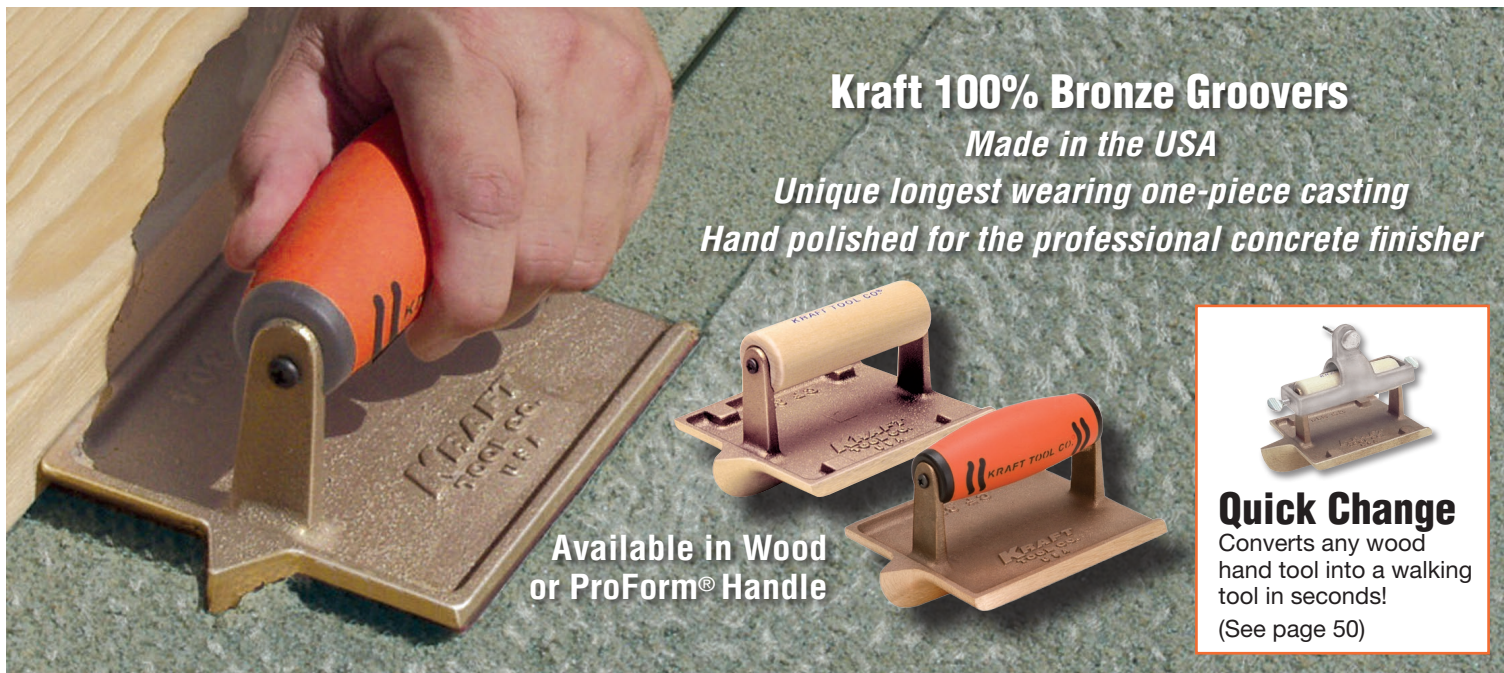

**Kraft 100% Bronze Groovers**

*Made in the USA*

*Unique longest wearing one-piece casting*

*Hand polished for the professional concrete finisher*

Available in Wood or ProForm® Handle



### Quick Change

Converts any wood hand tool into a walking tool in seconds!  
(See page 50)

#### MEDIUM BIT

5-1/2"x3"

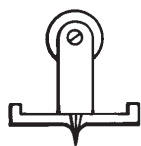

Choice of Handle



Wood  
CF260

ProForm®  
CF260PF

3/8" Deep Bit 5/16" Wide Bit Radius 1/4"

#### SMALL BIT

6"x2"

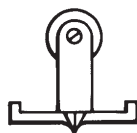

Choice of Handle



Wood  
CF301

ProForm®  
CF301PF

3/16" Deep Bit 3/16" Wide Bit Radius 1/4"

#### LARGE BIT

6"x4-1/2"

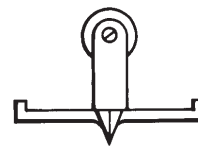

Choice of Handle



Wood  
CF303

ProForm®  
CF303PF

1/2" Deep Bit 3/8" Wide Bit Radius 1/4"

#### BIG TEX BIT

6"x4-1/2"

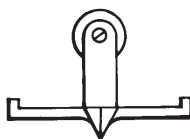

Wood  
CF408

ProForm®  
CF408PF

5/8" Deep Bit 5/8" Wide Bit Radius 1/4"

#### NARROW BIT

6"x4-1/2"

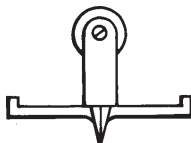

Wood  
CF305

ProForm®  
CF305PF

3/4" Deep Bit 3/8" Wide Bit Radius 1/4"

#### BIG BIT

6"x4-1/2"

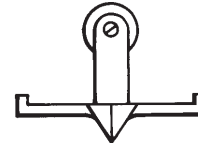

Wood  
CF304

ProForm®  
CF304PF

3/4" Deep Bit 7/8" Wide Bit Radius 3/8"

#### DEEP BIT

6"x4-1/2"

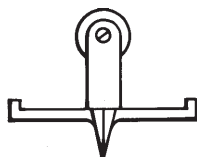

Wood  
CF314

ProForm®  
CF314PF

1" Deep Bit 1/2" Wide Bit Radius 1/4"

#### DENVER JUMBO BIT

6"x4-1/2"

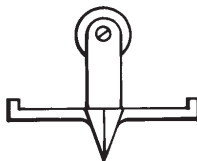

Wood  
CF316

ProForm®  
CF316PF

1" Deep Bit 1-1/4" Wide Bit Radius 1/2"

#### CANADIAN DEEP BIT

6"x4-1/2"

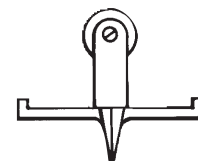

Wood  
CF315

ProForm®  
CF315PF

1-1/2" Deep Bit 1/2" Wide Bit Radius 1/4"

#### COLORADO BIT

6-1/2"x3"



Wood  
CF380

ProForm®  
CF380PF

3/4" Deep Bit 3/8" Wide Bit Radius 1/8"

#### EXTRA DEEP BIT

7-1/2"x4-1/2"

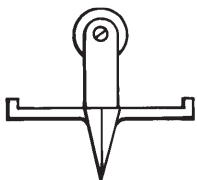

Wood  
CF317

ProForm®  
CF317PF

1-1/2" Deep Bit 1/2" Wide Bit Radius 1/4"

#### DEEP BIT

8"x4-1/2"

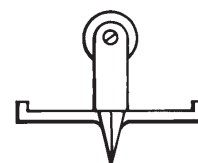

Wood  
CF374

ProForm®  
CF374PF

1" Deep Bit 1/2" Wide Bit Radius 1/4"

# BRONZE EDGERS & GROOVERS

- Unique long-wearing one-piece casting
- Hand polished for the professional concrete finisher
- Available in either wood or soft grip ProForm® handles
- Made in the USA



Bit 3/4" deep with 3/8" radius

Lip 3/4" deep with 3/8" radius

## Matched Set

### Bronze Groover and Edger

Groover bit (depth and radius) matches edger lip. Perfect for matching edge and groove finishes on sidewalks and driveways.

#### Choice of Handle



| Wood No. | ProForm® No. | Size  |
|----------|--------------|---|
| CF318    | CF318PF      | Edger, 6"x3", 3/8" Radius, 3/4" Lip                     |
| CF319    | CF319PF      | Groover, 6"x6", 3/8" Radius, 3/4" Bit Depth, 5/8" Width |
| CF324    | CF324PF      | Edger/Groover (Set)                                     |



## Edgers

Special turned up ends to eliminate gouging of concrete

| Wood No. | ProForm® No. | Size      | Radius | Lip  |
|----------|--------------|-----------|--------|------|
| CF311    | CF311PF      | 6"x2-3/4" | 1/4"   | 5/8" |
| CF313    | CF313PF      | 6"x4"     | 1/4"   | 5/8" |



## Bronze Chamfer Tube Edger

- Belt polished surface for cutting clean, smooth edges
- Used for creating chamfered edges on round support piers
- Made of long wearing one-piece bronze with 1" lip and 1/2" radius and turned up ends
- Slope on the pier edge can be varied depending upon wetness of the concrete and the angle and pressure applied by the user



| Wood No. | ProForm® No. | Diameter |
|----------|--------------|----------|
| CF382    | CF382PF      | 12"      |
| CF383    | CF383PF      | 16"      |
| CF384    | CF384PF      | 18"      |

| Wood No. | ProForm® No. | Diameter |
|----------|--------------|----------|
| CF385    | CF385PF      | 24"      |
| CF386    | CF386PF      | 30"      |
| CF387    | CF387PF      | 36"      |
| CF388    | CF388PF      | 48"      |

## Jumbo Bronze Edger

Special turned up ends to eliminate gouging of concrete

| Wood No. | ProForm® No. | Size  | Radius | Lip  |
|----------|--------------|-------|--------|------|
| CF312    | CF312PF      | 9"x4" | 1/4"   | 3/4" |



## Bronze Rocker Groover

Curved blade and tilt handle give plenty of knuckle room.

| No.   | Size          | Bit       | Depth |
|-------|---------------|-----------|-------|
| CF306 | 4-3/4"x1-3/4" | 1/4"x1/4" | 1/8"  |
| CF307 | 4-3/4"x1-3/4" | 3/8"x3/8" | 1/4"  |
| CF308 | 4-3/4"x1-3/4" | 1/2"x1/2" | 1/4"  |



## Quick Change Bracket Converter Bracket for Hand-Held Tools

- Converts any wood handled tool into a walking tool in seconds
- Thumb screws hold aluminum bracket securely in place
- Fits all wooden handled bronze, stainless steel and blue steel hand tools

No. CC495



Hand tool not included



## Iron Groover Dallas Bit Groover

Made of long-wearing heavy-duty malleable iron. Turned up edges prevent gouging. Features approximately 1/8" radius.

| No.   | Size      | Depth | Width |
|-------|-----------|-------|-------|
| CF299 | 6"x4-1/2" | 5/8"  | 5/8"  |

## Ultra Hard Groover Heavy-Duty Iron

This west coast favorite is made of a special formula chrome-nickel-iron metal that is long lasting. 6" wood handle with steel clevis tightens to various angles.

| No.   | Size      | Depth | Width |
|-------|-----------|-------|-------|
| CF404 | 3-1/2"x4" | 1/4"  | 3/8"  |



### Bronze Concrete Name Stamp

The perfect way to mark concrete for permanent identification. Made from high grade bronze. Stamp is 9"x5" oval with flat ends. Up to 16 spaces on each of 3 lines. Replacement year stamp is 5/8" high. Stamp can be furnished without date on request. Allow approximately 2-3 weeks for shipment.

| No.        | Description                                 |
|------------|---|
| CF400      | Stamp with 2018 Insert                      |
| CF400PF    | Stamp with 2018 Insert with ProForm® Handle |
| CF400-01   | Stamp without Date                          |
| CF400PF-01 | Stamp without Date with ProForm® Handle     |
| CF401-18   | 2018 Date (Insert Only)                     |
| CF401-19   | 2019 Date (Insert Only)                     |



**PUT YOUR NAME HERE**  
Order forms available online or ask your Customer Service Representative

### Walking Bronze Groover Single End Bit Groover

- Belt polished surface for cutting clean smooth sharp grooves
- Long wearing one-piece bronze with turned up ends
- Easy to clean and comfortable to use
- Includes 5' wood clevis handle (CC386)

6"x4-1/2"

| No.   | Radius | Depth | Width  |
|-------|--------|-------|--------|
| CC303 | 1/4"   | 1/2"  | 3/8"   |
| CC308 | 1/4"   | 5/8"  | 5/8"   |
| CC304 | 3/8"   | 3/4"  | 7/8"   |
| CC305 | 1/4"   | 3/4"  | 3/8"   |
| CC314 | 1/4"   | 1"    | 1/2"   |
| CC316 | 1/2"   | 1"    | 1-1/4" |

7-1/2"x4-1/2"

|       |      |        |      |
|-------|------|--------|------|
| CC317 | 1/4" | 1-1/2" | 1/2" |
|-------|------|--------|------|

8"x4-1/2"

|       |      |    |      |
|-------|------|----|------|
| CC374 | 1/4" | 1" | 1/2" |
|-------|------|----|------|

Add "01" after part no. for groover without handle

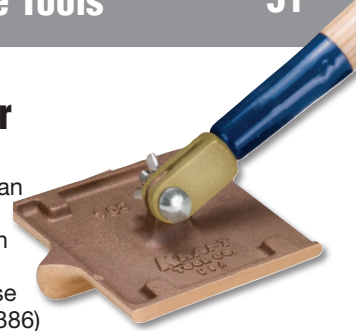

### Double End Bit Groover

- Grooves in both directions
- Includes 5' wood clevis handle (CC386)

8"x4-1/2"

| No.   | Radius | Depth | Width |
|-------|--------|-------|-------|
| CC275 | 1/4"   | 1"    | 1/2"  |

Add "01" after part no. for groover without handle



### Single End Bit Groover 8"x8"

- Largest bronze walking groover available
- Belt polished surface for cutting clean smooth sharp grooves
- Long wearing one-piece bronze with turned up ends
- Easy to clean and comfortable to use
- Includes 5' wood clevis handle (CC386)

Add "01" after part no. for groover without handle

| No.   | Radius | Depth  | Width |
|-------|--------|--------|-------|
| CC276 | 1/4"   | 3/4"   | 3/8"  |
| CC277 | 1/8"   | 3/4"   | 1/4"  |
| CC278 | 1/4"   | 1"     | 3/8"  |
| CC279 | 1/4"   | 1-1/2" | 5/8"  |

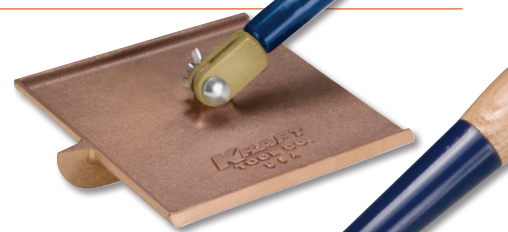

### Bronze Groover With 360° Swivel Bracket

- Belt polished surface for cutting clean, smooth and sharp grooves
- Fitted with 360 degree swivel handle bracket
- Easy to clean and comfortable to use
- Includes 54" heavy-duty wood clevis handle (CC656)

Add "01" after part no. for groover without handle

6"x4-1/2"

| No.     | Radius | Depth | Width |
|---------|--------|-------|-------|
| CC303CA | 1/4"   | 1/2"  | 3/8"  |
| CC304CA | 3/8"   | 3/4"  | 7/8"  |
| CC305CA | 1/4"   | 3/4"  | 3/8"  |
| CC314CA | 1/4"   | 1"    | 1/2"  |



### "Side Railer" Bronze Groover

- Unique design with raised sides allows this popular bronze groover to more accurately follow forms and straightedges when grooving
- Includes 5' wood clevis handle (CC386)

| No.     | Size      | Radius | Depth | Width |
|---------|-----------|--------|-------|-------|
| CC314SR | 6"x4-1/2" | 1/4"   | 1"    | 1/2"  |
| CC304SR | 6"x4-1/2" | 3/8"   | 3/4"  | 7/8"  |



Add "01" after part no. for groover without handle

### Bronze Edgers

- Belt polished surface for cutting clean smooth edges
- Long-wearing one-piece bronze with turned up ends
- Easy to clean and comfortable to use
- Includes 5' wood clevis handle (CC386)

Add "01" after part no. for edger without handle

| No.   | Size  | Radius | Lip  |
|-------|-------|--------|------|
| CC313 | 6"x4" | 1/4"   | 5/8" |
| CC302 | 9"x4" | 1/4"   | 3/4" |

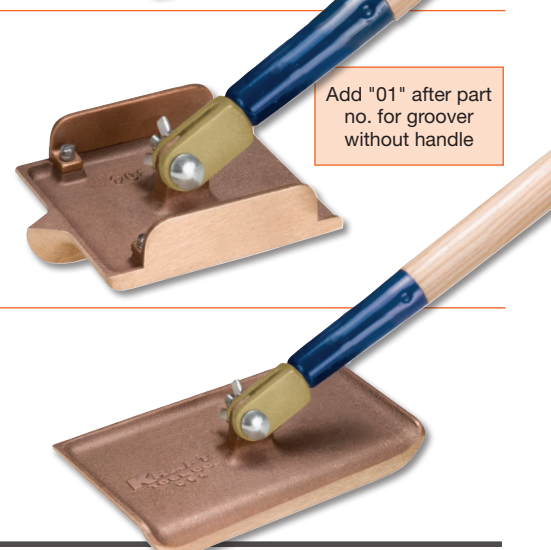

# Elite Series™ STEP TOOLS

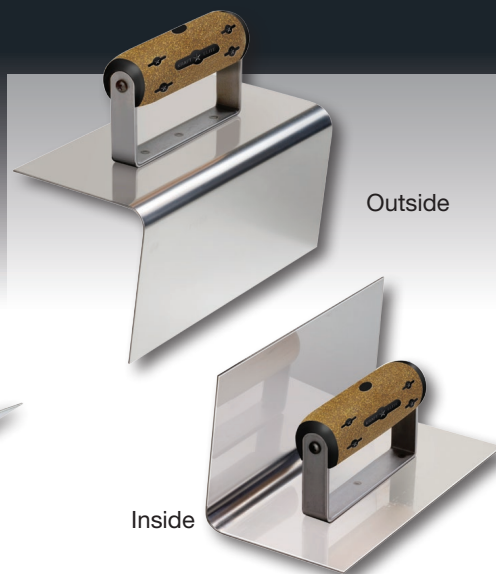
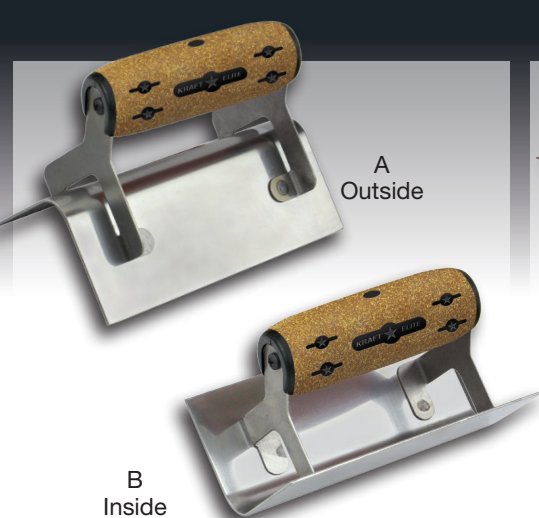
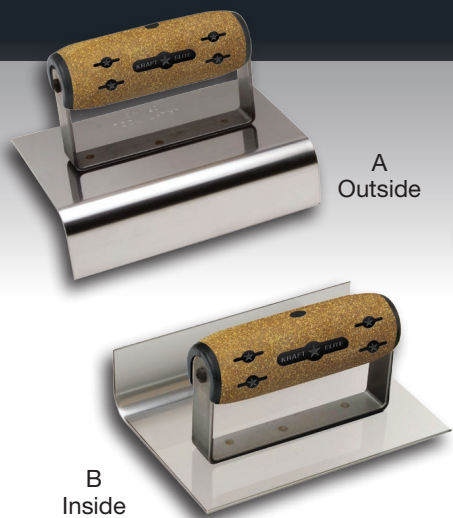

## Sidewalk and Curb Tools Stainless Steel

### A) Outside Nose Tool

Cork Handle

| No.     | Size  | Radius | Lip    |
|---------|-------|--------|--------|
| CFE146K | 6"x4" | 1/2"   | 1-1/2" |
| CFE147K | 6"x4" | 3/4"   | 1-1/2" |
| CFE148K | 6"x4" | 1"     | 1-1/2" |
| CFE243K | 6"x4" | 1-1/2" | 2"     |
| CFE244K | 6"x6" | 1/2"   | 1-1/2" |
| CFE245K | 6"x6" | 3/4"   | 1-1/2" |
| CFE247K | 6"x6" | 1"     | 1-1/2" |
| CFE242K | 6"x6" | 1-1/2" | 2"     |

### B) Inside Cove Tool

Cork Handle

| No.     | Size  | Radius | Lip    |
|---------|-------|--------|--------|
| CFE157K | 6"x4" | 1/2"   | 1-1/2" |
| CFE152K | 6"x4" | 3/4"   | 1-1/2" |
| CFE153K | 6"x4" | 1"     | 1-1/2" |
| CFE248K | 6"x6" | 1/2"   | 1-1/2" |
| CFE249K | 6"x6" | 3/4"   | 1-1/2" |
| CFE250K | 6"x6" | 1"     | 1-1/2" |

See Kraft Tool's Signature Sidewalk and Curb Tools on page 63

## Step and Corner Tools Stainless Steel

### A) Outside Nose Tool

Cork Handle

| No.     | Length | Width  | Radius |
|---------|--------|--------|--------|
| CFE125K | 6"     | 2-1/2" | 1/4"   |
| CFE123K | 6"     | 2-1/2" | 1/2"   |
| CFE121K | 6"     | 2-1/2" | Square |

### B) Inside Cove Tool

Cork Handle

| No.     | Length | Width  | Radius |
|---------|--------|--------|--------|
| CFE126K | 6"     | 2-1/2" | 1/4"   |
| CFE124K | 6"     | 2-1/2" | 1/2"   |
| CFE122K | 6"     | 2-1/2" | Square |

See Kraft Tool's Signature Step and Corner Tools on page 63

## Step Tools

### Stainless Steel

- Inside and outside step tools, available individually or as a matched pair
- 8"x4" with 1/2" radius and 4" lip

Cork Handle

| No.     | Description  | Batter     |
|---------|--------------|------------|
| CFE177K | Inside Tool  | 1/2" at 6" |
| CFE178K | Outside Tool | 1/2" at 6" |
| CFE179K | Matched Pair | 1/2" at 6" |
| CFE180K | Inside Tool  | None       |
| CFE181K | Outside Tool | None       |
| CFE182K | Matched Pair | None       |

See Kraft Tool's Signature Step Tools on page 63

## Hand Seamer/Groover Stainless Steel

Seamer makes smooth control joints. No rivet design and brushed stainless steel for an extra smooth working surface. Closed end bit eliminates build up in tool.

Cork Handle

| No.     | Size    | Depth | Radius |
|---------|---------|-------|--------|
| CFE019K | 8"x5"   | 5/8"  | 3/8"   |
| CFE023K | 8"x5"   | 3/4"  | 1/2"   |
| CFE027K | 8"x5"   | 7/8"  | 3/4"   |
| CFE025K | 8"x8"   | 1/2"  | 3/8"   |
| CFE040K | 8"x8"   | 5/8"  | 3/8"   |
| CFE026K | 8"x8"   | 3/4"  | 1/2"   |
| CFE021K | 8"x8"   | 7/8"  | 3/4"   |
| CFE029K | 10"x10" | 7/8"  | 3/4"   |

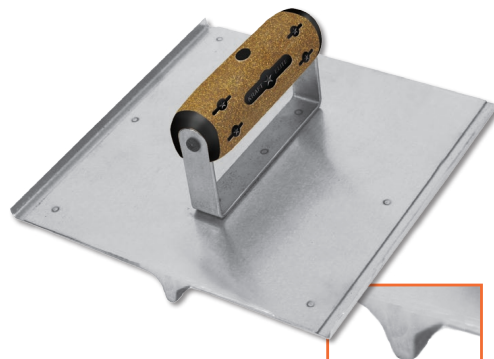

See Kraft Tool's Signature Hand Seamer/Groover on page 60

Elite Series™ Finishing Trowels Pages 4-6  
Elite Series™ Hand Floats Page 16-17





# Elite Series™ EDGERS AND GROOVERS



**NEW**

### 6" Long Sidewalk Edgers

| No.     | Width  | Radius | Lip    |
|---------|--------|--------|--------|
| CFE161K | 1-1/2" | 1/4"   | 3/8"   |
| CFE160K | 2"     | 3/8"   | 1/2"   |
| CFE162K | 2-1/2" | 1/4"   | 3/8"   |
| CFE170K | 3"     | 1/8"   | 1/4"   |
| CFE163K | 3"     | 1/4"   | 3/8"   |
| CFE092K | 3"     | 3/8"   | 1/2"   |
| CFE164K | 3-1/2" | 3/8"   | 1/2"   |
| CFE171K | 4"     | 1/8"   | 1/4"   |
| CFE172K | 4"     | 1/4"   | 3/8"   |
| CFE173K | 4"     | 3/8"   | 1/2"   |
| CFE165K | 4"     | 1/2"   | 5/8"   |
| CFE907K | 4"     | 5/8"   | 3/4"   |
| CFE174K | 4"     | 3/4"   | 1"     |
| CFE136K | 6"     | 1/8"   | 1/4"   |
| CFE137K | 6"     | 1/4"   | 3/8"   |
| CFE138K | 6"     | 3/8"   | 1/2"   |
| CFE175K | 6"     | 1/2"   | 5/8"   |
| CFE912K | 6"     | 5/8"   | 3/4"   |
| CFE139K | 6"     | 3/4"   | 1"     |
| CFE908K | 6"     | 1"     | 1-1/4" |

### 8" Long Sidewalk Edgers

|         |    |      |      |
|---------|----|------|------|
| CFE169K | 4" | 1/8" | 1/4" |
| CFE168K | 4" | 1/4" | 3/8" |
| CFE167K | 4" | 3/8" | 1/2" |
| CFE166K | 4" | 1/2" | 5/8" |
| CFE185K | 4" | 3/4" | 1"   |
| CFE127K | 5" | 1/4" | 3/8" |
| CFE128K | 5" | 3/8" | 1/2" |
| CFE129K | 5" | 1/2" | 5/8" |
| CFE130K | 5" | 3/4" | 1"   |
| CFE100K | 6" | 1/8" | 1/4" |
| CFE101K | 6" | 1/4" | 3/8" |
| CFE102K | 6" | 3/8" | 1/2" |
| CFE103K | 6" | 1/2" | 5/8" |
| CFE104K | 6" | 3/4" | 1"   |
| CFE105K | 8" | 1/8" | 1/4" |
| CFE106K | 8" | 1/4" | 3/8" |
| CFE107K | 8" | 3/8" | 1/2" |
| CFE108K | 8" | 1/2" | 5/8" |
| CFE109K | 8" | 3/4" | 1"   |

### 9" Long Highway Edgers

|         |        |        |      |
|---------|--------|--------|------|
| CFE155K | 2-1/2" | 1/2"   | 5/8" |
| CFE176K | 3"     | 1/2"   | 5/8" |
| CFE188K | 4"     | 1/2"   | 5/8" |
| CFE189K | 4"     | 3/4"   | 1"   |
| CFE190K | 5"     | 3/8"   | 1/2" |
| CFE191K | 5"     | 1/2"   | 5/8" |
| CFE241K | 6"     | 1-1/2" | 2"   |

### 10" Long Highway Edgers

|         |        |        |        |
|---------|--------|--------|--------|
| CFE158K | 3-1/2" | 1/4"   | 3/8"   |
| CFE159K | 4"     | 3/8"   | 1/2"   |
| CFE154K | 4"     | 1"     | 1-1/4" |
| CFE140K | 4"     | 1-1/2" | 2"     |
| CFE143K | 5-3/4" | 2"     | 2-5/8" |
| CFE909K | 6"     | 1/4"   | 3/8"   |
| CFE320K | 6"     | 3/8"   | 1/2"   |
| CFE321K | 6"     | 1/2"   | 5/8"   |
| CFE906K | 6"     | 5/8"   | 3/4"   |
| CFE322K | 6"     | 3/4"   | 1"     |
| CFE323K | 6"     | 1"     | 1-1/4" |
| CFE240K | 6"     | 1-1/2" | 2"     |
| CFE144K | 6-1/4" | 3"     | 3-1/4" |



## Cork Handle

### Patent Pending

- Wicks moisture away for a firm grip without chafing and slipping
- Precise diameter for an easy, comfortable grip
- Secured and balanced for ease of use

## Elite Series™ ★★★★★ Five Star Edgers And Groovers

Experience the highest quality edgers and groovers available for the professional tradesman. Each Elite Series™ Hand Edger, Groover, and Step Tool is made to meticulous standards to create a long-lasting quality tool. Each radius is formed to exacting specifications for a smooth, professional finish on every job. The unique cork handle is secured to each tool to provide the utmost comfort for the user.

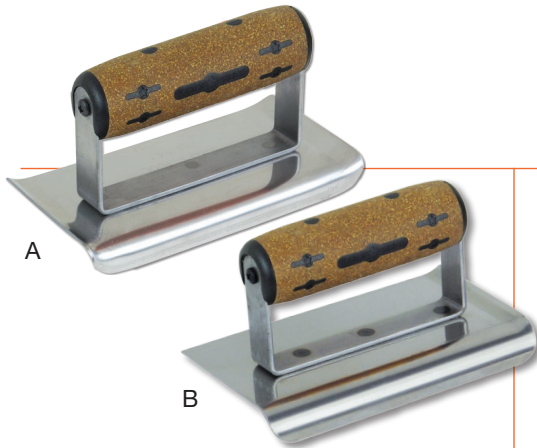

## Curved End Edgers

Strong #16 gauge stainless steel blade. Edger has turned up end(s) to prevent gouging of concrete.

### A) Both Ends Curved

#### NEW SIZES

#### Cork Handle

| No.      | Size      | Radius | Lip  |
|----------|-----------|--------|------|
| CFE142K  | 6"x2-1/2" | 1/4"   | 3/8" |
| CFE141K  | 6"x3"     | 1/4"   | 3/8" |
| CFE092KC | 6"x3"     | 3/8"   | 1/2" |
| CFE172KC | 6"x4"     | 1/4"   | 3/8" |
| CFE173KC | 6"x4"     | 3/8"   | 1/2" |
| CFE165KC | 6"x4"     | 1/2"   | 5/8" |
| CFE168KC | 8"x4"     | 1/4"   | 3/8" |
| CFE167KC | 8"x4"     | 3/8"   | 1/2" |
| CFE166KC | 8"x4"     | 1/2"   | 5/8" |

### B) One End Curved **NEW**

#### Cork Handle

| No.       | Size  | Radius | Lip  |
|-----------|-------|--------|------|
| CFE141KCF | 6"x3" | 1/4"   | 3/8" |
| CFE092KCF | 6"x3" | 3/8"   | 1/2" |
| CFE172KCF | 6"x4" | 1/4"   | 3/8" |
| CFE173KCF | 6"x4" | 3/8"   | 1/2" |
| CFE165KCF | 6"x4" | 1/2"   | 5/8" |
| CFE168KCF | 8"x4" | 1/4"   | 3/8" |
| CFE167KCF | 8"x4" | 3/8"   | 1/2" |
| CFE166KCF | 8"x4" | 1/2"   | 5/8" |

See Kraft Tool's Signature Curved End Edger on page 56



## Hand Edger

### #18 Gauge Stainless Steel

Special brushed stainless steel for an extra smooth working surface.

#### Cork Handle

| No.     | Size  | Radius | Lip  |
|---------|-------|--------|------|
| CFE039K | 8"x8" | 1/4"   | 1/2" |
| CFE035K | 8"x8" | 1/2"   | 3/4" |
| CFE038K | 8"x8" | 3/4"   | 7/8" |

See Kraft Tool's Signature Hand Edger on page 56

## Stainless Steel Hand Edgers (Right)

Strong #16 gauge stainless steel construction for a longer lasting blade. A steel mounting welded to the blade secures the cork handle to the tool.

See Kraft Tool's Signature Hand Edgers on page 57

# Elite Series™

## Five Star Edgers And Groovers

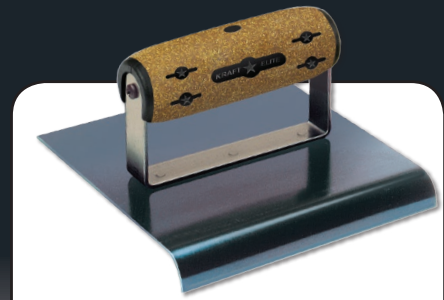

### Blue Crucible Steel Step Tools

- Tempered blue crucible spring steel
- Blade is very flexible and lightweight
- Available with or without batter

#### A) Inside Step Tool

##### Cork Handle

| No.     | Size  | Lip | Radius | Batter          |
|---------|-------|-----|--------|-----------------|
| CFE584K | 7"x6" | 6"  | 1/4"   | 1/2" at 6"      |
| CFE760K | 7"x6" | 6"  | 1/4"   | None            |
| CFE585K | 7"x6" | 6"  | 3/8"   | 1/2" at 6"      |
| CFE761K | 7"x6" | 6"  | 3/8"   | None            |
| CFE586K | 7"x6" | 6"  | 1/2"   | 1/2" at 6"      |
| CFE762K | 7"x6" | 6"  | 1/2"   | None            |
| CFE587K | 7"x6" | 6"  | 3/4"   | 1/2" at 6"      |
| CFE763K | 7"x6" | 6"  | 3/4"   | None            |
| CFE588K | 7"x6" | 6"  | 1"     | 1/2" at 6"      |
| CFE764K | 7"x6" | 6"  | 1"     | None            |
| CFE766K | 7"x6" | 6"  | 1-1/2" | None <b>NEW</b> |

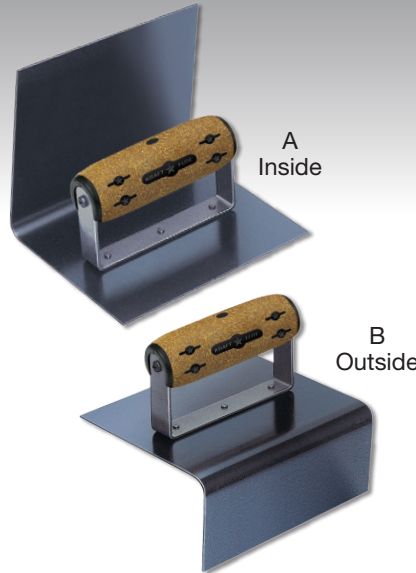

#### B) Outside Step Tool

##### Cork Handle

| No.     | Size  | Lip    | Radius | Batter          |
|---------|-------|--------|--------|-----------------|
| CFE589K | 6"x6" | 3-1/2" | 1/4"   | 1/2" at 6"      |
| CFE767K | 6"x6" | 3-1/2" | 1/4"   | None            |
| CFE590K | 6"x6" | 3-1/2" | 3/8"   | 1/2" at 6"      |
| CFE768K | 6"x6" | 3-1/2" | 3/8"   | None            |
| CFE591K | 6"x6" | 3-1/2" | 1/2"   | 1/2" at 6"      |
| CFE769K | 6"x6" | 3-1/2" | 1/2"   | None            |
| CFE592K | 6"x6" | 3-1/2" | 3/4"   | 1/2" at 6"      |
| CFE770K | 6"x6" | 3-1/2" | 3/4"   | None            |
| CFE593K | 6"x6" | 3-1/2" | 1"     | 1/2" at 6"      |
| CFE771K | 6"x6" | 3-1/2" | 1"     | None            |
| CFE772K | 6"x6" | 3-1/2" | 1-1/2" | None <b>NEW</b> |

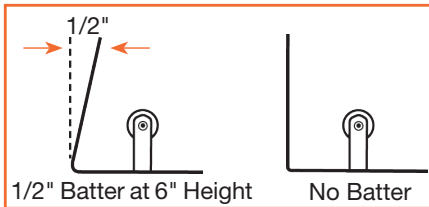

See Kraft Tool's Signature Blue Steel Step Tools on page 67

| No.     | Size      | Radius |
|---------|-----------|--------|
| CFE566K | 6"x3"     | 1/8"   |
| CFE568K | 6"x3"     | 1/4"   |
| CFE569K | 6"x3"     | 3/8"   |
| CFE570K | 6"x3"     | 1/2"   |
| CFE565K | 6"x3"     | 3/4"   |
| CFE567K | 6"x4"     | 1/8"   |
| CFE572K | 6"x4"     | 1/4"   |
| CFE573K | 6"x4"     | 3/8"   |
| CFE574K | 6"x4"     | 1/2"   |
| CFE562K | 6"x4"     | 5/8"   |
| CFE571K | 6"x4"     | 3/4"   |
| CFE675K | 6"x4"     | 1"     |
| CFE670K | 6"x5-1/2" | 1/8"   |
| CFE671K | 6"x5-1/2" | 1/4"   |
| CFE672K | 6"x5-1/2" | 3/8"   |
| CFE673K | 6"x5-1/2" | 1/2"   |
| CFE674K | 6"x5-1/2" | 3/4"   |
| CFE579K | 6"x6"     | 1/8"   |
| CFE575K | 6"x6"     | 1/4"   |
| CFE576K | 6"x6"     | 3/8"   |
| CFE577K | 6"x6"     | 1/2"   |
| CFE563K | 6"x6"     | 5/8"   |
| CFE578K | 6"x6"     | 3/4"   |
| CFE564K | 6"x6"     | 1"     |
| CFE677K | 9"x4"     | 1/4"   |
| CFE595K | 9"x6"     | 1/4"   |
| CFE596K | 9"x6"     | 3/8"   |
| CFE597K | 9"x6"     | 1/2"   |
| CFE598K | 9"x6"     | 3/4"   |

See Kraft Tool's Signature Blue Steel Edgers on page 65

### Blue Crucible Steel Curb and Step Tools

- Made of blue crucible spring steel
- Provides just the right feel and flex for a professional finish

#### A) Curb Tool - Outside

- Measures 9"x5"

##### Cork Handle

| No.     | Lip | Radius | Batter       |
|---------|-----|--------|--------------|
| CFE580K | 5"  | 1/2"   | 1-1/2" at 6" |
| CFE581K | 5"  | 3/4"   | 1-1/2" at 6" |

#### B) Step Tool - Inside

##### Cork Handle

| No.     | Size  | Lip | Radius |
|---------|-------|-----|--------|
| CFE515K | 6"x4" | 3"  | 1"     |
| CFE516K | 6"x6" | 3"  | 1"     |

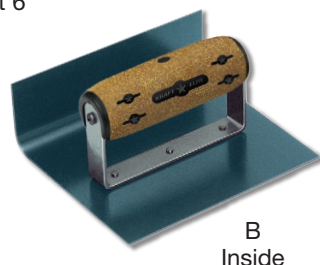
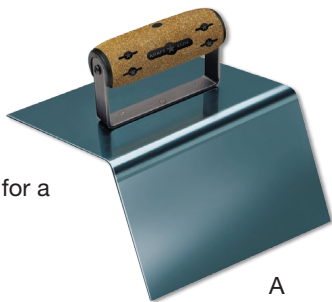

See Kraft Tool's Signature Blue Steel Curb and Step Tools on page 65

### Blue Crucible Steel Junior Step Tools

- Made of blue crucible spring steel
- Provides just the right feel and flex for a professional finish
- Purchase together or separately

#### A) Junior Step Tool - Outside

##### Cork Handle

| No.     | Size  | Lip | Radius |
|---------|-------|-----|--------|
| CFE517K | 6"x5" | 2"  | 1/2"   |

#### B) Junior Step Tool - Inside

##### Cork Handle

| No.     | Size  | Lip | Radius |
|---------|-------|-----|--------|
| CFE518K | 6"x5" | 2"  | 1/2"   |

#### Matched Pair

##### Cork Handle

| No.     | Size  | Lip | Radius |
|---------|-------|-----|--------|
| CFE519K | 6"x5" | 2"  | 1/2"   |

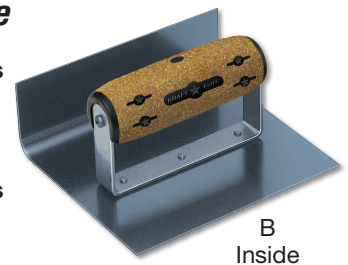
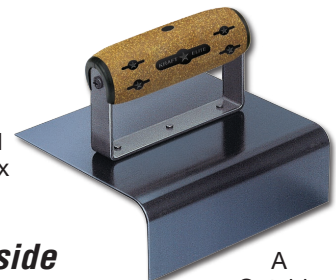

See Kraft Tool's Signature Blue Steel Step Tools on page 67