

Texture Rollers

In just minutes create a unique finish on walls and ceilings. Simply roll this texture roller over fresh textured surfaces to provide a beautiful uniform pattern. Hides blemishes and defects in old walls. Fits standard 9" paint roller.

No.	Description
DW180	Crowsfoot
DW180R	Crowsfoot with Roller Frame
DW181	Basket Weave
DW181R	Basket Weave with Roller Frame
DW182	Monterrey
DW182R	Monterrey with Roller Frame
DW183	Poinsettia
DW183R	Poinsettia with Roller Frame
DW184	Tree Bark
DW184R	Tree Bark with Roller Frame
DW185	Vine
DW185R	Vine with Roller Frame
DW186	Palm Leaf
DW186R	Palm Leaf with Roller Frame

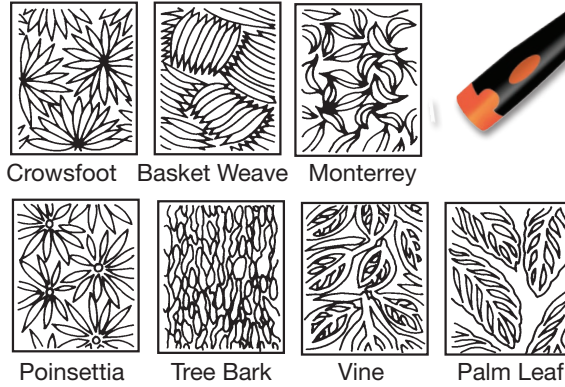

- Comes with or without roller frame
- Outstanding decorations for walls
- Economically applied and simple to use



Poinsettia

Roller Frame Only

9" roller frame with soft style handle, threaded end for extension handle.

No. DW179*

Roller Tray (page 74)
18" Plastic No. DW189



Patch Gun

Handy and efficient tool for acoustic repairs, remodeling and patching. Great for spot retouching. The gun holds 2-4 pounds of mix. Galvanized steel frame won't corrode with use. Comb adjusts for individual project needs. Plastic handle designed to fit a pole for extended reach.

No.	Description
DC196*	Patch Gun
DC196-01*	Replacement Rotary Wheel
DC196-02*	Replacement Lid



Lexan® Knock Down Knife

Clear, durable and flexible. Used for drywall, EIFS and acoustical jobs. Threaded end plastic handle can be used with broom threaded extension handle for longer reach (page 86). Packaged 6 per carton.

No.	Size
DW193	18"x12"
DW194	24"x12"



Spray Shield

High impact super-flexible plastic, lightweight, and easy to clean. Keeps paint off window frames and floors. Ideal to control spray for acoustical ceilings. Accepts broom threaded handles (page 86).

No.	Size
DC192	36"x9"

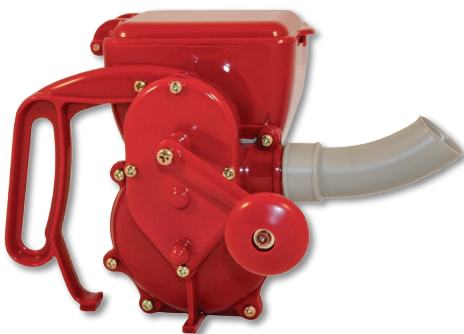

Glitter Gun

Plastic glitter gun used to apply glitter to ceilings and walls. Easily operated by turning handle to apply a steady flow of glitter to surface.

No. DC615*

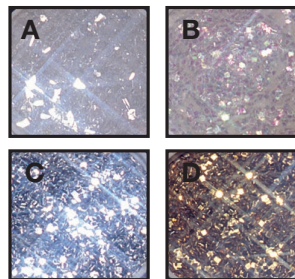

Glitter

Gives sparkling effect to ceilings. Covers about 500 sq. ft. per pound. Glitter is applied by blowing it onto a wet surface of texture. Fade and tarnish resistant. Not recommended for outside use.

No.	Description
A) DC456	1 lb. Glaschip #20 Size
B) DC472	1 lb. Iris Glitter
C) DC452	1 lb. Silver Glitter 1/16"
D) DC492	1 lb. Gold Glitter 1/16"

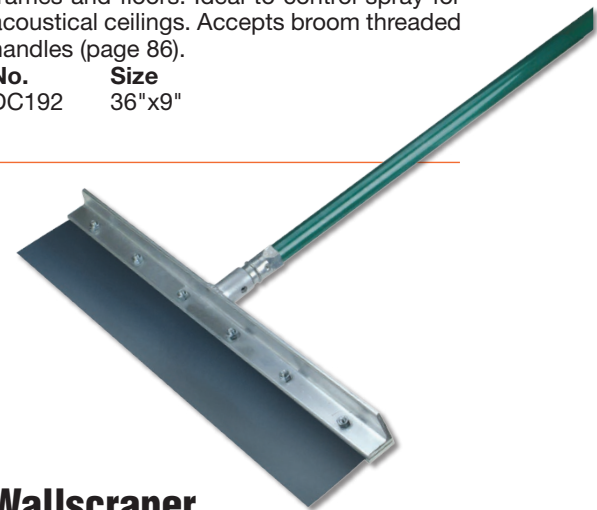

Wallscraper

Sturdy, 22" blue steel blade scrapes excess mud from walls and ceilings. Easy-to-change replacement blade and 48" replaceable handle are available.

No.	Description
DC386	Wallscraper
DC388	22" Replacement Blade
HC517-02M	48" Replacement Handle



Drywall Dolly

All steel structure of welded tubing. Rounded corners for safety. Bed is sloped to carry boards at proper angle. Phenolic resin wheels, resist corrosion from most materials and provide exceptional service in cold and wet conditions. Comes with four heavy-duty casters; two locking swivel casters and two straight casters. 48" long by 24" wide and 48" tall. Easily fits through most doorways. Ships assembled Weight: 92 lbs.

No. DC323**

**Must ship via truck

Can ship UPS



Economy Drywall Dolly

All steel construction. 44"x12" sloped bed. 2 straight and 2 locking 8" casters. 22" wide base easily fits through doorways. Bright orange easy to spot on jobsite. Ships flat, unassembled. Shipping weight: 100 lbs.

No. DC323E*

Economy Drywall Dolly with Non-Marking Wheels

Same steel construction as economy model, but features wheels that will not mark surfaces. Ships flat, unassembled.

No. DC323ENM*



Rasp

Rasp is the ideal tool to shave and form wood, vinyl, drywall and many other materials. Handy tool to carry in the pocket or pouch. Only 5-1/2" long.

No.	Description
DC135*	Rasp
DC136*	Replacement Blade



Drywall Stirrup Footlift

Drywall stirrup footlift is made of cast aluminum, correctly balanced with lip always on floor. Just kick under board and lift. Stirrup allows the lifter to move without bending over.

No. DW273



Kraft Tool Fractional Read Tape Measure

- Positive lock tape
- 16" markings for studs
- Compact smooth plastic case fits comfortably in hand
- Fractions marked for easy reading

No. GG339* Size 25'x1"



Lift 'n' Carry Panel Mover

One person can carry up to 150 lbs. of drywall, panel board, plywood, or wallboard with this lightweight molded plastic tool. Handle is angled to keep material away from hands. Rubber pads to prevent shifting.

No. HC545*



Drywall Roll Lifter

Rigid steel construction, ribbed back weighted nose and roller-wheel for moving ease. Allows one person to raise drywall up to 3". Weighs 2 lbs, 10 oz.

No. DC171

Mini Lifter

Small, yet mighty! Junior mini foot lift is only 9" long. Strong, yet lightweight metal reinforced bottom is shaped to create a small fulcrum for easy lifting. The 1" toe kick protects wall from your boot, while easily placing it under boards. Easy to carry in your pocket or pouch for easy access for small jobs. Hang hole for easy storage.

No. DC175



Nail Bags, Belts Page 90-91

- Nail Bags
- Tool Belts
- Tool Bags
- More...

Drywall Tool Pouch

The best heavy leather drywall tool pouch on the market. Features a 3"x2" steel hammer loop, plus six other tool loops and holders. Securely made with total rivet construction for heavy-duty use.

No. WL077



*See page 178

Contractor Dual Rail Manual Tile Cutter With Carrying Case

Adjustable measuring guide with English and Metric measurements. All metal body with chrome plated handle and rails. Cuts 19" (48.26cm) ceramic tile straight and 13-3/4" (35cm) ceramic tile diagonally. Comes with 1/2" thick carbide cutting wheel.

No.	Description
ST015*	Dual Rail Manual Tile Cutter with Carrying Case
ST015-02*	1/2" Carbide Replacement Cutting Wheel



Add "01" after part no. for
Tile Cutter without
Carrying Case

Professional 14" Dual Rail Tile Cutter With Carrying Case

All metal body with chrome plated handle and rails. Heavy-duty steel base with anti skid pads. Adjustable measuring guide with English and Metric measurements. Cuts 14" (35.5cm) ceramic tile straight and cuts 10" (25.4cm) ceramic tile diagonally. Comes with 7/8" thick carbide cutting wheel.

No.	Description
ST017*	14" Dual Rail Tile Cutter with Carrying Case
ST017-02*	7/8" Carbide Replacement Cutting Wheel

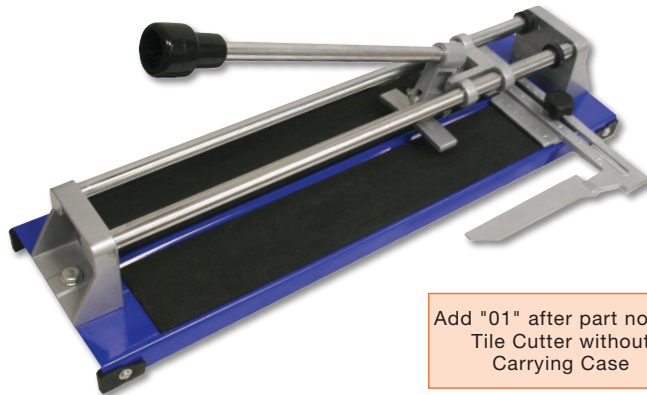

Add "01" after part no. for
Tile Cutter without
Carrying Case

6" Rod / Coping Saw

Cuts tile in odd shapes to accommodate plumbing and electrical outlets. Quality steel framed rod saw with 6" carbide grip blade. Comes with easy-to-change blade held in place by angled steel posts. ProForm® soft grip handle adds comfort and prevents slippage.

No.	Description
ST172	Coping Saw
ST172-01*	Replacement Blade



Tile Hole Saw

Carbide-tipped hole saw cuts clean holes fast and easy. The carbide edges cut a 1-3/8" diameter hole. Works well on both ceramic and quarry tile. Ideal for faucet and shower head pipes. Fits electric drills.

No. TL140*



Carbide Scoring and Cutting Tool

All-purpose tool for scoring and cutting countertop laminates, roof tiles and floor tiles, WonderBoard, Durock, etc. The unique design features three carbide blades. Flip the blade to use the chisel tip hidden within handle to make shaping boards easy. Hard plastic handle cover designed for a firm grip. Length 7-3/4".

No. TL137*

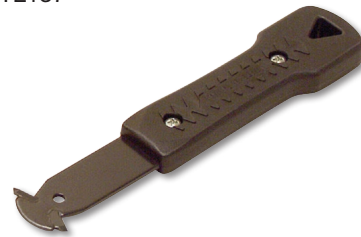

Superior Tile Cutter® Replacement Parts

For more replacement parts check online at www.KraftTool.com



#400 Wheel

#200 Wheel

Carbide Scoring Wheels

- Each are fitted with bushing, washer, screw and locknut.
- Carbide wheels fit all Superior Tile Cutters® and can be sharpened, thus increasing the life of the wheel.

No.	Description
ST048	#400 1/2" Carbide Scoring Wheel
ST051	#200 1/2" Carbide Scoring Wheel

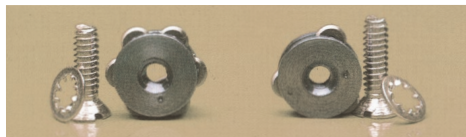

6 Wheel Turret

3 Wheel Turret

Brass Turrets

- Low cost 1/2" replacement brass turrets with carbon steel cutting wheels.
- Rotate turret to move cutting wheel into position.

No.	Description
ST049	6 Wheel 1/2" Brass turrets (2 ea.)
ST050	3 Wheel 1/2" Brass turrets (2 ea.)



"A" Type Replacement Handle

- Insert and spring automatically keep the handle adjusted to the bar.
- Unique spring tension provides automatic adjustment for straight cuts.

No.	Description
ST070	Replacement Handle (Fits all tile cutters)

"The Original"
 Since 1930
SUPERIOR
 Tile Cutter®, Inc. & Tools
 A Kraft Tool Co.® Brand

Since 1930, Superior Tile Cutter®, Inc. has been a trailblazer in making professional quality tile cutters, chisels and scribes. These quality tools are known to last a professional tile setter a lifetime. In 2003, Kraft Tool Co.® acquired this company and expanded this brand to include everything you need for tile, carpet, wood, and vinyl flooring.



TILE CUTTERS

Superior Tile Cutters are designed to score and evenly cut most types of bull nose, shoe-base, quarter rounds, wall, thin vitreous, quarry, porcelain and sheet ceramic tiles without moving the material. All Superior Tile Cutters feature the "A" type handle with automatic spring tension keeping the handle adjusted to the bar.

Small

6"x11"

WT. 5.0 lbs.

- Cuts 6" tiles straight and 4-1/2" tiles diagonally
- Includes adjustable angle gauge
- 4" working table on the right side of the breaker bar, and 2" working table on the left side



ST002 (#00-400)

With #400 Carbide Wheel (ST048)

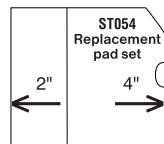

Medium

12"x12"

WT. 7.0 lbs.

- Cuts 6" tiles straight and 4-1/2" tiles diagonally
- Includes adjustable angle gauge
- 6" working table on each side of the breaker bar



ST004 (#1A-400)

With #400 Carbide Wheel (ST048)

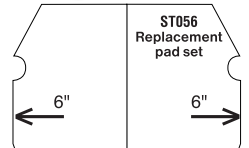

Large

15"x15"

WT. 9.0 lbs.

- Cuts 10" tiles straight and 7" tiles diagonally
- Includes adjustable angle gauge
- 7-1/4" working table on each side of the breaker bar

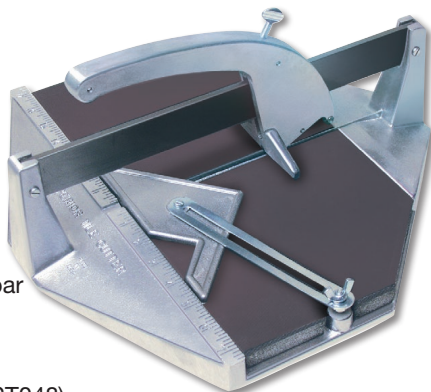

ST006 (#2A-400)

With #400 Carbide Wheel (ST048)

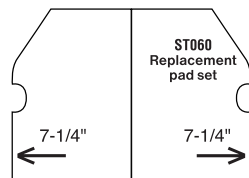

Jumbo

16"x21-1/2"

WT. 12.0 lbs.

- Cuts 16" tiles straight and 10" tiles diagonally
- Includes adjustable angle gauge
- 10" working table on the right side of the breaker bar, and 4" working table on the left side
- Scores tile up to 1-1/2" in thickness

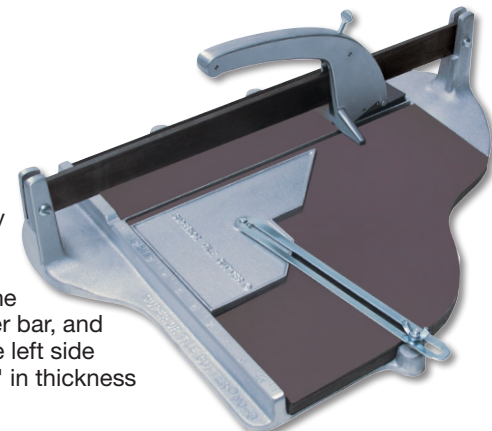

ST007 (#3)

With #400 Carbide Wheel (ST048)

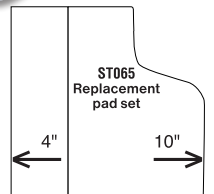

Tile Protectors

For use on all Superior Tile Cutters®. 1 Pair.
 No. ST072



Carbide-Tipped Chisels and Scribe

Designed for removing chipped or broken tile. Chisels are shaped to prevent damage to adjacent tiles. Scribe has pencil point to ensure precision. Carbide-tipped chisels and scribe are 6" in length.

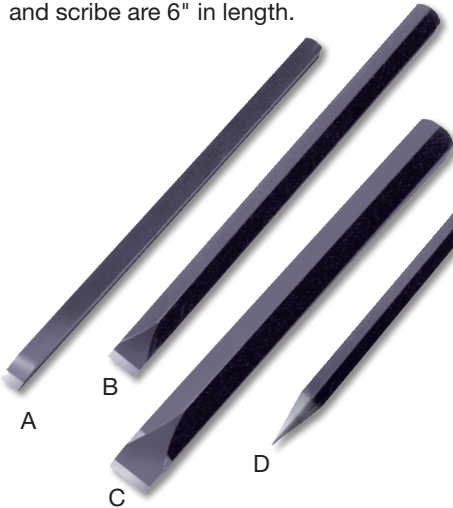

No.	Description
A) ST030	Chisel with 1/4" Wide Tip
B) ST031	Chisel with 3/8" Wide Tip
C) ST032	Chisel with 1/2" Wide Tip
D) ST033	Scribe with 1/4" Shank

Tile / China Markers

Grease-type pencils smoothly mark slick materials such as tile, glass, porcelain, china, or stone. Can also be used on non-porous glazed material. The mark then wipes away for a clean finish. Smooth writing is moisture resistant. Pull the string to peel back the casing when you need more marker. Various colors provide visibility on a variety of surface colors. Includes two each: yellow, black, and red.

No.	Size
ST157*	6-1/2"



Carbide-Tipped Tile Hammer

5/8" polished hammer head face on an 8 oz. hammer head. Fitted with a smooth 10" solid wood handle.

No.	Description
RO3122-5/8C	Hammer with Carbide-Tip
RO3122-5/8	Hammer without Carbide-Tip



Chalk Box and Chalk

Traditional metal-looking plastic chalk box. Use as chalk line or plumb line. Includes 100' of line. Can be used to snap lines and create grids. (See more chalk boxes on page 88.)



No.	Description
GG319	Chalk Box
GG303	White Chalk - 8 oz.
GG304	Blue Chalk - 8 oz.
GG305	Glo Orange Chalk - 8 oz.
GG306	Red Chalk - 8 oz.
GG307	Yellow Chalk - 8 oz.

Poly-Lined Grout Bag

Poly-lined grout bag has a soft 3/8" tip molded in. Size of tip can be increased by cutting a small amount off with scissors. Ideal for use in grouting masonry or tile joints.

No.	Size
WL010	23"x13"



Cone-Shaped Heavy-Duty Vinyl Grout Bag

Cone-shaped, heavy-duty vinyl bag comes complete with replaceable metal tip.

No.	Size
WL013	Large 24"x10-1/2"
WL015	Large 3/8" Replacement Metal Tip
WL014	Giant 28"x15"
WL019	Giant 7/16" Replacement Metal Tip



Tile Spacers

Evenly spaces tile for uniform grout lines. Constructed of tough durable plastic.

No.	Size	Quantity
ST324*	1/16" Spacer	Bag of 300
ST325*	1/16" Spacer	Box of 3000
ST326*	1/8" Spacer	Bag of 200
ST327*	1/8" Spacer	Box of 1600
ST328*	3/16" Spacer	Bag of 150
ST329*	3/16" Spacer	Box of 850
ST330*	1/4" Spacer	Bag of 100
ST331*	1/4" Spacer	Box of 550
ST332*	3/8" Spacer	Bag of 50



Images To Scale

1/16" 1/8" 3/16" 1/4" 3/8"

Tile Wedges

Use these durable plastic wedges for installing wall tiles. Avoid tile slippage on vertical surfaces while maintaining a horizontal grout line. Tapered, textured grip makes installation and removal easy. Length 1-1/4", width 7/16", height 3/16".

No.	Description
ST340*	Bag of 500 Tile Wedges





Superior 8" Carbide Tungsten Tile Nippers

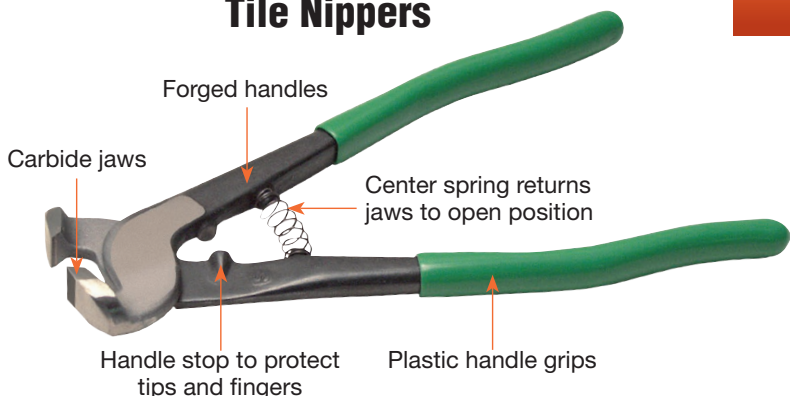

6 Styles to Choose From

ST021 #40 Carbide Nippers with 1/2" Offset Jaws

- Carbide-tipped jaws
- 1/2" biting surface area
- 3/16" opening for cutting standard tile**
- Both cutting edges straight

Cuts all tile and porcelain

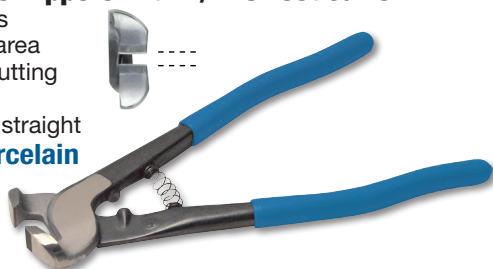

ST023 #85C1 Carbide Nippers with 5/8" Centered Jaws

- Carbide-tipped jaws
- 5/8" biting surface area
- 1/8" opening for cutting thin tile**
- **Both jaws convex** for more accurate cutting of glass, glass mosaic and porcelain tile

Cuts glass, mosaic and porcelain tile



ST020 #80 Carbide Nippers with 5/8" Offset Jaws

- Carbide-tipped jaws
- 5/8" biting surface area
- 3/16" opening for cutting standard tile**
- Both cutting edges straight

Cuts all tile and porcelain



ST024 #Quarry Carbide Nippers with 5/8" Offset Jaws

- Carbide-tipped jaws
- 5/8" biting surface area
- 3/8" opening for cutting thicker tile**
- Both cutting edges straight

Cuts thicker man-made or quarry tiles including porcelain

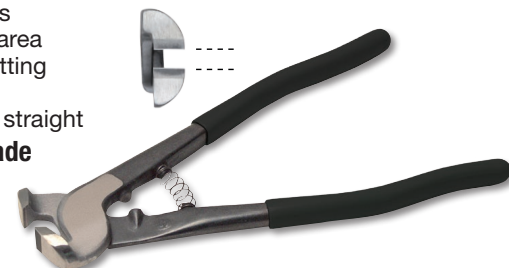

ST022 #85C Carbide Nippers with 5/8" Centered Jaws

- Carbide-tipped jaws
- 5/8" biting surface area
- 3/16" opening for cutting standard tile**
- **One jaw convex** for easy bite action

Cuts all tile and porcelain



ST025 #Thin Tile Carbide Nippers with 5/8" Offset Jaws

- Carbide-tipped jaws
- 5/8" biting surface area
- 1/8" opening for cutting thin tile**
- Both cutting edges straight

Cuts wall (thin) tile



** Opening refers to gap when jaws are closed

Glass Mosaic Cutter

Cut glass, mosaic, terrazzo and thin tile. Cuts thicknesses from 1/32" to 1/4" by handle adjustment of the replaceable carbide cutting wheels.

No.	Description
ST026	Glass Mosaic Cutters
ST026-01	Replacement Cutting Wheels



Tile Cutter

Score the tile with the carbide wheel then use the strong plastic breaker bar to break ceramic tile. Soft comfortable textured plastic grips. Tool measures 8" long.

No.	Description
TL410*	Tile Cutter



DIY Tile Kit

This kit features all the essentials to get started in tile installation. All tools fit in the 5-gallon bucket with lid. Bucket features graduations for accurate measurements while mixing materials. Includes a margin trowel for mixing material and a 1/4" square notched trowel for laying down thinset mortar. Tile nipper for shaping tile to desired size. 1/4" tile spacers to insert between tiles for consistent spacing. Molded float for applying grout and a sponge to keep the work area clean. Includes a pair of disposable gloves and instructions.

No. ST100



Notch Trowels

Easy-to-use notch trowels. The 6"x2" blade is great for enclosed or small areas. Features a comfortable wood handle.

No.	Size	Notch
ST350*	1/4"x1/4"	Square
ST351*	1/4"x3/16"	V



Midget Notch Trowels

A smaller version of the two most popular notched trowels. The small size is easy to maneuver in small spaces and for smaller projects. The square notch is perfect for applying thinset for floor tiles and adhesive for laminated wood plank flooring. The V-notch trowel provides the perfect amount of mastic for wall tiles. The tempered steel blade is hardened for strength. Stainless steel rivets attach the cast aluminum mounting. Measures 6-1/2"x4".

Wood		ProForm®	
No.	Size	No.	Notch
ST392	1/4"x3/16"	ST392PF	V
ST394	1/4"x1/4"	ST394PF	Square



Gizmo Snap-On Trowel

Ideal for applying solid wood flooring and engineered wood flooring adhesive moisture barrier. Disposable notched steel blades allow you to trowel the perfect amount of adhesive each time. Use a new clip for each bucket of material. After use, simply discard the blade for easy clean up. It clips firmly on to any of our 11" notch trowels or finishing trowels. Two notch styles are available for various flooring thicknesses. Each style includes a package of ten 11"x1-1/2" blades.

No.	Notch Type
ST430	A) Wave Notch Use for flooring 3/8" thick or less 1/32" (.8mm) Deep 3/32" (2.4mm) Groover Width
ST431	B) Modified V-Notch Use for flooring 3/8" to 3/4" thick. 3/8" (10mm) Deep 3/16" (4.76mm) Width, 3/8" (9.53) Flat

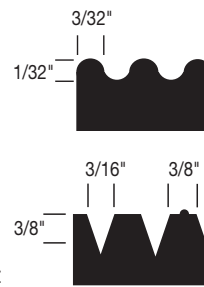

Drawings not to scale

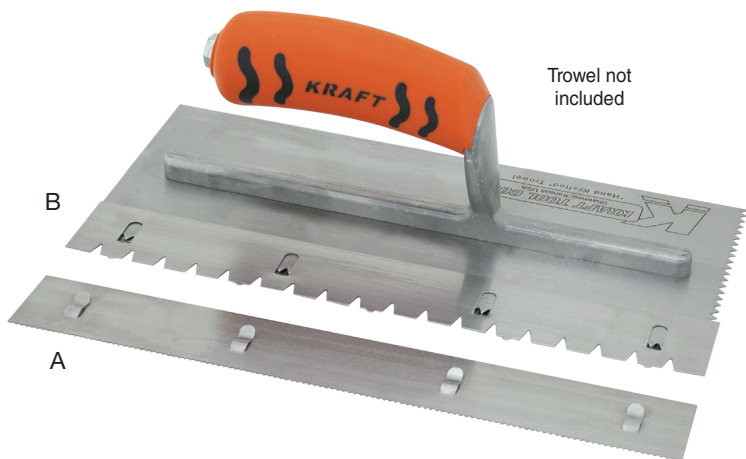



NOTCH TROWELS



Since 1930
SUPERIOR
Tile Cutter®, Inc. & Tools



Add "CC" to part # for case cut displays



Drawings not to scale

11"x4-1/2"

Add "CC" to part # for case cut displays

- Professional Tile Installation Trowels
- 16 Different Notch Sizes
- Hardened, Tempered Blade with Stainless Steel Rivets
- Patented ProForm® Soft Grip Handle
- Order Individually or in Case Cut Displays

<p>No. ST400PF Notch: SQ</p> <p>Spreading adhesives for carpet, tile, sheet vinyl, vinyl tile, VCT rubber and cork. (2mm x 2mm x 2mm)</p>	<p>No. ST401PF Notch: SQ</p> <p>Spreading adhesives for vinyl and rubber cove base and glue-down parquet wood flooring. (3mm x 3mm x 3mm)</p>	<p>No. ST402PF Notch: SQ</p> <p>Spreading adhesives for glue-down engineered and solid wood flooring. (5mm x 5mm x 5mm)</p>	<p>No. ST403PF Notch: SQ</p> <p>Spreading adhesives for glue-down engineered wood flooring. (6mm x 3mm x 6mm)</p>
<p>No. ST404PF Notch: SQ</p> <p>Spreading thinset mortar for ceramic floor tile and laminated wood plank flooring. (6mm x 6mm x 6mm)</p>	<p>No. ST411PF Notch: SQ</p> <p>Spreading thinset for ceramic and quarry tile. ST416PF 16"x4-1/2" (6mm x 9mm x 6mm)</p>	<p>No. ST412PF Notch: SQ</p> <p>Spreading thinset and mortar for large format ceramic and quarry tile. (12mm x 12mm x 12mm)</p>	<p>No. ST405PF Notch: U</p> <p>Spreading adhesives for carpet tile, smooth backed carpet, VCT, felt-back sheet vinyl and vinyl plank. (1mm x 1mm x 2mm)</p>
<p>No. ST406PF Notch: U</p> <p>Spreading adhesives for carpet to cushion in double glue installations. (3mm x 2.2mm x 3mm)</p>	<p>No. ST407PF Notch: U</p> <p>Spreading adhesives for double glue carpet. (3mm x 5mm x 3mm)</p>	<p>No. ST420PF Notch: U</p> <p>Spreading thinset, full contact mortars and thick-bed mortars. (19mm x 14mm x 9mm)</p>	<p>No. ST417PF Notch: U</p> <p>Spreading thinset mortar for floor or wall tiles, or applying adhesives and mastic material. (6mm x 9mm x 6mm)</p>
<p>No. ST408PF Notch: V</p> <p>Spreading adhesives for glue-down engineered wood flooring. (5mm x 4mm)</p>	<p>No. ST409PF Notch: V</p> <p>Spreading adhesives for attached foam and smooth backed carpet. (2.2mm x 2.2mm x 2.2mm)</p>	<p>No. ST410PF Notch: V</p> <p>Spreading adhesives for textured and rough backed carpets. (3mm x 3mm x 2mm)</p>	<p>No. ST414PF Notch: V</p> <p>Spreading mastic for wall tile. (6mm x 5mm)</p>

PROFESSIONAL SPONGES

Sponges (Medium Fine Pore)

Durable polyester-based sponges retain water like natural sponges. Package contains *three* different semi-oval sponges. No. PL060



Grout Sponge

Large water holding capacity. Soft to prevent digging, scratching or marring of grout.

No.	Size
ST135	7-1/2"x5"x2" (Sold 24 per Case Cut Carton)
ST135-125	7-1/2"x5"x2" (Display Box of 125)
ST135BALE	7-1/2"x5"x2" (Bale of 400)

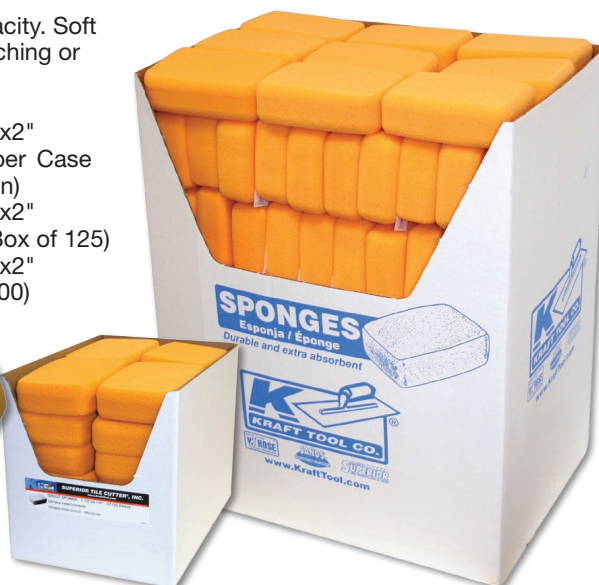

Scouring Pad Holder

Kraft Tool's ProForm® soft grip handle is mounted to the plastic backing plate. Bottom hook strip attaches to scouring pad. This tool helps protect hands when scrubbing. (Must purchase pad separately.)

No.	Size
ST140PF	9-1/4"x3-1/4"

Scouring Pad

Available in non-abrasive or medium abrasive. Ideal for cleaning tile tools.

No.	Size	Description
ST134	10"x4-3/8"x1"	(Blue) Medium abrasive
ST133	10"x4-3/8"x1"	(White) Non-abrasive



Turtle Back Sponge

General purpose, durable cellulose sponge. Keeps its shape and conforms to hand. Holds water exceptionally well, washes clean.

No.	Size
PL600	6-3/4"x3-1/2"x2"
PL600-25	6-3/4"x3-1/2"x2" (Box of 25)
PL600L*	7-1/2"x3-1/2"x2"
PL600L-25*	7-1/2"x3-1/2"x2" (Box of 25)

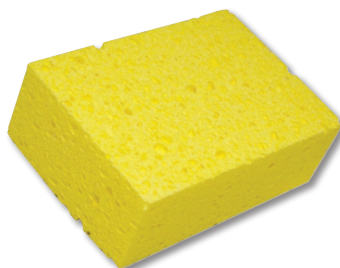

Cellulose Sponge

Durable cellulose keeps its shape. Great for cleaning and all around use.

No.	Size
PL370	6-1/2"x4-1/4"x2-1/4" (Case Cut Carton of 24)



Grout Scrubber Sponge

Hydra sponge on one side to wipe off excess grout. Coarse plastic foam scrubber on opposite side to remove grout haze.

No.	Size
ST137	7-1/2"x5"x2" (Case Cut Carton of 24)
ST137-125	7-1/2"x5"x2" (Display Box of 125)
ST137BALE	7-1/2"x5"x2" (Bale of 200)



Rubber Sponge

Cleaning sponge made of pure natural rubber. Rectangular-shaped to fit your hand.

No.	Size
PL369	6"x3"x1-1/2"



White Rubbing Stone

Top quality rubbing stone is preferred by many tile setters. Will not mark or stain.

No.	Size	Grit
ST281	8"x2"x1"	60
ST282	8"x2"x1"	80



Tile Setter's Rub Brick

Smooth out and dress down tile, marble, granite or concrete with these high quality 6"x2"x1" silicon carbide rub bricks.

No.	Grit	No.	Grit
ST370	46	ST372	80
ST371	60	ST373	120



GROUT FLOATS

Toe Grout Float

The pure gum rubber face is bonded to a molded rubber pad, then cemented to a non-marring backing. The offset position of the handle and its special narrow width makes it possible to work in tight corners. Now available with a non-marring float back. Fitted with wood or ProForm® soft grip float handle.

No.	Size	Handle
ST127	12"x3"	Wood
ST127PF	12"x3"	ProForm®



Epoxy Grout Float

Long-wearing, lightweight float with non-marring plastic handle and back. Dense 1/2" float face ideal for using with epoxy grouts.

No.	Size
ST362*	10"x3-3/4"

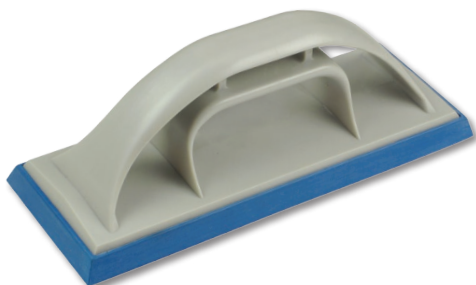

Tile Grouter's Float

The classic float is excellent for tile grouting, but has been adapted for many uses. Flexible pure gum rubber face is bonded to a molded rubber pad. This non-stick surface won't absorb materials, leaving a more professional finish. Beveled sides provide protection and control for grout applications. The front has rounded corners for smooth finishes, while the back has squared off corners providing even coverage into corners. For a guaranteed cleaner finish use the float with the ProForm® handle where a non-marring backing provides support for the tool.

No.	Size	Handle	No.	Size	Handle
ST126	9-1/2"x4"	Wood	ST126PF	9-1/2"x4"	ProForm®
ST132	12"x4"	Wood	ST132PF	12"x4"	ProForm®



Non-Porous Grout Float

The very best non-porous, hard synthetic rubber-faced float for stucco, tile grout, and brown coat. Fitted with wood float handle.

No.	Size
ST128	11-1/2"x5"
ST360	12"x4"



Super Grout Float

A medium weight, firm float for grouting glazed tile on walls or floors. Can also be used for grouting mosaics and plain or abrasive quarry tile. The green pad is cemented to a strong aluminum backing and completed with a smooth wood handle. For a guaranteed cleaner finish use the float with the ProForm® handle where a non-marring backing provides support for the tool. Size 9-1/2"x4".

No.	Handle
ST125	Wood
ST125PF	ProForm®



Margin Grout Float

Professional quality margin grout float with contoured wood handle. Non-marring gum rubber pad is beveled on the sides and mounted to a tempered steel blade. Excellent for compact spaces.

No.	Size
ST353*	6"x2"



Grout Cleaning Brush

Contoured plastic handle with sturdy 3/4" long nylon bristles in 2 by 9 rows. For scrubbing grout and grout lines. Hang hole at the end of handle for easy storage.

No.	Size
ST171	8"



Grout Saw

The preferred tool among tile professionals for grinding, cleaning, and removing old grout. Long-lasting carbide grit blade keeps its sharpness. The second blade is serrated to move the grout dust out of the way. Use both blades for wide joints. Durable ProForm® soft grip handle.

No.	Description
ST147	Grout Saw
ST148*	(2) Repl. Blades



*See page 178

Plastic Bucket and Pail

Durable 90 mil 5 gal. translucent bucket and 10 qt. pail for general uses such as mixing or moving various materials. Lid for 5 gallon bucket sold separately.

5 Gal. Plastic Bucket

Liters, Quarts, Gallons measurements

No.	Description
GG468	5 Gal. Plastic Bucket
GG468-01	Plastic Lid (Fits GG468 5 Gal. Bucket)
GG468-02	Plastic Lid with Spout (Fits GG468 5 Gal. Bucket)

10 Qt. Plastic Pail

Ounces, Liters, Quarts measurements

No.	Description
GG470	10 Qt. Plastic Pail



GG468-02



Bucket Dolly

Easily move heavy buckets. Strong molded plastic construction can be used with standard 3-1/2 to 5 gallon buckets. 300 lb capacity. 5 rubber wheels make this dolly perform well even on unlevel surfaces. 2-1/2" deep walls hold bucket securely. (Bucket not included.)

No. ST379



Stainless Steel Bucket Trowel

Stainless steel blade is tapered to align with sides and bottom of bucket. Leaves no wasted material. Special tang to hang trowel on rim of bucket.

No.	Size
PL800*	7"x4-1/2"x3"

Lid Claw

Open buckets with ease. Durable, one piece plastic construction.

No. DW110



Ultra Rubber Knee Pads

Durable, accordion style rubber knee pads with comfortable foam pad insert. Adjustable, replaceable strap.

No.	Description
WL084*	Knee Pads (pair)
WL084-01*	Replacement Straps



Epoxy Mixing Paddle

Flat steel blade with slots so material flows through and around mixer. Ideal for mixing epoxies, mortars, resins and other construction materials. Plated to resist wear and corrosion. 7/16" hex shaft. Overall length 18". Fits most 1/2" drill motors.

No. DC719

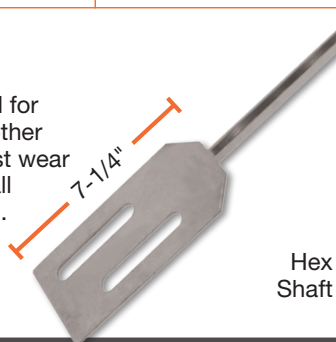

Hex Shaft

Double Bent Mixer

Bent mixing blades provide a bottom-to-top mixing action. Mix urethane and other materials smoothly. Plated to reduce wear and corrosion. 18" hex shaft. 4"x3" blades. Fits most 1/2" drill motors.

No. DC720



Hex Shaft

Unomixer

Ideal for fast mixing of all kinds of materials, from paint to cement. Unique design mixes materials quickly. The 3-1/4" diameter head is welded to the 16" shaft for strength.

For use in a 1/2" drill.

No. DC363*

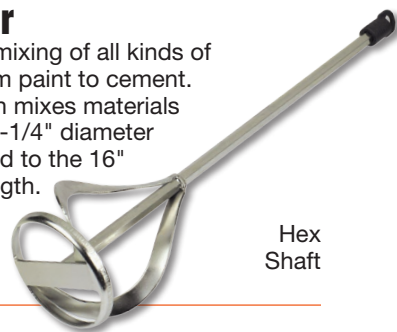

Hex Shaft

Stainless Steel Jiffy Mud and Paint Mixers

For heavy-duty jobs. Fits 5-10 gallon containers. 20-1/2" long, 1/2" shaft,

top diameter 4-5/8", bottom diameter 5", depth 5". Use with 1/2" drill.

No. DC409



Round Shaft

For small containers 2 gallons or less. 10-1/4" long, 1/4" shaft, top diameter 2-5/8", bottom diameter 2-5/8", depth 2-3/8". Use with 3/8" drill at 450-750 RPMS for best results.

No. DC408

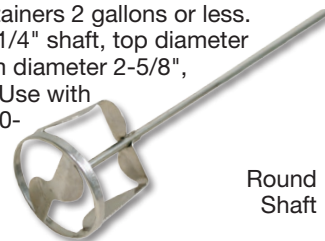

Round Shaft

Egg Beater Mixer

Use to mix thinset, grout and concrete products. Plated steel is easy to use and easy to clean. The 30" overall length of the tool works easily in 5 gallon buckets. The 7/16" steel hex shaft works in 1/2" or larger drills.

No. DC716*



Hex Shaft

Triangle Blade Mixer

Multi-purpose triangle blade mixer. Use with all concrete-based products. Measures 9-1/2" head depth, 23-1/4" overall. For use in a 1/2" drill.

No. DC721

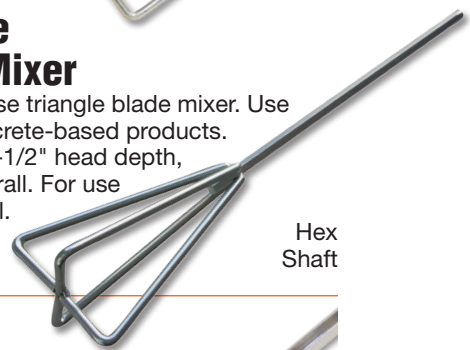

Hex Shaft

Pro Caulk Gun

Professional caulking gun features all steel construction. Easy-to-load barrel swivels to quickly change the angles on corners. Ladder hook keeps the tools handy on the jobsite.

No.	Description
GG279*	10 oz.
GG277*	1 qt.



Miter Snips

Accurately cuts angles in seconds up to 1" wide x 1/2" thick (replaceable blade). Cuts plastic, decorative moldings and tile edges/trim. Adjustable miter fence with built in protractor. 7 preset angles from 45°-135°. Safety lock handle with no slip grip. To change angle, slide the self-indexing metal guide to desired angle.

No.	Description
LA355*	Miter Snips
LA355-01*	Top cutting Replacement Blade



US Patent #6,973,725 B2

T-Handle Floor Scraper

54" long all steel floor scraper. All steel "T" handle with weighted head for extra leverage. Shaves all kinds of floor coverings on any type of floor. Fitted with 7" or 10" replaceable steel blade.

No.	Size
GG393	Floor Scraper With 7" Blade
GG397	Floor Scraper With 10" Blade
GG394	7" Replacement Blade
GG395	10" Replacement Blade



Heavy-Duty Rubber Floor Squeegee

Rugged heavy-duty floor squeegee with all steel construction. Pure gum rubber blade is replaceable and reversible for longer wear. Comes complete with 60" wood handle and ferrule (CC901-02).

No.	Description
GG285	24" Rubber Floor Squeegee
GG286	36" Rubber Floor Squeegee
GG287	24" Rubber Refill
GG288	36" Rubber Refill

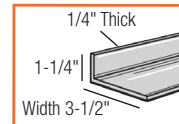

L Shape Screeds / Straightedges

L-shaped screed set is easy to hold and move around to even out surfaces. Made of high strength, lightweight aluminum. Each screed is 3-1/2" wide x 1-1/4" high. The 1/4" thick metal provides strength for leveling. Multiple sizes included in a set for use on a variety of different projects.

No.	Description	Sizes
ST295	5 Piece Set	1-1/2', 2', 3', 4', 6'
ST296	6 Piece Set	1-1/2', 2', 2-1/2', 3', 4', 6'

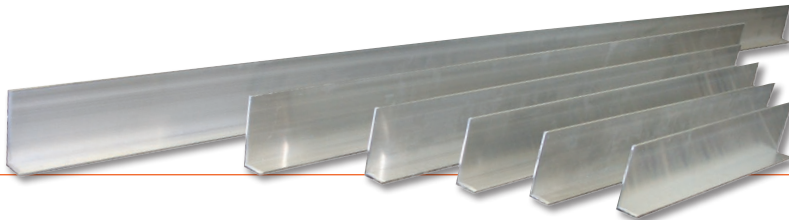

Aluminum Screed Set

Screed set 1" wide x 4" high. Made of high strength lightweight gold anodized aluminum.

No.	Description	Sizes
ST294AL	5 Piece Set	2', 2-1/2', 3', 4-1/2', 6'

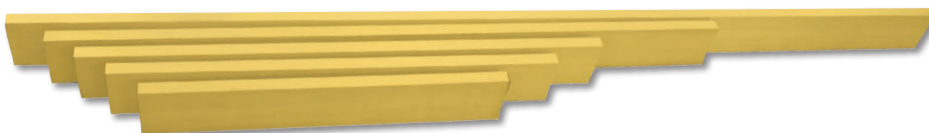

4" Heavy-Duty Scraper

Small, yet forceful scraper provides access to hard to reach places. Easily remove vinyl, ceramic tile and adhesive with less effort. A 4" heavy-duty blade scrapes away at material for remodeling or new construction. The blade is secured to a 9" handle with three tightening screws. A rubber grip provides comfort with use. Overall length is 12" Carded for easy display.

No.	Description
ST298*	4" Heavy-Duty Scraper
ST299*	4" Repl. Wall Scraper Blades (Pkg 5)



Heavy-Duty Scraper

Large metal handle is weighted to produce inertia, for easier scraping. Heavy-duty blade carrier has 3 tightening screws. 15" hammer-end handle ideal for rubber mallet use (see page 148). Includes single 5" replaceable blade.

No.	Description
FC520	Heavy-duty Scraper
FC521	5" Replacement Blades (Pkg 5)



Big Floor Scraper Telescoping Handle

Features an 8" wide heavy-duty replaceable blade, and a twist-lock adjustable telescoping handle. Handle length adjusts from 36" to 59". The perfect tool for floor preparation.

No.	Description
FC506	Big Floor Scraper
FC507	8" Replacement Blades (Pkg 5)



Forged Floor and Wall Scraper 54" All Steel

The perfect scraper for extra tough scraping and cleaning jobs. A 54" steel handle is welded to the solid forged 4" blade. Pry tile, wood flooring and other materials.

No. ST175

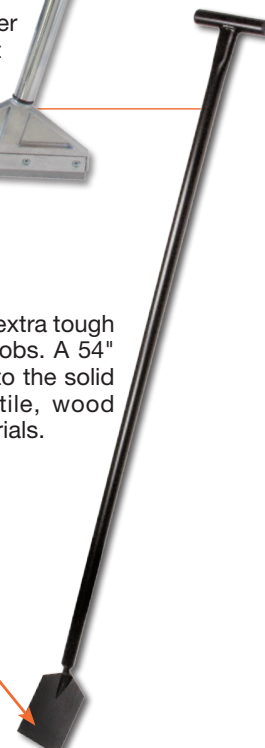

*See page 178

CARPET FLOORING

Carpet Puller

Strong die cast aluminum. Serrated clamping grips for gripping carpet and maximum pulling power. No. FC522*



Wide Stair Tool

Constructed of tough, durable alloy steel to withstand hammering. The blade is ground to a perfect taper so as not to cut the carpet. Nickel plating will not rust. 8" tall.

No. FC510* Blade Size 3-1/2"



Comes complete with power head, 4 extension tubes in a tough, durable heavy-duty plastic case with wheels.

Carpet Power Stretcher

Drive head has adjustable locking head for various lengths of stretching. Stretcher adjusts from 3' to 22'. Adjustment knob on head allows easy adjustment of power pins for various carpet thicknesses. The driving head has an adjustment for partial carpet stretches.

Equipped with 4 standard size extension tubes, interchangeable with other popular models.

No. FC502

Economy Adjustable Knee Kicker

Adjusts from 17-1/2" to 21-1/2" long. Steel pins adjust to depth of carpet.

No. FC500E*



Carpet Seam Roller

5" wide head helps press carpet backing into adhesive for stronger seams.

No. FC532*



Electric Carpet Stapler

Powerful 11 AMP tool drives staples into hardwoods. Jamb-proof magazine holds 100 staples. Features a built-in trigger-lock for safety. The stapler height fits under step-raisers for easy stapling and features a uniquely designed pointed tip.

No. Description

FC535 Stapler Gun

FC536 Staples - 9/16" length divergent points with 3/16" crown. Packed 5,000 per box.



Heat Iron

Low profile tool glides easily under carpets and permits the seams to be joined on the iron, while the adhesive is still hot. "U" shaped handle provides strength and is tapered to slide easily by the seam edges. Heat settings are adjustable from 250° to 350°, for fast seaming. Built-in heat shield protects sensitive pile fibers and synthetic backings. Weighs 3.7 lbs.

No. FC501



Heat Seaming Tape

Create a professional seam every time. Ideal for both commercial and residential use.

Use our special heat seaming iron (FC501) to melt the glue providing a strong durable adhesion to the carpet. 66' long roll.

No. FC530



Deluxe Carpet Knife

Knife is made of cast aluminum with a bright polished surface. Rear-loading blade storage for quick access to extra blades. Must purchase blades separately.

No. Description

FC504 Carpet Knife

FC548* (10) Replacement Blades (slotted)



Utility Push Button Carpet Knife

Perfect for cutting carpet, foam, padding, etc. Knurled handle for a sure grip. Press the button on the handle for fast change and access to blade storage. Uses standard slotted carpet blades. Includes 1 heavy-duty steel blade. Carded for easy display.

No. Description

FC547* Push Button Carpet Knife

FC548* (10) Replacement Blades (slotted)

WOOD FLOORING

Bearcat Stripper Machine

Easily remove flooring products for replacement. The blade carrier forms an ultra-low blade angle to get beneath material to be removed. Cam-driven oscillating cutting system focuses the energy of the motor to the blade. The shearing blade is directly linked to the 1 H.P. motor for fewer parts to wear out. Net weight: 127 lbs.

No.	Description
FC700ZZ**	Bearcat Stripper Machine
FC701ZZ	6"x4" Bearcat Stripper Blade
FC705ZZ	10"x3" Bearcat Stripper Blade

**Must ship via truck



Tapping Block And White Rubber Mallet

This 7"x3" block has female groove on one side and end to install tongue-and-groove planks tightly in place. 30 oz. white rubber mallet head on 10-1/4" solid wood handle; non-marring rubber.

No.	Description
FC550*	Tapping Block
FC551*	Rubber Mallet



Multi-Undercut Saw

Saw cuts along walls, door jambs, toe spaces, and inside corners. Height adjusts in 1/8" increments from flush to 1" above the floor, 1-1/4" depth. Cuts straight or angled with adjustable handle. Comes with carbide blade made specifically for the Multi-Undercut Saw. Carrying case included. 7 AMP 110V motor. Weight 11 lbs.

No.	Description
FC527	Multi-Undercut Saw
FC528	Replacement Carbide Blade (use only with FC527 Multi-Undercut Saw)



Undercut Door Jamb Saw

This is the perfect tool for cutting door jambs and other hard-to-reach areas. 12" long blade. Double-edged blade works in both directions

No. FC518*

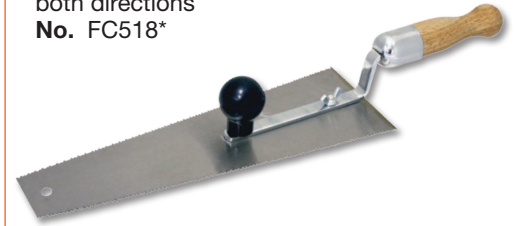

Door Jamb Super Saw

Powerful 13 AMP 110V motor. Saw allows undercutting of doors, door jambs, inside corners and walls. Blade height adjusts from flush to maximum 1". Cuts doors 1-3/4" thick, without removal. Complete with (1) combination and (1) masonry blade, detailed instructions and durable plastic carrying case. Weight 18 lbs. complete.

No.	Description
FC537	Door Jamb Saw
FC538	Carbide-Tipped Blade (use only with FC537 Door Jamb Super Saw)



VINYL FLOORING

Economy Vinyl Tile Cutter

Heavy cutting frame with casters, moveable cutting guide, and marked measuring guide. Cuts 12" tiles straight or 9" tiles diagonally. No. FC512E*

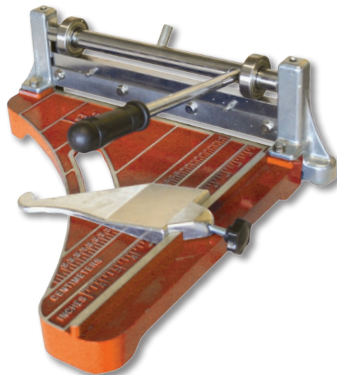

Vinyl Roller

Solid steel construction. The 100 lb. roller has a smooth surface, and rounded corners to protect flooring materials from indentations. Each of the 3 sections "floats" independently and automatically compensates for subfloor irregularities. Handle yoke detaches for easy carrying and storage. Includes hard plastic case to protect roller. Diameter 5-1/4", width 16", height 39".

No. FC511



Vinyl Floor Roller

Great tool for rolling vinyl floor covering, carpet and cove base. Handle telescopes from 18" to 33". Three (3) non-marking rollers are 7-3/8" wide.

No. FC543*



Vinyl Seam Roller

Weighted steel seam roller with 6" wood handle. Roller is flat on shaft side, rounded on outside edge; 2" diameter and 2" wide. Great for finishing work in vinyl installations.

No. FC542*



KRAFT TOOL SHIRTS AND HATS

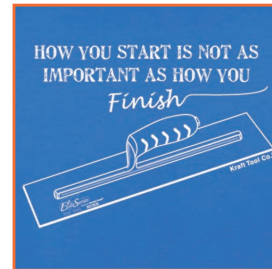

No. KTCSHIRT-C* Kraft Tool Co.® Shirt - Blue (L)
 KTCSHIRT-D* Kraft Tool Co.® Shirt - Blue (XL)
 KTCSHIRT-E* Kraft Tool Co.® Shirt - Blue (XXL)

No. KTCSHIRT-A* Kraft Tool Co.® Shirt - Ash Grey (L)
 KTCSHIRT-B* Kraft Tool Co.® Shirt - Ash Grey (XL)
 KTCSHIRT-F* Kraft Tool Co.® Shirt - Ash Grey (XXL)

Shirt Back

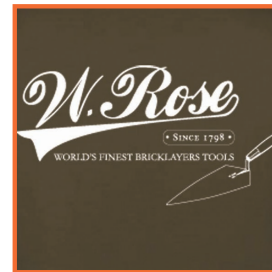

No. KTCSHIRT ROSE-C* W. Rose™ Shirt - Brown (L)
 KTCSHIRT ROSE-D* W. Rose™ Shirt - Brown (XL)
 KTCSHIRT ROSE-E* W. Rose™ Shirt - Brown (XXL)

No. KTCSHIRT ROSE-A* W. Rose™ Shirt - Ash Grey (L)
 KTCSHIRT ROSE-B* W. Rose™ Shirt - Ash Grey (XL)
 KTCSHIRT ROSE-F* W. Rose™ Shirt - Ash Grey (XXL)

Shirt Back



KTCCAP-MESH*
Kraft Ball Cap



KTCCAP*
Kraft Ball Cap



KTCCAP-CAMO*
Kraft Camo Ball Cap



KTCCAP-ROSE*
W. Rose™ Ball Cap

W. Rose™ Ceremonial Trowels

Ideal for retirements, award presentations and other special occasions.

No.	Description
RO316-10G	Gold
RO316-10C	Chrome



W. Rose™ Shot Glass Holder With Shot Glasses

A party novelty for work functions, or makes a great gift for the fun-loving mason. Includes 3 thick glass W. Rose™ shot glasses.

No.	Description
RO55SHOTGLASS	Trowel and 3 Shot Glasses

