

AIR CONDITIONING PRODUCTS

PRIMATECH[®]

PREMIER HIGHWAY PRODUCTS

PRODUCT	PAGES
Compressors	3 - 9
Clutches	10 - 11
Condensers / Condenser Tech Tip	12 - 13
Blowers	14
Expansion Valves	15
Accumulators / Receiver Driers	16 - 17
Heater Core / Evaporators	17
Accessories / Switches	18
Orifice Tubes / Lubes	19
Service Kits & Kit Components	20 - 23
Cross Reference	24 - 32
Part To Page Reference	33
PrimaTech Warranty	34
Compressor Replacement Process	35



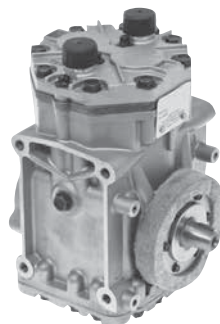

PTAC5256

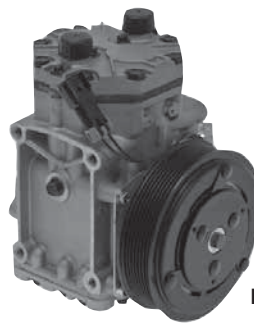

PTAC5269

PN	DESCRIPTION	OIL TYPE	GROOVES	VOLT	MOUNT	PORT TYPE
PTAC5256	COMP YORK ET210L	ESTER PAG 100	W/O	12	DIRECT	TUBE O-RING
PTAC5269	CCI COMP 2W CLUTCH	ESTER PAG 100	8	12	DIRECT	TUBE O-RING

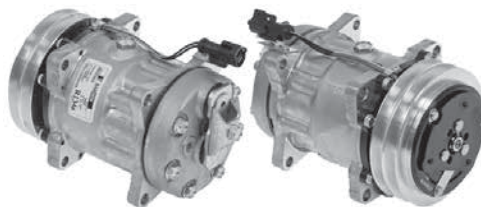

PN	DESCRIPTION	OIL TYPE	GROOVES	VOLT	MOUNT	PORT TYPE
PTAC5320	SANDEN 2GR SJHEAD	PAG 100	2	12	EAR	PAD

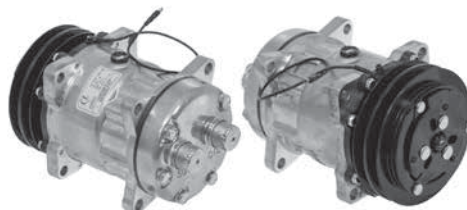

PN	DESCRIPTION	OIL TYPE	GROOVES	VOLT	MOUNT	PORT TYPE
PTAC5327	SANDEN	PAG 100	2	12	EAR	HTO



PN	DESCRIPTION	OIL TYPE	GROOVES	VOLT	MOUNT	PORT TYPE
PTAC5333	COMP SD7H15 PV8 119MM DIRECT MOUNT 12V GH HEAD	PAG 100	8	12	DIRECT	PAD

ATTENTION: The replacement of a compressor requires installation of a new receiver drier/accumulator and the system to be flushed per the manufacturer's guidelines. See page 35 for additional warranty information.

COMPRESSORS

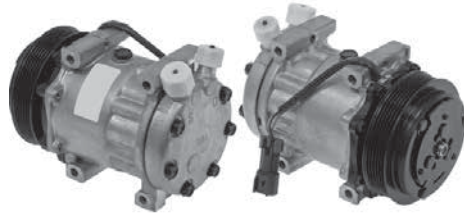

PN	DESCRIPTION	OIL TYPE	GROOVES	VOLT	MOUNT	PORT TYPE
PTAC5339	COMP SD7H15 4883 12V DIRECT MOUNT VOR PV6 125MM	PAG 100	6	12	DIRECT	VERTICAL O-RING



PN	DESCRIPTION	OIL TYPE	GROOVES	VOLT	MOUNT	PORT TYPE
PTAC5347	COMP SD7H15 PV6 12V 125MM NAVISTAR TANG GWA 2WIRE	PAG 100	8	12	DIRECT	PAD



PN	DESCRIPTION	OIL TYPE	GROOVES	VOLT	MOUNT	PORT TYPE
PTAC5348	COMP SD7H15 DM PV8 12V 119MM NAVISTAR GWA 2 WIRE	PAG 100	8	12	DIRECT	PAD



PN	DESCRIPTION	OIL TYPE	GROOVES	VOLT	MOUNT	PORT TYPE
PTAC5362	COMP SD7H15 4039 PV6 125MM 12V GA HEAD	PAG 100	6	12	DIRECT	PAD

ATTENTION: The replacement of a compressor requires installation of a new receiver drier/accumulator and the system to be flushed per the manufacturer's guidelines. See page 35 for additional warranty information.

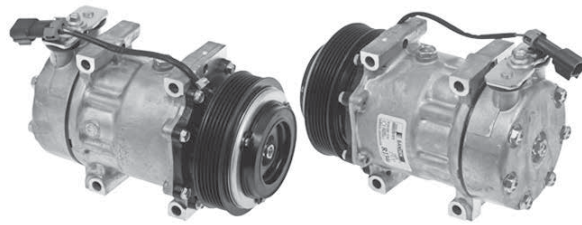

PN	DESCRIPTION	OIL TYPE	GROOVES	VOLT	MOUNT	PORT TYPE
PTAC5362SD	SANDEN SUPRHD COMP/PACCAR	PAG 100	8	12	DIRECT	PAD

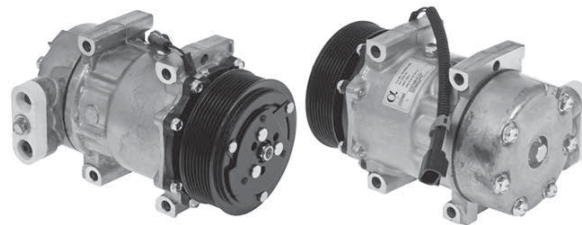

PN	DESCRIPTION	OIL TYPE	GROOVES	VOLT	MOUNT	PORT TYPE
PTAC5365	COMP SD7H15SHD 4042 PV8 119MM 12V GQ HEAD	PAG 100	8	12	DIRECT	PAD

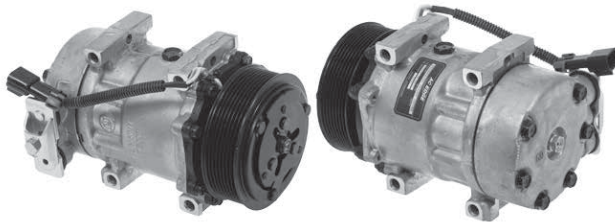

PN	DESCRIPTION	OIL TYPE	GROOVES	VOLT	MOUNT	PORT TYPE
PTAC5365SD	SANDEN SUPRHD COMP/PACCAR	PAG 100	8	12	DIRECT	PAD

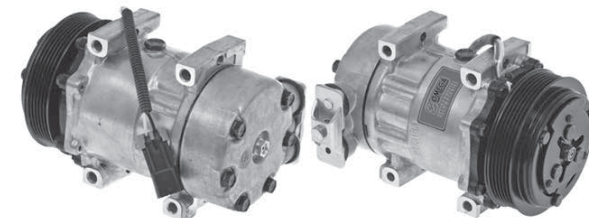

PN	DESCRIPTION	OIL TYPE	GROOVES	VOLT	MOUNT	PORT TYPE
PTAC5366	COMP SD7H15 4040 PV6 125MM 12V GQ HEAD	PAG 100	6	12	DIRECT	PAD

ATTENTION: The replacement of a compressor requires installation of a new receiver drier/accumulator and the system to be flushed per the manufacturer's guidelines. See page 35 for additional warranty information.

COMPRESSORS

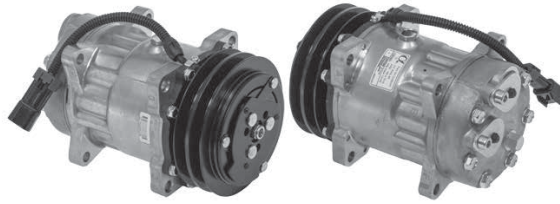

PN	DESCRIPTION	OIL TYPE	GROOVES	VOLT	MOUNT	PORT TYPE
PTAC5384	SANDEN	PAG 100	2	12	EAR	VOR

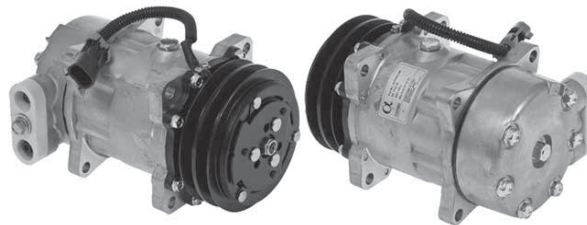

PN	DESCRIPTION	OIL TYPE	GROOVES	VOLT	MOUNT	PORT TYPE
PTAC5373	COMP SD7H15 4041 2AG 125MM 12V GQ HEAD	PAG 100	2	12	EAR	PAD

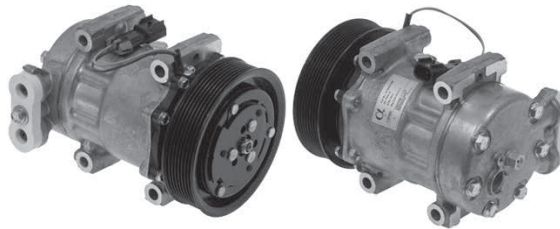

PN	DESCRIPTION	OIL TYPE	GROOVES	VOLT	MOUNT	PORT TYPE
PTAC5398	SD7H15 SUPR-HD COMPRESSOR FRTLNR	PAG 100	8	12	DIRECT	VPAD



PN	DESCRIPTION	OIL TYPE	GROOVES	VOLT	MOUNT	PORT TYPE
PTAC5385	COMP SD7H15 4493 HPAD 132MM PV8 DIR 12V	PAG 100	8	12	DIRECT	PAD

ATTENTION: The replacement of a compressor requires installation of a new receiver drier/accumulator and the system to be flushed per the manufacturer's guidelines. See page 35 for additional warranty information.

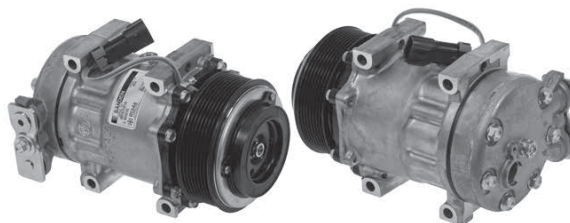

PN	DESCRIPTION	OIL TYPE	GROOVES	VOLT	MOUNT	PORT TYPE
PTAC5395	SD7H15 SHD COMPRESSOR FRTLNR	PAG 100	8	12	DIRECT	VPAD

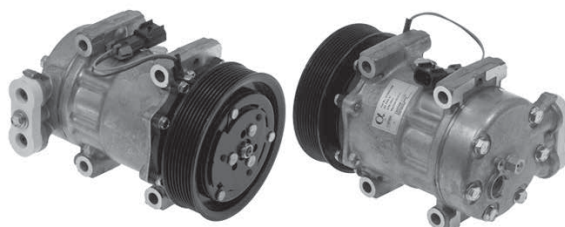

PN	DESCRIPTION	OIL TYPE	GROOVES	VOLT	MOUNT	PORT TYPE
PTAC5398	SD7H15 SUPR-HD COMPRESSOR FRTLNR	PAG 100	8	12	DIRECT	VPAD



PN	DESCRIPTION	OIL TYPE	GROOVES	VOLT	MOUNT	PORT TYPE
PTAC5402	SANDEN SUPR-HD COMP 12GR 12V	PAG 100	12	12	DIRECT	PAD

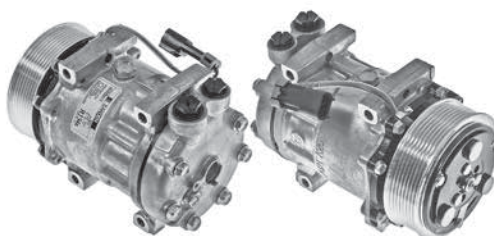

PN	DESCRIPTION	OIL TYPE	GROOVES	VOLT	MOUNT	PORT TYPE
PTAC5403	SANDEN COMPRESSOR SD 4307	PAG 100	8	12	DIRECT	PAD

ATTENTION: The replacement of a compressor requires installation of a new receiver drier/accumulator and the system to be flushed per the manufacturer's guidelines. See page 35 for additional warranty information.

COMPRESSORS

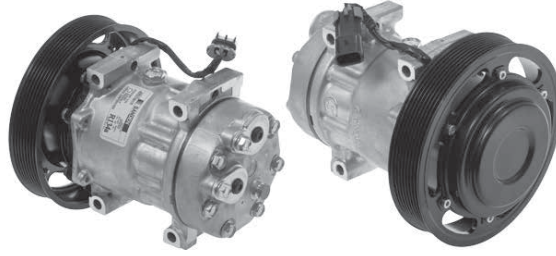

PN	DESCRIPTION	OIL TYPE	GROOVES	VOLT	MOUNT	PORT TYPE
PTAC5404	COMP SD7H15SHD 4042 PV8 119MM 12V GQ HEAD	PAG 100	8	12	DIRECT	PAD

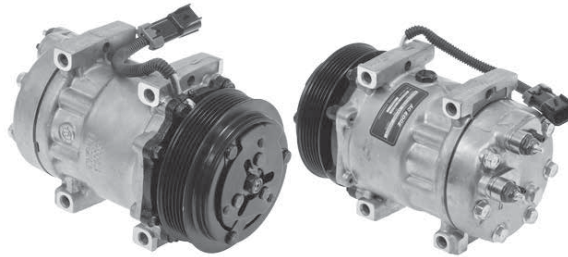

PN	DESCRIPTION	OIL TYPE	GROOVES	VOLT	MOUNT	PORT TYPE
PTAC54546	SANDEN SUPRHD COMP/PACCAR	PAG 100	6	12	DIRECT	PAD

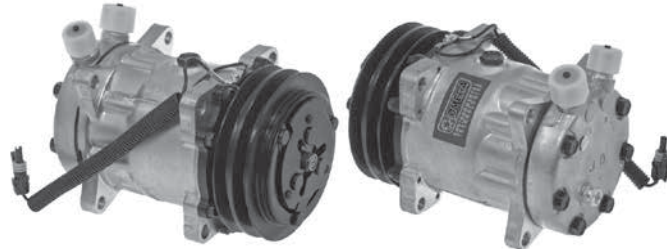

PN	DESCRIPTION	OIL TYPE	GROOVES	VOLT	MOUNT	PORT TYPE
PTAC5764	COMP SD7H15 4647 VOR 132MM 2A 12V NO DIODE	PAG 100	2	12	EAR	VERTICAL O-RING

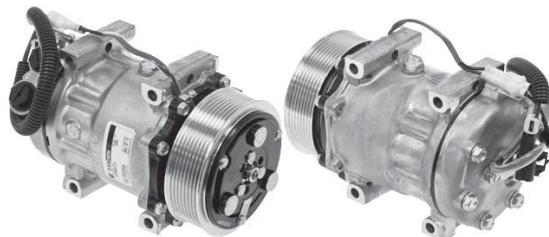

PN	DESCRIPTION	OIL TYPE	GROOVES	VOLT	MOUNT	PORT TYPE
PTAC5770	COMP SD7H15 4041 2AG 125MM 12V GQ HEAD	PAG 100	2	12	EAR	PAD

ATTENTION: The replacement of a compressor requires installation of a new receiver drier/accumulator and the system to be flushed per the manufacturer's guidelines. See page 35 for additional warranty information.

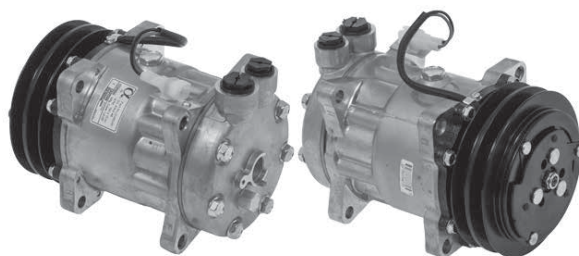

PN	DESCRIPTION	OIL TYPE	GROOVES	VOLT	MOUNT	PORT TYPE
PTAC5771	COMP SD7H15 4603/4469 FORD F-700 TRUCK 94-99 W CL	PAG 100	2	12	EAR	PAD



PN	DESCRIPTION	OIL TYPE	GROOVES	VOLT	MOUNT	PORT TYPE
PTAC5923A	TM16 DIR.MT. COMP W/120MM 8G	PAG 46	8	12	DIRECT	PAD

ATTENTION: The replacement of a compressor requires installation of a new receiver drier/accumulator and the system to be flushed per the manufacturer's guidelines. See page 35 for additional warranty information.

CLUTCHES



PN	DESCRIPTION	GROOVES	VOLT
PTAC5030	CLUTCH YORK PV6 12V	POLY GROOVE 6	12



PN	DESCRIPTION	GROOVES	VOLT
PTAC5031	CLUTCH YORK TYPE 12V 6 IN .50 SINGLE GROOVE	1	12

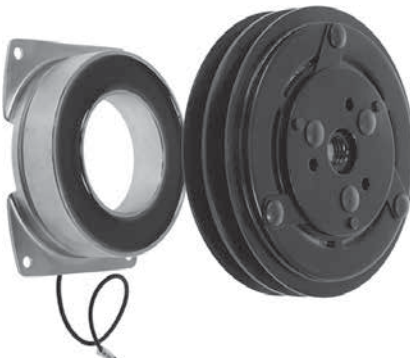

PN	DESCRIPTION	GROOVES	VOLT
PTAC5044	CLUTCH YORK 6 IN 2A 12V 3 SPRING W/BULLET TERMINAL	2	12



PN	DESCRIPTION	GROOVES	VOLT
PTAC5128	CLUTCH YORK PV8 12V 2WIRE 155MM GROOVE DIAMETER	POLY GROOVE 8	12

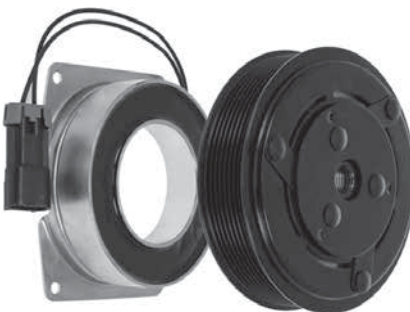

PN	DESCRIPTION	GROOVES	VOLT
PTAC5129	CLUTCH PV6 6 IN 2V 2 WIRE YORK COMP	POLY GROOVE 6	12

PN	DESCRIPTION	GROOVES	VOLT
PTAC5131	CLUTCH HD TRUCK 6 IN 1GR 12V	1	12



PN	DESCRIPTION	GROOVES	VOLT
PTAC5144	CLUTCH HD 6 IN 3 SPRING YORK 12V W/PACKARD TERMINAL	2	12



PN	DESCRIPTION	GROOVES	VOLT
PTAC5145	CLUTCH YORK 2A 6 IN W/2 WIRE COIL	2	12



PN	DESCRIPTION	GROOVES	VOLT
PTAC5164	SD7 6GR 2W KEY/DIODE	6	12



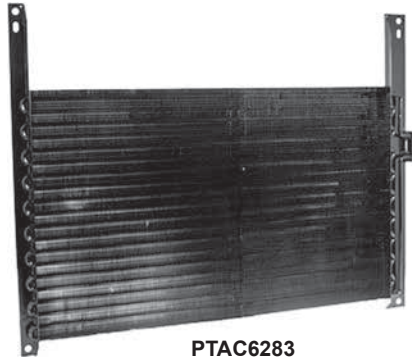

PTAC6283



PTAC6288

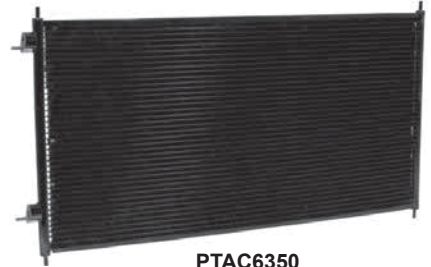

PTAC6350



PTAC6319

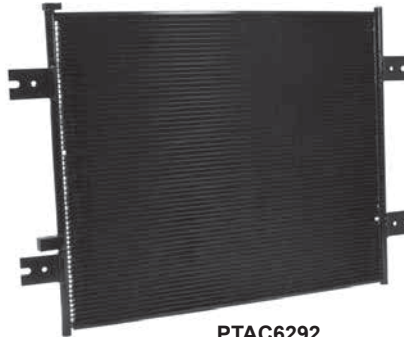

PTAC6292



PTAC6368



PTAC6345

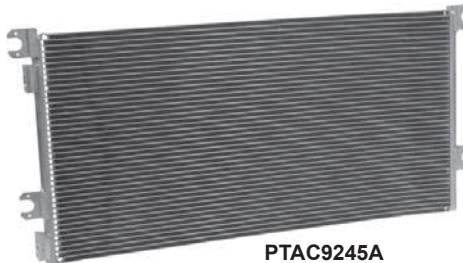

PTAC9245A

PN	DESCRIPTION	TYPE	HEIGHT	LENGTH	DEPTH
PTAC6283	A/C CONDENSER/ NAVISTAR	PF	508MM	864MM	25MM
PTAC6288	A/C CONDENSER	PF	616MM	540MM	19MM
PTAC6292	CONDENSER/PETERBILT	PF	775MM	616MM	19MM
PTAC6319	CONDENSER/FRTLINER COLUMBIA	PF	495MM	875MM	20MM
PTAC6345	CONDENSER/2009 FREIGHTLINER	PF	562MM	876MM	19MM
PTAC6350	CONDENSER/NAVISTAR PROSTAR	PF	828MM	425MM	19MM
PTAC6368	CONDENSER/NAVISTAR	PF	517MM	616MM	19MM
PTAC9245A	VOLVO CONDENSER/PF ALUM TYPE	PF	412MM	812MM	19MM

Technical Tip For Late Models

Late Model Condensers Cannot Be Flushed . . . Only Replaced

3/8" Tube & Fin

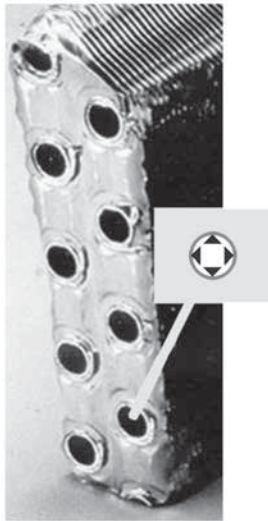

First OEM and
aftermarket design
R-12 ONLY!

First Generation
Serpentine

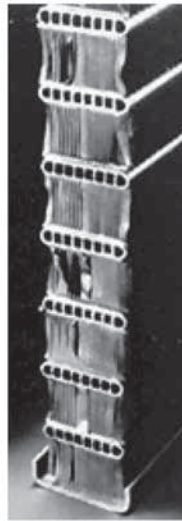

First high efficiency design
used later in R-12 & early
R-134a systems.

Second Generation
Serpentine

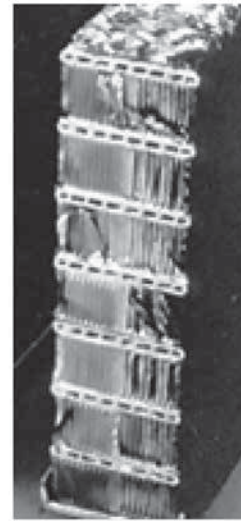

More passages closer
together. CANNOT be
flushed completely!

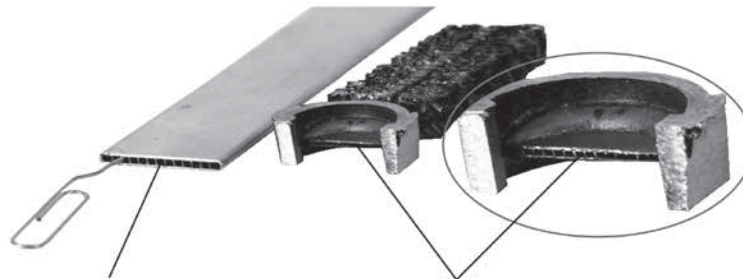

First Generation
Parallel Flow Condenser

Second Generation
Parallel Flow Condenser

The parallel flow condenser is by far the most efficient condenser to use with R134-a refrigerant. The multi-channel construction and multiple passes the refrigerant makes through the condenser allows maximum heat transfer. The smaller tubes and wide surface area allows the most refrigerant to come in contact with air flowing through the condenser fins.

The reasons for this efficiency is also one of its major drawbacks. These small tubes that efficiently transfer heat are so small that they trap any trash in the system that tries to pass through them. Flushing will not remove the trash from the condenser. This trash will create a restriction in the condenser and make the high side pressures go up. This forces the compressor to work harder and possibly fail. Trash in the condenser can also work itself free and end up at the compressor where it will also cause a failure.

If there is a situation where the system needs to be flushed we strongly recommend changing the condenser. This will cut down on comebacks and also will help extend the life of the AC system.

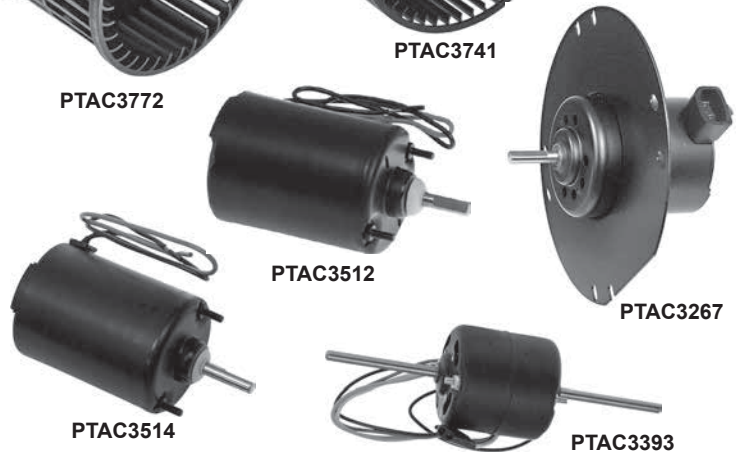
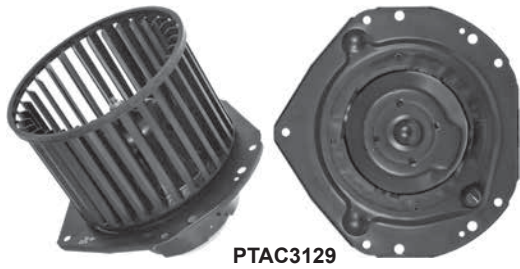
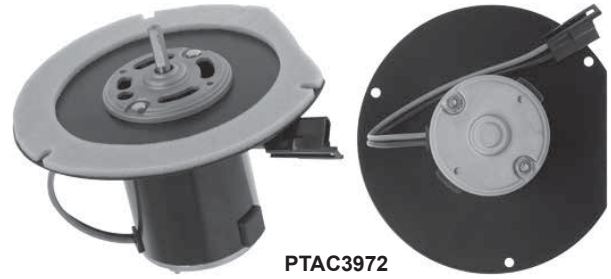
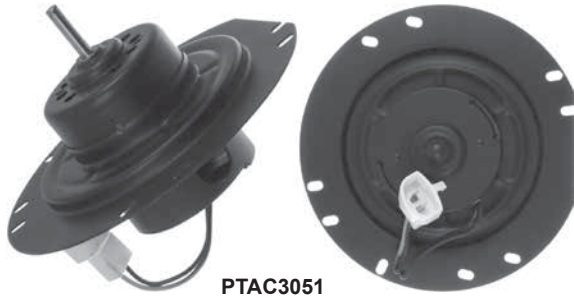

PN	DESCRIPTION	VOLT	HEIGHT	WIDTH	SHAFT DIAM.	ROT.	SHAFT LEN.	# OF SPEEDS
PTAC3051	BLOWER MOTOR FORD	12	4.5	3.25	5/16	CW	1-JAN	1
PTAC3129	BLOWER MOTOR GMC	12	3.375	3.125	5/16	CW	1.4375	1
PTAC3267	BLOWER MOTOR FORD	12	4.5	3.25	5/16	CW	1.625	1
PTAC3393	BLOWER MOTOR	12	4.625	3	5/16	CW	3.3125	3
PTAC3512	BLOWER MOTOR	12	4.625	3	5/16	CW	1.75	1
PTAC3514	BLOWER MOTOR	24	4.625	3	5/16	CW	1.75	1
PTAC3741	BLOWER WHEEL	—	6	3	5/16	CCW	—	—
PTAC3772	BLOWER WHEEL	—	4.5"	3 3/8"	5/16	DUAL	—	—
PTAC3941	BLR MOTOR ASSEMBLY NAVISTAR/PROSTAR	12	6.5	7.875	5/16	CW	1.875	1
PTAC3972	BLOWER MOTOR PETERBILT	12	2.09	3	5/16	CW	2.09	1



PTAC1600



PTAC1602



PTAC1612



PTAC1614



PTAC1619



PTAC1621



PTAC1622



PTAC1632



PTAC1672

PN	DESCRIPTION	FIT	TONS BLOCK	REFRIG.	LIQUID INLET	LIQUID OUTLET	SUCTION INLET	SUCTION OUTLET
PTAC1600	3/8 X 1/2 X 1/2 X 5/8 2T	O-RING	2	R134a	3/8"	1/2"	1/2"	5/8"
PTAC1602	3/8 X 1/2 X 5/8 X 5/8 2T	O-RING	2	R134a	3/8"	1/2"	5/8"	5/8"
PTAC1612	NAVISTAR CLASS 8	FLANGE	1.5	R134a	3/8"	1/2"	1/2"	5/8"
PTAC1614	EXPANSION VALVE	O-RING	2	R134a	3/8"	1/2"	5/8"	3/4"
PTAC1619	FREIGHTLINER	STAT SEAL	1.5	R134a	3/8"	1/2"	5/8"	3/4"
PTAC1621	FREIGHTLINER CENTURY COLUMBIA 02-05	STAT SEAL	1	R134a	3/8"	1/2"	5/8"	5/8"
PTAC1622	VOLVO - NAVISTAR	O-RING	2	R134a	3/8"	1/2"	5/8"	3/4"
PTAC1632	FRT. CORONADO	STAT SEAL	2	R134a	3/8"	3/8"	5/8"	3/4"
PTAC1672	VOLVO - NAVISTAR	O-RING	2	R134a	3/8"	1/2"	5/8"	5/8"

ACCUMULATORS / RECEIVER DRIERS

PN	DESCRIPTION
PTAC7126	A/C DRIER

DIAMETER: 3"
 LENGTH: 6.25"
 FITTING INCHES: 3.8"
 SIGHT GLASS: N
 SERVICE VALVE: N
 MOISTURE INDICATOR: N
 FITTING OUT: 3.8"



PTAC7126

PN	DESCRIPTION
PTAC7141	A/C DRIER

DIAMETER: 3"
 LENGTH: 8.25"
 FITTING INCHES: 3/8 MIO
 SIGHT GLASS: N
 SERVICE VALVE: N
 MOISTURE INDICATOR: N
 FITTING OUT: 3/8 MIO



PTAC7141

PN	DESCRIPTION
PTAC7159	VOLVO/GM TRUCK 3 IN X 9.18 IN 3/8 IN

DIAMETER: 3"
 LENGTH: 9.25"
 FITTING INCHES: 3/8 MIO
 SIGHT GLASS: TOP
 SERVICE VALVE: TOP
 MOISTURE INDICATOR: TOP
 FITTING OUT: 3/8 MIO



PTAC7159

PN	DESCRIPTION
PTAC7169	94 & UP KENWORTH OEM# PH08833500

DIAMETER: 3"
 LENGTH: 10"
 FITTING INCHES: 3/8 MIO
 SIGHT GLASS: TOP
 SERVICE VALVE: TOP
 MOISTURE INDICATOR: TOP
 FITTING OUT: 3/8 FO



PTAC7169

PN	DESCRIPTION
PTAC7197	FREIGHTLINER #ABP-N83-319744

DIAMETER: 3"
 LENGTH: 10"
 FITTING INCHES: PAD
 SERVICE VALVE: 2 SIDE MIO
 FITTING OUT: PAD



PTAC7197

PN	DESCRIPTION
PTAC7230	94 & UP KENWORTH OEM# PH08833500

DIAMETER: 3"
 LENGTH: 10"
 FITTING INCHES: 11/16 FO
 SIGHT GLASS: TOP
 SERVICE VALVE: TOP
 FITTING OUT: 3/8 FO



PTAC7230

PN	DESCRIPTION
PTAC7387	KENWORTH TRUCK 251-571 3/8 FOR X 3/8 MIO

DIAMETER: 3"
 LENGTH: 10"
 FITTING INCHES: 3/8 FO
 SIGHT GLASS: TOP
 FITTING OUT: 3/8 MIO



PTAC7387

PN	DESCRIPTION
PTAC7415	ACCUMULATOR/ NAVISTAR

DIAMETER: 2.5"
 LENGTH: 14"
 FITTING INCHES: QD
 SIGHT GLASS: N
 SERVICE VALVE: N
 FITTING OUT: QD



PTAC7415



PTAC7416

PN	DESCRIPTION
PTAC7416	ACCUMULATOR/ NAVISTAR PROSTAR

DIAMETER: 4.5"
LENGTH: 6.25"
FITTING INCHES: PAD
SIGHT GLASS: N
SERVICE VALVE: N
FITTING OUT: PAD



PTAC7417

PN	DESCRIPTION
PTAC7417	ACCUMULATOR/ NAVISTAR

DIAMETER: 3"
LENGTH: 6.3"
FITTING INCHES: 3/8" FOR
SIGHT GLASS: N
SERVICE VALVE: N
MOISTURE INDICATOR: N
FITTING OUT: PAD



PTAC7493

PN	DESCRIPTION
PTAC7493	FORD GENERIC ACCUMULATOR

DIAMETER: 3.5"
LENGTH: 8"
FITTING INCHES: 5/8" MOR
SIGHT GLASS: N
SERVICE VALVE: N
MOISTURE INDICATOR: N
FITTING OUT: 3/4" MOR



PTAC7555

PN	DESCRIPTION
PTAC7555	DRIER/R9777

DIAMETER: 3"
LENGTH: 6.25"
FITTING INCHES: 3/8 MO
SIGHT GLASS: N
SERVICE VALVE: N
FITTING OUT: 3/8 MO



PTAC7585

PN	DESCRIPTION
PTAC7585	DRIER/2010-11 FRTLINER

DIAMETER: 4"
LENGTH: 6"
FITTING INCHES: PAD
SIGHT GLASS: N
SERVICE VALVE: N
FITTING OUT: PAD

FITTING IDENTIFICATION:



MALE INSERT
O-RING



FEMALE
INSERT O-RING



PAD

HEATER CORE / EVAPORATORS

PN	DESCRIPTION	
PTAC6948	HEATER CORE NAVISTAR	HEIGHT: 314mm WIDTH: 193mm DEPTH: 38mm
PTAC6609	A/C EVAPORATOR NAVISTAR	HEIGHT: 250mm WIDTH: 331mm DEPTH: 65mm
PTAC6636	A/C EVAPORATOR FORD	HEIGHT: 199mm WIDTH: 267mm DEPTH: 92mm

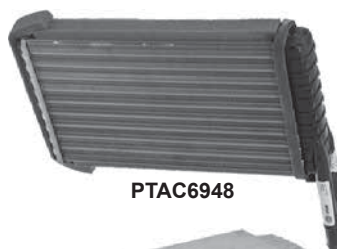

PTAC6948



PTAC6636

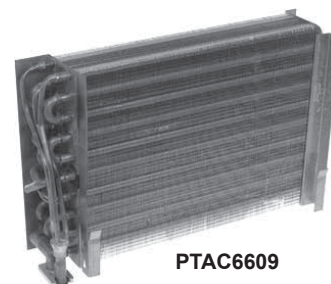

PTAC6609

ACCESSORIES / SWITCHES

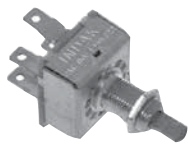

PTAC1150



PTAC1223P

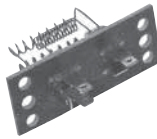

PTAC1224



PTAC1233



PTAC1248



PTAC1342



PTAC2104



PTAC2386



PTAC5513



PTAC5514



PTAC8916

ACCESSORIES

PN	DESCRIPTION
PTAC1150	ROTARY SWITCH W/LONG THREADS
PTAC1220	RESISTOR - 3 TERMINAL
PTAC1223P	BLOWER RESISTOR/OE PET STYLE
PTAC1224	RESISTOR
PTAC1233	RESISTOR - 3 TERMINAL
PTAC1243	RESISTOR/NAVISTAR
PTAC1248	BLOWER RESISTOR/FORD
PTAC1342	A/C THERMOSTAT - PRESET
PTAC2104	WATER VALVE, CABLE
PTAC2386	HTR ACTUATOR/NAVISTAR
PTAC5513	SVC VALVE-#8 TUBE-O DISCH
PTAC5514	SVC VALVE-#10 TUBE-O SUCT
PTAC8916	R134A HIFLOW VALVE CORES/10

SWITCHES



PTAC1265



PTAC1293



PTAC1324



PTAC1437



PTAC1439



PTAC1459



PTAC1489



PTAC1492



PTAC1493



PTAC1498



PTAC1513



PTAC1514



PTAC1515

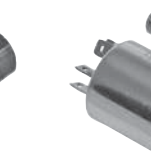

PTAC1550 / PTAC1560



PTAC1565

PN	DESCRIPTION
PTAC1265	70A RELAY/STERLING TRUCKS
PTAC1293	70 AMP 4 TERMINAL CARRIER/TR
PTAC1324	SWITCH/STERLING/FRTLINER
PTAC1437	HIGH PRESSURE SWITCH -NO
PTAC1439	HIGH PRESSURE SWITCH -NC
PTAC1459	PR.SWITCH/94-95 KW T600 K301
PTAC1489	HP SWITCH/NAVISTAR
PTAC1492	HIGH PRESSURE SWITCH
PTAC1493	LOW PRESSURE SWITCH
PTAC1498	HIGH PRESSURE SWITCH
PTAC1499	HIGH PRESSURE SWITCH -NO
PTAC1513	BINARY SW., FEMALE, R134A
PTAC1514	BINARY SWITCH/FREIGHTLINER
PTAC1515	BINARY SWITCH/KW K301-370-1
PTAC1519	LOW PRESSURE SWITCH/KENWORTH
PTAC1546	PRESSURE SWITCH PIGTAIL 2-W
PTAC1550	TRINARY SW. MALE, NO
PTAC1560	TRINARY SW. FEMALE, NO
PTAC1565	TRINARY SW. FEMALE, NC

ORIFICE TUBES

PN	DESCRIPTION
PTAC1651	ORIFICE TUBE - BLUE
PTAC1652	ORIFICE TUBE - ORANGE
PTAC1654	ORIFICE TUBE - RED
PTAC1662	ORIFICE TUBE, NAVISTAR
PTAC1663	ORIFICE TUBE - B/W .072"



PTAC1651



PTAC1651



PTAC1654



PTAC1662



PTAC1663

LUBES

PN	DESCRIPTION
PTAC8202	A/C RETRO OIL - 12 OZ
PTAC8203	A/C RETRO OIL - 32 OZ
PTAC8206	A/C PAG100 OIL - 8 OZ
PTAC8207	A/C PAG46 OIL - 8 OZ
PTAC8208	A/C PAG150 OIL - 8 OZ
PTAC8227	A/C PAG100 OIL - 32 OZ
PTAC8228	A/C PAG100 OIL - GALLON
PTAC8229	A/C PAG150 OIL - 32 OZ
PTAC8230	A/C PAG150 OIL - GALLON
PTAC8248	SANDEN PAG OIL - 8.45 OZ
PTAC8256	A/C VACUUM PUMP OIL - QUART
PTAC8811	A/C FLUSH - PREMIUM - GALLON
PTAC8812	A/C FLUSH SOLVENT - QUART



PTAC8202

PTAC8206

PTAC8207



PTAC8248



PTAC8256



PTAC8812



PTAC8811



PTAC8229



PTAC8227

SERVICE KITS

MASTER KIT

Includes the four kits below plus the storage container.

KIT FEATURES:

- **BOX 1 PTACMT9660**
Compressor Ports & Line Connection O-Rings 48 PN's
- **BOX 2 PTACMT9661**
Sealing Washers HD Trucks & O-Rings Sprinter Van 35 PN's
- **BOX 3 PTACMT9662**
Sealing Washer & Metal Gaskets 23 PN's
- **BOX 4 PTACMT9663**
Orifice Tubes & Orifice Tube Repair Kit 12 PN's

PN: PTACMT9260

Includes 88 PN's - 575 Pieces



COVERAGE & USAGE:

- Medium and Heavy Duty Truck Coverage 2013 - 1994!
- Most Commonly Used A/C Small Parts on Medium to Heavy Duty Trucks!
- Kit in Kit - Color Code Sections to Organize Components for easy Identification!
- Section for Sprinter Van 2013 - 2004
- Coverage Includes: Navistar, Mack, Freightliner, Peterbilt, Ford / Sterling, GM / Volvo, Sprinter Van, Dodge, Mercedes

PN: PTACMT9660

Includes 48 PN's - 306 Pieces

COMMON PORTS						SPRINTER VAN 2013 - 2004					
PTACMT0001	PTACMT0002	PTACMT0003	PTACMT0004	PTACMT0005	PTACMT0006	PTACMT0007	PTACMT0008	PTACMT0009	PTACMT0010	PTACMT0011	PTACMT0012
PTACMT0013	PTACMT0014	PTACMT0015	PTACMT0016	PTACMT0017	PTACMT0018	PTACMT0019	PTACMT0020	PTACMT0021	PTACMT0022	PTACMT0023	PTACMT0024
COMMON HEADS						FORD SPRINGLOCK					
PTACMT0025	PTACMT0026	PTACMT0027	PTACMT0028	PTACMT0029	PTACMT0030	PTACMT0031	PTACMT0032	PTACMT0033	PTACMT0034	PTACMT0035	PTACMT0036
PTACMT0037	PTACMT0038	PTACMT0039	PTACMT0040	PTACMT0041	PTACMT0042	PTACMT0043	PTACMT0044	PTACMT0045	PTACMT0046	PTACMT0047	PTACMT0048
COMMON FLARE NUTS						COMMON FLARE NUTS					
PTACMT0049	PTACMT0050	PTACMT0051	PTACMT0052	PTACMT0053	PTACMT0054	PTACMT0055	PTACMT0056	PTACMT0057	PTACMT0058	PTACMT0059	PTACMT0060
PTACMT0061	PTACMT0062	PTACMT0063	PTACMT0064	PTACMT0065	PTACMT0066	PTACMT0067	PTACMT0068	PTACMT0069	PTACMT0070	PTACMT0071	PTACMT0072

PN: PTACMT9661

Includes 35 PN's - 150 Pieces

SPRINTER VAN 2013 - 2004						COMMON HEADS					
PTACMT0073	PTACMT0074	PTACMT0075	PTACMT0076	PTACMT0077	PTACMT0078	PTACMT0079	PTACMT0080	PTACMT0081	PTACMT0082	PTACMT0083	PTACMT0084
PTACMT0085	PTACMT0086	PTACMT0087	PTACMT0088	PTACMT0089	PTACMT0090	PTACMT0091	PTACMT0092	PTACMT0093	PTACMT0094	PTACMT0095	PTACMT0096
COMMON HEADS						COMMON HEADS					
PTACMT0097	PTACMT0098	PTACMT0099	PTACMT0100	PTACMT0101	PTACMT0102	PTACMT0103	PTACMT0104	PTACMT0105	PTACMT0106	PTACMT0107	PTACMT0108
PTACMT0109	PTACMT0110	PTACMT0111	PTACMT0112	PTACMT0113	PTACMT0114	PTACMT0115	PTACMT0116	PTACMT0117	PTACMT0118	PTACMT0119	PTACMT0120
COMMON HEADS						COMMON HEADS					
PTACMT0121	PTACMT0122	PTACMT0123	PTACMT0124	PTACMT0125	PTACMT0126	PTACMT0127	PTACMT0128	PTACMT0129	PTACMT0130	PTACMT0131	PTACMT0132
PTACMT0133	PTACMT0134	PTACMT0135	PTACMT0136	PTACMT0137	PTACMT0138	PTACMT0139	PTACMT0140	PTACMT0141	PTACMT0142	PTACMT0143	PTACMT0144
COMMON HEADS						COMMON HEADS					
PTACMT0145	PTACMT0146	PTACMT0147	PTACMT0148	PTACMT0149	PTACMT0150	PTACMT0151	PTACMT0152	PTACMT0153	PTACMT0154	PTACMT0155	PTACMT0156
PTACMT0157	PTACMT0158	PTACMT0159	PTACMT0160	PTACMT0161	PTACMT0162	PTACMT0163	PTACMT0164	PTACMT0165	PTACMT0166	PTACMT0167	PTACMT0168

PN: PTACMT9662

Includes 23 PN's - 90 Pieces

CAPS, VALVE CORES & SERVICE PORTS					
PTACMT0069	PTACMT0070	PTACMT0071	PTACMT0072	PTACMT0073	PTACMT0074
PTACMT0075	PTACMT0076	PTACMT0077	PTACMT0078	PTACMT0079	PTACMT0080
PTACMT0081	PTACMT0082	PTACMT0083	PTACMT0084	PTACMT0085	PTACMT0086
PTACMT0087	PTACMT0088	PTACMT0089	PTACMT0090	PTACMT0091	PTACMT0092
PTACMT0093	PTACMT0094	PTACMT0095	PTACMT0096	PTACMT0097	PTACMT0098
PTACMT0099	PTACMT0100	PTACMT0101	PTACMT0102	PTACMT0103	PTACMT0104

PN: PTACMT9663

Includes 12 PN's - 29 Pieces

ORIFICE TUBES & REPAIR KIT					
PTACMT0097	PTACMT0098	PTACMT0099	PTACMT0100	PTACMT0101	PTACMT0102
PTACMT0103	PTACMT0104	PTACMT0105	PTACMT0106	PTACMT0107	PTACMT0108
PTACMT0109	PTACMT0110	PTACMT0111	PTACMT0112	PTACMT0113	PTACMT0114
PTACMT0115	PTACMT0116	PTACMT0117	PTACMT0118	PTACMT0119	PTACMT0120
PTACMT0121	PTACMT0122	PTACMT0123	PTACMT0124	PTACMT0125	PTACMT0126
PTACMT0127	PTACMT0128	PTACMT0129	PTACMT0130	PTACMT0131	PTACMT0132

INDIVIDUAL KITS

PN	DESCRIPTION
PTACMT9660	COMPRESSOR PORTS & LINE CONNECTION O-RINGS 48 PN'S - 306 PIECES

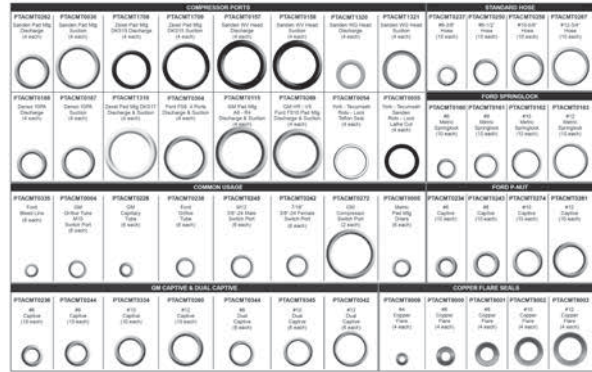

PN	DESCRIPTION
PTACMT9661	SEALING WASHERS HD TRUCKS & O-RINGS SPRINTER VAN 35 PN'S - 150 PIECES

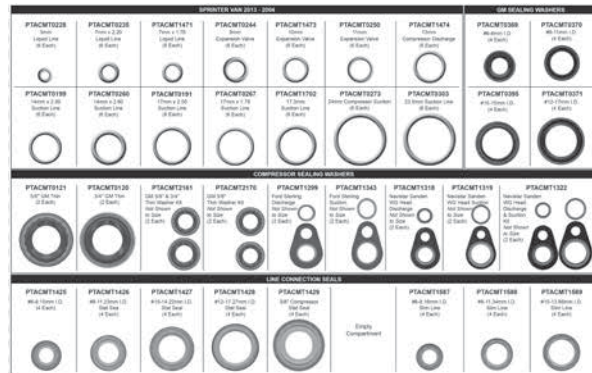

PN	DESCRIPTION
PTACMT9662	SEALING WASHERS & METAL GASKETS 23 PN'S - 90 PIECES



PN	DESCRIPTION
PTACMT9663	ORIFICE TUBES & ORIFICE TUBE REPAIR KIT 12 PN'S - 29 PIECES



INDIVIDUAL COMPONENTS

PN	DESCRIPTION	STD PK.
PTACMT0272	GM COMPRESSOR SWITCH PORT O/R	20 PACK
PTACMT1319	SEALING WASHER - SUCTION - NAVISTAR - SANDEN WG HEAD	EACH
PTACMT1318	SEALING WASHER - DISCHARGE - NAVISTAR - SANDENWG HEAD	EACH
PTACMT1343	SEALING WAHER KIT - SUCTION - FORD/STERLING TRUCKS	EACH
PTACMT0395	#10 (15MM I.D.) SEALING WASHER - GM	10 PACK
PTACMT0369	#6 (8MM I.D.) SEALING WASHER - GM	10 PACK
PTACMT0370	#8 (11MM I.D.) SEALING WASHER - GM	10 PACK
PTACMT0371	#12 (17MM I.D.) SEALING WASHER - GM	10 PACK
PTACMT1425	#6 (8.15MM I.D.) STAT SEAL	10 PACK
PTACMT1428	#12 (17.27MM I.D.) STAT SEAL	10 PACK
PTACMT1429	5/8" (15.37MM I.D.) STATO SEAL - COMPRESSOR PORT	10 PACK
PTACMT1587	#6 (8.15MM I.D.) SLIM LINE SEAL - FREIGHTLINER	EACH
PTACMT1588	#8 (11.34MM I.D.) SLIM LINE SEAL - FREIGHTLINER	EACH
PTACMT1589	#10 (13.86MM I.D.) SLIM LINE SEAL - FREIGHTLINER	EACH
PTACMT1320	SANDEN COMPRESSOR - WG HEAD - DISCHARGE	EACH
PTACMT1321	SANDEN COMPRESSOR - WG HEAD - SUCTION	EACH
PTACMT1427	#10 (14.22MM I.D.) STAT SEAL	EACH
PTACMT0054	TEFLON SEAL - YORK/TECUMSEH ROTO LOCK FITTINGS	20 PACK
PTACMT1299	SEALING WAHER KIT - DISCHARGE - FORD/STERLING TRUCKS	EACH
PTACMT0097	GM - WHITE EVAPORATOR MOUNT (0.072")	5 PACK
PTACMT0092	FORD - BLUE - EVAPORATOR MOUNT (0.067")	5 PACK
PTACMT0093	FORD/PETERBILT - RED EVAPORATOR MOUNT (0.062")	5 PACK
PTACMT0095	FORD - BROWN - EVAPORATOR MOUNT (0.047")	5 PACK
PTACMT0094	FORD - ORANGE - EVAPORATOR MOUNT (0.057")	5 PACK
PTACMT0098	GM - BLACK/WHITE CONDENSER MOUNT (0.072")	5 PACK
PTACMT0091	NAVISTAR - PURPLE - CONDENSER MOUNT (0.062")	5 PACK
PTACMT0099	GM/VOLVO - YELLOW - EVAPORATOR MOUNT (0.062")	5 PACK
PTACMT1243	FORD/STERLING - BLACK/WHITE - EVAPORATOR MOUNT (0.072")	5 PACK
PTACMT0829	ORIFICE TUBE REPAIR KIT (3/8" OR 1/2" O.D. TUBE)	EACH
PTACMT0105	SCHRADER TYPE - GM/FORD HI-SIDE SERVICE PORT	5 PACK
PTACMT0177	AEROQUIP TYPE - LOW SIDE	EACH
PTACMT0178	AEROQUIP TYPE - HI-SIDE	EACH
PTACMT1606	FITTING 3/8-24" MOR X M10-1.25 MALE SWITCH W/VALVE CORE	EACH
PTACMT1607	FITTING 3/8-24" MOR X M12-1.50 MALE SWITCH W/VALVE CORE	EACH
PTACMT1608	FITTING, LOW SIDE SERVICE PORT 3/8"24 X 13MM QDK	EACH
PTACMT1609	FITTING, LOW SIDE SERVICE PORT 3/8"24 X 15MM QDK	EACH
PTACMT0157	SANDEN COMPRESSOR - WV HEAD - DISCHARGE	20 PACK
PTACMT1708	SELTEC DKS15BH/CH - DISCHARGE PORT - .669X.095	EACH
PTACMT1709	SELTEC DKS15BH/CH - SUCTION PORT - .827X.098	EACH
PTACMT1310	ZEXEL COMPRESSOR - DKS17 - DISCHARGE & SUCTION PORTS	20 PACK
PTACMT0228	GM CAPILLARY TUBE	20 PACK
PTACMT0004	M10 SWITCH PORTS - #7 / GM ORIFICE TUBE O-RING	20 PACK
PTACMT0245	M12 SWITCH PORTS	20 PACK
PTACMT0260	GM #12 CAPTIVE (.103" WALL)	20 PACK
PTACMT0262	SANDEN PAD MOUNT - DISCHARGE PORT	20 PACK
PTACMT0115	GM COMPRESSOR PORTS - DISCHARGE AND SUCTION - A6 AND R4	20 PACK
PTACMT0345	GM - #10 (5/8") DUAL	20 PACK
PTACMT0344	GM - #8 (1/2") DUAL	20 PACK
PTACMT0303	28MM - SUCTION LINE - SPRINTER VAN	20 PACK
PTACMT0030	SANDEN PAD MOUNT - SUCTION PORT / FORD FS6 - 2 PORT - OVAL	20 PACK
PTACMT0304	FORD FS6 - COMPRESSOR PORTS	20 PACK
PTACMT0238	FORD ORIFICE TUBE - O-RING	EACH
PTACMT0236	GM #6 CAPTIVE (.095" WALL)	20 PACK
PTACMT0335	FORD LIQUID LINE BLEED TUBE	20 PACK
PTACMT0244	GM #8 CAPTIVE (.095" WALL)	20 PACK
PTACMT0274	FORD #10 P-NUT (.098" WALL)	20 PACK
PTACMT0160	#6 METRIC - SPRINGLOCK	20 PACK

INDIVIDUAL COMPONENTS

PN	DESCRIPTION	STD PK.
PTACMT0163	#12 METRIC - SPRINGLOCK	20 PACK
PTACMT0187	DENSO 10PA15C - #10 SUCTION PORT	20 PACK
PTACMT0191	17MM X 2.01MM - SPRINTER VAN	20 PACK
PTACMT0161	#8 METRIC - SPRINGLOCK	20 PACK
PTACMT0269	GM COMPRESSOR HR, V5 DISCHARGE AND SUCTION PORT - FORD FS10, SANDEN FLX7	20 PACK
PTACMT0199	14MM X 2.00 - SUCTION LINE - SPRINTER VAN	20 PACK
PTACMT0005	METRIC - PAD MOUNT DRIERS	EACH
PTACMT0188	DENSO 10PA15C - #8 DISCHARGE PORT	EACH
PTACMT0242	7/16"-20 SWITCH PORT - SANDEN DRAIN PLUGS	EACH
PTACMT0237	#6 STD HOSE - FORD #6 STD SPRINGLOCK - SELTEC DRAIN PLUG	EACH
PTACMT0250	#8 STD HOSE - FORD #8 STD SPRINGLOCK	EACH
PTACMT0258	#10 STD HOSE - FORD #10 STD SPRINGLOCK - YORK/TECUMSEH TUBE-O FITTING SEAL	EACH
PTACMT0158	SANDEN COMPRESSOR - WV HEAD - SUCTION	20 PACK
PTACMT0342	GM - #12 (3/4") DUAL	20 PACK
PTACMT0234	FORD #6 P-NUT (1.03" WALL)	20 PACK
PTACMT0235	7MM X 2.21MM - SPRINTER VAN	20 PACK
PTACMT0243	FORD #8 P-NUT (1.03" WALL)	20 PACK
PTACMT0261	FORD #12 P-NUT (1.03" WALL)	20 PACK
PTACMT0267	#12 STD HOSE - FORD #12 STD SPRINGLOCK - VIR OUTLET	20 PACK
PTACMT0273	24MM - COMPRESSOR SUCTION - SPRINTER VAN	20 PACK
PTACMT0641	LATHE CUT SEAL - YORK/TECUMSEH - SANDEN ROTO LOCK FITTINGS	10 PACK
PTACMT1471	7MM X 1.78MM - SPRINTER VAN	20 PACK
PTACMT1473	10MM - EXP VALVE - SPRINTER VAN	20 PACK
PTACMT1474	13MM - COMPRESSOR DISCHARGE & CONDENSER - SPRINTER VAN	20 PACK
PTACMT1702	22MM - SUCTION LINE - SPRINTER VAN	20 PACK
PTACMT0063	SCHRADER TYPE - M8 X 1.0 - LOW SIDE	5 PACK
PTACMT0069	SCHRADER TYPE - M10 X 1.0 - HI-SIDE	5 PACK
PTACMT0193	AEROQUIP STYLE - M10 HI-SIDE	5 PACK
PTACMT8009	#4 (5/16") COPPER FLARE WASHER	EACH
PTACMT8000	#6 (3/8") COPPER FLARE WASHER	EACH
PTACMT8001	#8 (1/2") COPPER FLARE WASHER	EACH
PTACMT8002	#10 (5/8") COPPER FLARE WASHER	EACH
PTACMT8003	#12 (3/4") COPPER FLARE WASHER	EACH
PTACMT0067	SCHRADER TYPE - M10 X 1.25 (JRA) - HI-SIDE	5 PACK
PTACMT0061	SCHRADER TYPE - M9 X 1.0 (JRA) - LOW SIDE	5 PACK
PTACMT0062	EATON STYLE CAP M8 - 13MM	5 PACK
PTACMT0068	EATON STYLE CAP M10 - 16MM	5 PACK
PTACMT0192	AEROQUIP STYLE - M8 LOW SIDE	5 PACK
PTACMT1544	SCHRADER TYPE - SPRINTER VAN	5 PACK
PTACMT0301	SCHRADER TYPE - VOLVO	5 PACK
PTACMT0050	EATON STYLE - M8 - 13MM HI FLOW VALVE CORE (HI-SIDE)	5 PACK
PTACMT0064	STANDARD VALVE CORE - R12 & R134A	20 PACK
PTACMT0058	GM - HI FLOW R12 & R134A	5 PACK
PTACMT0059	JRA - HI FLOW VALVE CORE	5 PACK
PTACMT0065	EATON STYLE - M10 -16MM HI FLOW VALVE CORE (LOW SIDE)	5 PACK
PTACMT0334	GM #10 CAPTIVE (.095" WALL)	20 PACK
PTACMT0162	#10 METRIC - SPRINGLOCK	20 PACK
PTACMT1426	#8 (11.23MM I.D.) STAT SEAL	EACH
PTACMT1322	SEALING WASHER - KIT DISCHARGE & SUCTION - NAVISTAR - SANDEN WG HEAD	EACH
PTACMT0121	SEALING WASHER 5/8" THIN - GM COMPRESSOR PORT	10 PACK
PTACMT0120	SEALING WASHER 3/4" THIN - GM COMPRESSOR PORT	10 PACK
PTACMT2161	SEALING WASHER 5/8" & 3/4" THIN (KIT OF 2) - GM COMPRESSOR PORT	EACH
PTACMT2170	SEALING WASHER 5/8" THIN (KIT OF 2) - GM COMPRESSOR PORT	EACH
PTACMT0145	SCHRADER TYPE - GM/FORD LOW SIDE SERVICE PORT	2 PACK
PTACMT0628	ALL CONDENSER MOUNT - VOV UPGRADE	EACH
PTACMT0629	ALL EVAPORATOR MOUNT - VOV UPGRADE	EACH

CROSS REFERENCE

PN	MANUFACTURER	PRIMATECH
0139	AIRSOURCE/MEI	PTAC0139
621	FOURSEASONS	PTAC1651
635	FOURSEASONS	PTAC1654
639	FOURSEASONS	PTAC1652
1150	AIRSOURCE/MEI	PTAC1150
1220	AIRSOURCE/MEI	PTAC1220
1224	AIRSOURCE/MEI	PTAC1224
1233	AIRSOURCE/MEI	PTAC1233
1243	AIRSOURCE/MEI	PTAC1243
1248	AIRSOURCE/MEI	PTAC1248
1252	AIRSOURCE/MEI	PTAC1252
1265	AIRSOURCE/MEI	PTAC1265
1293	AIRSOURCE/MEI	PTAC1293
1324	AIRSOURCE/MEI	PTAC1324
1342	AIRSOURCE/MEI	PTAC1342
1437	AIRSOURCE/MEI	PTAC1437
1439	AIRSOURCE/MEI	PTAC1439
1459	AIRSOURCE/MEI	PTAC1459
1489	AIRSOURCE/MEI	PTAC1489
1492	AIRSOURCE/MEI	PTAC1492
1493	AIRSOURCE/MEI	PTAC1493
1498	AIRSOURCE/MEI	PTAC1498
1499	AIRSOURCE/MEI	PTAC1499
1511	AIRSOURCE/MEI	PTAC1511
1513	AIRSOURCE/MEI	PTAC1513
1514	AIRSOURCE/MEI	PTAC1514
1515	AIRSOURCE/MEI	PTAC1515
1546	AIRSOURCE/MEI	PTAC1546
1550	AIRSOURCE/MEI	PTAC1550
1560	AIRSOURCE/MEI	PTAC1560
1565	AIRSOURCE/MEI	PTAC1565
1600	AIRSOURCE/MEI	PTAC1600
1601	AIRSOURCE/MEI	PTAC1601
1601	AIRSOURCE/MEI	PTAC1601
1602	AIRSOURCE/MEI	PTAC1602
1611	AIRSOURCE/MEI	PTAC1611
1612	AIRSOURCE/MEI	PTAC1612
1613	AIRSOURCE/MEI	PTAC1613
1613	AIRSOURCE/MEI	PTAC1613
1614	AIRSOURCE/MEI	PTAC1614
1615	AIRSOURCE/MEI	PTAC1615
1618	AIRSOURCE/MEI	PTAC1618
1619	AIRSOURCE/MEI	PTAC1619
1621	AIRSOURCE/MEI	PTAC1621
1622	AIRSOURCE/MEI	PTAC1622

PN	MANUFACTURER	PRIMATECH
1632	AIRSOURCE/MEI	PTAC1632
1644	AIRSOURCE/MEI	PTAC1644
1651	AIRSOURCE/MEI	PTAC1651
1652	AIRSOURCE/MEI	PTAC1652
1654	AIRSOURCE/MEI	PTAC1654
1662	AIRSOURCE/MEI	PTAC1662
1663	AIRSOURCE/MEI	PTAC1663
1672	AIRSOURCE/MEI	PTAC1672
2104	AIRSOURCE/MEI	PTAC2104
2386	AIRSOURCE/MEI	PTAC2386
3051	AIRSOURCE/MEI	PTAC3051
3129	AIRSOURCE/MEI	PTAC3129
3231	AIRSOURCE/MEI	PTAC3231
3267	AIRSOURCE/MEI	PTAC3267
3393	AIRSOURCE/MEI	PTAC3393
3512	AIRSOURCE/MEI	PTAC3512
3514	AIRSOURCE/MEI	PTAC3514
3592	FOURSEASONS	PTAC1550
3673	AIRSOURCE/MEI	PTAC3673
3741	AIRSOURCE/MEI	PTAC3741
3772	AIRSOURCE/MEI	PTAC3772
3941	AIRSOURCE/MEI	PTAC3941
3972	AIRSOURCE/MEI	PTAC3972
4546	AIRSOURCE/MEI	PTAC54546
5029	AIRSOURCE/MEI	PTAC5029
5030	AIRSOURCE/MEI	PTAC5030
5030	AIRSOURCE/MEI	PTAC5030
5031	AIRSOURCE/MEI	PTAC5031
5032	AIRSOURCE/MEI	PTAC5032
5041	AIRSOURCE/MEI	PTAC5041
5044	AIRSOURCE/MEI	PTAC5044
5044	AIRSOURCE/MEI	PTAC5044
5126	AIRSOURCE/MEI	PTAC5126
5128	AIRSOURCE/MEI	PTAC5128
5129	AIRSOURCE/MEI	PTAC5129
5131	AIRSOURCE/MEI	PTAC5131
5137	AIRSOURCE/MEI	PTAC5137
5144	AIRSOURCE/MEI	PTAC5144
5145	AIRSOURCE/MEI	PTAC5145
5164	AIRSOURCE/MEI	PTAC5164
5236	AIRSOURCE/MEI	PTAC5236
5256	AIRSOURCE/MEI	PTAC5256
5258	AIRSOURCE/MEI	PTAC5258
5269	AIRSOURCE/MEI	PTAC5269
5320	AIRSOURCE/MEI	PTAC5320

PN	MANUFACTURER	PRIMATECH
5327	AIRSOURCE/MEI	PTAC5327
5330	AIRSOURCE/MEI	PTAC5330
5331	AIRSOURCE/MEI	PTAC5331
5333	AIRSOURCE/MEI	PTAC5333
5334	AIRSOURCE/MEI	PTAC5334
5339	AIRSOURCE/MEI	PTAC5339
5347	AIRSOURCE/MEI	PTAC5347
5348	AIRSOURCE/MEI	PTAC5348
5349	AIRSOURCE/MEI	PTAC5349
5362	AIRSOURCE/MEI	PTAC5362
5365	AIRSOURCE/MEI	PTAC5365
5366	AIRSOURCE/MEI	PTAC5366
5373	AIRSOURCE/MEI	PTAC5373
5380	AIRSOURCE/MEI	PTAC5380
5382	AIRSOURCE/MEI	PTAC5382
5384	AIRSOURCE/MEI	PTAC5384
5385	AIRSOURCE/MEI	PTAC5385
5387	AIRSOURCE/MEI	PTAC5387
5393	AIRSOURCE/MEI	PTAC5393
5395	AIRSOURCE/MEI	PTAC5395
5398	AIRSOURCE/MEI	PTAC5398
5402	AIRSOURCE/MEI	PTAC5402
5403	AIRSOURCE/MEI	PTAC5403
5404	AIRSOURCE/MEI	PTAC5404
5513	AIRSOURCE/MEI	PTAC5513
5514	AIRSOURCE/MEI	PTAC5514
5705	AIRSOURCE/MEI	PTAC5705
5707	AIRSOURCE/MEI	PTAC5707
5711	AIRSOURCE/MEI	PTAC5711
5726	AIRSOURCE/MEI	PTAC5726
5727	AIRSOURCE/MEI	PTAC5727
5752	AIRSOURCE/MEI	PTAC5752
5764	AIRSOURCE/MEI	PTAC5764
5770	AIRSOURCE/MEI	PTAC5770
5771	AIRSOURCE/MEI	PTAC5771
5805	AIRSOURCE/MEI	PTAC5805
5811	AIRSOURCE/MEI	PTAC5811
5899	AIRSOURCE/MEI	PTAC5899
5920	AIRSOURCE/MEI	PTAC5920
6127	AIRSOURCE/MEI	PTAC6127
6205	AIRSOURCE/MEI	PTAC6205
6229	AIRSOURCE/MEI	PTAC6229
6273	AIRSOURCE/MEI	PTAC6273
6283	AIRSOURCE/MEI	PTAC6283
6287	AIRSOURCE/MEI	PTAC6287

PN	MANUFACTURER	PRIMATECH
6287	AIRSOURCE/MEI	PTAC6287
6288	AIRSOURCE/MEI	PTAC6288
6292	AIRSOURCE/MEI	PTAC6292
6319	AIRSOURCE/MEI	PTAC6319
6331	AIRSOURCE/MEI	PTAC6331
6345	AIRSOURCE/MEI	PTAC6345
6350	AIRSOURCE/MEI	PTAC6350
6368	AIRSOURCE/MEI	PTAC6368
6609	AIRSOURCE/MEI	PTAC6609
6636	AIRSOURCE/MEI	PTAC6636
6948	AIRSOURCE/MEI	PTAC6948
7126	AIRSOURCE/MEI	PTAC7126
7130	AIRSOURCE/MEI	PTAC7130
7132	AIRSOURCE/MEI	PTAC7132
7134	AIRSOURCE/MEI	PTAC7134
7135	AIRSOURCE/MEI	PTAC7135
7141	AIRSOURCE/MEI	PTAC7141
7143	AIRSOURCE/MEI	PTAC7143
7159	AIRSOURCE/MEI	PTAC7159
7160	AIRSOURCE/MEI	PTAC7160
7160	AIRSOURCE/MEI	PTAC7160
7166	AIRSOURCE/MEI	PTAC7166
7169	AIRSOURCE/MEI	PTAC7169
7197	AIRSOURCE/MEI	PTAC7197
7198	AIRSOURCE/MEI	PTAC7198
7230	AIRSOURCE/MEI	PTAC7230
7387	AIRSOURCE/MEI	PTAC7387
7393	AIRSOURCE/MEI	PTAC7393
7408	AIRSOURCE/MEI	PTAC7408
7415	AIRSOURCE/MEI	PTAC7415
7416	AIRSOURCE/MEI	PTAC7416
7417	AIRSOURCE/MEI	PTAC7417
7493	AIRSOURCE/MEI	PTAC7493
7541	AIRSOURCE/MEI	PTAC7541
7555	AIRSOURCE/MEI	PTAC7555
7559	AIRSOURCE/MEI	PTAC7559
7585	AIRSOURCE/MEI	PTAC7585
8202	AIRSOURCE/MEI	PTAC8202
8203	AIRSOURCE/MEI	PTAC8203
8206	AIRSOURCE/MEI	PTAC8206
8207	AIRSOURCE/MEI	PTAC8207
8208	AIRSOURCE/MEI	PTAC8208
8227	AIRSOURCE/MEI	PTAC8227
8228	AIRSOURCE/MEI	PTAC8228
8229	AIRSOURCE/MEI	PTAC8229

PN	MANUFACTURER	PRIMATECH
8230	AIRSOURCE/MEI	PTAC8230
8248	AIRSOURCE/MEI	PTAC8248
8256	AIRSOURCE/MEI	PTAC8256
8621	FOURSEASONS	PTAC1651
8635	FOURSEASONS	PTAC1654
8639	FOURSEASONS	PTAC1652
8811	AIRSOURCE/MEI	PTAC8811
8812	AIRSOURCE/MEI	PTAC8812
8916	AIRSOURCE/MEI	PTAC8916
14718	FOURSEASONS	PTAC5513
14720	FOURSEASONS	PTAC5514
33049	FOURSEASONS	PTAC7493
33352	FOURSEASONS	PTAC7408
33474	FOURSEASONS	PTAC7166
33478	FOURSEASONS	PTAC7387
33479	FOURSEASONS	PTAC7169
33498	FOURSEASONS	PTAC7230
33533	FOURSEASONS	PTAC7135
33537	FOURSEASONS	PTAC7132
35334	FOURSEASONS	PTAC3129
35402	FOURSEASONS	PTAC3267
35540	FOURSEASONS	PTAC3512
35543	FOURSEASONS	PTAC3231
35703	FOURSEASONS	PTAC1150
35720	FOURSEASONS	PTAC1342
35761	FOURSEASONS	PTAC1513
35795	FOURSEASONS	PTAC1252
35888	FOURSEASONS	PTAC1220
35901	FOURSEASONS	PTAC1550
35928	FOURSEASONS	PTAC1252
38621	FOURSEASONS	PTAC1651
38635	FOURSEASONS	PTAC1654
38639	FOURSEASONS	PTAC1652
38641	FOURSEASONS	PTAC1662
38677	FOURSEASONS	PTAC1611
38679	FOURSEASONS	PTAC1612
38880	FOURSEASONS	PTAC1602
38892	FOURSEASONS	PTAC1614
38901	FOURSEASONS	PTAC1600
39071	FOURSEASONS	PTAC1663
39177	FOURSEASONS	PTAC1621
47531	FOURSEASONS	PTAC5044
47905	FOURSEASONS	PTAC5031
47906	FOURSEASONS	PTAC5131
47907	FOURSEASONS	PTAC5144

PN	MANUFACTURER	PRIMATECH
47926	FOURSEASONS	PTAC5144
47927	FOURSEASONS	PTAC5129
47931	FOURSEASONS	PTAC5031
47938	FOURSEASONS	PTAC5030
47960	FOURSEASONS	PTAC5029
47971	FOURSEASONS	PTAC5032
48534	FOURSEASONS	PTAC5041
52052	FOURSEASONS	PTAC6127
58035	FOURSEASONS	PTAC5920
58056	FOURSEASONS	PTAC5236
58064	FOURSEASONS	PTAC5256
58507	FOURSEASONS	PTAC5920
58521	FOURSEASONS	PTAC5811
58621	FOURSEASONS	PTAC5711
58700	FOURSEASONS	PTAC5727
58701	FOURSEASONS	PTAC5764
58702	FOURSEASONS	PTAC5707
58705	FOURSEASONS	PTAC5764
58708	FOURSEASONS	PTAC5330
58710	FOURSEASONS	PTAC5331
58785	FOURSEASONS	PTAC5349
58786	FOURSEASONS	PTAC5333
58793	FOURSEASONS	PTAC5770
58796	FOURSEASONS	PTAC5331
58797	FOURSEASONS	PTAC5334
59009	FOURSEASONS	PTAC8202
59030	FOURSEASONS	PTAC8811
59035	FOURSEASONS	PTAC8812
59347	FOURSEASONS	PTAC8916
68173	FOURSEASONS	PTAC5373
68176	FOURSEASONS	PTAC5384
68576	FOURSEASONS	PTAC5771
68579	FOURSEASONS	PTAC5726
68588	FOURSEASONS	PTAC5752
68702	FOURSEASONS	PTAC5899
69991	FOURSEASONS	PTAC8812
69994	FOURSEASONS	PTAC8811
74628	FOURSEASONS	PTAC2104
78574	FOURSEASONS	PTAC5764
78595	FOURSEASONS	PTAC5362
78597	FOURSEASONS	PTAC5705
83700	FOURSEASONS	PTAC7141
83701	FOURSEASONS	PTAC7393
83705	FOURSEASONS	PTAC7143
83708	FOURSEASONS	PTAC7160

PN	MANUFACTURER	PRIMATECH
83709	FOURSEASONS	PTAC7198
83720	FOURSEASONS	PTAC7415
98599	FOURSEASONS	PTAC5348
160034	BERGSTROM	PTAC6283
160049	BERGSTROM	PTAC6127
160061	BERGSTROM	PTAC6229
160199	BERGSTROM	PTAC6287
201520	BERGSTROM	PTAC3512
203061	BERGSTROM	PTAC6287
203184	BERGSTROM	PTAC3231
203203	BERGSTROM	PTAC3129
203299	BERGSTROM	PTAC3051
205620	BERGSTROM	PTAC3512
404413	BERGSTROM	PTAC1493
409517	EVERCO	PTAC8811
409517	EVERCO	PTAC8812
409518	EVERCO	PTAC8811
409518	EVERCO	PTAC8812
525694	BERGSTROM	PTAC5764
525722	BERGSTROM	PTAC5726
525723	BERGSTROM	PTAC5727
525741	BERGSTROM	PTAC5236
525854	BERGSTROM	PTAC5920
525856	BERGSTROM	PTAC5811
525917	BERGSTROM	PTAC5711
525979	BERGSTROM	PTAC5805
525992	BERGSTROM	PTAC5330
525995	BERGSTROM	PTAC5331
525996	BERGSTROM	PTAC5327
525997	BERGSTROM	PTAC5707
526066	BERGSTROM	PTAC5349
526112	BERGSTROM	PTAC7493
526353	BERGSTROM	PTAC5348
526357	BERGSTROM	PTAC5771
526363	BERGSTROM	PTAC5770
526434	BERGSTROM	PTAC5334
526435	BERGSTROM	PTAC5333
526436	BERGSTROM	PTAC5333
526437	BERGSTROM	PTAC5705
526442	BERGSTROM	PTAC5380
526445	BERGSTROM	PTAC5393
526479	BERGSTROM	PTAC5770
526488	BERGSTROM	PTAC5385
526489	BERGSTROM	PTAC5387
526495	BERGSTROM	PTAC5707

PN	MANUFACTURER	PRIMATECH
526504	BERGSTROM	PTAC5384
526507	BERGSTROM	PTAC5380
540018	BERGSTROM	PTAC1654
540021	BERGSTROM	PTAC1601
540031	BERGSTROM	PTAC1601
540057	BERGSTROM	PTAC1611
540064	BERGSTROM	PTAC7126
540092	BERGSTROM	PTAC7160
540126	BERGSTROM	PTAC7143
540214	BERGSTROM	PTAC5513
540215	BERGSTROM	PTAC5514
540225	BERGSTROM	PTAC5513
540254	BERGSTROM	PTAC1612
540265	BERGSTROM	PTAC1651
540266	BERGSTROM	PTAC1652
540274	BERGSTROM	PTAC1614
540317	BERGSTROM	PTAC1613
540320	BERGSTROM	PTAC1613
540383	BERGSTROM	PTAC1615
540446	BERGSTROM	PTAC1644
540454	BERGSTROM	PTAC1619
550508	BERGSTROM	PTAC8916
551354	BERGSTROM	PTAC8916
650179	BERGSTROM	PTAC1233
650204	BERGSTROM	PTAC1492
650441	BERGSTROM	PTAC1220
650475	BERGSTROM	PTAC1233
650475	BERGSTROM	PTAC1224
650477	BERGSTROM	PTAC1233
650482	BERGSTROM	PTAC5044
650483	BERGSTROM	PTAC5044
650487	BERGSTROM	PTAC5131
650496	BERGSTROM	PTAC5041
650543	BERGSTROM	PTAC5131
650545	BERGSTROM	PTAC5030
650547	BERGSTROM	PTAC5032
650627	BERGSTROM	PTAC1565
650633	BERGSTROM	PTAC1550
650633	BERGSTROM	PTAC1560
650867	BERGSTROM	PTAC5129
650868	BERGSTROM	PTAC5145
650966	BERGSTROM	PTAC5031
651069	BERGSTROM	PTAC1252
651323	BERGSTROM	PTAC1439
651332	BERGSTROM	PTAC1498

PN	MANUFACTURER	PRIMATECH
651332	BERGSTROM	PTAC1499
651459	BERGSTROM	PTAC1252
654475	BERGSTROM	PTAC1224
869619	BERGSTROM	PTAC2104
890072	BERGSTROM	PTAC1150
901006	EVERCO	PTAC1150
901413	EVERCO	PTAC1437
901800	EVERCO	PTAC1220
901815	EVERCO	PTAC1233
922105	EVERCO	PTAC5513
922106	EVERCO	PTAC5514
932110	EVERCO	PTAC1601
932118	EVERCO	PTAC1613
932136	EVERCO	PTAC1614
932150	EVERCO	PTAC1612
932151	EVERCO	PTAC1611
932203	EVERCO	PTAC1662
932204	EVERCO	PTAC1651
932205	EVERCO	PTAC1654
932207	EVERCO	PTAC1652
935032	EVERCO	PTAC2104
936105	EVERCO	PTAC7135
936109	EVERCO	PTAC7166
936116	EVERCO	PTAC7160
936120	EVERCO	PTAC7230
936121	EVERCO	PTAC7134
936122	EVERCO	PTAC7169
936123	EVERCO	PTAC7197
936124	EVERCO	PTAC7387
936130	EVERCO	PTAC7132
936163	EVERCO	PTAC7126
936219	EVERCO	PTAC7130
936220	EVERCO	PTAC7230
936520	EVERCO	PTAC7493
936536	EVERCO	PTAC7408
936777	EVERCO	PTAC7143
936800	EVERCO	PTAC7141
936801	EVERCO	PTAC7393
937171	EVERCO	PTAC3512
937400	EVERCO	PTAC3393
937405	EVERCO	PTAC3231
937729	EVERCO	PTAC3129
937734	EVERCO	PTAC3267
937742	EVERCO	PTAC3051
937802	EVERCO	PTAC5899

PN	MANUFACTURER	PRIMATECH
948223	EVERCO	PTAC5041
948224	EVERCO	PTAC5044
948435	EVERCO	PTAC5030
948436	EVERCO	PTAC5029
948439	EVERCO	PTAC5031
948440	EVERCO	PTAC5131
948442	EVERCO	PTAC5041
948445	EVERCO	PTAC5032
948447	EVERCO	PTAC5145
948448	EVERCO	PTAC5129
948448	EVERCO	PTAC5126
948449	EVERCO	PTAC5128
961191	EVERCO	PTAC5771
967024	EVERCO	PTAC5920
967140	EVERCO	PTAC5711
967184	EVERCO	PTAC5811
967212	EVERCO	PTAC5727
967215	EVERCO	PTAC5707
967221	EVERCO	PTAC5330
967223	EVERCO	PTAC5393
967228	EVERCO	PTAC5333
967229	EVERCO	PTAC5349
967232	EVERCO	PTAC5320
967236	EVERCO	PTAC5770
967241	EVERCO	PTAC5334
967242	EVERCO	PTAC5373
967263	EVERCO	PTAC5327
967415	EVERCO	PTAC5705
969104	EVERCO	PTAC5236
995064	EVERCO	PTAC8916
1099004	BERGSTROM	PTAC3231
2017001	BERGSTROM	PTAC1224
2212005	BERGSTROM	PTAC1498
2212005	BERGSTROM	PTAC1499
2212010	BERGSTROM	PTAC1324
2213008	BERGSTROM	PTAC1493
1000010743	BERGSTROM	PTAC5373
1000023163	BERGSTROM	PTAC5365
1000023163	BERGSTROM	PTAC5365SD
1000036213	BERGSTROM	PTAC6287
1000039652	BERGSTROM	PTAC5339
1000039661	BERGSTROM	PTAC6287
1699947C1	REDDOT	PTAC3741
1699950C1	REDDOT	PTAC6609
223P	AIRSOURCE/MEI	PTAC1223P

PN	MANUFACTURER	PRIMATECH
3521729C1	REDDOT	PTAC1489
4379-RD5-7120-0	REDDOT	PTAC5727
51-5642	REDDOT	PTAC1550
51-5642	REDDOT	PTAC1560
525985C	BERGSTROM	PTAC7408
526024C	BERGSTROM	PTAC7159
526333C	BERGSTROM	PTAC7415
5333S	AIRSOURCE/MEI	PTAC5333SD
5365S	AIRSOURCE/MEI	PTAC5365SD
540072C	BERGSTROM	PTAC7169
540077C	BERGSTROM	PTAC7160
540078C	BERGSTROM	PTAC7132
540091C	BERGSTROM	PTAC7135
540096C	BERGSTROM	PTAC7387
540102C	BERGSTROM	PTAC7159
540103C	BERGSTROM	PTAC7166
540111C	BERGSTROM	PTAC7141
540122C	BERGSTROM	PTAC7159
540127C	BERGSTROM	PTAC7130
540300C	BERGSTROM	PTAC7159
540322C	BERGSTROM	PTAC7198
540433C	BERGSTROM	PTAC7197
6245A	AIRSOURCE/MEI	PTAC6245A
62SD	AIRSOURCE/MEI	PTAC5362SD
71R-1150	REDDOT	PTAC1150
71R-1450	REDDOT	PTAC1220
71R-1457	REDDOT	PTAC1233
71R-1470	REDDOT	PTAC1233
71R-1722	REDDOT	PTAC1252
71R-6125	REDDOT	PTAC1437
71R-6160	REDDOT	PTAC1437
71R-6180	REDDOT	PTAC1439
71R-6181	REDDOT	PTAC1492
71R-6181	REDDOT	PTAC1493
71R-6183	REDDOT	PTAC1492
71R-6210	REDDOT	PTAC1498
71R-6210	REDDOT	PTAC1499
71R-7073	REDDOT	PTAC1439
71R-7500	REDDOT	PTAC1550
71R-7500	REDDOT	PTAC1560
71R-7550	REDDOT	PTAC1550
71R-7550	REDDOT	PTAC1560
71R-7650	REDDOT	PTAC1565
71R-8420	REDDOT	PTAC1612
71R-8430	REDDOT	PTAC1611

PN	MANUFACTURER	PRIMATECH
71R-8440	REDDOT	PTAC1614
71R-8503	REDDOT	PTAC1651
71R-8504	REDDOT	PTAC1652
71R-8505	REDDOT	PTAC1654
71R-8507	REDDOT	PTAC1662
72R-5040	REDDOT	PTAC2104
73R-0522	REDDOT	PTAC3512
73R-0552	REDDOT	PTAC3512
73R-2212	REDDOT	PTAC3051
73R-4102	REDDOT	PTAC3393
73R-4162	REDDOT	PTAC3231
73R-6253	REDDOT	PTAC3741
73R-6370	REDDOT	PTAC3741
73R-7130	REDDOT	PTAC3772
74R-2001	REDDOT	PTAC7393
74R-2306	REDDOT	PTAC7132
74R-2536	REDDOT	PTAC7126
74R-2590	REDDOT	PTAC7555
74R-2606	REDDOT	PTAC7134
74R-2666	REDDOT	PTAC7135
74R-2676	REDDOT	PTAC7143
74R-3066	REDDOT	PTAC7143
74R-3076	REDDOT	PTAC7166
74R-3077	REDDOT	PTAC7166
74R-3106	REDDOT	PTAC7159
74R-3126	REDDOT	PTAC7198
74R-3127	REDDOT	PTAC7198
74R-3128	REDDOT	PTAC7198
74R-3147	REDDOT	PTAC7160
74R-3156	REDDOT	PTAC7135
74R-3326	REDDOT	PTAC7169
74R-3328	REDDOT	PTAC7169
74R-3356	REDDOT	PTAC7387
74R-3450	REDDOT	PTAC7130
74R-3455	REDDOT	PTAC7230
74R-3476	REDDOT	PTAC7230
74R-4210	REDDOT	PTAC7559
74R-5060	REDDOT	PTAC7408
74R-5095	REDDOT	PTAC7493
74R-5097	REDDOT	PTAC7415
75R-0302	REDDOT	PTAC5031
75R-0402	REDDOT	PTAC5131
75R-0402	REDDOT	PTAC5031
75R-0452	REDDOT	PTAC5044
75R-0502	REDDOT	PTAC5126

PN	MANUFACTURER	PRIMATECH
75R-0522	REDDOT	PTAC5129
75R-0612	REDDOT	PTAC5030
75R-0662	REDDOT	PTAC5029
75R-0682	REDDOT	PTAC5128
75R-1202	REDDOT	PTAC5044
75R-1202	REDDOT	PTAC5144
75R-1302	REDDOT	PTAC5145
75R-1342	REDDOT	PTAC5032
75R-1842	REDDOT	PTAC5137
75R-3452	REDDOT	PTAC5041
75R-3502	REDDOT	PTAC5041
75R4502	REDDOT	PTAC5041
75R-4502	REDDOT	PTAC5041
75R-5641	REDDOT	PTAC5514
75R-5648	REDDOT	PTAC5513
75R-7240	REDDOT	PTAC5256
75R-7270	REDDOT	PTAC5256
75R-7280	REDDOT	PTAC5236
75R-7290	REDDOT	PTAC5256
75R-7300	REDDOT	PTAC5258
75R-81152	REDDOT	PTAC5770
75R-81152-DS	REDDOT	PTAC5770
75R-81192	REDDOT	PTAC5771
75R-81292	REDDOT	PTAC5348
75R-81292-Q	REDDOT	PTAC5348
75R-81302	REDDOT	PTAC5333
75R-81312	REDDOT	PTAC5770
75R-81312-DS	REDDOT	PTAC5770
75R-81362	REDDOT	PTAC5385
75R-81372	REDDOT	PTAC5387
75R-81462	REDDOT	PTAC5327
75R-81472	REDDOT	PTAC5764
75R-81502	REDDOT	PTAC5707
75R-81502-DS	REDDOT	PTAC5707
75R-81582	REDDOT	PTAC5726
75R-81602	REDDOT	PTAC5334
75R-81622	REDDOT	PTAC5339
75R-81622-Q	REDDOT	PTAC5339
75R-81652	REDDOT	PTAC5384
75R-81672	REDDOT	PTAC5726
75R-81772	REDDOT	PTAC5347
75R-8212	REDDOT	PTAC5920
75R-82312-DS	REDDOT	PTAC5333SD
75R-83132	REDDOT	PTAC5705
75R-84132	REDDOT	PTAC5320

PN	MANUFACTURER	PRIMATECH
75R-84132-DS	REDDOT	PTAC5320
75R-84212	REDDOT	PTAC5330
75R-84212-DS	REDDOT	PTAC5330
75R-8422	REDDOT	PTAC5727
75R-84232	REDDOT	PTAC5331
75R-8424	REDDOT	PTAC5752
75R-84252	REDDOT	PTAC5333
75R-84302-Q	REDDOT	PTAC5347
75R-8432	REDDOT	PTAC5726
75R-8432-DS	REDDOT	PTAC5726
75R-84332	REDDOT	PTAC5327
75R-84362	REDDOT	PTAC5380
75R-84362-DS	REDDOT	PTAC5380
75R-84382	REDDOT	PTAC5382
75R-84432	REDDOT	PTAC5382
75R-84472	REDDOT	PTAC5707
75R-84622	REDDOT	PTAC5349
75R-84622-DS	REDDOT	PTAC5349
75R-8512	REDDOT	PTAC5811
75R-8612	REDDOT	PTAC5711
75R-8662	REDDOT	PTAC5899
75R-8772	REDDOT	PTAC5373
75R-89522-DS	REDDOT	PTAC5362SD
75R-89532-DS	REDDOT	PTAC5402
75R-9612	REDDOT	PTAC5404
77R-0585	REDDOT	PTAC6245A
77R-6978	REDDOT	PTAC6287
77R-7715	REDDOT	PTAC6331
77R-7717	REDDOT	PTAC6331
923A	AIRSOURCE/MEI	PTAC5923A
A8025V	EVERCO	PTAC1550
A8025V	EVERCO	PTAC1560
A84028	EVERCO	PTAC5727
A84030	EVERCO	PTAC5764
A84032	EVERCO	PTAC5707
A84041	EVERCO	PTAC5330
A84043	EVERCO	PTAC5331
A8892	EVERCO	PTAC5920
A93191	EVERCO	PTAC5771
A94049	EVERCO	PTAC5726
B11373	BERGSTROM	PTAC8248
B275152	BERGSTROM	PTAC3231
B402842	BERGSTROM	PTAC5752
B402892	BERGSTROM	PTAC5899
B402917	BERGSTROM	PTAC5041

PN	MANUFACTURER	PRIMATECH
B402966	BERGSTROM	PTAC5030
B402967	BERGSTROM	PTAC5029
B404255	BERGSTROM	PTAC1601
B404291	BERGSTROM	PTAC1601
F37-6000C	BERGSTROM	PTAC7393
RD-4-4069-0	REDDOT	PTAC2104
RD-4-6415-0P	REDDOT	PTAC6331
RD-4-7277-0P	REDDOT	PTAC6350
RD-4-7279-0P	REDDOT	PTAC6368
RD-4-7280-0P	REDDOT	PTAC6288
RD-4-7284-0P	REDDOT	PTAC6205
RD-5-1011670	REDDOT	PTAC1493
RD-5-10166-0	REDDOT	PTAC1492
RD-5-10179-0	REDDOT	PTAC1602
RD-5-10261-0DS	REDDOT	PTAC5320
RD-5-10266-0	REDDOT	PTAC5330
RD-5-10266-0DS	REDDOT	PTAC5330
RD-5-10266-0P	REDDOT	PTAC5330
RD-5-10267-0P	REDDOT	PTAC5331
RD-5-10273-0	REDDOT	PTAC5362
RD5-10276-0	REDDOT	PTAC5380
RD-5-10276-0	REDDOT	PTAC5380
RD-5-10276-0DS	REDDOT	PTAC5380
RD-5-10276-0P	REDDOT	PTAC5380
RD-5-10284-0P	REDDOT	PTAC5705
RD-5-10341-0	REDDOT	PTAC1233
RD-5-10363-0	REDDOT	PTAC5126
RD-5-10365-0	REDDOT	PTAC5128
RD-5-10366-0	REDDOT	PTAC5129
RD-5-10370-0	REDDOT	PTAC5041
RD-5-10397-0	REDDOT	PTAC5032
RD-5-10433-0	REDDOT	PTAC1233
RD-5-10738-0DS	REDDOT	PTAC5349
RD-5-10738-0P	REDDOT	PTAC5349
RD-5-10753-0	REDDOT	PTAC3741
RD-5-10853-0P	REDDOT	PTAC7135
RD-5-11237-0	REDDOT	PTAC5770
RD-5-11237-0DS	REDDOT	PTAC5770
RD-5-11237-0P	REDDOT	PTAC5770
RD-5-11240-0P	REDDOT	PTAC5771

PN	MANUFACTURER	PRIMATECH
RD-5-11249-0P	REDDOT	PTAC5331
RD-5-11250-0P	REDDOT	PTAC5348
RD-5-11251-0P	REDDOT	PTAC5333
RD-5-11252-0DS	REDDOT	PTAC5770
RD-5-11252-0P	REDDOT	PTAC5770
RD-5-11253-0	REDDOT	PTAC5770
RD-5-11256-0P	REDDOT	PTAC5385
RD-5-11257-0P	REDDOT	PTAC5387
RD-5-11315-0	REDDOT	PTAC5327
RD-5-11315-0P	REDDOT	PTAC5327
RD-5-11316-0P	REDDOT	PTAC5764
RD5-11326-0	REDDOT	PTAC5707
RD-5-11326-0	REDDOT	PTAC5707
RD-5-11326-0DS	REDDOT	PTAC5707
RD-5-11326-0P	REDDOT	PTAC5707
RD-5-11337-0	REDDOT	PTAC5726
RD-5-11339-0P	REDDOT	PTAC5334
RD-5-11343-0P	REDDOT	PTAC5384
RD-5-11345-0	REDDOT	PTAC5726
RD-5-11357-0	REDDOT	PTAC5347
RD5-12330-0P	REDDOT	PTAC5339
RD-5-12332-0P	REDDOT	PTAC5366
RD-5-12334-0P	REDDOT	PTAC5365
RD-5-12334-0P	REDDOT	PTAC5365SD
RD-5-12523-0P	REDDOT	PTAC5373
RD-5-13062-0DS	REDDOT	PTAC5333SD
RD-5-13209-0DS	REDDOT	PTAC5362SD
RD-5-13210-0DS	REDDOT	PTAC5402
RD-5-13248-0P	REDDOT	PTAC5404
RD-5-3593-0	REDDOT	PTAC7141
RD-5-3646-0	REDDOT	PTAC1150
RD-5-3647-0	REDDOT	PTAC1220
RD-5-3780-0	REDDOT	PTAC3393
RD5-4383-0P	REDDOT	PTAC1560
RD-5-4383-0P	REDDOT	PTAC1550
RD-5-4383-0P	REDDOT	PTAC1560
RD5-4585-0P	REDDOT	PTAC1560
RD-5-4585-0P	REDDOT	PTAC1550
RD-5-4585-0P	REDDOT	PTAC1560
RD-5-4625-0	REDDOT	PTAC1565

CROSS REFERENCE

PN	MANUFACTURER	PRIMATECH
RD-5-4923-0	REDDOT	PTAC2104
RD-5-4959-0	REDDOT	PTAC7130
RD-5-4966-0	REDDOT	PTAC5031
RD-5-4987-0	REDDOT	PTAC5041
RD-5-4994-0	REDDOT	PTAC5041
RD-5-5190-0	REDDOT	PTAC3231
RD-5-5230-0	REDDOT	PTAC3512
RD-5-5443-0P	REDDOT	PTAC5920
RD-5-5876-0	REDDOT	PTAC5811
RD-5-6405-0	REDDOT	PTAC7132
RD-5-6504-0	REDDOT	PTAC7132
RD-5-6868-0	REDDOT	PTAC1601
RD-5-7101-0	REDDOT	PTAC5256
RD-5-7120-0P	REDDOT	PTAC5727
RD-5-7122-0	REDDOT	PTAC5726
RD-5-7124-0P	REDDOT	PTAC5752
RD5-7145-0	REDDOT	PTAC5711
RD-5-7522-0	REDDOT	PTAC5726
RD-5-7522-0DS	REDDOT	PTAC5726
RD-5-7522-0P	REDDOT	PTAC5726
RD-5-7563-0P	REDDOT	PTAC7230
RD-5-7613-0	REDDOT	PTAC5513
RD-5-7614-0	REDDOT	PTAC5514
RD-5-7760-2	REDDOT	PTAC2104
RD-5-8029-0	REDDOT	PTAC3051
RD-5-8100-0	REDDOT	PTAC1614
RD-5-8218-0	REDDOT	PTAC1437
RD-5-8218-0P	REDDOT	PTAC1437
RD-5-8220-0	REDDOT	PTAC1439
RD-5-8287-0	REDDOT	PTAC1498
RD-5-8287-0	REDDOT	PTAC1499
RD-5-8288-0	REDDOT	PTAC1498
RD-5-8288-0	REDDOT	PTAC1499
RD-5-8333-0	REDDOT	PTAC3772
RD-5-86380	REDDOT	PTAC5256
RD-5-8638-0	REDDOT	PTAC5256
RD-5-8638-1P	REDDOT	PTAC5256
RD-5-8767-0	REDDOT	PTAC5899
RD-5-8767-0P	REDDOT	PTAC5899
RD-5-8937-0	REDDOT	PTAC5031

PN	MANUFACTURER	PRIMATECH
RD-5-8946-0	REDDOT	PTAC1437
RD-5-9082-0	REDDOT	PTAC1654
RD-5-9082-0	REDDOT	PTAC1652
RD-5-9084-0	REDDOT	PTAC8916
RD-5-9084-0M	REDDOT	PTAC8916
RD-5-9419-0P	REDDOT	PTAC7555
RD-5-9807-0	REDDOT	PTAC1651
RD-5-9915-0	REDDOT	PTAC1252

PART TO PAGE REFERENCE

PN	PG	PN	PG	PN	PG	PN	PG	PN	PG
PTAC1150	18	PTAC3772	14	PTAC6948	17	PTACMT0098	22	PTACMT0369	22
PTAC1220	18	PTAC3941	14	PTAC7126	16	PTACMT0099	22	PTACMT0370	22
PTAC1223P	18	PTAC3972	14	PTAC7141	16	PTACMT0105	22	PTACMT0371	22
PTAC1224	18	PTAC5030	10	PTAC7159	16	PTACMT0115	22	PTACMT0395	22
PTAC1233	18	PTAC5031	10	PTAC7169	16	PTACMT0120	23	PTACMT0628	23
PTAC1243	18	PTAC5044	10	PTAC7197	16	PTACMT0121	23	PTACMT0629	23
PTAC1248	18	PTAC5128	10	PTAC7230	16	PTACMT0145	23	PTACMT0641	23
PTAC1265	18	PTAC5129	10	PTAC7387	16	PTACMT0157	22	PTACMT0829	22
PTAC1293	18	PTAC5131	11	PTAC7415	16	PTACMT0158	23	PTACMT1243	22
PTAC1324	18	PTAC5144	11	PTAC7416	17	PTACMT0160	22	PTACMT1299	22
PTAC1342	18	PTAC5145	11	PTAC7417	17	PTACMT0161	23	PTACMT1310	22
PTAC1437	18	PTAC5164	11	PTAC7493	17	PTACMT0162	23	PTACMT1318	22
PTAC1439	18	PTAC5256	3	PTAC7555	17	PTACMT0163	23	PTACMT1319	22
PTAC1459	18	PTAC5269	3	PTAC7585	17	PTACMT0177	22	PTACMT1320	22
PTAC1489	18	PTAC5320	3	PTAC8202	19	PTACMT0178	22	PTACMT1321	22
PTAC1492	18	PTAC5327	3	PTAC8203	19	PTACMT0187	23	PTACMT1322	23
PTAC1493	18	PTAC5333	3	PTAC8206	19	PTACMT0188	23	PTACMT1343	22
PTAC1498	18	PTAC5339	4	PTAC8207	19	PTACMT0191	23	PTACMT1425	22
PTAC1499	18	PTAC5347	4	PTAC8208	19	PTACMT0192	23	PTACMT1426	23
PTAC1513	18	PTAC5348	4	PTAC8227	19	PTACMT0193	23	PTACMT1427	22
PTAC1514	18	PTAC5362	4	PTAC8228	19	PTACMT0199	23	PTACMT1428	22
PTAC1515	18	PTAC5362SD	5	PTAC8229	19	PTACMT0228	22	PTACMT1429	22
PTAC1519	18	PTAC5365	5	PTAC8230	19	PTACMT0234	23	PTACMT1471	23
PTAC1546	18	PTAC5365SD	5	PTAC8248	19	PTACMT0235	23	PTACMT1473	23
PTAC1550	18	PTAC5366	5	PTAC8256	19	PTACMT0236	22	PTACMT1474	23
PTAC1560	18	PTAC5373	6	PTAC8811	19	PTACMT0237	23	PTACMT1544	23
PTAC1565	18	PTAC5384	6	PTAC8812	19	PTACMT0238	22	PTACMT1587	22
PTAC1600	15	PTAC5385	6	PTAC8916	18	PTACMT0242	23	PTACMT1588	22
PTAC1602	15	PTAC5395	7	PTAC9245A	12	PTACMT0243	23	PTACMT1589	22
PTAC1612	15	PTAC5398	6	PTACMT0004	22	PTACMT0244	22	PTACMT1606	22
PTAC1614	15	PTAC5398	7	PTACMT0005	23	PTACMT0245	22	PTACMT1607	22
PTAC1619	15	PTAC5402	7	PTACMT0030	23	PTACMT0250	23	PTACMT1608	22
PTAC1621	15	PTAC5403	7	PTACMT0050	23	PTACMT0258	23	PTACMT1609	22
PTAC1622	15	PTAC5404	8	PTACMT0054	22	PTACMT0260	22	PTACMT1702	23
PTAC1632	15	PTAC54546	8	PTACMT0058	23	PTACMT0261	23	PTACMT1708	22
PTAC1651	19	PTAC5513	18	PTACMT0059	23	PTACMT0262	22	PTACMT1709	22
PTAC1652	19	PTAC5514	18	PTACMT0061	23	PTACMT0267	23	PTACMT2161	23
PTAC1654	19	PTAC5764	8	PTACMT0062	23	PTACMT0269	23	PTACMT2170	23
PTAC1662	19	PTAC5770	8	PTACMT0063	23	PTACMT0272	22	PTACMT8000	23
PTAC1663	19	PTAC5771	9	PTACMT0064	23	PTACMT0272	22	PTACMT8001	23
PTAC1672	15	PTAC5923A	9	PTACMT0065	23	PTACMT0273	23	PTACMT8002	23
PTAC2104	18	PTAC6283	12	PTACMT0067	23	PTACMT0274	22	PTACMT8003	23
PTAC2386	18	PTAC6288	12	PTACMT0068	23	PTACMT0301	23	PTACMT8009	23
PTAC3051	14	PTAC6292	12	PTACMT0069	23	PTACMT0303	22	PTACMT9260	20
PTAC3129	14	PTAC6319	12	PTACMT0091	22	PTACMT0304	22	PTACMT9660	21
PTAC3267	14	PTAC6345	12	PTACMT0092	22	PTACMT0334	23	PTACMT9661	21
PTAC3393	14	PTAC6350	12	PTACMT0093	22	PTACMT0335	22	PTACMT9662	21
PTAC3512	14	PTAC6368	12	PTACMT0094	22	PTACMT0342	23	PTACMT9663	21
PTAC3514	14	PTAC6609	17	PTACMT0095	22	PTACMT0344	22		
PTAC3741	14	PTAC6636	17	PTACMT0097	22	PTACMT0345	22		



WARRANTY TERMS & CONDITIONS

All PrimaTech® Air Conditioning Components will be free from defects in material and workmanship for one year, unlimited mileage with the following exceptions:

- 1 - Air Conditioning Compressors: Failure to follow the Compressor Replacement Process outlined on the following page will void the warranty.
- 2 - Warranty can be processed nationwide by any PrimaTech distributor, regardless of where the product was initially purchased. Only PrimaTech products will be processed for warranty. If a product is warrantable, only the product will be replaced.
- 3 - Products rendered defective by misapplication, contamination, abuse, alteration or any change/adjustment are not warrantable. It is the user's responsibility to determine the suitability of any product to their specific application. Any product disassembly voids all warranty.
- 4 - There are no warranties or conditions beyond this document and no person is granted authorization to express or imply additional warranty or liability. The buyer's sole remedy for a warranted product is replacement of product per conditions above. In no event shall PrimaTech, its agents or employees be responsible for incidental or consequential damages nor negligence in any respect.

COMPRESSOR REPLACEMENT PROCESS

COMPRESSOR REPLACEMENT PROCESS

- Replace the accumulator or receiver drier.
- Replace the expansion device (orifice tube, expansion valve or liquid line containing the orifice tube).
- Replace the hose assemblies containing mufflers (these cannot be flushed).
- Closed loop flushing of components not replaced must be done.
- Catastrophic compressor failure requires the replacement of any parallel flow or serpentine style condenser.
- Install an in-line suction or liquid line filter.
- Use only approved R134a or R12 refrigerants. Blend or hydrocarbon refrigerants of any kind are unacceptable and will VOID all warranties.
- Where a parallel flow condenser is used, the condenser must be replaced as it cannot be flushed or cleaned.

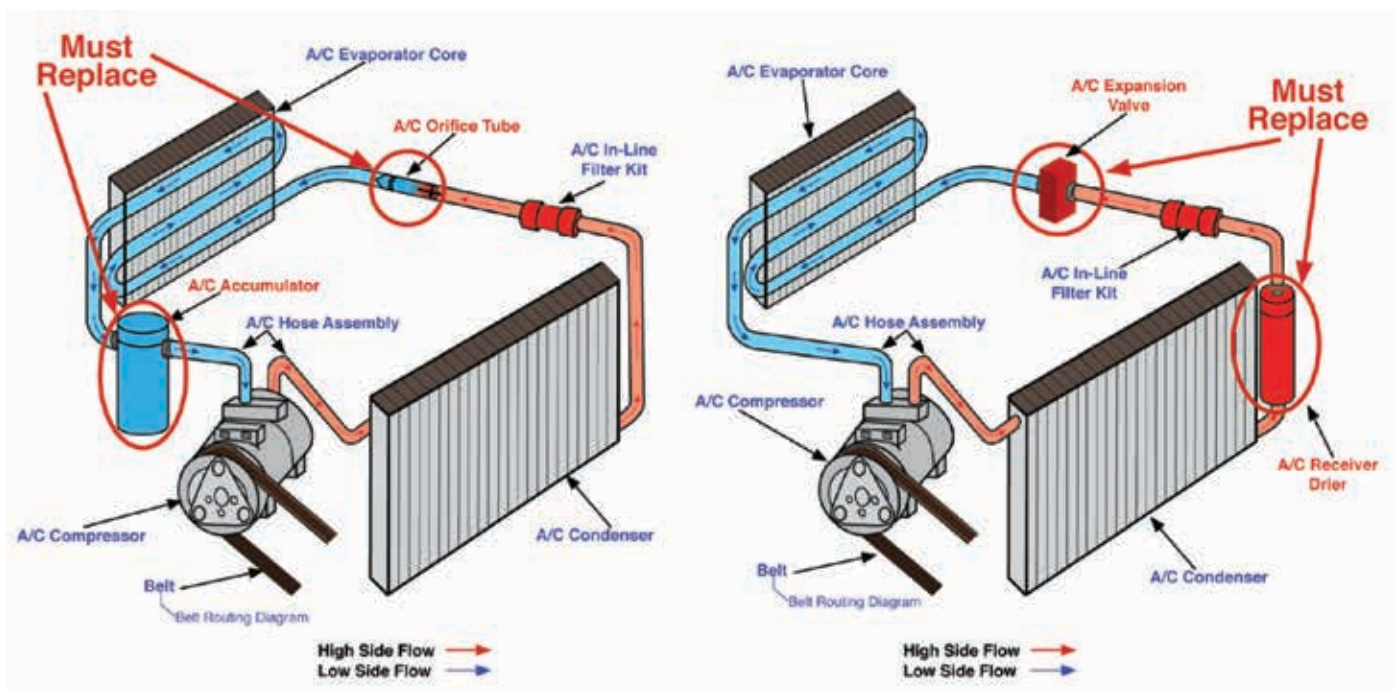

***Failure to follow this process will void all compressor warranty claims.
Documentation may be required.***

PRIMATECH[®]
— PREMIER HIGHWAY PRODUCTS —

www.PrimaBrands.com

PTC300L-2
3/2014

PRIMA[®]TECH

PREMIER HIGHWAY PRODUCTS