









New products

2015.2



	MILLING TOOLS		MILLING TOOLS
	• Face milling cutters		4
	• Shoulder milling cutters		10
	• Copy milling cutters		30
	MILLING INSERTS		54
	TURNING INSERTS		78
	DRILLING INSERTS		124
	TECHNICAL SECTION		129
	• Milling		131
	• Turning		156
	• Drilling		174
			TECHNICAL SECTION

NEW PRODUCTS FOR MACHINING STAINLESS MATERIALS

MILLING:

New range of face milling cutters



ECONOMICAL OFFER

OEHT inserts with 8 cutting edges. Optional round inserts REHT and wiper insert XEHT

Page..... 6

New inserts for milling



COMPREHENSIVE RANGE

Positive geometries - MF and MM - for machining stainless steel

Page..... 55

New range of helical milling cutters



PRODUCTIVE TOOL

Depth of cut up to 108 mm

Page..... 15

TURNING:

New inserts for turning
of difficult-to-machine materials

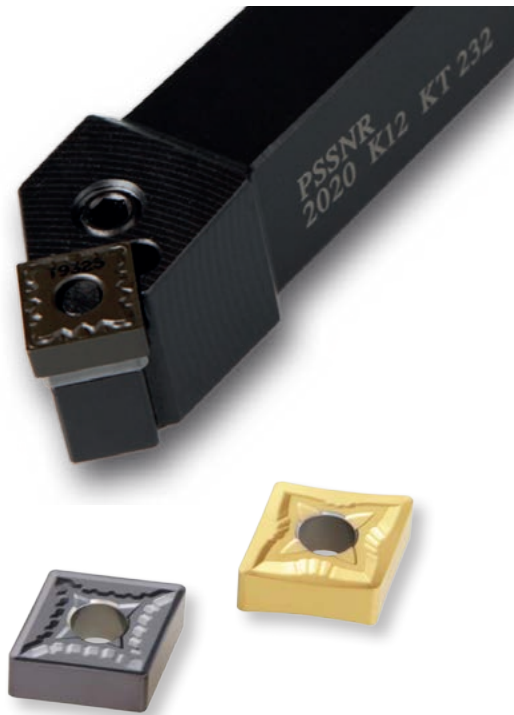

RELIABILITY AND DURABILITY

Positive chip-breakers SF, SM and new grades



DRILLING:

New inserts for drilling
long-chip materials



PERFORMANCE AND EXPANDED
APPLICATIONS

Chip-breaker SD optimised for mild steel and
stainless steel

FACE MILLING CUTTERS





NEW RANGE OF FACE MILLING CUTTERS FOR MACHINING STAINLESS STEELS

A versatile range of new milling cutters and inserts with geometries designed for face milling adhesive and soft materials. These include inserts featuring eight cutting edges for economical milling of stainless steels.

NEW PRODUCTS

- **Wide range of milling cutters** - 50-200 mm diameter, including diameters of copy milling cutters
- **Octagonal inserts** OEHT 06 for depths 3,3 - 10,7 mm
- Round inserts REHT 16, for face and copy milling
- Inserts XEHT 06 with wiper cutting edge
- **New geometries** designed for machining stainless steels

BENEFITS

- **Economical** OEHT inserts feature eight cutting edges
- **Comprehensive** range: New milling cutters, inserts and geometries – all specially designed for stainless steels
- **Versatile** tool: A wide range of inserts can be clamped into the same milling cutter – octagonal, round and wiper inserts.
- Versatile applications: For a wide range of materials
- Suitable for unstable conditions and machining fragile components

INSERTS

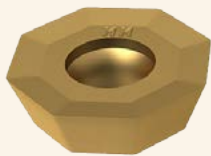

OEHT

INSERT OEHT

Positive geometry

- 8 cutting edges
- Suitable for machining stainless steels, high temperature alloys, general steels and non ferrous metals

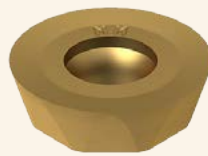

REHT

INSERT REHT

Geometry with a positive rake angle

- Suitable for machining stainless steels, high temperature alloys and general steels.
- Designed especially for light and medium machining

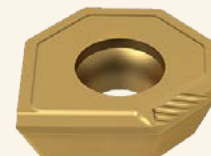

XEHT

INSERT XEHT

Wiper geometry with a slightly positive rake angle

- Wiper insert
- Suitable for machining general steels and also stainless steels and high temperature alloys
- Geometry suited to light cutting conditions



Each milling cutter supports internal delivery of coolant (incl. larger milling cutter diameters of 160 and 200 mm).

S450E06Z

FACE MILLING CUTTERS

OEHT - MACHINING EXAMPLE

Material: DIN 1.4404 / X2CrNiMo 17-12-2

Insert: **OEHT 0604AEER-MM: M8340**

Coolant: No

Cutting speed	v_c	140	m.min ⁻¹
Feed per tooth	f_z	0,15	mm.zub ⁻¹
Axial length of cut	a_p	2,5	mm

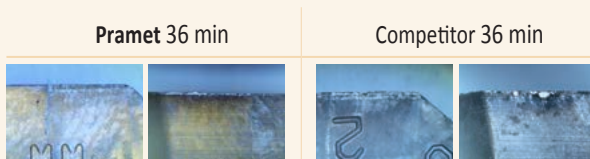

Total time [min]	Pramet	Competitor
	58	36

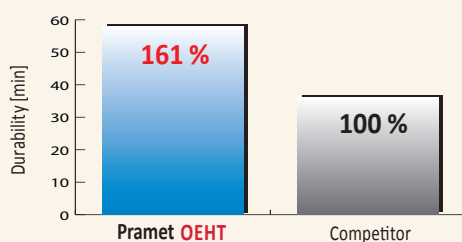
**REHT - MACHINING EXAMPLE**

Material: DIN 1.4404 / X2CrNiMo 17-12-2

Insert: **REHT 1604M0EN-MM: M8340**

Coolant: No

Cutting speed	v_c	160	m.min ⁻¹
Feed per tooth	f_z	0,15	mm.zub ⁻¹
Axial length of cut	a_p	2,0	mm

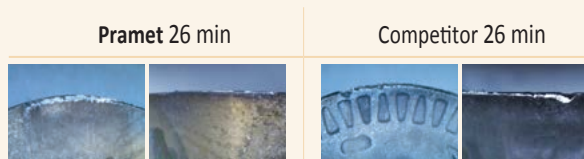

Total time [min]	Pramet	Competitor
	54	26

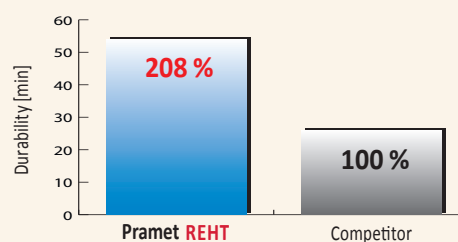
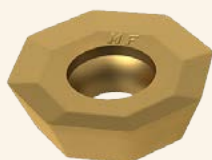
**OEHT INSERT GEOMETRIES****MF****GEOMETRY MF**

Sharp and highly positive geometry

- Primary choice for **finishing operations**
- For machining stainless steel, mild carbon steel, and non-ferrous metals

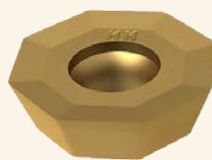
**MM****GEOMETRY MM**

Sharp and positive geometry

- Primary choice for **standard stainless steels**
- For machining stainless steel, mild carbon steel, non-ferrous metals and superalloys

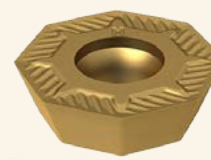
**M****GEOMETRY M**

Positive geometry with stabiliser

- Suitable for **unstable cutting conditions**
- For machining carbon steels and harder stainless steels

S45OE06Z-C

FACE MILLING CUTTERS

MILLING TOOLS



MILLING INSERTS

γ_p	+10°	κ_r	43°
γ_f	+1° ÷ +6°	$a_{p\max}$	3,3 (10,7) mm

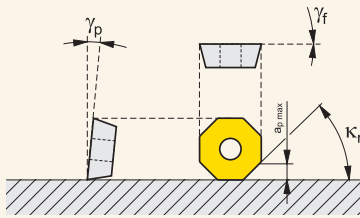

TURNING INSERTS

DRILLING INSERTS

TECHNICAL SECTION

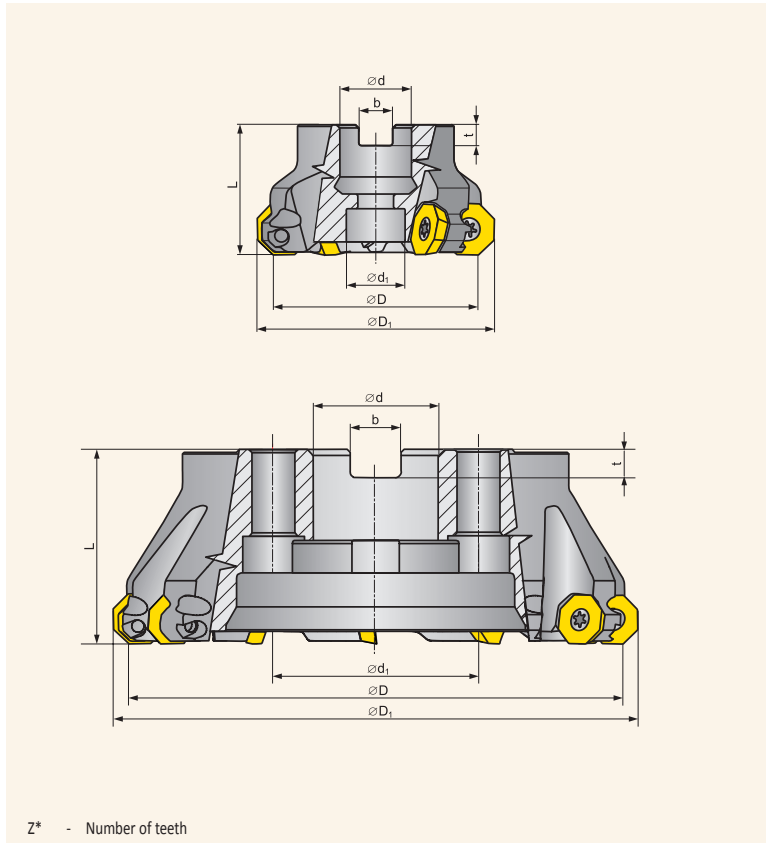

ISO	Assortment	Dimensions [mm]								Cooling	[kg]	
		D	d	d ₁	L	D ₁	b	t	Z*			
50A04R-S45OE06Z-C	●	50	22	18	40	60,2	10,4	6,3	4		+	0,3
50A05R-S45OE06Z-C	●	50	22	18	40	60,0	10,4	6,3	5		+	0,3
56A05R-S45OE06Z-C	●	56	22	18	40	66,0	10,4	6,3	5		+	0,4
63A04R-S45OE06Z-C	●	63	22	18	40	73,2	10,4	6,3	4		+	0,5
63A06R-S45OE06Z-C	●	63	22	18	40	73,0	10,4	6,3	6		+	0,5
70A06R-S45OE06Z-C	●	70	22	18	40	80,0	10,4	6,3	6		+	0,6
80A05R-S45OE06Z-C	●	80	27	38	50	90,2	12,4	7	5		+	0,9
80A06R-S45OE06Z-C	●	80	27	38	50	90,2	12,4	7	6		+	1,0
90A07R-S45OE06Z-C	●	90	32	45	50	100,0	14,4	8	7		+	1,4
100A06R-S45OE06Z-C	●	100	32	45	50	110,2	14,4	8	6		+	1,6
100A08R-S45OE06Z-C	●	100	32	45	50	109,9	14,4	8	8		+	1,7
125A07R-S45OE06Z-C	●	125	40	56	63	135,2	16,4	9	7		+	3,1
125A09R-S45OE06Z-C	●	125	40	56	63	134,9	16,4	9	9		+	3,1
160C09R-S45OE06Z-C	●	160	40	66,7	63	170,2	16,4	9	9		+	5,0
160C12R-S45OE06Z-C	●	160	40	66,7	63	169,9	16,4	9	12		+	5,1
200C11R-S45OE06Z-C	●	200	60	101,6	63	210,2	25,7	14	11		+	8,1
200C14R-S45OE06Z-C	●	200	60	101,6	63	209,9	25,7	14	14		+	8,3

● New item in the assortment

● Stock assortment ○ Non-stock assortment All dimensions [mm]
See latest price list for current availability

S450E06Z-C

FACE MILLING CUTTERS

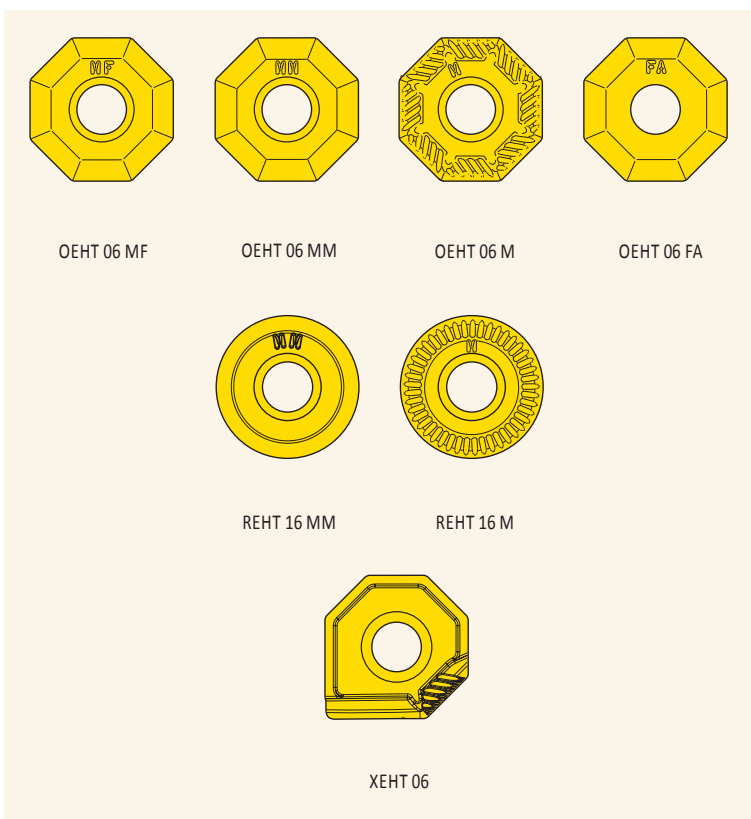
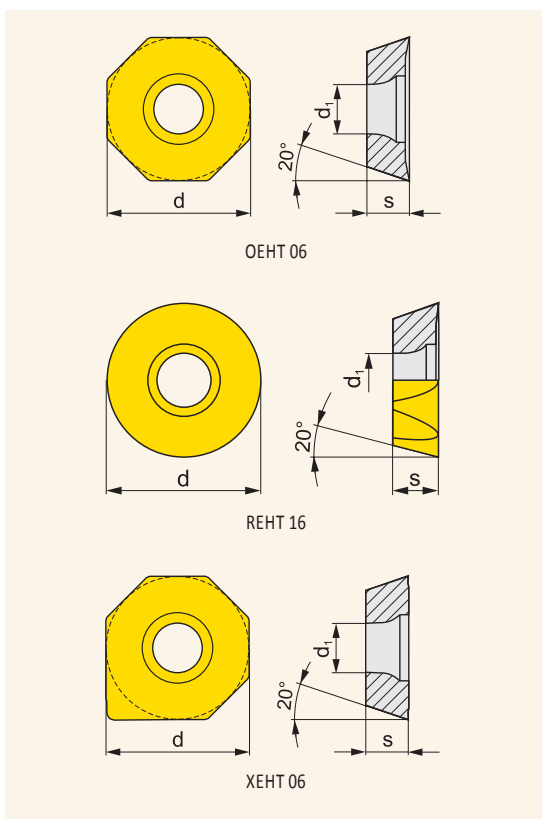

INDEXABLE CUTTING INSERTS

ISO	Grades							Dimensions [mm]			
	M0315	M9325	M8310	M8340	8230	HF7		d	s	d ₁	
OEHT 0604AEER-MF			●	●	●			16,050	4,760	5,50	
OEHT 0604AEER-MM		●	●	●	●			16,050	4,760	5,50	
OEHT 0604AESR-M		●	●	●	●			16,050	4,760	5,50	
REHT 1604MOEN-MM		●	●	●	●			16,000	4,760	5,50	
REHT 1604MOSN-M		●	●	●	●			16,000	4,760	5,50	
OEHT 0604AEFR-FA	●					●		16,050	4,760	5,50	
XEHT 0604AESR			●					16,050	4,760	5,50	

SPARE PARTS

Diameter of cutter	Clamping screw	Screw for taper clamping	Screw driver	Arbor cover	Cover screw	Screw driver
50÷70	US 5011-T20P	HS 1030C	SDR T20P-T	-	-	-
80÷125	US 5011-T20P	-	SDR T20P-T	-	-	-
160	US 5011-T20P	HS 1240C	SDR T20P-T	CAC160C	HSD 0825C	HXK 5
200	US 5011-T20P	HS 1655C	SDR T20P-T	CAC200C	HSD 1025C	HXK 7

● New item in the assortment

● Stock assortment ○ Non-stock assortment All dimensions [mm]
See latest price list for current availability

SHOULDER MILLING CUTTERS



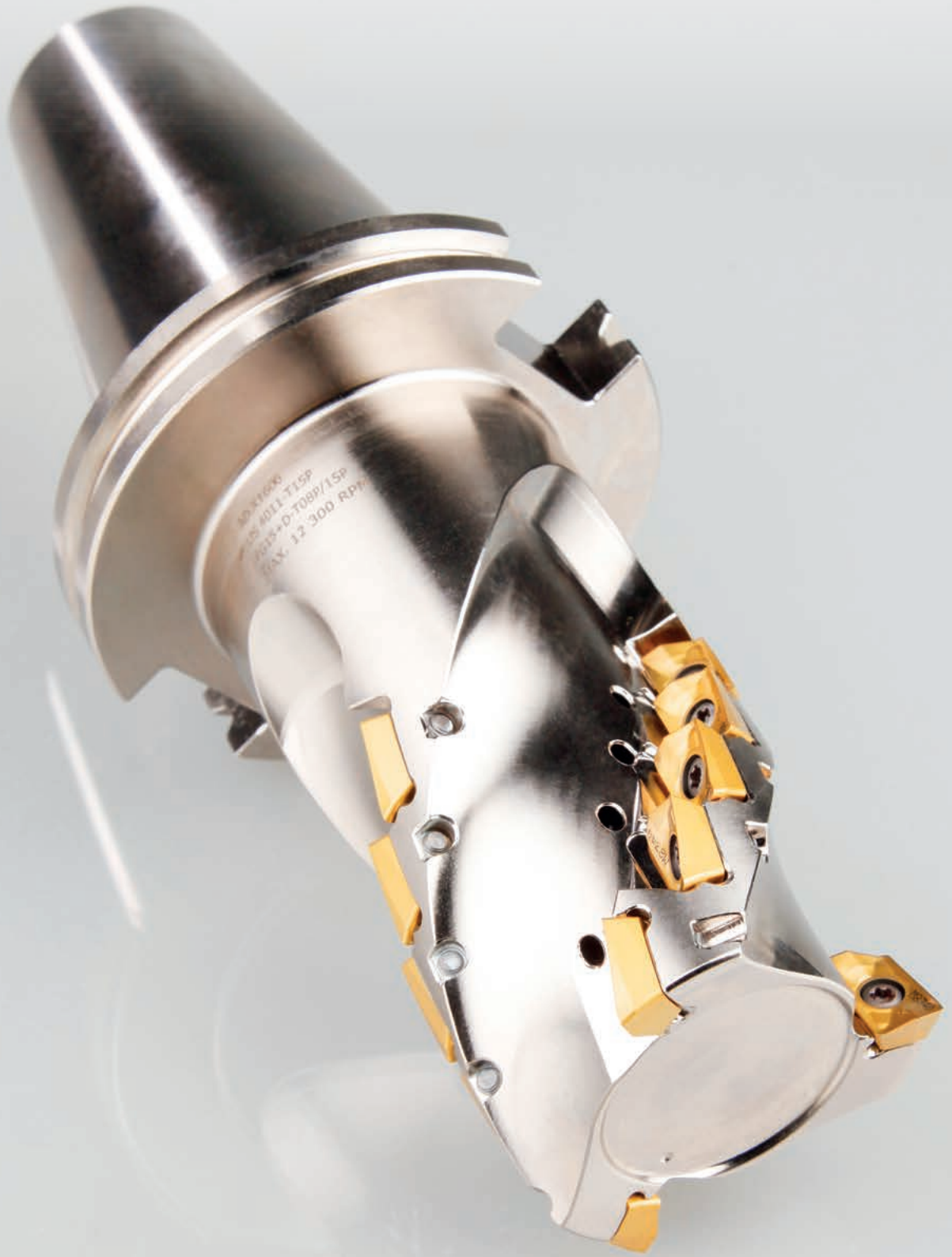

NO. 11640
TYPE H011 T15P
F035-D-7088/15P
MAX. 12 300 RPM

FULL RANGE OF PRODUCTS FOR SHOULDER MILLING

COMPLETE RANGE OF MILLING CUTTERS

PRODUCTIVE AND ECONOMICAL OFFER

WIDE RANGE OF MILLING CUTTER DIAMETERS

END MILLS, MODULAR MILLS AND SHELL-TYPE ROUGHING CYLINDRICAL CUTTERS

PRODUCTIVE

FORCE AD

- ADMX 07
- ADMX / ADEX 11
- ADMX / ADEX 16

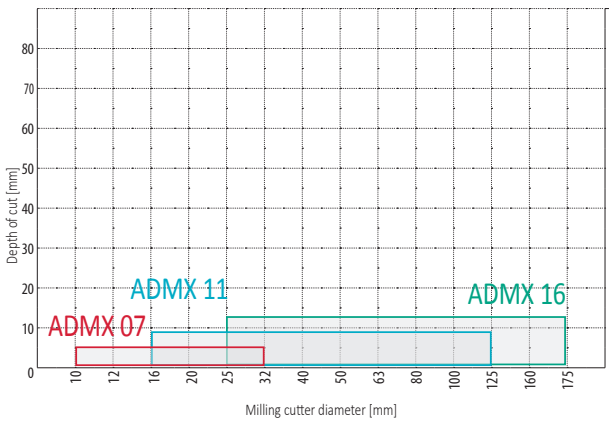
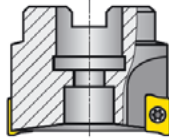

HELICAL AD

- ADMX / ADEX 11
- ADMX / ADEX 16

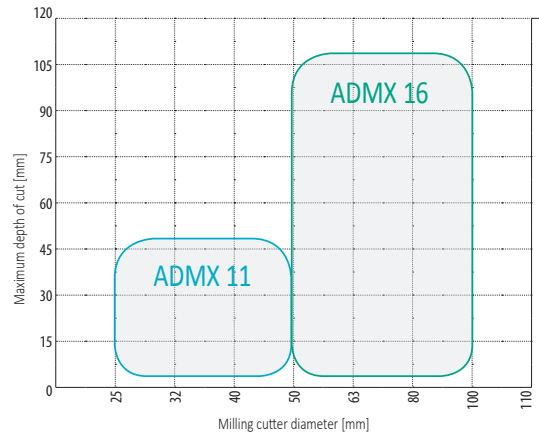

ECONOMICAL

ECON LN

- LNGX / LNGU 12
- LNMU / LNGU 16

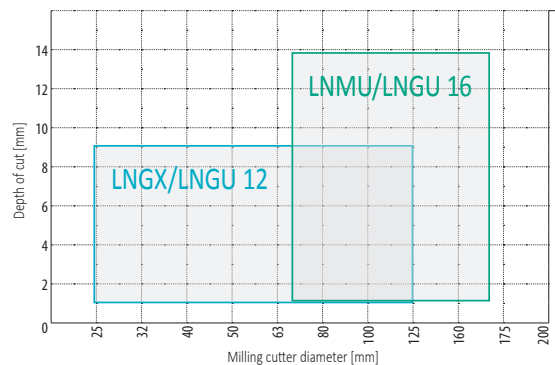
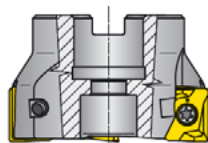

WIDE RANGE OF INSERTS

Radius	0,2mm	0,4mm	0,8mm	1,0mm	1,2mm	1,6mm	2,0mm	2,5mm	3,0mm	3,2mm	4,0mm	5,0mm
AD 07												
AD 11												
AD 16												
LN 12												
LN 16												

NEW
INSERTS FOR
STAINLESS STEEL
(page 55-56)

NEW
INSERTS
LNMU 16
(page 57)

VERSATILE APPLICATIONS



NEW
INSERTS FOR
STAINLESS STEEL
(page 55-56)

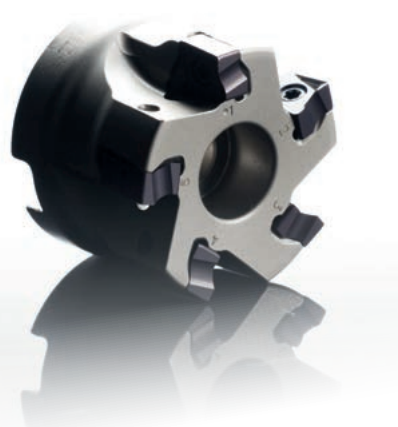

MILLING TOOLS

MILLING INSERTS

TURNING INSERTS

DRILLING INSERTS

TECHNICAL SECTION

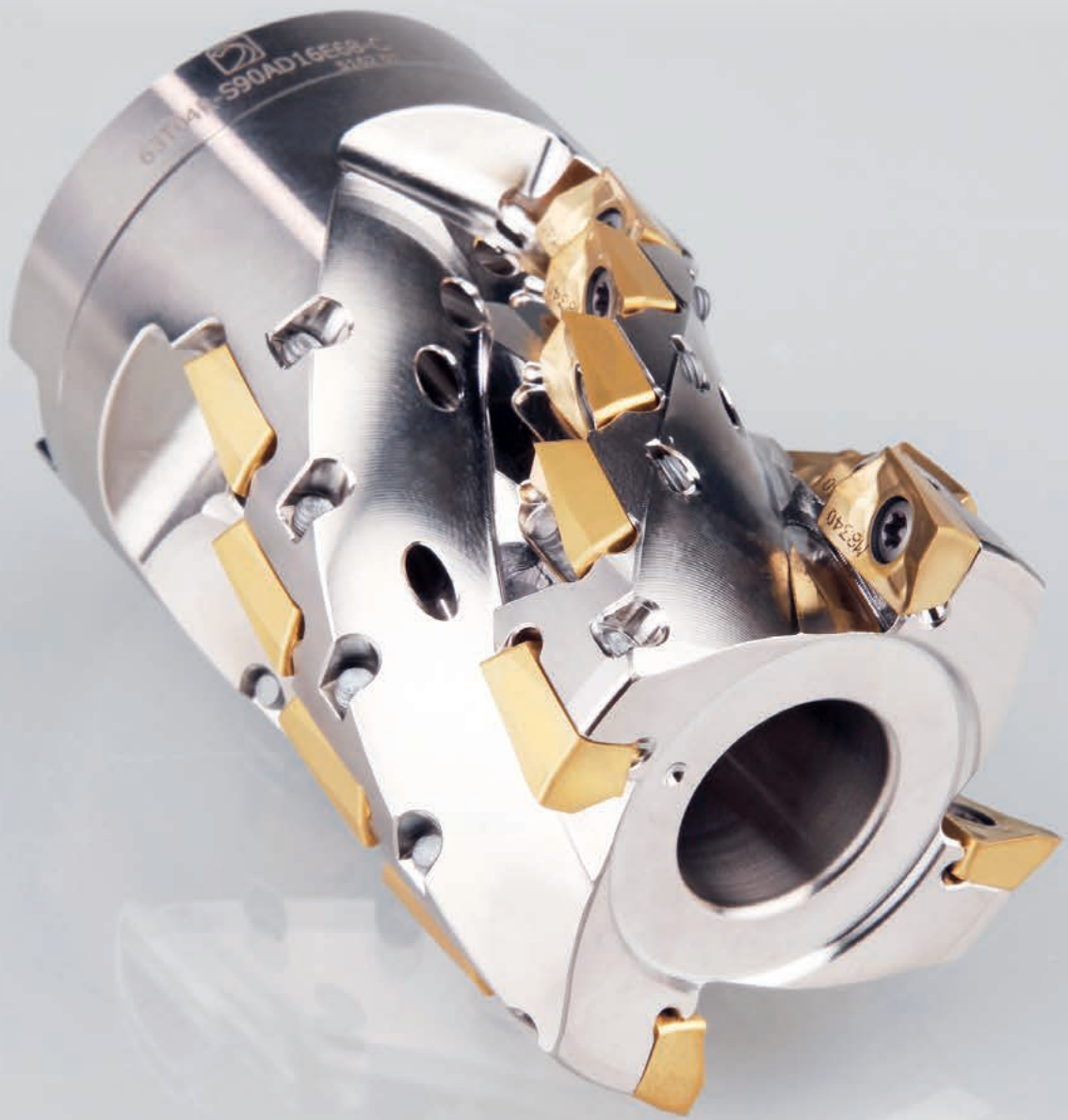

NEW RANGE OF MILLING CUTTERS WITH HELICAL CUTTING EDGES FOR ADMX 16 INSERTS

Our successful Force AD range of shoulder milling cutters has been expanded with the addition of helical milling cutters using the ADMX 16 inserts.

We now offer a complete range of tools for this insert.

NEW PRODUCTS

- New productive helical end mills for roughing
- A wide range of new milling cutters: End mills diameters 50-80 mm and shell end mills diameters 50-100 mm
- Suitable for medium machining all materials including, cast iron, stainless steels and aluminium alloys

BENEFITS

- **Higher metal removal rates** with a depth of cut up to 108 mm
- **Reduced noise and vibration**
- **Reliable** chip evacuation from the cutting zone, even for large cutting depths
- **Compact range** of tools for the ADMX 16 inserts (the same insert type can be used for several milling cutters and applications)
- **Versatile** milling tool for a wide range of applications. Main operations: Contouring, grooving, shoulder milling.

+ Safer and easier chip evacuation

- Large clearance between teeth
- Internal delivery of coolant

+ Highly reliable clamping

- Axial support for inserts increases milling stability, reducing both insert and tool wear

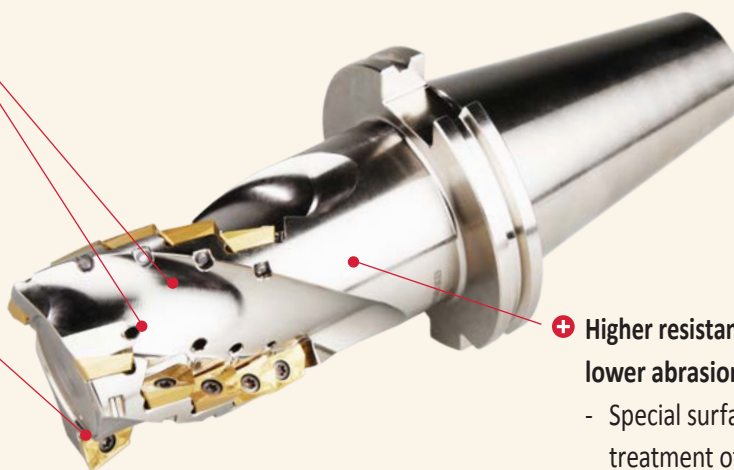

+ Higher resistance to corrosion, lower abrasion of the tool

- Special surface treatment of the body
- nickel plating



The milling cutters are designed for the ADMX160608 inserts. The inserts that are positioned along the helix are required to have a radius of ≤ 0.8 mm.

The inserts on the **end teeth may have radii higher than 0.8 mm, however for radii above 2.0 mm a modification of the pocket/seats is needed.** See page 137 for details.

SAD16E

HELICAL MILLING CUTTERS

MILLING TOOLS



MILLING INSERTS

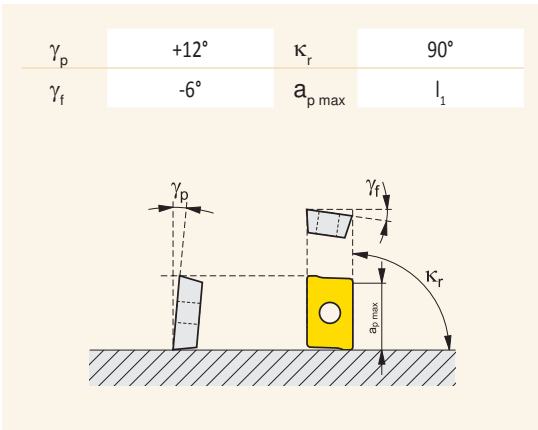

TURNING INSERTS

DRILLING INSERTS

TECHNICAL SECTION

HELICAL AD

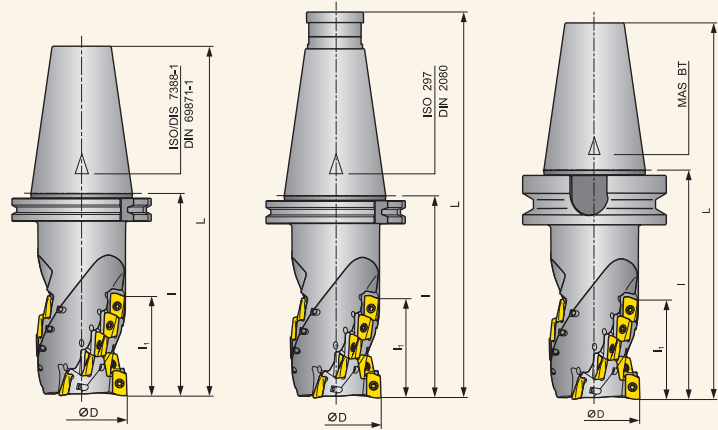

Z* - Number of teeth

ISO	Assortment	Dimensions [mm]								Cooling	[kg]
		D	L	l	l_1	Z*	ZN*	TS*	Taper		
50J3R100H50-SAD16E54-C	●	50	202	100	54	3	12	50	ISO/DIS 7388-1	+	3,2
50J3R140H50-SAD16E80-C	●	50	242	140	80	3	18	50	ISO/DIS 7388-1	+	3,5
63J3R140H50-SAD16E68-C	●	63	242	140	68	3	15	50	ISO/DIS 7388-1	+	4,4
63J3R155H50-SAD16E95-C	●	63	257	155	95	3	21	50	ISO/DIS 7388-1	+	4,6
80J4R165H50-SAD16E108-C	●	80	257	165	108	4	32	50	ISO/DIS 7388-1	+	6,5
50J3R140G50-SAD16E80-C	●	50	267	140	80	3	18	50	ISO 297	+	3,6
63J3R155G50-SAD16E95-C	●	63	282	155	95	3	21	50	ISO 297	+	4,7
80J4R165G50-SAD16E108-C	●	80	292	165	108	4	32	50	ISO 297	+	6,6
50J3R140X50-SAD16E68-C	●	50	242	140	68	3	15	50	MAS BT	+	4,4
63J3R155X50-SAD16E80-C	●	63	257	155	80	3	18	50	MAS BT	+	5,3
80J4R165X50-SAD16E95-C	●	80	267	165	95	4	28	50	MAS BT	+	7,0

● New item in the assortment

● Stock assortment ○ Non-stock assortment All dimensions [mm]
See latest price list for current availability

SAD16E

HELICAL MILLING CUTTERS

ADMX 16

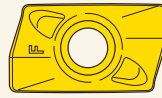
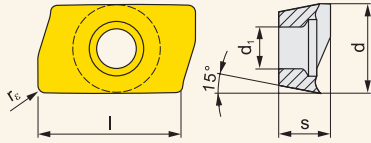

ADMX 16SR-F

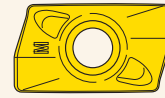

ADMX 16SR-M

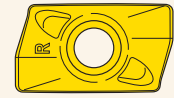

ADMX 16PR-R

ADMX 16 (16)

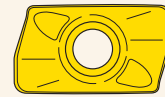
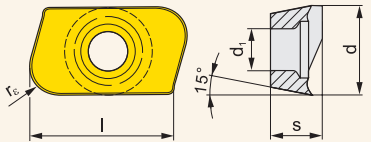

ADMX 160616SR-M

ADMX 16 (40)

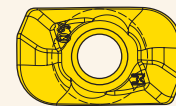
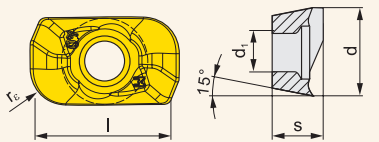

ADMX 160640SR-M

ADMX 16

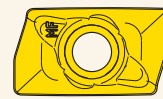
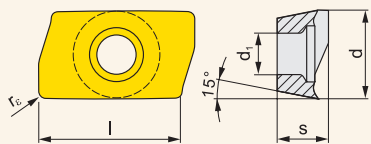

ADMX 160608SR-MF

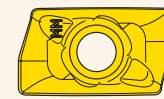

ADMX 160608SR-MM

ADEX 16

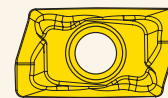
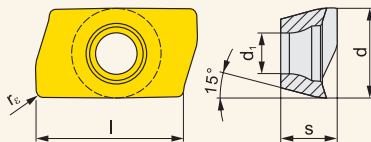

ADEX 16...SR-FM

ADEX 16

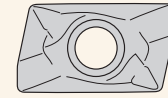
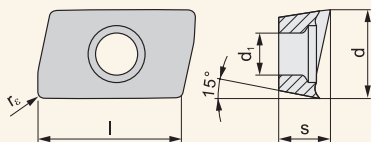

ADEX 16...FR-FA

● New item in the assortment

● Stock assortment ○ Non-stock assortment All dimensions [mm]
See latest price list for current availability



SAD16E

HELICAL MILLING CUTTERS

INDEXABLE CUTTING INSERTS

ISO	Grades											Dimensions [mm]							
	M0315	M5315	M9315	M9325	M9340	M8310	M8340	8215	8230	8240	HF7				(l)	d	s	d ₁	r _e
ADMX 160608SR-F					●	●	●	●	●	●					16,000	9,950	6,25	4,50	0,8
ADMX 160604SR-M						●	●	●							16,000	9,950	6,25	4,50	0,4
ADMX 160608SR-M		●	●	●	●	●	●	●	●						16,000	9,950	6,25	4,50	0,8
ADMX 160616SR-M				●		●	●	●	●						16,000	9,950	6,25	4,50	1,6
ADMX 160620SR-M						●		●							16,000	9,950	6,25	4,50	2,0
ADMX 160630SR-M						●		●							16,000	9,950	6,25	4,50	3,0
ADMX 160632SR-M				●		●	○	●	●						16,000	9,950	6,25	4,50	3,2
ADMX 160640SR-M						●		●							15,680	9,950	6,25	4,50	4,0
ADMX 160650SR-M						●		●							15,680	9,950	6,25	4,50	5,0
ADMX 160608PR-R		●	●	●		●	●	●	●						16,000	9,950	6,25	4,50	0,8
ADMX 160616PR-R		●	●	●		●	●	●							16,000	9,950	6,25	4,50	1,6
ADMX 160608SR-MF							●								16,000	9,950	6,25	4,50	0,8
ADMX 160604SR-MM							●								16,000	9,950	6,25	4,50	0,4
ADMX 160608SR-MM							●								16,000	9,950	6,25	4,50	0,8
ADMX 160616SR-MM							●								16,000	9,950	6,25	4,50	1,6
ADEX 160608SR-FM				●	●	●	●	●	●	●					16,000	9,950	6,25	4,50	0,8
ADEX 160604FR-FA	●										●				16,000	9,950	6,10	4,50	0,8
ADEX 160608FR-FA	●										●				16,000	9,950	6,10	4,50	0,8
ADEX 160616FR-FA	●										●				16,000	9,950	6,10	4,50	1,6
ADEX 160630FR-FA											●				16,000	9,950	6,10	4,50	3,0

SPARE PARTS

	Clamping screw	Shank	Handle
Diameter of cutter			
50 ÷ 80	US 4011-T15P	D-T08P/T15P	FG-15

● New item in the assortment

● Stock assortment ○ Non-stock assortment All dimensions [mm]
See latest price list for current availability



S90AD16E

HELICAL MILLING CUTTERS

MILLING TOOLS



MILLING INSERTS

γ_p	+12°	κ_r	90°
γ_f	-6°	$a_{p\ max}$	l_1

TURNING INSERTS

DRILLING INSERTS

TECHNICAL SECTION

HELICAL AD

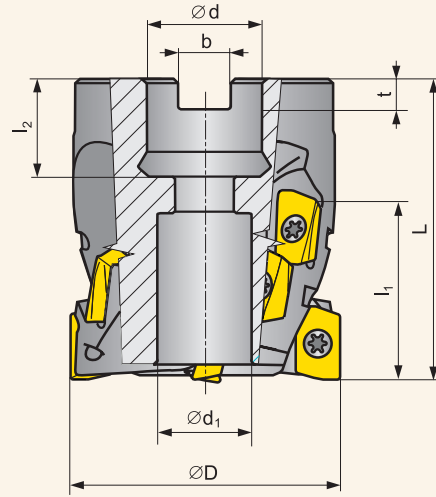

Z* - Number of teeth

ISO	Assortment	Dimensions [mm]								Cooling	[kg]
		D	L	l_1	l_2	d_1	d	Z*	ZN*		
50T03R-S90AD16E40-C	●	50	70	40	21	18	22	3	9	+	0,5
63T04R-S90AD16E40-C	●	63	70	40	22	22	27	4	12	+	0,9
63T04R-S90AD16E68-C	●	63	100	68	22	22	27	4	20	+	1,2
80T04R-S90AD16E55-C	●	80	85	55	25	30	32	4	16	+	1,8
80T04R-S90AD16E80-C	●	80	115	80	25	30	32	4	24	+	2,6
100T05R-S90AD16E80-C	●	100	120	80	30	36	40	5	30	+	4,4

● New item in the assortment ● Stock assortment ○ Non-stock assortment All dimensions [mm]
See latest price list for current availability

S90AD16E

HELICAL MILLING CUTTERS

ADMX 16

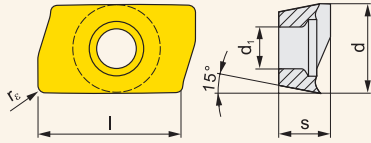

ADMX 16 (16)

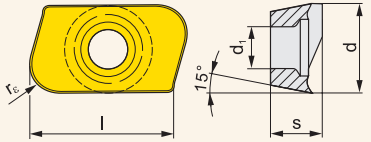

ADMX 16 (40)

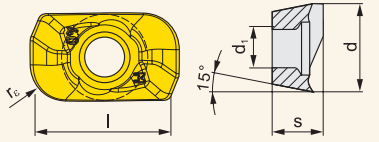

ADMX 16

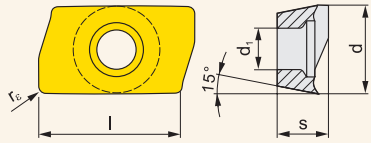

ADEX 16

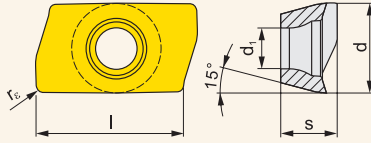

ADEX 16

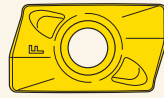
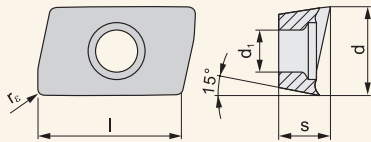

ADMX 16SR-F

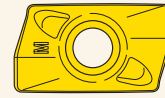

ADMX 16SR-M

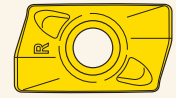

ADMX 16PR-R

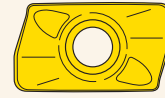

ADMX 160616SR-M

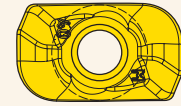

ADMX 160640SR-M

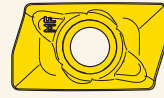

ADMX 160608SR-MF

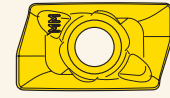

ADMX 160608SR-MM

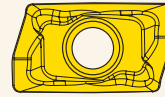

ADEX 16...SR-FM

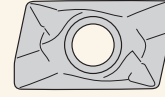

ADEX 16...FR-FA

● New item in the assortment

● Stock assortment ○ Non-stock assortment All dimensions [mm]
See latest price list for current availability





S90AD16E

HELICAL MILLING CUTTERS

INDEXABLE CUTTING INSERTS

ISO	Grades											Dimensions [mm]							
	M0315	M5315	M9315	M9325	M9340	M8310	M8340	8215	8230	8240	HF7				(l)	d	s	d ₁	r _e
ADMX 160608SR-F					●	●	●	●	●	●					16,000	9,950	6,25	4,50	0,8
ADMX 160604SR-M							●	●	●						16,000	9,950	6,25	4,50	0,4
ADMX 160608SR-M		●	●	●	●	●	●	●	●	●					16,000	9,950	6,25	4,50	0,8
ADMX 160616SR-M				●		●	●	●	●	●					16,000	9,950	6,25	4,50	1,6
ADMX 160620SR-M							●		●						16,000	9,950	6,25	4,50	2,0
ADMX 160630SR-M							●		●						16,000	9,950	6,25	4,50	3,0
ADMX 160632SR-M				●			●	○	●	●					16,000	9,950	6,25	4,50	3,2
ADMX 160640SR-M							●		●						15,680	9,950	6,25	4,50	4,0
ADMX 160650SR-M							●		●						15,680	9,950	6,25	4,50	5,0
ADMX 160608PR-R		●	●	●		●	●	●	●	●					16,000	9,950	6,25	4,50	0,8
ADMX 160616PR-R		●	●	●			●	●	●						16,000	9,950	6,25	4,50	1,6
ADMX 160608SR-MF							●								16,000	9,950	6,25	4,50	0,8
ADMX 160604SR-MM							●								16,000	9,950	6,25	4,50	0,4
ADMX 160608SR-MM							●								16,000	9,950	6,25	4,50	0,8
ADMX 160616SR-MM							●								16,000	9,950	6,25	4,50	1,6
ADEX 160608SR-FM				●	●	●	●	●	●	●					16,000	9,950	6,25	4,50	0,8
ADEX 160604FR-FA	●										●				16,000	9,950	6,10	4,50	0,8
ADEX 160608FR-FA	●										●				16,000	9,950	6,10	4,50	0,8
ADEX 160616FR-FA	●										●				16,000	9,950	6,10	4,50	1,6
ADEX 160630FR-FA											●				16,000	9,950	6,10	4,50	3,0

SPARE PARTS

Diameter of cutter	Clamping screw	Shank	Handle	Screw for taper clamping
50	 US 4011-T15P	 D-T08P/T15P	 FG-15	 HS 1030C
63	US 4011-T15P	D-T08P/T15P	FG-15	HS 1230C
80	US 4011-T15P	D-T08P/T15P	FG-15	HS 1630C
100	US 4011-T15P	D-T08P/T15P	FG-15	HS 2040C

● New item in the assortment

● Stock assortment ○ Non-stock assortment All dimensions [mm]
See latest price list for current availability



SAD11E

SHOULDER MILLING CUTTERS

MILLING TOOLS



MILLING INSERTS

γ_p	$+4^\circ \div +8^\circ$	κ_r	90°
γ_f	$-9^\circ \div -12,8^\circ$	$a_{p\max}$	9 mm

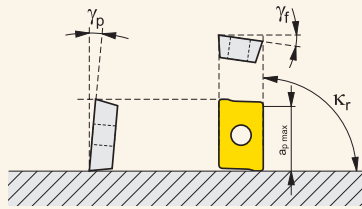

TURNING INSERTS

DRILLING INSERTS

TECHNICAL SECTION

FORCE AD

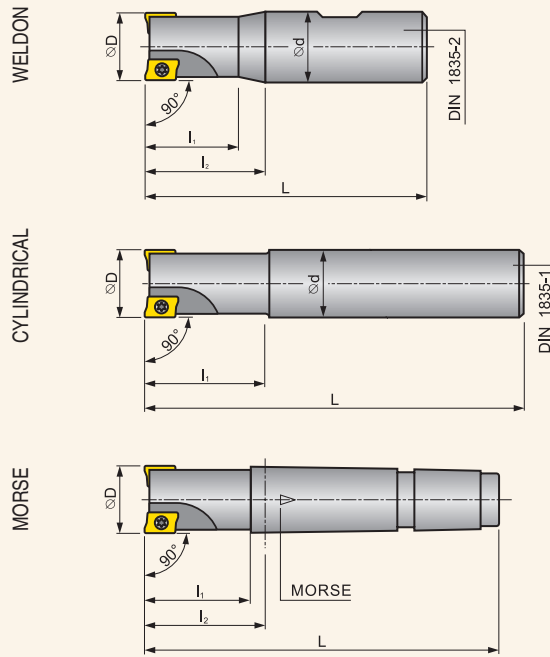

Z* - Number of teeth

ISO	Assortment	Dimensions [mm]							Cooling	[kg]	
		D	L	l_1	l_2	d	Morse	Z*			
WELDON											
16A2R027B16-SAD11E-C	●	16	75	27	-	16	-	2		+	0,1
20A2R032B20-SAD11E-C	●	20	82	32	-	20	-	2		+	0,2
20A3R032B20-SAD11E-C	●	20	82	32	-	20	-	3		+	0,2
25A3R042B25-SAD11E-C	●	25	98	42	-	25	-	3		+	0,3
25A4R042B25-SAD11E-C	●	25	98	42	-	25	-	4		+	0,3
32A4R042B32-SAD11E-C	●	32	102	42	-	32	-	4		+	0,4
32A5R042B32-SAD11E-C	●	32	102	42	-	32	-	5		+	0,4
CYLINDRICAL											
16A2R024A14-SAD11E-C	●	16	160	24	-	14	-	2		+	0,2
16A2R024A16-SAD11E-C	●	16	135	24	-	16	-	2		+	0,2
16A2R050A16-SAD11E-C	●	16	135	50	-	16	-	2		+	0,2
18A2R029A20-SAD11E-C	●	18	150	29	-	20	-	2		+	0,3
20A2R029A20-SAD11E-C	●	20	150	29	-	20	-	2		+	0,3
20A2R070A20-SAD11E-C	●	20	150	70	-	20	-	2		+	0,3
20A3R029A18-SAD11E-C	●	20	200	29	-	18	-	3		+	0,3
20A3R029A20-SAD11E-C	●	20	150	29	-	20	-	3		+	0,3
22A3R029A20-SAD11E-C	●	22	200	29	-	20	-	3		+	0,4
25A3R034A25-SAD11E-C	●	25	170	34	-	25	-	3		+	0,5
25A3R080A25-SAD11E-C	●	25	170	80	-	25	-	3		+	0,5
25A4R034A25-SAD11E-C	●	25	170	34	-	25	-	4		+	0,5
32A3R090A32-SAD11E-C	○	32	195	90	-	32	-	3		+	0,9
32A5R034A32-SAD11E-C	●	32	195	34	-	32	-	5		+	0,9

● New item in the assortment

● Stock assortment ○ Non-stock assortment All dimensions [mm]
See latest price list for current availability

SAD11E

SHOULDER MILLING CUTTERS

MILLING TOOLS

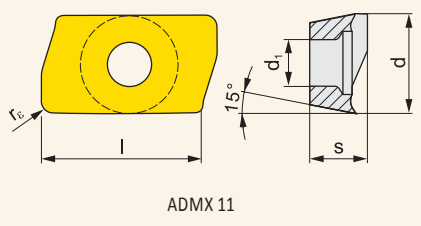

MILLING INSERTS

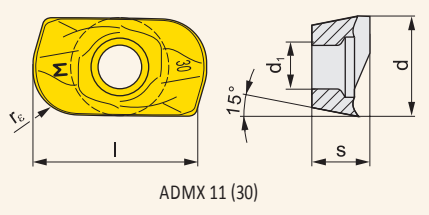

TURNING INSERTS

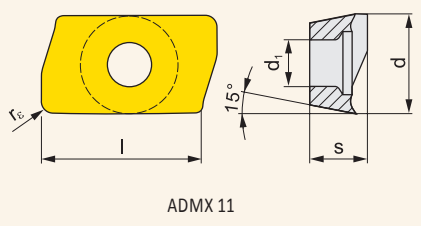

DRILLING INSERTS

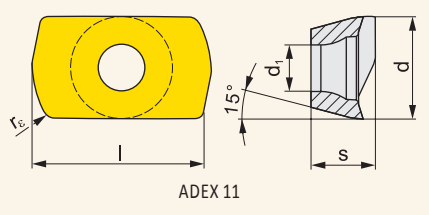

TECHNICAL SECTION

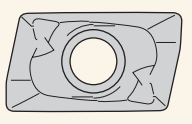
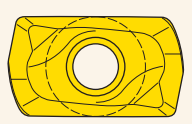
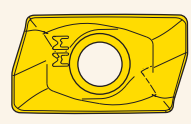
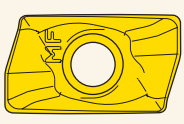
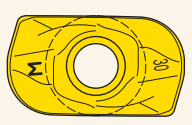
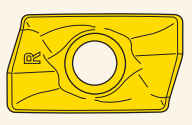
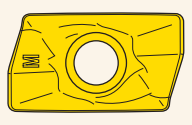
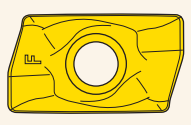
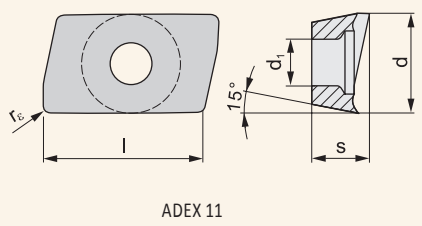



● New item in the assortment

● Stock assortment ○ Non-stock assortment All dimensions [mm]
See latest price list for current availability

INDEXABLE CUTTING INSERTS

ISO	Grades											Dimensions [mm]				
	M0315	M5315	M9315	M9325	M9340	M8310	M8340	8215	8230	8240	HF7	(l)	d	s	d ₁	r _ε
ADMX 11T304SR-F					●	●	●	●	●	●		11,000	6,530	3,97	2,90	0,4
ADMX 11T308SR-F					●		●	●	●	●		11,000	6,530	3,97	2,90	0,8
ADMX 11T302SR-M							●		●			11,000	6,530	3,97	2,90	0,2
ADMX 11T304SR-M				●	●	●	●	●	●	●		11,000	6,530	3,97	2,90	0,4
ADMX 11T308SR-M		●	●	●	●	●	●	●	●	●		11,000	6,530	3,97	2,90	0,8
ADMX 11T310SR-M							●		●			11,000	6,530	3,97	2,90	1,0
ADMX 11T312SR-M							●	●	●			11,000	6,530	3,97	2,90	1,2
ADMX 11T316SR-M						●	●	●	●	●		11,000	6,530	3,97	2,90	1,6
ADMX 11T320SR-M							●		●			10,810	6,530	3,97	2,90	2,0
ADMX 11T325SR-M							●		●			10,810	6,530	3,97	2,90	2,5
ADMX 11T330SR-M							●		●			10,810	6,530	3,97	2,90	3,0
ADMX 11T308PR-R		●	●	●		●	●	●	●	●		11,000	6,530	3,97	2,90	0,8
ADMX 11T316PR-R				●			●	●	●			11,000	6,530	3,97	2,90	1,6
ADMX 11T304SR-MF							●					11,000	6,530	3,97	2,90	0,4
ADMX 11T308SR-MF							●					11,000	6,530	3,97	2,90	0,8
ADMX 11T304SR-MM							●					11,000	6,530	3,97	2,90	0,4
ADMX 11T308SR-MM							●					11,000	6,530	3,97	2,90	0,8
ADMX 11T312SR-MM							●					11,000	6,530	3,97	2,90	1,2
ADEX 11T308SR-HF						●	●	●	●			10,665	6,530	3,80	2,90	0,8
ADEX 11T304FR-FA	●										●	11,000	6,530	3,97	2,90	0,4
ADEX 11T308FR-FA	●										●	11,000	6,530	3,97	2,90	0,8
ADEX 11T316FR-FA											●	11,000	6,530	3,97	2,90	1,6

SPARE PARTS

Diameter of cutter	Clamping screw	Screwdriver
16 ÷ 32	 US 2505-T08P	 FLAG T08P

● New item in the assortment

● Stock assortment ○ Non-stock assortment All dimensions [mm]
See latest price list for current availability

COPY MILLING CUTTERS





SMORC

COPY MILLING CUTTERS

MILLING TOOLS



MILLING INSERTS

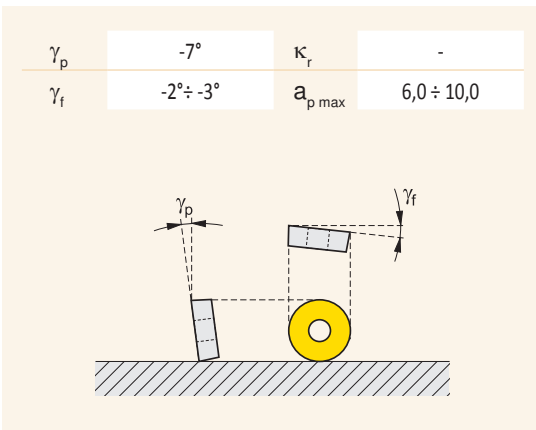

TURNING INSERTS

DRILLING INSERTS

TECHNICAL SECTION

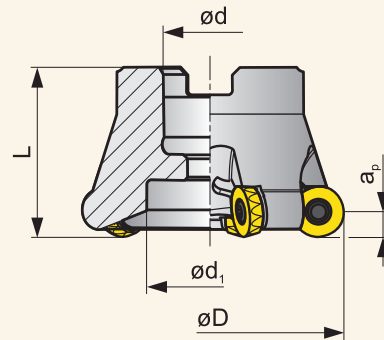

Z* - Number of teeth

ISO	Assortment	Dimensions [mm]								Cooling	[kg]	
		D	d	d ₁	L	Z*						
40A03R-SMORC12	●	40	16	12	40	3	RC.. 1204				-	0,2
50A04R-SMORC12	●	50	22	18	40	4	RC.. 1204				-	0,3
52A05R-SMORC12-C	●	52	22	18	40	5	RC.. 1204				+	0,2
63A05R-SMORC12	●	63	22	30	40	5	RC.. 1204				-	0,4
66A06R-SMORC12-C	●	66	27	22	50	6	RC.. 1204				+	0,5
80A05R-SMORC12	●	80	27	37	50	5	RC.. 1204				-	0,9
100A06R-SMORC12	●	100	32	45	50	6	RC.. 1204				-	1,6
63A04R-SMORC16	●	63	22	18	50	4	RC.. 1606				-	0,5
66A05R-SMORC16-C	●	66	27	22	50	5	RC.. 1606				+	0,4
80A05R-SMORC16	●	80	27	37	50	5	RC.. 1606				-	0,7
100A06R-SMORC16	●	100	32	45	50	6	RC.. 1606				-	1,1
125A07R-SMORC16-C	●	125	40	36	63	7	RC.. 1606				+	2,7
160C08R-SMORC16	●	160	40	66,7	63	8	RC.. 1606				-	4,4
80A04R-SMORC20	●	80	27	28	50	4	RC.. 2006				-	0,6
100A05R-SMORC20	●	100	32	45	50	5	RC.. 2006				-	1,0
125A06R-SMORC20-C	●	125	40	36	63	6	RC.. 2006				+	2,6
160C07R-SMORC20	●	160	40	66,7	63	7	RC.. 2006				-	4,1

● New item in the assortment

● Stock assortment ○ Non-stock assortment All dimensions [mm]
See latest price list for current availability

SMORC

COPY MILLING CUTTERS

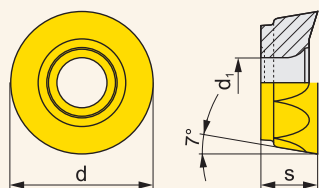

RCMT

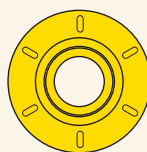

RCMT-F

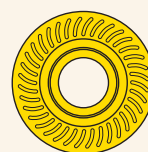

RCMT-M

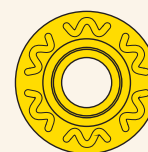

RCMT-R

INDEXABLE CUTTING INSERTS

ISO	Grades							Dimensions [mm]				
	M9315	M9325	M9340	M8310	M8345	8215	8230	d	s	d ₁		
RCMT 1204MOEN-F				●		●	●	12,000	4,760	4,40		
RCMT 1204MOEN-R	●		●	●			●	12,000	4,760	4,40		
RCMT 1204MOSN-M		●	●	●	●		●	12,000	4,760	4,40		
RCMT 1204MOSN-R	●				●			12,000	4,760	4,40		
RCMT 1606MOEN-F				●			●	16,000	6,350	5,50		
RCMT 1606MOSN-M		●	●		●		●	16,000	6,350	5,50		
RCMT 1606MOSN-R		●		●	●		●	16,000	6,350	5,50		
RCMT 2006MOSN-F			●				●	20,000	6,350	6,50		
RCMT 2006MOSN-M	●	●	●		●		●	20,000	6,350	6,50		
RCMT 2006MOSN-R		●			●	●		20,000	6,350	6,50		

SPARE PARTS

Cutter	Clamping screw	Shank	Handle	Screwdriver	Screw for taper clamping
40A03R-SMORC12	US 63509-T15P	D-T08P/T15P	FG-15	-	HS 90835
50A04R-SMORC12	US 63509-T15P	D-T08P/T15P	FG-15	-	HS 1030C
52A05R-SMORC12-C	US 63509-T15P	D-T08P/T15P	FG-15	-	HSD 1025C
63A05R-SMORC12	US 63509-T15P	D-T08P/T15P	FG-15	-	HS 1030C
66A06R-SMORC12-C	US 63509-T15P	D-T08P/T15P	FG-15	-	HS 1230C
80A05R-SMORC12	US 63509-T15P	D-T08P/T15P	FG-15	-	-
100A06R-SMORC12	US 63509-T15P	D-T08P/T15P	FG-15	-	-
63A04R-SMORC16	US 65014-T20P	-	-	SDR T20P-T	HS 1030C
66A05R-SMORC16-C	US 65014-T20P	-	-	SDR T20P-T	HS 1230C
80A05R-SMORC16	US 65014-T20P	-	-	SDR T20P-T	-
100A06R-SMORC16	US 65014-T20P	-	-	SDR T20P-T	-
125A07R-SMORC16-C	US 65014-T20P	-	-	SDR T20P-T	HSD 2040
160C08R-SMORC16	US 65014-T20P	-	-	SDR T20P-T	-
80A04R-SMORC20	US 66015-T25P	-	-	SDR T25P-T	HS 1230C
100A05R-SMORC20	US 66015-T25P	-	-	SDR T25P-T	-
125A06R-SMORC20-C	US 66015-T25P	-	-	SDR T25P-T	HSD 2040
160C07R-SMORC20	US 66015-T25P	-	-	SDR T25P-T	-

● New item in the assortment

● Stock assortment ○ Non-stock assortment All dimensions [mm]
See latest price list for current availability

SPD09-C

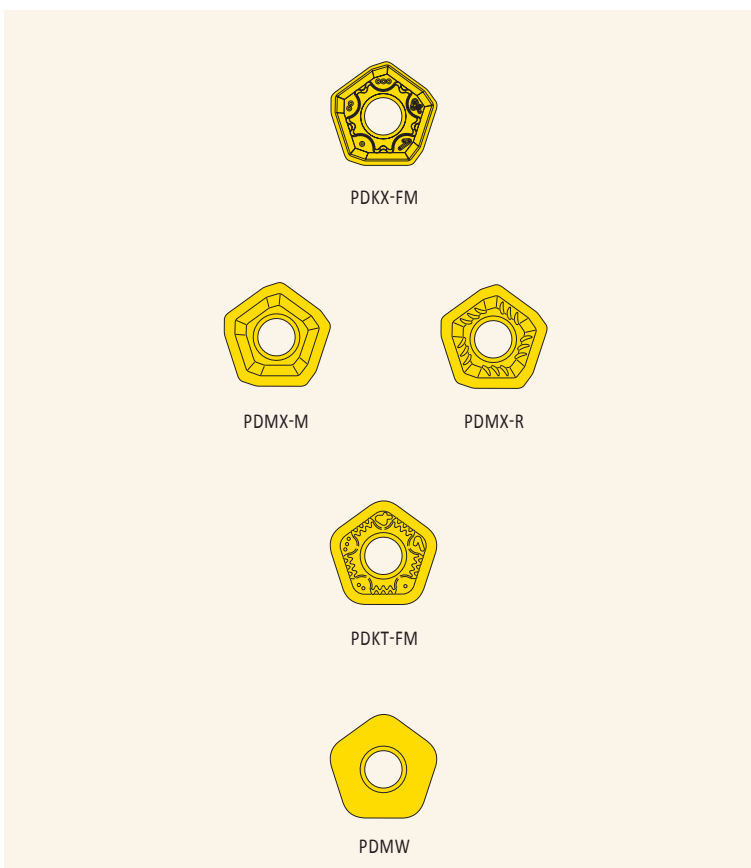
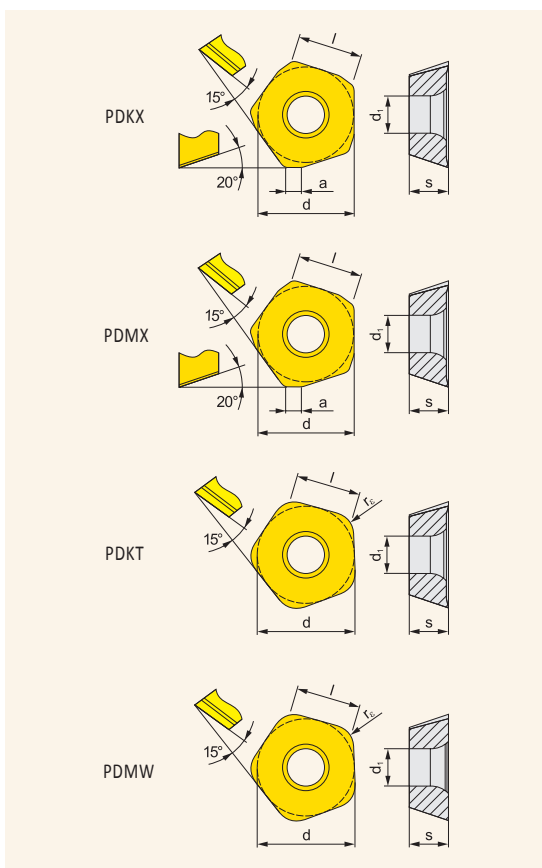

HIGH FEED MILLING CUTTERS



INDEXABLE CUTTING INSERTS

ISO	Grades						Dimensions [mm]						
	M9315	M9325	M9340	M8310	M8345	8215	8230	l	d	s	d ₁	a	r _c
PDKX 0905ZEER-FM			●	●				9,000	13,500	5,47	5,50	2,0	-
PDMX 0905ZEER-M			●	●	●	●		9,000	13,500	5,47	5,50	2,0	-
PDMX 0905ZESR-R				●	●	●		9,000	13,500	5,47	5,50	2,0	-
PDKT 090530ER-FM				●	●	●		9,000	13,500	5,47	5,50	-	3
PDMW 090530SR	●	●		●	●			9,000	13,500	5,47	5,50	-	3

SPARE PARTS

Diameter of cutter	Clamping screw	Screwdriver
32 ÷ 40	 US 45011-T20P	 FLAG T20P

● New item in the assortment

● Stock assortment ○ Non-stock assortment All dimensions [mm]
See latest price list for current availability

S19PD09-C

HIGH FEED MILLING CUTTERS

MILLING TOOLS



MILLING INSERTS

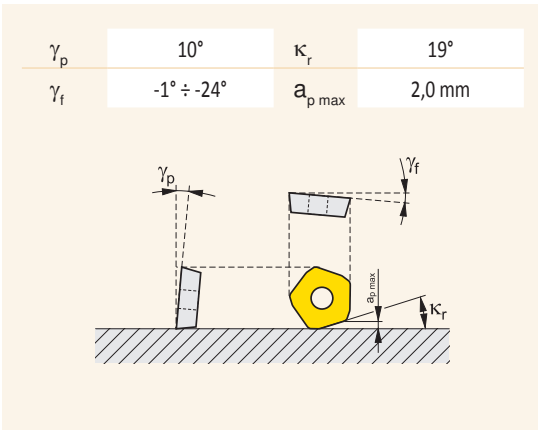

TURNING INSERTS

DRILLING INSERTS

TECHNICAL SECTION

PENTA HF

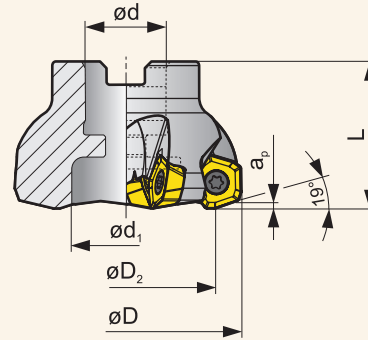

Z* - Number of teeth

ISO	Assortment	Dimensions [mm]								Cooling	[kg]
		D	d	d ₁	L	D ₂	Z*				
42A03R-S19PD09-C	●	42	16	12	40	27,8	3			+	0,2
50A04R-S19PD09-C	●	50	22	18	40	35,6	4			+	0,2
50A05R-S19PD09-C	●	50	22	18	40	36,0	5			+	0,2
52A04R-S19PD09-C	●	52	22	18	40	37,6	4			+	0,2
63A05R-S19PD09-C	●	63	22	18	40	48,6	5			+	0,3
63A06R-S19PD09-C	●	63	22	18	40	49,0	6			+	0,3
66A06R-S19PD09-C	●	66	22	18	40	51,6	6			+	0,3
66A06R-S19PD09-CF	●	66	27	22	50	52,0	6			+	0,5
80A05R-S19PD09-C	●	80	27	37	50	66,0	5			+	0,8
80A06R-S19PD09-C	●	80	27	37	50	66,0	6			+	0,8
100A06R-S19PD09-C	●	100	32	45	50	85,6	6			+	1,4
100A08R-S19PD09-C	●	100	32	45	50	85,6	8			+	1,4
125A10R-S19PD09-C	●	125	40	36	63	111,0	10			+	2,8

● New item in the assortment

● Stock assortment ○ Non-stock assortment All dimensions [mm]
See latest price list for current availability

S19PD09-C

HIGH FEED MILLING CUTTERS

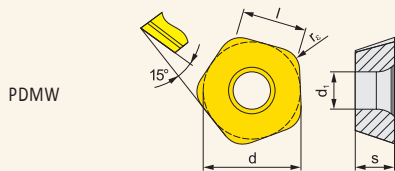
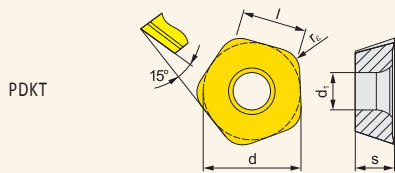
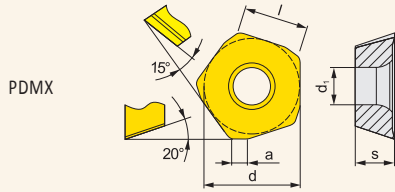
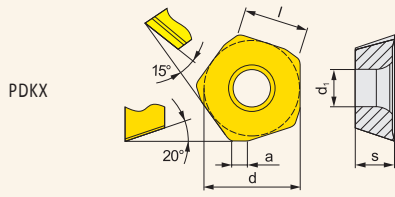

● New item in the assortment

● Stock assortment ○ Non-stock assortment All dimensions [mm]
See latest price list for current availability



S19PD09-C

HIGH FEED MILLING CUTTERS

INDEXABLE CUTTING INSERTS

ISO	Grades								Dimensions [mm]								
	M9315	M9325	M9340	M8310	M8345	8215	8230					l	d	s	d ₁	a	r _ε
PDKX 0905ZEER-FM			●	●								9,000	13,500	5,47	5,50	2,0	-
PDMX 0905ZEER-M			●	●	●	●						9,000	13,500	5,47	5,50	2,0	-
PDMX 0905ZESR-R				●	●	●						9,000	13,500	5,47	5,50	2,0	-
PDKT 090530ER-FM				●	●	●	●					9,000	13,500	5,47	5,50	-	3
PDMW 090530SR	●	●	●	●								9,000	13,500	5,47	5,50	-	3

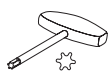
SPARE PARTS

Cutter	Clamping screw 	Screwdriver 	Screw for taper clamping 
42A03R-S19PD09-C	US 45011-T20P	SDR T20P-T	HS 90835
50A04R-S19PD09-C	US 45011-T20P	SDR T20P-T	HS 1030C
50A05R-S19PD09-C	US 45011-T20P	SDR T20P-T	HS 1030C
52A04R-S19PD09-C	US 45011-T20P	SDR T20P-T	HS 1030C
63A05R-S19PD09-C	US 45011-T20P	SDR T20P-T	HS 1030C
63A06R-S19PD09-C	US 45011-T20P	SDR T20P-T	HS 1030C
66A06R-S19PD09-C	US 45011-T20P	SDR T20P-T	HS 1030C
66A06R-S19PD09-CF	US 45011-T20P	SDR T20P-T	HS 1230C
80A05R-S19PD09-C	US 45011-T20P	SDR T20P-T	-
80A06R-S19PD09-C	US 45011-T20P	SDR T20P-T	-
100A06R-S19PD09-C	US 45011-T20P	SDR T20P-T	-
100A08R-S19PD09-C	US 45011-T20P	SDR T20P-T	-
125A10R-S19PD09-C	US 45011-T20P	SDR T20P-T	HSD 2040

● New item in the assortment

● Stock assortment ○ Non-stock assortment All dimensions [mm]
See latest price list for current availability

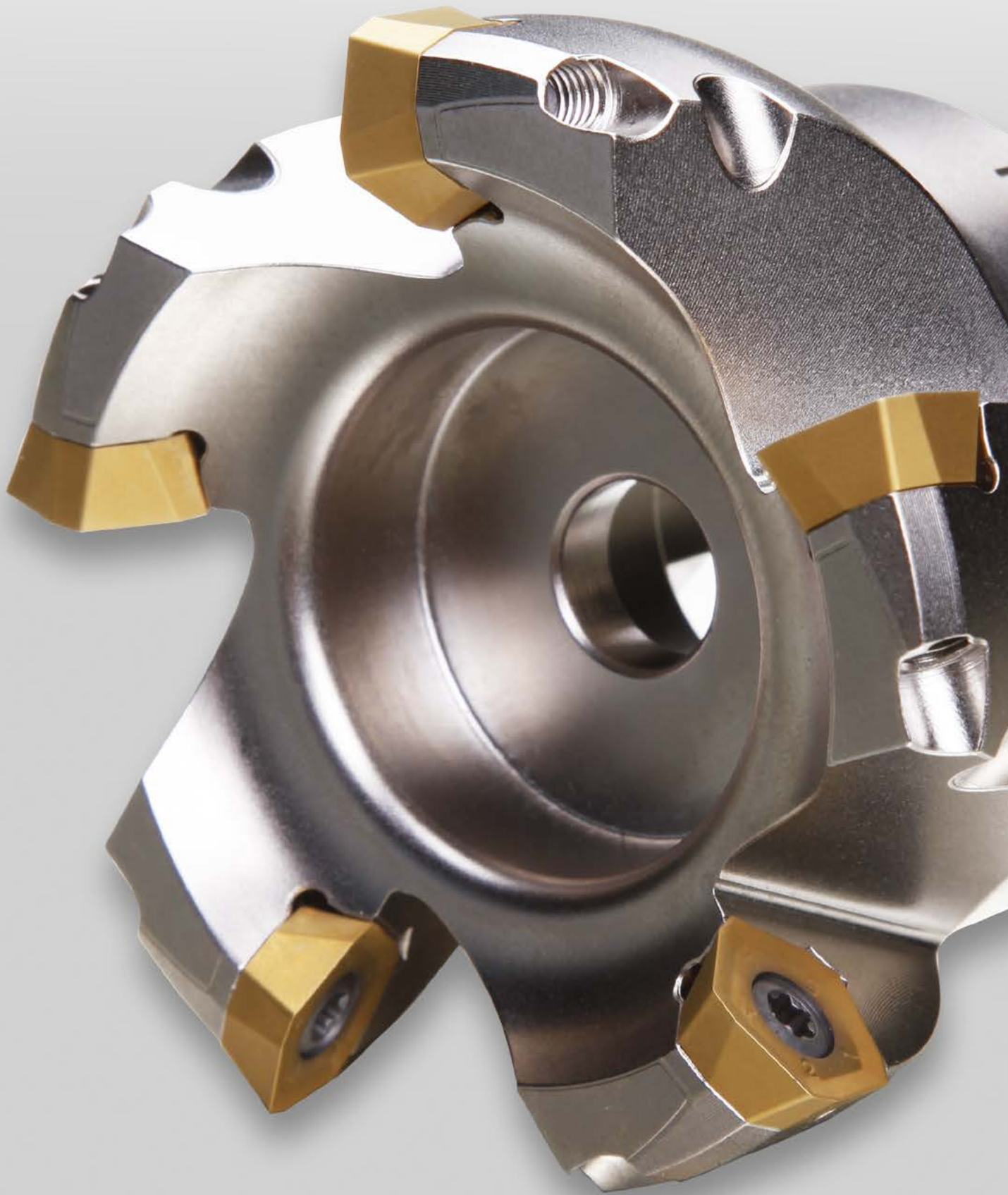

SZD

HIGH FEED MILLING CUTTERS

MILLING TOOLS



FEED ZD

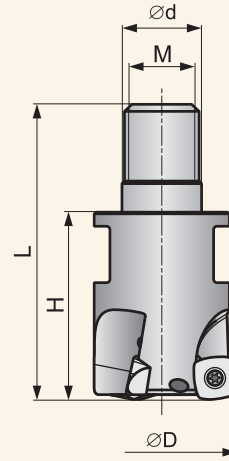

MILLING INSERTS

γ_p	+8°; +10°	κ_r	
γ_f	-5°; -6°	$a_{p\ max}$	1,0; 1,6 mm

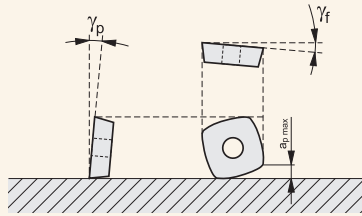

TURNING INSERTS

Z* - Number of teeth

DRILLING INSERTS

TECHNICAL SECTION

ISO	Assortment	Dimensions [mm]								Cooling	[kg]	
		D	H	L	d	M	Z*					
16E2R030M08-SZD07	●	16	30	48	8,5	M8	2	ZD.. 0703			+	0,0
20E3R030M10-SZD07	●	20	30	49	10,5	M10	3	ZD.. 0703			+	0,1
25E3R032M12-SZD07	●	25	32	54	12,5	M12	3	ZD.. 0703			+	0,1
25E4R032M12-SZD07	●	25	32	54	12,5	M12	4	ZD.. 0703			+	0,1
32E4R040M16-SZD07	○	32	40	65	17	M16	4	ZD.. 0703			+	0,2
25E2R032M12-SZD09-C	●	25	32	54	12,5	M12	2	ZD.. 09T3			+	0,1
25E3R032M12-SZD09-C	●	25	32	54	12,5	M12	3	ZD.. 09T3			+	0,1
32E3R040M16-SZD09-C	●	32	40	63	17	M16	3	ZD.. 09T3			+	0,2
35E4R040M16-SZD09-C	●	35	40	63	17	M16	4	ZD.. 09T3			+	0,2
42E4R040M16-SZD09-C	●	42	40	63	17	M16	4	ZD.. 09T3			+	0,2
32E3R040M16-SZD12-C	●	32	40	63	17	M16	3	ZD.. 1204			+	0,2
40E4R040M16-SZD12-C	●	40	40	63	17	M16	4	ZD.. 1204			+	0,2

● New item in the assortment ● Stock assortment ○ Non-stock assortment All dimensions [mm]
See latest price list for current availability

SZD

HIGH FEED MILLING CUTTERS

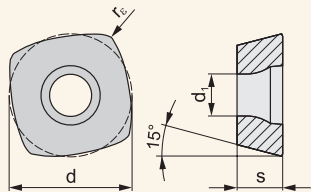

ZDCW / ZDEW

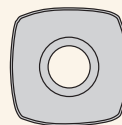

ZDCW / ZDEW

INDEXABLE CUTTING INSERTS

ISO	Grades						Dimensions [mm]				
	M8310	M8325	M8345	7205	7215	7230	l	d	s	d ₁	r _ε
ZDCW 070304	●	●	●		●	●	6,800	6,800	3,18	2,60	0,4
ZDCW 09T304	●	●	●	○	●	●	9,525	9,525	3,97	3,40	0,4
ZDEW 120408	●	●	●	●			12,700	12,700	4,76	4,40	0,8

SPARE PARTS

Diameter of cutter	Clamping screw	Screwdriver
..SZD07	US 2205-T07P	FLAG T07P
..SZD09	US 3006-T09P	FLAG T09P
..SZD12	US 4011-T15P	FLAG T15P

● New item in the assortment ● Stock assortment ○ Non-stock assortment All dimensions [mm]
See latest price list for current availability

MILLING TOOLS

MILLING INSERTS

TURNING INSERTS

DRILLING INSERTS

TECHNICAL SECTION

SMOZD

HIGH FEED MILLING CUTTERS

FEED ZD

MILLING TOOLS



MILLING INSERTS

γ_p	+10°	κ_r	-
γ_f	-6°	$a_{p\max}$	1,0; 1,6 mm

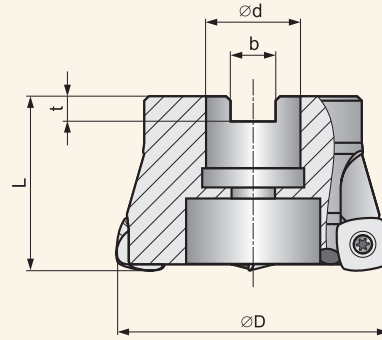
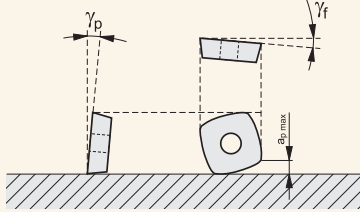

Z* - Number of teeth

TURNING INSERTS

DRILLING INSERTS

TECHNICAL SECTION

ISO	Assortment	Dimensions [mm]							Cooling	[kg]
		D	d	L	b	t	Z*			
40A03R-SMOZD09-C	○	40	16	40	8,4	5,6	3	ZD.. 09T3	+	0,2
40A04R-SMOZD09-C	●	40	16	40	8,4	5,6	4	ZD.. 09T3	+	0,2
50A04R-SMOZD12-C	●	50	22	40	10,4	6,4	4	ZD.. 1204	+	0,2
52A04R-SMOZD12-C	●	52	22	40	10,4	6,4	4	ZD.. 1204	+	0,3
63A04R-SMOZD12-C	○	63	22	40	10,4	6,4	4	ZD.. 1204	+	0,5
63A05R-SMOZD12-C	●	63	22	40	10,4	6,4	5	ZD.. 1204	+	0,4
66A05R-SMOZD12-C	●	66	27	50	12	7	5	ZD.. 1204	+	0,8
80A05R-SMOZD12-C	●	80	27	50	12	7	5	ZD.. 1204	+	1,0

● New item in the assortment ● Stock assortment ○ Non-stock assortment All dimensions [mm]
See latest price list for current availability

SMOZD

HIGH FEED MILLING CUTTERS

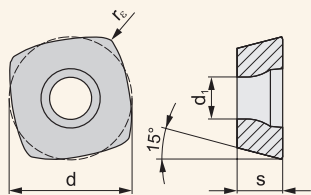

ZDCW / ZDEW

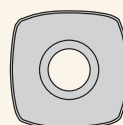









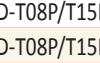

ZDCW / ZDEW

INDEXABLE CUTTING INSERTS

ISO	Grades						Dimensions [mm]				
	M8310	M8325	M8345	7205	7215	7230	l	d	s	d ₁	r _ε
ZDCW 09T304	●	●	●	○	●	●	9,525	9,525	3,97	3,40	0,4
ZDEW 120408	●	●	●	●			12,700	12,700	4,76	4,40	0,8

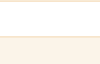
SPARE PARTS

Diameter of cutter	Clamping screw	Shank	Handle	Screw for taper clamping
40	 US 3006-T09P	 D-T07P/T09P	 FG-15	 HS 0830C
50 ÷ 66	 US 4011-T15P	 D-T08P/T15P	 FG-15	 HS 1030C
80	 US 4011-T15P	 D-T08P/T15P	 FG-15	-

● Stock assortment ○ Non-stock assortment All dimensions [mm]
See latest price list for current availability

MILLING TOOLS

MILLING INSERTS

TURNING INSERTS

DRILLING INSERTS

TECHNICAL SECTION

SRC-A

BALLNOSE EXCHANGEABLE HEADS

MILLING TOOLS



MILLING INSERTS

γ_p	0°	κ_r	
γ_f	-7° ÷ -14°	$a_{p \text{ max}}$	2 ÷ 5 mm

γ_p , γ_f , $a_{p \text{ max}}$

TURNING INSERTS

Z* - Number of teeth

DRILLING INSERTS

TECHNICAL SECTION

ISO	Assortment	Dimensions [mm]					Inserts	Cooling	[kg]
		D	d ₁	L	H	d			
08K2R30M06-SRC08-A	○	8	6,5	M6	45	19	RC 08, RC 08-F		
10K2R30M06-SRC10-A	○	10	6,5	M6	45	19	RC 10, RC 10F		
12K2R30M08-SRC12-A	●	12	8,5	M8	48	19	RC 12, RC 12-F		
16K2R35M08-SRC16-A	●	16	8,5	M8	53	35	RC 16, RC 16-F		
20K2R35M10-SRC20-A	●	20	10,5	M10	54	35	RC 20, RC 20-F		

● New item in the assortment

● Stock assortment ○ Non-stock assortment All dimensions [mm]
See latest price list for current availability

SRC-A

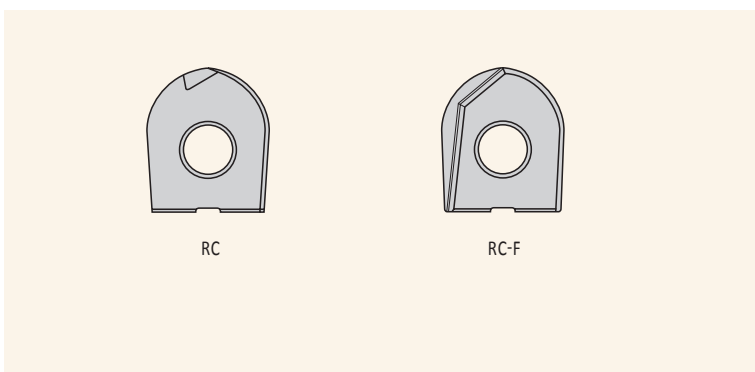
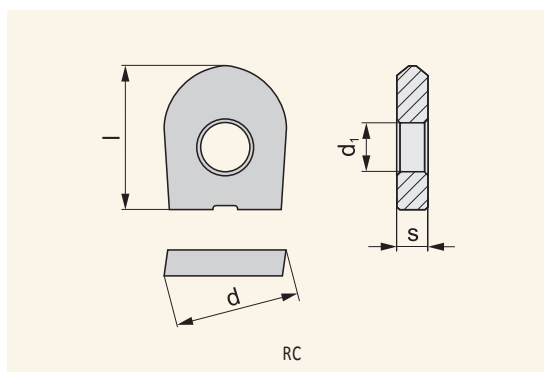

BALLNOSE EXCHANGEABLE HEADS



INDEXABLE CUTTING INSERTS

ISO	Grades						Dimensions [mm]			
	M8310	7215	7230				d	d ₁	l	s
RC 08	●	●	●				8,000	3,000	9,50	2,00
RC 10	●	●	●				10,000	4,000	11,50	2,50
RC 12	●	●	●				12,000	5,000	12,00	2,50
RC 16	●	●	●				16,000	5,000	14,00	3,00
RC 20	●	●	●				20,000	5,000	16,00	3,00
RC 08-F		●					8,000	3,000	9,50	2,00
RC 10-F		●	○				10,000	4,000	11,50	2,50
RC 12-F		●	○				12,000	5,000	12,00	2,50
RC 16-F		●	●				16,000	5,000	14,00	3,00
RC 20-F		●	●				20,000	5,000	16,00	3,00

SPARE PARTS

Diameter of cutter	Clamping screw	Screwdriver
8	 CS 3007-T08P	 SDR T08P
10	CS 4008-T15P	SDR T15P
12	CS 5009-T20P	SDR T20P
16	CS 5013-T20P	SDR T20P
20	CS 5015-T20P	SDR T20P

● New item in the assortment

● Stock assortment ○ Non-stock assortment All dimensions [mm]
See latest price list for current availability

K2-SRC

BALLNOSE MILLING CUTTERS FOR COPYING

MILLING TOOLS



MILLING INSERTS

γ_p	0°	κ_r	
γ_f	$-7^\circ \div -14^\circ$	$a_{p \max}$	$2 \div 8 \text{ mm}$

TURNING INSERTS

DRILLING INSERTS

TECHNICAL SECTION

Z* - Number of teeth

ISO	Assortment	Dimensions [mm]					Inserts	Cooling	[kg]
		D	d ₁	L	H	d			
SRC TYPE A									
08K2R025A10-SRC08-A	●	8	7,5	110	25	10	RC 08, RC 08-F, LC 08-KP, LC 08-KPF	-	0,1
10K2R030A12-SRC10-A	●	10	9	130	30	12	RC 10, RC 10F, LC10-KP, LC 10-KPF	-	0,1
12K2R030A12-SRC12-A	●	12	10,5	130	30	12	RC 12, RC 12-F, LC 12.-CH, LC 12.-RE	-	0,2
16K2R035A16-SRC16-A	●	16	14	140	35	16	RC 16, RC 16-F	-	0,3
20K2R045A20-SRC20-A	●	20	18	160	45	20	RC 20, RC 20-F	-	0,4
25K2R045A25-SRC25-A	●	25	22,4	160	45	25	RC 25, RC 25-F	-	0,7
32K2R060A32-SRC32-A	●	32	28,6	180	60	32	RC 32, RC 32-F	-	1,1
SRC TYPE B									
08K2R050A12-SRC08-A	●	8	-	140	13,5	12	RC 08, RC 08-F, LC08-KP, LC 08-KPF	-	0,1
10K2R060A16-SRC10-A	●	10	-	150	19,5	16	RC 10, RC 10F, LC10-KP, LC 10-KPF	-	0,1
12K2R060A16-SRC12-A	●	12	-	160	24,5	16	RC 12, RC 12-F, LC 12.-CH, LC 12.-RE	-	0,2
16K2R065A20-SRC16-A	●	16	-	175	31,5	20	RC 16, RC 16-F	-	0,3
20K2R080A25-SRC20-A	●	20	-	190	33,5	25	RC 20, RC 20-F	-	0,4

● New item in the assortment ● Stock assortment ○ Non-stock assortment All dimensions [mm]
See latest price list for current availability

K2-SRC

BALLNOSE MILLING CUTTERS FOR COPYING

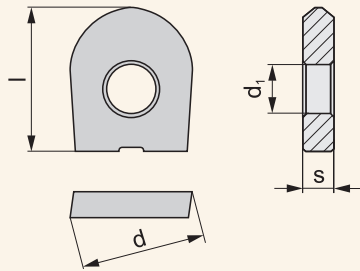

RC

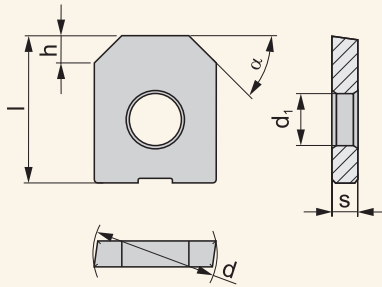

LC

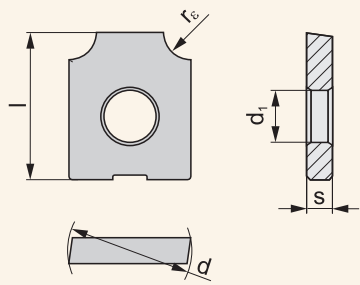

LC

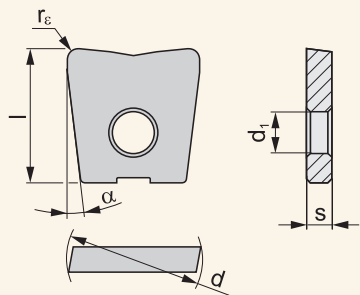

LC-KP

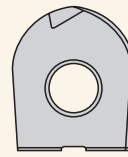

RC

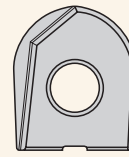

RC..F



RC 12..-CH



LC 12..-RE

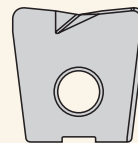

LC..-KP

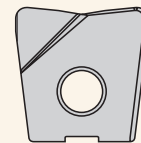

LC..-KPF

● New item in the assortment

● Stock assortment ○ Non-stock assortment All dimensions [mm]
See latest price list for current availability



K2-SRC

BALLNOSE MILLING CUTTERS FOR COPYING

INDEXABLE CUTTING INSERTS

ISO	Grades										Dimensions [mm]				
	M8310	7215	7230								d	d ₁	l	s	r
RC 08	●	●	●								8,000	3,000	9,50	2,00	-
RC 10	●	●	●								10,000	4,000	11,50	2,50	-
RC 12	●	●	●								12,000	5,000	12,00	2,50	-
RC 16	●	●	●								16,000	5,000	14,00	3,00	-
RC 20	●	●	●								20,000	5,000	16,00	3,00	-
RC 25	●	●	●								25,000	6,000	21,50	4,00	-
RC 32		●	○								32,000	8,000	25,90	5,00	-
RC 08-F		●									8,000	3,000	9,50	2,00	-
RC 10-F		●	○								10,000	4,000	11,50	2,50	-
RC 12-F		●	○								12,000	5,000	12,00	2,50	-
RC 16-F		●	●								16,000	5,000	14,00	3,00	-
RC 20-F		●	●								20,000	5,000	16,00	3,00	-
RC 25-F		●	○								25,000	6,000	21,50	4,00	-
RC 32-F		○									32,000	8,000	25,90	5,00	-
LC 0806-KP	●	●	●								8,000	3,000	9,50	2,00	0,6
LC 0810-KP	●	○	○								8,000	3,000	9,50	2,00	1,0
LC 1008-KP	●	●	○								10,000	4,000	11,50	2,50	0,8
LC 1010-KP	●	●	●								10,000	4,000	11,50	2,50	1,0
LC 0806-KPF		●	○								8,000	3,000	9,50	2,00	0,6
LC 1008-KPF		●	○								10,000	4,000	11,50	2,50	0,8
LC 1245-CH		○									12,000	5,000	14,00	2,50	-
LC 1260-CH		○									12,000	5,000	14,00	2,50	-
LC 1210-RE		○									12,000	5,000	14,00	2,50	1,00
LC 1220-RE		○									12,000	5,000	14,00	2,50	2,00
LC 1230-RE		○									12,000	5,000	14,00	2,50	3,00

SPARE PARTS

Diameter of cutter	Clamping screw	Screwdriver
		
8	CS 3007-T08P	SDR T08P
10	CS 4008-T15P	SDR T15P
12	CS 5009-T20P	SDR T20P
16	CS 5013-T20P	SDR T20P
20	CS 5015-T20P	SDR T20P
25	CS 6020-T20P	SDR T20P
32	CS 8025-T30P	SDR T30P

● New item in the assortment

● Stock assortment ○ Non-stock assortment All dimensions [mm]
See latest price list for current availability



K2-SLC

SHOULDER END MILLING CUTTERS

MILLING TOOLS



MILLING INSERTS

γ_p	0°	κ_r	90°
γ_f	-7° ÷ -14°	$a_{p\ max}$	0,6 ÷ 4,0 mm

TURNING INSERTS

DRILLING INSERTS

TECHNICAL SECTION

Z* - Number of teeth

ISO	Assortment	Dimensions [mm]					Inserts	Cooling	[kg]
		D	d ₁	L	H	d			
SLC / SRC TYPE A									
08K2R025A10-SRC08-A	●	8	7,5	110	25	10	LC 08-KP; LC 08-KPF; RC 08; RC 08-F	-	0,1
10K2R030A12-SRC10-A	●	10	9	130	30	12	LC 10-KP; LC 10-KPF; RC 10; RC 10-F	-	0,1
12K2R030A12-SLC12-A	●	12	10,5	130	30	12	LC 12-KP; LC 12-KPF; LC 12..-RI	-	0,2
16K2R035A16-SLC16-A	●	16	14	140	35	16	LC 16-KP; LC 16-KPF	-	0,3
20K2R045A20-SLC20-A	●	20	18	160	45	20	LC20-KP; LC20-KPF	-	0,4
SLC / SRC TYPE B									
08K2R050A12-SRC08-A	●	8	-	140	13,5	12	LC 08-KP; LC 08-KPF; RC 08; RC 08-F	-	0,1
10K2R060A16-SRC10-A	●	10	-	150	19,5	16	LC 10-KP; LC 10-KPF; RC 10; RC 10-F	-	0,1

● New item in the assortment ● Stock assortment ○ Non-stock assortment All dimensions [mm]
See latest price list for current availability

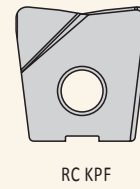
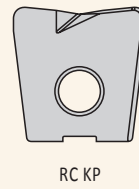
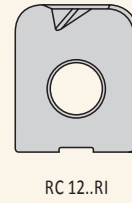
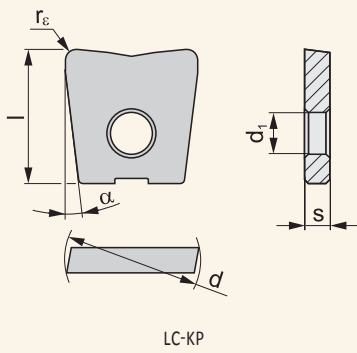
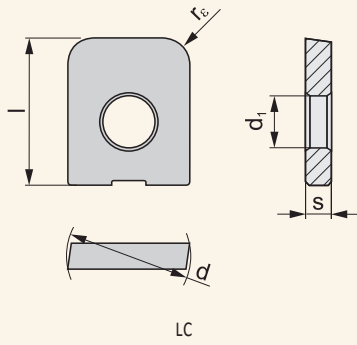

K2-SLC

SHOULDER END MILLING CUTTERS

INDEXABLE CUTTING INSERTS

ISO	Grades											Dimensions [mm]				
	M8310	7215	7230									d	d ₁	l	s	r
LC 0806-KP	●	●	●									8,000	3,000	9,50	2,00	0,6
LC 0810-KP	●	○	○									8,000	3,000	9,50	2,00	1,0
LC 1008-KP	●	●	○									10,000	4,000	11,50	2,50	0,8
LC 1010-KP	●	●	●									10,000	4,000	11,50	2,50	1,0
LC 1210-KP	●	●	●									12,000	5,000	14,00	2,50	1,0
LC 1220-KP		○	○									12,000	5,000	14,00	2,50	2,0
LC 1610-KP	●	●	●									16,000	5,000	16,00	3,00	1,0
LC 1613-KP	●	●	○									16,000	5,000	16,00	3,00	1,3
LC 1630-KP		○	○									16,000	5,000	16,00	3,00	3,0
LC 2010-KP	●	○	●									20,000	5,000	18,00	3,00	1,0
LC 2016-KP	●	●	○									20,000	5,000	18,00	3,00	1,6
LC 2040-KP		○	○									20,000	5,000	18,00	3,00	4,0
LC 0806-KPF		●	○									8,000	3,000	9,50	2,00	0,6
LC 1008-KPF		●	○									10,000	4,000	11,50	2,50	0,8
LC 1210-KPF		○	●									12,000	5,000	14,00	2,50	1,0
LC 1613-KPF		●	○									16,000	5,000	16,00	3,00	1,3
LC 2016-KPF		○	●									20,000	5,000	18,00	3,00	1,6
LC 1215-RI		○										12,000	5,000	14,00	2,50	1,5
LC 1220-RI		○										12,000	5,000	14,00	2,50	2,0
LC 1230-RI		○										12,000	5,000	14,00	2,50	3,0

SPARE PARTS

Diameter of cutter	Clamping screw	Screwdriver
	8	CS 3007-T08P
10	CS 4008-T15P	SDR T15P
12	CS 5009-T20P	SDR T20P
16	CS 5013-T20P	SDR T20P
20	CS 5015-T20P	SDR T20P

● New item in the assortment

● Stock assortment ○ Non-stock assortment All dimensions [mm]
See latest price list for current availability



MILLING INSERTS

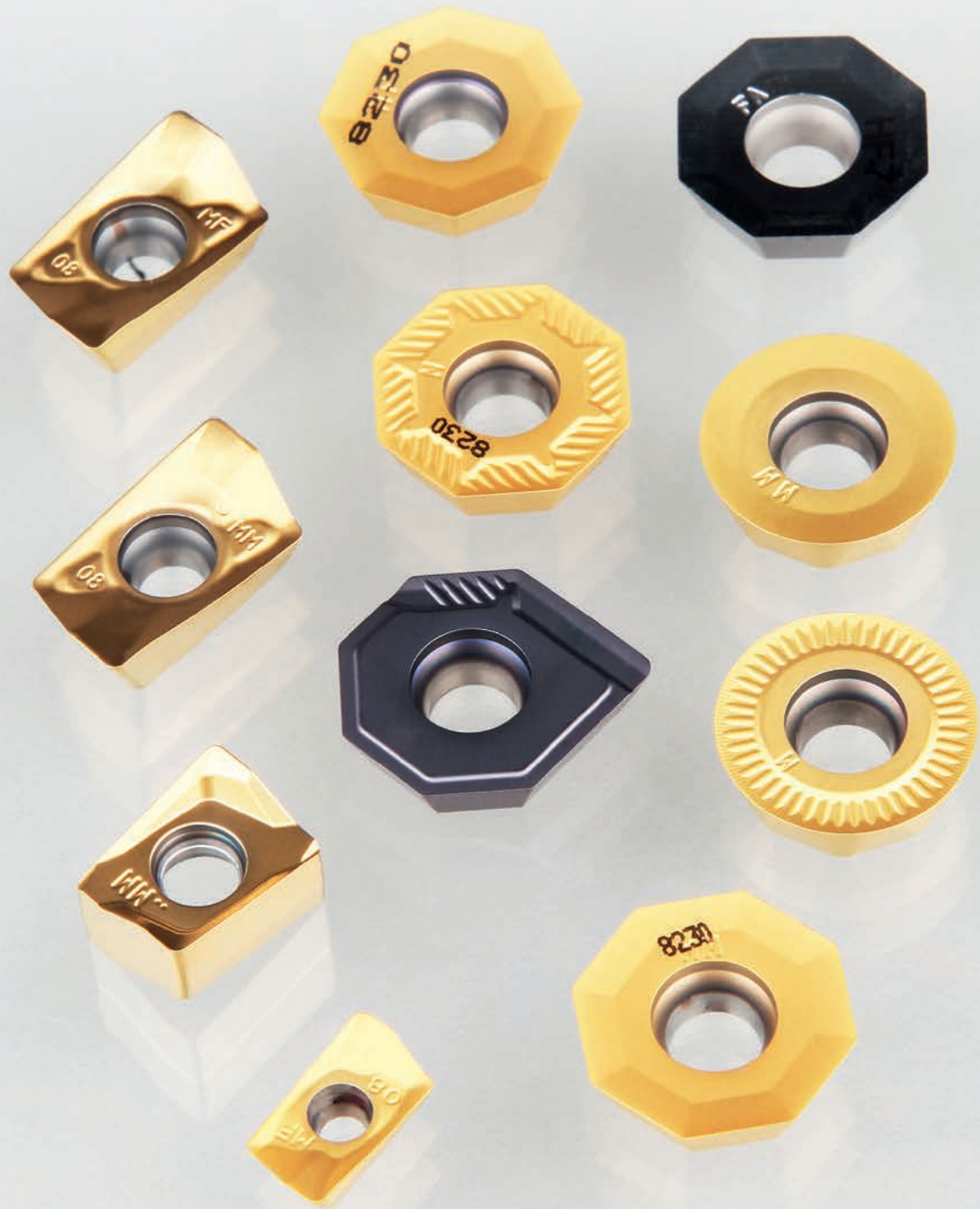

NEW INSERTS FOR MILLING STAINLESS STEEL

The ADMX11 and ADMX16 ranges of inserts for shoulder milling have been expanded with two new positive geometries - MF and MM - for machining stainless steel.

Positive rake angle and a positive land provide low cutting resistance.

NEW PRODUCTS

- **Two new geometries, MM and MF**, designed for the machining of stainless steel. They are also suitable for high temperature alloys and mild carbon steel.

BENEFITS

- **Lower cost of tooling and tool exchange.** New geometries **increase durability of the inserts**, both when machining with and without coolant.
- **Low power demand.** Positive geometry MF and MM provides low cutting resistance, reduced cutting forces and power consumption of the machine.

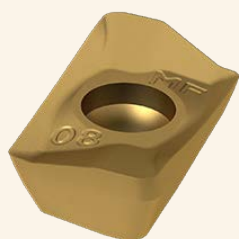

MF

GEOMETRY MF

Sharp and highly positive geometry

- Light machining
- **Finishing operations**
- Ideal for machining stainless steel
- Also suitable for machining superalloys, low carbon steel and non-ferrous materials

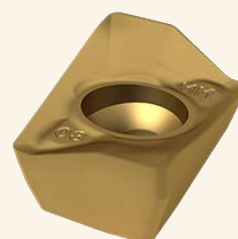

MM

GEOMETRY MM

Sharp and highly positive geometry **with stabilised cutting edge**

- **Universal geometry**
- Medium and low feeds
- Finishing and semi-roughing
- Ideal for machining stainless steel
- Also suitable for machining superalloys and low carbon steel

NEW INSERTS FOR MILLING STAINLESS STEEL

The LNGX 12 range of inserts for shoulder milling has been expanded with two new positive geometries. MF and MM geometries are an ideal choice for stainless steel milling.

NEW PRODUCTS

- **Two new geometries, MM and MF**, designed for the machining of stainless steels. They are also suitable for high temperature alloys and mild carbon steel.

BENEFITS

- **Increased durability of inserts:** Low build-up of heat (due to low contact of chip and insert).
- **Low power demand.** More positive geometry MM compared to existing geometry M provides lower cutting resistance.



MF

GEOMETRY MF

Sharp and positive geometry

- Light machining, **finishing operations**
- Light to medium cutting conditions
- Ideal for machining stainless steels
- Also suitable for machining high temperature alloys, low carbon steel, and non-ferrous materials

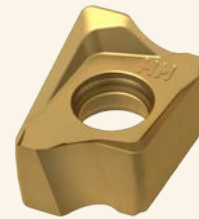

MM

GEOMETRY MM

Positive geometry with stabilised cutting edge

- Medium and low feeds
- Light to medium cutting conditions
- Ideal for machining stainless steels
- Also suitable for machining high temperature alloys and low carbon steels

NEW INSERTS FOR ECONOMICAL SHOULDER MILLING

The LNGU/LNMU 16 inserts have been expanded with new radii and geometry options. We offer a complete line of inserts to support economical and reliable shoulder milling in a wide range of materials.

GEOMETRY



RADIUS 0,8 – 4,0 mm



NEW PRODUCTS

- New geometry of inserts F and M for machining stainless steel, steel and cast iron
- Highly positive geometry FA for machining non-ferrous metals
- New options for radii 1.6, 2.0, 3.0, and 4.0

BENEFITS

- Economical shoulder milling (four cutting edges)
- Complete line of geometries and radii
- A versatile tool for a wide range of machined materials (of groups P, M, K, N).
- Stability and operational reliability

INDEXABLE CUTTING INSERTS FOR MILLING

ADEX-FM

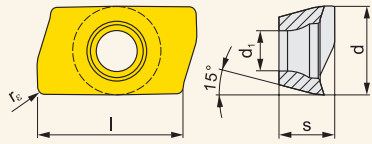

Dimensions	l	d	d ₁	s
1606	16,000	9,950	4,50	6,25

Geometry	ISO	Grade							Radius		Feed/tooth		Depth of cut	
		M9325	M9340	M8310	M8340	8215	8230	8240	r _e	f _{min}	f _{max}	a _{p min}	a _{p max}	
	ADEX 160608SR-FM	●	●	●	●	●	●	●	0,8	0,10	0,25	0,3	13,0	

ADEX-HF

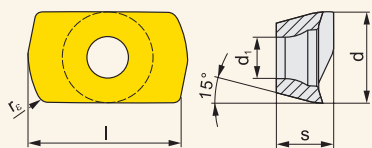

Dimensions	l	d	d ₁	s
11T3	10,665	6,530	2,90	3,80
1606	15,575	9,950	4,50	5,88

Geometry	ISO	Grade				Radius		Feed/tooth		Depth of cut	
		M8310	M8340	8215	8230	r _e	f _{min}	f _{max}	a _{p min}	a _{p max}	
	ADEX 11T308SR-HF	●	●	●	●	0,8	0,60	1,30	0,1	0,6	
	ADEX 160612SR-HF	●	●	●	●	1,2	0,60	1,30	0,3	1,3	

● New item in the assortment

● Stock assortment ○ Non-stock assortment All dimensions [mm]
See latest price list for current availability

INDEXABLE CUTTING INSERTS FOR MILLING

ADMX 07

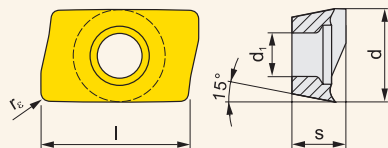

Dimensions	l	d	s	d ₁
0702	7,000	4,482	2,48	2,20

Geometry	ISO	Grade					Radius	Feed/tooth		Depth of cut	
		M9340	M8310	M8340	8215	8230	r _e	f _{min}	f _{max}	a _{p min}	a _{p max}
	ADMX 070202SR-M			●	●	●	0,2	0,03	0,12	0,1	5,0
	ADMX 070204SR-M	●	●	●	●	●	0,4	0,03	0,12	0,1	5,0
	ADMX 070208SR-M	●	●	●	●	●	0,8	0,03	0,12	0,1	5,0
	ADMX 070220SR-M			●		●	2,0	0,03	0,12	0,1	5,0

● New item in the assortment ● Stock assortment ○ Non-stock assortment All dimensions [mm]
See latest price list for current availability

MILLING TOOLS

MILLING INSERTS

TURNING INSERTS

DRILLING INSERTS

TECHNICAL SECTION

INDEXABLE CUTTING INSERTS FOR MILLING

ADMX 11

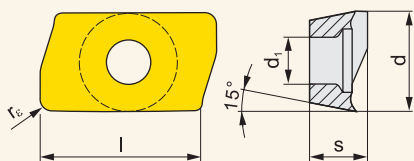

Dimensions	l	d	d ₁	s		
11T3	11,000	6,530	2,90	3,97		

Geometry	ISO	Grade								Radius		Feed/tooth		Depth of cut	
		M5315	M9315	M9325	M9340	M8310	M8340	8215	8230	8240	r _c	f _{min}	f _{max}	a _{p min}	a _{p max}
	ADMX 11T304SR-F				●	●	●	●	●		0,4	0,07	0,12	0,2	9,0
	ADMX 11T308SR-F				●	●	●	●	●		0,8	0,07	0,12	0,2	9,0
	ADMX 11T302SR-M						●		●		0,2	0,10	0,18	0,2	9,0
	ADMX 11T304SR-M			●	●	●	●	●	●		0,4	0,10	0,18	0,2	9,0
	ADMX 11T308SR-M	●	●	●	●	●	●	●	●		0,8	0,10	0,18	0,2	9,0
	ADMX 11T310SR-M						●		●		1,0	0,10	0,22	0,2	9,0
	ADMX 11T312SR-M						●	●	●		1,2	0,10	0,22	0,2	9,0
	ADMX 11T316SR-M					●	●	●	●	●	1,6	0,10	0,22	0,2	9,0
	ADMX 11T320SR-M						●		●		2,0	0,10	0,22	0,2	9,0
	ADMX 11T325SR-M						●		●		2,5	0,10	0,22	0,2	9,0
	ADMX 11T330SR-M						●		●		3,0	0,10	0,22	0,2	9,0
	ADMX 11T308PR-R	●	●	●		●	●	●	●		0,8	0,15	0,25	0,8	9,0
	ADMX 11T316PR-R			●		●	●	●			1,6	0,10	0,22	0,8	9,0
	ADMX 11T304SR-MF					●					0,4	0,07	0,14	0,2	9,0
	ADMX 11T308SR-MF					●					0,8	0,07	0,14	0,2	9,0
	ADMX 11T304SR-MM					●					0,4	0,10	0,18	0,2	9,0
	ADMX 11T308SR-MM					●					0,8	0,10	0,18	0,2	9,0
	ADMX 11T312SR-MM					●					1,2	0,10	0,18	0,2	9,0

● New item in the assortment





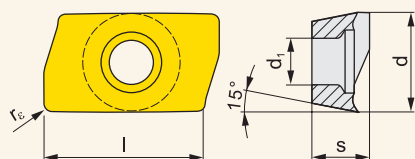

● Stock assortment ○ Non-stock assortment All dimensions [mm]
See latest price list for current availability

INDEXABLE CUTTING INSERTS FOR MILLING

ADMX 16



Dimensions	l	d	d ₁	s
1606	16,000	9,950	4,50	6,25

Geometry	ISO	Grade								Radius		Feed/tooth		Depth of cut	
		M5315	M9315	M9325	M9340	M8310	M8340	8215	8230	8240	r _e	f _{min}	f _{max}	a _{p min}	a _{p max}
	ADMX 160608SR-F				●	●	●	●	●	●	0,8	0,07	0,15	0,3	13,0
	ADMX 160604SR-M							●	●	●	0,4	0,10	0,25	0,3	13,0
	ADMX 160608SR-M	●	●	●	●	●	●	●	●	●	0,8	0,10	0,25	0,3	13,0
	ADMX 160616SR-M			●		●	●	●	●	●	1,6	0,10	0,30	0,3	13,0
	ADMX 160620SR-M							●	●		2,0	0,10	0,25	0,3	13,0
	ADMX 160630SR-M							●	●		3,0	0,10	0,25	0,3	13,0
	ADMX 160632SR-M		●			●	○	●	●		3,2	0,10	0,30	0,3	13,0
	ADMX 160640SR-M					●		●			4,0	0,10	0,25	0,3	13,0
	ADMX 160650SR-M					●		●			5,0	0,10	0,25	0,3	13,0
	ADMX 160608PR-R	●	●	●		●	●	●	●		0,8	0,17	0,35	1,0	13,0
	ADMX 160616PR-R	●	●	●		●	●	●			1,6	0,17	0,35	1,0	13,0
	ADMX 160608SR-MF					●					0,8	0,05	0,16	0,3	13,0
	ADMX 160604SR-MM					●					0,4	0,14	0,22	0,3	13,0
	ADMX 160608SR-MM					●					0,8	0,14	0,22	0,3	13,0
	ADMX 160616SR-MM					●					1,6	0,14	0,22	0,3	13,0

● New item in the assortment ● Stock assortment ○ Non-stock assortment All dimensions [mm] See latest price list for current availability

MILLING TOOLS

MILLING INSERTS

TURNING INSERTS

DRILLING INSERTS

TECHNICAL SECTION

INDEXABLE CUTTING INSERTS FOR MILLING

HNGX 06

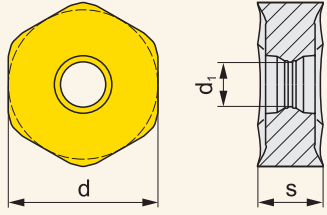

Dimensions	d	s	d ₁
0604	10,500	5,260	3,70

MILLING TOOLS

MILLING INSERTS

TURNING INSERTS

DRILLING INSERTS

TECHNICAL SECTION

Geometry	ISO	Grade								Radius	Feed/tooth		Depth of cut		
		M5315	M9315	M9325	M9340	M8310	M8340	8215	8230	8240	r _c	f _{min}	f _{max}	a _{p min}	a _{p max}
	HNGX 0604ANSN-F				●	●	●	●	●			0,08	0,17	0,3	3,0
	HNGX 0604ANSN-M	●	●	●	●	●	●	●	●			0,13	0,25	0,6	3,0
	HNGX 0604ANSN-R	●	●	●	●	●	●	●	●			0,18	0,30	1,0	3,0

● New item in the assortment ● Stock assortment ○ Non-stock assortment All dimensions [mm]
See latest price list for current availability

INDEXABLE CUTTING INSERTS FOR MILLING

HNGX 09

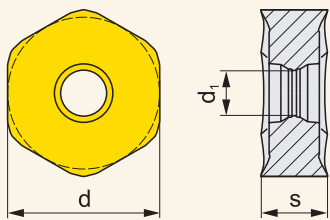

Dimensions	d	s	d ₁
0906	16,500	6,350	4,90

Geometry	ISO	Grade								Radius		Feed/tooth		Depth of cut	
		M5315	M9315	M9325	M9340	M8310	M8340	8215	8230	8240	r _e	f _{min}	f _{max}	a _{p min}	a _{p max}
			HNGX 0906ANEN-FF				●		●	●				0,05	0,20
	HNGX 0906ANSN-F				●	●	●	●	●			0,10	0,20	0,5	5,0
	HNGX 0906ANSN-M	●	●	●	●	●	●	●	●			0,17	0,35	0,8	5,0
	HNGX 0906ANSN-R	●	●	●	●	●	●	●	●			0,30	0,50	1,0	5,0

● New item in the assortment ● Stock assortment ○ Non-stock assortment All dimensions [mm]
See latest price list for current availability

MILLING TOOLS

MILLING INSERTS

TURNING INSERTS

DRILLING INSERTS

TECHNICAL SECTION

INDEXABLE CUTTING INSERTS FOR MILLING

LC12-RE

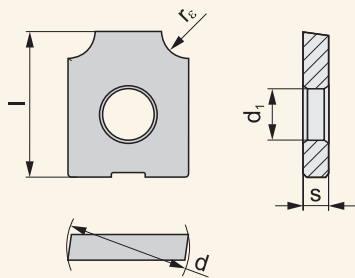

Dimensions	d	d ₁	l	s	r _ε
1210	12,000	5,000	14,00	2,50	1,0
1220	12,000	5,000	14,00	2,50	2,0
1230	12,000	5,000	14,00	2,50	3,0

Geometry	ISO	Grade										Radius		Feed/tooth		Depth of cut							
		7215										r _ε	f _{min}	f _{max}	a _{p min}	a _{p max}							
	LC 1210-RE	○																1,0	0,08	0,25	0,1	1,0	
	LC 1220-RE	○																	2,0	0,08	0,25	0,1	2,0
	LC 1230-RE	○																	3,0	0,08	0,25	0,1	3,0

LC12-RI

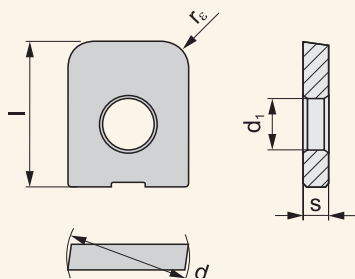

Dimensions	d	d ₁	l	s	r _ε
1215	12,000	5,000	14,00	2,50	1,5
1220	12,000	5,000	14,00	2,50	2,0
1230	12,000	5,000	14,00	2,50	3,0

Geometry	ISO	Grade										Rádus		Feed/tooth		Depth of cut								
		7215										r _ε	f _{min}	f _{max}	a _{p min}	a _{p max}								
	LC 1215-RI	○																	1,5	0,08	0,25	0,1	1,5	
	LC 1220-RI	○																		2,0	0,08	0,25	0,1	2,0
	LC 1230-RI	○																		3,0	0,08	0,25	0,1	3,0

● New item in the assortment



● Stock assortment ○ Non-stock assortment All dimensions [mm]
See latest price list for current availability

INDEXABLE CUTTING INSERTS FOR MILLING

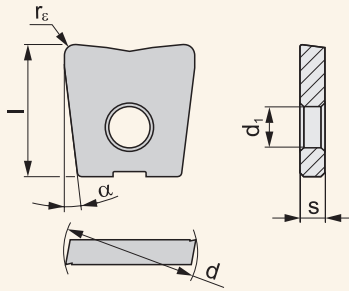
LC12-KP (KPF)



Dimensions	d	l	d ₁	s	α
08	8,000	9,500	3,00	2,00	3°
10	10,000	11,500	4,00	2,50	3°
12	12,000	14,000	5,00	2,50	7°
16	16,000	16,000	5,00	3,00	7°
20	20,000	18,000	5,00	3,00	7°

Geometry	ISO	Grade			Radius	Feed/tooth		Depth of cut	
		M8310	7215	7230	r _e	f _{min}	f _{max}	a _{p min}	a _{p max}
	LC 0806-KP	●	●	●		0,08	0,20	0,1	0,6
	LC 0810-KP	●	○	○		0,08	0,20	0,1	1,0
	LC 1008-KP	●	●	○		0,08	0,25	0,1	0,8
	LC 1010-KP	●	●	●		0,08	0,25	0,1	1,0
	LC 1210-KP	●	●	●		0,08	0,25	0,1	1,0
	LC 1220-KP		○	○		0,08	0,25	0,1	2,0
	LC 1610-KP	●	●	●		0,08	0,30	0,1	1,0
	LC 1613-KP	●	●	○		0,08	0,30	0,1	1,3
	LC 1630-KP		○	○		0,08	0,30	0,1	3,0
	LC 2010-KP	●	○	●		0,08	0,35	0,1	1,0
	LC 2016-KP	●	●	○		0,08	0,35	0,1	1,6
	LC 2040-KP		○	○		0,08	0,35	0,1	4,0
		LC 0806-KPF		●	○		0,05	0,20	0,1
LC 1008-KPF			●	○		0,05	0,20	0,1	0,8
LC 1210-KPF			○	●		0,05	0,25	0,1	1,0
LC 1613-KPF			●	○		0,05	0,30	0,1	1,3
LC 2016-KPF			○	●		0,05	0,35	0,1	1,6

● New item in the assortment



● Stock assortment ○ Non-stock assortment All dimensions [mm]
See latest price list for current availability

INDEXABLE CUTTING INSERTS FOR MILLING

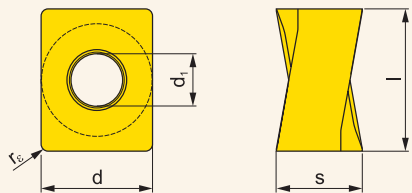
LNGU 16



Dimensions	l	d	d ₁	s
1607	16,6	13,200	5,70	10,00

Geometry	ISO	Grade							Radius			Feed/tooth		Depth of cut	
		M9315	M9325	M8340	8215	8230	8240	HF7	r _e	f _{min}	f _{max}	a _{p min}	a _{p max}		
	LNGU 160708SR-M	●	●	●	●	●	●		0,8	0,10	0,30	1,0	13,0		
	LNGU 160708FR-FA						●		0,8	0,05	0,45	0,3	13,0		

● New item in the assortment ● Stock assortment ○ Non-stock assortment All dimensions [mm] See latest price list for current availability

MILLING TOOLS
MILLING INSERTS
TURNING INSERTS
DRILLING INSERTS
TECHNICAL SECTION

INDEXABLE CUTTING INSERTS FOR MILLING

MILLING TOOLS

LNMU 16

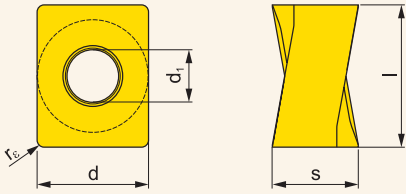

Dimensions	l	d	d ₁	s
1607	16,6	13,200	5,70	10,00

MILLING INSERTS

Geometry	ISO	Grade							Radius			Feed/tooth		Depth of cut	
		M5315	M9315	M9325	M8310	M8340	8215	8230	r _e	f _{min}	f _{max}	a _{p min}	a _{p max}		
	LNMU 160708ER-F					●	●	●	0,8	0,08	0,20	0,3	13,0		
	LNMU 160708SR-M			●		●	●	●	0,8	0,10	0,30	0,3	13,0		
	LNMU 160720SR-M					●		●	2,0	0,10	0,30	0,3	13,0		
	LNMU 160730SR-M					●		●	3,0	0,10	0,30	0,3	13,0		
	LNMU 160740SR-M					●		●	4,0	0,10	0,30	0,3	13,0		
	LNMU 160708SR-R	●	●	●	●	●	●	●	0,8	0,15	0,40	1,0	13,0		
	LNMU 160716SR-R		●	●	●	●	●	●	1,6	0,15	0,40	1,0	13,0		

● New item in the assortment ● Stock assortment ○ Non-stock assortment All dimensions [mm] See latest price list for current availability

INDEXABLE CUTTING INSERTS FOR MILLING

LNGX 12

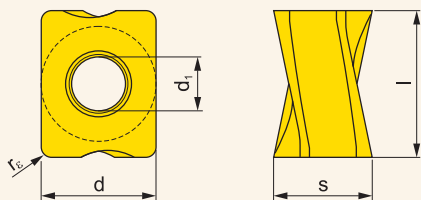

Dimensions	l	d	s	d ₁
1205	12,000	9,500	7,10	4,50

Geometry	ISO	Grade										Radius		Feed/tooth		Depth of cut	
		M0315	M5315	M9315	M9325	M9340	M8310	M8340	8215	8230	8240	HF7	r _c	f _{min}	f _{max}	a _{p min}	a _{p max}
	LNGX 120504ER-F						●	●	●				0,4	0,04	0,15	0,2	9,0
	LNGX 120508ER-F						●	●	●				0,8	0,04	0,15	0,2	9,0
	LNGX 120504ER-M						●		●				0,4	0,05	0,25	0,2	9,0
	LNGX 120508ER-M			●	●	●	●	●	●	●			0,8	0,05	0,25	0,2	9,0
	LNGX 120510ER-M						●		●				1,0	0,05	0,25	0,2	9,0
	LNGX 120512ER-M						●		●				1,2	0,05	0,25	0,2	9,0
	LNGX 120516ER-M						●		●				1,6	0,05	0,25	0,2	9,0
	LNGX 120520ER-M						●		●				2,0	0,05	0,25	0,2	9,0
	LNGX 120508SR-R		●	●	●	●	●	●	●				0,8	0,05	0,25	1,0	9,0
	LNGX 120516SR-R			●			●	●	●				1,6	0,05	0,25	1,0	9,0
	LNGX 120504ER-MF						●						0,4	0,05	0,25	0,2	9,0
	LNGX 120508ER-MF						●						0,8	0,05	0,25	0,2	9,0
	LNGX 120508SR-MM						●						0,8	0,05	0,25	0,2	9,0
	LNGX 120504FR-FA										●		0,4	0,03	0,35	0,2	9,0
	LNGX 120508FR-FA		●								●		0,8	0,03	0,35	0,2	9,0

● New item in the assortment ● Stock assortment ○ Non-stock assortment All dimensions [mm]
See latest price list for current availability

MILLING TOOLS

MILLING INSERTS

TURNING INSERTS

DRILLING INSERTS

TECHNICAL SECTION

INDEXABLE CUTTING INSERTS FOR MILLING

ODMT

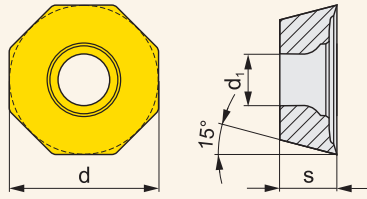

Dimensions	d	s	d ₁		
0504	12,700	4,760	4,40		
0605	15,9	5,560	5,50		

Geometry

ISO

Grade

Radius

Feed/tooth

Depth of cut

M5315

M9315

M9325

M8340

8215

8230

8240

r_ef_{min}f_{max}a_{p min}a_{p max}

Geometry	ISO	M5315	M9315	M9325	M8340	8215	8230	8240	r _e	f _{min}	f _{max}	a _{p min}	a _{p max}
ODMT 0504ZZN		●	●	●	●	●	●	●		0,12	0,45	1,0	8,6
ODMT 0605ZZN		●	●	●	●	●	●	●		0,15	0,45	1,0	8,6

● New item in the assortment



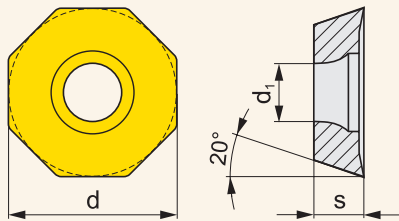

● Stock assortment ○ Non-stock assortment All dimensions [mm]
See latest price list for current availability

INDEXABLE CUTTING INSERTS FOR MILLING

OEHT 06



Dimensions	d	s	d ₁		
0604	16,100	4,760	5,50		

Geometry	ISO	Grade						Radius		Feed/tooth		Depth of cut	
		M0315	M9325	M8310	M8340	8230	HF7	r _e	f _{min}	f _{max}	a _{p min}	a _{p max}	
			OEHT 0604AEER-MF			●	●	●			0,08	0,20	0,5
	OEHT 0604AEER-MM		●	●	●	●			0,08	0,25	0,5	3,3	
	OEHT 0604AESR-M		●	●	●	●			0,08	0,35	0,8	3,3	
	OEHT 0604AEFR-FA	●					●		0,08	0,20	0,8	3,3	

● New item in the assortment ● Stock assortment ○ Non-stock assortment All dimensions [mm] See latest price list for current availability

INDEXABLE CUTTING INSERTS FOR MILLING

PDKT 09-FM

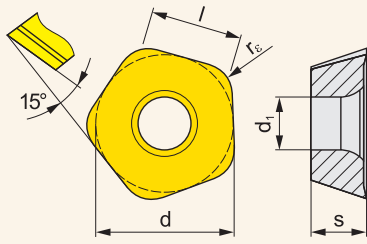

Dimensions	l	d	s	d ₁
0905	9,000	13,500	5,47	5,50

MILLING TOOLS

MILLING INSERTS

TURNING INSERTS

DRILLING INSERTS

TECHNICAL SECTION

Geometry	ISO	Grade				Radius	Feed/tooth		Depth of cut	
		M8310	M8345	8215	8230	r _c	f _{min}	f _{max}	a _{p min}	a _{p max}
	PDKT 090530ER-FM	●	●	●	●	3,0	0,50	2,50	0,3	2,0

PDMW 09

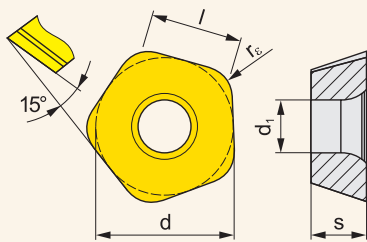

Dimensions	l	d	s	d ₁
0905	9,000	13,500	5,47	5,50

Geometry	ISO	Grade				Radius	Feed/tooth		Depth of cut	
		M9315	M9325	M8310	M8345	r _c	f _{min}	f _{max}	a _{p min}	a _{p max}
	PDMW 090530SR	●	●	●	●	3,0	0,50	2,50	0,3	2,0

● New item in the assortment

● Stock assortment ○ Non-stock assortment All dimensions [mm]
See latest price list for current availability

INDEXABLE CUTTING INSERTS FOR MILLING

PNMQ 13

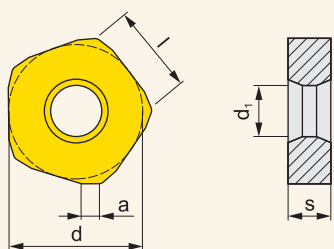

Dimensions	l	d	s	d ₁	a
1308	13,000	24,400	7,94	10,00	3,00

Geometry	ISO	Grade					Radius	Feed/tooth		Depth of cut	
		M9315	M9340	M8345	8230		r _c	f _{min}	f _{max}	a _{p min}	a _{p max}
	PNMQ 1308DNSN	●	●	●	●			0,30	0,70	0,5	10,0

PNMU 13-M

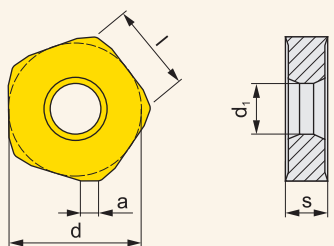

Dimensions	l	d	s	d ₁	a
1308	13,000	24,400	7,94	10,00	3,00

Geometry	ISO	Grade					Radius	Feed/tooth		Depth of cut		
		M9315	M9340	M8345	8215	8230		r _c	f _{min}	f _{max}	a _{p min}	a _{p max}
	PNMU 1308DNSR-M	●	●	●	●	●			0,25	0,70	0,5	10,0

● New item in the assortment

● Stock assortment ○ Non-stock assortment All dimensions [mm]
See latest price list for current availability

MILLING TOOLS

MILLING INSERTS

TURNING INSERTS

DRILLING INSERTS

TECHNICAL SECTION

INDEXABLE CUTTING INSERTS FOR MILLING

RC(F)

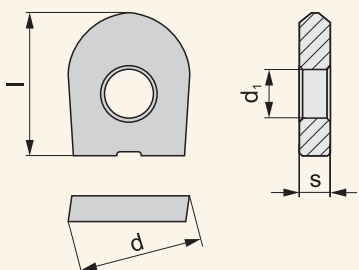

Dimensions	d	d ₁	l	s
08	8,000	3,000	9,50	2,00
10	10,000	4,000	11,50	2,50
12	12,000	5,000	12,00	2,50
16	16,000	5,000	14,00	3,00
20	20,000	5,000	16,00	3,00
25	25,000	6,000	21,50	4,00
32	32,000	8,000	25,90	5,00

Geometry	ISO	Grade			Radius	Feed/tooth		Depth of cut	
		M8310	7215	7230		r _c	f _{min}	f _{max}	a _{p min}
	RC 08	●	●	●		0,10	0,30	0,3	0,8
	RC 10	●	●	●		0,10	0,33	0,3	1,0
	RC 12	●	●	●		0,10	0,35	0,4	1,2
	RC 16	●	●	●		0,10	0,40	0,5	1,6
	RC 20	●	●	●		0,10	0,50	0,6	2,0
	RC 25	●	●	●		0,10	0,55	0,6	2,5
	RC 32		○	○		0,10	0,60	0,6	3,2
	RC 08-F		●				0,05	0,30	0,3
RC 10-F		●	○			0,05	0,33	0,3	1,0
RC 12-F		●	○			0,05	0,35	0,4	1,2
RC 16-F		●	●			0,05	0,40	0,5	1,6
RC 20-F		●	●			0,05	0,50	0,5	2,0
RC 25-F		●	○			0,05	0,50	0,6	2,5
RC 32-F		○				0,05	0,60	0,6	3,2

● New item in the assortment ● Stock assortment ○ Non-stock assortment All dimensions [mm]
See latest price list for current availability

MILLING TOOLS

MILLING INSERTS

TURNING INSERTS

DRILLING INSERTS

TECHNICAL SECTION

INDEXABLE CUTTING INSERTS FOR MILLING

RCMT

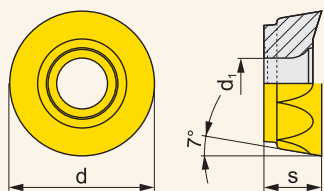

Dimensions	d	s	d ₁		
1204	12,000	4,760	4,40		
1606	16,000	6,350	5,50		
2006	20,000	6,350	5,50		

Geometry	ISO	Grade							Radius		Feed/tooth		Depth of cut	
		M9315	M9325	M9340	M8310	M8345	8215	8230	r _e	f _{min}	f _{max}	a _{p min}	a _{p max}	
	RCMT 1204MOEN-F				●		●	●			0,05	0,20	0,3	6,0
	RCMT 1606MOEN-F				●			●			0,05	0,25	0,3	8,0
	RCMT 2006MOSN-F			●							0,08	0,30	0,3	10,0
	RCMT 1204MOSN-M		●	●	●	●	●	●			0,15	0,40	0,3	6,0
	RCMT 1606MOSN-M		●	●		●	●	●			0,15	0,45	0,3	8,0
	RCMT 2006MOSN-M	●	●	●		●	●	●			0,15	0,45	0,3	10,0
	RCMT 1204MOEN-R	●		●	●			●			0,20	0,50	0,3	6,0
	RCMT 1204MOSN-R	●				●					0,20	0,50	0,3	6,0
	RCMT 1606MOSN-R		●		●	●		●			0,20	0,60	0,3	8,0
	RCMT 2006MOSN-R		●		●			●			0,20	0,60	0,3	10,0

● New item in the assortment

● Stock assortment ○ Non-stock assortment All dimensions [mm] See latest price list for current availability

MILLING TOOLS

MILLING INSERTS

TURNING INSERTS

DRILLING INSERTS

TECHNICAL SECTION

INDEXABLE CUTTING INSERTS FOR MILLING

MILLING TOOLS

REHT 16

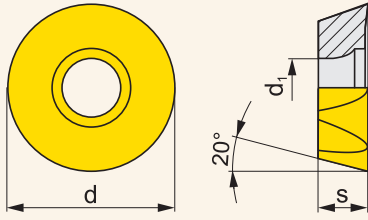

Dimensions	d	s	d ₁		
1604	16,000	4,760	5,50		

MILLING INSERTS

Geometry	ISO	Grade								Radius		Feed/tooth		Depth of cut	
		M9325	M8310	M8340	8230					r _c	f _{min}	f _{max}	a _{p min}	a _{p max}	
	REHT 1604M0EN-MM	●	●	●	●						0,08	0,25	0,5	4,0	
	REHT 1604M0SN-M	●	●	●	●						0,08	0,35	0,8	4,0	

TURNING INSERTS

SPKN EDS

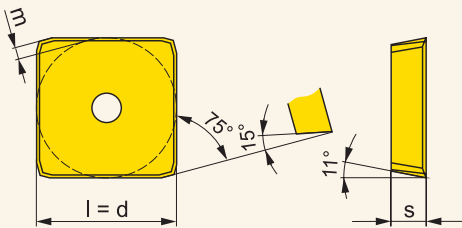

Dimensions	l	d	s	m		
1203	12,700	12,700	3,18	0,88		
1504	15,900	15,875	4,76	1,26		

DRILLING INSERTS

Geometry	ISO	Grade										Radius		Feed/tooth		Depth of cut	
		M5315	M9315	M9325	M8340	8215	8230	8240	H10	S26			r _c	f _{min}	f _{max}	a _{p min}	a _{p max}
	SPKN 1203EDSR	●	●	●	●	●	●	●	●	●				0,15	0,30	1,0	9,0
	SPKN 1203EDSL						○							0,15	0,30	1,0	9,0
	SPKN 1504EDSR	●	●	●	●	●	●	●	●	●				0,20	0,40	1,0	13,0
	SPKN 1504EDSL				○		○							0,20	0,40	1,0	13,0

TECHNICAL SECTION

● New item in the assortment

● Stock assortment ○ Non-stock assortment All dimensions [mm]
See latest price list for current availability

INDEXABLE CUTTING INSERTS FOR MILLING

ZDCW

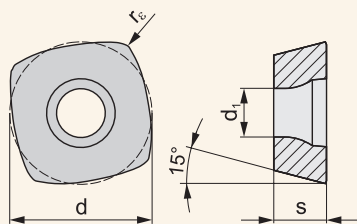

Dimensions	l	d	s	d ₁
0703	6,800	6,800	3,18	2,40
09T3	9,500	9,525	3,97	3,40

Geometry	ISO	Grade						Radius		Feed/tooth		Depth of cut	
		M8310	M8325	M8345	7205	7215	7230	r _c	f _{min}	f _{max}	a _{p min}	a _{p max}	
	ZDCW 070304	●	●	●	○	●	●	0,4	0,15	1,50	0,3	1,0	
	ZDCW 09T304	●	●	●	○	●	●	0,4	0,30	2,00	0,3	1,0	

XEHT 06

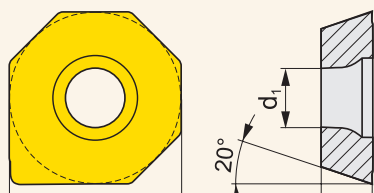

Dimensions	d	s	d ₁
0604	16,100	4,760	5,50

Geometry	ISO	Grade						Radius		Feed/tooth		Depth of cut	
		M8310						r _c	f _{min}	f _{max}	a _{p min}	a _{p max}	
	XEHT 0604AESR	●							0,08	0,35	0,1	0,5	

● New item in the assortment

● Stock assortment ○ Non-stock assortment All dimensions [mm]
See latest price list for current availability

TURNING INSERTS



NEW INSERTS FOR TURNING OF DIFFICULT-TO-MACHINE MATERIALS

New positive chip-breakers have been designed specifically for turning of difficult-to-machine materials, promoting longer insert durability.

NEW PRODUCTS

- **Two new positive geometries**, SF and SM
- Inserts with new chip-breakers in **new grades** T6310 and H07 for difficult-to-machine materials.

BENEFITS

- **Longer durability** of inserts with the same cutting conditions, or **higher cutting speed** with the same durability
- Chip-breakers are also designed for turning stainless steel and mild steel
- Suitable for turning sections with thin walls

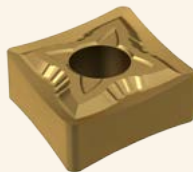

SF

CHIP-BREAKER SF

Sharp positive geometry with inclination cutting edge

- **Finishing machining**
- Very low cutting forces
- Continuous cut
- Suitable for materials with poor machinability, such as stainless steels, mild steels and high temperature alloys

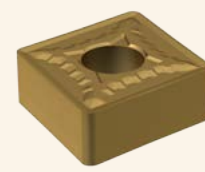

SM

CHIP-BREAKER SM

Wear-resistant and universal positive geometry

- **Medium machining**
- High productivity
- Continuous and interrupted cut
- Suitable for materials with poor machinability, such as stainless steels, mild steels and high temperature alloys



Which chip-breaker should be used?

- Finishing machining (continuous cut): chip-breaker **SF**
- Versatile (continuous and interrupted cut): chip-breaker **SM**
- The NF and RM chip-breakers with the new T6310 grade are now also suitable for materials with poor machinability.

New chip-breakers complement existing geometries to offer a wide choice of cutting conditions:

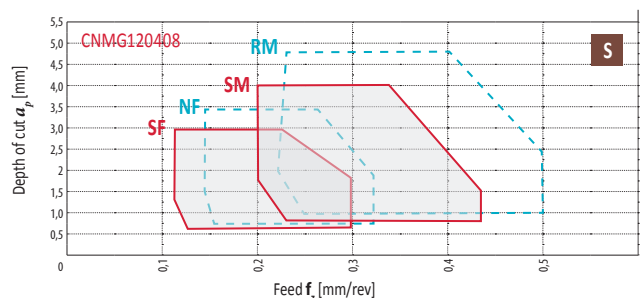

T6310, H07

TURNING INSERTS

NEW GRADES FOR TURNING OF DIFFICULT-TO-MACHINE MATERIALS

In addition to new chip-breakers, we have launched two grades which will increase reliability of the inserts for turning materials with poor machinability and titanium alloys.

T6310 GRADE

- **High reliability** due to special new sintering process
- High wear resistance (new substrate with high strength and hardness)
- PVD coating using Triple Coating Technology: Multi-layer TiAlN + top layer AlTiSiN with high hardness

T6310

H07 GRADE

- Special uncoated material for turning titanium and its alloys.
- Fine-grain substrate with low cobalt content.

H07

BENEFITS

- High strength and reliability of the insert during continuous cut
- Resistance to heat-related cracks
- Universal use for stainless steels, heat-treated and hardened materials
- Excellent durability of the inserts for higher cutting speeds

BENEFITS

- High abrasion resistance
- Resistance to pitting on the cutting face when machining titanium and its alloys
- Resistance to plastic deformation
- Also suitable for the machining of non-ferrous metals and cast iron

MACHINING EXAMPLE USING T6310 GRADE

Material: INCONEL 718
 Insert: CNMG 120408E-SF:T6310
 Coolant: No

Cutting speed	v_c	35	m/min
Feed	f	0,15	mm
Axial length of cut	a_p	1,5	mm

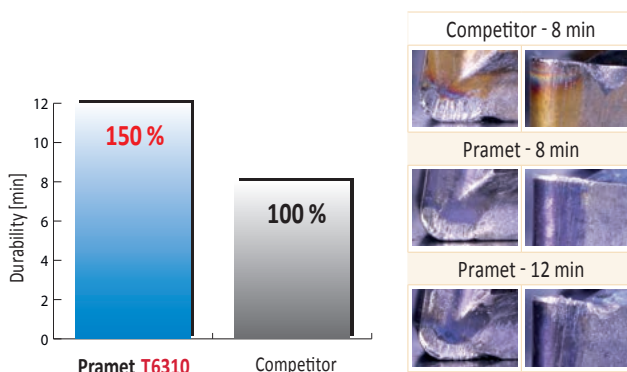

i

Which grade should be used?

Difficult-to-machine materials:

1. Finishing and medium machining (continuous cut): T6310
2. Where higher toughness is necessary, e.g. welded parts (interrupted cut): T8330

Titanium alloys:

1. H07 + chip-breaker SF
2. T6310 + chip-breaker SM

INDEXABLE CUTTING INSERTS FOR TURNING

CCGT

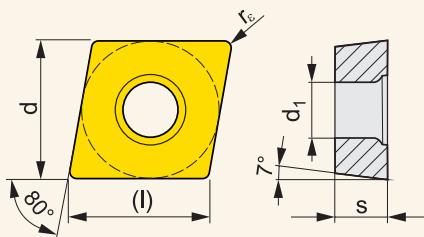

Dimensions	l	d	d ₁	s
0602	6,4	6,350	2,80	2,38
0803	8,1	7,940	3,40	3,18
09T3	9,7	9,525	4,40	3,97
1204	12,9	12,700	5,50	4,76

Chip-breaker	ISO	Grade					Radius	Feed/rev.		Depth of cut	
		T0315	T8310	T8315	T8330	HF7	r _c	f _{min}	f _{max}	a _{p min}	a _{p max}
	CCGT 060202F-AL	●				●	0,2	0,06	0,15	0,3	3,0
	CCGT 060204F-AL	●				●	0,4	0,10	0,30	0,4	3,5
	CCGT 080302E-AL		●				0,2	0,05	0,15	0,3	2,5
	CCGT 080302F-AL	●					0,2	0,05	0,15	0,3	2,5
	CCGT 080304E-AL		●				0,4	0,05	0,30	0,4	2,5
	CCGT 080304F-AL	●				●	0,4	0,05	0,30	0,4	2,5
	CCGT 09T302F-AL	●				●	0,2	0,10	0,15	0,3	4,0
	CCGT 09T304F-AL	●				●	0,4	0,10	0,30	0,4	4,5
	CCGT 09T308F-AL	●				●	0,8	0,15	0,60	0,8	5,0
	CCGT 120404F-AL	●				●	0,4	0,10	0,30	0,4	7,0
	CCGT 120408F-AL	●				●	0,8	0,15	0,60	0,8	7,0
		CCGT 060202ER-SI				●		0,2	0,08	0,15	0,4
CCGT 060204ER-SI			●	●			0,4	0,08	0,25	0,5	1,5
CCGT 09T304ER-SI			●	●			0,4	0,14	0,30	0,8	2,0
CCGT 120408ER-SI				●			0,8	0,22	0,44	1,0	4,0
	CCGT 060202EL-SI				●		0,2	0,08	0,15	0,4	1,6
	CCGT 060204EL-SI		●	●			0,4	0,08	0,25	0,5	1,5
	CCGT 09T304EL-SI		●	●			0,4	0,14	0,30	0,8	2,0
	CCGT 120408EL-SI			●			0,8	0,22	0,44	1,0	4,0

● New item in the assortment

● Stock assortment ○ Non-stock assortment All dimensions [mm]
See latest price list for current availability

INDEXABLE CUTTING INSERTS FOR TURNING

CCMT

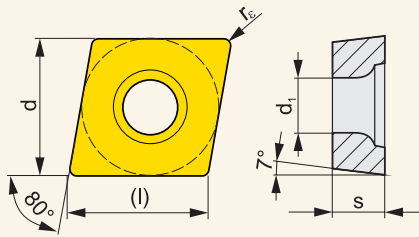



Dimensions	(l)	d	d ₁	s		
0602	6,4	6,350	2,90	2,38		
0803	8,1	7,940	3,40	3,18		
09T3	9,7	9,525	4,50	3,97		
1204	12,9	12,700	5,60	4,76		

Chip-breaker	ISO	Grade										Radius		Feed/rev.		Depth of cut		
		T5305	T5315	T7335	T9310	T9315	T9325	T9335	6630	T8315	T8330	TT010	TT310	r _c	f _{min}	f _{max}	a _{p min}	a _{p max}
	CCMT 060202E-FF									●	●			0,2	0,05	0,15	0,2	2,0
	CCMT 060204E-FF									●	●			0,4	0,05	0,23	0,4	2,0
	CCMT 09T304E-FF									●	●			0,4	0,05	0,23	0,4	2,0
	CCMT 080302E-FF2						●					●		0,2	0,04	0,15	0,2	1,5
	CCMT 080304E-FF2						●					●		0,4	0,06	0,23	0,4	2,5
	CCMT 060202E-FM			●	●	●				●	●			0,2	0,08	0,15	0,2	1,0
	CCMT 060204E-FM			●	●	●				●	●			0,4	0,08	0,20	0,4	1,5
	CCMT 060208E-FM				●	●					●			0,8	0,12	0,30	0,8	2,0
	CCMT 09T302E-FM			●	●	●				●	●			0,2	0,05	0,15	0,2	3,0
	CCMT 09T304E-FM			●	●	●				●	●			0,4	0,10	0,30	0,4	3,0
	CCMT 09T308E-FM			●	●	●				●	●			0,8	0,15	0,35	0,8	3,0
	CCMT 120404E-FM			●	●	●				●	●			0,4	0,10	0,30	0,4	4,0
	CCMT 120408E-FM			●	●	●				●	●			0,8	0,15	0,35	0,8	4,0
	CCMT 120412E-FM				●	●					●			1,2	0,15	0,45	1,2	4,0
	CCMT 080304E-FM2				●	●	●							0,4	0,15	0,25	0,4	2,7
	CCMT 080308E-FM2					●	●							0,8	0,15	0,40	0,8	4,0
	CCMT 080304E-NF2		●	●	●	●								0,4	0,12	0,25	0,5	3,6
	CCMT 080308E-NF2		●	●		●								0,8	0,17	0,40	1,0	4,0
	CCMT 060202E-RF			●										0,2	0,10	0,15	1,0	3,0
	CCMT 060204E-RF		●	●				●						0,4	0,10	0,30	1,0	3,0
	CCMT 09T304E-RF			●				●						0,4	0,15	0,30	0,8	4,0
	CCMT 09T308E-RF		●	●				●						0,8	0,10	0,40	0,8	4,0
	CCMT 120408E-RF		●	●				●						0,8	0,20	0,60	1,0	8,0
	CCMT 09T304E-RM	●	●	●	●	●				●				0,4	0,15	0,30	1,0	4,0
	CCMT 09T308E-RM	●	●	●	●	●				●				0,8	0,20	0,40	1,5	4,0
	CCMT 120408E-RM	●	●	●	●	●				●				0,8	0,20	0,40	1,5	4,5
	CCMT 120412E-RM				●	●				●				1,2	0,20	0,50	1,5	4,5

● New item in the assortment

● Stock assortment ○ Non-stock assortment All dimensions [mm]
See latest price list for current availability

INDEXABLE CUTTING INSERTS FOR TURNING

Chip-breaker	ISO	Grade										Radius		Feed/rev.		Depth of cut		
		T5305	T5315	T7335	T9310	T9315	T9325	T9335	6630	T8315	T8330	TT010	TT310	r_c	f_{min}	f_{max}	$a_{p min}$	$a_{p max}$
	CCMT 060202E-UR			●		●				●	●	●		0,2	0,08	0,15	0,2	3,0
	CCMT 060204E-UR		●	●		●	●			●	●	●		0,4	0,08	0,30	0,4	3,0
	CCMT 060208E-UR		●			●	●			●				0,8	0,08	0,50	0,8	3,0
	CCMT 09T302E-UR											●		0,2	0,08	0,15	0,2	3,0
	CCMT 09T304E-UR		●	●	●	●	●			●	●	●		0,4	0,08	0,30	0,4	4,0
	CCMT 09T308E-UR		●	●	●	●	●			●	●	●		0,8	0,08	0,50	0,8	3,0
	CCMT 120404E-UR		●			●	●			●				0,4	0,08	0,30	0,4	3,0
	CCMT 120408E-UR		●	●		●	●			●				0,8	0,08	0,50	0,8	4,0
	CCMT 120412E-UR		●			●	●			●				1,2	0,08	0,50	1,2	4,0
	CCMT 060204W-UR											●		0,4	0,08	0,30	0,4	2,0
	CCMT 09T308W-UR											●		0,8	0,08	0,50	0,8	3,0

MILLING TOOLS

MILLING INSERTS

TURNING INSERTS

DRILLING INSERTS

TECHNICAL SECTION

● New item in the assortment

● Stock assortment ○ Non-stock assortment All dimensions [mm]
See latest price list for current availability

INDEXABLE CUTTING INSERTS FOR TURNING

CCMW

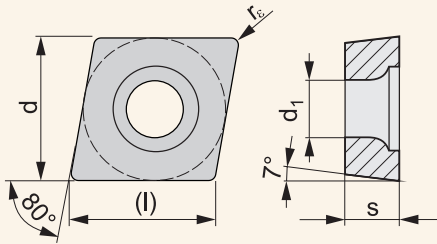

Dimensions	(l)	d	d ₁	s		
0602	6,4	6,350	2,80	2,38		
09T3	9,7	9,525	4,40	3,97		
1204	12,9	12,700	5,50	4,76		

MILLING TOOLS

MILLING INSERTS

TURNING INSERTS

DRILLING INSERTS

TECHNICAL SECTION

Chip-breaker	ISO	Grade				Radius	Feed/rev.		Depth of cut	
		T5305	T5315			r _c	f _{min}	f _{max}	a _{p min}	a _{p max}
	CCMW 060202	●	●			0,2	0,05	0,15	0,2	4,2
	CCMW 060204	●	●			0,4	0,05	0,30	0,4	4,2
	CCMW 09T304	●	●			0,4	0,05	0,30	0,4	6,3
	CCMW 09T308	●	●			0,8	0,05	0,35	0,8	6,3
	CCMW 120404	●	●			0,4	0,05	0,30	0,4	8,4
	CCMW 120408	●	●			0,8	0,05	0,40	0,8	8,4

CNGG

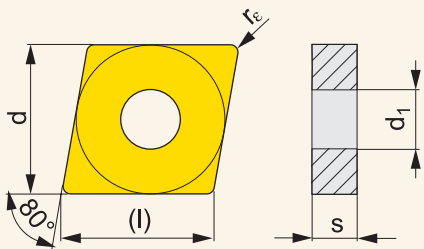

Dimensions	(l)	d	d ₁	s		
1204	12,9	12,700	5,16	4,76		

Chip-breaker	ISO	Grade				Radius	Feed/rev.		Depth of cut	
		T6310	T8315	T8330	H07	r _c	f _{min}	f _{max}	a _{p min}	a _{p max}
	CNGG 120402E-SF	●	●	●	●	0,2	0,08	0,15	0,2	2,5

● New item in the assortment

● Stock assortment ○ Non-stock assortment All dimensions [mm]
See latest price list for current availability

INDEXABLE CUTTING INSERTS FOR TURNING

CNMA

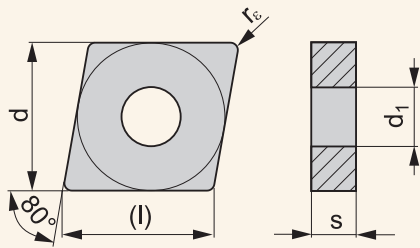

Dimensions	(l)	d	d ₁	s
1204	12,9	12,700	5,16	4,76
1606	16,1	15,875	6,35	6,35
1906	19,3	19,050	7,94	6,35

Chip-breaker	ISO	Grade						Radius			Feed/rev.			Depth of cut	
		T5305	T5315	T6310				r _c	f _{min}	f _{max}	a _{p min}	a _{p max}			
	CNMA 120404	●	●					0,4	0,10	0,30	0,4	8,4			
	CNMA 120408	●	●	●				0,8	0,05	0,60	0,8	8,4			
	CNMA 120412	●	●	●				1,2	0,05	0,60	1,2	8,4			
	CNMA 120416	●	●					1,6	0,10	0,60	1,6	8,4			
	CNMA 160612	●	●					1,2	0,10	0,90	1,2	10,6			
	CNMA 190612	●	●					1,2	0,10	0,90	1,2	12,7			
	CNMA 190616	●	●					1,6	0,10	0,90	1,6	12,7			
	CNMA 120408S	●						0,8	0,10	0,60	0,8	8,4			
	CNMA 120412S	●						1,2	0,10	0,60	1,6	8,4			
	CNMA 160612S	●						1,2	0,10	0,60	1,2	8,5			
	CNMA 190616S	●						1,6	0,10	0,90	1,6	12,7			

● New item in the assortment ● Stock assortment ○ Non-stock assortment All dimensions [mm] See latest price list for current availability

INDEXABLE CUTTING INSERTS FOR TURNING

CNMG

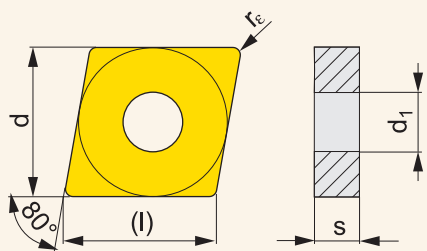

Dimensions	l	d	d ₁	s
0903	9,7	9,525	3,81	3,18
1204	12,9	12,700	5,16	4,76
1606	16,1	15,875	6,35	6,35
1906	19,3	19,050	7,94	6,35
2509	25,8	25,400	9,12	9,52

MILLING TOOLS

MILLING INSERTS

TURNING INSERTS

DRILLING INSERTS







TECHNICAL SECTION

Chip-breaker	ISO	Grade											Radius		Feed/rev.		Depth of cut				
		T5305	T5315	T7335	T9310	T9315	T9325	T9335	6630	6640	T6310	T8315	T8330	H07	HF7	TT310	r _c	f _{min}	f _{max}	a _{p min}	a _{p max}
	CNMG 120408W-F		●			●	●										0,8	0,10	0,60	0,8	4,4
	CNMG 120404E-FF													●			0,4	0,06	0,15	0,4	1,5
	CNMG 120408E-FF													●			0,8	0,08	0,20	0,8	1,5
	CNMG 090304E-FM					●	●							●			0,4	0,10	0,30	0,5	6,3
	CNMG 090308E-FM					●	●							●			0,8	0,10	0,45	0,8	3,0
	CNMG 120404E-FM			●	●	●	●						●	●		●	0,4	0,10	0,30	0,5	3,0
	CNMG 120408E-FM			●	●	●	●						●	●		●	0,8	0,15	0,45	0,8	3,0
	CNMG 120412E-FM					●	●										1,2	0,15	0,45	1,2	4,0
	CNMG 120408E-KR	●	●														0,8	0,25	0,60	0,8	7,0
	CNMG 120412E-KR	●	●														1,2	0,25	0,70	1,2	7,0
	CNMG 090308E-M					●	●	●									0,8	0,15	0,60	0,8	4,0
	CNMG 120404E-M		●		●	●	●	●									0,4	0,17	0,30	0,8	6,0
	CNMG 120408E-M	●	●		●	●	●	●	●	●				●			0,8	0,15	0,60	0,8	6,0
	CNMG 120412E-M	●	●		●	●	●	●	●	●							1,2	0,17	0,80	1,2	6,0
	CNMG 120416E-M	●					●	●									1,6	0,17	0,80	1,6	8,0
	CNMG 160608E-M				●	●	●	●	●								0,8	0,15	0,60	0,8	7,0
	CNMG 160612E-M					●	●	●									1,2	0,17	0,60	1,2	7,0
	CNMG 160616E-M						●	●									1,6	0,17	0,60	1,6	7,0
	CNMG 190608E-M					●	●	●	●	●							0,8	0,15	0,60	0,8	8,0
	CNMG 190612E-M					●	●	●	●	●	●						1,2	0,17	0,80	1,2	8,0
	CNMG 190616E-M					●	●	●	●								1,6	0,17	0,80	1,6	8,0
	CNMG 120408W-M		●			●	●										0,8	0,15	0,60	0,8	4,0
	CNMG 120412W-M		●			●	●										1,2	0,20	0,90	1,2	4,0
	CNMG 120404W-MR					●	●										0,4	0,39	0,60	0,5	4,0
	CNMG 120408W-MR		●			●	●										0,8	0,46	0,70	0,8	5,0
	CNMG 120412W-MR		●			●	●										1,2	0,49	0,75	1,2	5,0

● New item in the assortment

● Stock assortment ○ Non-stock assortment All dimensions [mm]
See latest price list for current availability

INDEXABLE CUTTING INSERTS FOR TURNING

Chip-breaker	ISO	Grade											Radius		Feed/rev.		Depth of cut					
		T5305	T5315	T7335	T9310	T9315	T9325	T9335	6630	6640	T6310	T8315	T8330	H07	HF7	TT310	r _c	f _{min}	f _{max}	a _{p min}	a _{p max}	
	CNMG 090304E-NF			●			●					●	●	●				0,4	0,10	0,30	0,4	3,0
	CNMG 090308E-NF			●			●					●	●	●				0,8	0,13	0,30	0,8	3,0
	CNMG 120404E-NF			●		●	●					●	●	●		●		0,4	0,13	0,30	0,4	3,0
	CNMG 120408E-NF			●		●	●					●	●	●		●		0,8	0,15	0,35	0,8	3,5
	CNMG 120412E-NF			●		●	●					●	●	●				1,2	0,15	0,35	1,2	4,0
	CNMG 120404E-NM			●		●	●					●	●				0,4	0,15	0,30	0,5	3,0	
	CNMG 120408E-NM			●		●	●					●	●				0,8	0,20	0,40	0,8	3,0	
	CNMG 120412E-NM			●		●	●					●	●				1,2	0,20	0,40	1,2	3,5	
	CNMG 160608E-NM			●			●					●	●				0,8	0,25	0,50	0,8	5,0	
	CNMG 160612E-NM			●			●					●	●				1,2	0,25	0,50	1,2	5,0	
	CNMG 190612E-NM			●			●					●	●				1,2	0,30	0,50	1,2	8,0	
	CNMG 120408E-R	●	●		●	●	●	●	●								0,8	0,17	0,60	1,0	8,0	
	CNMG 120412E-R	●	●		●	●	●	●	●								1,2	0,25	0,70	2,0	6,0	
	CNMG 120416E-R		●					●									1,6	0,30	0,80	2,0	6,0	
	CNMG 160608E-R		●														0,8	0,25	0,60	2,0	7,0	
	CNMG 160612E-R	●	●		●	●	●		●								1,2	0,25	0,70	2,0	7,0	
	CNMG 160616E-R	●															1,6	0,25	0,80	2,0	7,0	
	CNMG 190608E-R		●														0,8	0,25	0,60	2,0	8,0	
	CNMG 190612E-R	●	●		●	●	●	●	●	●							1,2	0,25	0,70	2,0	8,0	
	CNMG 190616E-R	●	●		●	●	●	●	●	●							1,6	0,25	0,80	2,0	9,0	
	CNMG 120408E-RM	●	●	●	●	●	●					●	●	●			0,8	0,20	0,50	1,0	7,0	
	CNMG 120412E-RM	●	●	●	●	●	●					●	●	●			1,2	0,25	0,70	1,5	7,0	
	CNMG 120416E-RM	●	●	●	●	●	●						●				1,6	0,30	0,75	2,0	7,0	
	CNMG 160608E-RM	●	●	●		●	●	●					●				0,8	0,20	0,50	1,0	8,0	
	CNMG 160612E-RM	●	●	●	●	●	●					●	●				1,2	0,25	0,70	1,5	8,0	
	CNMG 160616E-RM	●	●	●	●	●	●										1,6	0,30	0,80	2,0	8,0	
	CNMG 190608E-RM	●	●	●		●	●	●									0,8	0,20	0,50	1,0	10,0	
	CNMG 190612E-RM	●	●	●	●	●	●						●	●			1,2	0,25	0,70	1,5	10,0	
	CNMG 190616E-RM	●	●	●	●	●	●						●				1,6	0,30	0,80	2,0	10,0	
	CNMG 250924E-RM			●		●	●	●									2,4	0,40	1,00	2,5	15,0	
	CNMG 120404E-SF			●								●	●	●	●		0,4	0,10	0,30	0,4	2,7	
	CNMG 120408E-SF			●								●	●	●	●		0,8	0,12	0,30	0,8	3,0	
	CNMG 120412E-SF											●	●	●			1,2	0,15	0,35	1,2	3,0	
	CNMG 120404E-SM			●		●	●					●	●				0,4	0,18	0,30	0,4	4,0	
	CNMG 120408E-SM			●		●	●					●	●				0,8	0,20	0,45	0,8	4,0	
	CNMG 120412E-SM			●		●	●					●	●				1,2	0,22	0,45	1,2	4,5	
	CNMG 160608E-SM			●			●						●				0,8	0,22	0,50	0,8	5,0	
	CNMG 160612E-SM			●		●	●					●					1,2	0,25	0,55	1,2	5,5	
	CNMG 190612E-SM			●		●	●					●					1,2	0,25	0,55	1,2	6,0	

● New item in the assortment

● Stock assortment ○ Non-stock assortment All dimensions [mm]
See latest price list for current availability

MILLING TOOLS

MILLING INSERTS

TURNING INSERTS

DRILLING INSERTS

TECHNICAL SECTION

INDEXABLE CUTTING INSERTS FOR TURNING

MILLING TOOLS

MILLING INSERTS

TURNING INSERTS

DRILLING INSERTS

TECHNICAL SECTION

Chip-breaker	ISO	Grade										Radius			Feed/rev.		Depth of cut				
		T5305	T5315	T7335	T9310	T9315	T9325	T9335	6630	6640	T6310	T8315	T8330	H07	HF7	TT310	r _c	f _{min}	f _{max}	a _{p min}	a _{p max}
	CNMG 120404EL-SI			●			●						●	●			0,4	0,20	0,30	0,8	5,0
	CNMG 120408EL-SI			●			●						●	●			0,8	0,20	0,50	0,8	5,0
	CNMG 120412EL-SI						●							●			1,2	0,20	0,50	1,2	5,0
	CNMG 120404ER-SI			●			●	●					●	●			0,4	0,20	0,30	0,8	5,0
	CNMG 120408ER-SI			●			●	●					●	●			0,8	0,20	0,50	0,8	5,0
	CNMG 120412ER-SI						●							●			1,2	0,20	0,50	1,2	5,0

● New item in the assortment ● Stock assortment ○ Non-stock assortment All dimensions [mm]
 See latest price list for current availability

INDEXABLE CUTTING INSERTS FOR TURNING

CNMM

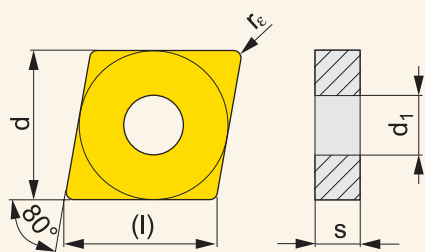

Dimensions	l	d	d ₁	s		
1204	12,9	12,700	5,16	4,76		
1606	16,1	15,875	6,35	6,35		
1906	19,3	19,050	7,94	6,35		
2509	25,8	25,400	9,12	9,52		



Chip-breaker	ISO	Grade								Radius		Feed/rev.		Depth of cut	
		T7335	T9315	T9325	T9335	6630	6640	T8330	T8345	r _c	f _{min}	f _{max}	a _{p min}	a _{p max}	
	CNMM 160612E-DR		●	●	●					1,2	0,30	0,85	2,5	9,0	
	CNMM 190608E-DR		●	●	●					0,8	0,30	0,60	2,5	9,0	
	CNMM 190612E-DR		●	●	●	●				1,2	0,30	0,85	2,5	9,0	
	CNMM 190616E-DR		●	●	●					1,6	0,30	0,85	2,5	9,0	
	CNMM 190616E-HR		●	●	●	●	●	●		1,6	0,50	1,20	5,0	13,3	
	CNMM 190624E-HR		●	●	●	●		●		2,4	0,50	1,40	5,0	13,3	
	CNMM 250924E-HR		●	●	●	●	●	●		2,4	0,50	1,40	5,0	14,0	
	CNMM 120408E-NR	●	●	●		●	●	●		0,8	0,25	0,60	1,0	8,4	
	CNMM 120412E-NR	●	●	●				●		1,2	0,25	0,80	1,2	8,4	
	CNMM 120408E-NR2	●	●	●				●		0,8	0,25	0,55	0,8	7,5	
	CNMM 120412E-NR2	●	●	●				●		1,2	0,28	0,70	1,2	7,5	
	CNMM 160608E-NR2	●		●				●		0,8	0,30	0,60	1,0	9,5	
	CNMM 160612E-NR2	●	●	●				●		1,2	0,35	0,65	1,5	9,5	
	CNMM 160616E-NR2	●		●						1,6	0,35	0,80	2,0	9,5	
	CNMM 190612E-NR2	●	●	●				●		1,2	0,35	0,90	1,5	12,0	
	CNMM 190616E-NR2	●	●	●				●		1,6	0,40	1,00	2,0	12,0	
	CNMM 190624E-NR2	●	●	●						2,4	0,40	1,20	2,5	12,0	
	CNMM 250924E-NR2	●	●	●				●		2,4	0,40	1,60	2,5	16,0	
		CNMM 120408E-OR		●	●	●			●		0,8	0,25	0,60	2,0	8,0
CNMM 120412E-OR			●	●	●					1,2	0,30	0,70	2,5	8,0	
CNMM 120416E-OR			●	●	●					1,6	0,35	0,80	2,0	8,0	
CNMM 160608E-OR			●	●	●					0,8	0,30	0,60	3,0	8,0	
CNMM 160612E-OR			●	●				●		1,2	0,35	0,90	3,0	10,0	
CNMM 160616E-OR			●	●						1,6	0,36	1,00	3,0	10,0	
CNMM 190612E-OR			●	●	●	●		●		1,2	0,35	0,90	3,0	10,0	
CNMM 190616E-OR			●	●	●	●		●	●	1,6	0,37	1,20	3,0	10,0	
CNMM 190624E-OR			●	●						2,4	0,38	1,25	3,0	12,0	
CNMM 250924E-OR			●	●	●	●		●	●	2,4	0,45	1,70	4,0	16,0	

● New item in the assortment

● Stock assortment ○ Non-stock assortment All dimensions [mm]
See latest price list for current availability

INDEXABLE CUTTING INSERTS FOR TURNING

MILLING TOOLS
MILLING INSERTS
TURNING INSERTS
DRILLING INSERTS
TECHNICAL SECTION

Chip-breaker	ISO	Grade								Radius		Feed/rev.		Depth of cut	
		T7335	T9315	T9325	T9335	6630	6640	T8330	T8345	r_c	f_{min}	f_{max}	$a_{p min}$	$a_{p max}$	
	CNMM 190616E-OR1			●	●	●					1,6	0,30	1,20	3,0	11,0
	CNMM 250924S-923		●		●		●	●			2,4	0,45	1,50	3,0	16,0

● New item in the assortment ○ Stock assortment ○ Non-stock assortment All dimensions [mm]
See latest price list for current availability

INDEXABLE CUTTING INSERTS FOR TURNING

DCGT

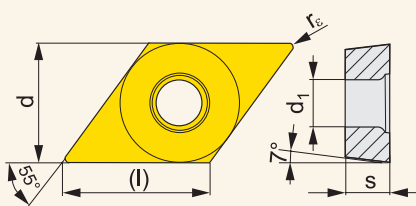

Dimensions	(l)	d	d ₁	s		
0702	7,8	6,350	2,80	2,38		
11T3	11,6	9,525	4,40	3,97		

Chip-breaker	ISO	Grade						Radius		Feed/rev.		Depth of cut	
		T0315	T8330	HF7				r _c	f _{min}	f _{max}	a _{p min}	a _{p max}	
	DCGT 070202F-AL	●		●				0,2	0,06	0,12	0,3	2,1	
	DCGT 070204F-AL	●		●				0,4	0,10	0,24	0,4	2,1	
	DCGT 11T302F-AL	●		●				0,2	0,06	0,12	0,3	3,3	
	DCGT 11T304F-AL	●		●				0,4	0,10	0,24	0,4	3,3	
	DCGT 11T308F-AL	●		●				0,8	0,15	0,48	0,8	3,3	
	DCGT 11T304ER-SI		●					0,4	0,08	0,24	0,4	2,5	
	DCGT 11T308ER-SI		●					0,8	0,15	0,30	0,8	2,5	
	DCGT 11T304EL-SI		●					0,4	0,08	0,24	0,4	2,5	
	DCGT 11T308EL-SI		●					0,8	0,15	0,30	0,8	2,5	

● New item in the assortment ● Stock assortment ○ Non-stock assortment All dimensions [mm]
See latest price list for current availability

MILLING TOOLS

MILLING INSERTS

TURNING INSERTS

DRILLING INSERTS

TECHNICAL SECTION

INDEXABLE CUTTING INSERTS FOR TURNING

DCMT

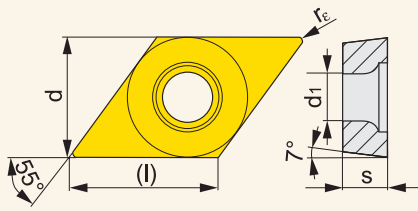

Dimensions	l	d	d ₁	s		
0702	7,8	6,350	2,90	2,38		
11T3	11,6	9,525	4,50	3,97		
1504	15,5	12,700	5,60	4,76		

Chip-breaker	ISO	Grade								Radius		Feed/rev.		Depth of cut	
		T5305	T5315	T7335	T9315	T9325	6630	T8315	T8330	TT310	r _c	f _{min}	f _{max}	a _{p min}	a _{p max}
	DCMT 11T302E-FF							●	●		0,2	0,05	0,12	0,2	2,0
	DCMT 11T304E-FF							●	●		0,4	0,05	0,23	0,4	2,0
	DCMT 11T308E-FF							●	●		0,8	0,05	0,23	0,8	2,0
	DCMT 070202E-FM				●	●		●	●		0,2	0,05	0,12	0,2	1,0
	DCMT 070204E-FM			●	●	●		●	●		0,4	0,08	0,24	0,4	2,0
	DCMT 11T302E-FM				●	●		●	●		0,2	0,08	0,12	0,2	2,0
	DCMT 11T304E-FM			●	●	●		●	●		0,4	0,10	0,24	0,4	3,0
	DCMT 11T308E-FM			●	●	●		●	●		0,8	0,10	0,30	0,8	3,0
	DCMT 11T312E-FM				●	●			●		1,2	0,20	0,40	1,2	3,3
	DCMT 11T304E-RF		●	●			●				0,4	0,10	0,24	0,8	3,3
	DCMT 11T308E-RF		●	●			●				0,8	0,10	0,40	0,8	3,3
	DCMT 11T304E-RM	●	●	●	●	●			●		0,4	0,15	0,24	1,0	3,3
	DCMT 11T308E-RM	●	●	●	●	●			●		0,8	0,15	0,40	1,0	3,3
	DCMT 11T312E-RM			●	●	●			●		1,2	0,15	0,45	1,5	3,3
	DCMT 150408E-RM				●	●			●		0,8	0,20	0,48	1,0	4,5
	DCMT 070202E-UR				●	●		●	●		0,2	0,05	0,12	0,2	1,0
	DCMT 070204E-UR				●	●		●	●	●	0,4	0,05	0,24	0,4	2,1
	DCMT 11T302E-UR				●	●			●	●	0,2	0,05	0,12	0,2	2,0
	DCMT 11T304E-UR		●	●	●	●			●	●	0,4	0,08	0,24	0,4	2,5
	DCMT 11T308E-UR		●	●	●	●			●	●	0,8	0,08	0,48	0,8	3,0
	DCMT 11T312E-UR				●	●					1,2	0,15	0,30	1,2	3,0

● New item in the assortment

● Stock assortment ○ Non-stock assortment All dimensions [mm]
See latest price list for current availability

INDEXABLE CUTTING INSERTS FOR TURNING

DCMW

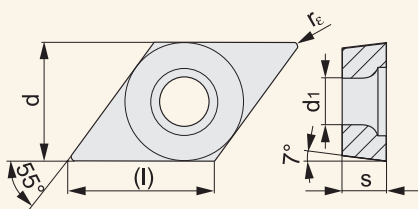

Dimensions	(l)	d	d ₁	s		
0702	7,8	6,350	2,80	2,38		
11T3	11,6	9,525	4,40	3,97		

Chip-breaker	ISO	Grade			Radius	Feed/rev.		Depth of cut	
		T5305	T5315		r _e	f _{min}	f _{max}	a _{p min}	a _{p max}
	DCMW 070202	●	●		0,2	0,05	0,35	0,2	2,9
	DCMW 070204	●	●		0,4	0,05	0,20	0,4	2,0
	DCMW 11T304	●	●		0,4	0,05	0,35	0,4	2,9
	DCMW 11T308	●	●		0,8	0,05	0,35	0,8	2,9

DNMA

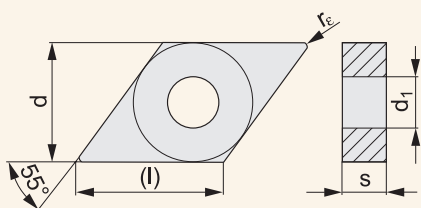

Dimensions	(l)	d	d ₁	s		
1504	15,5	12,700	5,16	4,76		
1506	15,5	12,700	5,16	6,35		

Chip-breaker	ISO	Grade			Radius	Feed/rev.		Depth of cut	
		T5305	T5315	T6310	r _e	f _{min}	f _{max}	a _{p min}	a _{p max}
	DNMA 150404	●	●		0,4	0,10	0,24	0,4	3,9
	DNMA 150408	●	●		0,8	0,10	0,48	0,8	3,9
	DNMA 150604	●	●	●	0,4	0,05	0,24	0,4	3,9
	DNMA 150608	●	●	●	0,8	0,05	0,48	0,8	3,9
	DNMA 150612	●	●		1,2	0,10	0,72	1,2	3,9

● New item in the assortment

● Stock assortment ○ Non-stock assortment All dimensions [mm]
See latest price list for current availability

INDEXABLE CUTTING INSERTS FOR TURNING

DNMG

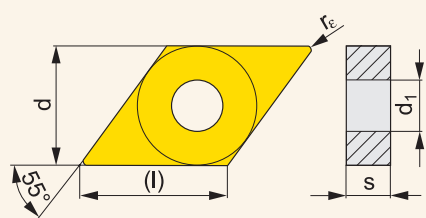









Dimensions	l	d	d ₁	s
1104	11,6	9,525	3,81	4,76
1504	15,5	12,700	5,16	4,76
1506	15,5	12,700	5,16	6,35

Chip-breaker	ISO	Grade											Radius		Feed/rev.		Depth of cut			
		T5305	T5315	T7335	T9310	T9315	T9325	T9335	6630	T6310	T8315	T8330	H07	HF7	TT310	r _c	f _{min}	f _{max}	a _{p min}	a _{p max}
	DNMG 110402E-FF															0,2	0,06	0,12	0,2	1,5
	DNMG 110404E-FF															0,4	0,06	0,20	0,4	1,5
	DNMG 110408E-FF															0,8	0,08	0,25	0,8	1,5
	DNMG 150404E-FF															0,4	0,06	0,20	0,4	1,5
	DNMG 150604E-FF															0,4	0,06	0,20	0,4	1,5
	DNMG 150608E-FF															0,8	0,08	0,25	0,8	1,5
	DNMG 110404E-FM				●	●	●					●	●		0,4	0,10	0,24	0,4	3,0	
	DNMG 110408E-FM				●	●	●					●	●		0,8	0,10	0,35	0,4	3,0	
	DNMG 150404E-FM					●	●					●			0,4	0,10	0,24	0,5	3,0	
	DNMG 150408E-FM					●	●					●			0,8	0,15	0,45	0,8	3,0	
	DNMG 150604E-FM			●	●	●	●					●	●		●	0,4	0,10	0,24	0,5	3,0
	DNMG 150608E-FM			●	●	●	●					●	●		●	0,8	0,15	0,45	0,8	3,0
	DNMG 150612E-FM					●	●					●			1,2	0,15	0,45	1,2	3,0	
	DNMG 150616E-FM					●	●								1,6	0,15	0,45	1,6	3,0	
	DNMG 110404E-M		●		●	●	●								0,4	0,12	0,24	0,5	3,0	
	DNMG 110408E-M		●		●	●	●								0,8	0,15	0,48	0,8	3,3	
	DNMG 110412E-M				●	●	●								1,2	0,17	0,72	1,2	3,3	
	DNMG 150404E-M				●	●	●								0,4	0,12	0,24	0,5	3,0	
	DNMG 150408E-M				●	●	●								0,8	0,15	0,48	0,8	4,5	
	DNMG 150412E-M				●	●	●								1,2	0,17	0,72	1,2	4,5	
	DNMG 150604E-M		●		●	●	●								0,4	0,12	0,24	0,5	3,0	
	DNMG 150608E-M		●		●	●	●	●	●						0,8	0,15	0,48	0,8	4,5	
	DNMG 150612E-M		●		●	●	●	●							1,2	0,17	0,72	1,2	4,5	
	DNMG 110404E-NF			●	●	●					●	●			0,4	0,10	0,24	0,4	3,0	
	DNMG 110408E-NF			●	●	●					●	●			0,8	0,13	0,30	0,8	3,0	
	DNMG 150404E-NF			●	●	●					●	●			0,4	0,13	0,24	0,4	3,0	
	DNMG 150408E-NF			●	●	●					●	●			0,8	0,15	0,30	0,8	3,0	
	DNMG 150604E-NF		●		●	●	●				●	●	●		0,4	0,13	0,24	0,4	3,0	
	DNMG 150608E-NF		●		●	●	●				●	●	●		0,8	0,15	0,30	0,8	3,0	
	DNMG 150612E-NF				●	●					●	●			1,2	0,15	0,35	1,2	3,5	

● New item in the assortment

● Stock assortment ○ Non-stock assortment All dimensions [mm]
See latest price list for current availability

INDEXABLE CUTTING INSERTS FOR TURNING

Chip-breaker	ISO	Grade											Radius		Feed/rev.		Depth of cut				
		T5305	T5315	T7335	T9310	T9315	T9325	T9335	6630	T6310	T8315	T8330	H07	HF7	TT310	r_c	f_{min}	f_{max}	$a_{p min}$	$a_{p max}$	
	DNMG 110404E-NM			●			●				●	●					0,4	0,15	0,24	0,5	3,0
	DNMG 110408E-NM			●			●				●	●					0,8	0,20	0,40	0,8	3,0
	DNMG 150604E-NM			●		●	●				●	●					0,4	0,15	0,24	0,5	3,0
	DNMG 150608E-NM			●		●	●				●	●					0,8	0,20	0,40	0,8	3,0
	DNMG 150612E-NM			●			●					●					1,2	0,20	0,40	1,2	3,5
	DNMG 150608E-R	●	●		●	●	●		●							0,8	0,25	0,48	2,0	4,5	
	DNMG 150612E-R	●	●		●	●	●		●							1,2	0,25	0,70	2,0	4,5	
	DNMG 150616E-R								●							1,6	0,30	0,80	2,0	4,5	
	DNMG 110408E-RM			●		●	●	●								0,8	0,20	0,48	1,0	3,3	
	DNMG 110412E-RM						●	●	●							1,2	0,25	0,60	1,5	3,3	
	DNMG 150412E-RM						●	●	●							1,2	0,25	0,70	1,5	4,5	
	DNMG 150608E-RM	●	●	●	●	●	●	●			●	●				0,8	0,20	0,48	1,0	4,5	
	DNMG 150612E-RM	●	●	●	●	●	●	●				●				1,2	0,25	0,70	1,5	4,5	
	DNMG 150616E-RM		●	●		●	●	●								1,6	0,30	0,75	2,0	4,5	
	DNMG 110404E-SF			●						●	●	●				0,4	0,10	0,24	0,4	2,0	
	DNMG 110408E-SF			●						●	●	●				0,8	0,12	0,27	0,8	2,5	
	DNMG 150404E-SF									●	●	●				0,4	0,10	0,24	0,4	2,5	
	DNMG 150408E-SF									●	●	●				0,8	0,12	0,30	0,8	3,0	
	DNMG 150604E-SF			●						●	●	●	●			0,4	0,10	0,24	0,4	2,5	
	DNMG 150608E-SF			●						●	●	●	●			0,8	0,12	0,30	0,8	3,0	
	DNMG 150612E-SF									●	●					1,2	0,15	0,30	1,2	3,0	
	DNMG 110404E-SM			●			●			●	●					0,4	0,15	0,24	0,4	3,0	
	DNMG 110408E-SM			●			●	●		●	●					0,8	0,18	0,35	0,8	3,3	
	DNMG 150604E-SM			●			●	●		●	●					0,4	0,18	0,24	0,4	3,5	
	DNMG 150608E-SM			●			●	●		●	●					0,8	0,20	0,40	0,8	4,0	
	DNMG 150612E-SM			●			●	●		●	●					1,2	0,22	0,40	1,2	4,0	
	DNMG 110404EL-SI			●			●				●					0,4	0,20	0,24	0,8	3,3	
	DNMG 110408EL-SI			●			●				●					0,8	0,20	0,48	0,8	3,3	
	DNMG 150408EL-SI			●			●				●					0,8	0,20	0,48	0,8	4,5	
	DNMG 150604EL-SI			●			●		●		●					0,4	0,20	0,24	0,8	4,5	
	DNMG 150608EL-SI			●			●		●		●					0,8	0,20	0,48	0,8	4,5	
	DNMG 110404ER-SI			●			●				●					0,4	0,20	0,24	0,8	3,3	
	DNMG 110408ER-SI			●			●				●					0,8	0,20	0,48	0,8	3,3	
	DNMG 150408ER-SI			●			●				●					0,8	0,20	0,48	0,8	4,5	
	DNMG 150604ER-SI			●			●		●		●					0,4	0,20	0,24	0,8	4,5	
	DNMG 150608ER-SI			●			●		●		●					0,8	0,20	0,48	0,8	4,5	
	DNMG 150608W-MR					●	●									0,8	0,36	0,55	0,8	4,0	
	DNMG 150612W-MR					●	●									1,2	0,39	0,60	1,2	4,0	

● New item in the assortment

● Stock assortment ○ Non-stock assortment All dimensions [mm]
See latest price list for current availability

INDEXABLE CUTTING INSERTS FOR TURNING

ECMT

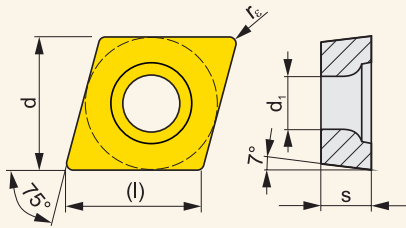

Dimensions	l	d	d ₁	s
0602	6,5	6,350	2,80	2,38
0803	8,2	7,940	3,40	3,18

MILLING TOOLS

MILLING INSERTS

TURNING INSERTS

DRILLING INSERTS

TECHNICAL SECTION

Chip-breaker	ISO	Grade				Radius	Feed/rev.		Depth of cut	
		T5315	T9315	T9325	T9335		r _c	f _{min}	f _{max}	a _{p min}
	ECMT 060204E-FM2		●	●	●	0,4	0,15	0,25	0,4	2,7
	ECMT 080304E-FM2	●	●	●	●	0,4	0,10	0,25	0,4	2,7
	ECMT 080308E-FM2		●	●	●	0,8	0,15	0,40	0,8	4,0

EPMT

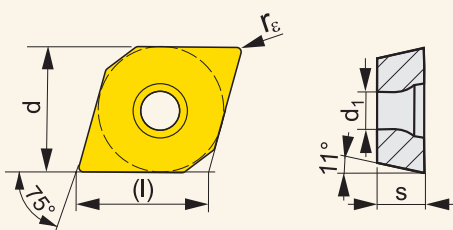

Dimensions	l	d	d ₁	s
0502	5,7	5,560	2,50	2,38

Chip-breaker	ISO	Grade				Radius	Feed/rev.		Depth of cut	
		T7335	T9315	T9325	TT010		r _c	f _{min}	f _{max}	a _{p min}
	EPMT 050202E-NF2	●	●	●	●	0,2	0,05	0,15	1,0	2,5

● New item in the assortment

● Stock assortment ○ Non-stock assortment All dimensions [mm]
See latest price list for current availability

INDEXABLE CUTTING INSERTS FOR TURNING

LCMF 13

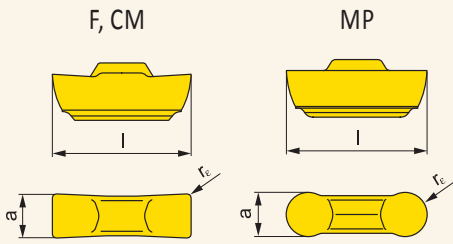

Dimensions	a	tol. a	l		
0313	3,0	±0,05	12,60		
0413	4,0	±0,05	12,60		

Chip-breaker	ISO	Grade						Radius		Feed/rev.		Depth of cut	
		T9325	T8330					r _c	f _{min}	f _{max}	a _{p min}	a _{p max}	
	LCMF 031304-CM	●						0,4	0,05	0,30	-	-	
	LCMF 031304-CM-04*	●						0,4	0,05	0,30	-	-	
	LCMF 041304-CM	●						0,4	0,05	0,30	-	-	
	LCMF 031302-F	●						0,2	0,05	0,20	0,3	3,0	
	LCMF 031302-F-04*	●						0,2	0,05	0,20	0,3	2,0	
	LCMF 031304-F	●						0,4	0,05	0,25	0,3	3,0	
	LCMF 031304-F-04*	●						0,4	0,05	0,20	0,3	2,0	
	LCMF 041304-F	●	●					0,4	0,05	0,25	0,5	3,0	
	LCMF 0313MO-MP	●						1,5	0,05	0,30	0,5	1,5	
	LCMF 0313MO-MP-04*	●						1,5	0,05	0,30	0,5	1,5	
	LCMF 0413MO-MP	●						2,0	0,05	0,35	0,5	2,0	

* Inserts are designed for the following shanks:
A16Q-GGER/L 0313-04
A20R-GGFR/L 0313-04

● New item in the assortment

● Stock assortment ○ Non-stock assortment All dimensions [mm]
See latest price list for current availability

INDEXABLE CUTTING INSERTS FOR TURNING

RCMT

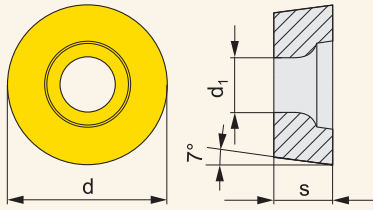

Dimensions	d	d ₁	s			
0602	6,0	2,800	2,38			
0803	8,0	3,400	3,18			
10T3	10,0	4,400	3,97			
1204	12,0	4,400	4,76			
1606	16,0	5,500	6,35			
2006	20,0	6,500	6,35			
2507	25,0	8,600	7,94			
3009	30,0	10,000	9,52			

Chip-breaker	ISO	Grade				Radius r _c	Feed/rev.		Depth of cut	
		T9310	T9315	T9325	T8330		f _{min}	f _{max}	a _{p min}	a _{p max}
	RCMT 1606MOS-37		●	●			0,20	0,90	1,0	4,0
	RCMT 2006MOS-371		●	●			0,20	1,20	1,0	5,0
	RCMT 2507MOS-372			●			0,20	1,20	1,0	6,0
	RCMT 0602MOE-FM		●	●	●		0,10	0,60	0,3	2,4
	RCMT 0803MOE-FM		●	●	●		0,15	0,80	0,5	3,0
	RCMT 10T3MOE-FM		●	●	●		0,30	1,00	0,7	4,0
	RCMT 1204MOE-FM		●	●	●		0,30	1,00	0,7	4,8
	RCMT 0602MOE-UR		●	●	●		0,10	0,40	0,1	1,5
	RCMT 0803MOE-UR		●	●	●		0,13	1,00	0,2	3,0
	RCMT 10T3MOE-UR		●	●	●		0,15	1,00	0,2	4,0
	RCMT 1204MOE-UR		●	●	●		0,17	1,00	0,2	5,0
	RCMT 3009MO-RR4	○	○				0,80	1,50	4,0	8,0

● New item in the assortment

● Stock assortment ○ Non-stock assortment All dimensions [mm]
See latest price list for current availability

INDEXABLE CUTTING INSERTS FOR TURNING

RCMW

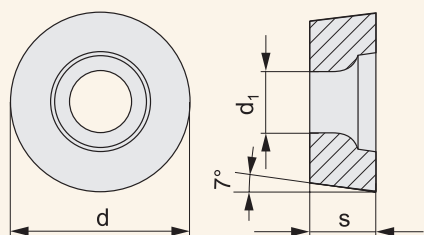

Dimensions	d	d ₁	s		
0602	6,0	2,800	2,38		
0803	8,0	3,400	3,18		
10T3	10,0	4,400	3,97		
1204	12,0	4,400	4,76		

Chip-breaker	ISO	Grade				Radius	Feed/rev.		Depth of cut	
		T5305	T5315			r _c	f _{min}	f _{max}	a _{p min}	a _{p max}
	RCMW 0602MO	●	●				0,05	0,20	0,5	1,5
	RCMW 0803MO	●	●				0,05	0,30	0,5	2,0
	RCMW 10T3MO	●	●				0,10	0,35	0,5	2,5
	RCMW 1204MO	●	●				0,05	0,40	0,5	3,0

● New item in the assortment ● Stock assortment ○ Non-stock assortment All dimensions [mm]
See latest price list for current availability

INDEXABLE CUTTING INSERTS FOR TURNING

RCMX

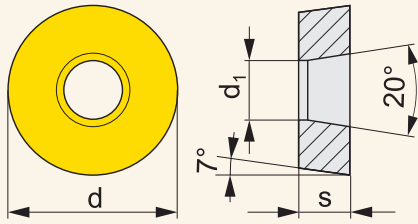

Dimensions	d	d ₁	s			
1003	10,0	3,600	3,18			
1204	12,0	4,200	4,76			
1606	16,0	5,200	6,35			
2006	20,0	6,500	6,35			
2507	25,0	7,200	7,94			
3209	32,0	9,500	9,52			

Chip-breaker	ISO	Grade								Radius		Feed/rev.		Depth of cut	
		T5305	T5315	T9310	T9315	T9325	T9335	6630	6640	T8345	r _c	f _{min}	f _{max}	a _{p min}	a _{p max}
	RCMX 1003MOS-31					●	●					0,40	1,00	1,5	2,5
	RCMX 1204MOS-321				●	●	●					0,40	1,00	1,0	3,0
	RCMX 1606MOS-331				●	●	●	●				0,40	1,20	1,0	4,0
	RCMX 2006MOS-341							●	●			0,60	1,20	2,0	5,0
	RCMX 2507MOS-351							●	●			0,80	1,20	3,0	7,0
	RCMX 3209MOS-361								●			0,80	1,50	3,0	8,0
	RCMX 1606MOS-37				●	●						0,20	0,90	1,0	4,0
	RCMX 2006MOS-37							●				0,20	0,90	1,5	5,0
	RCMX 2507MOS-37							●				0,60	0,90	2,0	7,0
	RCMX 2006MO-RF1	●		●	●	●	●					0,45	1,20	1,0	5,0
	RCMX 2507MO-RF1			●	●	●	●		●			0,60	1,20	1,5	7,0
	RCMX 2006MO-RM1			●	●	●	●					0,20	1,30	1,5	5,0
	RCMX 2507MO-RM1			●	●	●	●					0,60	1,20	2,0	7,0
	RCMX 2507MO-RM2			●	●	●						0,80	1,50	2,0	7,0
	RCMX 3209MO-RM2		●	●	●	●						0,80	1,50	2,0	8,0
	RCMX 3209MO-RR2			●	●	●						0,80	1,50	2,5	8,0

● New item in the assortment

● Stock assortment ○ Non-stock assortment All dimensions [mm]
See latest price list for current availability

INDEXABLE CUTTING INSERTS FOR TURNING

SCMT

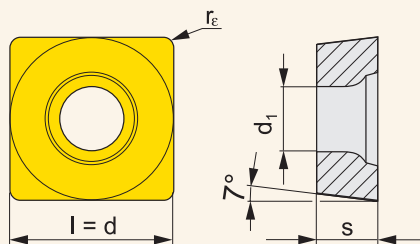

Dimensions	l	d	d ₁	s
09T3	9,5	9,525	4,50	3,97
1204	12,7	12,700	5,60	4,76
2509	25,4	25,400	8,70	9,52
3809	38,1	38,100	8,70	9,52

Chip-breaker	ISO	Grade										Radius		Feed/rev.		Depth of cut	
		T5305	T5315	T7335	T9315	T9325	T9335	6630	6635	T8315	T8330	TT310	r _c	f _{min}	f _{max}	a _{p min}	a _{p max}
	SCMT 09T304E-FM			●	●	●			●	●			0,4	0,10	0,30	0,4	3,0
	SCMT 09T308E-FM			●	●	●			●	●			0,8	0,15	0,35	0,8	3,0
	SCMT 120404E-FM				●	●			●	●			0,4	0,10	0,30	0,4	4,0
	SCMT 120408E-FM			●	●	●			●	●			0,8	0,15	0,35	0,8	4,0
	SCMT 120412E-FM				●	●				●			1,2	0,15	0,45	1,2	4,0
	SCMT 09T308E-RF		●	●			●						0,8	0,10	0,40	0,8	4,0
	SCMT 120408E-RF		●	●			●						0,8	0,20	0,68	1,0	8,0
	SCMT 09T308E-RM	●	●	●	●	●				●			0,8	0,20	0,40	1,5	4,0
	SCMT 120408E-RM	●	●	●	●	●				●			0,8	0,20	0,40	1,5	4,5
	SCMT 09T304E-UR				●	●				●			0,4	0,08	0,34	0,4	3,0
	SCMT 09T308E-UR		●		●	●				●	●		0,8	0,08	0,50	0,8	3,0
	SCMT 120408E-UR		●		●	●				●			0,8	0,08	0,50	0,8	4,0
	SCMT 120412E-UR					●				●			1,2	0,08	0,50	1,2	4,0
	SCMT 380932E-DR4						●						3,2	0,70	1,40	4,0	18,0
	SCMT 250924E-OR				●	●	●						2,4	0,60	1,80	3,0	16,0
	SCMT 380932E-OR				●	●	●	●					3,2	1,00	2,00	4,0	24,0
	SCMT 250924E-SR				●	●							2,4	0,60	1,80	3,0	16,0
	SCMT 380932E-SR					●							3,2	1,20	2,00	4,0	24,0

● New item in the assortment

● Stock assortment ○ Non-stock assortment All dimensions [mm]
See latest price list for current availability

INDEXABLE CUTTING INSERTS FOR TURNING

SCMW

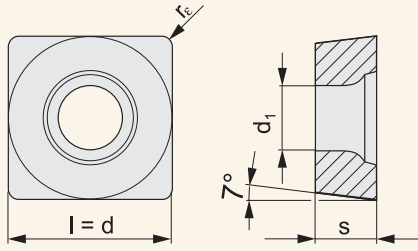

Dimensions	l	d	d ₁	s
09T3	9,5	9,525	4,40	3,97
1204	12,7	12,700	5,50	4,76

Chip-breaker	ISO	Grade		Radius			Feed/rev.		Depth of cut	
		T5305	T5315	r _e	f _{min}	f _{max}	a _{p min}	a _{p max}		
		●	●							
	SCMW 09T304	●	●	0,4	0,05	0,34	0,4	4,5		
	SCMW 09T308	●	●	0,8	0,05	0,35	0,8	4,5		
	SCMW 120408	●	●	0,8	0,05	0,40	0,8	6,0		

● New item in the assortment ● Stock assortment ○ Non-stock assortment All dimensions [mm]
See latest price list for current availability

INDEXABLE CUTTING INSERTS FOR TURNING

SNMA

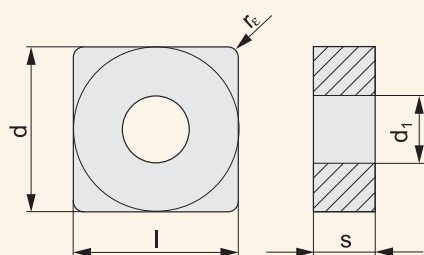

Dimensions	(l)	d	d ₁	s		
1204	12,7	12,700	5,16	4,76		
1506	15,9	15,875	6,35	6,35		
1906	19,1	19,050	7,94	6,35		
2507	25,4	25,400	9,12	7,94		
2509	25,4	25,400	9,12	9,52		

Chip-breaker	ISO	Grade			Radius	Feed/rev.		Depth of cut		
		T5305	T5315	T6310	r _c	f _{min}	f _{max}	a _{p min}	a _{p max}	
	SNMA 120408	●	●	●	0,8	0,05	0,60	0,8	6,0	
	SNMA 120412	●	●		1,2	0,10	0,60	1,2	6,0	
	SNMA 150612	●	●		1,2	0,10	0,90	1,2	7,1	
	SNMA 190612	●	●		1,2	0,10	0,90	1,2	8,9	
	SNMA 190616	●	●		1,6	0,10	0,90	1,6	8,9	
	SNMA 250724	●	●		2,4	0,10	1,10	2,4	12,0	
	SNMA 250924	●	●		2,4	0,10	1,10	2,4	12,0	
	SNMA 120412S	●			1,2	0,10	0,60	1,2	6,0	
	SNMA 190616S	●			1,6	0,10	0,90	1,2	8,9	
	SNMA 250724S	●			2,4	0,10	1,10	2,4	12,0	
	SNMA 250924S	●			2,4	0,10	1,10	2,4	12,0	

● New item in the assortment ● Stock assortment ○ Non-stock assortment All dimensions [mm]
See latest price list for current availability

INDEXABLE CUTTING INSERTS FOR TURNING

SNMG

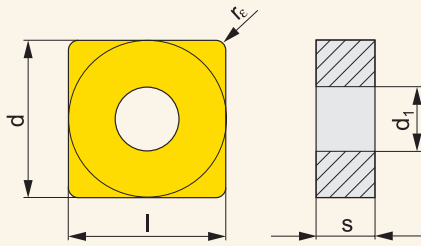



Dimensions	l	d	d ₁	s
1204	12,7	12,700	5,16	4,76
1506	15,9	15,875	6,35	6,35
1906	19,1	19,050	7,94	6,35
2509	25,4	25,400	9,12	9,52

Chip-breaker	ISO	Grade											Radius	Feed/rev.		Depth of cut					
		T5305	T5315	T7335	T9310	T9315	T9325	T9335	6630	6640	T6310	T8315	T8330	H07	HF7	TT310	r _c	f _{min}	f _{max}	a _{p min}	a _{p max}
	SNMG 120404E-FM					●	●						●	●			0,4	0,10	0,30	0,5	3,0
	SNMG 120408E-FM				●	●	●						●	●		●	0,8	0,15	0,45	0,8	3,0
	SNMG 120412E-FM					●	●						●			1,2	0,15	0,45	1,2	3,0	
	SNMG 120416E-FM					●	●						●			1,6	0,15	0,45	1,6	8,4	
	SNMG 120408E-KR	●	●													0,8	0,20	0,50	0,8	7,0	
	SNMG 120412E-KR	●	●													1,2	0,25	0,70	1,2	7,0	
	SNMG 120404E-NF			●		●	●					●	●			0,4	0,13	0,30	0,4	3,0	
	SNMG 120408E-NF			●		●	●					●	●	●		0,8	0,15	0,35	0,8	3,5	
	SNMG 120408E-NM			●			●					●	●			0,8	0,20	0,50	0,8	3,0	
	SNMG 120412E-NM			●			●					●				1,2	0,20	0,50	1,2	3,5	
	SNMG 120408E-M	●	●		●	●	●	●	●							0,8	0,15	0,60	0,8	6,0	
	SNMG 120412E-M					●	●	●								1,2	0,15	0,80	1,2	8,0	
	SNMG 120416E-M					●	●	●								1,6	0,17	0,80	1,6	8,0	
	SNMG 150612E-M					●	●	●	●							1,2	0,17	0,80	1,2	8,0	
	SNMG 190612E-M					●	●	●	●							1,2	0,17	0,80	1,2	8,0	
	SNMG 190616E-M					●	●	●								1,6	0,17	0,80	1,6	8,0	
	SNMG 120408E-R	●			●	●	●	●	●							0,8	0,25	0,60	2,0	6,0	
	SNMG 120412E-R	●			●		●	●	●							1,2	0,25	0,70	2,0	6,0	
	SNMG 120416E-R				●	●	●									1,6	0,30	0,80	2,0	6,0	
	SNMG 150612E-R	●	●		●	●	●									1,2	0,25	0,70	2,0	7,0	
	SNMG 150616E-R		●		●	●	●									1,6	0,25	0,80	2,0	7,0	
	SNMG 190612E-R				●	●	●		●	●						1,2	0,25	0,70	2,0	9,0	
	SNMG 190616E-R				●	●	●	●		●						1,6	0,30	0,80	2,0	9,0	
	SNMG 120408E-RM	●	●	●	●	●	●				●	●	●			0,8	0,20	0,50	1,0	7,0	
	SNMG 120412E-RM	●	●	●	●	●	●				●					1,2	0,25	0,70	1,5	7,0	
	SNMG 120416E-RM	●	●	●	●	●	●					●				1,6	0,30	0,75	2,0	7,0	
	SNMG 150612E-RM	●	●	●	●	●	●				●					1,2	0,25	0,70	1,5	8,0	
	SNMG 150616E-RM	●	●	●		●	●	●				●				1,6	0,30	0,80	2,0	8,0	

● New item in the assortment

● Stock assortment ○ Non-stock assortment All dimensions [mm]
See latest price list for current availability

INDEXABLE CUTTING INSERTS FOR TURNING

Chip-breaker	ISO	Grade											Radius		Feed/rev.		Depth of cut			
		T5305	T5315	T7335	T9310	T9315	T9325	T9335	6630	6640	T6310	T8315	T8330	H07	HF7	TT310	r _c	f _{min}	f _{max}	a _{p min}
	SNMG 190612E-RM	●	●	●	●	●	●									1,2	0,25	0,70	1,5	10,0
	SNMG 190616E-RM	●	●	●	●	●	●			●						1,6	0,30	0,80	2,0	10,0
	SNMG 250924E-RM			●		●	●	●								2,4	0,40	1,20	2,4	15,0
	SNMG 120408E-SF			●						●	●	●	●		0,8	0,12	0,30	0,8	3,0	
	SNMG 120412E-SF									●	●	●			1,2	0,15	0,35	1,2	3,5	
	SNMG 120408E-SM			●		●	●			●		●			0,8	0,20	0,45	0,8	4,5	
	SNMG 120412E-SM			●		●	●								1,2	0,22	0,50	1,2	5,0	
	SNMG 190612E-SM			●			●			●					1,2	0,25	0,55	1,2	5,5	
	SNMG 190616E-SM			●			●								1,6	0,30	0,55	1,6	6,0	

● New item in the assortment

● Stock assortment ○ Non-stock assortment All dimensions [mm]
See latest price list for current availability

MILLING TOOLS

MILLING INSERTS

TURNING INSERTS

DRILLING INSERTS

TECHNICAL SECTION

INDEXABLE CUTTING INSERTS FOR TURNING

SNMM

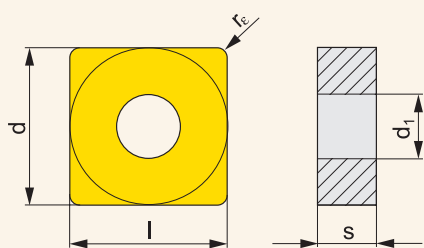





Dimensions	l	d	d ₁	s		
1204	12,7	12,700	5,16	4,76		
1506	15,9	15,875	6,35	6,35		
1906	19,1	19,050	7,94	6,35		
2507	25,4	25,400	9,12	7,94		
2509	25,4	25,400	9,12	9,52		

Chip-breaker	ISO	Grade								Radius	Feed/rev.		Depth of cut	
		T7335	T9315	T9325	T9335	6630	6640	T8330	T8345	r _c	f _{min}	f _{max}	a _{p min}	a _{p max}
	SNMM 120412E-DR		●	●	●					1,2	0,30	0,85	2,5	8,4
	SNMM 150612E-DR		●	●	●					1,2	0,30	0,85	2,5	9,0
	SNMM 190612E-DR		●	●	●	●				1,2	0,30	0,85	2,5	9,0
	SNMM 190616E-DR		●	●	●					1,6	0,30	0,85	2,5	9,0
	SNMM 190616E-HR			●	●	●			●	1,6	0,50	1,36	5,0	13,3
	SNMM 190624E-HR		●	●	●				●	2,4	0,50	1,40	5,0	13,3
	SNMM 250716E-HR		●	●	●				●	1,6	0,50	1,36	5,0	14,0
	SNMM 250724E-HR		●	●	●	●	●		●	2,4	0,50	1,40	5,0	14,0
	SNMM 250732E-HR			●	●					3,2	0,50	1,40	5,0	14,0
	SNMM 250924E-HR		●	●	●	●			●	2,4	0,50	1,40	5,0	14,0
	SNMM 250932E-HR			●	●					3,2	0,50	1,40	5,0	14,0
	SNMM 120408E-NR		●	●	●				●	0,8	0,25	0,68	1,0	8,4
	SNMM 120408E-NR2		●	●	●				●	0,8	0,30	0,55	0,8	7,0
	SNMM 120412E-NR2		●	●	●				●	1,2	0,32	0,70	1,2	7,5
	SNMM 150612E-NR2		●	●	●				●	1,2	0,30	0,70	1,2	9,0
	SNMM 150616E-NR2		●	●	●					1,6	0,35	0,90	1,6	9,0
	SNMM 190612E-NR2		●	●	●					1,2	0,32	0,70	1,5	12,0
	SNMM 190616E-NR2		●	●	●				●	1,6	0,35	0,90	1,6	12,0
	SNMM 190624E-NR2		●	●	●					2,4	0,40	1,20	2,5	12,0
	SNMM 250724E-NR2		●	●	●				●	2,4	0,50	1,40	3,0	16,0
	SNMM 250924E-NR2		●	●	●					2,4	0,50	1,60	3,0	16,0
		SNMM 120408E-OR		●	●	●					0,8	0,30	0,68	1,5
SNMM 120412E-OR			●	●	●					1,2	0,32	0,70	2,0	6,0
SNMM 120416E-OR			●	●	●					1,6	0,35	0,80	2,0	8,0
SNMM 150608E-OR			●	●	●					0,8	0,35	0,60	2,0	8,0
SNMM 150612E-OR			●	●	●					1,2	0,35	1,00	2,0	9,0
SNMM 150616E-OR			●	●	●					1,6	0,35	1,00	2,0	10,0
SNMM 190612E-OR			●	●	●				●	1,2	0,35	1,00	3,0	10,0
SNMM 190616E-OR			●	●	●	●			●	1,6	0,38	1,20	2,0	10,0

● New item in the assortment

● Stock assortment ○ Non-stock assortment All dimensions [mm]
See latest price list for current availability

INDEXABLE CUTTING INSERTS FOR TURNING

Chip-breaker	ISO	Grade								Radius		Feed/rev.		Depth of cut	
		T7335	T9315	T9325	T9335	6630	6640	T8330	T8345	r_c	f_{min}	f_{max}	$a_{p min}$	$a_{p max}$	
	SNMM 190624E-OR	●	●							2,4	0,45	1,20	3,5	12,0	
	SNMM 250716E-OR	●	●	●						1,6	0,45	1,36	4,0	16,0	
	SNMM 250724E-OR	●	●	●	●			●	●	2,4	0,45	1,70	4,0	16,0	
	SNMM 250924E-OR	●	●	●				●		2,4	0,30	1,70	3,0	16,0	
	SNMM 190616E-OR1	●	●	●	●					1,6	0,30	1,00	3,0	11,0	
	SNMM 250724S-SR			●	●		●			2,4	0,70	1,60	5,0	16,0	
	SNMM 250924S-SR			●	●	●				2,4	0,70	1,60	5,0	16,0	
	SNMM 190616S-923				●			●	●	1,6	0,45	1,36	3,0	13,0	
	SNMM 250716S-923				●					1,6	0,45	1,36	3,0	13,0	
	SNMM 250724S-923	●		●				●	●	2,4	0,45	1,50	3,0	16,0	
	SNMM 250924S-923	●		●				●	●	2,4	0,45	1,50	3,0	16,0	

● New item in the assortment

● Stock assortment ○ Non-stock assortment All dimensions [mm]
See latest price list for current availability

MILLING TOOLS

MILLING INSERTS

TURNING INSERTS

DRILLING INSERTS

TECHNICAL SECTION

INDEXABLE CUTTING INSERTS FOR TURNING

TCGT

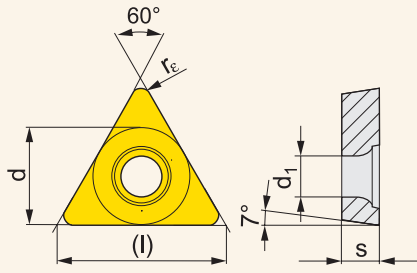

Dimensions	(l)	d	d ₁	s
0902	9,6	5,560	2,50	2,38
1102	11,0	6,350	2,80	2,38
16T3	16,5	9,525	4,40	3,97

MILLING TOOLS

MILLING INSERTS

TURNING INSERTS

DRILLING INSERTS

TECHNICAL SECTION

Chip-breaker	ISO	Grade				Radius	Feed/rev.		Depth of cut	
		T0315	T8315	T8330	HF7	r _c	f _{min}	f _{max}	a _{p min}	a _{p max}
	TCGT 090202F-AL	○			○	0,2	0,06	0,12	0,3	3,0
	TCGT 090204F-AL	○			●	0,4	0,10	0,24	0,4	3,0
	TCGT 110202F-AL	○			●	0,2	0,06	0,12	0,3	3,6
	TCGT 110204F-AL	●			●	0,4	0,10	0,24	0,4	3,6
	TCGT 110208F-AL	○			○	0,8	0,15	0,48	0,8	3,6
	TCGT 16T304F-AL	●			●	0,4	0,10	0,24	0,4	5,3
	TCGT 16T308F-AL	●			●	0,8	0,15	0,48	0,8	5,3
	TCGT 110202ER-SI		●	●		0,2	0,08	0,12	0,4	1,6
	TCGT 110204ER-SI		●	●		0,4	0,08	0,24	0,4	1,6
	TCGT 110202EL-SI		●	●		0,2	0,08	0,12	0,4	1,6
	TCGT 110204EL-SI		●	●		0,4	0,08	0,24	0,4	1,6

● New item in the assortment

● Stock assortment ○ Non-stock assortment All dimensions [mm]
See latest price list for current availability

INDEXABLE CUTTING INSERTS FOR TURNING

TCMT

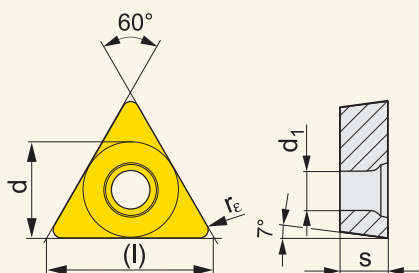

Dimensions	l	d	d ₁	s
06T1	6,9	3,970	2,20	1,98
0902	9,5	5,560	2,50	2,38
1102	11,0	6,350	2,90	2,38
16T3	16,5	9,525	4,50	3,97

Chip-breaker	ISO	Grade								Radius		Feed/rev.		Depth of cut	
		T5305	T5315	T7335	T9315	T9325	6630	T8315	T8330	TT310	r _e	f _{min}	f _{max}	a _{p min}	a _{p max}
	TCMT 06T102E-FF2				●						0,2	0,08	0,12	0,2	1,5
	TCMT 06T104E-FF2				●	●					0,4	0,15	0,23	0,4	2,0
	TCMT 090204E-FF2		●		●	●					0,4	0,10	0,23	0,4	2,5
	TCMT 110202E-FM			●	●	●		●	●		0,2	0,08	0,12	0,2	2,0
	TCMT 110204E-FM			●	●	●		●	●		0,4	0,08	0,24	0,4	2,0
	TCMT 110208E-FM				●	●			●		0,8	0,15	0,30	0,8	2,5
	TCMT 16T304E-FM			●	●	●		●	●		0,4	0,10	0,25	0,4	3,0
	TCMT 16T308E-FM			●	●	●		●	●		0,8	0,10	0,35	0,8	3,0
	TCMT 16T308E-RF						●				0,8	0,15	0,40	1,0	4,0
	TCMT 16T308E-RM	●	●	●	●	●			●		0,8	0,15	0,40	1,0	4,0
	TCMT 16T312E-RM	●	●		●	●			●		1,2	0,15	0,45	1,5	4,0
	TCMT 110204E-UR				●	●			●		0,4	0,08	0,24	0,4	3,0
	TCMT 16T304E-UR				●	●			●	●	0,4	0,08	0,24	0,4	3,0
	TCMT 16T308E-UR		●		●	●			●		0,8	0,08	0,30	0,8	3,0

● New item in the assortment

● Stock assortment ○ Non-stock assortment All dimensions [mm]
See latest price list for current availability

INDEXABLE CUTTING INSERTS FOR TURNING

MILLING TOOLS

MILLING INSERTS

TURNING INSERTS

DRILLING INSERTS

TECHNICAL SECTION

TCMW

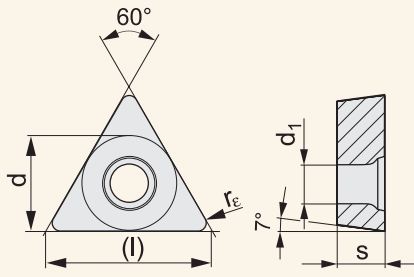

Dimensions	l	d	d ₁	s
1102	11,0	6,350	2,80	2,38
16T3	16,5	9,525	4,40	3,97

Chip-breaker ISO	Grade		Radius r _c	Feed/rev.		Depth of cut	
	T5305	T5315		f _{min}	f _{max}	a _{p min}	a _{p max}
	TCMW 110204	● ●	0,4	0,10	0,20	0,4	3,6
	TCMW 16T304	● ●	0,4	0,05	0,24	0,4	4,8
	TCMW 16T308	● ●	0,8	0,05	0,35	0,8	4,8

● New item in the assortment ● Stock assortment ○ Non-stock assortment All dimensions [mm]
 See latest price list for current availability

INDEXABLE CUTTING INSERTS FOR TURNING

TNMA

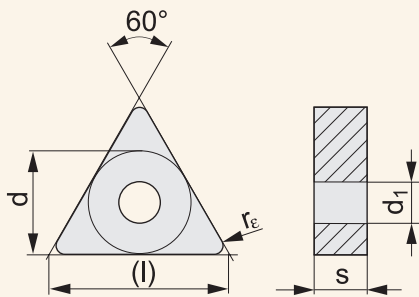

Dimensions	(l)	d	d ₁	s
1604	16,5	9,525	3,81	4,76
2204	22,0	12,700	5,16	4,76

Chip-breaker	ISO	Grade						Radius			Feed/rev.			Depth of cut	
		T5305	T5315	T6310				r _c	f _{min}	f _{max}	a _{p min}	a _{p max}			
	TNMA 160404	●	●					0,4	0,10	0,24	0,4	4,8			
	TNMA 160408	●	●	●				0,8	0,05	0,40	0,8	4,8			
	TNMA 160412	●	●	●				1,2	0,05	0,40	1,2	4,8			
	TNMA 220408	●	●	●				0,8	0,05	0,40	0,8	6,4			
	TNMA 220412	●	●					1,2	0,10	0,40	1,2	6,4			
	TNMA 160408S	●						0,8	0,10	0,40	0,8	4,8			
	TNMA 220412S	●						1,2	0,10	0,40	1,2	6,4			

● New item in the assortment ● Stock assortment ○ Non-stock assortment All dimensions [mm] See latest price list for current availability

INDEXABLE CUTTING INSERTS FOR TURNING

TNMG

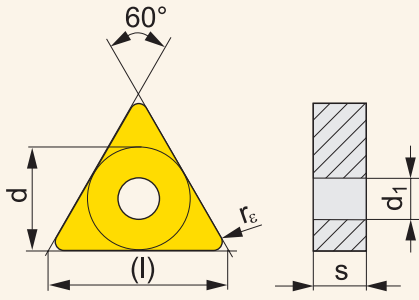

Dimensions	l	d	d ₁	s
1604	16,5	9,525	3,81	4,76
2204	22,0	12,700	5,16	4,76
2706	27,5	15,875	6,35	6,35
3309	33,0	19,050	7,94	9,52

MILLING TOOLS

MILLING INSERTS

TURNING INSERTS

DRILLING INSERTS





TECHNICAL SECTION

Chip-breaker	ISO	Grade											Radius		Feed/rev.		Depth of cut			
		T5305	T5315	T7335	T9310	T9315	T9325	T9335	6630	T6310	T8315	T8330	H07	HF7	TT310	r _c	f _{min}	f _{max}	a _{p min}	a _{p max}
	TNMG 160404E-FF															0,4	0,06	0,20	0,4	1,5
	TNMG 160408E-FF															0,8	0,08	0,25	0,8	1,5
	TNMG 160404E-FM			●	●	●	●					●	●		●	0,4	0,10	0,24	0,5	3,0
	TNMG 160408E-FM			●	●	●	●					●	●		●	0,8	0,15	0,45	0,8	3,0
	TNMG 160412E-FM					●	●					●				1,2	0,15	0,45	1,2	3,0
	TNMG 220404E-FM					●	●					●				0,4	0,15	0,24	0,8	5,0
	TNMG 220408E-FM					●	●					●				0,8	0,15	0,45	0,8	3,0
	TNMG 160408E-KR	●	●													0,8	0,20	0,40	0,8	4,0
	TNMG 160404E-M		●			●	●	●								0,4	0,17	0,24	0,8	3,0
	TNMG 160408E-M	●	●		●	●	●	●	●							0,8	0,15	0,48	0,8	5,3
	TNMG 160412E-M		●			●	●	●								1,2	0,15	0,72	1,2	5,3
	TNMG 220408E-M	●	●		●	●	●	●	●							0,8	0,15	0,48	0,8	6,0
	TNMG 220412E-M	●	●			●	●	●	●							1,2	0,17	0,72	1,2	6,0
	TNMG 160404E-NF			●		●	●		●	●	●		●		0,4	0,13	0,24	0,4	3,0	
	TNMG 160408E-NF			●		●	●		●	●	●		●		0,8	0,15	0,30	0,8	3,0	
	TNMG 160404E-NM			●		●			●	●					0,4	0,15	0,24	0,5	3,0	
	TNMG 160408E-NM			●		●	●		●	●					0,8	0,20	0,40	1,0	3,0	
	TNMG 220408E-NM			●		●	●		●	●					0,8	0,20	0,40	1,0	3,5	
	TNMG 220412E-NM			●		●									1,2	0,20	0,40	1,2	3,5	
	TNMG 160408E-R	●	●		●	●	●				●	●			0,8	0,20	0,48	0,8	5,3	
	TNMG 160412E-R		●		●	●	●				●	●			1,2	0,25	0,70	2,0	5,3	
	TNMG 220408E-R				●	●	●	●							0,8	0,25	0,48	2,0	6,0	
	TNMG 220412E-R				●	●	●								1,2	0,25	0,70	2,0	6,0	
	TNMG 220416E-R				●	●	●								1,6	0,25	0,80	2,0	6,0	

● New item in the assortment

● Stock assortment ○ Non-stock assortment All dimensions [mm]
See latest price list for current availability

INDEXABLE CUTTING INSERTS FOR TURNING

Chip-breaker	ISO	Grade											Radius	Feed/rev.		Depth of cut				
		T5305	T5315	T7335	T9310	T9315	T9325	T9335	6630	T6310	T8315	T8330	H07	HF7	TT310	r _c	f _{min}	f _{max}	a _{p min}	a _{p max}
	TNMG 160408E-RM	●	●	●	●	●	●	●								0,8	0,20	0,48	1,0	5,3
	TNMG 160412E-RM	●	●	●		●	●	●				●				1,2	0,25	0,65	1,5	5,3
	TNMG 220408E-RM	●	●	●	●	●	●	●								0,8	0,20	0,48	1,0	7,0
	TNMG 220412E-RM	●	●	●	●	●	●	●								1,2	0,25	0,65	1,5	7,0
	TNMG 220416E-RM	●	●	●		●	●	●								1,6	0,30	0,75	2,0	7,0
	TNMG 270612E-RM						●									1,2	0,35	0,72	1,2	8,9
	TNMG 270616E-RM					●	●	●								1,6	0,35	0,75	2,0	8,9
	TNMG 270624E-RM						●	●								2,4	0,35	0,80	3,0	8,9
	TNMG 270632E-RM							●								3,2	0,35	0,80	3,2	8,9
	TNMG 330924E-RM							●								2,4	0,45	0,90	3,0	10,9
	TNMG 160404E-SF			●					●	●	●	●			0,4	0,10	0,24	0,4	2,5	
	TNMG 160408E-SF			●					●	●	●	●			0,8	0,12	0,28	0,8	3,0	
	TNMG 220408E-SF								●	●	●				0,8	0,15	0,35	0,8	3,5	
	TNMG 160404E-SM			●		●	●		●	●					0,4	0,18	0,24	0,4	4,0	
	TNMG 160408E-SM			●		●	●		●	●					0,8	0,20	0,40	0,8	4,0	
	TNMG 160412E-SM			●			●								1,2	0,22	0,40	1,2	4,0	
	TNMG 220404E-SM						●		●	●					0,4	0,20	0,24	0,4	4,0	
	TNMG 220408E-SM			●		●	●		●	●					0,8	0,20	0,45	0,8	4,5	
	TNMG 220412E-SM			●		●	●								1,2	0,22	0,50	1,2	5,0	
	TNMG 160404EL-SI			●		●	●	●	●	●					0,4	0,20	0,24	0,8	5,0	
	TNMG 160408EL-SI			●		●	●	●	●	●					0,8	0,20	0,48	0,8	5,0	
	TNMG 160404ER-SI			●		●	●	●	●	●					0,4	0,20	0,24	0,8	5,0	
	TNMG 160408ER-SI			●		●	●	●	●	●					0,8	0,20	0,48	0,8	5,0	

● New item in the assortment

● Stock assortment ○ Non-stock assortment All dimensions [mm]
See latest price list for current availability

MILLING TOOLS

MILLING INSERTS

TURNING INSERTS

DRILLING INSERTS

TECHNICAL SECTION

INDEXABLE CUTTING INSERTS FOR TURNING

TNMM

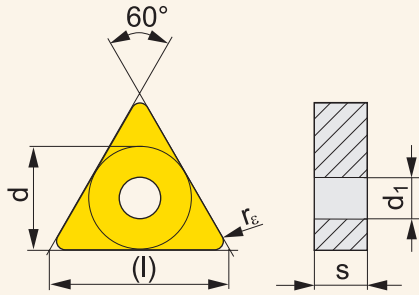

Dimensions	l	d	d ₁	s		
1604	16,5	9,525	3,81	4,76		
2204	22,0	12,700	5,16	4,76		
2706	27,5	15,875	6,35	6,35		

Chip-breaker	ISO	Grade					Radius		Feed/rev.		Depth of cut	
		T9315	T9325	T9335	6640	T8330	r _c	f _{min}	f _{max}	a _{p min}	a _{p max}	
	TNMM 160408E-DR		●				0,8	0,30	0,48	2,5	5,3	
	TNMM 220408E-DR	●	●	●			0,8	0,30	0,48	2,5	7,3	
	TNMM 220412E-DR	●	●	●			1,2	0,30	0,72	2,5	7,3	
	TNMM 220416E-DR		●				1,6	0,30	0,85	2,5	7,3	
	TNMM 270616E-DR		●	●	○		1,6	0,30	0,85	2,5	8,9	
	TNMM 270616E-HR		●	●			1,6	0,50	0,96	5,0	8,9	
	TNMM 270624E-HR		●				2,4	0,50	1,40	5,0	8,9	
	TNMM 160408E-NR2		●				0,8	0,20	0,48	0,8	5,3	
	TNMM 220408E-NR2		●				0,8	0,25	0,48	0,8	7,3	
	TNMM 220412E-NR2		●		●		1,2	0,30	0,70	1,2	7,3	
	TNMM 160408E-OR	●	●				0,8	0,25	0,45	2,0	5,0	
	TNMM 160412E-OR	●	●				1,2	0,30	0,60	2,0	5,3	
	TNMM 220408E-OR	●	●	●			0,8	0,30	0,48	1,0	7,3	
	TNMM 220412E-OR	●	●	●			1,2	0,32	0,70	2,0	7,0	
	TNMM 220416E-OR	●	●				1,6	0,40	0,80	3,0	7,3	
	TNMM 220412ER			●			1,2	0,20	0,50	1,2	5,0	
	TNMM 220412EL			●			1,2	0,20	0,50	1,2	5,0	

● New item in the assortment ● Stock assortment ○ Non-stock assortment All dimensions [mm] See latest price list for current availability

INDEXABLE CUTTING INSERTS FOR TURNING

VBMT

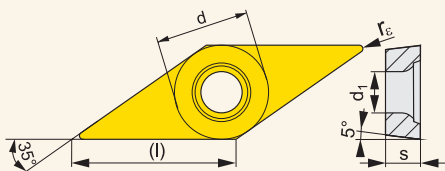

Dimensions	l	d	d ₁	s
1102	11,1	6,350	2,90	2,38
1103	11,1	6,350	2,90	3,18
1604	16,6	9,525	4,50	4,76

Chip-breaker	ISO	Grade								Radius		Feed/rev.		Depth of cut	
		T5305	T5315	T7335	T9310	T9315	T9325	T8315	T8330	TT310	r _c	f _{min}	f _{max}	a _{p min}	a _{p max}
	VBMT 110302E-FM					●	●	●			0,2	0,07	0,10	0,2	2,0
	VBMT 110304E-FM			●		●	●	●	●		0,4	0,08	0,20	0,4	2,0
	VBMT 110308E-FM					●	●		●		0,8	0,10	0,25	0,8	2,5
	VBMT 160402E-FM					●	●		●		0,2	0,07	0,10	0,2	2,0
	VBMT 160404E-FM		●	●		●	●	●	●		0,4	0,10	0,20	0,4	2,0
	VBMT 160408E-FM		●	●		●	●	●	●		0,8	0,15	0,30	0,8	2,5
	VBMT 160412E-FM					●	●		●		1,2	0,20	0,40	1,2	3,0
	VBMT 160404E-RM	●	●	●		●	●		●		0,4	0,10	0,20	0,8	3,6
	VBMT 160408E-RM	●	●	●		●	●		●		0,8	0,10	0,35	1,0	3,6
	VBMT 160412E-RM			●		●	●		●		1,2	0,15	0,40	1,2	3,6
	VBMT 110202E-UR								●		0,2	0,07	0,10	0,2	2,0
	VBMT 110204E-UR					●	●		●	●	0,4	0,08	0,20	0,4	2,0
	VBMT 160402E-UR								●		0,2	0,05	0,10	0,2	2,0
	VBMT 160404E-UR		●		●	●	●		●	●	0,4	0,08	0,20	0,4	3,0
	VBMT 160408E-UR		●		●	●	●		●	●	0,8	0,08	0,40	0,8	3,0
	VBMT 160412E-UR				●	●	●		●		1,2	0,08	0,30	1,2	3,0

● New item in the assortment

● Stock assortment ○ Non-stock assortment All dimensions [mm]
See latest price list for current availability

INDEXABLE CUTTING INSERTS FOR TURNING

VCMT

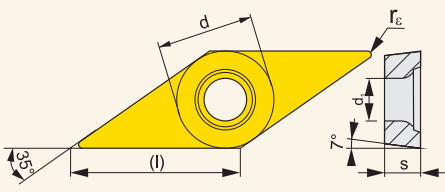

Dimensions	l	d	d ₁	s
1103	11,1	6,350	2,90	3,18
1604	16,6	9,525	4,50	4,76

MILLING TOOLS

MILLING INSERTS

TURNING INSERTS

DRILLING INSERTS

TECHNICAL SECTION

Chip-breaker	ISO	Grade			Radius		Feed/rev.		Depth of cut	
		T9315	T9325	T8330	r _c	f _{min}	f _{max}	a _{p min}	a _{p max}	
	VCMT 160404E-FM	●	○	○	0,4	0,10	0,20	0,4	2,0	
	VCMT 160408E-FM	●	○	○	0,8	0,15	0,30	0,8	2,5	
	VCMT 110304E-UR	●	○	○	0,4	0,08	0,20	0,4	2,0	
	VCMT 110308E-UR	●	○	○	0,8	0,08	0,30	0,8	2,0	
	VCMT 160404E-UR	●	○	○	0,4	0,08	0,20	0,4	2,0	
	VCMT 160408E-UR	●	○	○	0,8	0,08	0,30	0,8	3,0	

● New item in the assortment

● Stock assortment ○ Non-stock assortment All dimensions [mm]
See latest price list for current availability

INDEXABLE CUTTING INSERTS FOR TURNING

VCGW, VCMW

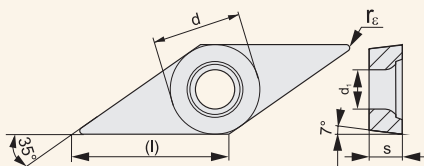

Dimensions	l	d	d ₁	s
1103	11,1	6,350	2,80	3,18
1303	13,8	7,940	3,40	3,18
1604	16,5	9,525	4,40	4,76

Chip-breaker	ISO	Grade						Radius			Feed/rev.			Depth of cut	
		T5305	T5315					r _e	f _{min}	f _{max}	a _{p min}	a _{p max}			
	VCGW 130302	●						0,2	0,07	0,10	0,4	3,3			
	VCGW 130304	●						0,4	0,10	0,20	0,4	3,3			
	VCGW 130308	●							0,8	0,10	0,40	0,8	3,3		
	VCMW 110302	●	●					0,2	0,05	0,10	0,2	2,4			
	VCMW 110304	●	●					0,4	0,05	0,20	0,4	2,4			
	VCMW 160404	●	●					0,4	0,05	0,20	0,4	3,7			
	VCMW 160408	●	●						0,8	0,05	0,40	0,8	3,7		

● New item in the assortment ● Stock assortment ○ Non-stock assortment All dimensions [mm]
See latest price list for current availability

MILLING TOOLS

MILLING INSERTS

TURNING INSERTS

DRILLING INSERTS

TECHNICAL SECTION

INDEXABLE CUTTING INSERTS FOR TURNING

VNMG

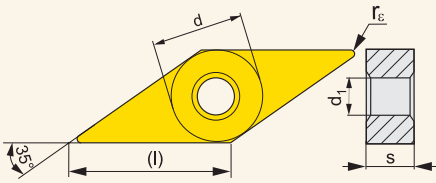

Dimensions	l	d	d ₁	s
1604	16,6	9,525	3,81	4,76

MILLING TOOLS

MILLING INSERTS

TURNING INSERTS

DRILLING INSERTS

TECHNICAL SECTION

Chip-breaker	ISO	Grade									Radius		Feed/rev.		Depth of cut		
		T5305	T5315	T7335	T9310	T9315	T9325	T9335	T6310	T8315	T8330	r _c	f _{min}	f _{max}	a _{p min}	a _{p max}	
	VNMG 160404E-FF									●	●		0,4	0,06	0,20	0,4	1,5
	VNMG 160404E-FM				●	●	●					●	0,4	0,10	0,20	0,5	3,0
	VNMG 160408E-FM				●	●	●					●	0,8	0,15	0,35	0,8	3,0
	VNMG 160412E-FM					●	●					●	1,2	0,15	0,45	1,2	3,0
	VNMG 160404E-M		●			●	●	●					0,4	0,12	0,20	0,8	3,0
	VNMG 160408E-M	●	●		●	●	●	●					0,8	0,15	0,40	0,8	4,0
	VNMG 160412E-M						●	●					1,2	0,15	0,60	1,2	4,0
	VNMG 160404E-NF			●		●	●	●	●	●			0,4	0,10	0,20	0,4	2,5
	VNMG 160408E-NF			●		●	●	●	●	●			0,8	0,13	0,30	0,8	3,0
	VNMG 160404E-NM			●			●		●	●			0,4	0,15	0,20	0,5	3,0
	VNMG 160408E-NM			●			●		●	●			0,8	0,20	0,40	0,8	3,0
	VNMG 160404E-SF								●	●	●		0,4	0,10	0,20	0,4	2,0
	VNMG 160408E-SF								●	●	●		0,8	0,12	0,25	0,8	2,5
	VNMG 160412E-SF								●	●			1,2	0,15	0,28	1,2	3,0
	VNMG 160404E-SM			●		●	●	●	●	●			0,4	0,15	0,20	0,4	3,0
	VNMG 160408E-SM			●		●	●	●	●	●			0,8	0,20	0,30	0,8	3,5
	VNMG 160412E-SM					●		●	●	●			1,2	0,22	0,40	1,2	3,5

● New item in the assortment

● Stock assortment ○ Non-stock assortment All dimensions [mm]
See latest price list for current availability

INDEXABLE CUTTING INSERTS FOR TURNING

WCMT

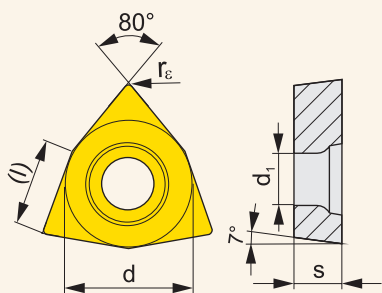

Dimensions	l	d	d ₁	s
06T3	6,5	9,525	4,50	3,97
0804	8,7	12,700	5,60	4,76

Chip-breaker	ISO	Grade					Radius	Feed/rev.		Depth of cut	
		T7335	T9315	T9325	T8315	T8330	r _e	f _{min}	f _{max}	a _{p min}	a _{p max}
	WCMT 06T304E-FM	●	●	●	●	●	0,4	0,10	0,30	0,4	3,0
	WCMT 06T308E-FM	●	●	●	●	●	0,8	0,15	0,35	0,8	3,0
	WCMT 080404E-FM	●	●	●	●	●	0,4	0,10	0,30	0,4	4,0
	WCMT 080408E-FM	●	●	●	●	●	0,8	0,15	0,35	0,8	4,0
	WCMT 080412E-FM	●	●	●	●	●	1,2	0,15	0,45	1,2	4,0
	WCMT 06T308E-UR	●	●				0,8	0,15	0,30	0,8	3,0
	WCMT 06T308E-RF	●					0,8	0,15	0,40	0,8	4,0
	WCMT 080412E-RF	●					1,2	0,20	0,70	1,2	5,6

● New item in the assortment ● Stock assortment ○ Non-stock assortment All dimensions [mm]
 See latest price list for current availability

MILLING TOOLS

MILLING INSERTS

TURNING INSERTS

DRILLING INSERTS

TECHNICAL SECTION

INDEXABLE CUTTING INSERTS FOR TURNING

WNMA

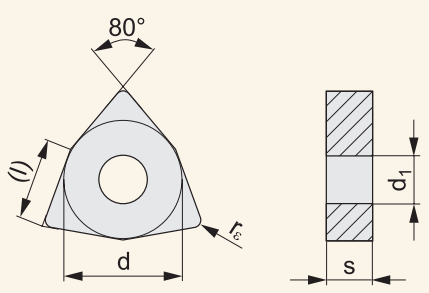

Dimensions	l	d	d ₁	s
0804	8,7	12,700	5,16	4,76

Chip-breaker	ISO	Grade			Radius	Feed/rev.		Depth of cut	
		T5305	T5315	T6310	r _c	f _{min}	f _{max}	a _{p min}	a _{p max}
	WNMA 080404	●	●		0,4	0,10	0,30	0,4	4,4
	WNMA 080408	●	●	●	0,8	0,05	0,60	0,8	4,4
	WNMA 080412	●	●	●	1,2	0,05	0,60	1,2	4,4
	WNMA 080408S	●			0,8	0,10	0,60	0,8	4,4

● New item in the assortment ● Stock assortment ○ Non-stock assortment All dimensions [mm]
 See latest price list for current availability

INDEXABLE CUTTING INSERTS FOR TURNING

WNMG

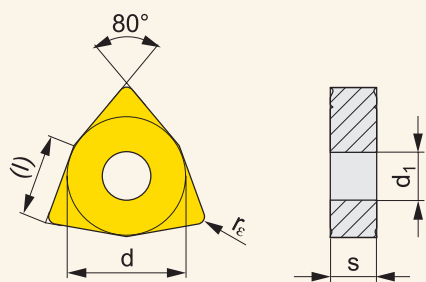









Dimensions	l	d	d ₁	s
0604	6,5	9,525	3,81	4,76
06T3	6,5	9,525	3,81	3,97
0804	8,7	12,700	5,16	4,76

Chip-breaker	ISO	Grade											Radius		Feed/rev.		Depth of cut			
		T5305	T5315	T7335	T9310	T9315	T9325	T9335	6630	T6310	T8315	T8330	H07	HF7	TT310	r _c	f _{min}	f _{max}	a _{p min}	a _{p max}
	WNMG 060408W-F					●	●									0,8	0,15	0,60	0,8	4,2
	WNMG 080404W-F					●	●									0,4	0,15	0,30	0,4	4,4
	WNMG 060402E-FF												●			0,2	0,06	0,15	0,2	1,5
	WNMG 060404E-FF												●			0,4	0,06	0,20	0,4	1,5
	WNMG 080404E-FF												●			0,4	0,06	0,20	0,4	1,5
	WNMG 080408E-FF												●			0,8	0,08	0,25	0,8	1,5
	WNMG 06T304E-FM						●						●			0,4	0,10	0,30	0,5	3,0
	WNMG 06T308E-FM						●						●			0,8	0,10	0,35	0,8	3,0
	WNMG 060404E-FM					●	●					●	●		●	0,4	0,10	0,30	0,5	3,0
	WNMG 060408E-FM					●	●					●			●	0,8	0,10	0,35	0,8	3,0
	WNMG 060412E-FM						●									1,2	0,15	0,45	1,2	3,0
	WNMG 080404E-FM				●	●	●	●					●	●		0,4	0,10	0,30	0,5	3,0
	WNMG 080408E-FM				●	●	●	●					●	●		0,8	0,15	0,45	0,8	3,0
	WNMG 080412E-FM				●	●	●	●					●			1,2	0,15	0,45	1,2	4,0
	WNMG 080408E-KR	●	●													0,8	0,25	0,60	0,8	5,5
	WNMG 080412E-KR	●	●													1,2	0,25	0,60	1,2	5,5
	WNMG 060404E-M		●			●	●	●								0,4	0,17	0,30	0,8	3,0
	WNMG 060408E-M		●		●	●	●	●								0,8	0,15	0,60	0,8	4,2
	WNMG 080404E-M		●			●	●	●								0,4	0,17	0,30	0,8	3,0
	WNMG 080408E-M	●	●		●	●	●	●	●			●				0,8	0,15	0,60	0,8	5,6
	WNMG 080412E-M	●	●		●	●	●	●								1,2	0,15	0,80	1,2	5,6
	WNMG 060408W-M				●	●	●									0,8	0,15	0,60	0,8	3,0
	WNMG 060412W-M		●			●	●									1,2	0,15	0,90	1,2	3,0
	WNMG 080408W-M					●	●									0,8	0,15	0,60	0,8	4,0
	WNMG 080412W-M		●			●	●									1,2	0,20	0,90	1,2	4,0
	WNMG 060408W-MR					●	●									0,8	0,46	0,70	0,8	3,0
	WNMG 080404W-MR					●	●									0,4	0,39	0,60	0,5	4,0

● New item in the assortment

● Stock assortment ○ Non-stock assortment All dimensions [mm]
See latest price list for current availability

INDEXABLE CUTTING INSERTS FOR TURNING

Chip-breaker	ISO	Grade										Radius		Feed/rev.		Depth of cut				
		T5305	T5315	T7335	T9310	T9315	T9325	T9335	6630	T6310	T8315	T8330	H07	HF7	TT310	r_c	f_{min}	f_{max}	$a_{p min}$	$a_{p max}$
	WNMG 080408W-MR		●			●	●									0,8	0,46	0,70	0,8	4,0
	WNMG 080412W-MR		●			●	●									1,2	0,49	0,75	1,2	4,0
	WNMG 060404E-NF			●		●	●		●	●	●				0,4	0,10	0,30	0,4	3,0	
	WNMG 060408E-NF					●	●		●	●	●				0,8	0,13	0,30	0,8	3,0	
	WNMG 080404E-NF			●		●	●		●	●	●		●		0,4	0,13	0,30	0,4	3,0	
	WNMG 080408E-NF			●		●	●		●	●	●		●		0,8	0,15	0,35	0,8	3,5	
	WNMG 080412E-NF			●		●	●		●	●	●				1,2	0,15	0,35	1,2	4,0	
	WNMG 060404E-NM			●		●				●	●				0,4	0,15	0,30	0,5	3,0	
	WNMG 060408E-NM			●		●	●			●	●				0,8	0,20	0,40	0,8	3,0	
	WNMG 060412E-NM			●		●	●								1,2	0,20	0,50	1,2	3,5	
	WNMG 080404E-NM			●		●	●			●	●				0,4	0,15	0,30	0,5	3,0	
	WNMG 080408E-NM			●		●	●			●	●				0,8	0,20	0,50	0,8	3,0	
	WNMG 080412E-NM			●		●	●			●	●				1,2	0,20	0,50	1,2	3,5	
	WNMG 080408E-R		●	●		●	●	●	●						0,8	0,25	0,60	2,0	5,6	
	WNMG 080412E-R		●	●		●	●	●	●						1,2	0,25	0,70	2,0	5,6	
	WNMG 080416E-R			●											1,6	0,30	0,80	2,0	5,6	
	WNMG 060412E-RM				●		●	●	●						1,2	0,25	0,60	1,3	4,0	
	WNMG 080408E-RM		●	●	●	●	●	●		●	●				0,8	0,20	0,55	1,0	5,0	
	WNMG 080412E-RM		●	●	●	●	●	●		●	●				1,2	0,25	0,70	1,5	5,0	
	WNMG 080416E-RM		●	●	●	●	●	●			●				1,6	0,30	0,75	2,0	5,0	
	WNMG 060404E-SF				●					●	●	●	●		0,4	0,10	0,25	0,4	2,5	
	WNMG 060408E-SF				●					●	●	●	●		0,8	0,12	0,28	0,8	3,0	
	WNMG 080404E-SF				●					●	●	●	●		0,4	0,10	0,30	0,4	2,7	
	WNMG 080408E-SF				●					●	●	●	●		0,8	0,12	0,30	0,8	3,0	
	WNMG 060404E-SM				●		●	●			●				0,4	0,18	0,30	0,4	3,0	
	WNMG 060408E-SM				●					●	●				0,8	0,18	0,35	0,8	3,5	
	WNMG 060412E-SM				●						●				1,2	0,20	0,40	1,2	4,0	
	WNMG 080404E-SM				●		●	●			●	●			0,4	0,18	0,30	0,4	4,0	
	WNMG 080408E-SM				●		●	●			●	●			0,8	0,20	0,45	0,8	4,0	
	WNMG 080412E-SM				●		●	●			●	●			1,2	0,22	0,45	1,2	4,5	
	WNMG 060404EL-SI						●				●				0,4	0,20	0,30	0,8	4,2	
	WNMG 080404EL-SI				●					●	●				0,4	0,20	0,30	0,8	5,0	
	WNMG 080408EL-SI				●					●	●				0,8	0,20	0,50	0,8	5,0	
	WNMG 080412EL-SI							●			●				1,2	0,20	0,50	1,2	5,0	
	WNMG 060404ER-SI						●				●				0,4	0,20	0,30	0,8	4,2	
	WNMG 080404ER-SI				●					●	●				0,4	0,20	0,30	0,8	5,0	
	WNMG 080408ER-SI				●					●	●				0,8	0,20	0,50	0,8	5,0	
	WNMG 080412ER-SI							●			●				1,2	0,20	0,50	1,2	5,0	

● New item in the assortment

● Stock assortment ○ Non-stock assortment All dimensions [mm]
See latest price list for current availability

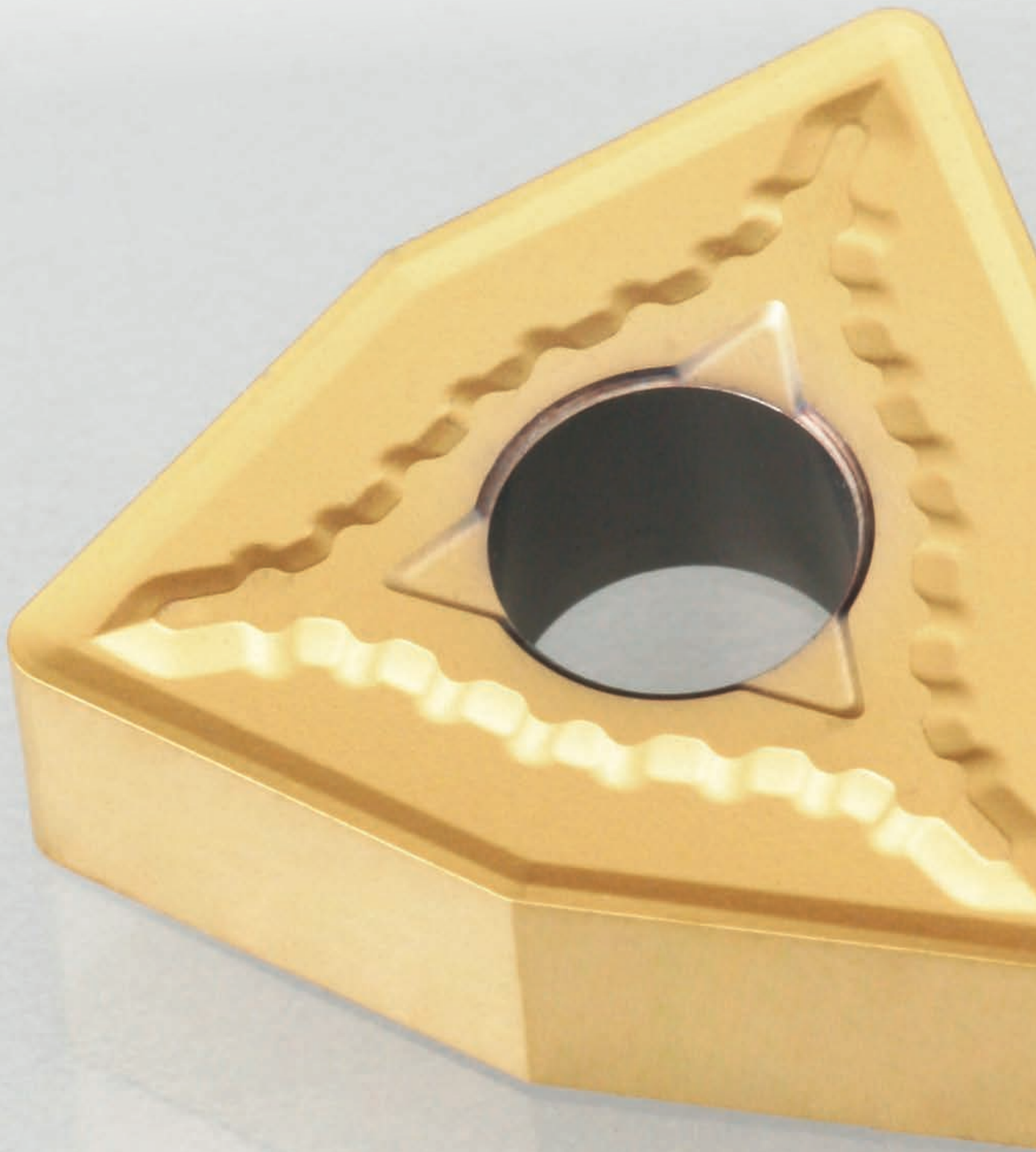

DRILLING INSERTS

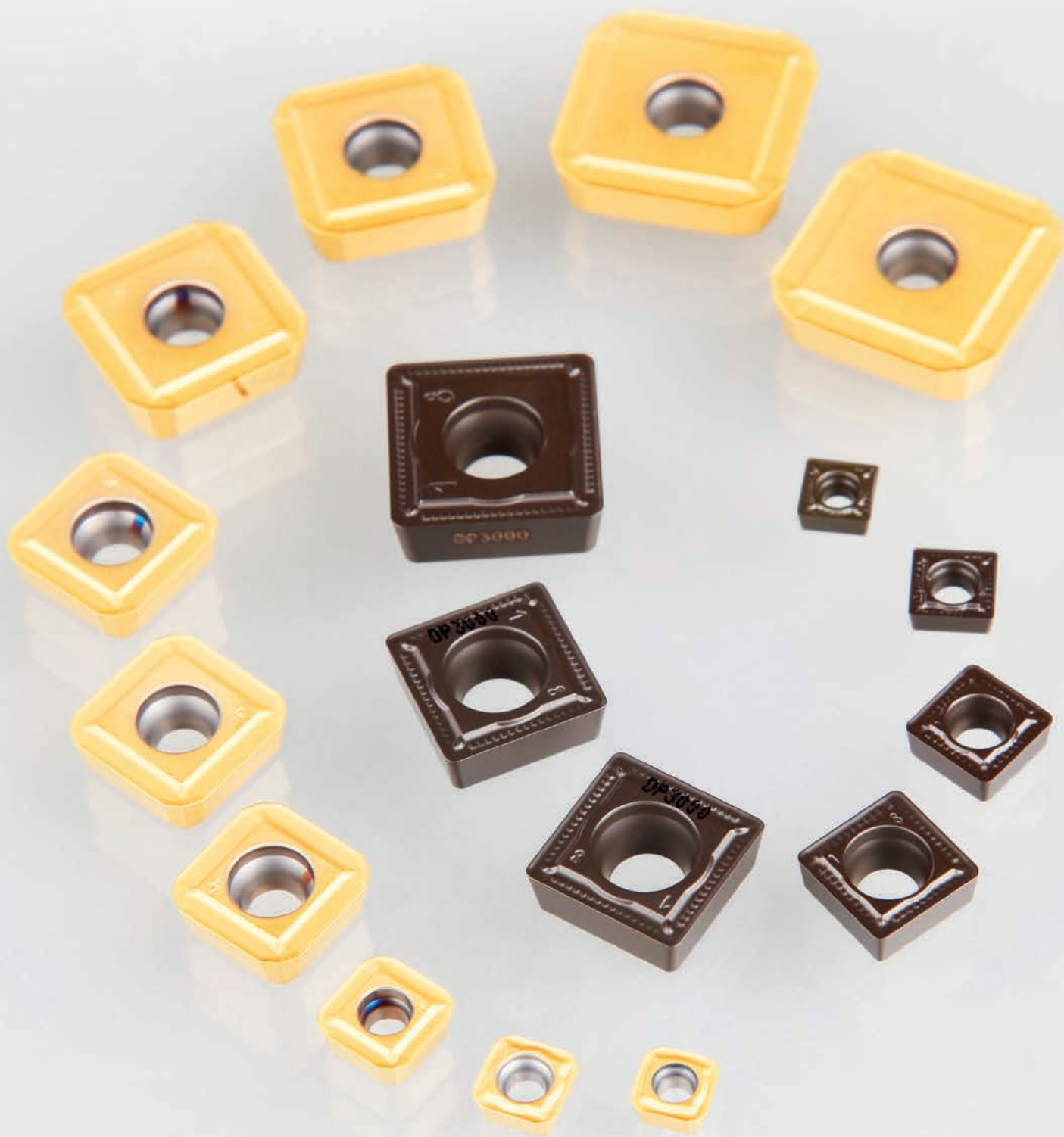

NEW INSERTS FOR DRILLING LONG-CHIP MATERIALS

The new SD chip-breaker expands the choice for the SCET and XPET inserts in the 800D drill series. The chip-breaker is designed for drilling long-chip materials, in particular mild steel and stainless steel.

NEW PRODUCTS

- New patented SD chip-breaker for the SCET and XPET inserts
- Optimised for low carbon and soft stainless steels

BENEFITS

- Reliable formation of chip and good chip evacuation
- Quiet running, minimised vibration
- Suitable for high cutting speeds
- Optimised geometry with different grades for the outer and inner inserts allows better performance and greater insert reliability



SD

CHIP-BREAKER SD

Positive geometry with stabiliser

- For low carbon and soft stainless steels
- Geometry designed for drilling in solid material
- Optimum contact of the chip with the face increases durability of the inserts
- Low cutting forces

MACHINING EXAMPLE USING THE NEW SD CHIP-BREAKER

Material: AISI316
 Drill: 803D-21-63-S25
 Inner insert: XPET 0602AP-SD:D8345
 Outer insert: SCET 060204-SD:D9335
 Coolant: Yes

Speed	n	1950	1/min
Feed per revolution	f	0,08	mm

Chip-breaker	UD	SD	
Total drilled length	432	6048	mm
Total time	2,8	38,8	min

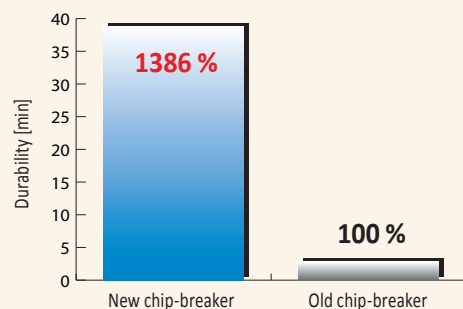

For best results use the same SD chip breaker for both inner and outer inserts.





We offer a range of 2D – 5D drills for drilling steels and stainless steels.

INDEXABLE CUTTING INSERTS FOR DRILLING

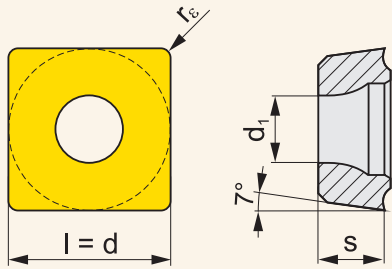
SCET



Dimensions	l	d	s	d ₁		
0502	5,6	5,556	2,38	2,40		
0602	6,4	6,350	2,38	2,90		
0703	7,9	7,937	3,18	3,50		
09T3	9,5	9,525	3,97	4,50		
1204	12,7	12,700	4,76	5,60		
1505	15,9	15,875	5,56	5,60		

Chip-breaker	ISO	Grade		Radius	Feed/rev.		Depth of cut	
		D8330	D9335		r _c	f _{min}	f _{max}	a _{p min}
	SCET 050204-UD	●	●	0,4	0,05	0,11	-	-
	SCET 060204-UD	●	●	0,4	0,06	0,15	-	-
	SCET 070308-UD	●	●	0,8	0,07	0,18	-	-
	SCET 09T308-UD	●	●	0,8	0,08	0,20	-	-
	SCET 120408-UD	●	●	0,8	0,09	0,22	-	-
	SCET 150512-UD	●	●	1,2	0,10	0,25	-	-
	SCET 050204-SD	●	●	0,4	0,05	0,11	-	-
	SCET 060204-SD	●	●	0,4	0,06	0,15	-	-
	SCET 070308-SD	●	●	0,8	0,07	0,18	-	-
	SCET 09T308-SD	●	●	0,8	0,08	0,20	-	-
	SCET 120408-SD	●	●	0,8	0,09	0,22	-	-
	SCET 150512-SD	●	●	1,2	0,10	0,25	-	-

● New item in the assortment

● Stock assortment ○ Non-stock assortment All dimensions [mm]
See latest price list for current availability

INDEXABLE CUTTING INSERTS FOR DRILLING

XPET

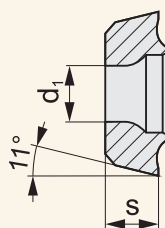
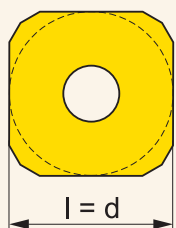

Dimensions	l	d	s	d ₁
0502	5,6	5,556	2,38	2,40
0602	6,4	6,350	2,38	2,60
0703	7,9	7,937	3,18	2,90
0903	9,5	9,525	3,18	3,50
11T3	11,5	11,509	3,97	3,90
12T3	12,7	12,700	3,97	3,90
1504	15,9	15,875	4,76	4,50
1904	19,1	19,050	4,76	4,50

Chip-breaker	ISO	D8345	Grade						Radius		Feed/rev.		Depth of cut	
									r _c	f _{min}	f _{max}	a _{p min}	a _{p max}	
	XPET 0502AP	●								0,05	0,11	-	-	
	XPET 0602AP	●								0,06	0,15	-	-	
	XPET 0703AP	●								0,07	0,18	-	-	
	XPET 0903AP	●								0,08	0,20	-	-	
	XPET 11T3AP	●								0,09	0,22	-	-	
	XPET 12T3AP	●								0,09	0,22	-	-	
	XPET 1504AP	●								0,10	0,25	-	-	
	XPET 1904AP	●								0,10	0,25	-	-	
	XPET 0502AP-SD	●								0,05	0,11	-	-	
	XPET 0602AP-SD	●								0,06	0,15	-	-	
	XPET 0703AP-SD	●								0,07	0,18	-	-	
	XPET 0903AP-SD	●								0,08	0,20	-	-	
	XPET 11T3AP-SD	●								0,09	0,22	-	-	
	XPET 12T3AP-SD	●								0,09	0,22	-	-	
	XPET 1504AP-SD	●								0,10	0,25	-	-	
	XPET 1904AP-SD	●								0,10	0,25	-	-	

● New item in the assortment

● Stock assortment ○ Non-stock assortment All dimensions [mm]
See latest price list for current availability

MILLING TOOLS

MILLING INSERTS

TURNING INSERTS

DRILLING INSERTS

TECHNICAL SECTION

TECHNICAL SECTION



WORKPIECE MATERIALS - CLASSIFICATION

Correctly identifying the machined material is one of the most important factors when choosing the tool and the initial machining conditions. To facilitate this, the machined materials are divided into six basic groups, or into twenty-four subgroups, combining materials that qualitatively cause







the same type of loading (straining) on the cutting edge and therefore a similar type of wear.

Thus the first step is to assign the workpiece material to one of the (sub) groups - see table

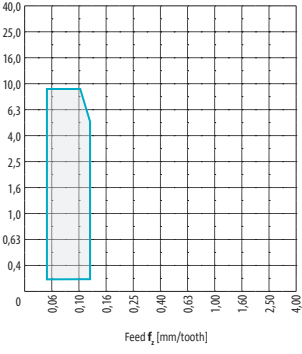
Group	Subgroup	*Dormer AMG	Subgroup definition	Example	Correction to standard
P	P1	1.1, 1.2	Steel and cast steel with very good (enhanced) machinability; automatic steel and low-carbon steel	ČSN 11 109	1,33
	P2	1.3	Non-alloy and low-alloy cast steel and steel with a medium carbon content ($0.25 < C < 0.55$); rigidity of up to 900 MPa and hardness of 160-255 HB	ČSN 12 050	1,00
	P3	1.4	Less machinable non-alloy and low-alloy cast steel and steel with a medium carbon content; rigidity of up to 1000 MPa and hardness of up to 300 HB	ČSN 15 340	0,80
	P4	1.5	Medium- to high-alloy cast steel and steel (usually with a carbon content of $0.55 < C$); rigidity of up to 1270 MPa and hardness of up to 375HB (resp. 40 HRC)	ČSN 19 436	0,60
M	M1	2.1	Ferritic corrosion-resistant steel	ČSN 17041	1,09
	M2	(2.1, 2.4)	Martensitic corrosion-resistant steel	ČSN 17042	1,06
	M3	2.2	Austenitic corrosion-resistant steel	ČSN 17 247	1,00
	M4	2.3, 2.4	Ferritic-austenitic (duplex) and super-austenitic corrosion-resistant steel	ČSN 17 465	0,93
K	K1	3.1, 3.2	Grey cast iron	ČSN 42 2425	1,00
	K2	3.1, 3.2	Tempered cast iron	ČSN 42 2545	0,95
	K3	3.3	Ductile cast iron ferritic and ferrite-pearlite	ČSN 42 2304	0,90
	K4	3.4	Ductile cast iron pearlite-ferritic, pearlite-sorbite and pearlite	ČSN 42 2307	0,85
N	N1	7.1	Aluminium and its soft alloys (with a low Si content), particularly formed and cast (non-hardened); hardness of up to 100 HB	ČSN 42 4400	1,00
	N2	7.2, 7.3, 7.4	Hard Al alloys, particularly cast and hardened (with a high Si content)	ČSN 42 4330	0,65
	N3	6.1, 6.2, 6.3	Soft Cu alloys, automatic brass and other types of soft brass and bronze	ČSN 42 3135	0,60
	N4	6.4	Less machinable and hard Cu alloys	ČSN 42 3145	0,40
S	S1	4.1, 4.2, 4.3	Technically pure Ti, alloys a, a+b and b, refined and aged alloys	TiAl6V4	1,75
	S2	5.1, 5.2, 5.3	Fe-based alloys	INCOLOY 800	1,20
	S3	5.1, 5.2, 5.3	Ni-based alloys	INCONEL 718	1,00
	S4	5.1, 5.2, 5.3	Co-based alloys	Haynes 25	0,75
H	H1	1.6	Highly rigid and hard tool steel and hardened and refined steel with a hardness of 40-50 HRC	ČSN 19 854	1,15
	H2	-	Hardened and white cast iron 350-600 HV	ČSN 42 2483	1,10
	H3	1.7	Hardened and refined steel with hardness in the 50-55 HRC range	ČSN 19 552.4	1,00
	H4	1.8	Hardened and refined (mostly tool) steel with hardness of more than 55 HRC	ČSN 19 436.4	0,95

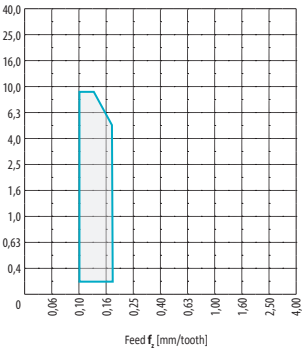
* The material classification code used by Dormer is added here for cross reference purposes and should be used only as a guide.

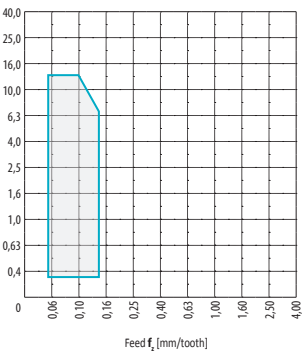
GEOMETRY OF CUTTING INSERTS FOR MILLING

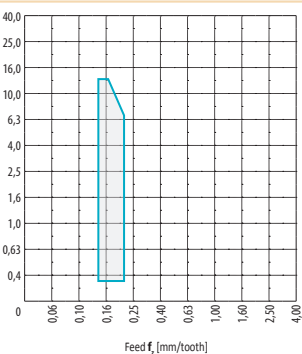
Geometry	Photo	Group of machined materials						Operating diagram	Description	Used for inserts: ADMX 11T304SR-MF, ADMX 11T308SR-MF																									
		Milling	P	M	K	N	S				H																								
ADMX 11-MF		Light	■	■	■	□	□		<ul style="list-style-type: none"> - Highly positive geometry - Suitable for milling material groups M, S, P and secondary N - Particularly suited to light milling - Available with radii of 0.4 and 0.8 - Particularly suited to finishing operations 																										
	Cutting edge profile	Medium	■	■	■	□	□																												
	Heavy	■	■	■	□	□	□																												
<table border="1"> <tr> <td colspan="8">Range of machining conditions:</td> <td>Unit:</td> </tr> <tr> <td>f_z</td> <td colspan="7">0,05 ÷ 0,14</td> <td>[mm/tooth]</td> </tr> <tr> <td>a_p</td> <td colspan="7">0,2 ÷ 9,0</td> <td>[mm]</td> </tr> </table>									Range of machining conditions:								Unit:	f_z	0,05 ÷ 0,14							[mm/tooth]	a_p	0,2 ÷ 9,0							[mm]
Range of machining conditions:								Unit:																											
f_z	0,05 ÷ 0,14							[mm/tooth]																											
a_p	0,2 ÷ 9,0							[mm]																											
ADMX 11-MM		Light	■	■	■	□	□		<ul style="list-style-type: none"> - Highly positive geometry - Suitable for milling material groups M, S, P and secondary N - Particularly suited to light and medium machining - Available with radii of 0.4, 0.8 and 1.2 - Universal geometry for finishing and semi-roughing operations 																										
	Cutting edge profile	Medium	■	■	■	□	□																												
	Heavy	■	■	■	□	□	□																												
<table border="1"> <tr> <td colspan="8">Range of machining conditions:</td> <td>Unit:</td> </tr> <tr> <td>f_z</td> <td colspan="7">0,1 ÷ 0,18</td> <td>[mm/tooth]</td> </tr> <tr> <td>a_p</td> <td colspan="7">0,2 ÷ 9,0</td> <td>[mm]</td> </tr> </table>									Range of machining conditions:								Unit:	f_z	0,1 ÷ 0,18							[mm/tooth]	a_p	0,2 ÷ 9,0							[mm]
Range of machining conditions:								Unit:																											
f_z	0,1 ÷ 0,18							[mm/tooth]																											
a_p	0,2 ÷ 9,0							[mm]																											
ADMX 16-MF		Light	■	■	■	□	□		<ul style="list-style-type: none"> - Highly positive geometry - Suitable for milling material groups M, S, P and secondary N - Particularly suited to finishing operations 																										
	Cutting edge profile	Medium	■	■	■	□	□																												
	Heavy	■	■	■	□	□	□																												
<table border="1"> <tr> <td colspan="8">Range of machining conditions:</td> <td>Unit:</td> </tr> <tr> <td>f_z</td> <td colspan="7">0,05 ÷ 0,16</td> <td>[mm/tooth]</td> </tr> <tr> <td>a_p</td> <td colspan="7">0,3 ÷ 13,0</td> <td>[mm]</td> </tr> </table>									Range of machining conditions:								Unit:	f_z	0,05 ÷ 0,16							[mm/tooth]	a_p	0,3 ÷ 13,0							[mm]
Range of machining conditions:								Unit:																											
f_z	0,05 ÷ 0,16							[mm/tooth]																											
a_p	0,3 ÷ 13,0							[mm]																											
ADMX 16-MM		Light	■	■	■	□	□		<ul style="list-style-type: none"> - Highly positive geometry - Suitable for milling material groups M, S, P and secondary N - Available with radii of 0.4, 0.8 and 1.6 - Universal geometry for finishing and semi-roughing operations 																										
	Cutting edge profile	Medium	■	■	■	□	□																												
	Heavy	■	■	■	□	□	□																												
<table border="1"> <tr> <td colspan="8">Range of machining conditions:</td> <td>Unit:</td> </tr> <tr> <td>f_z</td> <td colspan="7">0,14 ÷ 0,22</td> <td>[mm/tooth]</td> </tr> <tr> <td>a_p</td> <td colspan="7">0,3 ÷ 13,0</td> <td>[mm]</td> </tr> </table>									Range of machining conditions:								Unit:	f_z	0,14 ÷ 0,22							[mm/tooth]	a_p	0,3 ÷ 13,0							[mm]
Range of machining conditions:								Unit:																											
f_z	0,14 ÷ 0,22							[mm/tooth]																											
a_p	0,3 ÷ 13,0							[mm]																											

Main application area
 Other applications
 Potential applications

GEOMETRY OF CUTTING INSERTS FOR MILLING

MILLING TOOLS

LNGX 12-MF

Geometry	Photo	Group of machined materials						Operating diagram	Description	Used for inserts: LNGX 120504ER-MF, LNGX 120508ER-MF	
		Milling	P	M	K	N	S				H
	Light	■	■				■				
	Medium	□	■			■					
Heavy											

Depth of cut a_p [mm]

Feed f_z [mm/tooth]

Range of machining conditions:

f_z	0,04 ÷ 0,15	Unit:	[mm/tooth]
a_p	0,3 ÷ 9,0	Unit:	[mm]

- Positive geometry without peripheral land
- Suitable for milling material groups M, S and P
- Particularly suited to light milling
- Available with radii of 0.4 and 0.8

MILLING INSERTS

LNGX 12-MM

Geometry	Photo	Group of machined materials						Operating diagram	Description	Used for inserts: LNGX 120508SR-MM	
		Milling	P	M	K	N	S				H
	Light	■	■				■				
	Medium	■	■			■					
Heavy	□	□					□				

Depth of cut a_p [mm]

Feed f_z [mm/tooth]

Range of machining conditions:

f_z	0,08 ÷ 0,20	Unit:	[mm/tooth]
a_p	0,3 ÷ 9,0	Unit:	[mm]

- Positive geometry with stabilised cutting edge
- Suitable for milling material groups M, S and P
- Particularly suited to light and medium machining

TURNING INSERTS

DRILLING INSERTS

TECHNICAL SECTION

■ Main application area ■ Other applications □ Potential applications

GEOMETRY OF CUTTING INSERTS FOR MILLING

Geometry	Photo	Group of machined materials						Operating diagram	Description	Used for inserts: LNGU 160708FR-FA							
		Milling	P	M	K	N	S				H						
LNGU 16-FA		Light	■	■	■	■	■	■	<ul style="list-style-type: none"> - Highly positive geometry with a sharp cutting edge - Suitable for machining material group N, and potentially groups M and S - Cutting insert has a polished face to reduce sticking of the machined material - $f_{zmax} = 0.18$ for ISO M and S 								
	Cutting edge profile	Medium	□	□	□	□	□	□									
		Heavy	□	□	□	□	□	□									
									<p>Range of machining conditions:</p> <table border="1"> <tr> <td>f_z</td> <td>0,05 ÷ 0,45</td> <td>Unit:</td> <td>[mm/tooth]</td> </tr> <tr> <td>a_p</td> <td>0,3 ÷ 13,0</td> <td>Unit:</td> <td>[mm]</td> </tr> </table>	f_z	0,05 ÷ 0,45	Unit:	[mm/tooth]	a_p	0,3 ÷ 13,0	Unit:	[mm]
f_z	0,05 ÷ 0,45	Unit:	[mm/tooth]														
a_p	0,3 ÷ 13,0	Unit:	[mm]														
LNMU 16ER-F		Light	■	■	■	■	■	■	<ul style="list-style-type: none"> - Positive geometry without a peripheral stabilising land - Suitable for machining material group P, and potentially groups K, M and S - Particularly suited to light milling 								
	Cutting edge profile	Medium	□	□	□	□	□	□									
		Heavy	□	□	□	□	□	□									
									<p>Range of machining conditions:</p> <table border="1"> <tr> <td>f_z</td> <td>0,08 ÷ 0,20</td> <td>Unit:</td> <td>[mm/tooth]</td> </tr> <tr> <td>a_p</td> <td>0,3 ÷ 13,0</td> <td>Unit:</td> <td>[mm]</td> </tr> </table>	f_z	0,08 ÷ 0,20	Unit:	[mm/tooth]	a_p	0,3 ÷ 13,0	Unit:	[mm]
f_z	0,08 ÷ 0,20	Unit:	[mm/tooth]														
a_p	0,3 ÷ 13,0	Unit:	[mm]														
LNMU 16SR-M		Light	■	■	■	■	■	■	<ul style="list-style-type: none"> - Positive geometry with stabilised cutting edge - Suitable for machining material groups P and K, and potentially M - Particularly suited to light and medium machining - Available with radii of 08, 20, 30 and 40 								
	Cutting edge profile	Medium	□	□	□	□	□	□									
		Heavy	□	□	□	□	□	□									
									<p>Range of machining conditions:</p> <table border="1"> <tr> <td>f_z</td> <td>0,1 ÷ 0,30</td> <td>Unit:</td> <td>[mm/tooth]</td> </tr> <tr> <td>a_p</td> <td>0,3 ÷ 13,0</td> <td>Unit:</td> <td>[mm]</td> </tr> </table>	f_z	0,1 ÷ 0,30	Unit:	[mm/tooth]	a_p	0,3 ÷ 13,0	Unit:	[mm]
f_z	0,1 ÷ 0,30	Unit:	[mm/tooth]														
a_p	0,3 ÷ 13,0	Unit:	[mm]														
LNMU 16SR-R		Light	■	■	■	■	■	■	<ul style="list-style-type: none"> - Positive geometry with a negative stabilising land - Geometry suitable for medium machining - Suitable for machining material groups K and P - Also suitable for material group H and potentially M - Geometry also suitable for less stable conditions - Available with radii of 08 and 16 								
	Cutting edge profile	Medium	□	□	□	□	□	□									
		Heavy	□	□	□	□	□	□									
									<p>Range of machining conditions:</p> <table border="1"> <tr> <td>f_z</td> <td>0,15 ÷ 0,40</td> <td>Unit:</td> <td>[mm/tooth]</td> </tr> <tr> <td>a_p</td> <td>0,3 ÷ 13,0</td> <td>Unit:</td> <td>[mm]</td> </tr> </table>	f_z	0,15 ÷ 0,40	Unit:	[mm/tooth]	a_p	0,3 ÷ 13,0	Unit:	[mm]
f_z	0,15 ÷ 0,40	Unit:	[mm/tooth]														
a_p	0,3 ÷ 13,0	Unit:	[mm]														

■ Main application area ■ Other applications □ Potential applications

GEOMETRY OF CUTTING INSERTS FOR MILLING

MILLING TOOLS

MILLING INSERTS

TURNING INSERTS

DRILLING INSERTS

TECHNICAL SECTION

OEHT 06-MF

Geometry	Photo	Group of machined materials						Operating diagram	Description	Used for inserts: OEHT 0604AEER-MF						
		Milling	P	M	K	N	S				H					
Cutting edge profile		Light	■	■	■	■	■		<ul style="list-style-type: none"> - Sharp geometry with a positive rake angle - Suitable for machining material groups M and S, and potentially P and N - Designed primarily for finishing - Suitable for light and medium cutting conditions - It may be possible to use all eight cutting edges depending on the depth of cut 	Range of machining conditions: Unit: <table border="1"> <tr> <td>f_z</td> <td>0,08 ÷ 0,20</td> <td>[mm/tooth]</td> </tr> <tr> <td>a_p</td> <td>0,5 ÷ 3,3 (4,3; 9,9; 10,7)</td> <td>[mm]</td> </tr> </table>	f_z	0,08 ÷ 0,20	[mm/tooth]	a_p	0,5 ÷ 3,3 (4,3; 9,9; 10,7)	[mm]
		f_z	0,08 ÷ 0,20	[mm/tooth]												
		a_p	0,5 ÷ 3,3 (4,3; 9,9; 10,7)	[mm]												
Medium	■	■	■	■	■	<table border="1"> <tr> <td>f_z</td> <td>0,08 ÷ 0,20</td> <td>[mm/tooth]</td> </tr> <tr> <td>a_p</td> <td>0,5 ÷ 3,3 (4,3; 9,9; 10,7)</td> <td>[mm]</td> </tr> </table>	f_z	0,08 ÷ 0,20	[mm/tooth]	a_p	0,5 ÷ 3,3 (4,3; 9,9; 10,7)	[mm]				
f_z	0,08 ÷ 0,20	[mm/tooth]														
a_p	0,5 ÷ 3,3 (4,3; 9,9; 10,7)	[mm]														
Heavy	■	■	■	■	■											

OEHT 06-MM

Geometry	Photo	Group of machined materials						Operating diagram	Description	Used for inserts: OEHT 0604AEER-MM						
		Milling	P	M	K	N	S				H					
Cutting edge profile		Light	■	■	■	■	■		<ul style="list-style-type: none"> - Sharp geometry with a slightly positive rake angle - Suitable for machining material groups M, S and P, and potentially N - Designed especially for light and medium machining - It may be possible to use all eight cutting edges depending on the depth of cut 	Range of machining conditions: Unit: <table border="1"> <tr> <td>f_z</td> <td>0,08 ÷ 0,25</td> <td>[mm/tooth]</td> </tr> <tr> <td>a_p</td> <td>0,5 ÷ 3,3 (4,3; 9,9; 10,7)</td> <td>[mm]</td> </tr> </table>	f_z	0,08 ÷ 0,25	[mm/tooth]	a_p	0,5 ÷ 3,3 (4,3; 9,9; 10,7)	[mm]
		f_z	0,08 ÷ 0,25	[mm/tooth]												
		a_p	0,5 ÷ 3,3 (4,3; 9,9; 10,7)	[mm]												
Medium	■	■	■	■	■	<table border="1"> <tr> <td>f_z</td> <td>0,08 ÷ 0,25</td> <td>[mm/tooth]</td> </tr> <tr> <td>a_p</td> <td>0,5 ÷ 3,3 (4,3; 9,9; 10,7)</td> <td>[mm]</td> </tr> </table>	f_z	0,08 ÷ 0,25	[mm/tooth]	a_p	0,5 ÷ 3,3 (4,3; 9,9; 10,7)	[mm]				
f_z	0,08 ÷ 0,25	[mm/tooth]														
a_p	0,5 ÷ 3,3 (4,3; 9,9; 10,7)	[mm]														
Heavy	■	■	■	■	■											

OEHT 06-M

Geometry	Photo	Group of machined materials						Operating diagram	Description	Used for inserts: OEHT 0604AEER-M						
		Milling	P	M	K	N	S				H					
Cutting edge profile		Light	■	■	■	■	■		<ul style="list-style-type: none"> - Geometry with a slightly positive rake angle and a narrow peripheral land - Suitable for milling material groups M, P and S - Designed especially for light and medium machining - It may be possible to use all eight cutting edges depending on the depth of cut 	Range of machining conditions: Unit: <table border="1"> <tr> <td>f_z</td> <td>0,08 ÷ 0,35</td> <td>[mm/tooth]</td> </tr> <tr> <td>a_p</td> <td>0,8 ÷ 3,3 (4,3; 9,9; 10,7)</td> <td>[mm]</td> </tr> </table>	f_z	0,08 ÷ 0,35	[mm/tooth]	a_p	0,8 ÷ 3,3 (4,3; 9,9; 10,7)	[mm]
		f_z	0,08 ÷ 0,35	[mm/tooth]												
		a_p	0,8 ÷ 3,3 (4,3; 9,9; 10,7)	[mm]												
Medium	■	■	■	■	■	<table border="1"> <tr> <td>f_z</td> <td>0,08 ÷ 0,35</td> <td>[mm/tooth]</td> </tr> <tr> <td>a_p</td> <td>0,8 ÷ 3,3 (4,3; 9,9; 10,7)</td> <td>[mm]</td> </tr> </table>	f_z	0,08 ÷ 0,35	[mm/tooth]	a_p	0,8 ÷ 3,3 (4,3; 9,9; 10,7)	[mm]				
f_z	0,08 ÷ 0,35	[mm/tooth]														
a_p	0,8 ÷ 3,3 (4,3; 9,9; 10,7)	[mm]														
Heavy	■	■	■	■	■											



OEHT 06-FA

Geometry	Photo	Group of machined materials						Operating diagram	Description	Used for inserts: OEHT 0604AEFR-FA						
		Milling	P	M	K	N	S				H					
Cutting edge profile		Light	■	■	■	■	■		<ul style="list-style-type: none"> - Sharp geometry with a positive rake angle - Minimal cutting edge roundness - Suitable for milling group N non-ferrous materials - Designed especially for light and medium machining - It may be possible to use all eight cutting edges depending on the depth of cut 	Range of machining conditions: Unit: <table border="1"> <tr> <td>f_z</td> <td>0,08 ÷ 0,20</td> <td>[mm/tooth]</td> </tr> <tr> <td>a_p</td> <td>0,8 ÷ 3,3 (4,3; 9,9; 10,7)</td> <td>[mm]</td> </tr> </table>	f_z	0,08 ÷ 0,20	[mm/tooth]	a_p	0,8 ÷ 3,3 (4,3; 9,9; 10,7)	[mm]
		f_z	0,08 ÷ 0,20	[mm/tooth]												
		a_p	0,8 ÷ 3,3 (4,3; 9,9; 10,7)	[mm]												
Medium	■	■	■	■	■	<table border="1"> <tr> <td>f_z</td> <td>0,08 ÷ 0,20</td> <td>[mm/tooth]</td> </tr> <tr> <td>a_p</td> <td>0,8 ÷ 3,3 (4,3; 9,9; 10,7)</td> <td>[mm]</td> </tr> </table>	f_z	0,08 ÷ 0,20	[mm/tooth]	a_p	0,8 ÷ 3,3 (4,3; 9,9; 10,7)	[mm]				
f_z	0,08 ÷ 0,20	[mm/tooth]														
a_p	0,8 ÷ 3,3 (4,3; 9,9; 10,7)	[mm]														
Heavy	■	■	■	■	■											

■ Main application area ■ Other applications □ Potential applications

GEOMETRY OF CUTTING INSERTS FOR MILLING

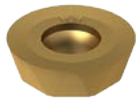
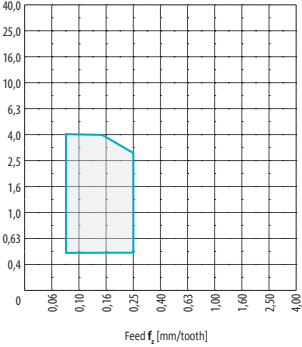
REHT 16-MM

Geometry	Photo	Group of machined materials						Operating diagram	Description	Used for inserts: REHT 1604M0EN-MM	
		Milling	P	M	K	N	S				H
REHT 16-MM		Light	■	■	□	■			<ul style="list-style-type: none"> - Geometry with a slightly positive rake angle - Suitable for machining material groups M, S and P, and potentially N - Designed especially for light and medium machining - Optional range for OEHT 0604 inserts 	Range of machining conditions: Unit:	
	Cutting edge profile	Medium	■	■	□	■					f_z 0,08 ÷ 0,25 [mm/tooth]
		Heavy									a_p 0,5 ÷ 4,0 [mm]

REHT 16-M

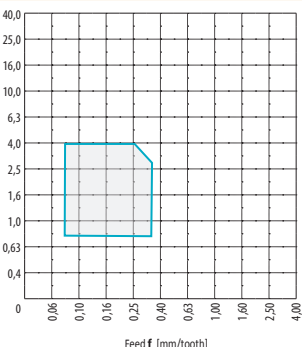
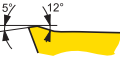
Geometry	Photo	Group of machined materials						Operating diagram	Description	Used for inserts: REHT 1604M0SN-M	
		Milling	P	M	K	N	S				H
REHT 16-M		Light	■	■		■			<ul style="list-style-type: none"> - Geometry with a positive rake angle and a narrow peripheral land - Suitable for milling material groups M, P and S - Designed especially for light and medium machining - Optional range for OEHT 0604 inserts 	Range of machining conditions: Unit:	
	Cutting edge profile	Medium	■	■		■					f_z 0,08 ÷ 0,35 [mm/tooth]
		Heavy									a_p 0,8 ÷ 4,0 [mm]

XEHT 06AESR

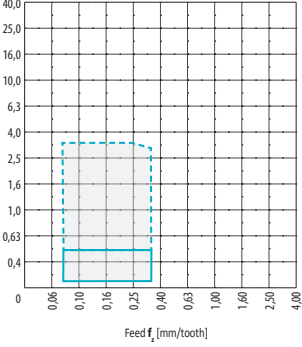
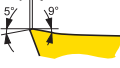
Geometry	Photo	Group of machined materials						Operating diagram	Description	Used for inserts: XEHT 0604AESR	
		Milling	P	M	K	N	S				H
XEHT 06AESR		Light	■	■		□			<ul style="list-style-type: none"> - Smoothing geometry with a slightly positive rake angle - Suitable for milling material groups P, secondary M, and potentially S - Geometry suited to light cutting conditions - Optional range for OEHT 0604 inserts 	Range of machining conditions: Unit:	
	Cutting edge profile	Medium									f_z 0,08 ÷ 0,35 [mm/tooth]
		Heavy									a_p 0,1 ÷ 0,5 (3,3) [mm]

■ Main application area ■ Other applications □ Potential applications

RECOMMENDED APPLICATIONS FOR CYLINDRICAL MILLING CUTTERS WITH HELICAL INSERTS

MILLING TOOLS

MILLING INSERTS

TURNING INSERTS

DRILLING INSERTS

TECHNICAL SECTION

FOR SHOULDER AND SLOT MILLING $a_e > 1/3 D$

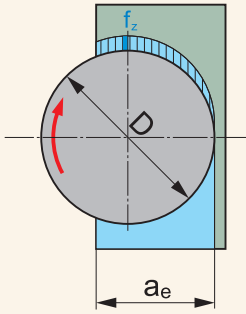

$f_{z\min}$ = minimum feed per tooth [mm.tooth⁻¹]
 $f_{z\max}$ = maximum feed per tooth [mm.tooth⁻¹]
 a_e = width of cut surface [mm]
 a_p = depth of cut [mm]
 D = milling cutter diameter [mm]

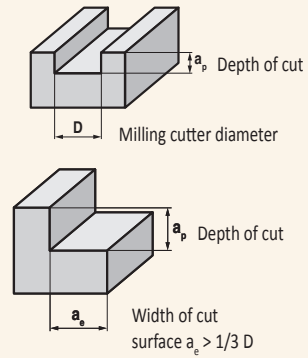

Milling cutter diameter [mm]	Recommended average chip thickness hm [mm]		$a_e = 20$		$a_e = 25$		$a_e = 30$		$a_e = 35$		$a_e = 40$		$a_e = 45$		$a_e = 50$	
			f_{\min}	f_{\max}	f_{\min}	f_{\max}	f_{\min}	f_{\max}	f_{\min}	f_{\max}	f_{\min}	f_{\max}	f_{\min}	f_{\max}	f_{\min}	f_{\max}
50	0,08	0,10	0,14	0,17	0,13	0,16	0,12	0,15	0,11	0,14	0,11	0,14	0,11	0,14	0,11	0,14
63	0,08	0,10			0,14	0,18	0,13	0,16	0,12	0,15	0,12	0,15	0,11	0,14	0,11	0,14
80	0,08	0,10					0,14	0,18	0,13	0,16	0,13	0,16	0,12	0,15	0,12	0,15
100	0,08	0,10							0,15	0,18	0,14	0,17	0,13	0,16	0,13	0,16

Milling cutter diameter [mm]	Recommended average chip thickness hm [mm]		$a_e = 55$		$a_e = 63$		$a_e = 70$		$a_e = 80$		$a_e = 90$		$a_e = 100$	
			f_{\min}	f_{\max}	f_{\min}	f_{\max}	f_{\min}	f_{\max}	f_{\min}	f_{\max}	f_{\min}	f_{\max}	f_{\min}	f_{\max}
50	0,08	0,10												
63	0,08	0,10	0,11	0,14	0,11	0,14								
80	0,08	0,10	0,11	0,14	0,11	0,14	0,11	0,14	0,11	0,14				
100	0,08	0,10	0,12	0,15	0,12	0,15	0,11	0,14	0,11	0,14	0,11	0,14	0,13	0,15

FOR SHOULDER MILLING $a_e < 1/3 D$

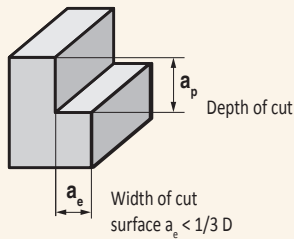
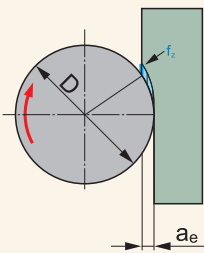

$f_{z\min}$ = minimum feed per tooth [mm.tooth⁻¹]
 $f_{z\max}$ = maximum feed per tooth [mm.tooth⁻¹]
 a_e = width of cut surface [mm]
 a_p = depth of cut [mm]
 D = milling cutter diameter [mm]

Milling cutter diameter [mm]	Recommended average chip thickness hm [mm]		$a_e = 2$		$a_e = 4$		$a_e = 8$		$a_e = 12$		$a_e = 16$		$a_e = 20$		$a_e = 24$		$a_e = 30$	
			f_{\min}	f_{\max}	f_{\min}	f_{\max}	f_{\min}	f_{\max}	f_{\min}	f_{\max}	f_{\min}	f_{\max}	f_{\min}	f_{\max}	f_{\min}	f_{\max}	f_{\min}	f_{\max}
50	0,08	0,10	0,40	0,50	0,29	0,36	0,21	0,26	0,17	0,21	0,15	0,19						
63	0,08	0,10	0,45	0,56	0,32	0,40	0,23	0,29	0,19	0,24	0,17	0,21	0,15	0,19				
80	0,08	0,10	0,51	0,64	0,36	0,45	0,26	0,32	0,21	0,27	0,19	0,23	0,17	0,21	0,15	0,19		
100	0,08	0,10	0,57	0,71	0,40	0,50	0,29	0,36	0,24	0,29	0,21	0,26	0,19	0,23	0,17	0,21	0,15	0,19

i For steels from 200 to 300 HB, we recommend reducing the feed and cutting speed by 15 %. For steels from 300 to 450 HB, we recommend reducing the feed and cutting speed by 30 %. For cast iron group K, the feed and cutting speed can be increased by 20 %.

ADMX/ADEX

MILLING CUTTER MODIFICATION

The body of the milling cutter must be modified when using inserts with a higher radius

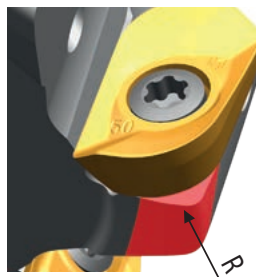

ADMX 07	R
ADMX070220SR-M	1,5
ADMX/ADEX 11	R
ADMX 11T320SR-M	1,0
ADMX 11T325SR-M	1,8
ADMX 11T330SR-M	1,8
ADEX 11T308SR-HF	1,4*
ADMX/ADEX 16	R
ADMX 160630SR-M	2,5
ADMX 160632SR-M	2,5
ADMX 160640SR-M	4,0
ADMX 160650SR-M	4,5
ADEX 160612SR-HF	3,0*

*For milling cutter diameters up to 80 mm

ADEX .. -HF

INFORMATION FOR CNC PROGRAMMING

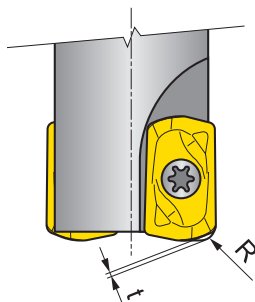

Insert	R	t
	[mm]	[mm]
ADEX 11T308SR-HF	1,42	0,35
ADEX 160612SR-HF	2,59	0,56

OEHT 06

NUMBER OF USABLE CUTTING EDGES OF THE OEHT 06 INSERTS BASED ON THE DEPTH OF CUT

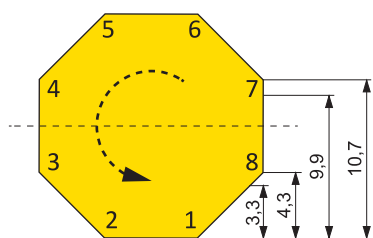

Depth of cut a_p [mm]	Number of cutting edges
up to 3,3	8
up to 4,3	7
up to 9,9	4
up to 10,7	2

ADEX 11T308SR-HF
ADEX 160612SR-HF
RAMPING
SHELL CUTTERS BODIES

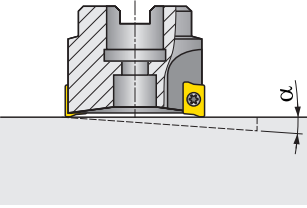
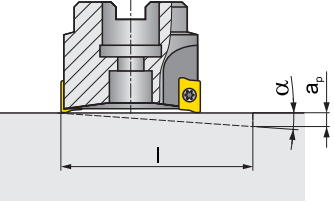
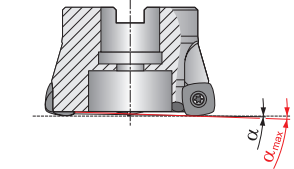
	Tool	Insert	Milling cutter diameter	α_{max}	a_p/l
			[mm]	[°]	[mm]
	S90AD11E	ADEX 11T308SR-HF	40	2,9** (0,6)*	0,6/57
			50	2,0** (0,6)*	0,6/86
			63	1,4** (0,2)*	0,6/100
			80	0,9** (0,15)*	0,6/100
			100	0,6** (0)*	-
			125	0,3** (0)*	-
	S90AD16E	ADEX 160612SR-HF	40	1,2** (4,5)*	1,3/65
			50	0,8** (3,0)*	1,3/100
			63	0,5** (2,0)*	0,8/100
			80	0,4** (1,5)*	0,6/100

END MILLING CUTTERS

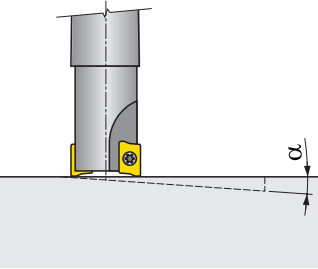
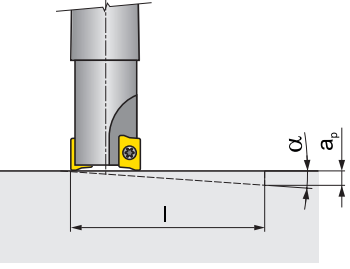
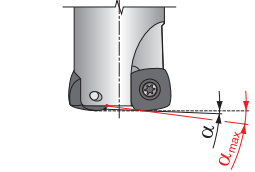
	Tool	Insert	Milling cutter diameter	α_{max}	a_p/l
			[mm]	[°]	[mm]
	SAD11E	ADEX 11T308SR-HF	16	5,4** (2,8)*	0,6/12
			20	4,2** (2,1)*	0,6/16
			25	3,0** (1,2)*	0,6/28
			32	3,1** (0,7)*	0,6/49
	SAD16E	ADEX 160612SR-HF	25	4,0** (8,0)*	1,3/19
			32	2,0** (7,5)*	1,3/38
			40	1,2** (4,5)*	1,3/65

* Valid for conventional milling
 ** Can be used for HFC geometry

ADEX 11T308SR-HF
ADEX 160612SR-HF

HELICAL INTERPOLATION MILLING

SHELL CUTTERS BODIES

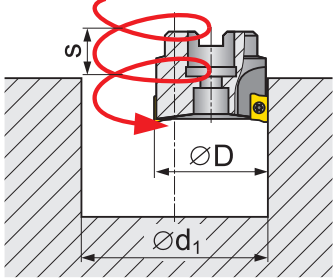

Tool	Insert	Milling cutter diameter	d_{min}	d_{max}	S_{max}
		[mm]			
S90AD11E	ADEX 11T308SR-HF	40	68,5	78	0,6
		50	88,5	98	0,6
		63	114,5	124	0,6
		80	148,5	158	0,6
		100	188	198	-
		125	238,5	248	-
S90AD16E	ADEX 160612SR-HF	40	72	-	1,3
			-	78	1,3
		50	92	-	1,3
			-	98	1,3
		63	118	-	1,3
			-	124	1,3
		80	136	-	1,3
			-	158	1,3

END MILLING CUTTERS

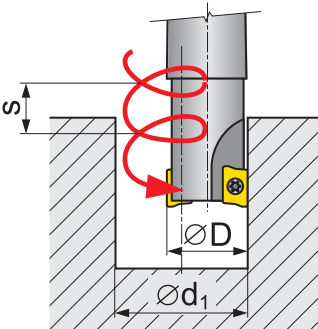

Tool	Insert	Milling cutter diameter	d_{min}	d_{max}	S_{max}
		[mm]			
SAD11E	ADEX 11T308SR-HF	16	21	30	0,6
		20	29	38	0,6
		25	39	48	0,6
		32	53	62	0,6
SAD16E	ADEX 160612SR-HF	25	42	-	1,3
			-	48	1,3
		32	55	-	1,3
			-	62	1,3
		40	72	-	1,3
			-	78	1,3

OEHT 0604...
REHT 1604..

RAMPING

SHELL CUTTERS BODIES

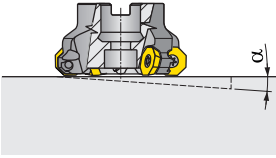
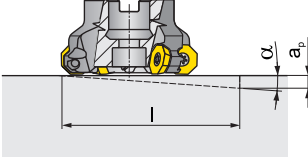
	Tool	Insert	Milling cutter diameter	α_{max}	a_p / l
			[mm]	[°]	[mm]
 	S450E06Z	OEHT 0604 ...	50	4,9	8,6/100
			56	4,2	7,3/100
			63	3,6	6,3/100
			70	3,1	5,4/100
			80	2,6	4,5/100
			90	2,3	4/100
			100	2	3,5/100
		REHT 1604....	125	1,5	2,6/100
			50	4,6	8/99,4
			56	4	7/100
			63	3	5,2/100
			70	2,7	4,7/100
			80	2,2	3,8/100
			90	2	3,5/100

HELICAL INTERPOLATION MILLING

SHELL CUTTERS BODIES

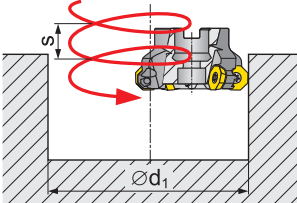
	Tool	Insert	Milling cutter diameter	d_{min}	d_{max}	s_{max}	
				[mm]			
	S450E06Z	OEHT 0604 ...	50	92	119	6,5	
			56	104	131	6,5	
			63	118	145	6,5	
			70	132	159	6,5	
			80	152	180	6,5	
			90	172	199	6,5	
			100	192	219	6,5	
		REHT 1604....	125	242	269	6,5	
			50	92	119	6,5	
			56	104	131	6,5	
			63	118	145	6,5	
			70	132	159	6,5	
			80	152	180	6,5	
			90	172	199	6,5	
			100	192	219	6,5	
			125	242	269	6,5	

OEHT 0604...
REHT 1604..

PROGRESSIVE PLUNGING

SHELL CUTTERS BODIES

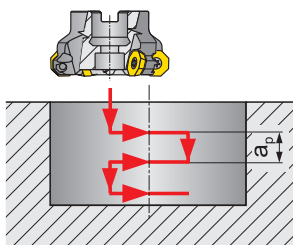

Tool	Insert	Milling cutter diameter	a_{pmax}
		[mm]	
S450E06Z	OEHT 0604 ...	50 ÷ 200	3,1
	REHT 1604....	50 ÷ 200	3,1

MILLING TOOLS

MILLING INSERTS

TURNING INSERTS

DRILLING INSERTS

TECHNICAL SECTION

TECHNICAL INFORMATION - MILLING

SURFACE QUALITY

INSERT TYPE	ADMX 16 LNGU 16 TBMR 27	PNMQ 13 PNMU 13	LNEM 16 SBMR 22 SEEN 15 SEER 15 SPGN 25	ADKX 15 APKT 16 SDMT 12	ADKX 15 LNGX 12 ODMT 06 ODMW 06 PDKT 09 PDMT 09 PDMW 09 SEEN 12 SEER 12 SEET 12 SEEW 12 SNMT 12	ODMT 05 OFKR 07 SOMT09-M SOMT09-MI SOMT09-P SPKN 12 SPKN 15 SPKR 12 SPKR 15	ADMX 11 HNEF 09-F HNGX 09 SEMT 09 SNHF 12 SNHF 15 SNHN 12 TPKN 16 TPKN 22 TPKR 16 TPKR 22	OEHT 06
Width of wiper edge (segment) a [mm]	3,2	2,8	2,5	2,2	2,0	1,6	1,4	1,3
Number of milling cutter teeth	$\max f_z$							
1	2,56	2,24	2,00	1,76	1,60	1,28	1,12	1,09
2	1,28	1,12	1,00	0,88	0,80	0,64	0,56	0,54
3	0,85	0,75	0,67	0,59	0,53	0,43	0,37	0,36
4	0,64	0,56	0,50	0,44	0,40	0,32	0,28	0,27
5	0,51	0,45	0,40	0,35	0,32	0,26	0,22	0,22
6	0,43	0,37	0,33	0,29	0,27	0,21	0,19	0,18
7	0,37	0,32	0,29	0,25	0,23	0,18	0,16	0,16
8	0,32	0,28	0,25	0,22	0,20	0,16	0,14	0,14
9	0,28	0,25	0,22	0,20	0,18	0,14	0,12	0,12
10	0,26	0,22	0,20	0,18	0,16	0,13	0,11	0,11
11	0,23	0,20	0,18	0,16	0,15	0,12	0,10	0,10
12	0,21	0,19	0,17	0,15	0,13	0,11	0,09	0,09
13	0,20	0,17	0,15	0,14	0,12	0,10	0,09	0,08
14	0,18	0,16	0,14	0,13	0,11	0,09	0,08	0,08
15	0,17	0,15	0,13	0,12	0,11	0,09	0,07	0,07
16	0,16	0,14	0,13	0,11	0,10	0,08	0,07	0,07
17	0,15	0,13	0,12	0,10	0,09	0,08	0,07	0,06
18	0,14	0,12	0,11	0,10	0,09	0,07	0,06	0,06

MILLING TOOLS

MILLING INSERTS

TURNING INSERTS

DRILLING INSERTS

TECHNICAL SECTION

MILLING

CHOICE OF INITIAL CUTTING CONDITIONS

- Specify the cutting conditions (light, medium or heavy duty milling).

Light duty milling – one interruption per revolution, good cutting conditions, workpiece with pre-machined surface or surface of rolled blanks and forgings without major defects or roughness in depth of cut $a_p \leq 2$ mm.

Medium duty milling – one or two interruptions per revolution. Not possible to choose the optimal cutting conditions. Surface of workpiece with skin of rolled blanks, forgings and castings or with minor defects in depth of cut $a_p = 2 - 4$ mm.

Heavy duty milling – multiple interruptions per revolution. Unfavourable cutting conditions (negative rake of working angle). Surface of workpiece with rough skin of castings, forgings and burnt parts. Variable depth of cut $a_p = 3 - 10$ mm.

Feed range for each group dependent on cutting conditions. At the worsening of cutting conditions, it is necessary to reduce the upper limit of feed.
- In accordance with tables 1a – 6a page 144 - 154, choose the suitable combination of grade and cutting edge with regard to the **machined material and the pre-chosen cutting insert and tool**. There are three possible solutions for each group of machined materials.
- Use tables 1b – 6b on pages 145 - 155 to choose the initial cutting speed with regard to type of tool or cutting insert, cutting conditions and milling grade.
- In tables 1b – 6b on pages 145 - 155 are the speed factors for recalculating the cutting speed with regard to the machine's condition, the tool and cutting edge service life, and the hardness of the workpiece material. If needed, however, the following can be used to calculate the actual speed:

$$v_c = v_{30} \cdot k_{VX} \cdot k_{VT} \cdot k_{VHB} \cdot (k_{VM})$$

Note: The cutting speed calculated in this way is the initial value (default), which is used to establish the basic cutting speed for a given operation. Variations in the machinability of the workpiece material are the main reason for needing to adjust the cutting speed.

Table 1a

CHOOSING THE MILLING TOOL AND THE INITIAL MACHINING CONDITIONS

Group	Tool type													Insert			Operating conditions of milling						
1														HNGX 06 HNGX 09 HNCF 0805..... SNMT 1205AZ	M8315 S(E) 8215 M8310 S 8230 S(E)	I II III	I II III	M9325 S 8215 M8310 S 8230 S	I II III	M9340 S 8230 S 8240 S	I II III	M9340 S 8230 S 8240 S	
														OBHT 06 ODMT(W) 05...ODMT(W) 06 SEWT 09 SPEW, SDEX 09... TCMT 0913... TCMT 1613 XPH1 1604...	8215 M9315 S(E) 8230 S(E) 8230 S(E)	I II III	I II III	8240 M9325 S 8230 S 8240 S	I II III	8240 M9340 S 8240 S 8240 S	I II III	8240 M9340 S 8240 S 8240 S	
3														ADMX ADEX 11T3... ADMX ADEX 1606... APET 1003PD APET APKT 1604... LINGX 12...LINGU 16... SCMT 09T30...SDMT 12050SR... ADMX 15T3...XOEN 12 T3...	8215 M9315 S(E) 8215 S(E) 8230 S(E)	I II III	I II III	8230 M9325 S 8230 S 8240 S	I II III	8240 M9340 S, P 8240 S, P 8240 S, P	I II III	8240 M9340 S, P 8240 S, P 8240 S, P	
														SCXR 09T3...SCXR 12T3...RPHX 0504... RPHX R0GT R0HT 07T1...0702... RPHX R0GT R0HT 10T1... RPHX R0GT R0HT 12T1... RPHX R0GT R0HT 1604... RPHX R0GT R0HT 1604... RCMT 1204...RCMT 1606...RCMT 2006...ZDCW 07... ZDCW 09...ZDCW 12... PD...09S5...R0HT 16...R0HT 15	7000 S 7005 E(S) 7215 S(E) M8310 S 8215 E(S) 8215 E(S)	I II III	I II III	7040 S 7230 S M8345 S 8240 S 8240 S	I II III	7040 S 7230 S M8345 S 8240 S 8240 S			
4														XP xKER-FM ZPxKER*x VCGT Z2030 RC, RCA, LC	M8310 S 7215 S	I II	I II	8230 M8325 S 7230 S	I II	M8345 S 8240 S	I II	M8345 S 8240 S	
														SN...11 (12) CN XN...1205	8215 E(S) 8230 S(E)	I II	I II	8230 S 8230 S(E)	I II	8240 S 8240 S	I II	8240 S 8240 S	
5														ADMX ADEX 1606... LNFT 1606ISR...SNGX 1305 SNGX 13052PN APET(W) 150412 SPET(W) 120404D ADMX ADEX 11T3... SDMX 1205 CCMX 09/3... CCMX 09T3...CCMX 09T3...	8230 M9315 S(E) 8230 S	I II	I II	8230 M9325 S 8230 S	I II	8240 M9340 S 8240 S	I II	8240 M9340 S 8240 S	
														SPUN, SPGN Z506... SBMR 22 PNUU1308...	8036T S 8230 S 8215 S	I II III	I II III	8240 S 8240 S 8240 S	I II III	8240 S 8240 S 8240 S	I II III	8240 S 8240 S 8240 S	
6														SPUN Z506... TBMR Z7...	8036T S 8230 S	I II	I II	8240 S 8240 S	I II	8240 S 8240 S	I II	8240 S 8240 S	
															8036T S 8230 S	I II	I II	8240 S 8240 S	I II	8240 S 8240 S	I II	8240 S 8240 S	
7															8036T S 8230 S	I II	I II	8240 S 8240 S	I II	8240 S 8240 S	I II	8240 S 8240 S	
															8036T S 8230 S	I II	I II	8240 S 8240 S	I II	8240 S 8240 S	I II	8240 S 8240 S	
8															8036T S 8230 S	I II	I II	8240 S 8240 S	I II	8240 S 8240 S	I II	8240 S 8240 S	
															8036T S 8230 S	I II	I II	8240 S 8240 S	I II	8240 S 8240 S	I II	8240 S 8240 S	
9															8036T S 8230 S	I II	I II	8240 S 8240 S	I II	8240 S 8240 S	I II	8240 S 8240 S	
															8036T S 8230 S	I II	I II	8240 S 8240 S	I II	8240 S 8240 S	I II	8240 S 8240 S	

Table 1b

CHOOSING THE MILLING TOOL AND THE INITIAL MACHINING CONDITIONS

Group	P													ADJUSTMENT v_c									
	Cutting conditions		Range of starting feeds										Subgroup	P1	P2	P3	P4						
1	Light	0.10	0.10	0.30	435	M5315	M5326	M9315	M9325	M9340	5040	M8325	M8345	8215	8230	M8310	M8326	M8340	M8346	7205	7215	7230	
	Medium	0.10	0.25	405	390	370	260	270	350	320	365	330	285	305	280	330	285	285	285	285	-	-	-
	Heavy	0.10	0.20	370	350	325	255	240	260	240	-	-	245	260	240	-	-	245	245	-	-	-	-
	Light	0.10	0.35	405	400	395	240	240	340	310	-	-	310	340	310	-	-	310	310	-	-	-	-
	Medium	0.10	0.30	370	360	350	230	230	295	270	-	-	275	295	270	-	-	275	275	-	-	-	-
	Heavy	0.10	0.20	355	335	310	245	245	250	230	-	-	235	250	230	-	-	235	235	-	-	-	-
	Light	0.10	0.30	380	370	360	235	235	305	280	-	-	280	305	280	-	-	280	280	-	-	-	-
	Medium	0.10	0.25	365	350	330	235	235	275	255	-	-	260	275	255	-	-	260	260	-	-	-	-
	Heavy	0.10	0.15	345	325	300	235	235	190	225	-	-	230	240	225	-	-	230	230	-	-	-	-
2	Light	-	-	-	-	-	-	420	300	260	265	265	265	350	320	380	-	325	-	315	290	245	
	Medium	-	-	-	-	-	-	385	275	240	245	245	320	295	350	-	300	-	290	265	225		
	Heavy	-	-	-	-	-	-	350	230	215	220	220	295	270	-	275	-	275	-	260	240	205	
	Light	-	-	-	-	-	-	-	-	-	-	-	245	295	345	-	300	-	300	-	310	265	
	Medium	-	-	-	-	-	-	-	-	-	-	220	270	315	-	275	-	275	-	295	250		
	Heavy	-	-	-	-	-	-	-	200	245	-	-	200	245	-	245	-	245	-	280	235		
	Light	0.10	0.50	-	-	-	-	-	290	270	-	-	270	270	-	270	-	270	-	270	-	-	
	Medium	0.10	0.30	-	-	-	-	-	265	245	-	-	245	245	-	245	-	245	-	245	-	-	
	Heavy	0.10	0.20	-	-	-	-	-	-	220	-	-	220	220	-	220	-	220	-	220	-	-	
3	Light	0.10	0.25	250	235	220	165	220	180	170	140	140	140	180	170	-	170	-	170	-	-	-	
	Medium	0.10	0.20	220	205	185	150	150	150	140	-	120	120	150	140	-	140	-	140	-	-	-	
	Heavy	0.08	0.15	-	-	-	140	140	95	110	-	115	115	110	-	-	-	115	-	115	-	-	
	Light	0.25	0.60	-	280	-	-	-	190	250	-	215	180	215	-	180	-	180	-	180	-	-	
	Medium	0.25	0.50	-	225	-	-	-	155	195	-	175	140	175	-	140	-	140	-	140	-	-	
	Heavy	0.25	0.40	-	200	-	-	-	135	170	-	155	120	155	-	120	-	120	-	120	-	-	
	Light	0.20	0.60	-	235	-	-	-	-	-	-	180	150	180	-	150	-	150	-	150	-	-	
	Medium	0.20	0.50	-	185	-	-	-	-	-	-	145	115	145	-	115	-	115	-	115	-	-	
	Heavy	0.20	0.40	-	165	-	-	-	-	-	-	125	100	125	-	100	-	100	-	100	-	-	
4	Light	-	-	-	-	-	-	-	-	-	-	-	-	-	-	-	-	-	-	-	-	-	
	Medium	-	-	-	-	-	-	-	-	-	-	-	-	-	-	-	-	-	-	-	-	-	
	Heavy	-	-	-	-	-	-	-	-	-	-	-	-	-	-	-	-	-	-	-	-	-	
	Light	0.10	0.50	-	-	-	-	-	290	270	-	-	270	270	-	270	-	270	-	270	-	-	
	Medium	0.10	0.30	-	-	-	-	-	265	245	-	-	245	245	-	245	-	245	-	245	-	-	
	Heavy	0.10	0.20	-	-	-	-	-	-	220	-	-	220	220	-	220	-	220	-	220	-	-	
	Light	0.10	0.25	250	235	220	165	220	180	170	140	140	140	180	170	-	170	-	170	-	-	-	
	Medium	0.10	0.20	220	205	185	150	150	150	140	-	120	120	150	140	-	140	-	140	-	-	-	
	Heavy	0.08	0.15	-	-	-	140	140	95	110	-	115	115	110	-	-	-	115	-	115	-	-	
5	Light	0.25	0.60	-	280	-	-	-	190	250	-	215	180	215	-	180	-	180	-	180	-	-	
	Medium	0.25	0.50	-	225	-	-	-	155	195	-	175	140	175	-	140	-	140	-	140	-	-	
	Heavy	0.25	0.40	-	200	-	-	-	135	170	-	155	120	155	-	120	-	120	-	120	-	-	
	Light	0.20	0.60	-	235	-	-	-	-	-	-	180	150	180	-	150	-	150	-	150	-	-	
	Medium	0.20	0.50	-	185	-	-	-	-	-	-	145	115	145	-	115	-	115	-	115	-	-	
	Heavy	0.20	0.40	-	165	-	-	-	-	-	-	125	100	125	-	100	-	100	-	100	-	-	
	Light	0.10	0.50	-	-	-	-	-	290	270	-	-	270	270	-	270	-	270	-	270	-	-	
	Medium	0.10	0.30	-	-	-	-	-	265	245	-	-	245	245	-	245	-	245	-	245	-	-	
	Heavy	0.10	0.20	-	-	-	-	-	-	220	-	-	220	220	-	220	-	220	-	220	-	-	
6	Light	0.10	0.25	250	235	220	165	220	180	170	140	140	140	180	170	-	170	-	170	-	-	-	
	Medium	0.10	0.20	220	205	185	150	150	150	140	-	120	120	150	140	-	140	-	140	-	-	-	
	Heavy	0.10	0.20	-	-	-	140	140	95	110	-	115	115	110	-	-	-	115	-	115	-	-	
	Light	0.25	0.60	-	280	-	-	-	190	250	-	215	180	215	-	180	-	180	-	180	-	-	
	Medium	0.25	0.50	-	225	-	-	-	155	195	-	175	140	175	-	140	-	140	-	140	-	-	
	Heavy	0.25	0.40	-	200	-	-	-	135	170	-	155	120	155	-	120	-	120	-	120	-	-	
	Light	0.20	0.60	-	235	-	-	-	-	-	-	180	150	180	-	150	-	150	-	150	-	-	
	Medium	0.20	0.50	-	185	-	-	-	-	-	-	145	115	145	-	115	-	115	-	115	-	-	
	Heavy	0.20	0.40	-	165	-	-	-	-	-	-	125	100	125	-	100	-	100	-	100	-	-	
7	Light	0.10	0.50	-	-	-	-	-	-	-	-	-	-	-	-	-	-	-	-	-	-	-	
	Medium	0.10	0.30	-	-	-	-	-	-	-	-	-	-	-	-	-	-	-	-	-	-	-	
	Heavy	0.10	0.20	-	-	-	-	-	-	-	-	-	-	-	-	-	-	-	-	-	-	-	
	Light	0.25	0.60	-	280	-	-	-	190	250	-	215	180	215	-	180	-	180	-	180	-	-	
	Medium	0.25	0.50	-	225	-	-	-	155	195	-	175	140	175	-	140	-	140	-	140	-	-	
	Heavy	0.25	0.40	-	200	-	-	-	135	170	-	155	120	155	-	120	-	120	-	120	-	-	
	Light	0.20	0.60	-	235	-	-	-	-	-	-	180	150	180	-	150	-	150	-	150	-	-	
	Medium	0.20	0.50	-	185	-	-	-	-	-	-	145	115	145	-	115	-	115	-	115	-	-	
	Heavy	0.20	0.40	-	165	-	-	-	-	-	-	125	100	125	-	100	-	100	-	100	-	-	
8	Light	0.10	0.50	-	-	-	-	-	-	-	-	-	-	-	-	-	-	-	-	-	-	-	
	Medium	0.10	0.30	-	-	-	-	-	-	-	-	-	-	-	-	-	-	-	-	-	-	-	
	Heavy	0.10	0.20	-	-	-	-	-	-	-	-	-	-	-	-	-	-	-	-	-	-	-	
	Light	0.25	0.60	-	280	-	-	-	190	250	-	215	180	215	-	180	-	180	-	180	-	-	
	Medium	0.25	0.50	-	225	-	-	-	155	195	-	175	140	175	-	140	-	140	-	140	-	-	
	Heavy	0.25	0.40	-	200	-	-	-	135	170	-	155	120	155	-	120	-	120	-	120	-	-	
	Light	0.20	0.60	-	235	-	-	-	-	-	-	180	150	180	-	150	-	150	-	150	-	-	
	Medium	0.2																					

Table 2a

CHOOSING THE MILLING TOOL AND THE INITIAL MACHINING CONDITIONS

Group	M												Operating conditions of milling					
	Tool type												Light	Medium	Heavy			
	Insert																	
1														M9325 S(E)	I	8215 S	I	M9340 S
														8215 (M8310) S(E)	II	8230 S	II	8230 S
														M8240 S(E)	III	8230 S	III	8240 S
2														8215 S(E)	I	8230 M9325 S	I	8240 M9340 S
														8230 S(E)	II	8230 S	II	8240 S
														8230 S(E)	III	8240 S	III	8240 S
3														8215 S(E)	I	8230 M9325 S	I	8240 M9340 S.P
														8215 S(E)	II	8230 S	II	8240 S.P
														8230 S(E)	III	8240 S	III	8240 S.P
4														7010 S(E)	I	7025 S	I	7040 S
														8215 S(E)	II	8230 S	II	8240 S
														8215 S(E)	III	8240 S	III	8240 S
5														8215 S(E)	I	8230 M8310 S	I	8240 M8345 S
														8230 S(E)	II	8230 S	II	8240 S
														8230 S(E)	III	8240 S	III	8240 S
6														8215 S(E)	I	8230 S	I	8240 S
														8230 S(E)	II	8240 S	II	8240 S
														8230 S(E)	III	8240 S	III	8240 S
7														8230 S(E)	I	8230 M8325 S	I	8240 M8345 S
														8230 S	II	8230 S	II	8240 S
														8230 S	III	8240 S	III	8240 S
8														8026T S	I	8240 S	I	8240 S
														8230 S	II	8230 S	II	8240 S
														8230 S	III	8240 S	III	8240 S
9														8026T S	I	8240 S	I	8240 S
														8230 S	II	8230 S	II	8240 S
														8230 S	III	8240 S	III	8240 S

Table 2b

CHOOSING THE MILLING TOOL AND THE INITIAL MACHINING CONDITIONS

Group	M										ADJUSTMENT v_c										
	Cutting conditions										Subgroup	M1	M2	M3	M4						
	Range of starting feeds										Adjustment for workpiece hardness										
											Hardness [HB]	KV_{HPS1}	KV_{HPS2}	KV_{HPS3}	KV_{HPS4}						
1	Light	0.10	0.30	245	-	160	-	210	190	215	-	195	-	-	-	-	120	1,35	1,31	1,24	1,15
	Medium	0.10	0.25	220	-	155	-	180	165	195	-	170	-	-	-	-	140	1,28	1,24	1,18	1,10
	Heavy	0.10	0.20	195	-	150	-	155	140	-	-	145	-	-	-	-	160	1,22	1,18	1,12	1,04
2	Light	0.10	0.35	235	-	140	-	200	185	-	185	-	-	-	-	-	180	1,14	1,11	1,05	0,98
	Medium	0.10	0.30	210	-	135	-	175	160	-	165	-	-	-	-	-	200	1,09	1,06	1,00	0,93
	Heavy	0.10	0.20	185	-	145	-	150	135	-	135	-	-	-	-	-	220	1,03	1,00	0,95	0,88
3	Light	-	-	250	-	180	155	210	190	225	-	195	-	185	170	145	240	0,98	0,95	0,90	0,84
	Medium	-	-	230	-	165	140	190	175	210	-	180	-	170	155	135	260	0,93	0,91	0,86	0,80
	Heavy	-	-	210	-	135	125	175	160	-	165	-	165	-	140	120	280	0,89	0,87	0,82	0,76
4	Light	-	-	-	-	-	-	145	-	175	205	180	-	-	-	-	300	0,87	0,84	0,80	0,74
	Medium	-	-	-	-	-	130	-	160	185	165	-	-	-	-	-	320	0,84	0,81	0,77	0,72
	Heavy	-	-	-	-	-	120	-	145	-	145	-	-	-	-	-	340	0,80	0,78	0,74	0,69
5	Light	0.10	0.50	-	-	-	-	170	160	-	160	-	-	-	-	-	360	0,77	0,75	0,71	0,66
	Medium	0.10	0.30	-	-	-	-	155	145	-	145	-	-	-	-	-	375	0,74	0,72	0,68	0,63
	Heavy	0.10	0.20	-	-	-	-	130	100	-	100	-	-	-	-	-	Adjustment for durability (general machining)				
6	Light	0.10	0.25	130	-	95	-	80	105	100	-	100	-	-	-	-	Durability [min]	k_{vc}			1,23
	Medium	0.10	0.30	-	-	-	-	155	145	-	145	-	-	-	-	-	15				1,23
	Heavy	0.10	0.20	-	-	-	-	-	130	-	130	-	-	-	-	-	20				1,13
7	Light	0.10	0.20	110	-	90	-	70	90	80	-	80	-	-	-	-	30				1,00
	Medium	0.10	0.20	90	-	80	-	55	-	65	-	65	-	-	-	-	45				0,89
	Heavy	0.08	0.15	90	-	80	-	55	-	65	-	65	-	-	-	-	60				0,81
8	Light	0.25	0.60	-	-	100	-	110	-	150	-	125	-	105	-	-	90				0,72
	Medium	0.25	0.50	-	-	80	-	90	-	115	-	105	-	80	-	-	Adjustment for durability (heavy roughing)				
	Heavy	0.25	0.40	-	-	70	-	80	-	100	-	90	-	70	-	-	Durability [min]	k_{vc}			1,23
9	Light	0.20	0.60	-	-	-	-	-	-	-	-	105	-	105	-	-	30				1,00
	Medium	0.20	0.50	-	-	-	-	-	-	-	-	85	-	85	-	-	60				0,89
	Heavy	0.20	0.40	-	-	-	-	-	-	-	-	75	-	75	-	-	120				0,81
Adjustment coefficient k_{vc}											Skin of forging and casting				0,70 - 0,90						
											Machine in good condition				1,05 - 1,20						
											Machine in poor condition				0,85 - 0,95						

Table 3a

CHOOSING THE MILLING TOOL AND THE INITIAL MACHINING CONDITIONS

Group	Tool type										Insert	Operating conditions of milling			
	1	2	3	4	5	6	7	8	9	10		Light	Medium	Heavy	
1											HMGX 06 HMGX 09 HMGX 09S..... SMTS1205AZ	I	M9315 S	M9315 S	M9325 S
2											CBMT 06 ODMT(W)05...ODMT(W)06 SDPW...SDBX09... SOMT0913... TCMT1313... XPH1304...	I	8230 M9315 S	8230 M9315 S	8240 M9325 S
3											ADMX.ADEX11T3... ADMX.ADEX1606... APKT100P0... APET.APKT1604... LNGX12...LNGU16... SOMT09130...SOMT120508SR... ADMX.K5T3...XOFEN12T3...	I	8230 M9315 S	8230 M9315 S	8240 M9325 S, P
4											SEKRO073...SEKRO12T3... ROBK.R0GT.R0MT.DTT3... ROBK.R0GT.R0MT.DTT3... ROBK.R0GT.R0MT.DTT3... ROBK.R0GT.R0MT.DTT3... ROBK.R0GT.R0MT.DTT3... RCMT1204...RCMT1606...RCMT2006...ZDCW 07, ZTCW09...Z0BW 12... PD...0905...REHT16...RFT15	I	7000 7205 E(S)	7005 7215 E(S)	7040 7230 M8325 E(S)
5											XP.XKER-FM ZP.XKER-KK VCGT.Z20S30 RC.RCA.LC	I	M8310 8230 7215	M8325 7230	M8325 7230
6											SN...11 (12) CN XN...1205	I	8215 E(S)	8230 S(E)	8240
7											ADMX.ADEX1606... LNFT16066SR...SNGX1305 SNGX13052PN APFT(W)150412SPT(W)1204AD ADMX.ADEX11T3... SDMK1205 CCMX06B... CCMX08T3...CCMX08T3...	I	8230 M9315 S(E)	8230 M9315 S(E)	8240 M9325 S
8											SPUN.SP6N.Z506... SBMK.Z2 PNUU1308...	I	8026T S	8026T S	8240 S
9											SPUN.Z506... TBMK.Z7...	I	8026T S	8026T S	8240 S
												I	-	-	-
												I	-	-	-
												I	-	-	-

Table 3b

CHOOSING THE MILLING TOOL AND THE INITIAL MACHINING CONDITIONS

Group	K													K				
	Cutting conditions	Range of starting feeds	M5315	M5326	M9315	M9325	5040	M8325	8215	8230	M8310	M8326	M8340	M8346	7205	7215	7230	H7
			M5315	M5326	M9315	M9325	5040	M8325	8215	8230	M8310	M8326	M8340	M8346	7205	7215	7230	H7
1	Light	0.10	0.30	410	-	400	385	-	330	300	345	-	305	-	-	-	-	-
	Medium	0.10	0.25	380	-	370	350	-	285	265	310	-	270	-	-	-	-	-
	Heavy	0.10	0.20	350	-	330	305	-	245	225	-	-	230	-	-	-	-	-
2	Light	0.10	0.35	380	-	380	375	-	320	290	-	-	290	-	-	-	-	120
	Medium	0.10	0.30	350	-	340	330	-	280	255	-	-	260	-	-	-	-	105
	Heavy	0.10	0.20	335	-	315	290	-	235	215	-	-	220	-	-	-	-	-
3	Light	0.10	0.30	360	-	350	340	-	285	265	-	-	265	-	-	-	-	105
	Medium	0.10	0.25	345	-	330	310	-	260	240	-	-	245	-	-	-	-	100
	Heavy	0.10	0.15	325	-	305	285	-	225	210	-	-	215	-	-	-	-	-
4	Light	-	-	-	-	-	395	245	330	300	360	-	305	-	295	275	230	125
	Medium	-	-	-	-	-	365	225	300	280	330	-	285	-	275	250	210	115
	Heavy	-	-	-	-	-	330	200	280	255	-	260	-	245	225	190	-	-
5	Light	-	-	-	-	-	-	-	-	280	325	-	285	-	-	290	250	-
	Medium	-	-	-	-	-	-	-	-	255	295	-	260	-	-	280	235	-
	Heavy	-	-	-	-	-	-	-	-	230	-	-	230	-	-	265	220	-
6	Light	0.10	0.50	-	-	-	-	-	275	255	-	-	255	-	-	-	-	-
	Medium	0.10	0.30	-	-	-	-	-	250	230	-	-	230	-	-	-	-	-
	Heavy	0.10	0.20	-	-	-	-	-	-	205	-	-	205	-	-	-	-	-
7	Light	0.10	0.25	235	-	220	205	-	130	170	160	-	160	-	-	-	-	65
	Medium	0.10	0.20	205	-	190	175	-	110	140	130	-	130	-	-	-	-	55
	Heavy	0.08	0.15	-	-	-	140	-	-	100	-	-	105	-	-	-	-	-
8	Light	0.25	0.60	-	-	-	-	160	-	235	-	200	-	-	-	-	-	-
	Medium	0.25	0.50	-	-	-	-	130	-	185	-	165	-	-	-	-	-	-
	Heavy	0.25	0.40	-	-	-	-	110	-	160	-	145	-	-	-	-	-	-
9	Light	0.20	0.60	-	-	-	-	-	-	-	-	170	-	-	-	-	-	-
	Medium	0.20	0.50	-	-	-	-	-	-	-	-	135	-	-	-	-	-	-
	Heavy	0.20	0.40	-	-	-	-	-	-	-	-	115	-	-	-	-	-	-

ADJUSTMENT v _c				
Subgroup	K1	K2	K3	K4
Adjustment for workpiece hardness				
Hardness (HB)	KV _{HB1}	KV _{HB2}	KV _{HB3}	KV _{HB4}
120	1.60	1.52	1.44	1.36
140	1.45	1.38	1.31	1.23
160	1.35	1.28	1.22	1.15
180	1.25	1.19	1.13	1.06
200	1.10	1.05	0.99	0.94
220	1.00	0.95	0.90	0.85
240	0.90	0.86	0.81	0.77
260	0.80	0.76	0.72	0.68
280	0.70	0.67	0.63	0.60
300	0.65	0.62	0.59	0.55
320	0.60	0.57	0.54	0.51
340	0.55	0.52	0.50	0.47
360	0.50	0.48	0.45	0.43
380	0.40	0.38	0.36	0.34
Adjustment for durability (general machining)				
Durability (min)	k _{pr}			
15	1.23			
20	1.13			
30	1.00			
45	0.89			
60	0.81			
90	0.72			
Adjustment for durability (heavy roughing)				
Durability (min)	k _{pr}			
30	1.23			
60	1.00			
90	0.89			
120	0.81			
Adjustment coefficient k _{vc}				
Skin of forging and casting		0.70 - 0.90		
Machine in good condition		1.05 - 1.20		
Machine in poor condition		0.85 - 0.95		

Table 4b

CHOOSING THE MILLING TOOL AND THE INITIAL MACHINING CONDITIONS

Group	N										ADJUSTMENT v_c				Subgroup	
	Cutting conditions		Range of starting feeds		8215	8230	M8326	7205	7215	7230	HF7	N1	N2	N3		N4
	Light	Medium	Heavy	0.10	0.10	0.10	0.10	0.10	0.10	0.10	0.10	0.10	0.10	0.10		0.10
1	Light	Medium	Heavy	0.10	0.10	0.10	0.10	0.10	0.10	0.10	0.10	0.10	0.10	0.10	0.10	
	Light	Medium	Heavy	0.10	0.10	0.10	0.10	0.10	0.10	0.10	0.10	0.10	0.10	0.10	0.10	
	Light	Medium	Heavy	0.10	0.10	0.10	0.10	0.10	0.10	0.10	0.10	0.10	0.10	0.10	0.10	
2	Light	Medium	Heavy	0.10	0.10	0.10	0.10	0.10	0.10	0.10	0.10	0.10	0.10	0.10	0.10	
	Light	Medium	Heavy	0.10	0.10	0.10	0.10	0.10	0.10	0.10	0.10	0.10	0.10	0.10	0.10	
	Light	Medium	Heavy	0.10	0.10	0.10	0.10	0.10	0.10	0.10	0.10	0.10	0.10	0.10	0.10	
3	Light	Medium	Heavy	0.10	0.10	0.10	0.10	0.10	0.10	0.10	0.10	0.10	0.10	0.10	0.10	
	Light	Medium	Heavy	0.10	0.10	0.10	0.10	0.10	0.10	0.10	0.10	0.10	0.10	0.10	0.10	
	Light	Medium	Heavy	0.10	0.10	0.10	0.10	0.10	0.10	0.10	0.10	0.10	0.10	0.10	0.10	
4	Light	Medium	Heavy	0.10	0.10	0.10	0.10	0.10	0.10	0.10	0.10	0.10	0.10	0.10	0.10	
	Light	Medium	Heavy	0.10	0.10	0.10	0.10	0.10	0.10	0.10	0.10	0.10	0.10	0.10	0.10	
	Light	Medium	Heavy	0.10	0.10	0.10	0.10	0.10	0.10	0.10	0.10	0.10	0.10	0.10	0.10	
5	Light	Medium	Heavy	0.10	0.10	0.10	0.10	0.10	0.10	0.10	0.10	0.10	0.10	0.10	0.10	
	Light	Medium	Heavy	0.10	0.10	0.10	0.10	0.10	0.10	0.10	0.10	0.10	0.10	0.10	0.10	
	Light	Medium	Heavy	0.10	0.10	0.10	0.10	0.10	0.10	0.10	0.10	0.10	0.10	0.10	0.10	
6	Light	Medium	Heavy	0.10	0.10	0.10	0.10	0.10	0.10	0.10	0.10	0.10	0.10	0.10	0.10	
	Light	Medium	Heavy	0.10	0.10	0.10	0.10	0.10	0.10	0.10	0.10	0.10	0.10	0.10	0.10	
	Light	Medium	Heavy	0.10	0.10	0.10	0.10	0.10	0.10	0.10	0.10	0.10	0.10	0.10	0.10	
7	Light	Medium	Heavy	0.10	0.10	0.10	0.10	0.10	0.10	0.10	0.10	0.10	0.10	0.10	0.10	
	Light	Medium	Heavy	0.10	0.10	0.10	0.10	0.10	0.10	0.10	0.10	0.10	0.10	0.10	0.10	
	Light	Medium	Heavy	0.10	0.10	0.10	0.10	0.10	0.10	0.10	0.10	0.10	0.10	0.10	0.10	
8	Light	Medium	Heavy	0.10	0.10	0.10	0.10	0.10	0.10	0.10	0.10	0.10	0.10	0.10	0.10	
	Light	Medium	Heavy	0.10	0.10	0.10	0.10	0.10	0.10	0.10	0.10	0.10	0.10	0.10	0.10	
	Light	Medium	Heavy	0.10	0.10	0.10	0.10	0.10	0.10	0.10	0.10	0.10	0.10	0.10	0.10	
9	Light	Medium	Heavy	0.10	0.10	0.10	0.10	0.10	0.10	0.10	0.10	0.10	0.10	0.10	0.10	
	Light	Medium	Heavy	0.10	0.10	0.10	0.10	0.10	0.10	0.10	0.10	0.10	0.10	0.10	0.10	
	Light	Medium	Heavy	0.10	0.10	0.10	0.10	0.10	0.10	0.10	0.10	0.10	0.10	0.10	0.10	
Adjustment for workpiece hardness																
Alloy type																
Aluminum for electrical applications																
Al alloys formed non-hardened HB60																
Al alloys formed hardened HB100																
Al alloys cast non-hardened HB75																
Al alloys cast hardened HB90																
Al alloys cast non-hardened HB 130 > 12% Si																
Very easy to machine alloys (>1% Pb)																
Brasses and lead bronzes (<1% Pb)																
Other brasses HB < 90																
Other brasses HB > 90																
Electrolytic bronze Cu																
Hard and very hard bronzes																
Adjustment for durability (general machining)																
Durability [min]																
15																
20																
30																
45																
60																
90																
Adjustment coefficient k_{vc}																
Skin of forging and casting																
Machine in good condition																
Machine in poor condition																

Table 5a

CHOOSING THE MILLING TOOL AND THE INITIAL MACHINING CONDITIONS

Group	S												Operating conditions of milling					
	Tool type												Light	Medium	Heavy			
	Insert																	
1														M8325 S(E)	I	8215 S	I	-
														8215 (M8310) S(E)	II	8200 S	II	-
2														M8240 S(E)	III	8230 S	III	-
														8215 S(E)	I	8230 M8325 S	I	-
3														8230 S(E)	II	8230 S	II	-
														8230 S(E)	III	8240 S	III	-
4														8215 S(E)	I	8300 M8325 S	I	-
														8215 S(E)	II	8200 S	II	-
5														8230 S(E)	III	8240 S	III	-
														7010 S(E)	I	7015 S	I	-
6														8215 S(E)	II	8215 S	II	-
														8215 S(E)	III	8230 S(E)	III	-
7														8215 S(E)	I	8230 M8325 S	I	-
														8215 S(E)	II	8240 S	II	-
8														8215 S(E)	III	8240 S	III	-
														8215 S(E)	I	8230 S(E)	I	-
9														8215 S(E)	II	8240 S	II	-
														8215 S(E)	III	8240 S	III	-

Table 5b

CHOOSING THE MILLING TOOL AND THE INITIAL MACHINING CONDITIONS

Group	S											ADJUSTMENT v_c			
	S											S1	S2	S3	S4
	Cutting conditions	Range of starting feeds		M9325	M9340	M8345	8215	8230	M8310	M8326	M8340	M8346	7215	7230	HF7
1	Light	0.10	0.30	120	80	-	105	95	105	-	95	-	-	-	
	Medium	0.10	0.25	110	75	-	90	80	95	-	85	-	-	-	
	Heavy	0.10	0.20	-	-	-	75	70	-	-	70	-	-	-	
2	Light	0.10	0.35	115	70	-	100	90	-	90	-	-	-	35	
	Medium	0.10	0.30	105	65	-	85	80	-	80	-	-	-	30	
	Heavy	0.10	0.20	-	-	-	75	65	-	70	-	-	-	-	
3	Light	0.10	0.30	105	70	65	90	80	-	80	-	-	-	30	
	Medium	0.10	0.25	95	70	60	80	75	-	75	-	-	-	30	
	Heavy	0.10	0.15	-	-	-	70	65	-	65	-	-	-	-	
4	Light	-	-	125	90	75	105	95	110	-	95	85	70	40	
	Medium	-	-	115	80	70	95	85	105	-	90	75	65	35	
	Heavy	-	-	-	-	-	85	80	-	80	-	-	-	-	
5	Light	-	-	-	-	70	-	85	100	-	90	-	-	-	
	Medium	-	-	-	-	65	-	80	90	-	80	-	-	-	
	Heavy	-	-	-	-	-	-	70	-	70	-	-	-	-	
6	Light	0.10	0.50	-	-	-	85	80	-	80	-	-	-	-	
	Medium	0.10	0.30	-	-	-	75	70	-	70	-	-	-	-	
	Heavy	0.10	0.20	-	-	-	-	65	-	65	-	-	-	-	
7	Light	0.10	0.25	-	-	-	50	50	-	50	-	-	-	-	
	Medium	0.10	0.20	-	-	-	45	40	-	40	-	-	-	-	
	Heavy	0.08	0.15	-	-	-	-	30	-	30	-	-	-	-	
8	Light	0.25	0.60	-	-	-	-	75	-	-	-	-	-	-	
	Medium	0.25	0.50	-	-	-	-	55	-	-	-	-	-	-	
	Heavy	0.25	0.40	-	-	-	-	50	-	65	-	-	-	-	
9	Light	0.20	0.60	-	-	-	-	-	-	-	-	-	-	-	
	Medium	0.20	0.50	-	-	-	-	-	-	-	-	-	-	-	
	Heavy	0.20	0.40	-	-	-	-	0.40	-	-	-	-	-	-	

Adjustment for workpiece hardness										
Hardness [HB]	KV_{HB1}	KV_{HB2}	KV_{HB3}	KV_{HB4}	KV_{HB5}					
180	2,14	1,46	1,22	0,92	0,92					
200	2,01	1,38	1,15	0,93	0,93					
210	1,93	1,32	1,10	0,83	0,83					
220	1,89	1,30	1,08	0,81	0,81					
230	1,84	1,26	1,05	0,79	0,79					
240	1,80	1,24	1,03	0,77	0,77					
250	1,75	1,20	1,00	0,75	0,75					
260	1,70	1,16	0,97	0,73	0,73					
280	1,61	1,10	0,92	0,69	0,69					
300	1,54	1,06	0,88	0,66	0,66					
320	1,47	1,01	0,84	0,63	0,63					
340	1,40	0,96	0,80	0,60	0,60					
350	1,37	0,94	0,78	0,59	0,59					
360	1,30	0,89	0,74	0,56	0,56					

Adjustment for durability (general machining)										
Durability [min]	k_{vr}									
15	1,23	1,13	1,00	0,89	0,81	0,72	0,63	0,56	0,50	0,45
20	1,13	1,00	0,89	0,81	0,72	0,63	0,56	0,50	0,45	0,40
30	1,00	0,89	0,81	0,72	0,63	0,56	0,50	0,45	0,40	0,35
45	0,89	0,81	0,72	0,63	0,56	0,50	0,45	0,40	0,35	0,30
60	0,81	0,72	0,63	0,56	0,50	0,45	0,40	0,35	0,30	0,25
90	0,72	0,63	0,56	0,50	0,45	0,40	0,35	0,30	0,25	0,20

Adjustment coefficient k_{vx}										
Skin of forging and casting	0,70-0,90									
Machine in good condition	1,05-1,20									
Machine in poor condition	0,85-0,95									

Table 6a

CHOOSING THE MILLING TOOL AND THE INITIAL MACHINING CONDITIONS

Group	Tool type										Insert	Operating conditions of milling			
												Light	Medium	Heavy	
1											HNGX 06 HNGX 09 HREF 0805..... SNMT 12020AZ	I II III	M9315 S 8215 M8310 S 8230 S(E)	I II III	- - -
2											CEHT 06 ODMT(W)05..ODMT(W)06 SEM709 SDEW..SDEK 09... SOMT0913... TCMT13073... XPH1 3604...	I II III	8215 M9315 S(E) 8230 S(E) 8230 S(E) 8230 S(E) 8230 S(E)	I II III	- - -
3											ADMX ADEX1173... ADMX ADEX1606... APET 1003PD APET..APKT 1604... LINGX 12...LINGU 16... SOMT 09130...SOMT12050SR... ADMX 15T3...XOEN12 T3...	I II III	8215 M9315 S(E) 8230 S(E) 8230 S(E) 8230 S(E)	I II III	- - -
4											SCXR09T3...SC08 T3T3...RPHX 0500... RPHX R0GT R0GT 07T1..0702... RPHX R0GT R0GT 0033... RPHX R0GT R0GT 12T3... RPHX R0GT R0GT 1604... RPHX R0GT R0GT 1604... RCMT 1204..RCMT1606..RCMT2006..ZDCW 07... ZDCW 09..ZDCW 12... PD..0805...R0HT 16..R0HT 15	I II III	7010 M8310 S(E) 7205 M8310 S(E) 7215 M8325 S(E) 8215 M8310 S(E) 8230 S(E)	I II III	- - -
5											XPXER-FM ZPXER-XX VCGT 220330 RC..RCA..LC	I II III	M8310 7215 - - -	I II III	- - -
6											SN...11 (12) CN XN...1205	I II III	8215 E(S) - - -	I II III	- - -
7											ADMX ADEX1606... LNET 1606 (ISR..SNGX 1305 SNGX 1305)2PN APET(W) 150412 SPET(W) 1204AD ADMX ADEX 1173... SDMX 1205 CCMX 0603... CCMX 08T3...CCMX 09T3...	I II III	- - - - - -	I II III	- - -
8											SPUN..SPGN 2506... SBMR 22 PNUU 1308...	I II III	- - - -	I II III	- - -
9											SPUN 2506... TBMR 27...	I II III	- - -	I II III	- - -

Table 6b

CHOOSING THE MILLING TOOL AND THE INITIAL MACHINING CONDITIONS

Group	H										ADJUSTMENT v_c											
	H										H1	H2	H3	H4								
	H										Adjustment for workpiece hardness											
Cutting conditions	Range of starting feeds										Subgroup	Hardness [HB/HRC]				KV_{HP1}	KV_{HP2}	KV_{HP3}	KV_{HP4}			
1	Light	0.10	0.30	85	M9315	80	M9325	80	5040	M8310	70	8215	60	8230	7205	7215	7230	H7	-	-	-	-
	Medium	0.10	0.25	80	75	70	-	-	-	65	60	60	55	-	-	-	-	-	-	-	-	-
	Heavy	0.10	0.20	-	-	-	-	-	-	-	-	50	45	-	-	-	-	-	-	-	-	-
2	Light	0.10	0.35	80	80	75	-	-	-	-	65	60	60	45	-	-	-	-	25	-	-	-
	Medium	0.10	0.30	70	70	70	-	-	-	-	55	50	50	-	-	-	-	-	20	-	-	-
	Heavy	0.10	0.20	-	-	-	-	-	-	-	50	45	45	-	-	-	-	-	-	-	-	-
3	Light	0.10	0.30	75	70	70	-	-	-	-	60	55	55	-	-	-	-	-	20	-	-	-
	Medium	0.10	0.25	70	70	65	-	-	-	-	55	50	50	-	-	-	-	-	20	-	-	-
	Heavy	0.10	0.15	-	-	-	-	-	-	-	45	45	45	-	-	-	-	-	-	-	-	-
4	Light	-	-	-	-	80	-	-	50	75	70	70	60	60	60	55	45	25	-	-	-	-
	Medium	-	-	-	-	75	-	-	45	70	60	60	55	55	50	45	25	-	-	-	-	-
	Heavy	-	-	-	-	-	-	-	-	-	55	50	50	-	-	-	-	-	-	-	-	-
5	Light	-	-	-	-	-	-	-	-	65	-	-	55	55	-	90	75	-	-	-	-	-
	Medium	-	-	-	-	-	-	-	-	60	-	-	50	50	-	85	75	-	-	-	-	-
	Heavy	-	-	-	-	-	-	-	-	-	-	-	45	45	-	-	-	-	-	-	-	-
6	Light	0.10	0.50	-	-	-	-	-	-	-	55	50	50	-	-	-	-	-	-	-	-	-
	Medium	0.10	0.30	-	-	-	-	-	-	-	50	45	45	-	-	-	-	-	-	-	-	-
	Heavy	0.10	0.20	-	-	-	-	-	-	-	-	-	40	40	-	-	-	-	-	-	-	-
7	Light	0.10	0.25	-	-	-	-	-	-	-	35	30	30	-	-	-	-	-	-	-	-	-
	Medium	0.10	0.20	-	-	-	-	-	-	-	30	25	25	-	-	-	-	-	-	-	-	-
	Heavy	0.08	0.15	-	-	-	-	-	-	-	-	20	20	-	-	-	-	-	-	-	-	-
8	Light	0.25	0.60	-	-	-	-	-	-	-	-	-	50	-	-	-	-	-	-	-	-	-
	Medium	0.25	0.50	-	-	-	-	-	-	-	-	35	35	-	-	-	-	-	-	-	-	-
	Heavy	0.25	0.40	-	-	-	-	-	-	-	-	30	30	-	-	-	-	-	-	-	-	-
9	Light	0.20	0.60	-	-	-	-	-	-	-	-	-	-	-	-	-	-	-	-	-	-	-
	Medium	0.20	0.50	-	-	-	-	-	-	-	-	-	-	-	-	-	-	-	-	-	-	-
	Heavy	0.20	0.40	-	-	-	-	-	-	-	-	-	-	-	-	-	-	-	-	-	-	-
Adjustment for durability (general machining)											Adjustment for durability (general machining)											
Durability [min]											Durability [min]											
k_{vr}											k_{vr}											
15											15											
20											20											
30											30											
45											45											
60											60											
90											90											
0.70 - 0.90											0.70 - 0.90											
1.05 - 1.20											1.05 - 1.20											
0.85 - 0.95											0.85 - 0.95											
Adjustment coefficient k_x											Adjustment coefficient k_x											
Skin of forging and casting											Skin of forging and casting											
Machine in good condition											Machine in good condition											
Machine in poor condition											Machine in poor condition											

GEOMETRY OF CUTTING INSERTS FOR TURNING

MILLING TOOLS

MILLING INSERTS

TURNING INSERTS

DRILLING INSERTS

TECHNICAL SECTION

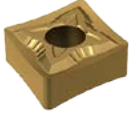
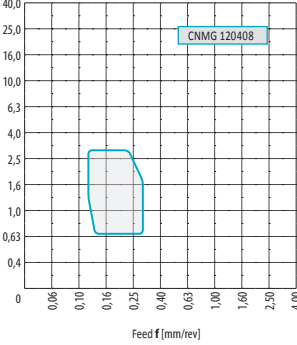
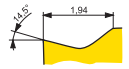
Chip-breaker	Photo	Group of machined materials	Operating diagram	Description	Used for inserts: CNGG, CNMG, DNMG, SNMG, TNMG, VNMG, WNMG										
SF		Turning P M K N S H		- Positive sharp geometry (without a peripheral stabilising land) - Suitable for finishing to light and medium machining - Main area of application – machined materials in groups S and M - Additional area of application – machined materials in group P - Continuous cut											
	Cutting edge profile	F M R				<table border="1"> <tr> <th colspan="2">Range of machining conditions:</th> <th>Unit:</th> </tr> <tr> <td>f</td> <td>0,08 ÷ 0,35</td> <td>[mm/rev]</td> </tr> <tr> <td>a_p</td> <td>0,2 ÷ 3,5</td> <td>[mm]</td> </tr> </table>	Range of machining conditions:		Unit:	f	0,08 ÷ 0,35	[mm/rev]	a_p	0,2 ÷ 3,5	[mm]
	Range of machining conditions:					Unit:									
f	0,08 ÷ 0,35	[mm/rev]													
a_p	0,2 ÷ 3,5	[mm]													
															

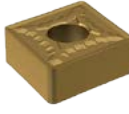
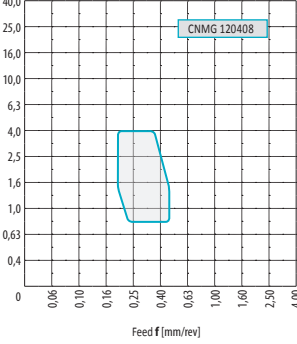
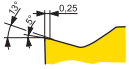
Chip-breaker	Photo	Group of machined materials	Operating diagram	Description	Used for inserts: CNMG, DNMG, SNMG, TNMG, VNMG, WNMG										
SM		Turning P M K N S H		- Slightly positive geometry with a peripheral stabilising land - Suitable for medium machining - Main area of application – machined materials in groups S and M - Additional area of application – machined materials in group P - Potential application – machined materials in group K - Continuous and interrupted cut											
	Cutting edge profile	F M R				<table border="1"> <tr> <th colspan="2">Range of machining conditions:</th> <th>Unit:</th> </tr> <tr> <td>f</td> <td>0,15 ÷ 0,55</td> <td>[mm/rev]</td> </tr> <tr> <td>a_p</td> <td>0,4 ÷ 6,0</td> <td>[mm]</td> </tr> </table>	Range of machining conditions:		Unit:	f	0,15 ÷ 0,55	[mm/rev]	a_p	0,4 ÷ 6,0	[mm]
	Range of machining conditions:					Unit:									
f	0,15 ÷ 0,55	[mm/rev]													
a_p	0,4 ÷ 6,0	[mm]													
															

■ Main application area ▣ Other applications □ Potential applications

NEW GRADES FOR TURNING

Identification code and microstructure	Application areas	Group of machined materials	Grade description and recommended application
--	-------------------	-----------------------------	---

T6310

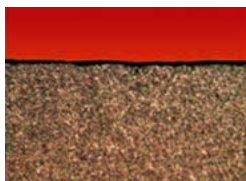
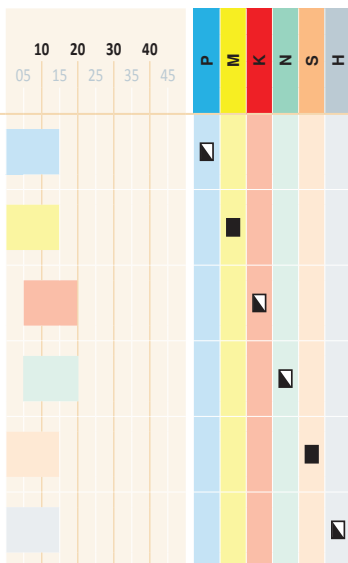

- Type H ultra submicron substrate
- Medium cobalt bonding phase content
- New multilayer PVD coating with a top layer that is highly wear-resistant (AlTiSiN)
- High wear resistance combined with effective resistance to the formation of ridgeline cracks
- Cutting edge is extremely strong and stable
- Special material for machining ISO S difficult-to-machine materials and ISO M stainless steels
- Suitable for machining material groups P, K, N and H
- Suitable for applications that require coolant and also for dry machining
- Can potentially be used in unstable conditions

H07

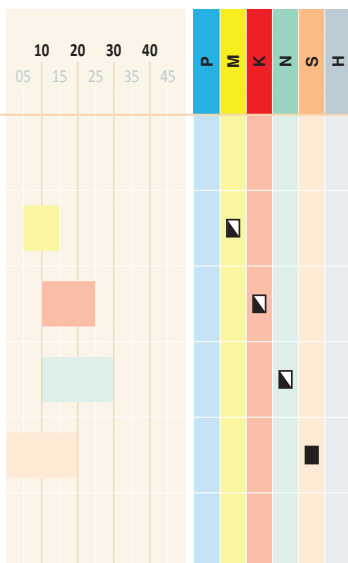

- Uncoated turning material
- H type fine-grain material (without cubic carbides) with low cobalt bonding phase content
- Special grade for machining titanium alloys
- Also suitable for machining material groups K, N and M
- Small to medium cross-sections of chip
- Suitable for continuous to slightly interrupted cut

■ Main application area ■ Other applications □ Potential applications

MILLING TOOLS

MILLING INSERTS

TURNING INSERTS

DRILLING INSERTS

TECHNICAL SECTION

Choosing the shape and size of the insert

Priority of choice	Insert shape	Insert size	Maximum length of cutting edge L_{max} [mm]		
 		V	11	0,25L	2,8
			16		4,2
		D	07	0,25L	2,0
			11		2,9
			15		3,9
		K	16	0,25L	4,7
			19		4,7
		T	11	0,33L	3,6
			16		5,5
			22		7,3
			27		9,1
		W	06	0,50L	3,3
			08		4,4
		C	06	0,66L	4,2
			09		6,4
			12		8,5
			16		10,6
			19		12,7
			25		16,5
		S	09	0,66L	6,3
			12		8,4
			15		10,4
			19		12,6
			25		16,8
38			25,0		
	R	06	0,40D	2,4	
		08		3,2	
		10		4,0	
		12		4,8	
		15		6,0	
		16		6,4	
		19		7,6	
		20		8,0	
		25		10,0	
		32		12,8	

MILLING TOOLS

MILLING INSERTS

TURNING INSERTS

DRILLING INSERTS

TECHNICAL SECTION

CHOICE OF INITIAL CUTTING CONDITIONS

Surface quality in turning

The quality of the machined surface in turning depends on the feed rate f and the radius of the insert r_ϵ . The values of surface roughness R_{max} and R_a are given in following tables.

There are other factors that can influence surface roughness, please take the given values as a guide.

$$R_{max} = \frac{f^2}{8 \cdot r_\epsilon} \cdot 1000$$

Feed f (mm/rev.)	r_ϵ Radius																				
	0,1	0,2	0,4	0,5	0,8	1,0	1,2	1,5	1,6	2,0	2,4	2,5	3,0	3,2	3,5	4,0	5,0	6,0	8,0		
Surface R_{max} (μm)																					
0,05	3,13	1,56	0,78	0,63	0,39	0,31	0,26	0,21	0,20	0,16	0,13	0,13	0,10	0,10	0,09	0,08	0,06	0,05	0,04		
0,07	6,1	3,06	1,53	1,23	0,77	0,61	0,51	0,41	0,38	0,31	0,26	0,25	0,20	0,19	0,18	0,15	0,12	0,10	0,08		
0,08	8,0	4,0	2,00	1,60	1,00	0,80	0,67	0,53	0,50	0,40	0,33	0,32	0,27	0,25	0,23	0,20	0,16	0,13	0,10		
0,10		6,3	3,13	2,50	1,56	1,25	1,04	0,83	0,78	0,63	0,52	0,50	0,42	0,39	0,36	0,31	0,25	0,21	0,16		
0,12		9,0	4,50	3,60	2,25	1,80	1,50	1,20	1,13	0,90	0,75	0,72	0,60	0,56	0,51	0,45	0,36	0,30	0,23		
0,15		14	7,0	5,6	3,52	2,81	2,34	1,88	1,76	1,41	1,17	1,13	0,94	0,88	0,80	0,70	0,56	0,47	0,35		
0,16		16	8,0	6,4	4,00	3,20	2,67	2,13	2,00	1,60	1,33	1,28	1,07	1,00	0,91	0,80	0,64	0,53	0,40		
0,18		20	10,1	8,1	5,1	4,05	3,38	2,70	2,53	2,03	1,69	1,62	1,35	1,27	1,16	1,01	0,81	0,68	0,51		
0,20			13	10,0	6,3	5,0	4,17	3,33	3,13	2,50	2,08	2,00	1,67	1,56	1,43	1,25	1,00	0,83	0,63		
0,22			15	12,1	7,6	6,1	5,0	4,03	3,78	3,03	2,52	2,42	2,02	1,89	1,73	1,51	1,21	1,01	0,76		
0,25			20	16	9,8	7,8	6,5	5,2	4,88	3,91	3,26	3,13	2,60	2,44	2,23	1,95	1,56	1,30	0,98		
0,27			23	18	11,4	9,1	7,6	6,1	5,7	4,56	3,80	3,65	3,04	2,85	2,60	2,28	1,82	1,52	1,14		
0,30			28	23	14	11,3	9,4	7,5	7,0	5,6	4,69	4,50	3,75	3,52	3,21	2,81	2,25	1,88	1,41		
0,32			32	26	16	13	10,7	8,5	8,0	6,4	5,3	5,1	4,27	4,00	3,66	3,20	2,56	2,13	1,60		
0,35			38	31	19	15	13	10,2	9,6	7,7	6,4	6,1	5,1	4,79	4,38	3,83	3,06	2,55	1,91		
0,37			43	34	21	17	14	11,4	10,7	8,6	7,1	6,8	5,7	5,3	4,89	4,28	3,42	2,85	2,14		
0,40				40	25	20	17	13	13	10,0	8,3	8,0	6,7	6,3	5,7	5,0	4,00	3,33	2,50		
0,45				51	32	25	21	17	16	13	10,5	10,1	8,4	7,9	7,2	6,3	5,1	4,22	3,16		
0,50					39	31	26	21	20	16	13	13	10,4	9,8	8,9	7,8	6,3	5,2	3,91		
0,55					47	38	32	25	24	19	16	15	13	11,8	10,8	9,5	7,6	6,3	4,73		
0,60					56	45	38	30	28	23	19	18	15	14	13	11,3	9,0	7,5	5,6		
0,65					66	53	44	35	33	26	22	21	18	17	15	13	10,6	8,8	6,6		
0,70					77	61	51	41	38	31	26	25	20	19	18	15	12,3	10,2	7,7		
0,75					88	70	59	47	44	35	29	28	23	22	20	18	14	11,7	8,8		
0,80						80	67	53	50	40	33	32	27	25	23	20	16	13	10,0		
0,85						90	75	60	56	45	38	36	30	28	26	23	18	15	11,3		
0,90						101	84	68	63	51	42	41	34	32	29	25	20	17	13		
0,95						113	94	75	71	56	47	45	38	35	32	28	23	19	14		
1,00							104	83	78	63	52	50	42	39	36	31	25	21	16		
1,20								120	113	90	75	72	60	56	51	45	36	30	23		
1,30								141	132	106	88	85	70	66	60	53	42	35	26		
1,40								163	153	123	102	98	82	77	70	61	49	41	31		
1,50									176	141	117	113	94	88	80	70	56	47	35		
1,60										160	133	128	107	100	91	80	64	53	40		
1,70										181	151	145	120	113	103	90	72	60	45		
1,80										203	169	162	135	127	116	101	81	68	51		
1,90											226	188	181	150	141	129	113	90	75	56	
2,00												208	200	167	156	143	125	100	83	63	
2,20													252	242	202	189	173	151	121	101	76
2,50															260	244	223	195	156	130	98

□ danger of hard chipbreaking

CHOICE OF INITIAL CUTTING CONDITIONS

$$R_a = 43,9 \frac{f^{1,88}}{r_\epsilon^{0,97}}$$

Feed f (mm/rev.)	r_ϵ Radius																		
	0,1	0,2	0,4	0,5	0,8	1,0	1,2	1,5	1,6	2,0	2,4	2,5	3,0	3,2	3,5	4,0	5,0	6,0	8,0
	Surface R_a (μm)																		
0,05	1,47	0,75	0,38	0,31	0,20	0,16	0,13	0,11	0,10	0,08	0,07	0,06	0,05	0,05	0,05	0,04	0,03	0,03	0,02
0,07	2,76	1,41	0,72	0,58	0,37	0,30	0,25	0,20	0,19	0,15	0,13	0,12	0,10	0,10	0,09	0,08	0,06	0,05	0,04
0,08	3,55	1,81	0,93	0,75	0,47	0,38	0,32	0,26	0,24	0,19	0,16	0,16	0,13	0,12	0,11	0,10	0,08	0,07	0,05
0,10		2,76	1,41	1,13	0,72	0,58	0,48	0,39	0,37	0,30	0,25	0,24	0,20	0,19	0,17	0,15	0,12	0,10	0,08
0,12		3,88	1,98	1,60	1,01	0,82	0,68	0,55	0,52	0,42	0,35	0,34	0,28	0,26	0,24	0,21	0,17	0,14	0,11
0,15		5,9	3,02	2,43	1,54	1,24	1,04	0,84	0,79	0,63	0,53	0,51	0,43	0,40	0,37	0,32	0,26	0,22	0,17
0,16		6,7	3,41	2,74	1,74	1,40	1,17	0,94	0,89	0,71	0,60	0,58	0,48	0,45	0,42	0,36	0,29	0,25	0,19
0,18		8,3	4,25	3,42	2,17	1,75	1,46	1,18	1,11	0,89	0,75	0,72	0,60	0,57	0,52	0,46	0,37	0,31	0,23
0,20			5,2	4,17	2,64	2,13	1,78	1,44	1,35	1,09	0,91	0,88	0,73	0,69	0,63	0,56	0,45	0,37	0,28
0,22			6,2	4,99	3,16	2,55	2,14	1,72	1,62	1,30	1,09	1,05	0,88	0,82	0,76	0,66	0,53	0,45	0,34
0,25			7,9	6,3	4,02	3,24	2,72	2,19	2,05	1,65	1,39	1,33	1,12	1,05	0,96	0,84	0,68	0,57	0,43
0,27			9,1	7,3	4,65	3,74	3,14	2,53	2,37	1,91	1,60	1,54	1,29	1,21	1,11	0,98	0,79	0,66	0,50
0,30			11,1	8,9	5,7	4,57	3,83	3,08	2,89	2,33	1,95	1,88	1,57	1,48	1,35	1,19	0,96	0,80	0,61
0,32			13	10,1	6,4	5,2	4,32	3,48	3,27	2,63	2,20	2,12	1,78	1,67	1,53	1,34	1,08	0,91	0,69
0,35			15	11,9	7,6	6,1	5,1	4,12	3,87	3,11	2,61	2,51	2,10	1,97	1,81	1,59	1,28	1,07	0,81
0,37			16	13	8,4	6,8	5,7	4,57	4,29	3,46	2,90	2,78	2,33	2,19	2,01	1,76	1,42	1,19	0,90
0,40				15	9,7	7,8	6,6	5,3	4,97	4,00	3,35	3,22	2,70	2,54	2,33	2,04	1,65	1,38	1,04
0,45				19	12,1	9,8	8,2	6,6	6,2	4,99	4,19	4,02	3,37	3,17	2,90	2,55	2,05	1,72	1,30
0,50					15	11,9	10,0	8,0	7,6	6,1	5,1	4,90	4,11	3,86	3,54	3,11	2,50	2,10	1,59
0,55					18	14	12,0	9,6	9,0	7,3	6,1	5,9	4,92	4,62	4,23	3,72	2,99	2,51	1,90
0,60					21	17	14	11,3	10,7	8,6	7,2	6,9	5,8	5,4	4,98	4,38	3,53	2,96	2,24
0,65					24	20	16	13	12,4	10,0	8,4	8,0	6,7	6,3	5,8	5,1	4,10	3,44	2,60
0,70					28	22	19	15	14	11,5	9,6	9,2	7,7	7,3	6,7	5,9	4,71	3,95	2,99
0,75					32	26	21	17	16	13	10,9	10,5	8,8	8,3	7,6	6,7	5,4	4,50	3,40
0,80						29	24	19	18	15	12,3	11,9	9,9	9,3	8,6	7,5	6,1	5,1	3,84
0,85						32	27	22	21	17	14	13	11,1	10,5	9,6	8,4	6,8	5,7	4,30
0,90						36	30	24	23	18	15	15	12,4	11,7	10,7	9,4	7,6	6,3	4,79
0,95						40	33	27	25	20	17	16	14	13	11,8	10,4	8,4	7,0	5,3
1,00							37	30	28	22	19	18	15	14	13	11,4	9,2	7,7	5,8
1,20								42	39	32	26	25	21	20	18	16	13	10,9	8,2
1,30								49	46	37	31	30	25	23	21	19	15	13	9,6
1,40								56	52	42	35	34	28	27	25	22	17	15	11,0
1,50									60	48	40	39	32	30	28	25	20	17	13
1,60										54	45	44	37	34	32	28	22	19	14
1,70										61	51	49	41	39	35	31	25	21	16
1,80										68	57	54	46	43	39	35	28	23	18
1,90										75	63	60	51	47	44	38	31	26	20
2,00											69	66	56	52	48	42	34	28	21
2,20											83	79	67	63	57	50	41	34	26
2,50													85	80	73	64	52	43	33

☐ danger of hard chipbreaking

TURNING

CHOICE OF INITIAL CUTTING CONDITIONS

1. The first step is to assign the material to be machined into one of six groups according to the ISO 513 standard (see page 130).
2. Basic insert shape is dependent on the type of machining, material and workpiece shape. Cutting edge length is then selected based on the depth of cut (see page 158).
3. Select the right combination of grade and chip-breaker with regard to the materials being machined and the turning operation (see tables 1a – 6b on page 162 – 173). Three possible recommendations are shown in tables for each material group. You can also check your recommendation on page 156 and 157 .
4. Choose the nose radius of the cutting insert with respect to the depth of cut, the feed and the cutting conditions. If there is a particular requirement for Ra, choose the radius according to tables (see pages 159 - 160). Preferred choice is the wiper insert.
5. Selecting the correct size of square section tool holder is determined by the shape of the cutting insert and the make up of the machine tool. For internal tool holders select the largest diameter tool possible in relation to the insert shape and bore diameter. Try and limit tool overhang to a maximum of 3 x tool diameter.
6. In tables no. 1a – 6b on page 162 – 173, select the initial cutting speed with regard to insert grade, shape, depth of cut and feed. Initial cutting condition are valid for tool life 15 min. (45 min. for heavy roughing), without coolant. Threading, cutting off and recessing – with coolant.
7. The tables also contain correction factors for recalculating cutting speeds with regard to tool life, grades and work piece hardness. If necessary use these factors and adjust accordingly.

$$v_c = v_{15} \cdot k_{vx} \cdot k_{vT} \cdot k_{vHB} \cdot (k_{vN})$$

Please note that cutting speed determined in this way is the initial value (default) defining the basic level of cutting speed for a given operation.

Above all, the range of machinability values of the workpiece material, which may be as much as two grades of machinability for high-grade steels, is often the reason for modifying a certain cutting speed if you require to achieve relatively accurate economical tool life.

Table 1b

CHOOSING THE INITIAL MACHINING CONDITIONS - TURNING

				ADJUSTMENT v_c			
				P1	P2	P3	P4
				Adjustment for workpiece hardness			
Type of operation	Selection priority	Feeds and depth of cut		Hardness [HB]	$k_{V_{opt}}$	$k_{V_{opt}}$	$k_{V_{opt}}$
		Feed [mm/rev]	Depth of cut a_p [mm]				
Fine turning	I	0,05	0,5	120	1,53	1,18	0,94
	II	0,08	0,5	140	1,46	1,12	0,90
	III	0,10	0,5	160	1,37	1,05	0,84
Finishing turning	I	0,10	1,5	180	1,30	1,00	0,80
	II	0,15	1,5	200	1,24	0,95	0,76
	III	0,20	1,5	220	1,17	0,90	0,72
Semi-roughing turning	I	0,20	2,5	240	1,12	0,86	0,69
	II	0,30	2,5	260	1,07	0,82	0,66
	III	0,40	2,5	280	1,04	0,80	0,64
Roughing turning	I	0,40	5,0	300	1,00	0,77	0,62
	II	0,60	5,0	320	0,96	0,74	0,59
	III	0,80	5,0	340	0,92	0,71	0,57
Heavy roughing turning	I	0,80	12,0	360	0,88	0,68	0,54
	II	1,00	12,0	375	0,85	0,65	0,52
	III	1,30	12,0				
Parting off, circumferential grooving (CTP)	I	0,10	-	Adjustment for durability (general machining)			
	II	0,15	-	k_{pr}	Durability [min]	k_{pr}	
	III	0,20	-	10	1,10	30	0,84
Face and internal grooving	I	0,10	-	15	1,00	45	0,76
	II	0,15	-	20	0,93	60	0,71
	III	0,20	-	Adjustment for durability (heavy roughing)			
Threading	I	0,30	-	k_{pr}	Durability [min]	k_{pr}	
	II	0,30	-	30	1,10	60	0,93
	III	0,30	-	45	1,00		
Adjustment coefficient k_{va}							
Skin of forging and casting							
Internal turning							
Interrupted cut							
Machine in good condition							
Machine in poor condition							
Adjustment to the shape of the insert							
Shape of insert							
S... C..., W...							
T..., D..., K...							
V..., L... (parting off and grooving)							
R..., L... (roughing)							

Figures in blue are valid for machining with coolant.

Table 2a

CHOOSING THE INITIAL MACHINING CONDITIONS - TURNING

OPERATING CONDITIONS FOR TURNING													
INDEXABLE INSERT TYPE in accordance with ISO	Fine turning		Finishing turning		Semi-finishing turning		Roughing turning		Heavy roughing turning		Parting off, grooving		Threading
	$f = 0.05 \div 0.1$ [mm/rev] $a_p = 0.2 \div 1.0$ [mm]	$f = 0.1 \div 0.2$ [mm/rev] $a_p = 0.8 \div 2.0$ [mm]	$f = 0.2 \div 0.4$ [mm/rev] $a_p = 1.5 \div 4.0$ [mm]	$f = 0.4 \div 0.8$ [mm/rev] $a_p = 4.0 \div 10.0$ [mm]	$f > 1.0$ [mm/rev] $a_p > 10.0$ [mm]	$f = 0.5 \div 0.3$							
	Pre-machined surface Uninterrupted cut	Casting, forging Interrupted cut	Pre-machined surface Uninterrupted cut	Casting, forging Interrupted cut	Pre-machined surface Uninterrupted cut	Casting, forging Interrupted cut	Pre-machined surface Uninterrupted cut	Casting, forging Interrupted cut	Pre-machined surface Uninterrupted cut	Casting, forging Interrupted cut	Circumferential grooving and parting off	Face grooving and parting off	
.A .M .G .U .N CNMA, CNMM, CNMG, DNMA, DNMM, DNMG, DNMU, SNMA, SNMM, SNMG, SNMX, TNMA, TNMM, TNMG, VNMU, RNMA, RNMM, RNMG, WNMA, WNMM, WNMG	T8315	T8315	T9325	T8315	T9325	T7335	T9325	T8315	T9325	T9325	T9335	T9335	-
	FF	FM	SM (W-MR)	NF	SM (W-MR)	SM	RM (W-MR)	RM	NR2 (OR)	NR2 (OR)	-	-	-
	T6310	T6310	T7335	T8330	T7335	T7335	T7335	T7335	T7335	T7335	T9335	T9335	-
	SF	SF	NM (SI)	SM	FM	FM	NR	R	NR2 (OR)	NR2 (OR)	-	-	-
	-	T9315	T8330	T8330	T8330	T8330	T7335	T8330	-	-	-	-	-
	-	NF	NM (SI)	FM	FM	FM	RM	NR2 (OR)	-	-	-	-	-
	-	T9325	6640	T9325	6640	6640	6640	-	T9310	T9310	-	-	-
	-	72	73 (78)	72	73 (78)	73 (78)	73 (78)	-	-	-	-	-	-
	-	-	T9325	T9325	72	72	74 (79)	-	T9315	T9315	-	-	-
	-	-	-	T8315	T5315	T9315	T9315	-	T9325	T9325	-	-	-
.W .T CCMW, CCMT, SGMW, SCMT, DCMW, DCMT, TCMW, TGMT, VGMW, VCMT, WCMW, WCM, RCMW, RCMT, RCMX	TT310	TT310	UR	UR	UR	UR	UR	UR	UR	UR	UR	UR	-
	UR	UR	FM	FF	FM	FM	FM	FM	FM	FM	OR	OR	-
	T8315	T8315	T9315	T7335	T9315	T7335	T9315	T7335	T9315	T9315	T9335	T9335	-
	FF	FM	RM	FM	RM	RM	RM	RM	RM	SR	-	-	-
	8016	T8315	T7335	T8330	T8330	T8330	T8330	T8330	-	-	-	-	-
	AI	UR	RM	FM	RM	RM	RM	RM	-	-	-	-	-
	-	T9325	T9325	T9335	T9325	T9335	T9335	T9335	-	-	-	-	-
	-	46	46	46	46	46	46	46	-	-	-	-	-
	-	T9325	T9325	T9335	T9325	T9335	T9335	T9335	-	-	-	-	-
	-	47	47	47	47	47	47	47	-	-	-	-	-
.R .N SPMR, SPGR, SPUN, SPGN, TPMR, TPGR, TPUN, TPGN	-	T9325	T9325	T9335	T9325	T9335	T9325	T9335	-	-	-	-	-
	-	46	46	46	46	46	46	46	-	-	-	-	-
	-	T9325	T9325	T9335	T9325	T9335	T9335	T9335	-	-	-	-	-
	-	47	47	47	47	47	47	47	-	-	-	-	-
	-	T9325	T9325	T9335	T9325	T9335	T9335	T9335	-	-	-	-	-
	-	48	48	48	48	48	48	48	-	-	-	-	-
	-	T8330	T8330	T8330	T8330	T8330	T8330	T8330	-	-	-	-	-
	-	-	-	-	-	-	-	-	-	-	-	-	-
	-	-	-	-	-	-	-	-	-	-	-	-	-
	-	-	-	-	-	-	-	-	-	-	-	-	-
.X LFMX, LFUX, LCMX, TN11., TN16., TN22..	T8330	T8330	T8330	T8330	T8330	T8330	T8330	T8330	T8330	T8330	T8330	T8330	-
	-	-	-	-	-	-	-	-	-	-	-	-	-
TN11., TN16., TN 22	-	-	-	-	-	-	-	-	-	-	-	-	-
	-	-	-	-	-	-	-	-	-	-	-	-	-

Machined material, main ISO group

M

Table 3a

CHOOSING THE INITIAL MACHINING CONDITIONS - TURNING

INDEXABLE INSERT TYPE in accordance with ISO		OPERATING CONDITIONS FOR TURNING																
		Fine turning		Finishing turning		Semi-finishing turning		Roughing turning		Heavy roughing turning		Parting off, grooving		Threading				
		$f = 0.05 \div 0.1$ [mm/rev] $a_p = 0.2 \div 1.0$ [mm]	$f = 0.1 \div 0.2$ [mm/rev] $a_p = 0.8 \div 2.0$ [mm]	$f = 0.2 \div 0.4$ [mm/rev] $a_p = 1.5 \div 4.0$ [mm]	$f = 0.4 \div 0.8$ [mm/rev] $a_p = 4.0 \div 10.0$ [mm]	$f > 1.0$ [mm/rev] $a_p > 10.0$ [mm]	$f = 0.5 \div 0.3$											
..A	CNMA, CNMM, CNMG, DNMA, DNMM, DNMG, DN1U, SNMA, SNMM, SNMG, SNMX, TNMA, TNMM, TNMG, VN1U, RNMA, RNMM, RNMG, WNMA, WNMM, WNMG	TC100	T5305	TC100	T5305	T5305	T5305	T5305	T5305	T5315	T5315	T5315	T9325	T9325	-	-	-	-
..M																		
..G																		
..U		TB310	T5315	TB310	T5315	T5305	T5315	T5305	T5315	T5305	T5315	T5315	T9335	T9335	-	-	-	-
..N																		
..X	KNUX LNUX																	
..W	CCMW, CCMT, SCMW, SCMT, DCMW, DCMT, TCMW, TCGT, VCMW, VCMT, WCMW, WCMT, RCMW, RCMT, RCMX	T5305	T5305	T5305	T5305	T5305	T5305	T5305	T5305	T5305	T5305	T5305	T5305	T5305	T5315	T5315	T9315	T9315
..T		UR	UR	UR	UR	UR	UR	UR	UR	UR	UR	UR	UR	UR	UR	UR	UR	UR
..R	SPMR, SPGR, SPUN, SPGN, TPMP, TPGR, TPUN, TPGN																	
..N																		
..X	LFMX, LFUX, LCMX, TN11., TN16., TN22..	T8330	T8330	T8330	T8330	T8330	T8330	T8330	T8330	T8330	T8330	T8330	T8330	T8330	T8330	T8330	T8330	T8330
	TN11., TN16., TN 22																	

Machined material, main ISO group



Figures in blue are valid for machining with coolant.

Type of operation	Selection priority	Feeds and depth of cut		N										Durability
		Feed [mm/rev]	Depth of cut a _p [mm]	T0315	T8030	T8310	T8315	T8330	H07	Hf7	D720	PC30	Pd1	
Fine turning	I	0,05	0,5	1170	-	1140	-	-	-	-	835	1995	1995	1495
	II	0,08	0,5	975	-	985	-	-	-	695	1945	1945	1460	
	III	0,10	0,5	890	-	915	-	-	-	635	1925	1925	1445	
Finishing turning	I	0,10	1,5	800	-	820	745	580	570	570	1820	1820	1365	
	II	0,15	1,5	680	-	725	660	520	485	485	1785	1785	1340	
	III	0,20	1,5	610	-	660	600	485	435	435	1760	1760	1320	
Semi-roughing turning	I	0,20	2,5	580	-	630	570	460	415	415	-	-	-	
	II	0,30	2,5	495	-	555	505	415	350	350	-	-	-	
	III	0,40	2,5	440	-	505	460	385	315	315	-	-	-	
Roughing turning	I	0,40	5,0	-	-	-	-	-	-	-	-	-	-	
	II	0,60	5,0	-	-	-	-	-	-	-	-	-	-	
	III	0,80	5,0	-	-	-	-	-	-	-	-	-	-	
Heavy roughing turning	I	0,80	12,0	-	-	-	-	-	-	-	-	-	-	
	II	1,00	12,0	-	-	-	-	-	-	-	-	-	-	
	III	1,30	12,0	-	-	-	-	-	-	-	-	-	-	
Parting off, circumferential and contouring (CTP)		0,10	-	-	-	-	-	380	-	-	-	-	-	
		0,15	-	-	-	-	-	365	-	-	-	-	-	
		0,20	-	-	-	-	-	340	-	-	-	-	-	
		0,30	-	-	-	-	-	310	-	-	-	-	-	
Face and internal grooving		0,10	-	-	-	-	-	300	-	-	-	-	-	
		0,15	-	-	-	-	-	290	-	-	-	-	-	
		0,20	-	-	-	-	-	270	-	-	-	-	-	
		0,30	-	-	-	-	-	245	-	-	-	-	-	
Threading		-	-	-	280	-	-	335	-	-	-	-	-	
		-	-	-	255	-	-	310	-	-	-	-	-	
		-	-	-	235	-	-	290	-	-	-	-	-	
		-	-	-	-	-	-	-	-	-	-	-	-	

Table 4b

CHOOSING THE INITIAL MACHINING CONDITIONS - TURNING

ADJUSTMENT v _c			
Subgroup	N1	N2	N3
Adjustment for workpiece material			
Alloy type	k _{vc}		
Aluminum for electrical applications	2,00		
Al alloys formed non-hardened HB60	1,50		
Al alloys formed hardened HB100	1,00		
Al alloys cast non-hardened HB75	0,90		
Al alloys cast hardened HB90	0,65		
Al alloys cast non-hardened HB 130 > 12% Si	1,0 PKD / 0,20		
Subgroup	Subgroup		
Alloy type	k _{vc}		
Very easy to machine alloys (>1% Pb)	0,90		
Brasses and lead bronzes (<1% Pb)	0,75		
Other brasses HB < 90	0,60		
Other brasses HB > 90	0,54		
Electrolytic bronze Cu	0,40		
Hard and very hard bronzes	0,6 PKD / 0,20		
Adjustment for durability (general machining)			
Durability [min]	k _{vr}	Durability [min]	k _{vr}
10	1,10	30	0,84
15	1,00	45	0,76
20	0,93	60	0,71
Adjustment coefficient k _{vc}			
Skin of forging and casting			
0,70 - 0,80			
Internal turning			
0,75 - 0,85			
Interrupted cut			
0,80 - 0,90			
Machine in good condition			
1,05 - 1,20			
Machine in poor condition			
0,85 - 0,95			
Adjustment to the shape of the insert			
Shape of insert			
k _{vc0}			
S..., C..., W...			
1,00			
T..., D..., K...			
0,95			
V..., L..., (parting off and grooving)			
0,88			
R..., L..., (roughing)			
1,10			

Table 5a

CHOOSING THE INITIAL MACHINING CONDITIONS - TURNING

OPERATING CONDITIONS FOR TURNING													
INDEXABLE INSERT TYPE in accordance with ISO	Fine turning		Finishing turning		Semi-finishing turning		Roughing turning		Heavy roughing turning		Parting off, grooving	Threading	
	f = 0.05 ÷ 0.1 [mm/rev] a _p = 0.2 ÷ 1.0 [mm]		f = 0.1 ÷ 0.2 [mm/rev] a _p = 0.8 ÷ 2.0 [mm]		f = 0.2 ÷ 0.4 [mm/rev] a _p = 1.5 ÷ 4.0 [mm]		f = 0.4 ÷ 0.8 [mm/rev] a _p = 4.0 ÷ 10.0 [mm]		f > 1.0 [mm/rev] a _p > 10.0 [mm]				f = 0.5 ÷ 0.3
	Pre-machined surface Uninterrupted cut	Casting, forging Interrupted cut	Pre-machined surface Uninterrupted cut	Casting, forging Interrupted cut	Pre-machined surface Uninterrupted cut	Casting, forging Interrupted cut	Pre-machined surface Uninterrupted cut	Casting, forging Interrupted cut	Pre-machined surface Uninterrupted cut	Casting, forging Interrupted cut			
.A .M .G .U .N .X	T8315	T8315	T6310	T8330	T9325	T7335	T9325	T9325	T8315	T9325	T8315	-	
	FF	FF	SF	NF	SM	SM	RM	RM	RM	RM	-	-	
	T6310	T8330	T9315	T8330	T7335	T7335	T7335	T7335	T7335	T7335	-	-	
	SF	SF	NF	SM	NM(SI)	FM	NR	NR	R	R	-	-	
	-	-	T9315	T8330	T8330	T8330	T7335	T7335	T8330	T8330	-	-	
	-	-	FM	FM	NM(SI)	FM	RM	NR2 (OR)	NR2 (OR)	NR2 (OR)	-	-	
	-	-	T9325	T9325	6640	6640	6640	6640	-	-	-	-	
	-	-	72	72	73 (78)	73 (78)	73 (78)	73 (78)	-	-	-	-	
	-	-	-	-	T9325	T9325	T9325	6640	-	-	-	-	
	-	-	-	-	72	72	74 (79)	74 (79)	-	-	-	-	
.W .T	TT310	T8315	TT310	T8315	T5315	T9315	T5315	T8315	T8315	T9315	-	-	
	UR	FF	UR	FF	RM	RM	RM	RM	RM	RM	-	-	
	T8315	T8330	T9315	T7335	T9315	T7335	T9315	T7335	-	-	-	-	
	FF	FF	FM	FM	RM	RM	RM	RM	-	-	-	-	
	8016	-	T8315	T8330	T7335	T8330	T8330	T8330	-	-	-	-	
	Al	-	UR	FM	RM	RM	RM	RM	-	-	-	-	
	-	-	T9325	T9335	T9325	T9335	T9325	T9335	-	-	-	-	
	-	-	46	46	46	46	46	46	-	-	-	-	
	-	-	T9325	T9335	T9325	T9335	T9325	T9335	-	-	-	-	
	-	-	47	47	47	47	47	47	-	-	-	-	
.R .N	-	-	T9325	T9335	T9325	T9335	T9325	T9335	-	-	-	-	
	-	-	48	48	48	48	48	48	-	-	-	-	
	-	-	III	III	III	III	III	III	-	-	-	-	
	-	-	T8330	T8330	T8330	T8330	T8330	T8330	-	-	-	-	
	-	-	UR	FM	RM	RM	RM	RM	-	-	-	-	
	-	-	T9325	T9335	T9325	T9335	T9325	T9335	-	-	-	-	
	-	-	46	46	46	46	46	46	-	-	-	-	
	-	-	T9325	T9335	T9325	T9335	T9325	T9335	-	-	-	-	
	-	-	47	47	47	47	47	47	-	-	-	-	
	-	-	48	48	48	48	48	48	-	-	-	-	
.X	T8330	T8330	T8330	T8330	T8330	T8330	T8330	T8330	T8330	T8330	T8330	-	
	-	-	-	-	-	-	-	-	-	-	-	-	
	-	-	-	-	-	-	-	-	-	-	-	-	
	-	-	-	-	-	-	-	-	-	-	-	-	
	-	-	-	-	-	-	-	-	-	-	-	-	
	-	-	-	-	-	-	-	-	-	-	-	-	
	-	-	-	-	-	-	-	-	-	-	-	-	
	-	-	-	-	-	-	-	-	-	-	-	-	
	-	-	-	-	-	-	-	-	-	-	-	-	
	-	-	-	-	-	-	-	-	-	-	-	-	
.X	T8330	T8330	T8330	T8330	T8330	T8330	T8330	T8330	T8330	T8330	T8330	-	
	-	-	-	-	-	-	-	-	-	-	-	-	
	-	-	-	-	-	-	-	-	-	-	-	-	
	-	-	-	-	-	-	-	-	-	-	-	-	
	-	-	-	-	-	-	-	-	-	-	-	-	
	-	-	-	-	-	-	-	-	-	-	-	-	
	-	-	-	-	-	-	-	-	-	-	-	-	
	-	-	-	-	-	-	-	-	-	-	-	-	
	-	-	-	-	-	-	-	-	-	-	-	-	
	-	-	-	-	-	-	-	-	-	-	-	-	
.X	T8330	T8330	T8330	T8330	T8330	T8330	T8330	T8330	T8330	T8330	T8330	-	
	-	-	-	-	-	-	-	-	-	-	-	-	
	-	-	-	-	-	-	-	-	-	-	-	-	
	-	-	-	-	-	-	-	-	-	-	-	-	
	-	-	-	-	-	-	-	-	-	-	-	-	
	-	-	-	-	-	-	-	-	-	-	-	-	
	-	-	-	-	-	-	-	-	-	-	-	-	
	-	-	-	-	-	-	-	-	-	-	-	-	
	-	-	-	-	-	-	-	-	-	-	-	-	
	-	-	-	-	-	-	-	-	-	-	-	-	
.X	T8330	T8330	T8330	T8330	T8330	T8330	T8330	T8330	T8330	T8330	T8330	-	
	-	-	-	-	-	-	-	-	-	-	-	-	
	-	-	-	-	-	-	-	-	-	-	-	-	
	-	-	-	-	-	-	-	-	-	-	-	-	
	-	-	-	-	-	-	-	-	-	-	-	-	
	-	-	-	-	-	-	-	-	-	-	-	-	
	-	-	-	-	-	-	-	-	-	-	-	-	
	-	-	-	-	-	-	-	-	-	-	-	-	
	-	-	-	-	-	-	-	-	-	-	-	-	
	-	-	-	-	-	-	-	-	-	-	-	-	
.X	T8330	T8330	T8330	T8330	T8330	T8330	T8330	T8330	T8330	T8330	T8330	-	
	-	-	-	-	-	-	-	-	-	-	-	-	
	-	-	-	-	-	-	-	-	-	-	-	-	
	-	-	-	-	-	-	-	-	-	-	-	-	
	-	-	-	-	-	-	-	-	-	-	-	-	
	-	-	-	-	-	-	-	-	-	-	-	-	
	-	-	-	-	-	-	-	-	-	-	-	-	
	-	-	-	-	-	-	-	-	-	-	-	-	
	-	-	-	-	-	-	-	-	-	-	-	-	
	-	-	-	-	-	-	-	-	-	-	-	-	
.X	T8330	T8330	T8330	T8330	T8330	T8330	T8330	T8330	T8330	T8330	T8330	-	
	-	-	-	-	-	-	-	-	-	-	-	-	
	-	-	-	-	-	-	-	-	-	-	-	-	
	-	-	-	-	-	-	-	-	-	-	-	-	
	-	-	-	-	-	-	-	-	-	-	-	-	
	-	-	-	-	-	-	-	-	-	-	-	-	
	-	-	-	-	-	-	-	-	-	-	-	-	
	-	-	-	-	-	-	-	-	-	-	-	-	
	-	-	-	-	-	-	-	-	-	-	-	-	
	-	-	-	-	-	-	-	-	-	-	-	-	
.X	T8330	T8330	T8330	T8330	T8330	T8330	T8330	T8330	T8330	T8330	T8330	-	
	-	-	-	-	-	-	-	-	-	-	-	-	
	-	-	-	-	-	-	-	-	-	-	-	-	
	-	-	-	-	-	-	-	-	-	-	-	-	
	-	-	-	-	-	-	-	-	-	-	-	-	
	-	-	-	-	-	-	-	-	-	-	-	-	
	-	-	-	-	-	-	-	-	-	-	-	-	
	-	-	-	-	-	-	-	-	-	-	-	-	
	-	-	-	-	-	-	-	-	-	-	-	-	
	-	-	-	-	-	-	-	-	-	-	-	-	

Machined material, main ISO group



Table 5b

CHOOSING THE INITIAL MACHINING CONDITIONS - TURNING

Type of operation		Selection priority		Feeds and depth of cut		S												ADJUSTMENT v_c			
						Adjustment for workpiece hardness												S1	S2	S3	S4
Subgroup	Hardness [HB]	$k_{v,HB}$			$k_{v,HB}$			$k_{v,HB}$			$k_{v,HB}$			$k_{v,HB}$	$k_{v,HB}$	$k_{v,HB}$	$k_{v,HB}$				
	120	2,14	1,46	1,22	0,92																
	140	2,01	1,38	1,15	0,86																
	160	1,93	1,32	1,10	0,83																
	180	1,89	1,30	1,08	0,81																
	200	1,84	1,26	1,05	0,79																
	220	1,80	1,24	1,03	0,77																
	240	1,75	1,20	1,00	0,75																
	260	1,70	1,16	0,97	0,73																
	280	1,61	1,10	0,92	0,69																
	300	1,54	1,06	0,88	0,66																
	320	1,47	1,01	0,84	0,63																
	340	1,40	0,96	0,80	0,60																
	360	1,37	0,94	0,78	0,59																
	375	1,30	0,89	0,74	0,56																
Adjustment for durability (general machining)																					
Durability [min]	$k_{v,c}$	Durability [min]	$k_{v,c}$	Durability [min]	$k_{v,c}$	Durability [min]	$k_{v,c}$	Durability [min]	$k_{v,c}$	Durability [min]	$k_{v,c}$	Durability [min]	$k_{v,c}$	Durability [min]	$k_{v,c}$	Durability [min]	$k_{v,c}$	Durability [min]			
10	1,10	30	0,84																		
15	1,00	45	0,76																		
20	0,93	60	0,71																		
Adjustment coefficient $k_{v,c}$																					
Skin of forging and casting																					
Internal turning																					
Interrupted cut																					
Machine in good condition																					
Machine in poor condition																					
Adjustment to the shape of the insert																					
Shape of insert																					
$S_{1...4}, W_{1...4}$																					
$T_{1...4}, D_{1...4}, K_{1...4}$																					
$V_{1...4}, L_{1...4}$ (parting off and grooving)																					
$R_{1...4}, L_{1...4}$ (roughing)																					

Figures in blue are valid for machining with coolant.

GEOMETRY OF CUTTING INSERTS FOR DRILLING

MILLING TOOLS

MILLING INSERTS

TURNING INSERTS

DRILLING INSERTS

TECHNICAL SECTION

Chip-breaker SCET - SD

Photo 

Group of machined materials

Drilling	P	M	K	N	S	H
----------	---	---	---	---	---	---

Operating diagram

Depth of cut a_p [mm]

Feed f [mm/rev]

Depending on the size of the insert, the type of material machined and the thickness of the tool (see page 175-176)

Description Used for inserts: **SCET - SD**

- Slightly positive geometry with a peripheral stabilising land
- Suitable for peripheral inserts of drill
- Main application area: Materials in groups P and M
- Other application areas: Materials in groups N and S
- Potential application: Materials in group K
- Available in sizes 05, 06, 07, 09, 12 and 15

Range of machining conditions: Unit:

f	see page 175-176	[mm/rev]
-----	------------------	----------

Table:

	a	γ_1	γ
SCET 05	0,04	5	18
SCET 06	0,06	5	18
SCET 07	0,08	5	18
SCET 09	0,1	5	18
SCET 12	0,1	5	18
SCET 15	0,1	5	18

Chip-breaker XPET - SD

Photo 

Group of machined materials

Drilling	P	M	K	N	S	H
----------	---	---	---	---	---	---

Operating diagram

Depth of cut a_p [mm]

Feed f [mm/rev]

Depending on the size of the insert, the type of material machined and the thickness of the tool (see page 175-176)

Description Used for inserts: **XPET AP - SD**

- Positive geometry for central inserts of drill
- Main application area: Materials in groups P and M
- Other application areas: Materials in groups N and S
- Potential application: Materials in group K
- Available in sizes 05, 06, 07, 09, 11, 12, 15 and 19

Range of machining conditions: Unit:

f	see page 175-176	[mm/rev]
-----	------------------	----------

Table:

	a	γ_1	γ
XPET 05	0,04	0	16
XPET 06	0,05	0	16
XPET 07	0,08	0	16
XPET 09	0,1	0	16
XPET 11	0,1	0	16
XPET 12	0,1	0	16
XPET 15	0,1	10	16
XPET 19	0,12	11	16

 For best results use the same SD chip breaker for both inner and outer inserts.

RECOMMENDED MACHINING CONDITIONS FOR INDEXABLE DRILLS

802D / 803D - chip-breaker SD

Pramet Material	Dormer AMG *	D9335		D8330		D8345		Feed f [mm/rev ⁻¹]					
			V _c		V _c		V _c	Ø 15	Ø 20	Ø 25	Ø 30	Ø 40	Ø 58
P1	1.1, 1.2	■	335	■	270	■		0,08	0,09	0,10	0,11	0,14	0,18
P2	1.3	■	250	■	200	■		0,11	0,13	0,15	0,17	0,21	0,28
P3	1.4	□	200	□	160	□		0,13	0,15	0,18	0,20	0,24	0,32
P4	1.5	-	-	-	-	-		-	-	-	-	-	-
M1	2.1	■	140	■	130	■		0,12	0,14	0,16	0,18	0,22	0,30
M2	(2.1, 2.4)	■	135	■	125	■		0,11	0,13	0,15	0,17	0,21	0,28
M3	2.2	□	125	□	115	□		0,07	0,08	0,09	0,10	0,12	0,16
M4	2.3, 2.4	□	120	□	110	□		0,07	0,08	0,09	0,10	0,12	0,16
K1	3.1, 3.2	□	190	□	150	□		0,14	0,16	0,19	0,21	0,26	0,34
K2	3.1, 3.2	-	-	-	-	-		-	-	-	-	-	-
K3	3.3	-	-	-	-	-		-	-	-	-	-	-
K4	3.4	-	-	-	-	-		-	-	-	-	-	-
N1	7.1	□	450	□	400	□		0,13	0,15	0,18	0,20	0,24	0,32
N2	7.2, 7.3, 7.4	□	295	□	260	□		0,13	0,15	0,18	0,20	0,24	0,32
N3	6.1, 6.2, 6.3	■	270	■	240	■		0,13	0,15	0,18	0,20	0,24	0,32
N4	6.4	□	180	□	160	□		0,12	0,14	0,16	0,18	0,22	0,30
S1	4.1, 4.2, 4.3	□	65	□	55	□		0,08	0,09	0,10	0,11	0,14	0,18
S2	5.1, 5.2, 5.3	□	45	□	40	□		0,08	0,09	0,10	0,11	0,14	0,18
S3	5.1, 5.2, 5.3	□	35	□	30	□		0,07	0,08	0,09	0,10	0,12	0,16
S4	5.1, 5.2, 5.3	□	30	□	25	□		0,07	0,08	0,09	0,10	0,12	0,16
H1	1.6	-	-	-	-	-		-	-	-	-	-	-
H2	-	-	-	-	-	-		-	-	-	-	-	-
H3	1.7	-	-	-	-	-		-	-	-	-	-	-
H4	1.8	-	-	-	-	-		-	-	-	-	-	-

804D - chip-breaker SD

Pramet Material	Dormer AMG *	D9335		D8330		D8345		Feed f [mm/rev ⁻¹]					
			V _c		V _c		V _c	Ø 15	Ø 20	Ø 25	Ø 30	Ø 40	Ø 58
P1	1.1, 1.2	■	335	■	270	■		0,07	0,08	0,09	0,10	0,12	0,16
P2	1.3	■	250	■	200	■		0,10	0,12	0,14	0,16	0,19	0,25
P3	1.4	□	200	□	160	□		0,12	0,14	0,16	0,18	0,22	0,30
P4	1.5	-	-	-	-	-		-	-	-	-	-	-
M1	2.1	■	140	■	130	■		0,11	0,13	0,15	0,17	0,21	0,28
M2	(2.1, 2.4)	■	135	■	125	■		0,10	0,12	0,14	0,16	0,19	0,25
M3	2.2	□	125	□	115	□		0,06	0,07	0,08	0,09	0,10	0,14
M4	2.3, 2.4	□	120	□	110	□		0,06	0,07	0,08	0,09	0,10	0,14
K1	3.1, 3.2	□	190	□	150	□		0,13	0,15	0,18	0,20	0,24	0,32
K2	3.1, 3.2	-	-	-	-	-		-	-	-	-	-	-
K3	3.3	-	-	-	-	-		-	-	-	-	-	-
K4	3.4	-	-	-	-	-		-	-	-	-	-	-
N1	7.1	□	450	□	400	□		0,12	0,14	0,16	0,18	0,22	0,30
N2	7.2, 7.3, 7.4	□	295	□	260	□		0,12	0,14	0,16	0,18	0,22	0,30
N3	6.1, 6.2, 6.3	■	270	■	240	■		0,12	0,14	0,16	0,18	0,22	0,30
N4	6.4	□	180	□	160	□		0,11	0,13	0,15	0,17	0,21	0,28
S1	4.1, 4.2, 4.3	□	65	□	55	□		0,07	0,08	0,09	0,10	0,12	0,16
S2	5.1, 5.2, 5.3	□	45	□	40	□		0,07	0,08	0,09	0,10	0,12	0,16
S3	5.1, 5.2, 5.3	□	35	□	30	□		0,06	0,07	0,08	0,09	0,10	0,14
S4	5.1, 5.2, 5.3	□	30	□	25	□		0,06	0,07	0,08	0,09	0,10	0,14
H1	1.6	-	-	-	-	-		-	-	-	-	-	-
H2	-	-	-	-	-	-		-	-	-	-	-	-
H3	1.7	-	-	-	-	-		-	-	-	-	-	-
H4	1.8	-	-	-	-	-		-	-	-	-	-	-

* The material classification code used by Dormer is added here for cross reference purposes and should be used only as a guide.

RECOMMENDED MACHINING CONDITIONS FOR INDEXABLE DRILLS

805D - chip-breaker SD

Pramet Material	Dormer AMG *	D9335		D8330		D8345	Feed f [mm/rev ¹]					
			V _c		V _c		Ø 15	Ø 20	Ø 25	Ø 30	Ø 40	Ø 58
P1	1.1, 1.2	■	270	■	215	■	0,07	0,08	0,09	0,10	0,12	0,16
P2	1.3	■	200	■	160	■	0,10	0,12	0,14	0,16	0,19	0,25
P3	1.4	□	160	□	130	□	0,12	0,14	0,16	0,18	0,22	0,30
P4	1.5	-	-	-	-	-	-	-	-	-	-	-
M1	2.1	■	110	■	105	■	0,11	0,13	0,15	0,17	0,21	0,28
M2	(2.1, 2.4)	■	110	■	100	■	0,10	0,12	0,14	0,16	0,19	0,25
M3	2.2	□	100	□	95	□	0,06	0,07	0,08	0,09	0,10	0,14
M4	2.3, 2.4	□	95	□	90	□	0,06	0,07	0,08	0,09	0,10	0,14
K1	3.1, 3.2	□	155	□	120	□	0,13	0,15	0,18	0,20	0,24	0,32
K2	3.1, 3.2	-	-	-	-	-	-	-	-	-	-	-
K3	3.3	-	-	-	-	-	-	-	-	-	-	-
K4	3.4	-	-	-	-	-	-	-	-	-	-	-
N1	7.1	□	360	□	320	□	0,12	0,14	0,16	0,18	0,22	0,30
N2	7.2, 7.3, 7.4	□	235	□	210	□	0,12	0,14	0,16	0,18	0,22	0,30
N3	6.1, 6.2, 6.3	■	220	■	195	■	0,12	0,14	0,16	0,18	0,22	0,30
N4	6.4	□	145	□	130	□	0,11	0,13	0,15	0,17	0,21	0,28
S1	4.1, 4.2, 4.3	□	50	□	45	□	0,07	0,08	0,09	0,10	0,12	0,16
S2	5.1, 5.2, 5.3	□	35	□	30	□	0,07	0,08	0,09	0,10	0,12	0,16
S3	5.1, 5.2, 5.3	□	30	□	25	□	0,06	0,07	0,08	0,09	0,10	0,14
S4	5.1, 5.2, 5.3	□	25	□	20	□	0,06	0,07	0,08	0,09	0,10	0,14
H1	1.6	-	-	-	-	-	-	-	-	-	-	-
H2	-	-	-	-	-	-	-	-	-	-	-	-
H3	1.7	-	-	-	-	-	-	-	-	-	-	-
H4	1.8	-	-	-	-	-	-	-	-	-	-	-

* The material classification code used by Dormer is added here for cross reference purposes and should be used only as a guide.

SIMPLY RELIABLE

As a professional you can judge the quality of work by just looking at the chip. Our chip is a clean and uncomplicated shape that in itself tells a story. It is a clear and consistent signal and that's why we use it as a symbol for being **simply reliable**.

Argentina

T: 54 (11) 6777-6777
F: 54 (11) 4441-4467
info.ar@dormerpramet.com

Australia

T: 1300 131 274
F: +61 3 9238 7105
info.int@dormerpramet.com

Brazil

responsible for **Bolivia, Panama, Chile, Paraguay, Colombia, Peru, Costa Rica, Uruguay, Ecuador, Venezuela, Guatemala**
T: +55 11 5660 3000
F: +55 11 5667 5883
info.br@dormerpramet.com

Canada

T: (888) 336 7637
En Français: (888) 368 8457
F: (905) 542 7000
cs.canada@dormerpramet.com

Czech Republic

responsible for export CEE: **Albania, Belarus, Bosnia - Herzegovina, Bulgaria, Croatia, Estonia, Kazakistan, Latvia, Lithuania, Macedonia, Montenegro, Romania, Serbia, Slovenia, Ukraine**
T: +420 583 381 111
F: +420 583 215 401
info.cz@dormerpramet.com

Denmark

T: +46 35 16 52 00
F: +46 35 16 52 90
info.se@dormerpramet.com
Kundtjeneste
T: direkt 808 82106
F: direkt +46 35 16 52 90

Finland

T: +358 205 44 121
F: +358 205 44 5199
Asiakaspalvelu
T: suora 0205 44 7003
F: suora 0205 44 7004
info.fi@dormerpramet.com

France

T: +33 (0)2 47 62 57 01
F: +33 (0)2 47 62 52 00
info.fr@dormerpramet.com

Germany

T: +49 9131 933 08 70
F: +49 9131 933 08 742
info.de@dormerpramet.com

Hungary

T: +36-96 / 522-846
F: +36-96 / 522-847
info.hu@dormerpramet.com

China

T: +86 21 24160508
F: +86 54426315
info.cn@dormerpramet.com

India

T: +91 124 470 3825
info.in@dormerpramet.com

Italy

solid tools:
T: +39 02 38 04 51
F: +39 02 38 04 52 43
info.it@dormerpramet.com
indexable tools:
T: +39 0523 55 19 11
F: +39 0523 55 18 00
info@impero-tools.com

Netherlands

T: +31 10 2080 240
F: +31 10 2080 282
info.nl@dormerpramet.com
responsible for **Austria**
T: +31 10 2080 212
F: +31 10 2080 282
info.at@dormerpramet.com
responsible for **Belgium**
T: +32 3 440 59 01
F: +32 3 449 15 43
info.be@dormerpramet.com
responsible for **Switzerland**
T: +31 10 2080 212
F: +31 10 2080 282
info.ch@dormerpramet.com

New Zealand

T: +64 9 2735858
F: +64 9 2735857
info.int@dormerpramet.com

Norway

T: +46 35 16 52 00
F: +46 35 16 52 90
info.se@dormerpramet.com
Kundeservice
T: direkt 800 10 113
F: direkt +46 35 16 52 90

Poland

T: +48 32 78-15-890
F: +48 32 78-60-406
info.pl@dormerpramet.com

Russia

T: +7 495 775 10 28
info.ru@dormerpramet.com

Slovakia

T: +421 417 645 659
F: +421 417 637 449
info.sk@dormerpramet.com

Spain

T: +34 935717722
F: +34 935717765
info.es@dormerpramet.com
responsible for **Portugal**
T: +351 21 424 54 21
F: +351 21 424 54 25
info.pt@dormerpramet.com

Sweden

responsible for **Iceland**
T: +46 (0) 35 16 52 00
F: +46 (0) 35 16 52 90
info.se@dormerpramet.com
Kundeservice
T: direkt +46 35 16 52 96
F: direkt +46 35 16 52 90

United Kingdom

responsible for **Ireland**
T: 0870 850 4466
F: 0870 850 8866
info.uk@dormerpramet.com

United States of America

responsible for **Mexico**
T: (800) 877-3745
F: (847) 783-5760
cs@dormerpramet.com

Rest of the World

Dormer Pramet International UK
T: +44 1246 571338
F: +44 1246 571339
info.int@dormerpramet.com

Dormer Pramet International CZ
T: +420 583 381 520
F: +420 583 215 401
info.int.cz@dormerpramet.com

CAT-PRA-NEWS-2015-2-EN