

**Riten**<sup>®</sup>

**SOLUTIONS, NOT EXCUSES**



**Live Centers**



**Dead Centers**



**Face Drivers**



**Engineered Products**

**More than  
centers**

**Fifth Edition**



# Quality workholding since 1933

## What's New?

*This catalog expands the world's largest selection of Live & Dead Centers and Face Drivers with new workholding products:*

- [Adjustable point live centers](#)
- [Quick Point dead centers](#)
- [90° point dead centers](#)
- [Low profile live centers](#)
- [Adapter sleeves](#)
- [Disk face drivers](#)

*Many other products have been redesigned to cover broader applications.*

*On-time delivery is assured through our worldwide network of stocking distributors and representatives. Our quality system is certified annually to meet the demanding requirements of **ISO-9001:2015**.*

*If you don't see the exact center or face driver needed for your unique application, Riten will make it for you. Special products are a major part of our business. For specifics, [see pages 41 and 42](#), visit [www.riten.com](http://www.riten.com), or call our technical service people at 1-800-338-0027.*

## Live & Dead Center Selection Guide

The selection guide below gives you an overview of centers available by basic application. Check individual models to determine accuracies, point types, tapers, workpiece weights, dimensions, and any special features.



### CNC Lathe

High RPM live and dead centers for precision turning applications. Pages 4-11.



### Turning and Grinding

Live centers for maximum workpiece weights ranging from 1,000 to 450,000 lbs. Pages 12-18.



### Precision Grinding

High accuracy live centers and a broad selection of dead centers. Pages 19-24.



### Large Bore

Live and dead centers for large bore parts, including-pipe, tubing, rolls, hydraulic cylinders, and similar workpieces. Pages 25-30.



### Special Purpose

Live centers designed for unique applications: spline rolling, medical and lightweight components, and workpieces requiring linear compensation in the live center. Pages 31-39.



# Contents

## Live and Dead Centers

■ Engineered for Accuracy and Durability.....	3
■ C4T Live Centers .....	4
■ CNC High RPM Sprint Live Centers.....	5
■ CNC Heavy Duty Live Centers .....	6
■ CNC Standard Dead Centers.....	7
■ CNC Mazak Dead Centers .....	8
■ Quick Point Live Centers, Dead Centers & Sets.....	9
■ Quick Point Replacement Points.....	10
■ CNC Carbide Tipped Live Centers.....	11
■ Advantage Live Centers .....	12
■ Regal Live Centers.....	13
■ Econo Live Centers .....	14
■ Low Profile Live Centers.....	15
■ Light & Extra-Light Live Centers.....	16
■ Heavy-Duty & Extra Heavy-Duty Live Centers .....	17
■ Super Duty Live Centers .....	18
■ Standard Length Full & Half Dead Centers .....	19-20
■ Imperial Large Carbide Point Dead Centers.....	21
■ 60° & 90° Standard & Long Dead Centers .....	22
■ Special Carbide Tipped Full & Half Dead Centers .....	23
■ Super Accurate Live Centers.....	24
■ Pipe Nose and Bull Nose Dead Centers.....	25
■ Special Carbide Tipped Bull Nose Dead Centers .....	26
■ Bull Nose Live Centers .....	27
■ Precision Bull Nose Live Centers.....	28
■ Pipe Nose Live Centers .....	29
■ Multi-Use Live Centers.....	30
■ Concentric Spring Loaded Live Centers.....	31-33
■ GPRTOPS Spring Loaded Live Centers .....	34
■ Ready Tool, Replacement Live Centers .....	35
■ Adjusta-Point Live Centers.....	36
■ Spline Rolling Live Centers.....	37
■ Raptor Gear Cutting Live Centers .....	38
■ Metal Spinning Live Centers.....	39
■ Repair/Trade-In & Center Survey Programs .....	40
■ Special Live and Dead Center Drawings .....	41-42

## Engineered Workholding Products

■ Rebuilding and Repair Services .....	43
■ Live Chuck Mandrels, Linear Compensating .....	44
■ Replaceable Bell Head Live & Dead Centers.....	45
■ Pipe Drivers, Spider Mandrel .....	46
■ Adapter Sleeves, Center Extractors.....	47
■ Tailstock Force Gauge Kit.....	48
■ Center Drill Machine.....	49

## Face Drivers

■ Introduction to Face Driving .....	50
■ Face Driver Selection and Sizing.....	51
■ Information Request Form .....	52
■ Installation and Setup .....	53
■ Running Off the Driver .....	54
■ Disk Driver .....	55
■ Mechanical, Type 40 .....	56
■ Mechanical, Type 41 .....	57
■ Mechanical, Type 42 .....	58
■ Mechanical, Type 43 .....	59
■ Mechanical, Type 44 .....	60
■ Mechanical, Type 45 .....	61
■ Mechanical, Type 46 .....	62
■ Mechanical, Type 47 .....	63
■ Mechanical, Type 48 .....	64
■ Mechanical, Type 49 .....	65
■ Mechanical, Type 50 .....	66
■ Actuated Driver, Quick Change Spindle Adapter...67	
■ Hydraulic, Type 62 .....	68
■ Hydraulic, Types 63 and 64 .....	69
■ Hydraulic, Types 66 and 68 .....	70
■ Face Driver Care and Maintenance .....	71-72
■ Face Driver Drawings and Dimensions .....	73-74
■ Calculation of Tailstock Forces .....	75
■ Web Site Information.....	76

*Product drawings and videos  
available on our website.*



# Engineered for accuracy and durability

## Precision Design = Life = Value

Unlike other manufacturers, Riten Industries concentrates solely on the science of rotational workholding. We are committed to serving our customers with the ultimate in centering technology, and direct all our energies to being the best there is. That's why our motto is "**Solutions, not excuses**".

With workpiece capabilities from 4 ounces to more than 200,000 pounds, an industry-leading .00008 TIR, and the world's largest selection of standard and custom models, Riten offers the widest range of workholding options to satisfy today's global manufacturing requirements.

The Riten **threaded seal adapter/retainer** allows easy bearing access and is lapped to be parallel to the bearing face. This guarantees that the seal adapter makes complete contact with the face of the bearing for consistent accuracy and rigidity.

**Perpendicularity** is paramount in the manufacture of a precision live center. With the latest in CNC grinding technology, each bearing shoulder is held to within  $\pm .0001$  TIR perpendicular to the centerline of the taper shank, conforming to strict international DIN standards. This precision is crucial for obtaining maximum rigidity and service life.

Riten's **gageline cross section**, together with our robust spindle construction, is designed to produce exceptional resistance to deflection.

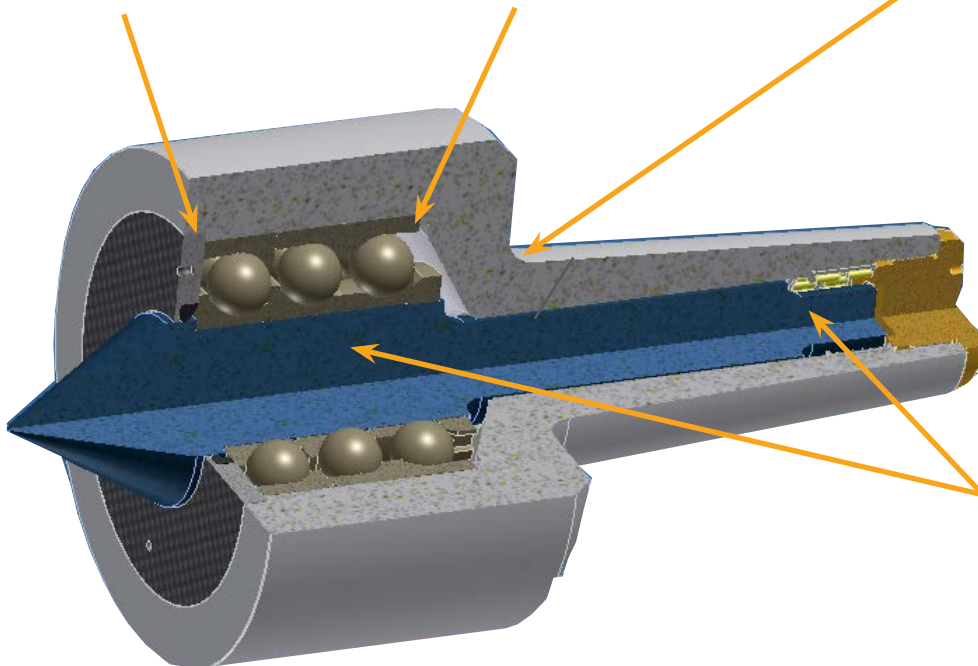

Some manufacturers claim that their stubbed spindle design is superior. The truth is it's simply less expensive to manufacture. The Riten **full length spindle design** is supported by multiple bearings which spread the load over the full length of the taper. Riten bearing bores are ground concentric and coaxial to the taper in one operation to  $\pm .0001$  TIR. This combination assures maximum bearing life and accuracy. Through precisely calculated fulcrum positioning, the full length spindle maintains maximum rigidity, dampens vibration, and will flex rather than break when subject to severe moment loads. This unique design is especially important when supporting heavier workpieces.



# C4T\* Live Centers

## Standard, Tracer and Long Point

The first and only live center with permanent bearing protection

- Accuracy guaranteed to  $\pm .00004$
- Ideal for applications which use high-pressure coolant
- Inpro/Seal bronze non-contacting bearing isolator seal turns freely, runs cooler, and will never wear out
- Optional Quick Point design
- Point configuration allows for tool clearance
- Riten full service and repair



Contaminants are captured in the outer labyrinth path and expelled through a port.

Inner section of labyrinth seals in bearing lubricant.

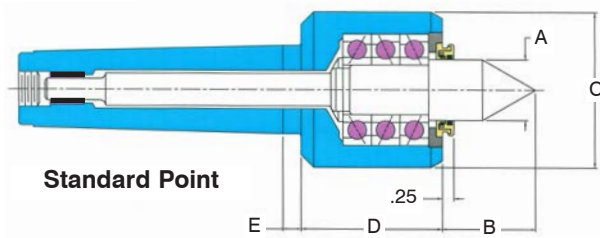

STANDARD POINT - MORSE TAPER									
Model	MT	A	B	C	D	E	Max. RPM	W. P. Weight	
53604	4	1.38	1.82	3.07	2.78	0.36	5000	2200	
53605	5	1.38	1.82	3.07	2.78	0.36	5000	5000	

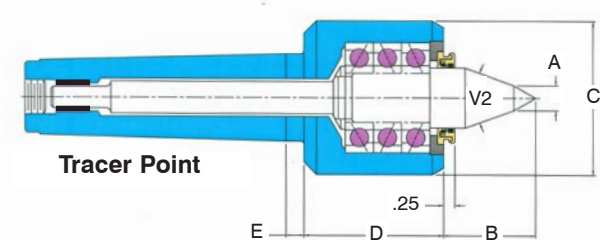

TRACER POINT - MORSE TAPER									
Model	MT	A	B	C	D	E	V2	Max. RPM	W. P. Weight
53904	4	0.56	2.25	3.07	2.78	0.36	40°	5000	1700
53905	5	0.56	2.25	3.07	2.78	0.36	40°	5000	1700

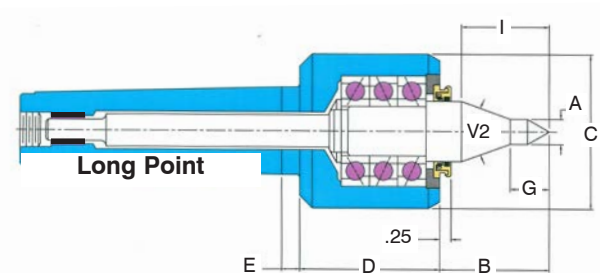

LONG POINT - MORSE TAPER											
Model	MT	A	B	C	D	E	G	V2	I	Max. RPM	W. P. Weight
53104	4	0.50	2.63	3.07	2.78	0.36	0.75	40°	1.96	5000	1100
53105	5	0.50	2.63	3.07	2.78	0.36	0.75	40°	1.96	5000	1100



# CNC High RPM Sprint Live Centers

## Standard, Tracer and Long Point

- Accuracy guaranteed to  $\pm .00004$
- The largest, toughest bearing set available in centers of this size
- Coolant deflectors for additional protection from contamination
- Points through-hardened to 61-63 Rc
- Body heat-treated for additional strength
- Riten full service and repair

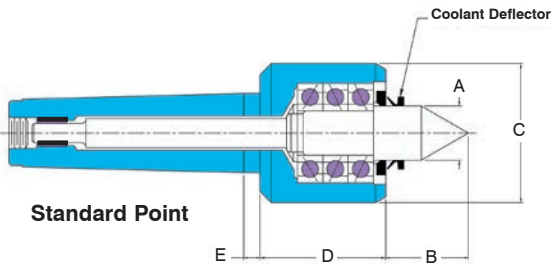

STANDARD POINT - MORSE TAPER									
Model	MT	A	B	C	D	E	Max. RPM	W. P.	Weight
14604	4	1.38	1.82	3.07	2.78	0.36	5000	2200	
14605	5	1.57	2.38	3.07	2.78	0.36	5000	5000	

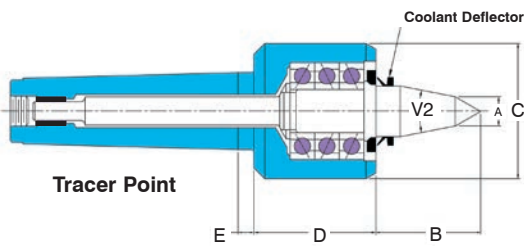

TRACER POINT - MORSE TAPER										
Model	MT	A	B	C	D	E	V2	Max. RPM	W. P.	Weight
14904	4	0.56	2.25	3.07	2.78	0.36	40°	5000	1700	
14905	5	0.56	2.25	3.07	2.78	0.36	40°	5000	1700	

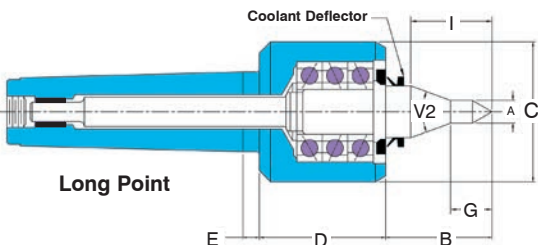

LONG POINT - MORSE TAPER												
Model	MT	A	B	C	D	E	G	V2	I	Max. RPM	W. P.	Weight
14104	4	0.50	2.63	3.07	2.78	0.36	.75	40°	1.96	5000	1100	
14105	5	0.50	2.63	3.07	2.78	0.36	.75	40°	1.96	5000	1100	



# CNC Heavy Duty Live Centers

## Standard and Tracer Point

- Accuracy guaranteed to  $\pm .00005$
- May be used in conjunction with Face Drivers
- Large workpieces in CNC applications
- Coolant deflectors for additional protection from contamination
- Riten full service and repair

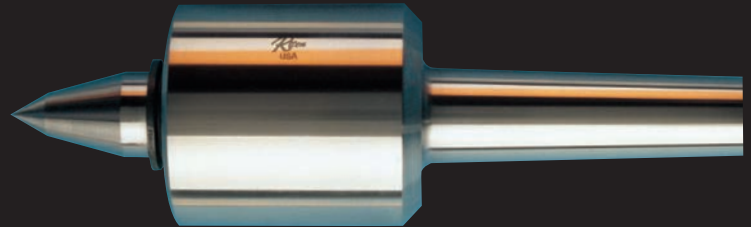

These CNC live centers are used to counter the high thrust in face driving applications. These centers are also used where workpieces weigh up to several thousand pounds. Radial pressure, thrust and rigidity requirements demand centers with a four-bearing design to handle these loads.

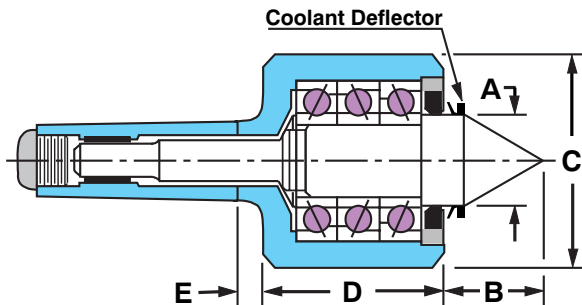

Standard Point

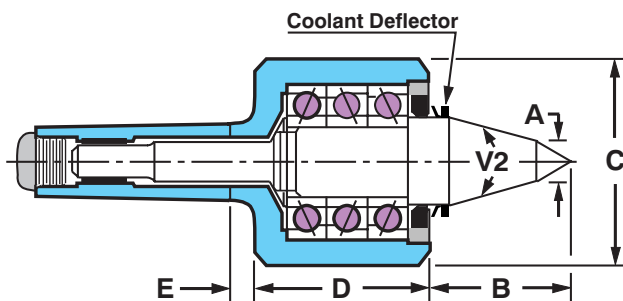

Tracer Point

### STANDARD POINT – MORSE TAPER

Model	MT	A	B	C	D	E	Max. RPM	W. P. Weight
15103*	3	1.26	1.50	2.81	3.19	0.50	5000	3000
15164*	4	1.65	1.75	3.77	3.84	0.50	4000	4800
15165	5	1.87	2.25	3.77	3.84	0.50	4000	8000
15105	5	1.99	2.26	4.63	3.84	0.50	4000	12000
15106	6	2.00	2.26	4.63	3.84	0.60	4000	14000

\* Stub spindle design on 3MT and 4MT.

### TRACER POINT – MORSE TAPER

Model	MT	A	B	C	D	E	V2	Max. RPM	W. P. Weight
16103*	3	0.50	2.06	2.81	3.19	0.50	40°	5000	1100
16194*	4	0.63	2.53	3.77	3.84	0.50	30°	4500	1800
16195	5	0.63	2.78	3.77	3.84	0.50	30°	4000	2500
16105	5	0.94	3.28	4.63	3.84	0.50	30°	4000	3750
16106	6	0.94	3.28	4.63	3.84	0.60	30°	4000	3750

\* Stub spindle design on 3MT and 4MT.



# CNC Dead Centers

## Steel and Carbide Tipped

- Accuracy guaranteed to  $\pm .00005$
- Through-hardened to 61-63 Rc
- Meets the rigid requirements of CNC turning
- All stock items
- Riten full service and repair



Type 1



Type 2

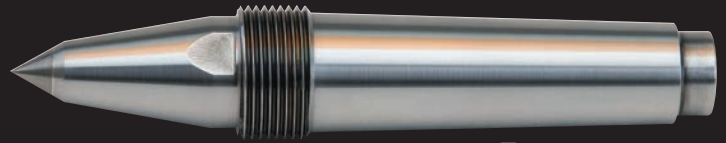

Type 3

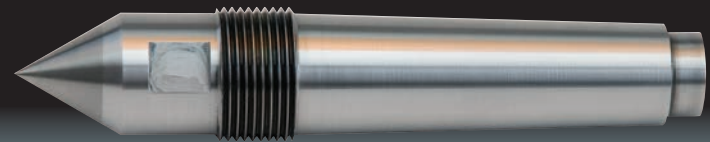

Type 4

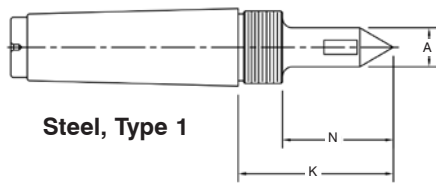

Steel, Type 1

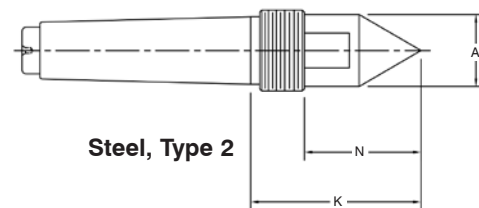

Steel, Type 2

STEEL, TYPE 1, MORSE TAPER						
Model	MT	A	N	K	Threads	Nut
68102	2	0.38	1.25	1.69	7/8 -14	81031
68113	3	0.38	1.25	1.69	7/8 -14	81031
68103	3	0.50	2.00	2.44	7/8 -14	81031
68123	3	0.75	2.00	2.44	7/8 -14	81031
68114	4	0.50	2.00	2.63	11/8 -12	81041
68104	4	0.63	2.25	2.88	11/8 -12	81041
68124	4	1.00	2.25	2.88	11/8 -12	81041
68115	5	0.50	2.00	2.95	15/8 -12	81051
68105	5	0.88	2.50	3.44	15/8 -12	81051
68125	5	1.25	2.50	3.44	15/8 -12	81051
68106	6	1.75	3.69	5.26	2 1/2 -12	86061

STEEL, TYPE 2, MORSE TAPER						
Model	MT	A	N	K	Threads	Nut
68603	3	1.00	1.63	2.37	11/8 - 12	81041
68604	4	1.25	2.03	2.94	13/8 - 12	86041
68605	5	1.75	2.46	3.62	17/8 - 12	86051
68606	6	2.25	3.69	5.25	2 1/2 -12	86061

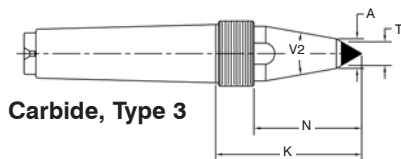

Carbide, Type 3

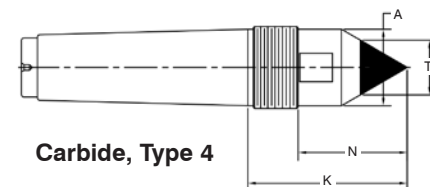

Carbide, Type 4

CARBIDE TIPPED, TYPE 3, MORSE TAPER								
Model	MT	T	A	N	K	V2	Threads	Nut
68923	3	0.38	0.50	2.00	2.62	20°	11/8 - 12	81041
68924	4	0.50	0.63	2.28	3.09	20°	13/8 - 12	86041
68925	5	0.50	0.63	2.50	3.44	20°	15/8 - 12	81051

CARBIDE TIPPED, TYPE 4, MORSE TAPER								
Model	MT	T	A	N	K	Threads	Nut	
68913	3	0.75	1.00	1.62	2.37	11/8 - 12	81041	
68914	4	1.00	1.25	2.02	2.93	13/8 - 12	86041	
68915	5	1.25	1.75	2.50	3.66	17/8 - 12	86051	





# Mazak CNC Dead Centers

## Special tapers for Mazak machines

- Accuracy guaranteed to  $\pm .00005$
- Through-hardened to 61-63 Rc
- Meets the rigid requirements of CNC turning
- All stock items
- Riten full service and repair

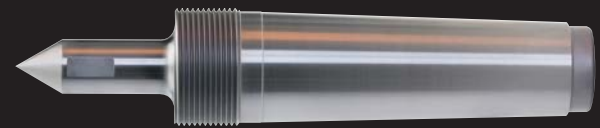

Type 1

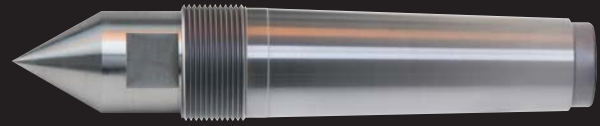

Type 2



Type 3



Type 4

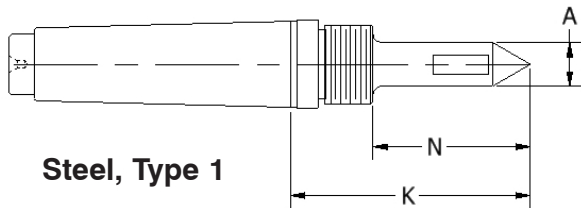

Steel, Type 1

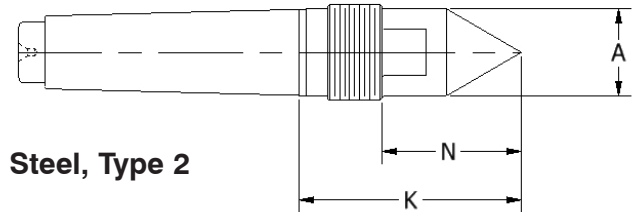

Steel, Type 2

STEEL, TYPE 1, MORSE TAPER						
Model	MT	A	N	K	Threads	Nut
68184	4	0.63	2.25	3.32	11/8 -12	81041
68185	5	0.88	2.50	3.98	17/8 -12	86051
68186	6	1.75	3.69	5.83	2 1/2 -12	86061

STEEL, TYPE 2, MORSE TAPER						
Model	MT	A	N	K	Threads	Nut
68684	4	1.25	2.04	3.23	13/8 -12	86041
68685	5	1.75	2.52	4.00	17/8 -12	86051
68686	6	2.63	2.75	5.07	3 -12	86062

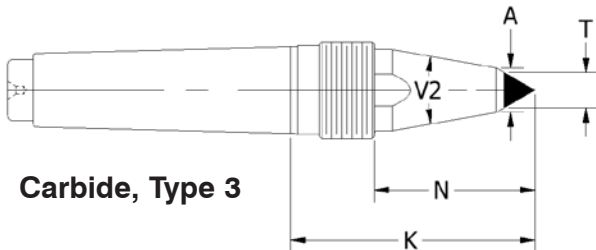

Carbide, Type 3

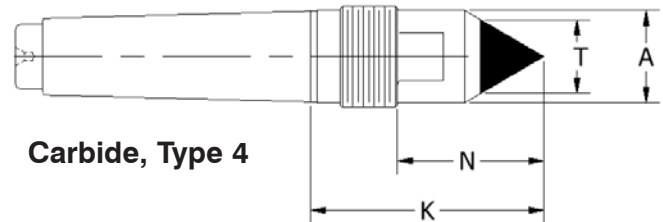

Carbide, Type 4

CARBIDE TIPPED, TYPE 3, MORSE TAPER								
Model	MT	T	A	N	K	V2	Threads	Nut
68984	4	0.50	0.63	2.28	3.47	20°	13/8 - 12	86041
68985	5	0.50	0.63	2.50	3.95	20°	15/8 - 12	81051

CARBIDE TIPPED, TYPE 4, MORSE TAPER								
Model	MT	T	A	N	K	Threads	Nut	
68974	4	1.00	1.25	2.00	3.19	13/8 - 12	86041	
68975	5	1.25	1.75	2.52	4.00	17/8 - 12	86051	



## Quick Point Live Centers, Dead Centers and Sets

- Accuracy guaranteed to  $\pm .00025$ .
- Interchangeable points reduce the need for several centers.
- Purchase individual replacement points or a complete set.
- Special points are available upon request.
- Mounting taper of points is 1:10.
- Safe storage container provided with a complete set.
- Point extractor for easy removal of points is included in the set or can be purchased separately.
- Optional C4T labyrinth bearing seal ([see page 4](#))

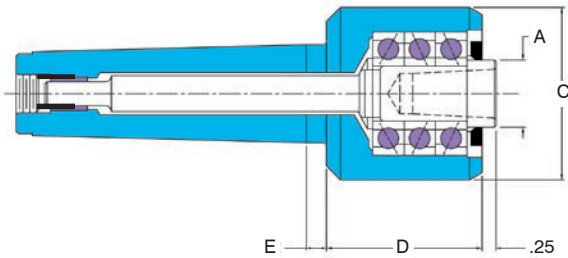

A Quick Point Set includes: one live center, one male point, one female point, one tracer point, one bull nose point, and one point extractor.

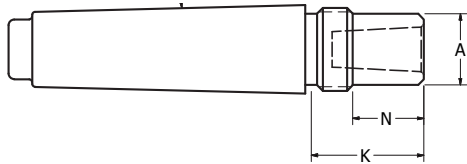

A Quick Point Set includes: one dead center, one tracer point, one bull nose point, one carbide tip point, one male point, one half point, and one point extractor.

LIVE CENTER*							
Model	MT	A	C	D	E	Max. RP	W. P. Weight
49102	2	0.98	2.13	2.00	0.38	5000	100
49103	3	0.98	2.13	2.00	0.37	5000	350
49104	4	1.38	3.07	2.78	0.36	5000	550
49105	5	1.57	3.07	2.78	0.36	5000	1400

\*Live Center includes male point unless otherwise specified.

CNC DEAD CENTER							
Model	MT	A	N	K	Threads	Nut	
68323	3	0.75	0.75	1.19	7/8 - 14	81031	
68324	4	1.00	0.75	1.44	11/8 - 12	81041	
68325	5	1.25	0.74	1.62	15/8 - 12	81051	
68384*	4	1.25	0.75	1.94	13/8 - 12	86041	
68385*	5	1.75	0.75	2.24	17/8 - 12	86051	

\* Special taper for Mazak machines  
Note: Dead center does not include a point.

### LIVE CENTER SETS

Model	Taper
49502	2
49503	3
49504	4
49505	5

### DEAD CENTER SETS

Model	Taper	Mazak
68303	3	-
68304	4	68394
68305	5	68395

### POINT EXTRACTORS

Model	Taper
49904	2, 3, 4
49905	5





## Quick Point Replacement Points

- Accuracy guaranteed to  $\pm .0002$ .
- Interchangeable points reduce the need for several centers.
- Purchase individual replacement points or a complete set.
- Special points are available upon request.
- Mounting taper of points is 1:10.
- Safe storage container provided with a complete set.
- Point extractor for easy removal of points is included in the set or can be purchased separately.

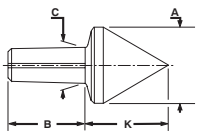
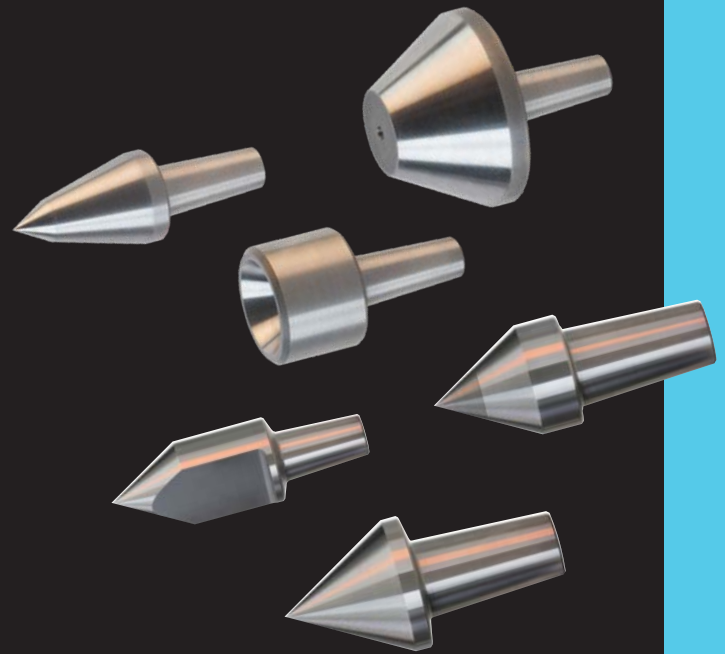

M - Male Point

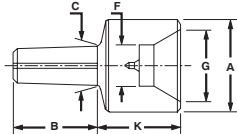

F - Female Point

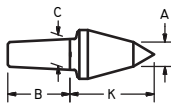

T - Tracer Point

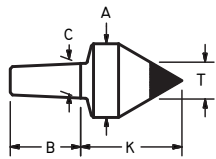

CT - Carbide Tip Male Point

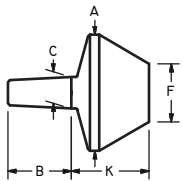

BN - Bull Nose Point

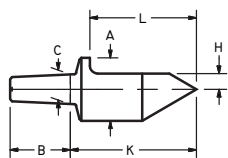

HP - Half Point

### QUICK POINTS

Model	MT	Style	A	F	G	K	C	B	T	H	L
91031	2/3	M	1.00	-	-	1.17	0.47	0.96	-	-	-
91032	2/3	F	1.13	0.50	0.88	1.07	0.47	0.96	-	-	-
91033	2/3	T	0.38	-	-	1.30	0.47	0.96	-	-	-
91034	2/3	BN	1.75	0.88	-	1.17	0.47	0.96	-	-	-
91035	2/3	CT	1.00	-	-	1.38	0.47	0.96	0.50	-	-
91036	2/3	HP	1.00	-	-	2.00	0.47	0.96	-	0.25	1.69
91041	4	M	1.13	-	-	1.30	0.59	1.20	-	-	-
91042	4	F	1.38	0.63	1.13	1.21	0.59	1.20	-	-	-
91043	4	T	0.50	-	-	1.80	0.59	1.20	-	-	-
91044	4	BN	2.25	1.00	-	1.55	0.59	1.20	-	-	-
91045	4	CT	1.00	-	-	1.38	0.59	1.20	0.50	-	-
91046	4	HP	1.13	-	-	2.55	0.59	1.20	-	0.25	2.25
91051	5	M	1.50	-	-	1.65	0.87	1.44	-	-	-
91052	5	F	1.50	0.75	1.25	1.21	0.87	1.44	-	-	-
91053	5	T	0.50	-	-	2.12	0.87	1.44	-	-	-
91054	5	BN	2.75	1.50	-	1.58	0.87	1.44	-	-	-
91055	5	CT	1.25	-	-	1.69	0.87	1.44	0.63	-	-
91056	5	HP	1.50	-	-	3.06	0.87	1.44	-	0.38	2.75



# Sprint and Advantage Carbide Tipped Live Centers

## Standard and Tracer Point

- Accuracy guaranteed to  $\pm .00005$
- Four bearing design for superior performance
- Points are through-hardened to 61-63 Rc
- Full-length spindle for extra rigidity
- Less tailstock pressure required
- Body heat-treated for additional strength
- Riten full service and repair

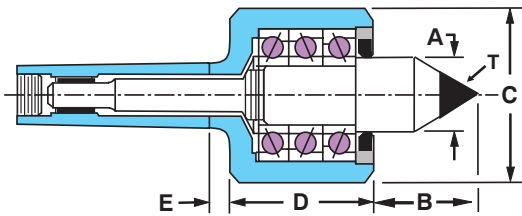
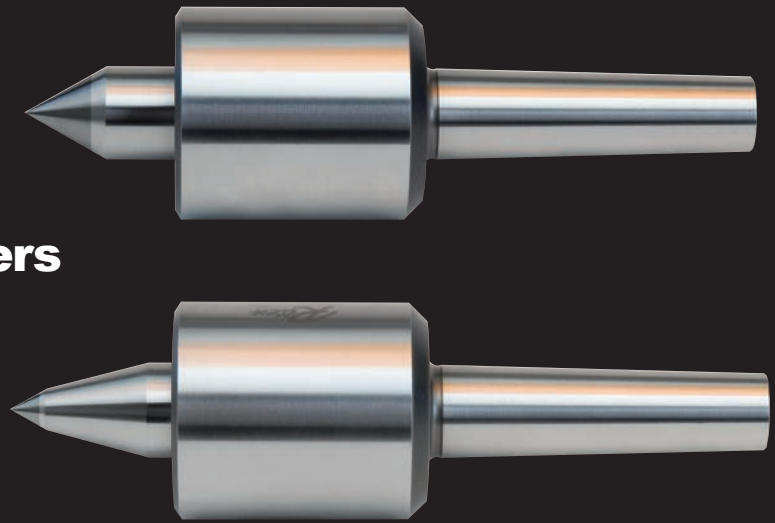

Standard Point

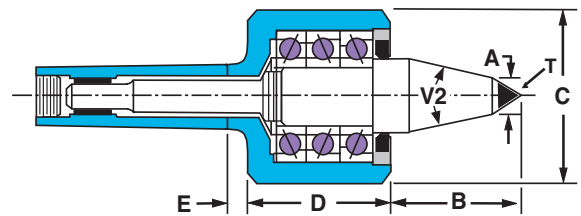

Tracer Point

### ADVANTAGE STANDARD POINT - MORSE TAPER

Model	MT	A	B	C	D	E	T*	Max. RPM	W. P. Weight
51692	2	0.87	1.12	1.75	2.37	0.38	0.50	5000	500
51693	3	0.87	1.12	1.75	2.37	0.38	0.50	5000	500
51694	4	1.26	2.00	2.88	3.32	0.38	0.88	5000	2200
51695	5	1.26	2.00	2.88	3.32	0.38	0.88	5000	2200

\* Carbide tip diameter

### ADVANTAGE TRACER POINT - MORSE TAPER

Model	MT	A	B	C	D	E	T*	V2	Max. RPM	W. P. Weight
51992	2	0.50	1.75	1.75	2.37	0.38	0.38	30°	5000	200
51993	3	0.50	1.75	1.75	2.37	0.38	0.38	30°	5000	200
51994	4	0.63	2.13	2.88	3.32	0.38	0.50	30°	5000	500
51995	5	0.63	2.13	2.88	3.32	0.38	0.50	30°	5000	500

\* Carbide tip diameter

### SPRINT STANDARD POINT - MORSE TAPER

Model	MT	A	B	C	D	E	T*	Max. RPM	W. P. Weight
14694	4	1.38	1.82	3.07	2.78	0.36	0.88	5000	2200
14695	5	1.57	2.38	3.07	2.78	0.36	1.00	5000	2500

\* Carbide tip diameter

### SPRINT TRACER POINT - MORSE TAPER

Model	MT	A	B	C	D	E	T*	V2	Max. RPM	W. P. Weight
14194	4	0.56	2.25	3.07	2.78	0.36	0.50	40°	5000	500
14195	5	0.75	2.26	3.07	2.78	0.36	0.63	40°	5000	800

\* Carbide tip diameter



## Advantage Live Centers Standard, Tracer and Long Point

- Accuracy guaranteed to  $\pm .00005$
- Four bearing design for superior performance
- Points are through-hardened to 61-63 Rc
- Full-length spindle for extra rigidity
- Less tailstock pressure required
- Body heat-treated for additional strength
- Riten full service and repair

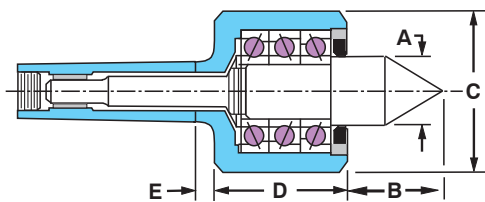
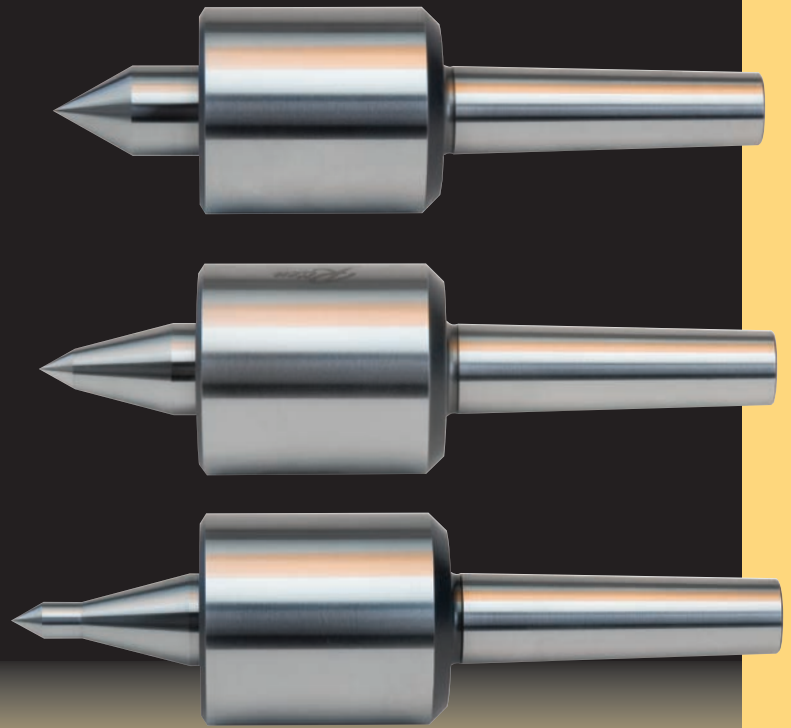

Standard Point

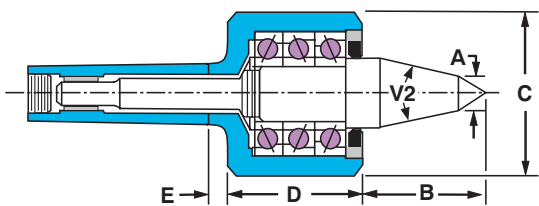

Tracer Point

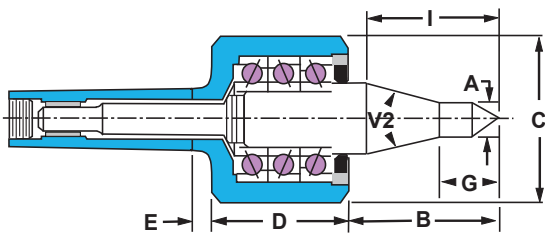

Long Point

### STANDARD POINT - MORSE TAPER

Model	MT	A	B	C	D	E	Max. RPM	W. P. Weight
51602	2	0.87	1.12	1.75	2.37	0.38	5000	880
51603	3	0.87	1.12	1.75	2.37	0.38	5000	920
51604	4	1.26	2.00	2.88	3.32	0.38	5000	2200
51605	5	1.26	2.00	2.88	3.32	0.38	5000	4400
51606	6	1.87	2.25	3.77	3.84	0.50	4000	8000

### TRACER POINT - MORSE TAPER

Model	MT	A	B	C	D	E	V2	Max. RPM	W. P. Weight
51902	2	0.38	1.75	1.75	2.37	0.38	30°	5000	750
51903	3	0.38	1.75	1.75	2.37	0.38	30°	5000	750
51904	4	0.56	2.13	2.88	3.32	0.38	30°	5000	1700
51905	5	0.56	2.13	2.88	3.32	0.38	30°	5000	1700
51906	6	0.63	2.78	3.77	3.84	0.50	30°	4000	2200

### LONG POINT - MORSE TAPER

Model	MT	A	B	C	D	E	G	V2	I	Max. RPM	W. P. Weight
51102	2	0.38	2.00	1.75	2.37	0.38	0.75	30°	1.67	5000	310
51103	3	0.38	2.00	1.75	2.37	0.38	0.75	30°	1.67	5000	310
51104	4	0.50	2.50	2.88	3.32	0.38	0.94	30°	2.35	5500	1100
51105	5	0.50	2.50	2.88	3.32	0.38	0.94	30°	2.35	5500	1100



## Regal Live Centers Standard and Long Point

- Accuracy guaranteed to  $\pm .00005$
- Points are through-hardened to 61-63 Rc
- Full-length spindle for extra rigidity
- Two angular contact bearings for superior performance in a compact design
- Body heat-treated for additional strength
- Long point configuration allows for tool clearance

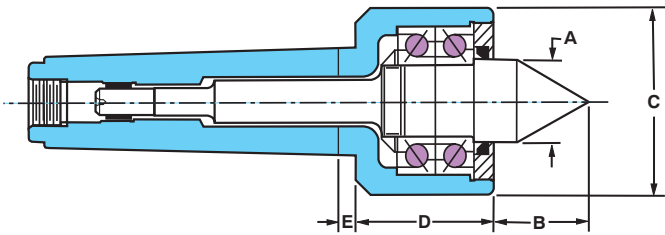
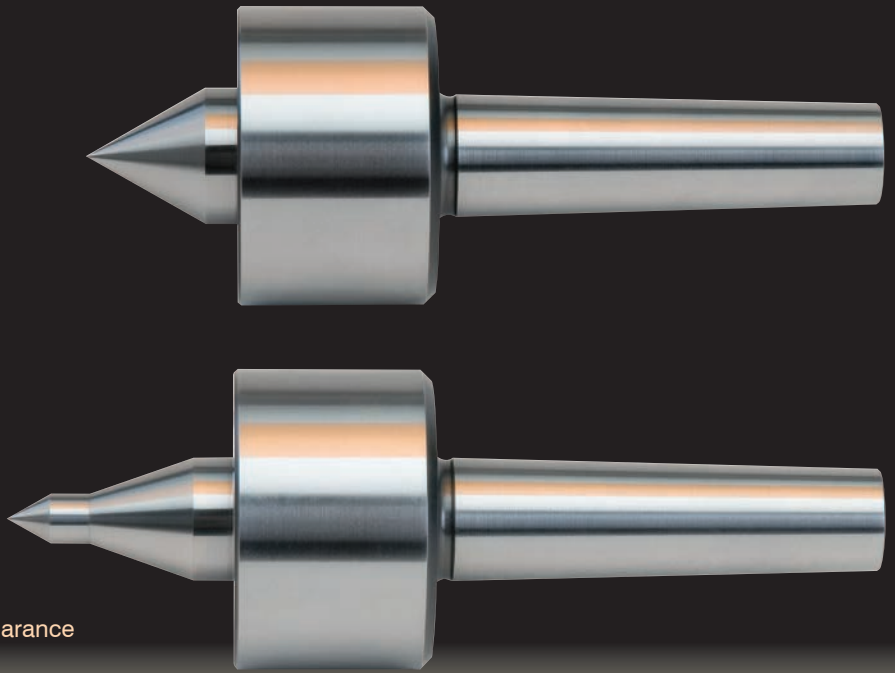

Standard Point

STANDARD POINT - MORSE TAPER									
Model	MT	A	B	C	D	E	Max. RPM	W. P.	Weight
48602	2	1.00	1.25	2.37	1.75	0.25	4000	440	
48603	3	1.00	1.25	2.37	1.75	0.25	4000	1100	
48604	4	1.38	1.50	3.00	1.97	0.38	4000	2100	
48605	5	1.38	1.82	3.07	2.09	0.30	4000	2800	

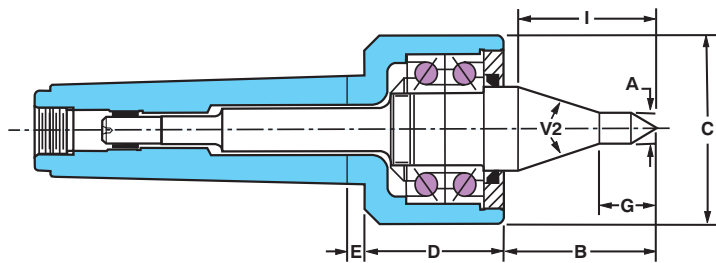

Long Point

LONG POINT - MORSE TAPER											
Model	MT	A	B	C	D	E	G	V2	I	Max. RPM	W. P. Weight
48102	2	0.38	1.88	2.37	1.75	0.25	0.64	40°	1.50	4000	310
48103	3	0.38	1.88	2.37	1.75	0.25	0.64	40°	1.50	4000	310
48104	4	0.50	2.22	3.00	1.97	0.38	0.81	40°	1.82	4000	1100
48105	5	0.50	2.50	3.07	2.09	0.30	0.94	40°	2.15	4000	1100



# Econo Tri-Bearing Live Centers

## Standard and Tracer Point

- Accuracy guaranteed to  $\pm .0002$
- Three rows of bearings
- Points are through-hardened to 61-63 Rc
- Sealed bearings lubricated for life, protected against contaminants and coolant
- **Non-repairable**, trade-in available

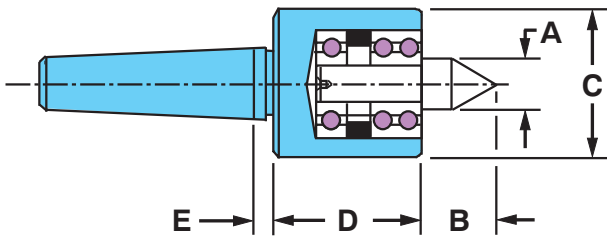
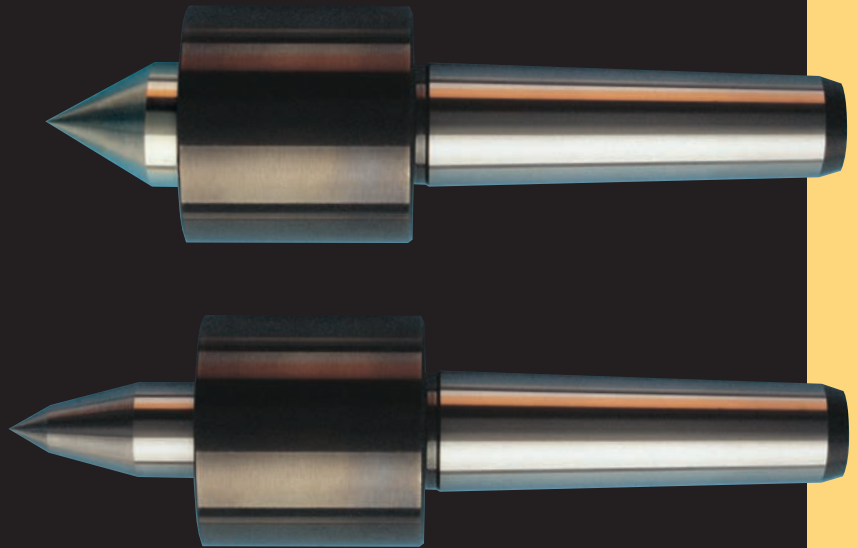

Standard Point

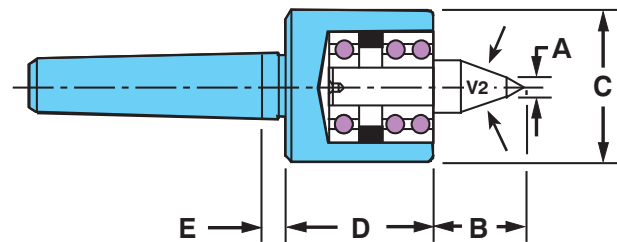

Tracer Point

### STANDARD POINT - MORSE TAPER

Model	MT	A	B	C	D	E	Max. RPM	W.P. Weight
44102	2	0.56	0.81	1.62	1.63	0.25	2500	300
44103	3	0.81	1.01	2.00	1.93	0.25	2500	500
44104	4	1.00	1.25	2.38	2.25	0.25	2500	1100
44105	5	1.00	1.25	2.38	2.25	0.25	2500	1100

### TRACER POINT - MORSE TAPER

Model	MT	A	B	C	D	E	V2	Max. RPM	W. P. Weight
44902	2	0.37	1.24	1.62	1.63	0.25	18°	2500	300
44903	3	0.37	1.52	2.00	1.93	0.25	30°	2500	300
44904	4	0.50	2.02	2.38	2.25	0.25	30°	2500	900
44905	5	0.50	2.02	2.38	2.25	0.25	30°	2500	900



## Low Profile Live Centers Standard, Tracer and Long Point

- Accuracy guaranteed to  $\pm .0002$
- Small housing diameter provides tool clearance
- Points are through-hardened to 61-63 Rc
- Full-length spindle for extra rigidity
- Less tailstock pressure required
- Body heat-treated for additional strength
- Riten full service and repair

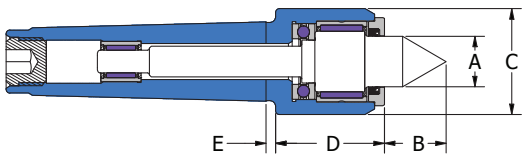

Standard Point

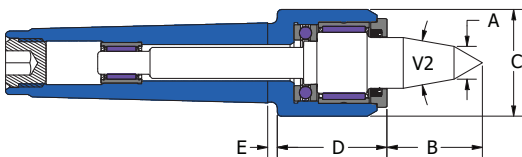

Tracer Point

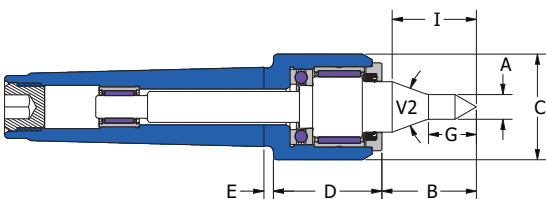

Long Point

### STANDARD POINT – MORSE TAPER

Model	MT	A	B	C	D	E	Max. RPM	W. P. Weight
87602	2	0.59	0.77	1.34	1.42	0.25	5000	200
87603	3	0.59	0.77	1.34	1.42	0.25	5000	400
87604	4	0.79	0.97	1.65	1.70	0.31	4500	800
87605	5	1.18	1.46	2.28	2.34	0.38	4300	1600

### TRACER POINT – MORSE TAPER

Model	MT	A	B	C	D	E	V2	Max. RPM	W. P. Weight
87902	2	0.39	1.26	1.34	1.42	0.25	20°	5000	170
87903	3	0.39	1.26	1.34	1.42	0.25	20°	5000	340
87904	4	0.51	1.48	1.65	1.70	0.31	20°	4500	700
87905	5	0.55	2.03	2.28	2.34	0.38	30°	4300	1400

### LONG POINT - MORSE TAPER

Model	MT	A	B	C	D	E	G	V2	I	Max. RPM	W. P. Weight
87102	2	0.31	1.26	1.34	1.42	0.25	0.63	40°	1.02	5000	50
87103	3	0.31	1.26	1.34	1.42	0.25	0.63	40°	1.02	5000	50
87104	4	0.39	1.48	1.65	1.70	0.31	0.75	40°	1.32	4500	150
87105	5	0.47	2.03	2.38	2.34	0.38	1.00	40°	2.00	4300	180





## Light and Extra-Light Live Centers

- Accuracy guaranteed to  $\pm .00005$ .
- Light live center designed for 2 to 10 lb. workpiece loads.
- X-Light live center designed for extremely light workpiece loads – 2 oz. to 2 lb.
- Excellent for very small workpieces. Used in medical, orthopedic, aerospace and similar applications.
- Free turning.
- Maximum 8,000 RPM.



*Extra-Light Live Center and quarter shown actual size*

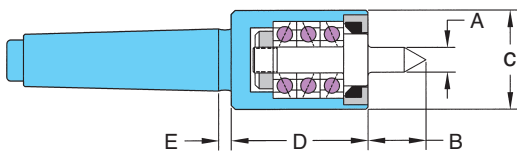

Maximum axial load: 500 lbs.

LIGHT LIVE CENTER - MORSE TAPER									
Model	Taper	A	B	C	D	E	Max RPM	W. P. Weight	
40552	2	0.38	0.87	1.50	2.06	0.19	8000	10	
40572	2	0.78	1.13	1.50	2.06	0.19	8000	10	
40553	3	0.38	0.87	1.50	2.06	0.19	8000	10	
40573	3	0.78	1.13	1.50	2.06	0.19	8000	10	
40554	4	0.38	0.87	1.50	2.06	0.19	8000	10	
40574	4	0.78	1.13	1.50	2.06	0.19	8000	10	
40555	5	0.38	0.87	1.50	2.06	0.19	8000	10	
40575	5	0.78	1.13	1.50	2.06	0.19	8000	10	

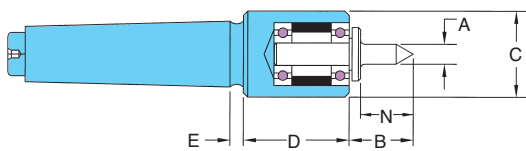

Maximum axial load: 100 lbs.

EXTRA-LIGHT LIVE CENTER - MORSE TAPER									
Model	Taper	A	B	C	D	E	N	Max RPM	W. P. Weight
40101	1	0.28	0.87	1.23	1.77	0.19	0.75	8000	2
40102	2	0.28	0.87	1.23	1.77	0.19	0.75	8000	2
40103	3	0.28	0.87	1.23	1.77	0.19	0.75	8000	2
40104	4	0.28	0.87	1.23	1.77	0.19	0.75	8000	2



# Heavy Duty and Extra Heavy Duty Live Centers Standard Point

- Accuracy guaranteed to  $\pm .0001$ .
- Four-bearing design for heavier loads such as steel rolls, paper rolls, printing rolls, castings, forgings and other large parts.
- For use where the workpiece may weigh several thousand pounds.
- Available in additional metric tapers upon request
- Riten full service and repair.

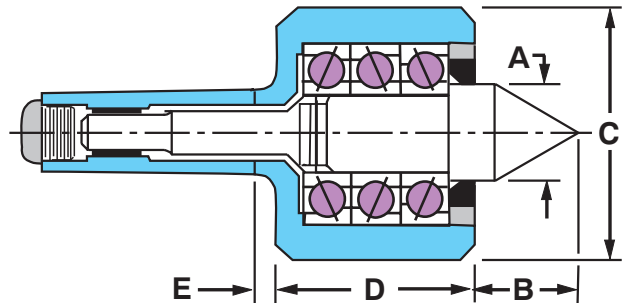
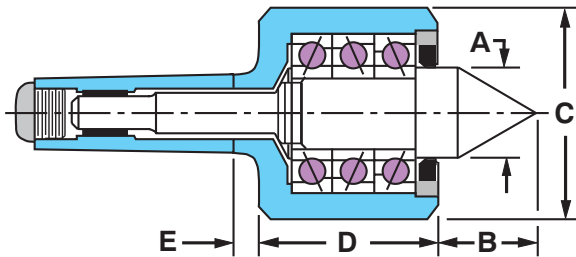
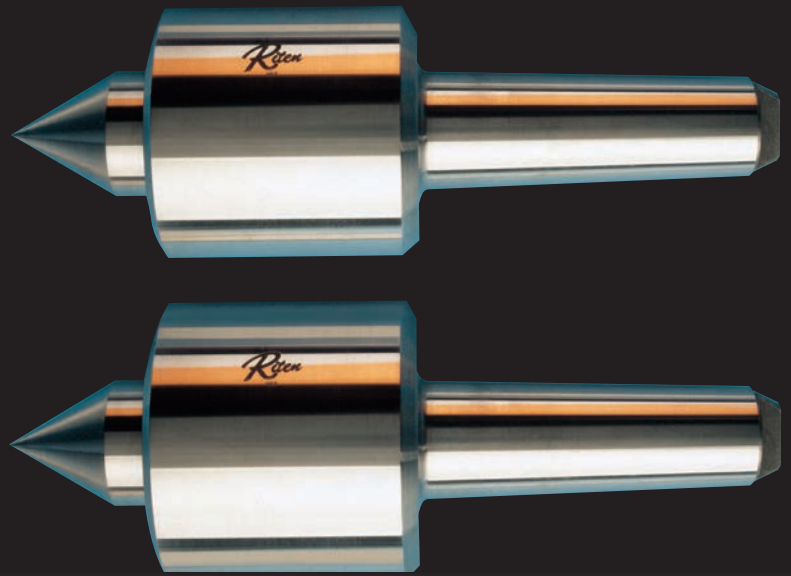

### HEAVY-DUTY – MORSE TAPER

Model	MT	A	B	C	D	E	Max RPM	W. P. Weight
34163	3	0.87	1.12	1.75	2.37	0.38	5000	920
34164	4	1.26	2.00	2.88	3.19	0.50	4200	2200
34105	5	1.87	2.25	3.77	3.84	0.50	3200	8000
34106	6	2.00	2.26	4.63	3.84	0.60	3000	14000
34107	7	2.00	2.25	4.63	3.84	0.60	3000	14000

### HEAVY-DUTY – JARNO TAPER

34220	20	2.00	2.26	4.63	3.84	0.60	3000	14000
-------	----	------	------	------	------	------	------	-------

### HEAVY-DUTY – METRIC TAPER (1:20)

34080	80	2.00	2.26	4.63	3.84	0.75	3000	14000
-------	----	------	------	------	------	------	------	-------

### EXTRA HEAVY-DUTY – MORSE TAPER

Model	MT	A	B	C	D	E	Max RPM	W. P. Weight
55103*	3	1.26	1.50	2.81	3.19	0.50	4000	3000
55164*	4	1.65	1.75	3.77	3.84	0.50	4000	4800
55105	5	1.99	2.26	4.63	3.84	0.50	3000	12000
55106	6	2.62	2.56	6.56	5.09	0.70	3000	22500
55107	7	2.62	2.56	6.56	5.09	0.75	3000	22500

\*Stub spindle design on 3MT and 4MT

### EXTRA HEAVY-DUTY – METRIC TAPER (1:20)

55080	80	2.63	2.50	6.56	5.09	0.75	3000	22500
55100	100	3.75	3.50	8.00	6.38	0.50	3000	25000
55100X	100	3.75	3.78	8.00	6.38	0.50	1500	30000



# Super Duty Live Centers Standard and Replaceable Point

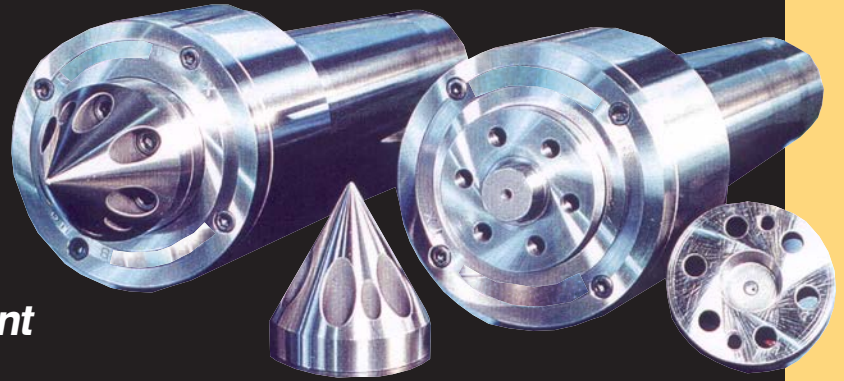

- Accuracy guaranteed to  $\pm .0002$
- Designed for especially heavy workpieces such as those found in mill roll manufacturing and rebuilding.
- Unmatched rigidity under load.
- Radial and axial deflection evaluated per application.
- Two-stage/5 point testing of noise level, vibration, temperature, and accuracy under load.
- Available in metric tapers upon request

Each center is engineered for a specific application. Representative sizes and capacities are shown below. Contact Riten Technical Service to discuss your specific needs.

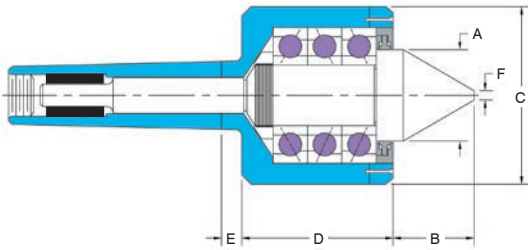

STANDARD POINT									
Model	Gage Line Dia.	A	B	C	D	E	F	Max RPM	Bearing Load Rating
N/A	3.5	3.75	3.25	8.00	6.38	0.50	0.25	1200	62,000 lbs.
N/A	4.5	4.25	5.00	9.75	7.25	0.63	0.38	900	69,500 lbs.
N/A	5	5.00	5.63	10.75	7.75	0.75	0.50	800	105,000 lbs.
N/A	6	6.00	5.75	11.38	8.63	0.88	0.75	600	125,000 lbs.

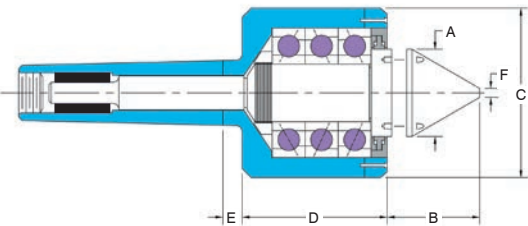

REPLACEABLE POINT									
Model	Gage Line Dia.	A	B	C	D	E	F	Max RPM	Bearing Load Rating
N/A	3.5	3.75	4.25	8.00	6.38	0.50	0.25	1200	62,000 lbs.
N/A	4.5	4.25	4.75	9.75	7.25	0.63	0.38	900	69,500 lbs.

Applications requiring bearing load ratings from 120,000 to 450,000 lbs. are available. For application assistance and available product configurations, please contact Riten Technical Support Group at 1-800-338-0027.

Standard contact angle is 60°. Optional contact angles of 45°, 70°, 80° and 90° are also available.



## Standard Length Full and Half Dead Centers

- Accuracy guaranteed to  $\pm .00005$
- Through-hardened to 61-63 Rc for extra regrinds
- Carbide tipped dead centers are hardened only on the knockout ends.
- Riten full service and repair
- Applying a Moly EP632 grease on the point will reduce friction and wear.

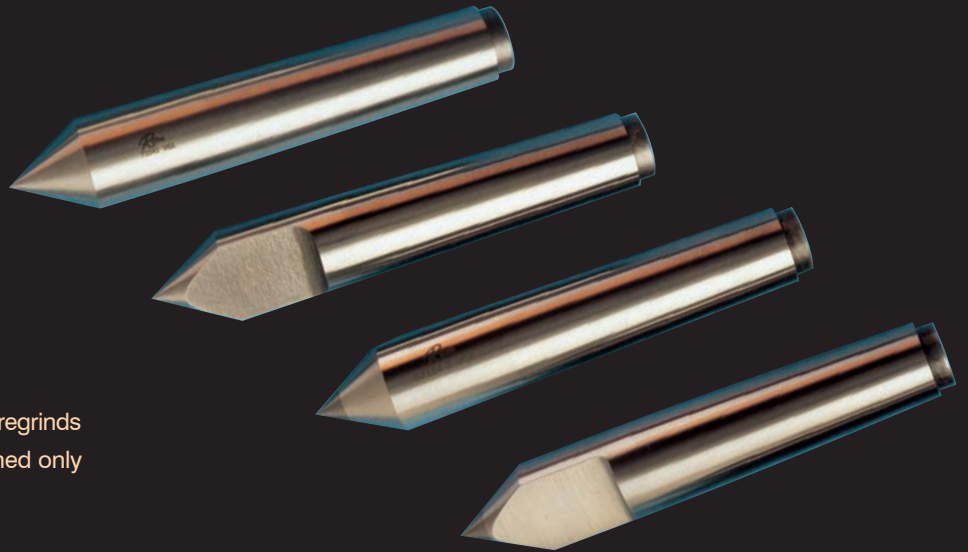

STEEL FULL CENTER

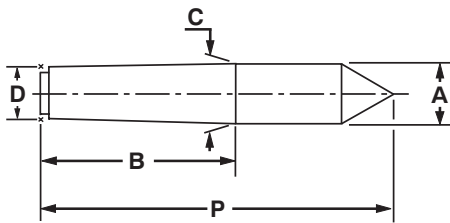

STEEL HALF CENTER

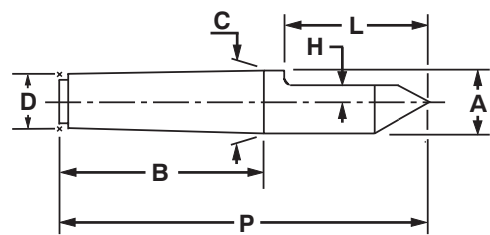

CARBIDE TIPPED FULL CENTER

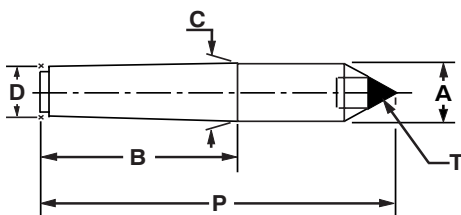

CARBIDE TIPPED HALF CENTER

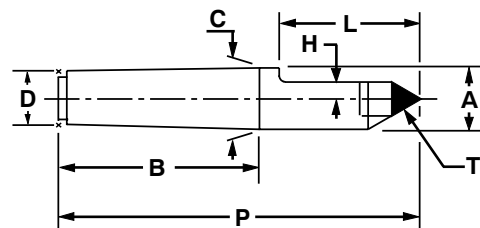

# Standard Length Dead Centers

MORSE TAPER DEAD CENTERS							
TAPER	P	B	C/A	D	•T	H	L
1	3.31	2.12	0.475	0.396	0.250	0.14	1.00
2	4.19	2.56	0.700	0.572	0.375	0.20	1.38
3	5.25	3.19	0.938	0.778	0.500	0.27	1.69
4	6.75	4.06	1.231	1.020	0.500	0.27	2.25
5	8.50	5.19	1.748	1.475	0.625	0.39	2.75
6	11.50	7.25	2.494	2.116	0.875	0.52	3.50
7	15.00	10.00	3.270	2.750	1.000	0.77	4.00

STEEL #	
FULL	HALF
71011	71012
71021	71022
71031	71032
71041	71042
71051	71052
71061	71062
71071	71072

CARBIDE #	
FULL	HALF
71013	71014
71023	71024
71033	71034
71043	71044
71053	71054
71063	71064
71073	71074

JARNO TAPER							
TAPER	P	B	C/A	D	•T	H	L
6	4.50	3.00	0.750	0.600	0.375	0.20	1.13
6	5.50	3.00	0.750	0.600	0.375	0.20	2.19
6	6.00	3.00	0.750	0.600	0.375	0.20	2.50
7	5.25	3.50	0.875	0.700	0.375	0.20	1.19
8	6.00	4.00	1.000	0.800	0.500	0.27	1.63
9	6.75	4.50	1.125	0.900	0.500	0.27	1.88
10	7.50	5.00	1.250	1.000	0.500	0.27	2.00
11	8.25	5.50	1.375	1.100	0.500	0.27	2.00
12	9.00	6.00	1.500	1.200	0.625	0.33	2.25
13	9.75	6.50	1.625	1.300	0.625	0.33	2.50
14	10.50	7.00	1.750	1.400	0.625	0.33	3.00
15	11.25	7.50	1.875	1.500	0.625	0.33	3.00
16	12.00	8.00	2.000	1.600	0.750	0.39	3.00
18	13.50	9.00	2.250	1.800	0.875	0.45	3.50
20	15.00	10.00	2.500	2.000	1.000	0.52	4.00
36	27.00	18.00	4.500	3.600	2.500	0.89	7.00

STEEL #	
FULL	HALF
72041	72042
72051	72052
72061	72062
72071	72072
72081	72082
72091	72092
72101	72102
72111	72112
72121	72122
72131	72132
72141	72142
72151	72152
72161	72162
72181	72182
72201	72202
72361	72362

CARBIDE #	
FULL	HALF
72043	72044
72053	72054
72063	72064
72073	72074
72083	72084
72093	72094
72103	72104
72113	72114
72123	72124
72133	72134
72143	72144
72153	72154
72163	72164
72183	72184
72203	72204
72363	72364

BROWN & SHARPE TAPER							
BS	P	B	C/A	D	•T	H	L
5	3.13	2.00	0.533	0.450	0.250	0.14	0.94
6	3.63	2.38	0.599	0.500	0.250	0.14	0.94
7	4.38	2.88	0.720	0.600	0.375	0.20	1.13
8	5.44	3.56	0.898	0.750	0.500	0.27	1.37
9	6.50	4.25	1.078	0.901	0.500	0.27	2.00
10	7.88	5.00	1.260	1.045	0.500	0.27	2.25
10*	8.56	5.69	1.289	1.045	0.500	0.27	2.25
11	9.31	5.94	1.498	1.250	0.625	0.33	2.50
11*	10.13	6.75	1.531	1.250	0.625	0.33	2.50
12	11.13	7.13	1.797	1.500	0.625	0.39	3.25
13	11.75	7.75	2.073	1.750	0.875	0.45	3.50
15	13.50	8.75	2.615	2.250	1.000	0.52	4.00
17	14.50	9.75	3.156	2.750	1.500	0.77	4.00
18	15.00	10.25	3.427	3.000	1.500	0.77	4.50

STEEL #	
FULL	HALF
74051	74052
74061	74062
74071	74072
74081	74082
74091	74092
74101	74102
74001	74002
74111	74112
74011	74012
74121	74122
74131	74132
74151	74152
74171	74172
74181	74182

CARBIDE #	
FULL	HALF
74053	74054
74063	74064
74073	74074
74083	74084
74093	74094
74103	74104
74003	74004
74113	74114
74013	74014
74123	74124
74133	74134
74153	74154
74173	74174
74183	74184

• Carbide diameter | \*CINN. Grinder



# Imperial Dead Centers

## Large Carbide Point

### Increased Center Hole Range

- Accuracy guaranteed to  $\pm .00005$ .
- Covers the widest range of center hole sizes.
- Eliminates the need for special centers.
- Also available in other tapers.

Imperial Carbide Centers cover the requirements for a wide range of workpiece center holes. They reduce costs by eliminating the need for special dead centers. Knockout ends are hardened on carbide tipped dead centers. Applying a Moly EP632 grease on the point will reduce friction and wear.

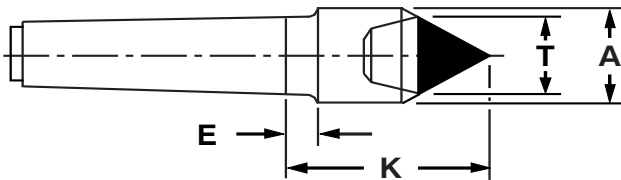
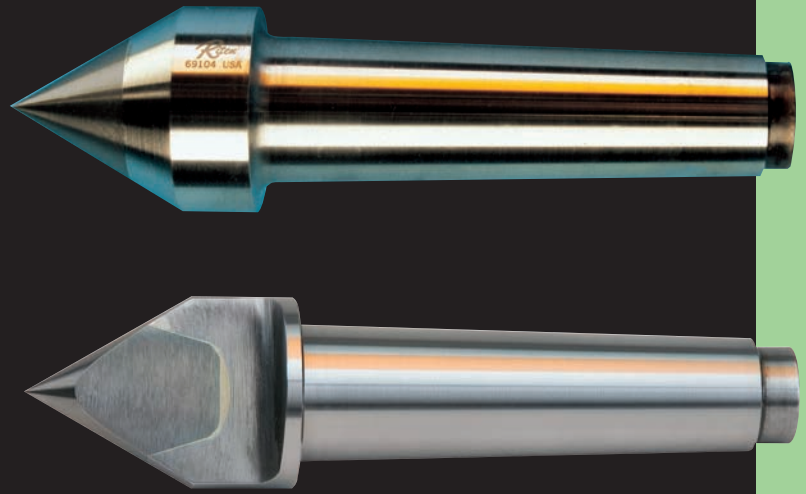

Full Dead Centers

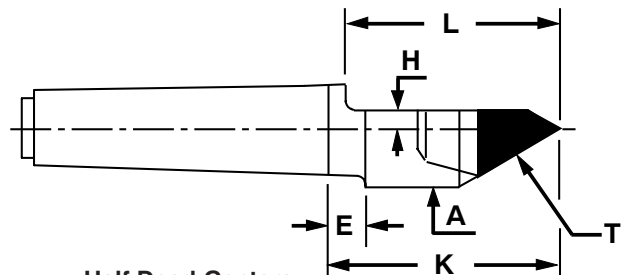

Half Dead Centers

MORSE TAPER					
Taper	T*	A	K	E	Model
2	1.00	1.25	2.38	0.38	69102
3	1.00	1.25	2.37	0.38	69103
4	1.25	1.75	2.69	0.50	69104
5	1.25	1.75	3.31	—	69105

JARNO TAPER					
Taper	T*	A	K	E	Model
6	1.00	1.25	2.38	0.38	69206
9	1.25	1.75	2.69	0.50	69209
10	1.25	1.75	2.69	0.50	69210
14	1.25	1.75	3.50	—	69214

BROWN & SHARPE TAPER					
Taper	T*	A	K	E	Model
7	1.00	1.25	2.37	0.38	69407
9	1.25	1.75	2.69	0.50	69409
12	1.25	1.80	4.00	—	69412

\* Carbide Diameter

MORSE TAPER							
Taper	T*	A	H	L	K	E	Model
2	1.00	1.25	0.13	1.69	2.38	0.38	69502
3	1.00	1.25	0.13	1.69	2.37	0.38	69503
4	1.25	1.75	0.25	2.25	2.94	0.50	69504
5	1.25	1.75	0.25	2.75	3.31	—	69505

JARNO TAPER							
Taper	T*	A	H	L	K	E	Model
6	1.00	1.25	0.13	1.88	2.38	0.38	69606
9	1.25	1.75	0.25	1.88	2.94	0.50	69609
10	1.25	1.75	0.25	2.00	2.94	0.50	69610
14	1.25	1.75	0.25	3.00	3.50	—	69614

BROWN & SHARPE TAPER							
Taper	T*	A	H	L	K	E	Model
7	1.00	1.25	0.13	1.87	2.37	0.38	69707
9	1.25	1.75	0.25	2.00	2.94	0.50	69709
12	1.25	1.80	0.25	3.25	4.00	—	69712

\* Carbide Diameter



## 60° & 90° Dead Centers, Standard & Long Lengths

- Accuracy guaranteed to  $\pm .00005$
- Through-hardened to 61-63 Rc for extra regrinds
- Applying a Moly EP632 grease on the point will reduce friction and wear.
- Riten full service and repair

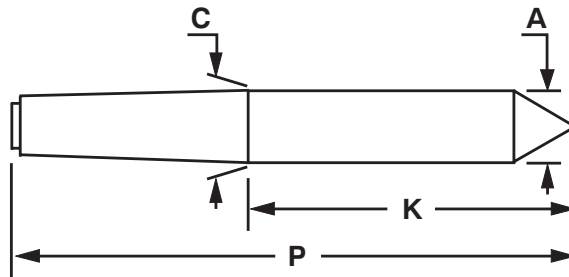
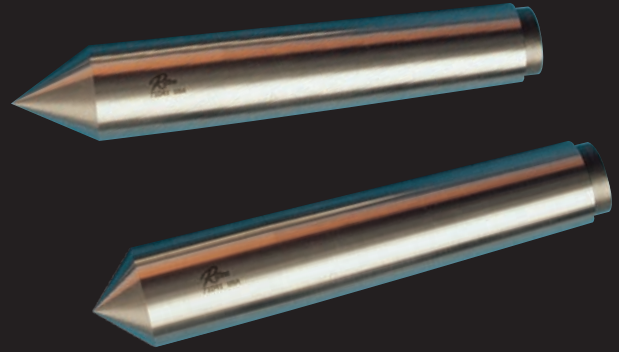

MORSE TAPER				MODEL	
TAPER	P	K	C/A	60°	90°
2	5.19	2.63	0.700	64502	97502
2	6.78	4.22	0.700	64602	97602
3	5.25	2.06	0.938	71031	97031
3	6.25	3.06	0.938	64503	97503
3	6.75	3.56	0.938	64603	97603
4	6.75	2.69	1.231	71041	97041
4	7.75	3.69	1.231	64504	97504
4	8.25	4.19	1.231	64604	97604
5	8.50	3.31	1.748	71051	97051
5	9.53	4.35	1.748	64505	97505
5	10.00	4.81	1.748	64605	97605
6	11.50	4.25	2.494	71061	97061
6	12.50	5.25	2.494	64506	97506
6	13.00	5.75	2.494	64606	97606
7	15.00	5.00	3.270	71071	97071
7	16.00	6.00	3.270	64507	97507

METRIC TAPER (1:20)				MODEL	
TAPER	P	K	C/A	60°	90°
80	12.50	4.78	3.150	70080	97080
100	14.50	5.37	3.937	70100	97100

BROWN & SHARPE TAPER				MODEL	
TAPER	P	K	C/A	60°	90°
7	5.25	2.37	0.720	64407	97407
12	12.25	5.12	1.797	64412	97412

JARNO TAPER				MODEL	
TAPER	P	K	C/A	60°	90°
10	7.50	2.50	1.250	72101	97101
10	8.50	3.50	1.250	64510	97510
10	9.25	4.25	1.250	64610	97610
14	10.50	3.50	1.750	72141	97141
14	11.50	4.50	1.750	64514	64514
14	12.00	5.00	1.750	64614	64914



## Fast-Trak Specials

### Carbide Full & Half Dead Centers

Additional tapers are available from our semi-finished inventories. To call, fax or email Riten with your special requirements see pages 41 and 42.

- Accuracy guaranteed to  $\pm .00005$
- Popular sizes in stock for fast delivery
- Other tapers available
- Hardened knockout ends
- Riten full service and repair



#### FULL CENTER

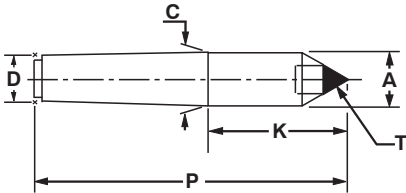

#### HALF CENTER

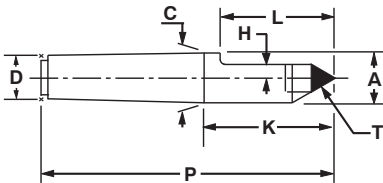

#### MORSE TAPER DEAD CENTERS

Taper	P	K	C/A	D	•T	H	L
3	5.25	2.06	0.938	0.778	0.75	0.13	1.69
3	6.25	3.06	0.938	0.778	0.75	0.13	2.63
3	6.75	3.56	0.938	0.778	0.75	0.13	3.13
4	6.75	2.69	1.231	1.020	0.75	0.13	2.25
4	6.75	2.69	1.231	1.020	1.00	0.13	2.25
4	7.75	3.69	1.231	1.020	0.75	0.13	2.75
4	7.75	3.69	1.231	1.020	1.00	0.13	2.75
4	8.25	4.19	1.231	1.020	0.75	0.13	3.25
4	8.25	4.19	1.231	1.020	1.00	0.13	3.25
5	8.50	3.31	1.748	1.475	1.00	0.13	2.75
5	9.50	4.31	1.748	1.475	1.00	0.13	3.75
5	10.00	4.81	1.748	1.475	1.00	0.13	4.25

#### MODEL

FULL	HALF
79053	79054
79063	79064
79073	79074
79083	79084
79093	79094
79103	79104
79113	79114
79123	79124
79133	79134
79143	79144
79153	79154
79163	79164

#### JARNO TAPER DEAD CENTERS

Taper	P	K	C/A	D	•T	H	L
10	7.50	2.50	1.250	1.000	1.00	0.13	2.00
10	8.50	3.50	1.250	1.000	1.00	0.13	3.00
10	9.25	4.25	1.250	1.000	1.00	0.13	3.75
14	10.50	3.50	1.750	1.400	1.00	0.13	3.00
14	11.50	4.50	1.750	1.400	1.00	0.13	4.00
14	12.00	5.00	1.750	1.400	1.00	0.13	4.50

#### MODEL

FULL	HALF
79263	79264
79273	79274
79283	79284
79293	79294
79303	79304
79313	79314





## Super Accurate Live Centers Standard Point

- Accuracy guaranteed to  $\pm .00004$
- Ideal for precision grinding
- Compact design
- Extended points available
- Five pounds of thrust to seat bearings
- Riten full service and repair

The ultimate live center for precision grinding is provided by Riten's unique design. Medium-duty live centers are required where the weight of the workpiece is several hundred pounds. These centers are built with larger bearings to provide the support and strength required to handle heavier workpieces.

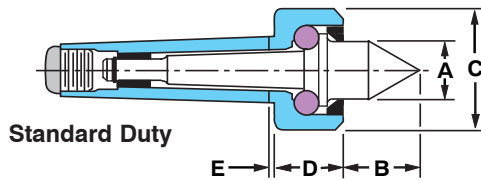
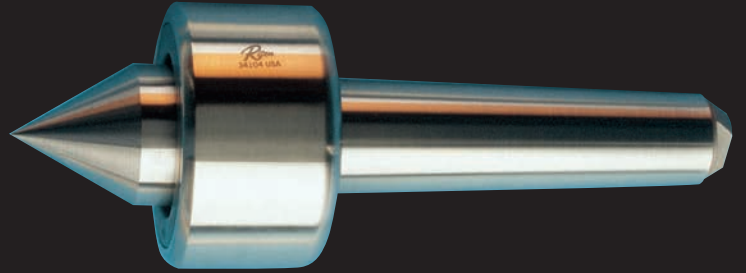
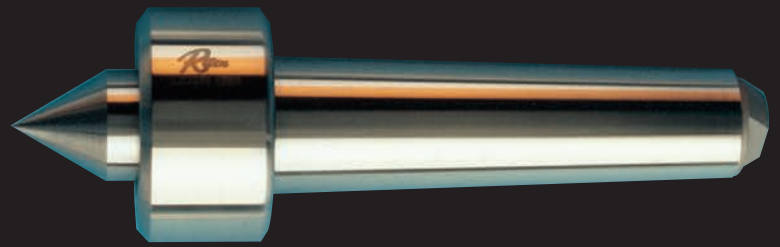

Standard Duty

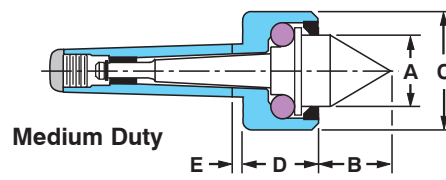

Medium Duty

MORSE TAPER									
Model	MT	A	B	C	D	E	Max RPM	W. P. Weight	
12102	2	0.73	0.87	1.25	0.75	0.18	1000	400	
12103	3	0.87	1.13	1.69	0.94	0.29	1000	1000	
12104	4	1.00	1.13	2.13	1.19	0.35	1000	1800	
12105	5	1.49	1.50	2.81	1.41	0.35	1000	3800	
12106	6	2.11	2.13	4.19	2.50	0.41	1000	6000	
Model	JT	JARNO TAPER							
12206	6	0.73	0.87	1.25	0.75	0.19	1000	300	
12207	7	0.87	1.13	1.69	0.94	0.29	1000	800	
12209	9	0.87	1.13	1.69	0.94	0.29	1000	1000	
12210	10	1.00	1.13	2.13	1.19	0.29	1000	1800	
12212	12	1.00	1.00	2.13	1.19	0.35	1000	1800	
12214	14	1.49	1.50	2.81	1.41	0.35	1000	3800	
12216	16	1.51	1.50	2.81	1.41	0.29	1000	3800	
12220	20	2.11	2.13	4.19	2.50	0.41	1000	6000	
Model	BS	BROWN & SHARPE TAPER							
12407	7	0.73	0.87	1.25	0.75	0.21	1000	400	
12409	9	0.87	1.13	1.69	0.94	0.31	1000	1000	
12410	10	1.00	1.00	2.13	1.19	0.92*	1000	1800	
12411	11	1.00	1.00	2.13	1.19	1.04*	1000	1800	
12412	12	1.51	1.50	2.81	1.41	0.43	1000	3800	
12413	13	1.51	1.50	2.81	1.41	0.37	1000	3800	

MORSE TAPER									
Model	MT	A	B	C	D	E	Max RPM	W. P. Weight	
34102	2	0.87	1.13	1.69	1.06	0.19	1000	500	
34103	3	1.00	1.13	2.13	1.38	0.29	1000	1200	
34104	4	1.49	1.63	2.81	1.66	0.35	1000	2200	
Model	JT	JARNO TAPER							
34206	6	0.87	1.13	1.69	1.06	0.19	1000	400	
34207	7	1.00	1.13	2.13	1.38	0.29	1000	900	
34209	9	1.00	1.13	2.13	1.38	0.29	1000	1300	
34210	10	1.49	1.50	2.81	1.66	0.41	1000	2200	
34211	11	1.49	1.50	2.81	1.66	0.29	1000	2200	
34212	12	1.49	1.50	2.81	1.66	0.35	1000	2200	
34214	14	2.11	2.13	4.19	2.50	0.60	1000	4400	
34216	16	2.11	2.13	4.19	2.50	0.41	1000	4400	
Model	BS	BROWN & SHARPE TAPER							
34407	7	0.87	1.13	1.69	1.06	0.21	1000	500	
34409	9	1.00	1.13	2.13	1.38	0.31	1000	1300	
34410	10	1.49	1.50	2.81	1.66	0.92*	1000	2200	
34411	11	1.49	1.50	2.81	1.66	1.04*	1000	2200	
34412	12	2.11	2.13	4.19	2.50	0.43	1000	4400	
34413	13	2.11	2.13	4.19	2.50	0.43	1000	4400	

\* B&S Cinn. (E= .25)



## Pipe and Bull Nose Dead Centers

- Accuracy guaranteed to  $\pm .00005$ .
- Through-hardened to 61-63 Rc.
- Riten full service and repair.
- Special "F" dimension available on bull nose.
- Quick delivery available on these items.

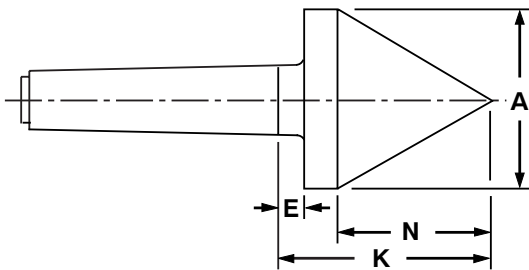

**Pipe Nose Dead Center**

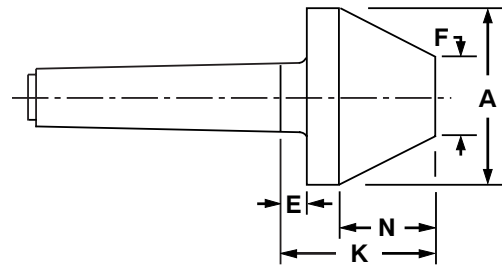

**Bull Nose Dead Center**

Special F dimensions available. Quick delivery on these items.

MORSE TAPER					
Taper	A	N	E	K	Model
2	2.13	1.831	0.50	2.84	66102
3	2.75	2.370	0.50	3.38	66103
4	2.75	2.370	0.50	3.38	66104
5	3.50	3.016	0.50	4.03	66105
6	4.50	3.878	0.75	5.19	66106

JARNO TAPER					
Taper	A	N	E	K	Model
14	3.50	3.016	0.50	4.03	66214

MORSE TAPER						
Taper	A	F	N	E	K	Model
2	2.13	0.50	1.400	0.50	2.41	66502
2	2.13	1.00	0.969	0.50	1.98	66602
3	2.75	0.50	1.939	0.50	2.95	66503
3	2.75	1.00	1.508	0.50	2.52	66603
3	2.75	1.50	1.077	0.50	2.08	66703
4	2.75	0.50	1.939	0.50	2.95	66504
4	2.75	1.00	1.508	0.50	2.52	66604
4	2.75	1.50	1.077	0.50	2.08	66704
5	3.50	1.00	2.154	0.50	3.17	66505
5	3.50	2.00	1.293	0.50	2.30	66605

JARNO TAPER						
Taper	A	F	N	E	K	Model
14	3.50	1.00	2.154	0.50	3.17	66514
14	3.50	2.00	1.293	0.50	2.30	66614



## Fast-Trak Specials

### Carbide Bull Nose Dead Centers

Additional tapers are available from our semi-finished inventories. To call, fax or email Riten with your special requirements see [pages 41 and 42](#).

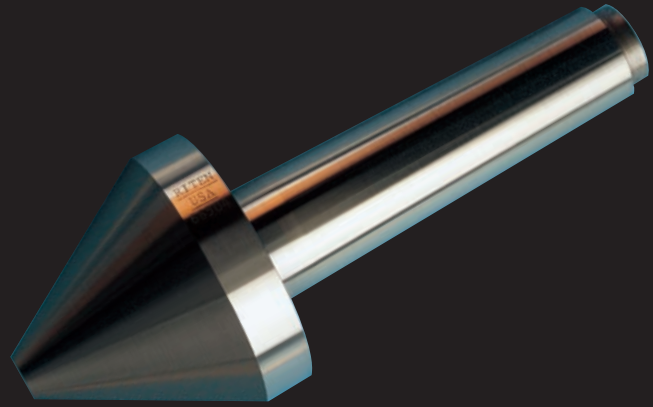

- Accuracy guaranteed to  $\pm .00005$
- Popular sizes in stock for fast delivery
- Other tapers available
- Hardened knockout ends
- Riten full service and repair

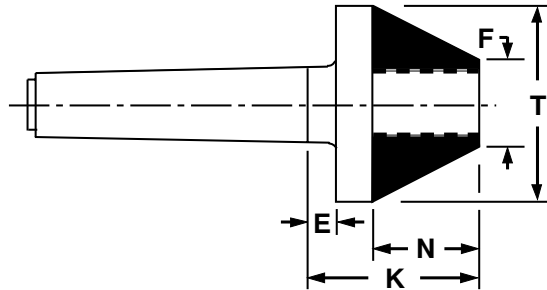

MORSE TAPER						
MT	•T	F	N	E	K	MODEL
3	1.75	0.75	0.86	0.50	1.86	66901
3	2.00	0.75	1.08	0.50	2.08	66902
3	2.50	1.00	1.29	0.50	2.30	66903
3	2.75	1.00	1.51	0.50	2.51	66904
4	1.75	0.75	0.86	0.50	1.86	66905
4	2.00	0.75	1.08	0.50	2.08	66906
4	2.50	1.00	1.29	0.50	2.30	66907
4	2.75	1.00	1.51	0.50	2.51	66908
5	1.75	0.75	0.86	0.50	2.64	66909
5	2.00	0.75	1.08	0.50	2.08	66910
5	2.50	1.00	1.29	0.50	2.30	66911
5	2.75	1.00	1.51	0.50	2.51	66912

• Carbide diameter



## Bull Nose Live Centers

- Large workpiece center holes.
- Large piece parts.
- Riten full service and repair.

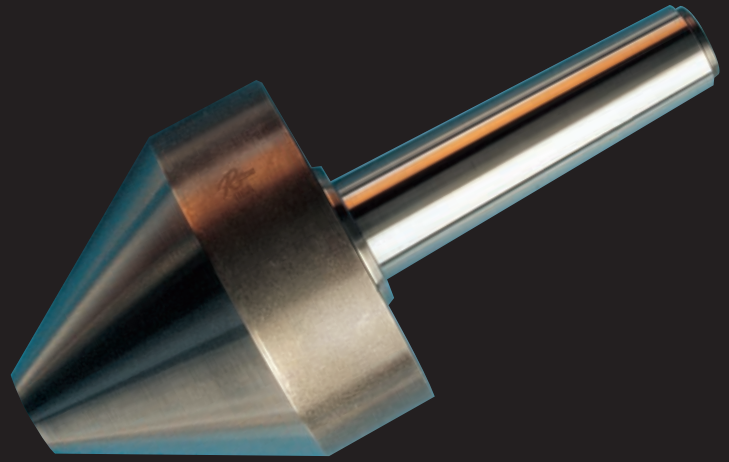

Riten Bull Nose Centers are designed for large bore, heavy work pieces such as hydraulic cylinders, thick wall pipe and heavy rolls. They utilize both ball and tapered roller bearings. For best results, choose a bull nose center that will place the workpiece in the middle or toward the larger end of the 60° angle. This will balance the weight of the part on the center and help carry the load evenly over the bearings.

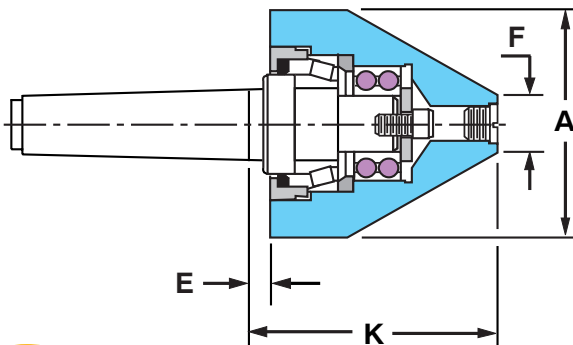

Accuracy guaranteed to  $\pm .00015$

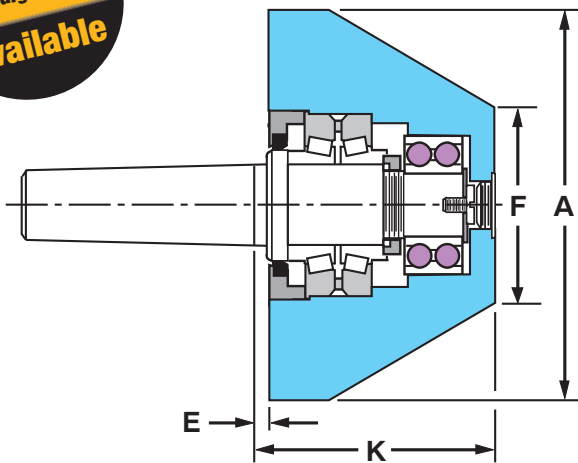

Accuracy guaranteed to  $\pm .0002$

Jarno,  
Brown & Sharpe,  
and Straight Shanks  
**Available**

### MORSE TAPER

Model	MT	A	F	E	K	W. P. Weight
56412	2	4.00	1.00	0.38	4.29	2000
56413	3	4.00	1.00	0.39	4.29	3800
56414	4	4.00	1.00	0.39	4.30	4800
56415	5	4.00	1.00	0.38	4.29	4800
56523	3	5.00	2.00	0.38	3.82	3800
56524	4	5.00	2.00	0.38	3.83	4800
56525	5	5.00	2.00	0.38	3.82	4800
56633	3	6.50	3.00	0.38	3.91	3800
56634	4	6.50	3.00	0.38	3.92	4800
56635	5	6.50	3.00	0.38	3.91	4800
56636	6	6.50	3.00	0.79	4.32	4800

### MORSE TAPER

Model	MT	A	F	E	K	W. P. Weight
56945	5	9.00	4.00	0.47	6.63	7000
56946	6	9.00	4.00	0.47	6.63	12000
56105	5	10.50	5.00	0.45	7.45	7000
56106	6	10.50	5.00	0.45	7.45	15000
56107	7	10.50	5.00	0.45	7.45	15000
56126	6	12.00	6.00	0.45	7.45	15000
56127	7	12.00	6.00	0.45	7.45	15000



## Precision Bull Nose Live Centers

- Accuracy guaranteed to  $\pm .0001$ .
- For heavy, large center hole workpieces.
- High RPM capacity.
- Riten full service and repair

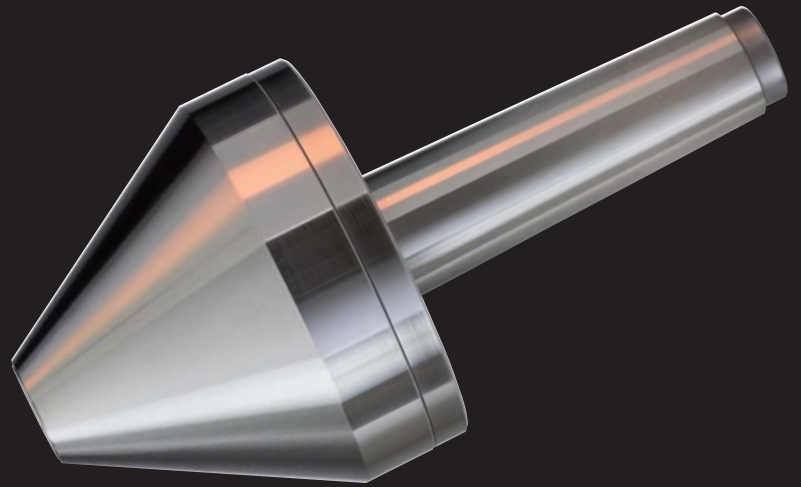

Riten Precision Bull Nose Centers are engineered for precision grinding, threading and turning of heavy, large center hole work pieces. They provide greater accuracy and higher speeds than standard Bull Nose Centers. The rigidity of the center prevents vibration and chatter. For the best support and chatter-free parts, choose a center where the part will seat as close to the large diameter as possible.

Engineered for precision grinding, threading and turning of heavy, large center hole work pieces. For the best support and chatter-free parts, choose a center where the part will seat as close to the large diameter as possible.

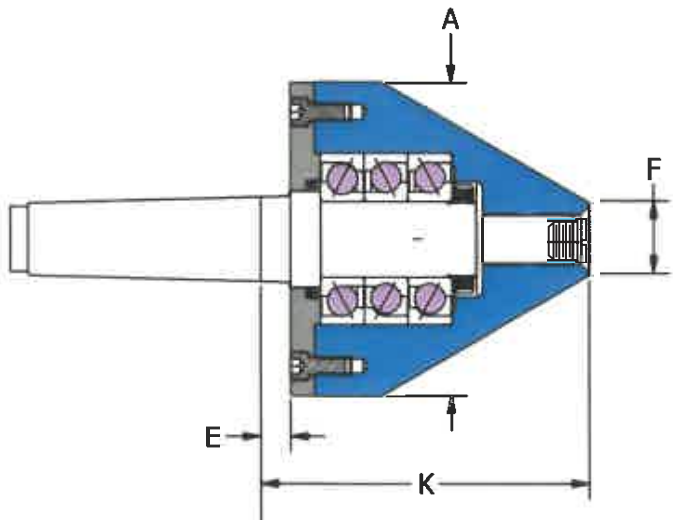

Accuracy guaranteed to  $\pm .0001$



MORSE TAPER							
Model	MT	A	F	E	K	Max RP	W. P. Weight
56202	2	2.48	0.56	0.26	3.26	8500	1350
56203	3	2.48	0.56	0.38	3.38	8500	1350
56303	3	3.50	1.00	0.27	3.77	7000	2700
56304	4	3.50	1.00	0.26	3.76	7000	2700
56404	4	4.50	1.00	0.62	5.37	6000	4000
56405	5	4.50	1.00	0.62	5.37	6000	4000
56505	5	5.50	1.50	0.63	5.56	4500	7000
56506	6	5.50	1.50	0.63	5.56	4500	7000
56605	5	6.50	1.50	0.62	6.81	4000	10,000
56606	6	6.50	1.50	0.62	6.81	4000	10,000
56705	5	7.50	2.00	0.62	7.25	3000	15,000
56706	6	7.50	2.00	0.62	7.25	3000	15,000
56707	7	7.50	2.00	0.62	7.25	3000	15,000
56855	5	8.50	3.00	0.62	7.25	3000	15,000
56856	6	8.50	3.00	0.62	7.25	3000	15,000
56857	7	8.50	3.00	0.62	7.25	3000	15,000
56805	5	10.00	4.00	0.63	7.13	2800	19,000
56806	6	10.00	4.00	0.63	7.13	2800	19,000
56807	7	10.00	4.00	0.63	7.13	2800	19,000
56905	5	12.00	6.00	0.63	7.13	2800	19,000
56906	6	12.00	6.00	0.63	7.13	2800	19,000
56907	7	12.00	6.00	0.63	7.13	2800	19,000
56915	5	14.00	8.00	0.63	7.13	2800	19,000
56916	6	14.00	8.00	0.63	7.13	2800	19,000
56917	7	14.00	8.00	0.63	7.13	2800	19,000



## Heavy Duty & Standard Pipe Nose Live Centers

■ For use with pipe, tubing and thin walled piece parts.

Designed for use in machining pipe, tubing and other thin wall workpieces. One center fits a wide range of sizes. For the best support and chatter-free parts, choose a center where the part will seat as close to the large diameter as possible.

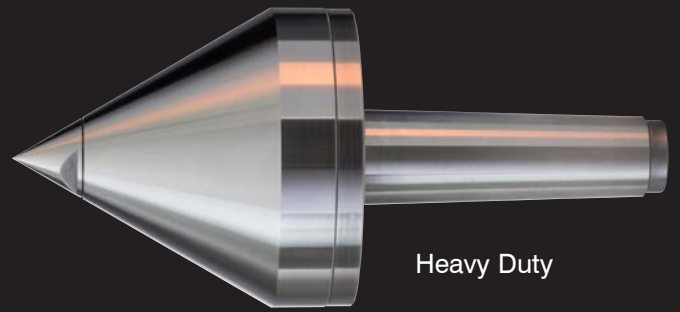

Heavy Duty

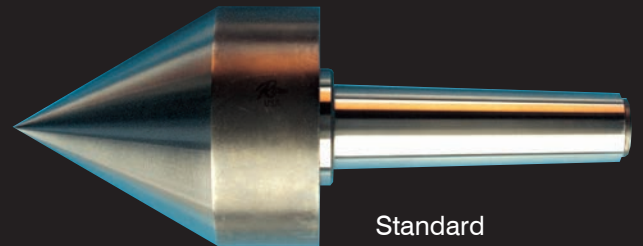

Standard

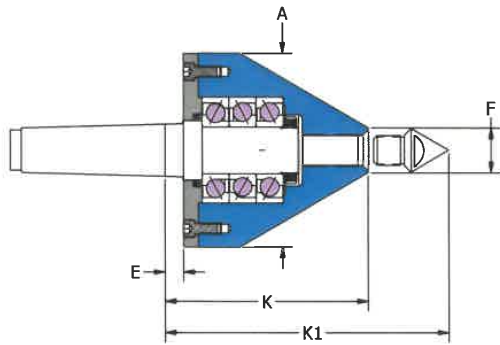

Accuracy guaranteed to  $\pm .0001$

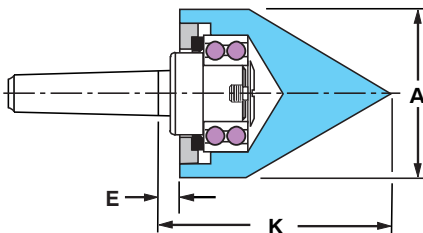

Accuracy guaranteed to  $\pm .00025$

### HEAVY DUTY - MORSE TAPER

Model	MT	A	F	E	K	K1	Max RPM	W. P. Weight	Point Part No.
65202*	2	2.50	-	0.26	-	3.76	8500	1350	-
65203*	3	2.50	-	0.38	-	3.88	8500	1350	-
65303	3	3.50	1.00	0.27	3.77	4.64	7800	2700	96501
65304	4	3.50	1.00	0.26	3.76	4.63	7800	2700	96501
65404	4	4.50	1.00	0.62	5.37	6.25	6000	4000	96501
65405	5	4.50	1.00	0.62	5.37	6.25	6000	4000	96501
65505	5	5.50	1.50	0.63	5.56	6.86	4000	7000	96515
65506	6	5.50	1.50	0.63	5.56	6.86	4000	7000	96515
65605	5	6.50	1.50	0.62	6.81	8.12	2600	10,000	96515
65606	6	6.50	1.50	0.62	6.81	8.12	2600	10,000	96515
65705	5	7.50	2.00	0.62	7.25	8.98	1900	15,000	96502
65706	6	7.50	2.00	0.62	7.25	8.98	1900	15,000	96502
65707	7	7.50	2.00	0.62	7.25	8.98	1900	15,000	96502

\* Solid point in pipe nose design.

### STANDARD - MORSE TAPER

Model	Taper	A	E	K	W. P. Weight	Max RPM
65252	2	2.50	0.31	3.76	260	4800
65253	3	2.50	0.31	3.76	260	4800
65254	4	2.50	0.31	3.76	260	4800
65353	3	3.50	0.44	4.91	1500	3000
65354	4	3.50	0.44	4.91	1500	3000
65355	5	3.50	0.44	4.91	1500	3000
65453	3	4.50	0.44	4.88	1500	3000
65454	4	4.50	0.44	4.88	1500	3000
65455	5	4.50	0.44	4.88	1500	3000
65555	5	5.50	0.38	6.33	4500	2000
65556	6	5.50	0.38	6.33	4500	2000



## Multi-Use Live Center

- Accurate to  $\pm .0001$ .
- Great for manual lathe applications.
- Riten full service and repair.

The Multi-Use live center is ideal for general machine shop use. It can be used when machining thin-walled workpieces or general shaft work applications. The versatility of this center makes it a "must have" tool when your center needs change frequently.

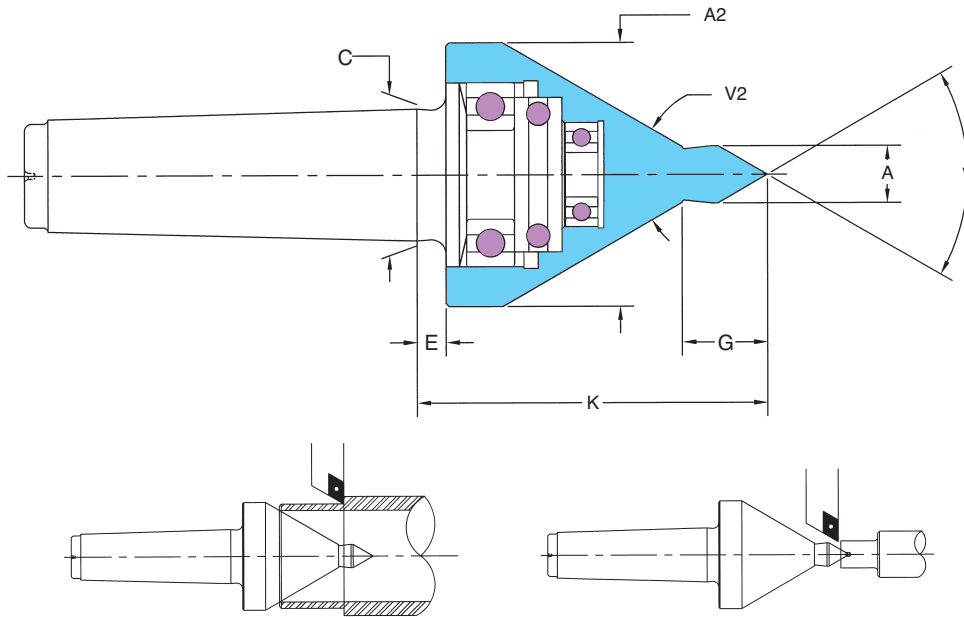

MULTI-USE LIVE CENTER - MORSE TAPER

Model	MT	A	A2	C	E	G	K	V	V2	Max RPM	W. P. Weight
60222	2	0.50	2.25	0.700	0.25	0.75	3.19	60°	60°	5000	330
60223	3	0.50	2.25	0.938	0.25	0.75	3.19	60°	60°	5000	330
60263	3	0.63	2.63	0.938	0.25	0.94	3.75	60°	60°	4000	685
60264	4	0.63	2.63	1.231	0.39	0.94	3.89	60°	60°	4000	685
60354	4	0.76	3.50	1.231	0.38	1.13	4.63	60°	60°	3500	1165
60355	5	0.76	3.50	1.748	0.38	1.13	4.63	60°	60°	3500	1165



**CONCENTRIC**

## Standard Spring Loaded and Interchangeable Bell Head Live Centers

- Accuracy to  $\pm .0001$ .
- Spring loaded spindle compensates for thermal expansion.
- Low profile - less overhang, added load capacity, and increased rigidity



Seventy-five years ago, Concentric pioneered and patented the first spring loaded live center. Today, this streamlined high precision center is available from Riten.

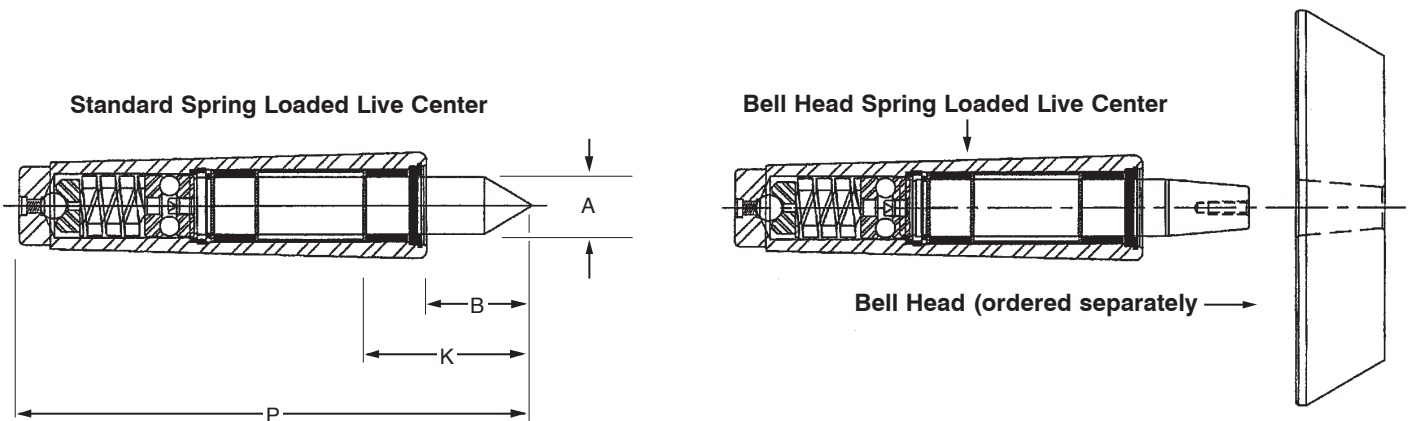

STANDARD POINT AND BELL HEAD								
Type	A	B	K*	P	Max Thrust Load	Max Spring Travel	Max W.P. Weight	Max RPM
II	0.378	0.88	1.38	3.95	173	0.094	274	3000
III	0.558	1.16	1.69	4.95	235	0.125	400	3000
IV	0.686	1.38	2.38	6.29	671	0.156	960	2000
V	1.075	2.00	2.88	8.02	844	0.188	1450	1500
VI	1.509	2.81	3.81	11.00	2183	0.188	2500	1500

\* K: Gage line to point typical for Morse Tapers.

### Special lubricating grease required for Concentric centers:

14.5 oz. tube, part no. 17991  
 Heavy duty grease gun, part no. 17990  
 Low profile grease gun nozzle - # Z737, part no. 17993



## Standard Spring Loaded Live Centers

TYPE II		TYPE III		TYPE IV		TYPE V		TYPE VI	
Taper	Part No.	Taper	Part No.	Taper	Part No.	Taper	Part No.	Taper	Part No.
2 MT	17102	3 MT	17103	4 MT	17104	5 MT	17105	6 MT	17106
7 B&S	17407	9 B&S	17409	10 B&S	17410	12 B&S	17412	15 B&S	17415
8 B&S	17408	8 Jarno	17208	11 B&S	17411	13 B&S	17413	16 B&S	17416
6 Jarno	17206	9 Jarno	17209	10 Jarno	17210	14 B&S	17414	20 Jarno	17220
7 Jarno	17207	1 SS	17303	11 Jarno	17211	14 Jarno	17214	22 Jarno	17222
5/8 SS	17301	11/16 SS	17304	12 Jarno	17212	16 Jarno	17216	21/4 SS	17309
3/4 SS	17302	11/4 SS	17305	11/2 SS	17306	13/4 SS	17307	21/2 SS	17310
						2 SS	17308	3 SS	17311

## Bell Head Spring Loaded Live Centers

TYPE II		TYPE III		TYPE IV		TYPE V		TYPE VI	
Taper	Part No.	Taper	Part No.	Taper	Part No.	Taper	Part No.	Taper	Part No.
2 MT	17122	3 MT	17123	4 MT	17124	5 MT	17125	6 MT	17126
7 B&S	17427	9 B&S	17429	10 B&S	17430	12 B&S	17432	15 B&S	17435
8 B&S	17428	8 Jarno	17228	11 B&S	17431	13 B&S	17433	16 B&S	17436
6 Jarno	17226	9 Jarno	17229	10 Jarno	17230	14 B&S	17434	20 Jarno	17240
7 Jarno	17227	1 SS	17323	11 Jarno	17231	14 Jarno	17234	22 Jarno	17242
5/8 SS	17321	11/16 SS	17324	12 Jarno	17232	16 Jarno	17236	21/4 SS	17329
3/4 SS	17322	11/4 SS	17325	11/2 SS	17326	13/4 SS	17327	21/2 SS	17330
						2 SS	17328	3 SS	17331

## Interchangeable Bell Head Adapters

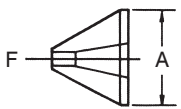

Style 1

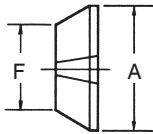

Style 2

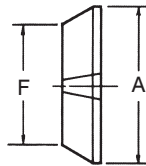

Style 3

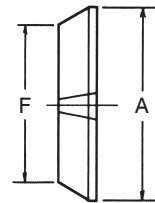

Style 4

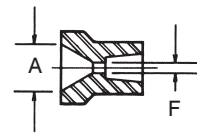

Style 5 Female Head

Center Type	STYLE 1			STYLE 2			STYLE 3			STYLE 4			STYLE 5		
	Part No.	A	F	Part No.	A	F	Part No.	A	F	Part No.	A	F	Part No.	A	F
II	00231	1.31	0.25	00232	1.82	1.24	00233	2.44	1.75	00234	2.84	2.26	00235	0.76	0.13
III	00331	1.83	0.35	00332	2.58	1.72	00333	3.32	2.46	00334	4.06	3.20	00335	1.12	0.19
IV	00431	2.27	0.36	00432	3.25	2.17	00433	4.22	3.14	00434	5.19	4.11	00435	1.37	0.23
V	00531	3.33	0.51	00532	4.80	3.21	00533	6.19	4.60	00534	7.65	6.06	00535	2.00	0.38
VI	00631	5.12	0.68	(Contact factory for availability).											



**CONCENTRIC**

## Long Point Spring Loaded Live Centers

- Accuracy to  $\pm .0001$ .
- Spring loaded spindle compensates for thermal expansion.
- Low profile - less overhang, added load capacity, and increased rigidity

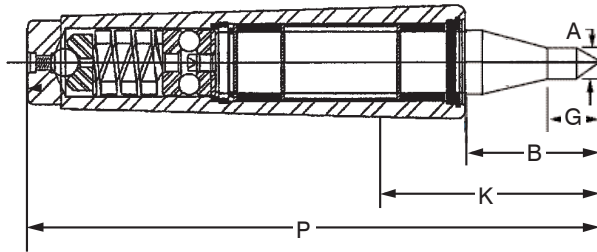

LONG POINT							
Type	A	G	K*	Max Thrust Load	Max Spring Travel	Max W.P. Weight	Max RPM
II	0.188	0.35	1.38	173	0.094	150	3000
III	0.250	0.47	1.69	235	0.125	260	3000
IV	0.375	0.70	2.38	671	0.156	580	2000
V	0.500	0.94	3.63	844	0.188	1100	1500
VI	(Contact factory for availability)						

\*K: Gage line to point typical for Morse Tapers.

TYPE II	
Taper	Part No.
2 MT	17162
5/8	17361
3/4	17362
XX	XXXXXX

TYPE III	
Taper	Part No.
3 MT	17163
1 SS	17363
1 1/4 SS	17365
XX	XXXXXX

TYPE IV	
Taper	Part No.
4 MT	17164
1 1/2	17366
XX	XXXXXX
XX	XXXXXX

TYPE V	
Taper	Part No.
5 MT	17165
XX	XXXXXX
XX	XXXXXX
XX	XXXXXX

## Spring Loaded Live Centers Standard and Tracer Point

- Accuracy guaranteed to  $\pm .0001$ .
- Bellville washers for automatic compensation for thermal expansion
- Color coded rings visually indicate one of three ranges of axial clamping pressure: light, medium or heavy.
- Four-point support for high axial and radial loads.
- Double labyrinth seal protects bearings from coolants and contaminants.
- Imported from Switzerland. Serviced and repaired in the U.S. by Riten.

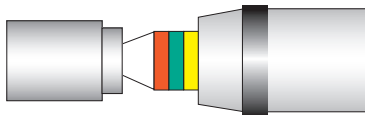
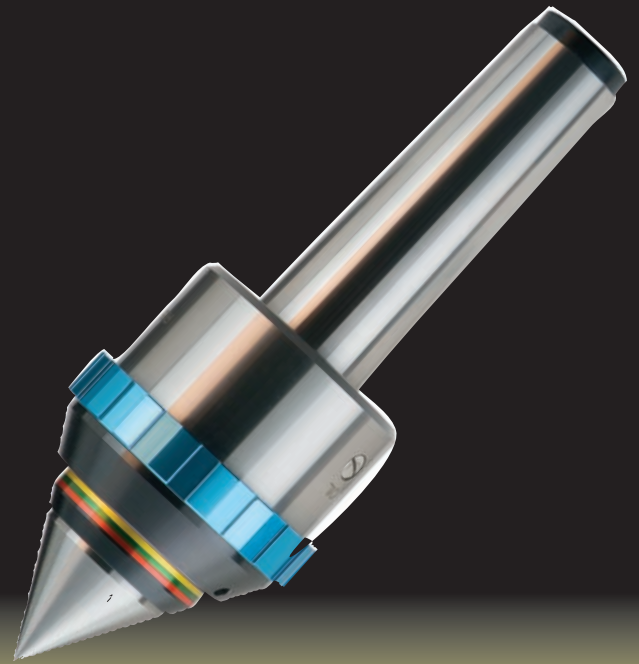

Low pressure for light workpieces and/or low stock removal

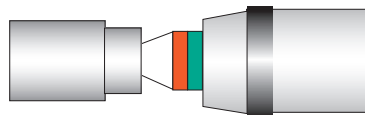

Medium pressure for medium workpieces and/or medium stock removal

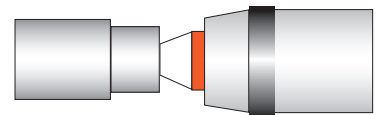

High pressure for heavy workpieces and/or heavy stock removal

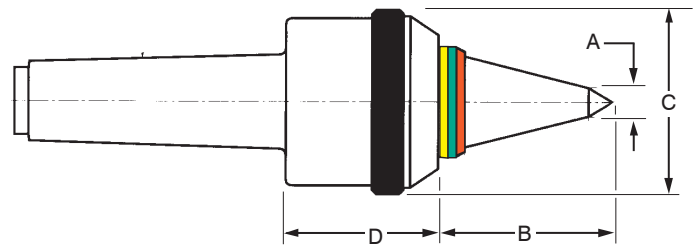
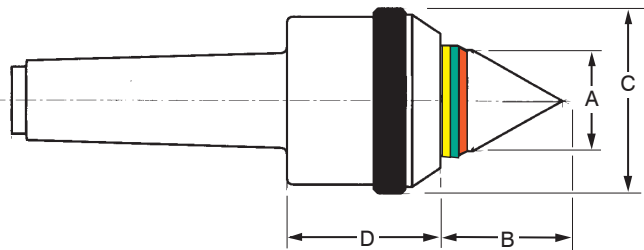

### STANDARD POINT - MORSE TAPER

Model	Taper	A	B	C	D	Max. Axial Load	Max RPM	W. P. Weight
17503	3	0.97	1.22	2.25	1.91	1150	4000	1600
17504	4	1.38	1.66	2.75	2.41	2150	3000	2600
17505	5	1.97	2.28	3.78	3.19	3000	2000	4300
17506	6	2.75	3.13	5.03	4.09	5600	1000	7600

### STANDARD POINT - STRAIGHT SHANK

17925	1.5	1.38	1.66	2.75	2.41	2150	3000	2600
-------	-----	------	------	------	------	------	------	------

### TRACER POINT - MORSE TAPER

Model	Taper	A	B	C	D	Max. Axial Load	Max RPM	W. P. Weight
17513	3	0.47	1.66	2.25	1.91	1150	4000	1300
17514	4	0.56	2.38	2.75	2.41	2150	3000	2100
17515	5	0.59	3.47	3.78	3.19	3000	2000	3100
17516	6	0.88	4.94	5.03	4.09	5600	1000	5300

### TRACER POINT - STRAIGHT SHANK

17915	1.5	0.56	2.38	2.75	2.41	2150	3000	2100
-------	-----	------	------	------	------	------	------	------



## Replacements for Ready Tool G and R Series Live Centers

- Accuracy guaranteed to  $\pm .0002$
- Replaceable threaded point, custom points available
- Points are through-hardened to 61-63 Rc
- Riten full service and repair



The Ready Tool Co. no longer manufactures live centers, but that doesn't mean you can't get the Ready G and R series built or repaired. Riten has been repairing and rebuilding these centers for decades, and they are now available as cataloged items. Riten has standardized on the G series, but, as can be seen in table, R models are basically equivalent and in some cases identical.

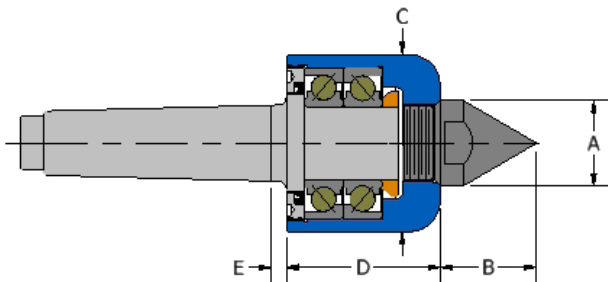

STANDARD MALE POINT - MORSE TAPER

Ready Model	Riten Model	MT	A	B	C	D	E	Thread
G10	G10-1	1	0.63	0.75	1.56	1.75	0.25	1/2-20
G20	G20-2	2	0.89	1.00	2.00	2.06	0.26	3/4-20
G30	G30-3	3	1.01	1.18	2.25	2.25	0.25	7/8-20
G40	G40-4	4	1.38	1.57	2.88	2.50	0.25	1 1/4-20
G50	G50-5	5	1.88	2.06	3.75	3.06	0.26	1 1/2-20
R1N	G10-1	1	0.63	0.75	1.56	1.75	0.25	1/2-20
R2N	G10-2	2	0.63	0.75	1.56	1.75	0.25	1/2-20
R3N	G20-3	3	0.89	1.00	2.00	2.06	0.25	3/4-20
R4N	G30-4	4	1.01	1.18	2.25	2.25	0.26	7/8-20
R5N	G40-5	5	1.38	1.57	2.88	2.50	0.25	1 1/4-20

Morse tapers standard. Other tapers available on request.



# Adjusta-Point Radial Compensating Live Centers

## Standard Point

- Designed to correct for off-center center holes
- Four adjusting screws move the point up to .030" in any direction.
- Accuracy guaranteed to  $\pm .0001$
- Additional tapers available on request
- Riten full service and repair

Point can be re-located  
.030" in any direction.

External adjusting  
screws

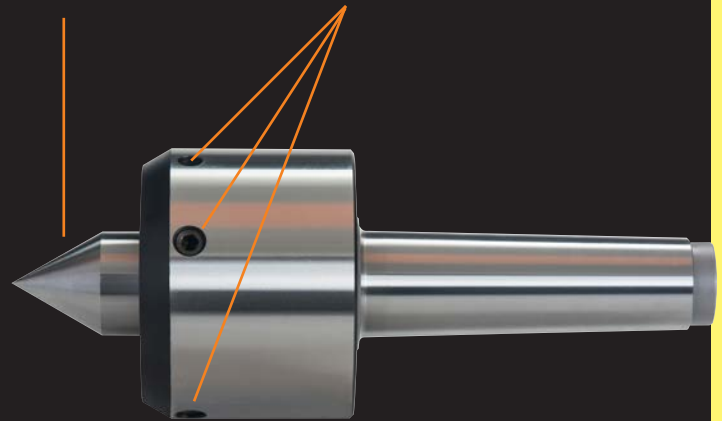

Produced originally as a "customer special", Adjusta-Point live centers have rapidly become a standard catalog item. They are designed specifically for applications when a workpiece's center hole is not quite on center. The adjustable point locates in the center hole, centering the part by offsetting the deviation. The process is similar to indicating a part using a 4-jaw chuck.

Stocked in Morse tapers, with other tapers on request.

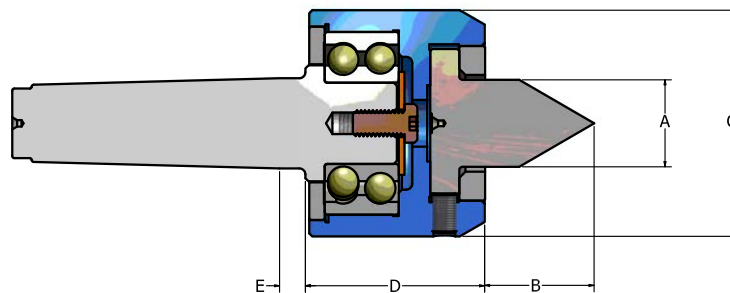

MORSE TAPER								
Model	MT	A	B	C	D	E	Max RPM	W. P. Weight
99993	3	1.69	2.12	4.39	3.40	0.51	3000	1500
99994	4	1.69	2.12	4.39	3.40	0.57	3000	3000
99995	5	1.69	2.12	4.39	3.40	0.57	3000	4500
99996	6	2.50	2.50	6.13	5.11	0.54	2500	7500
99997	7	2.50	2.50	6.13	5.11	0.54	2500	7500



## Spline Rolling Live Centers

- Accuracy guaranteed to  $\pm .00025$
- Tapered and ball bearings.
- Points are through-hardened to 61-63 Rc
- Riten full service and repair

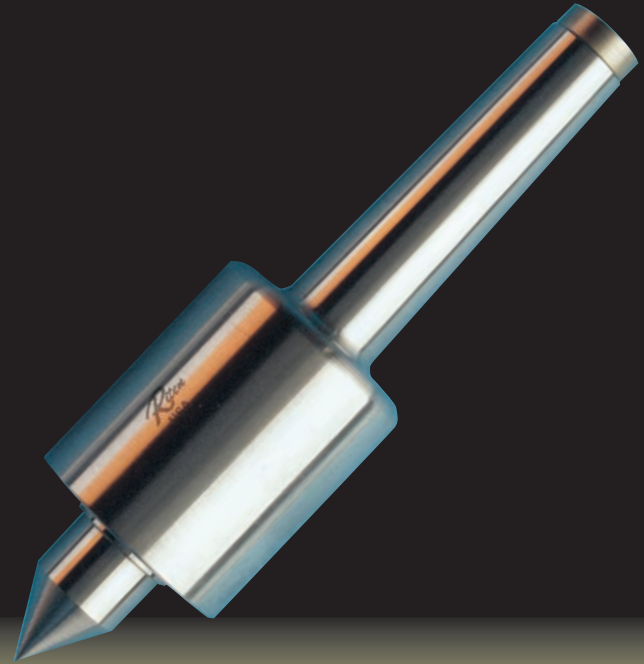

- Ideal for tight-tolerance applications
- Prompt deliveries on special points
- Also available in heavy-duty design

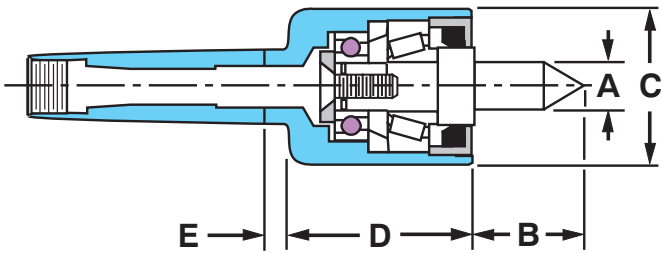

MORSE TAPER							
Model	Taper	A	B	C	D	E	W. P. Weight
46103	3	0.88	1.38	1.98	2.38	0.31	250
46104	4	0.88	1.38	1.98	2.38	0.31	250



CENTER EXTRACTOR	
46993	3 MT
46994	4 MT

Spline Rolling Centers are special application centers. Their design includes heavy-duty taper roller and ball bearings. The heat-treated points extend the life of the center. Lubrication is sealed in and no additional lubricant is required. Prompt deliveries on special points including female, cupped, long point, or radius end from semi-finished inventories. The Spline Rolling Center is available in heavy-duty design to meet difficult applications.



## Raptor Live Centers Standard and Tracer Point

- Accuracy guaranteed to  $\pm .0001$
- Tapered and ball bearings.
- Points are through-hardened to 61-63 Rc
- Riten full service and repair

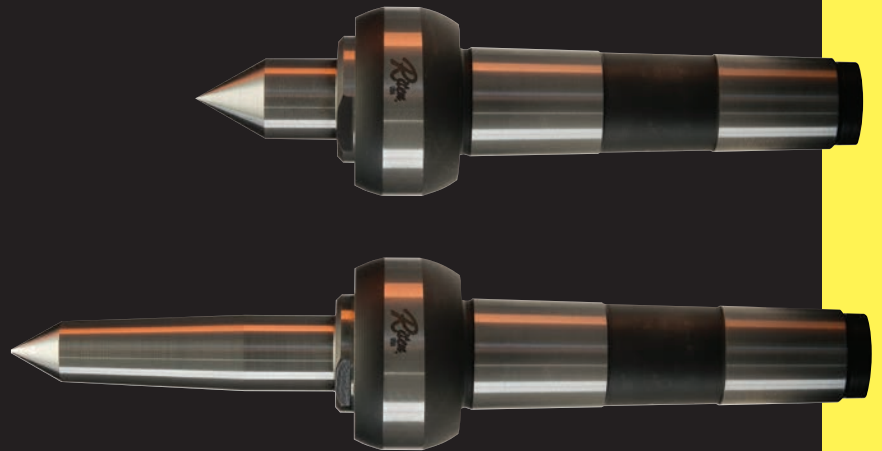

Riten's Raptor Live Centers are designed specifically for gear hobbing, cutting and grinding. They are an ideal replacement for foreign-made "Gepys", with higher concentricity, lower cost of ownership, and greatly reduced lead times. Repairs are made in the U.S., with turnaround times as little as two weeks.

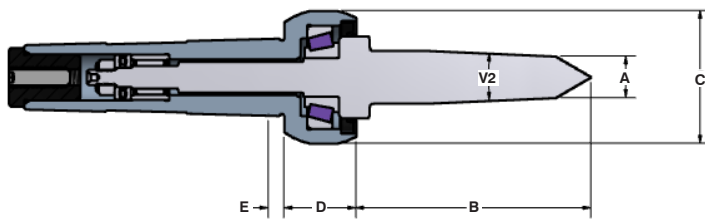
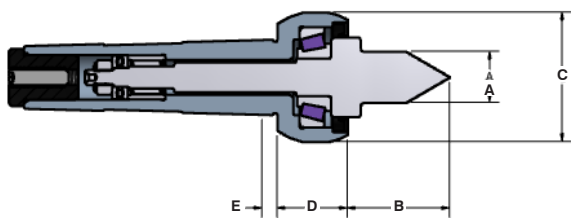

### STANDARD POINT - MORSE TAPER

Model	Taper	A	B	C	D	E	W. P. Weight
42603	3	0.63	1.28	1.63	0.91	0.19	250
42604	4	0.88	1.56	2.00	1.09	0.38	250

### TRACER POINT - MORSE TAPER

Model	Taper	A	B	C	D	E	V2	W. P. Weight
42903	3	0.50	2.88	1.63	0.91	0.19	5°	250
42904	4	0.72	3.06	2.00	1.09	0.38	5°	250

Estimated Max RPM - 3000



**Metal Spinning  
Live Centers**

**COMING SOON!**





## Center Service Programs

### Riten Repair/Trade-In Program

Upon receipt, Riten standard Live Centers will be rebuilt to “like new” condition at **40%** of the cost of a new center. This is a total reconditioning, which includes new spindle, new front and rear bearings, new seal, and new lubricant. All rebuilt centers are restored to original accuracy and receive the same factory warranty as a new center. The average turnaround time is a speedy two weeks.

If for any reason a Riten standard Live Center is determined to be beyond practical repair, a preferred customer trade-in allowance of 35% will be allowed toward the purchase of an equivalent new center.

Riten repairs 97% of all centers received, ours and competitors’, and remanufactures them to manufacturers’ specifications. Unrepairable centers will earn a trade-in allowance of up to 35% on a new Riten center.

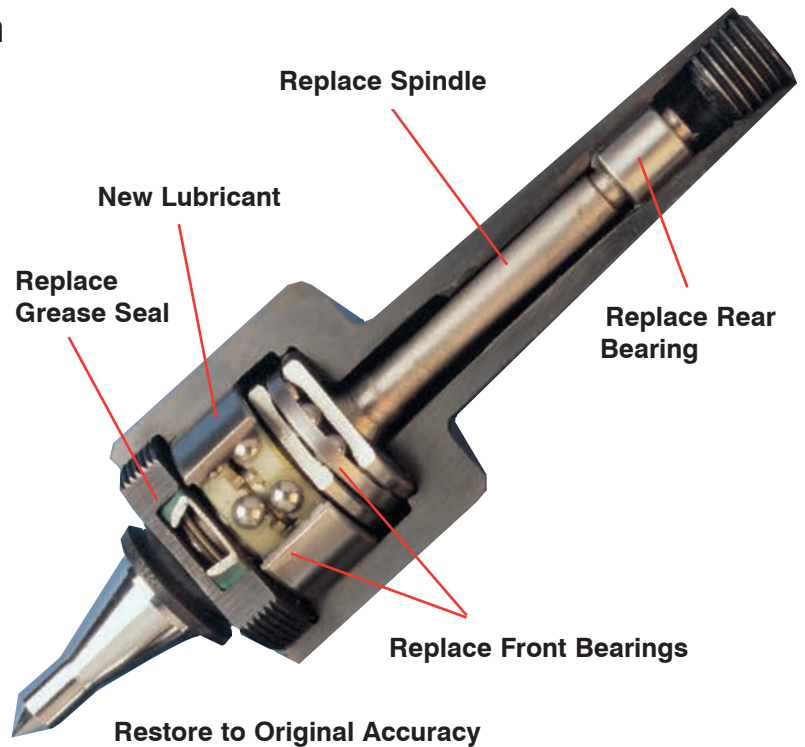

### Center Survey Program

In response to a number of customer requests, Riten has developed an in-plant survey program that helps you gain control of live and dead center availability and cost.

An authorized Riten representative, together with the distributor of your choice, conducts a complete inventory of all centers at your plant. The result is a written report listing all centers found at



your location, their condition, standardization suggestions, identification of duplicates, and trade-in opportunities. This information is extremely valuable in making sure the right centers are on hand, streamlining your inventory, and cutting costs.

This program is **free** to qualified customers. To request a center survey, call Riten Customer Service at 1-800-338-0027, or log on to [www.riten.com](http://www.riten.com). Samples of previous customer surveys can be provided on request.



# Live Center Specials

To order, fill in the dimensions you require and Fax to 800-338-0717 or E-mail a copy to [quotes@riten.com](mailto:quotes@riten.com). You can also go to [www.riten.com](http://www.riten.com) and "Design Your Own" center. Any dimension not supplied will be Riten factory standard.

## STANDARD POINT LIVE CENTER

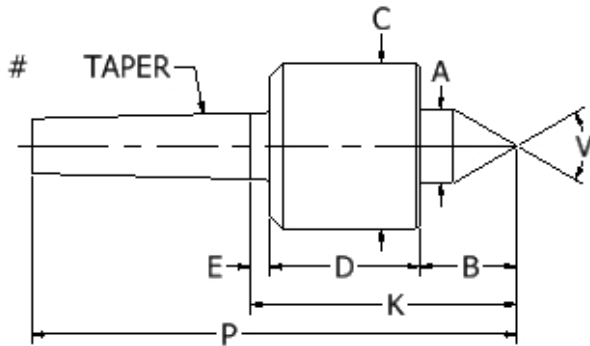

## Live Center Key

- A - Point Diameter
- B - Point Length
- C - Head Diameter
- D - Head Length
- E - Gage Line to Back of Head
- F - Minimum Diameter (Bull Nose and Female)
- G - Point to Angle (Sprint)
- K - Gage Line to Point
- P - Overall Length
- V - Point Angle

# \_\_\_\_\_ TAPER    A \_\_\_\_\_ B \_\_\_\_\_ C \_\_\_\_\_

E \_\_\_\_\_ F \_\_\_\_\_ G \_\_\_\_\_ V \_\_\_\_\_

RPM \_\_\_\_\_ Workpiece Weight \_\_\_\_\_ Thrust \_\_\_\_\_

## TRACER POINT LIVE CENTER

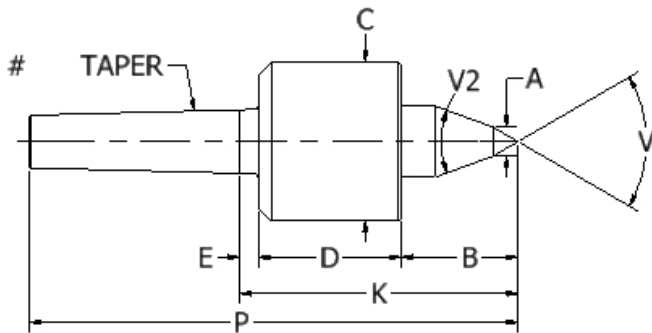

## LONG POINT LIVE CENTER

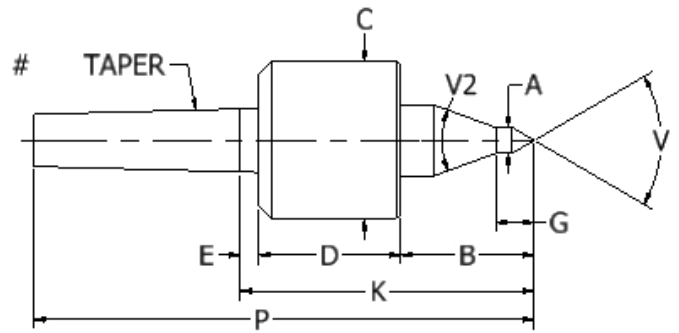

## PIPE NOSE LIVE CENTER

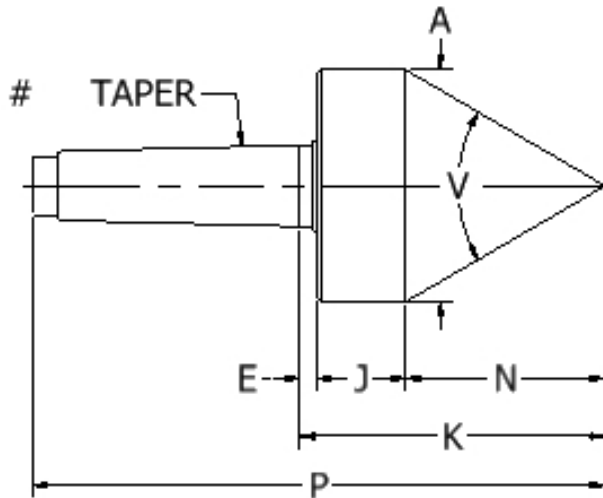

## BULL NOSE LIVE CENTER

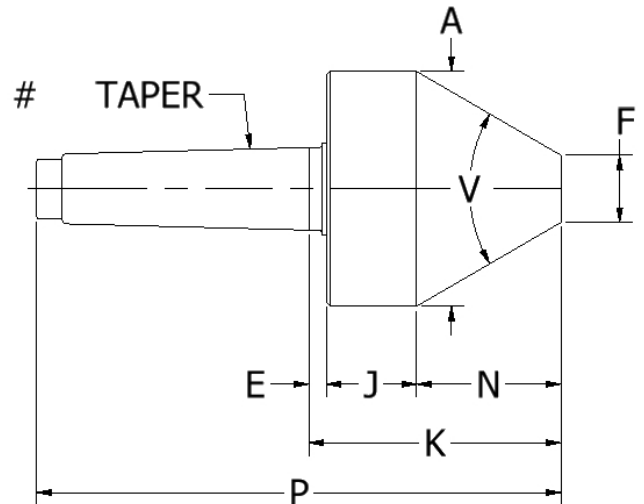



# Dead Center Specials

Standard drawings are available at [www.riten.com](http://www.riten.com).

## Dead Center Key

- |                               |  |                        |                             |
|-------------------------------|--|------------------------|-----------------------------|
| A - Point Diameter            | F - Minimum Diameter<br>(Bull Nose and Female) | K - Gage Line to Point | V - Point Angle             |
| B - Taper Length              | G - Female Major Diameter                      | L - Length of Cut Out  | V2 - Secondary Angle        |
| C - Gage Line Diameter        | H - Height Above Center Line                   | N - Point Length       | W - Flange Outside Diameter |
| E - Gage Line to Back of Head | J - Flat Length                                | P - Overall Length     | T - Carbide Tip Diameter    |

### CNC TAILSTOCK DEAD CENTER

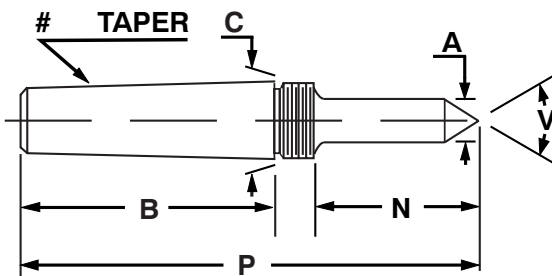

# \_\_\_\_\_ TAPER    A \_\_\_\_\_ B \_\_\_\_\_ C \_\_\_\_\_  
N \_\_\_\_\_ P \_\_\_\_\_ V \_\_\_\_\_ T \_\_\_\_\_

### FULL DEAD CENTER

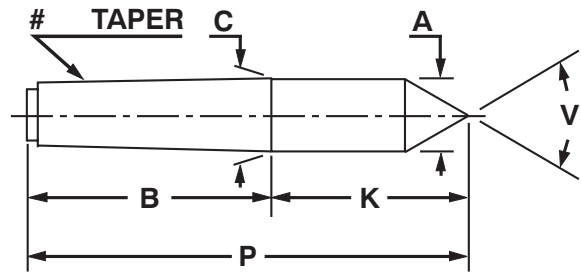

# \_\_\_\_\_ TAPER    A \_\_\_\_\_ B \_\_\_\_\_ C \_\_\_\_\_  
K \_\_\_\_\_ P \_\_\_\_\_ V \_\_\_\_\_ T \_\_\_\_\_

### HALF DEAD CENTER

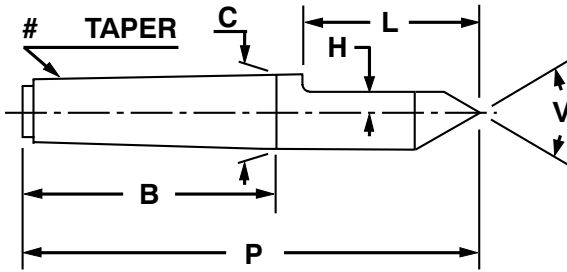

# \_\_\_\_\_ TAPER    B \_\_\_\_\_ C \_\_\_\_\_ H \_\_\_\_\_  
L \_\_\_\_\_ P \_\_\_\_\_ V \_\_\_\_\_ T \_\_\_\_\_

### FEMALE DEAD CENTER

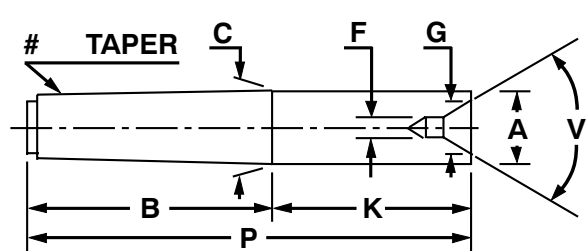

# \_\_\_\_\_ TAPER    A \_\_\_\_\_ B \_\_\_\_\_ C \_\_\_\_\_  
F \_\_\_\_\_ G \_\_\_\_\_ K \_\_\_\_\_ P \_\_\_\_\_ V \_\_\_\_\_

### BULL NOSE DEAD CENTER

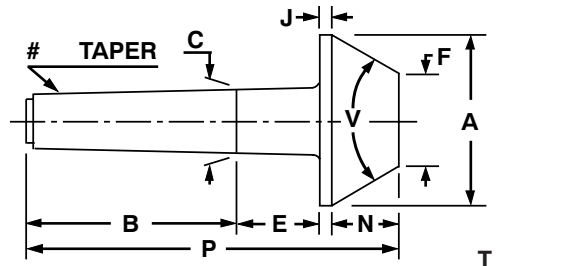

# \_\_\_\_\_ TAPER    A \_\_\_\_\_ B \_\_\_\_\_ C \_\_\_\_\_  
E \_\_\_\_\_ F \_\_\_\_\_ J \_\_\_\_\_ N \_\_\_\_\_ P \_\_\_\_\_ V \_\_\_\_\_

### PIPE NOSE DEAD CENTER

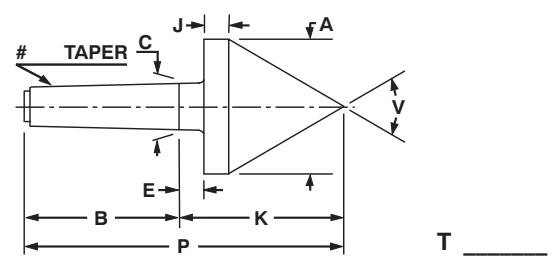

# \_\_\_\_\_ TAPER    A \_\_\_\_\_ B \_\_\_\_\_ C \_\_\_\_\_  
E \_\_\_\_\_ J \_\_\_\_\_ K \_\_\_\_\_ P \_\_\_\_\_ V \_\_\_\_\_



# Rebuilding and Repair Services

## Tailstock and Headstock Repair, Rebuilding & Custom Manufacturing

Riten has the capability to repair and remanufacture components for lathes and grinders from all manufacturers. Accuracies of rebuilt units are guaranteed to meet or exceed the manufacturer's original specifications, and carry a one-year factory warranty.

### Upgrades and redesigns

#### Re-engineered tailstock for giant engine lathe.

We designed a totally new live quill for a tailstock assembly capable of machining motor shafts weighing up to 200,000 lbs. These workpieces did not lend themselves to being run with steady rests, so the lathe had to be exceptionally rigid to meet the .005 accuracy required. The new design has consistently produced parts within .002.



#### Lathe tailstock for rebuild.

The ID was line bored and honed to restore roundness and size. A new quill was designed and manufactured. A new bearing assembly was selected to increase bearing capacity and rigidity. It used readily available bearings in the event of future maintenance. A new spindle was manufactured with a 5 Morse taper ID replacing the proprietary taper found in the old unit. The 5 Morse taper was selected since it provided commonality with the customer's existing tooling and had the advantage of being readily available. The tailstock was completely reassembled and painted prior to shipment to the customer.



**Live quill design and manufacture.** Our customer needed to increase the capacity of a large roll grinder, but the 7 Morse taper live centers used in the

tailstock would not support any heavier loads. Riten designed and manufactured a new 9" diameter by 36" long live quill to replace the existing dead quill. The new unit was rated for a maximum work piece weight of 40,000 pounds. The spindle featured a replaceable point option to allow the customer to center 60°, 70°, and 90° center holes. The tailstock was honed to size and assembled on site with the new quill by our field service personnel.



### Repair and rebuilding

**Rebuilt headstock of a large Russian lathe.** The lathe was used to turn rough forged 30 ft. rolls weighing approximately 20,000 lbs. The rotating spindle was completely refurbished: bearing bores and shoulders were plated and ground; the ID taper and mounting face were ground and held concentric to the bearings within .0002" TIR. The spindle was reassembled with new bearings and seals and returned to the customer for installation.

**Reground tailstock spindle from a Mazak lathe** with a damaged 6 Morse taper ID. The bearing bores were in good condition, so the shaft was steady rested and the Morse taper ID was ground concentric to the bearings within .0002" TIR. The spindle was returned to the customer for assembly into the lathe.

**Remanufactured tailstock spindle from a Cincinnati step grinder.** Riten ground, plated and ground the bearing diameters and shoulders. We steady rested the spindle and ground the 14 Jarno taper ID concentric to the bearings within .0002" TIR. The spindle was returned to the customer for reassembly.

## Live Chuck Mandrel

For rolls with damaged center holes, a Riten Live Chuck Mandrel can be used to chuck the bearing journals of the part. A variety of custom mandrels can be manufactured to fit any application. A new or existing chuck can be mounted on the taper of your choice.

- High precision: mandrel accuracy guaranteed to  $\pm .0001$ . Assembled accuracy depends on the chuck.
- Designed for maximum rigidity and long bearing life
- Compatible with all flat back chucks, including jaw chucks, compensating chucks, and magnetic chucks.

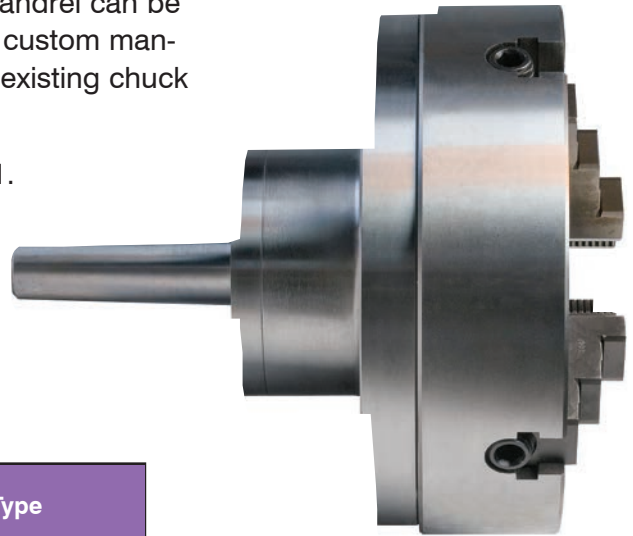

Order Code	Morse Taper	Chuck Size		
23104	4	4"	6"	8"
23105	5	8"	10"	12"
23106	6	10"	12"	16"
23107	7	12"	16"	18"

Chuck Type	
3JS	3-Jaw Scroll
6JS	6-Jaw Scroll
4JI	4-Jaw Independent
M	Magnetic Chuck

Example: a 5 Morse Taper Live Chuck Mandrel with a 10" 4-Jaw Independent chuck is part number **23105-10-4JI**. Other chuck sizes and taper shanks available on request. Dead Chuck Mandrels are also available.

## Linear Compensating Live Center

- Four interchangeable springs provide light, medium, heavy duty and extra heavy duty axial deflection pressures to compensate for thermal expansion and varying workpiece dimensions.
- Reduced center inventory and significant reductions in set-up time.
- Available in tapered and straight shanks, as well as a self-contained model (shown) that can be chucked for sub-spindle applications.
- Handles workpieces from tens to thousands of pounds.
- Lockable spindle quickly transforms the unit into a carbide tipped dead center.





# Engineered Products (cont.)

## Replaceable Bell Head Live and Dead Centers

### Dead Center Mandrels

- Heat treated for additional strength
- Accuracy guaranteed to  $\pm .0001$  assembled

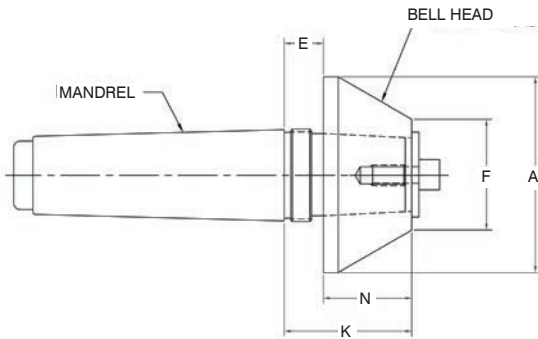

### Live Center Mandrels

- Accuracy guaranteed to  $\pm .0001$  assembled
- Riten full service and repair

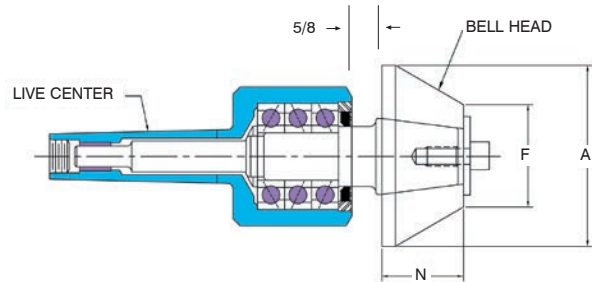

#### DEAD CENTER MANDRELS - MORSE TAPER

Model	MT	Threads	E	K	Bell Head
01104	4	-	0.50	2.19	Series 1
01114	4	M35 x 1.5	0.75	2.44	Series 1
01105	5	-	0.50	2.19	Series 1
01115	5	M45 x 1.5	0.75	2.44	Series 1
01195	5	-	0.75	2.71	Series 2
01185	5	M55 x 2.0	0.75	2.71	Series 2
01106	6	-	0.50	2.63	Series 2
01116	6	M55 x 2.0	0.75	2.88	Series 2
01117	7	M85 x 2.0	0.75	2.88	Series 2
01124*	4	M35 x 1.5	1.25	2.94	Series 1
01125*	5	M45 x 1.5	1.25	2.94	Series 1
01155*	5	M55 x 1.5	1.70	3.83	Series 2
01126*	6	3.00-12	2.35	4.48	Series 2

#### LIVE CENTERS - MORSE TAPER

Model	MT	Max. W. P. Weight	Bell Head
51403	3	730	Series 1
51404	4	1760	Series 1
51405	5	3520	Series 1
34405	5	6400	Series 2
34406	6	11,200	Series 2
34417	7	11,200	Series 2

Threaded mandrels include the extraction nut.

\* Special taper for Mazak machines

#### BELL HEADS (Fit both live centers and mandrels)

Model	A	F	N	Bell Head
01375	3.75	2.12	1.69	Series 1
01525	5.25	3.62	1.69	Series 1
01675	6.75	5.12	1.69	Series 1
01825	8.25	6.62	1.69	Series 1
01975	9.75	8.12	1.69	Series 1

#### BELL HEADS (Fit both live centers and mandrels)

Model	A	F	N	Bell Head
02045	4.50	2.50	2.13	Series 2
02055	5.50	3.33	2.13	Series 2
02075	7.50	5.33	2.13	Series 2
02095	9.50	7.33	2.13	Series 2
02115	11.50	9.33	2.13	Series 2
02135	13.50	11.33	2.13	Series 2
02155	15.50	13.33	2.13	Series 2

All Bell Heads are heat treated for additional strength.

All Bell Heads include screw and washer.

## Pipe Driver (Bore Driver)

- Full turning or grinding without unchucking
- Blades index in the event of scoring, doubling blade life
- Replacement blades are interchangeable within .005"
- Blades can be replaced or indexed without removing from machine
- Retainer lugs and slot depth provide excellent stiffness and rigidity under extreme feeds and speeds
- Torque limit on straight shanks prevents driver from slipping at breakaway/startup
- Crowned angles and flats designed to minimize impressions in bevels
- Material selection and heat treating are carefully monitored to maximize performance under demanding production conditions

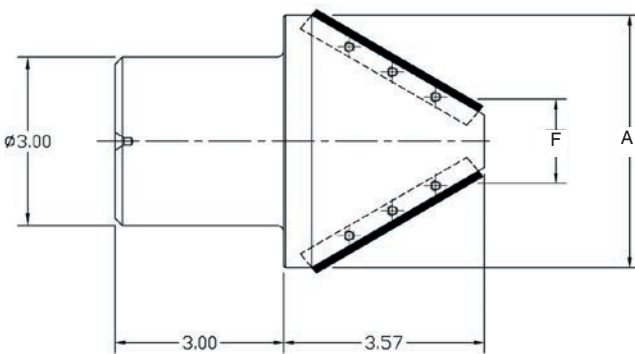

PIPE DRIVER			
Model	A	F	No. of Blades
PD045	4.50	1.50	3
PD075	7.50	4.50	5
PD105	10.50	7.50	7
PD135	13.50	10.50	9

Pipe Driver comes with two sets of crowned blades.

BLADES	
Model	Blade Style
BS100	Square
BC100	Crowned

## Spider Mandrels (Live or Dead)

- Precision incremental adjustments in thin wall bores
- Rotational accuracy of mandrels is .0002"
- Available with 3, 4, and 6 adjustment lugs
- Design of mandrel provides easy access to adjustment lugs
- Optional materials available for special design lugs
- Bull rings with extended lugs available to accommodate larger bores without changing the mandrel



## Adapter Sleeves

Precision-ground threaded adapter sleeves allow the use of your existing centers or face drivers on lathes and grinders with differing tapers.

- Accuracy guaranteed to  $\pm .0001$
- Through-hardened to 55-58 Rc
- Stocked in Morse tapers. Jarno, straight shank, and other tapers available on request.



Jam nut sold separately

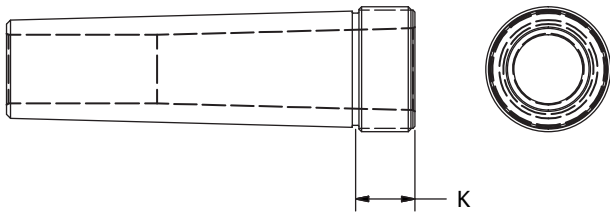

Model	Morse Taper O.D.	I.D.	K	Nut Part No.
10132	3	2	.80	81041
10142	4	2	.80	86041
10143	4	3	.80	86041
10152	5	2	.94	86055
10153	5	3	.94	86055
10154	5	4	.94	86055
10163	6	3	1.23	86065
10164	6	4	1.23	86065
10165	6	5	1.23	86065

## Center Extractors

Center hard to pull? Lose the hammer, and use an extractor.

- For live and dead centers
- Available in one-piece design with jack screws, or two-piece with ejector wedge
- Made to order. Contact Riten for details and price quote.

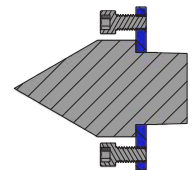
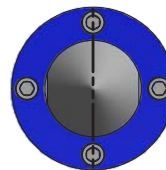
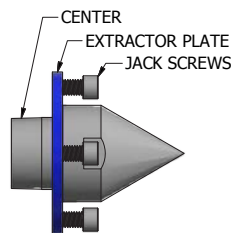

One-Piece Design

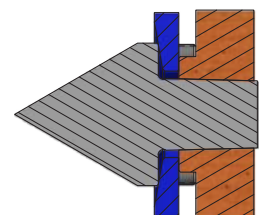
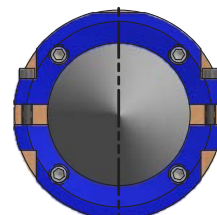
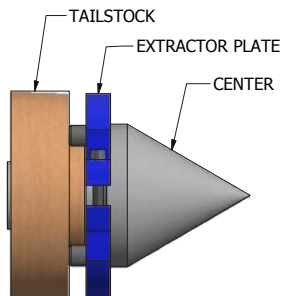

Two-Piece Design



### Tailstock Force Gauge



**Measuring Range: 200-6000 Lbs Force**

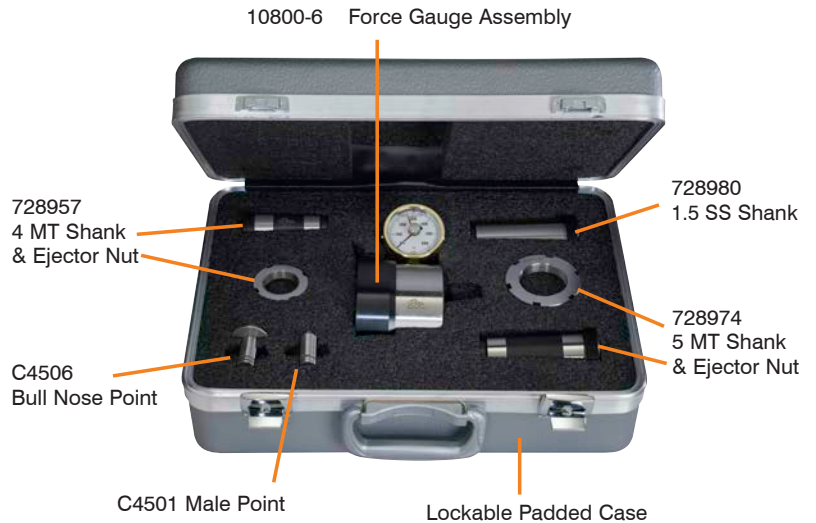

For many precision jobs using a face driver, it is critically important to know the exact force applied to the workpiece. Riten allows you to eliminate any guesswork, especially on older machines. Our new Force Gauge, in conjunction with the tailstock's pressure reading, accurately calibrates the lathe to deliver the precise load for faster setup and repeatable, scrap-free production.

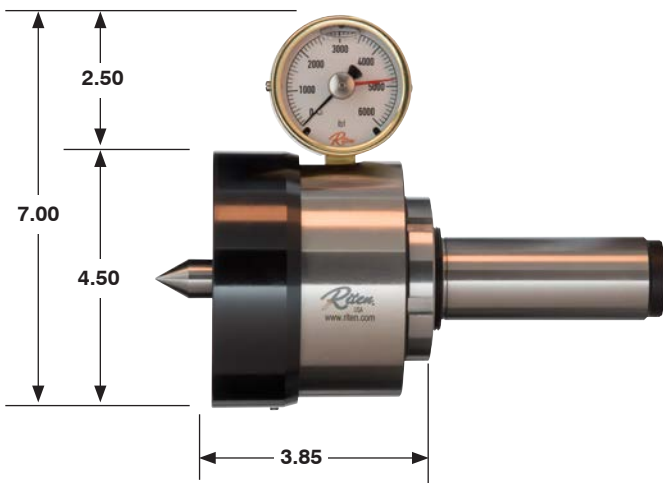

**Complete Kit: Model No.10800-6-KIT**

KIT COMPONENTS	
Model	Item
10800-6	Force Gauge Assembly
728957	4 MT Shank & Ejector Nut
728974	5 MT Shank & Ejector Nut
728980	1.5 SS Shank
C4501	Male Point
C4506	Bull Nose Point
	Lockable Padded Case

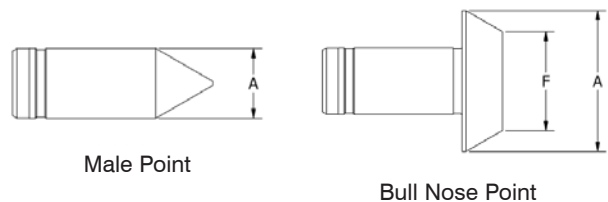

INTERCHANGEABLE POINTS			
Model	Style	A	F
C4501	Male	.71	-
C4503	Bull Nose	1.03	.58
C4506	Bull Nose	1.50	1.05

## Center Drill Machine

- Scroll chuck with hardened steel jaws
- Durable and lightweight cast aluminum housing
- Bearing Bronze Quill “Precision Fitted” to the Spindle will give you years of accurate service
- Rack & pinion feed gear with heavy duty feed handle for fatigue free drilling

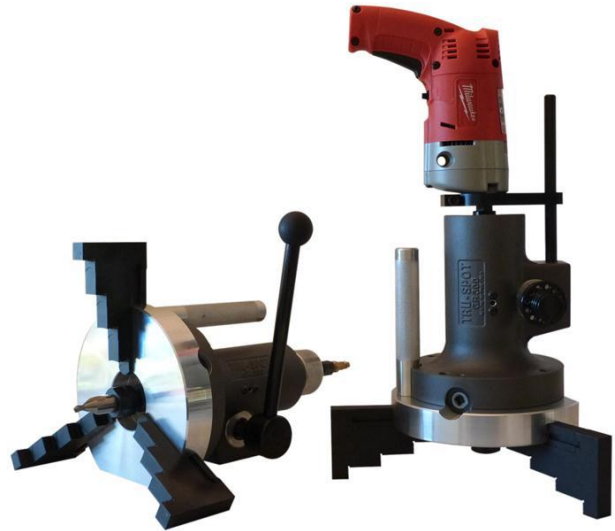

The GR300 Tru-Spot Center Drill Machine (part # GR300-12) with .85 HP, 1200 RPM air motor and standard 12” Jaw capacity is a precision center drilling machine for bar stock. It will accurately center shafts from 2.5” to 12” diameter in minutes. You can increase holding diameter with our optional extension jaws (part # GR300-24).

New GR300 Tru-Spot Center Drill Machine (part # GR300-12E) with ½ HP, 700 RPM Milwaukee Electric Drill and standard 12” Jaw capacity is a precision center drilling machine when accurate centers are required on a less frequent basis. You can increase holding diameter with our optional extension jaws (part # GR300-24E).

Our stocked Center Drill Bits range in sizes from 5/16” to 1-1/2” and fit our 12mm collet system. Special center drill bits, including solid carbide bits are available upon request.

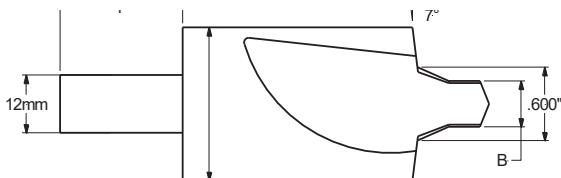
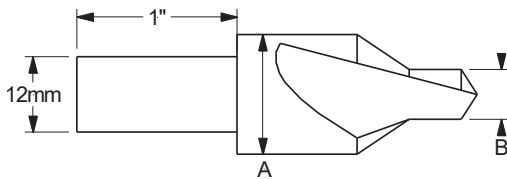

HSS CENTER-BITS				
Model	A	B	Overall Length	Tru-Coat*
GR4	5/16”	1/8”	2 1/2”	GR4TC
GR6	1/2”	7/32”	2 1/2”	GR6TC
GR7	5/8”	1/4”	2 1/2”	GR7TC
GR8	3/4”	5/16”	2 1/2”	GR8TC
GR10	1”	3/8”	3”	GR10TC
GR125	1 1/4”	3/8”	3 1/2”	GR125TC
GR135	1 1/2”	3/8”	3 1/2”	GR135TC

HSS CENTER-RELIEF BITS				
Model	A	B	Overall Length	Tru-Coat*
GR22	1 1/4”	3/8”	3 1/2”	GR22TC

\*Tru-Coat Coating for Aluminum Alloys, Alloy Steels, Stainless Steels, High Temperature Alloys\*



## Introduction to Face Driving



Ever increasing demands on the manufacturer to improve productivity and quality have led to the need for faster machining techniques. Face drivers, coupled with modern high performance equipment, maximize productivity and increase product quality at minimal expense.

With a Riten Face Driver, the entire work piece is exposed for machining. Since a face driver locates on the end face of the shaft, it is possible to machine the entire length of the work piece in one operation. The single axis reference point established by the center point of the face driver allows for a high degree of accuracy. In comparison, traditional machining requires multiple operations as the part is reversed to turn both ends. Accuracy and productivity suffer as the part is repeatedly chucked. By eliminating operations and setups the use of a face driver reduces costs, increases productivity and produces a part with a higher degree of accuracy.

***If you are new to face driving or need assistance in selecting a face driver, call Riten at 1-800-338-0027 and ask to speak to a face driver technical specialist. Alternatively, fill out the Information Request form on page 52 and fax to Riten at 800-338-0717 or email to [Quotes@riten.com](mailto:Quotes@riten.com). A product specialist will contact you with a recommendation.***



***To learn more about face driving, click here to watch our instructional videos.***

### Mechanical Design: Type 40 thru 50

The mechanical design has several advantages in comparison to the older hydraulic design. It is a true quick change system, allowing the interchangeability of drive pins and center points without disassembling the face driver. Changing out a set of drive pins and a center point can be accomplished in less than a minute. During operation the center point in the mechanical design locks in place providing superior rigidity and a higher degree of accuracy in comparison to the hydraulic design. Depending on the mounting, concentricity ranges from .0004 -.0008 inches TIR.



### Hydraulic Design: Type 62 thru 68

Although the hydraulic design requires minor disassembly, changing out a set of drive pins and a center point can be accomplished in five to ten minutes. It performs best in roughing applications where part accuracy is not as critical. The hydraulic design compensates for a higher degree of inaccuracy in the part face in comparison to the mechanical design. Depending on the mounting, concentricity ranges from .0015 -.0025 inches TIR.



Both designs are offered in a variety of sizes. This wide range of models offers a high degree of versatility for large parts, such as large rolls, motor shafts and crankshafts; for small parts, such as valve stems, ball studs and automatic transmission shafts; for rough castings and forgings, such as automotive gears. Face drivers are used in many between center operations, such as hobbing, milling, shaping, gear cutting, spline milling, facing and turning.

In addition to traditional turning, face drivers are becoming increasingly popular in both hard turning and grinding applications. Consult the factory in these circumstances since special pins and a special face driver may be required.

### Selecting a Face Driver

In selecting a face driver several factors should be considered. As stated earlier, the simplest approach is to fill out an Information Request form on page 52 and send it to the factory. The second approach is to fill out the Information Request form and select the driver yourself based on material hardness, accuracy required, part diameter and the required mounting method. You may find it helpful to fill out the request form as you read the following example:

Assume you are attempting to turn a 15" long piece of 2" diameter bar stock (Dimension S), while maintaining .0004" TIR. The face driven end finishes at 1.5" in diameter (Dimension F). It has a .380 diameter center hole. The lathe has an A2-6 spindle nose. Part rotation is clockwise and the material is under 35 Rc. Harder materials may require carbide or diamond coated drive pins. Consult the factory in these circumstances.

Accuracy is dependent on the mounting method and the design of the driver. Direct spindle mounting with a flange mount driver is the most accurate, followed by taper mounts and jaw chucking. Mechanical face drivers are accurate within .0004 - .0008" TIR depending on the mounting. Hydraulic face drivers are accurate within .0015 - .0025" TIR depending on the mounting. In this example, a flange mount mechanical face driver would be the best choice since you are trying to achieve .0004" TIR.

### Sizing a Face Driver

To size the driver, determine the minimum stock diameter of the work piece on the face-driven end. Take into account any chamfers. The drive pin driving diameter must be smaller than this to allow for tool clearance. Allow a minimum of .080" clearance between the part diameter and the driving diameter of the face driver. In selecting the driving diameter, there are two general rules of thumb to consider: The maximum stock size should be no more than 2 - 2.5 times the driving diameter and the maximum part length should not exceed 15 times the driving diameter. Continuing with this example, a 44FM face driver (page 60) with a driving diameter of 1.02 - 1.42" would be a good choice. Even at the smallest driving diameter, the 44FM satisfies both rules of thumb. Other drivers will work, but the 44FM is neither too big nor too small.

Center points are selected based on center hole size. Drive pins are selected based on driving diameter, the direction of rotation and the choice of center point. In this example, a C4601 center point will accommodate the .380 diameter center hole. As stated earlier, when looking directly at the driver the rotation is clockwise. P4404 or P4406 drive pins satisfy both the rotation requirement and the selection of a C4601 center point. If several drive pins will work, select the pin with the largest driving diameter.

To finish the example, the correct selection is a 44FM face driver, a 708038 spindle adapter, a C4601 center point and six P4406 drive pins.

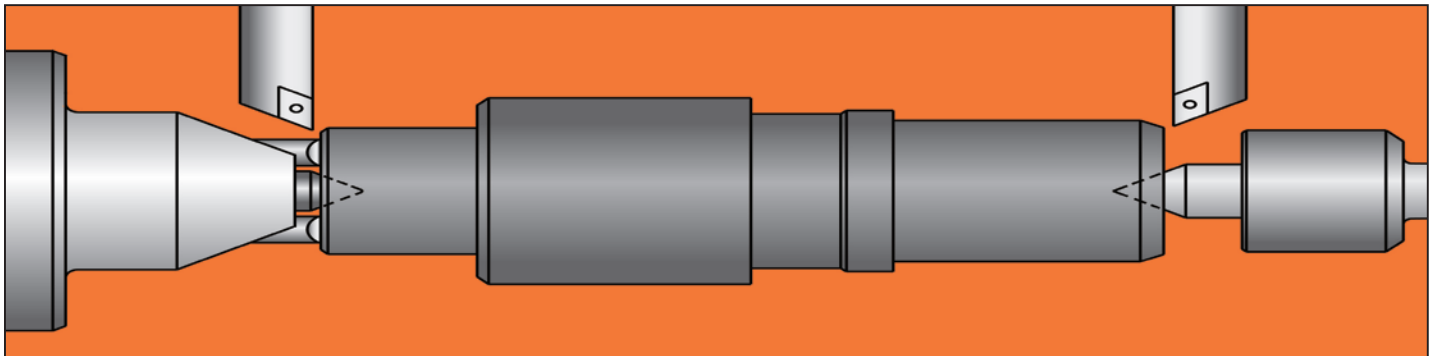

The following technical information is needed to determine your face driver requirements. Please complete and fax to Riten at 1-800-338-0717. If you have any questions please phone our customer service department at 1-800-338-0027, or send an email to [quotes@riten.com](mailto:quotes@riten.com).

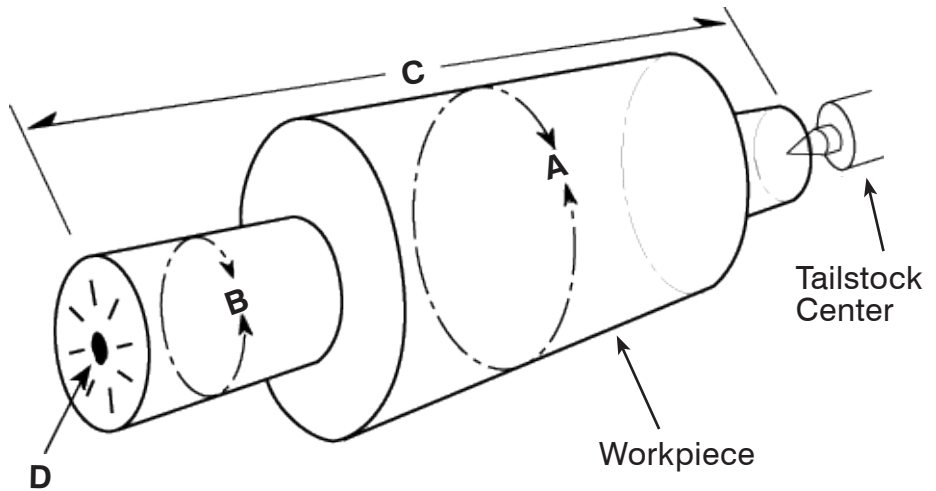

### Face Driver Mounting Data

Type of mount (check one):  Flange mount  Chuck mount  Taper mount  Other \_\_\_\_\_  
 If flange mount (check one):  A2-5  A2-6  A2-8  A2-11  Other \_\_\_\_\_  
 If taper mount (check one):  3 MT  4 MT  5 MT  6 MT  Other \_\_\_\_\_

### Workpiece Data

Workpiece Name (description): \_\_\_\_\_

A Beginning Diameter: _____	• Material Type: _____
B Finished Diameter: _____	• Material Hardness: Rc _____ BHN _____
C Overall Length of Workpiece: _____	• Workpiece Weight: _____
D Center Hole Diameter: _____	• Concentricity to Achieve: _____
E Center: Live ____ Dead ____	• Maximum Tailstock Ability Force (lbs.): _____

**Please attach finished part print to this application data request sheet.**

### Operation

Maximum Depth of Cut: \_\_\_\_\_ Are there simultaneous operations?  Yes  No  
 Feed/Revolution: \_\_\_\_\_ Spindle rotation:  
 Cutting Speed (inch/rev.): \_\_\_\_\_  Clockwise  Counterclockwise  Both  
 RPM: \_\_\_\_\_

### Machine Data

Machine Type (check one):  Lathe  Mill  Hobber  Grinder  Other \_\_\_\_\_  
 Machine manufacturer: \_\_\_\_\_ Machine Model No: \_\_\_\_\_  
 Tailstock center:  Live  Dead  
 Tailstock center size:  3MT  4MT  5MT  Other \_\_\_\_\_  
 Maximum tailstock force available (lbs.): \_\_\_\_\_

## Direct Spindle Mounting

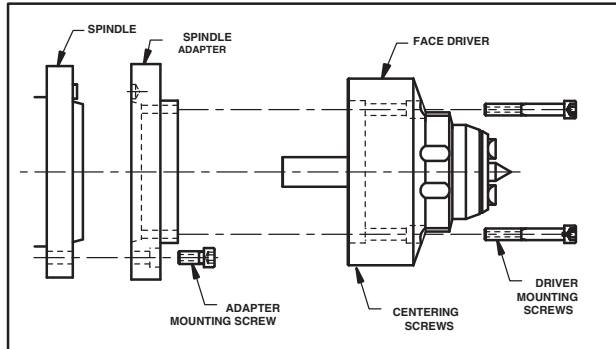

Both the FM series of mechanical face drivers and the F series of hydraulic face drivers can be mounted directly to the machine spindle nose with an adapter plate. You will need a flange mount face driver and the appropriate spindle adapter for your machine. Remove the chuck and any adapter plates exposing the machine spindle. Inspect the mounting taper in addition to the spindle face for burrs, dents, or any irregularities that may affect the proper seating of the new adapter plate. With the adapter, you will have received fasteners for the face driver, adjustment (stirring) screws for the adapter plate and an adjustment ring. The stirring screws should already be installed in the adapter plate. The adjustment ring will need to be installed on the back face of the face driver. Gentle tapping with a rubber mallet should be sufficient to press the ring on the back of the face driver. Install the adapter plate on the machine spindle nose using the fasteners that originally held the chuck in place.

Once the adapter plate is tightened securely you are ready to mount the face driver to the spindle adapter. We recommend removing the center point from the driver since this ID is your primary indicating datum. The fasteners which secure the face driver to the adapter plate should be snug but not tight since you will be indicating the bore to bring the driver on center. Make sure the (4) stirring screws in the adapter are backed off so the driver can be indicated freely. By using the adjusting screws and indicating on the ID, you can bring the face driver on centerline with the machine spindle. Indicate the driver as close to zero as possible.

Tighten the fasteners snugly and check the run out again to make sure that nothing moved off center. **Direct mounting is the most accurate way to mount the driver to minimize part run out.**

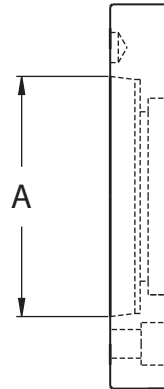

"A" Dimension	Spindle Size
3.250 in (82.55 mm)	A2-5
4.188 in (106.37 mm)	A2-6
5.500 in (139.70 mm)	A2-8
7.750 in (196.85 mm)	A2-11

"A" dimension = largest diameter of spindle nose to determine spindle size.

## Chuck Mounting

Flange mount, chuck mount and Morse Taper mount face drivers can all be jaw chucked. This is an excellent method of utilizing your face driver when removing the chuck is not desirable. Although flange mount drivers are intended to be direct mounted, chucking on the flange is an acceptable practice. It is possible to jaw chuck a Morse Taper mount by inserting the driver in a straight shank adapter sleeve and chucking on the sleeve. Another alternative is to jaw chuck the head of the driver, although care must be taken to avoid damaging the unit. We recommend machining a positive stop or shoulder in your soft jaws to prevent tailstock pressure and cutting forces from pushing the face driver back in the jaws.

Chuck mount hydraulic face drivers have a six degree reverse angle machined on the OD of the flange. You should machine your soft jaws to this angle to ensure the face driver is securely locked in position. Once the face driver is securely held in the jaw chuck you should remove the center point and check the run out. Any eccentricity in the mounting will be reflected in the part.



## Tailstock considerations

For machines with a dead tailstock, a heavy duty live center suitable for high axial loads (Page 6) should be used. Use of the appropriate live center will allow smooth, free rotation of the work piece. Hydraulic tailstocks should include a means of throttling the stroke to prevent a “hammer blow” effect as the work piece contacts the drive pins; otherwise, the pins could be damaged.

## Machining the work piece

Work piece Hardness – Generally speaking there will be no problem with drive pin penetration at normal tail stock pressures if the work piece hardness does not exceed 36 Rc. Harder parts may require special carbide tipped or diamond plated drive pins. We suggest you contact the factory at 800-338-0027 for specific recommendations.

## Pin Penetration

Before engaging the face driver, double check that you have the correct drive pins and center point. Running pins in the wrong rotation will result in immediate damage to the face driver.

The pictures below illustrate the indentations made by the drive pins during the initial clamping stage (Fig. 1), and the final clamping stage (Fig. 2). Note the uniformity of each indentation, indicating that every drive pin has penetrated the face to the same depth, assuring equal grip by each pin during machining.

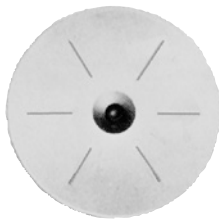

Fig. 1  
End view of workpiece

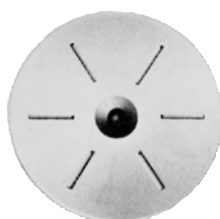

Fig. 2

Pin penetration from the initial clamping stage should range from 0.003 – 0.005 inches. Visually inspect the first piece prior to taking a cut! Adjust tail stock pressures accordingly. Pin penetration after machining should range from 0.010 to 0.020 inches. Visually inspect the first piece and adjust tail stock pressures accordingly. Visual inspection is an accepted practice when actual tail stock force is not available. Do not confuse hydraulic pressure with tailstock force.

## Cutting recommendations

1. When setting up for the first time, always use a new insert.
2. The end face of the workpiece should be square within .005. This is particularly important when using Face Drivers with only 3 drive pins.
3. Make sure the workpiece center hole is within the diameter range of the selected center point.
4. When installing the face driver, **indicate in the center point as close to zero as possible** to reduce runout.
5. **IMPORTANT!** Before use, make absolutely sure the drive pins are oriented properly with respect to driver rotation (clockwise or counter-clockwise). Incorrect orientation will result in immediate damage to the face driver.
6. For proper face driver operation the first cut is always toward the driver. This will help to firmly embed the drive pins in the work piece. Subsequent operations may cut in either direction, although cutting away from the driver may require higher tail stock pressures.
7. Periodically check the indentations during subsequent operations. If the penetration line begins to have a raised edge on one side, or there is other evidence that the pin is slipping, the drive pins should be changed immediately.



## Disk Driver

Gripping disks are interchangeable and bi-directional.

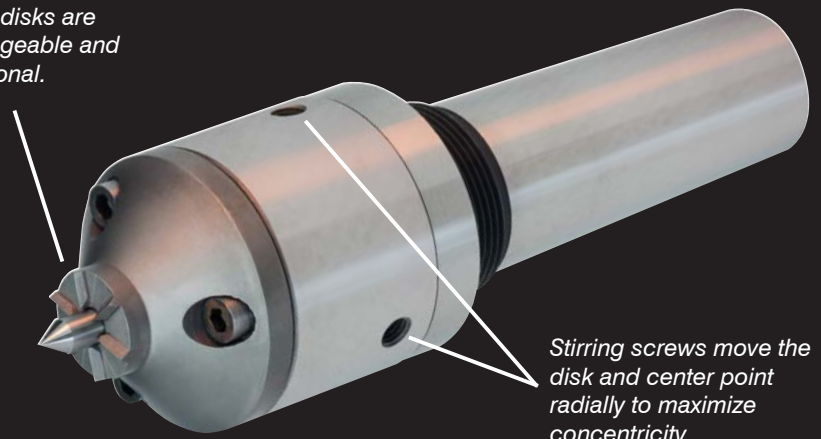

Stirring screws move the disk and center point radially to maximize concentricity.

- Designed to grip small workpieces with driving diameters from .32 to 2"
- Ideal for gear hobbing and other aggressive machining
- Available in Morse taper and standard straight shanks. Additional tapers available on request

This modified face driver is designed to get a solid grip on small-diameter workpieces. Instead of individual drive pins, the unit features interchangeable drive disks that securely penetrate the face of the part.

The disks are available in a choice of diameters, similar to the driving diameters on standard face drivers. Two styles are available: multi-toothed for softer materials, and diamond-coated for harder surfaces.

The design allows the disks to be bi-directional for both clockwise and counter-clockwise rotation. This also compensates for the backlash common to gear hobs. Three stirring screws move the disk and center point radially to compensate for mis-drilled center holes and other concentricity issues in the workpiece or in the machine.

DISK DRIVER	
Order Code	Mounting Style
5803	#3 Morse Taper
5804	#4 Morse Taper
5805	#5 Morse Taper
580150	1.5 Straight Shank

CENTER POINT		TOOTHED DRIVE DISKS			COATED DRIVE DISKS		
Order Code	Center Hole Diameter Range	Order Code	Outer Driving Diameter	Inner Driving Diameter	Order Code	Outer Driving Diameter	Inner Driving Diameter
C4301	0 - 0.320	D5801	.565	.400	D5891	.565	.400
		D5802	.750	.470	D5892	.750	.470
		D5803	1.000	.720	D5893	1.000	.720





# Mechanical Face Drivers

## TYPE 40

Driving Diameter Range: 0.32" - 0.67"

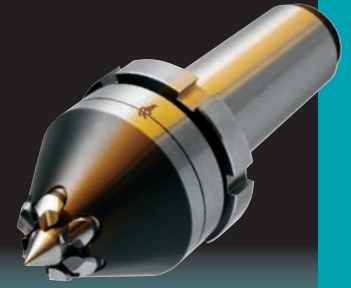

### Selecting the Face Driver components:

- #1 Determine the Face Driver model with the type of mounting required for the machine.
- #2 If mounting directly to machine spindle, verify spindle size and select appropriate spindle adapter.
- #3 Choose the center point with the diameter range closest to the center hole diameter.
- #4 Determine machine spindle rotation and driving diameter to select the correct drive pins.
  - Rotation is determined by looking directly at the spindle face or chuck face.
  - (For detailed instructions on selecting a face driver, [see page 51](#)).

### Mounting Styles Available for Type 40



Morse Taper\*



Flange Mount\*

\* All mechanical styles can be chucked.

#1 FACE DRIVER	
Order Code	Mounting Style
4003	#3 Morse Taper*
4004	#4 Morse Taper*
4005	#5 Morse Taper*
40FM	Flange Mount*

\* All mechanical styles can be chucked.

#2 SPINDLE ADAPTER (For direct mount only)	
Order Code	Spindle Size
708037	A2-5
708038	A2-6
708039	A2-8
708040	A2-11

#3 CENTER POINT		#4 DRIVE PINS (3 pins required)				
Order Code	Center Hole Dia. Range	Order Code	Counterclockwise (Right)		Clockwise (Left)	
			Outer Driving Diameter	Inner Driving Diameter	Outer Driving Diameter	Inner Driving Diameter
C4001	0 - 0.200	P4001	0.32	0.20	-	-
		P4002	-	-	0.32	0.20
		P4003	0.43	0.20	-	-
		P4004	-	-	0.43	0.20
		P4005	0.67	0.20	-	-
		P4006	-	-	0.67	0.20

**TO ORDER:** A complete unit consists of a face driver, center point and drive pins. For direct mounts, a spindle adapter must be added.

#1 Face Driver order code: \_ \_ \_ \_

#2 Spindle Adapter order code: \_ \_ \_ \_ \_  
(only required for direct mount)

#3 Center Point (included with Type 40)

#4 Drive Pins order code: \_ \_ \_ \_ \_ (3 pins required)



# Mechanical Face Drivers

## TYPE 41

Driving Diameter Range: 0.24" - 0.75"

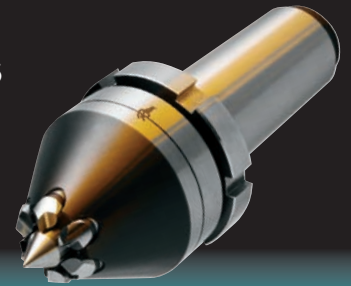

### Selecting the Face Driver components:

- #1 Determine the Face Driver model with the type of mounting required for the machine.
- #2 If mounting directly to machine spindle, verify spindle size and select appropriate spindle adapter.
- #3 Choose the center point with the diameter range closest to the center hole diameter.
- #4 Determine machine spindle rotation and driving diameter to select the correct drive pins.  
Rotation is determined by looking directly at the spindle face or chuck face.  
(For detailed instructions on selecting a face driver, [see page 51](#)).

### Mounting Styles Available for Type 41



Morse Taper\*



Flange Mount\*

\* All mechanical styles can be chucked.

### #1 FACE DRIVER

Order Code	Mounting Style
4103	#3 Morse Taper*
4104	#4 Morse Taper*
4105	#5 Morse Taper*
41FM	Flange Mount*

### #2 SPINDLE ADAPTER

(For direct mount only)

Order Code	Spindle Size
708037	A2-5
708038	A2-6
708039	A2-8
708040	A2-11

### #3 CENTER POINT

Order Code	Center Hole Dia. Range
C4101	0 - 0.120

### #4 DRIVE PINS (3 pins required)

Order Code	Counterclockwise (Right)		Clockwise (Left)	
	Outer Driving Diameter	Inner Driving Diameter	Outer Driving Diameter	Inner Driving Diameter
P4101	0.24	0.12	-	-
P4102	-	-	0.24	0.12
P4103	0.43	0.12	-	-
P4104	-	-	0.43	0.12
P4105	0.75	0.12	-	-
P4106	-	-	0.75	0.12

**TO ORDER:** A complete unit consists of a face driver, center point and drive pins. For direct mounts, a spindle adapter must be added.

#1 Face Driver order code: \_ \_ \_ \_

#2 Spindle Adapter order code: \_ \_ \_ \_ \_  
(only required for direct mount)

#3 Center Point (included with Type 41)

#4 Drive Pins order code: \_ \_ \_ \_ \_ (3 pins required)



# Mechanical Face Drivers

## TYPE 42

Driving Diameter Range: 0.43" - 0.79"

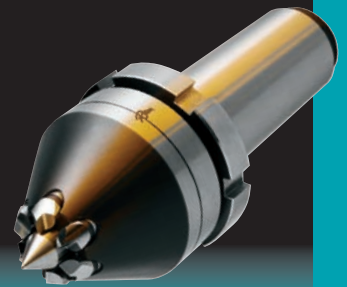

### Selecting the Face Driver components:

- #1 Determine the Face Driver model with the type of mounting required for the machine.
- #2 If mounting directly to machine spindle, verify spindle size and select appropriate spindle adapter.
- #3 Choose the center point with the diameter range closest to the center hole diameter.
- #4 Determine machine spindle rotation and driving diameter to select the correct drive pins. Rotation is determined by looking directly at the spindle face or chuck face.  
(For detailed instructions on selecting a face driver, [see page 51](#)).

### Mounting Styles Available for Type 42



Morse Taper\*



Flange Mount\*

\* All mechanical styles can be chucked.

#1 FACE DRIVER	
Order Code	Mounting Style
4203	#3 Morse Taper*
4204	#4 Morse Taper*
4205	#5 Morse Taper*
42FM	Flange Mount*

#2 SPINDLE ADAPTER (For direct mount only)	
Order Code	Spindle Size
708037	A2-5
708038	A2-6
708039	A2-8
708040	A2-11

#3 CENTER POINT		#4 DRIVE PINS (3 pins required)				
Order Code	Center Hole Dia. Range	Order Code	Counterclockwise (Right)		Clockwise (Left)	
			Outer Driving Diameter	Inner Driving Diameter	Outer Driving Diameter	Inner Driving Diameter
C4201 C4202	0 - 0.240	P4201	0.43	0.32	-	-
		P4202	-	-	0.43	0.32
		P4203	0.55	0.32	-	-
	0.217- 0.307	P4204	-	-	0.55	0.32
		P4205	0.79	0.32	-	-
		P4206	-	-	0.79	0.32
C4203	0.295 - 0.394	P4233	0.55	0.43	-	-
		P4234	-	-	0.55	0.43
		P4235	0.79	0.43	-	-
		P4236	-	-	0.79	0.43
C4204	0.335 - 0.472	P4245	0.79	0.52	-	-
		P4246	-	-	0.79	0.52
C4205	0.453 - 0.551	P4255	0.79	0.60	-	-
		P4256	-	-	0.79	0.60

**TO ORDER:** A complete unit consists of a face driver, center point and drive pins. For direct mounts, a spindle adapter must be added.

#1 Face Driver order code: \_ \_ \_ \_

#2 Spindle Adapter order code: \_ \_ \_ \_ \_  
(only required for direct mount)

#3 Center Point order code: \_ \_ \_ \_ \_

#4 Drive Pins order code: \_ \_ \_ \_ \_ (3 pins required)



# Mechanical Face Drivers

## TYPE 43

Driving Diameter Range: 0.51" - 1.02"

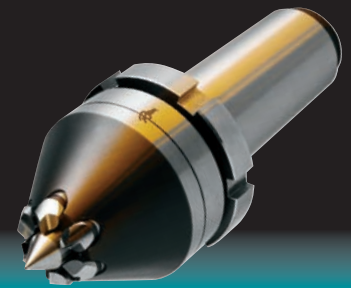

### Selecting the Face Driver components:

- #1 Determine the Face Driver model with the type of mounting required for the machine.
  - #2 If mounting directly to machine spindle, verify spindle size and select appropriate spindle adapter.
  - #3 Choose the center point with the diameter range closest to the center hole diameter.
  - #4 Determine machine spindle rotation and driving diameter to select the correct drive pins.
- Rotation is determined by looking directly at the spindle face or chuck face.  
(For detailed instructions on selecting a face driver, [see page 51](#)).

### Mounting Styles Available for Type 43



Morse Taper\*



Flange Mount\*

\* All mechanical styles can be chucked.

#1 FACE DRIVER	
Order Code	Mounting Style
4303	#3 Morse Taper
4304	#4 Morse Taper
4305	#5 Morse Taper
43FM	Flange Mount
430150	1.5 Straight Shank

#2 SPINDLE ADAPTER (For direct mount only)	
Order Code	Spindle Size
708037	A2-5
708038	A2-6
708039	A2-8
708040	A2-11

#3 CENTER POINT		#4 DRIVE PINS (3 pins required)				
Order Code	Center Hole Dia. Range	Order Code	Counterclockwise (Right)		Clockwise (Left)	
			Outer Driving Diameter	Inner Driving Diameter	Outer Driving Diameter	Inner Driving Diameter
C4301 C4302	0 - 0.320 0.256 - 0.376	P4301	0.51	0.39	-	-
		P4302	-	-	0.51	0.39
		P4303	0.71	0.39	-	-
		P4304	-	-	0.71	0.39
		P4305	1.02	0.39	-	-
		P4306	-	-	1.02	0.39
C4303	0.335 - 0.472	P4333	0.71	0.51	-	-
		P4334	-	-	0.71	0.51
		P4335	1.02	0.51	-	-
		P4336	-	-	1.02	0.51
C4304	0.453 - 0.591	P4345	1.02	0.65	-	-
		P4346	-	-	1.02	0.65
C4305	0.571 - 0.709	P4355	1.02	0.77	-	-
		P4356	-	-	1.02	0.77

**TO ORDER:** A complete unit consists of a face driver, center point and drive pins. For direct mounts, a spindle adapter must be added.

#1 Face Driver order code: \_\_\_\_\_

#2 Spindle Adapter order code: \_\_\_\_\_  
(only required for direct mount)

#3 Center Point order code: \_\_\_\_\_

#4 Drive Pins order code: \_\_\_\_\_ (3 pins required. 5-pin version available on request.)



# Mechanical Face Drivers

## TYPE 44

Driving Diameter Range: 1.02" - 1.42"

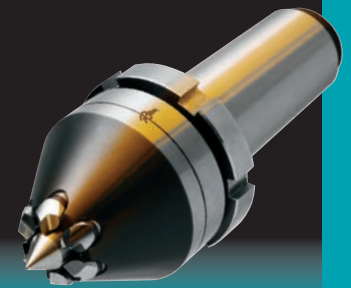

### Selecting the Face Driver components:

- #1 Determine the Face Driver model with the type of mounting required for the machine.
- #2 If mounting directly to machine spindle, verify spindle size and select appropriate spindle adapter.
- #3 Choose the center point with the diameter range closest to the center hole diameter.
- #4 Determine machine spindle rotation and driving diameter to select the correct drive pins.
  - Rotation is determined by looking directly at the spindle face or chuck face.
  - (For detailed instructions on selecting a face driver, [see page 51](#)).

### Mounting Styles Available for Type 44



Morse Taper\*



Flange Mount\*

\* All mechanical styles can be chucked.

**TO ORDER:** A complete unit consists of a face driver, center point and drive pins. For direct mounts, a spindle adapter must be added.

#1 Face Driver  
order code: \_\_\_\_\_

#2 Spindle Adapter  
order code: \_\_\_\_\_  
(only required for direct mount)

#3 Center Point  
order code: \_\_\_\_\_

#4 Drive Pins  
order code: \_\_\_\_\_  
(6 pins required)

#1 FACE DRIVER	
Order Code	Mounting Style
4404	#4 Morse Taper
4405	#5 Morse Taper
44FM	Flange Mount
446150	1.5 Straight Shank

#2 SPINDLE ADAPTER (For direct mount only)	
Order Code	Spindle Size
708037	A2-5
708038	A2-6
708039	A2-8
708040	A2-11

#3 CENTER POINT		#4 DRIVE PINS (6 pins required)				
Order Code	Center Hole Dia. Range	Order Code	Counterclockwise (Right)		Clockwise (Left)	
			Outer Driving Diameter	Inner Driving Diameter	Outer Driving Diameter	Inner Driving Diameter
C4601	0.08 - 0.550	P4401	1.02	0.63	—	—
		P4402	—	—	1.02	0.63
		P4403	1.22	0.63	—	—
		P4404	—	—	1.22	0.63
		P4405	1.42	0.63	—	—
		P4406	—	—	1.42	0.63
C4602	0.512 - 0.709	P4421	1.02	0.75	—	—
		P4422	—	—	1.02	0.75
		P4423	1.22	0.75	—	—
		P4424	—	—	1.22	0.75
		P4425	1.42	0.75	—	—
		P4426	—	—	1.42	0.75
C4603	0.669 - 0.866	P4431	1.02	0.90	—	—
		P4432	—	—	1.02	0.90
		P4433	1.22	0.90	—	—
		P4434	—	—	1.22	0.90
		P4435	1.42	0.90	—	—
		P4436	—	—	1.42	0.90
C4604	0.828 - 1.024	P4443	1.22	1.07	—	—
		P4444	—	—	1.22	1.07
		P4445	1.42	1.07	—	—
		P4446	—	—	1.42	1.07



# Mechanical Face Drivers

## TYPE 45

Driving Diameter Range: 1.34" - 1.73"

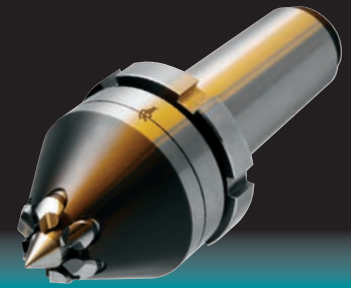

### Selecting the Face Driver components:

- #1 Determine the Face Driver model with the type of mounting required for the machine.
- #2 If mounting directly to machine spindle, verify spindle size and select appropriate spindle adapter.
- #3 Choose the center point with the diameter range closest to the center hole diameter.
- #4 Determine machine spindle rotation and driving diameter to select the correct drive pins.
  - Rotation is determined by looking directly at the spindle face or chuck face.
  - (For detailed instructions on selecting a face driver, [see page 51](#)).

### Mounting Styles Available for Type 45



Morse Taper\*



Flange Mount\*

\* All mechanical styles can be chucked.

**TO ORDER:** A complete unit consists of a face driver, center point and drive pins. For direct mounts, a spindle adapter must be added.

#1 Face Driver  
order code: \_\_\_\_\_

#2 Spindle Adapter  
order code: \_\_\_\_\_  
(only required for direct mount)

#3 Center Point  
order code: \_\_\_\_\_

#4 Drive Pins  
order code: \_\_\_\_\_  
(6 pins required)

#1 FACE DRIVER	
Order Code	Mounting Style
4504	#4 Morse Taper
4505	#5 Morse Taper
45FM	Flange Mount
456150	1.5 Straight Shank

#2 SPINDLE ADAPTER (For direct mount only)	
Order Code	Spindle Size
708037	A2-5
708038	A2-6
708039	A2-8
708040	A2-11

#3 CENTER POINT		#4 DRIVE PINS (6 pins required)				
Order Code	Center Hole Dia. Range	Order Code	Counterclockwise (Right)		Clockwise (Left)	
			Outer Driving Diameter	Inner Driving Diameter	Outer Driving Diameter	Inner Driving Diameter
C4501 C4502	0.08 - 0.710 0.669 - 0.866	P4501	1.34	0.95	-	-
		P4502	-	-	1.34	0.95
		P4503	1.54	0.95	-	-
		P4504	-	-	1.54	0.95
		P4505	1.73	0.95	-	-
		P4506	-	-	1.73	0.95
C4503	0.828 - 1.024	P4531	1.34	1.07	-	-
		P4532	-	-	1.34	1.07
		P4533	1.54	1.07	-	-
		P4534	-	-	1.54	1.07
		P4535	1.73	1.07	-	-
		P4536	-	-	1.73	1.07
C4504	0.984 - 1.181	P4541	1.34	1.22	-	-
		P4542	-	-	1.34	1.22
		P4543	1.54	1.22	-	-
		P4544	-	-	1.54	1.22
		P4545	1.73	1.22	-	-
		P4546	-	-	1.73	1.22
C4505	1.142 - 1.339	P4553	1.54	1.38	-	-
		P4554	-	-	1.54	1.38
		P4555	1.73	1.38	-	-
		P4556	-	-	1.73	1.38
C4506	1.299 - 1.496	P4565	1.73	1.54	-	-
		P4566	-	-	1.73	1.54



# Mechanical Face Drivers

## TYPE 46

Driving Diameter Range: 1.14" - 1.93"

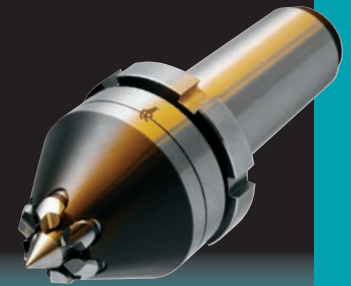

### Selecting the Face Driver components:

- #1 Determine the Face Driver model with the type of mounting required for the machine.
  - #2 If mounting directly to machine spindle, verify spindle size and select appropriate spindle adapter.
  - #3 Choose the center point with the diameter range closest to the center hole diameter.
  - #4 Determine machine spindle rotation and driving diameter to select the correct drive pins.
- Rotation is determined by looking directly at the spindle face or chuck face.  
(For detailed instructions on selecting a face driver, [see page 51](#)).

### Mounting Styles Available for Type 46



Morse Taper\*



Flange Mount\*

\* All mechanical styles can be chucked.

**TO ORDER:** A complete unit consists of a face driver, center point and drive pins. For direct mounts, a spindle adapter must be added.

#1 Face Driver  
order code: \_ \_ \_ \_

#2 Spindle Adapter  
order code: \_ \_ \_ \_ \_  
(only required for direct mount)

#3 Center Point  
order code: \_ \_ \_ \_ \_

#4 Drive Pins  
order code: \_ \_ \_ \_ \_  
(6 pins required)

#1 FACE DRIVER	
Order Code	Mounting Style
4604	#4 Morse Taper*
4605	#5 Morse Taper*
46FM	Flange Mount*

#2 SPINDLE ADAPTER (For direct mount only)	
Order Code	Spindle Size
708037	A2-5
708038	A2-6
708039	A2-8
708040	A2-11

#3 CENTER POINT		#4 DRIVE PINS (6 pins required)				
Order Code	Center Hole Dia. Range	Order Code	Counterclockwise (Right)		Clockwise (Left)	
			Outer Driving Diameter	Inner Driving Diameter	Outer Driving Diameter	Inner Driving Diameter
C4601 C4602	0.08 - 0.550 0.512 - 0.709	P4601	1.14	0.75	-	-
		P4602	-	-	1.14	0.75
		P4603	1.54	0.93**	-	-
		P4604	-	-	1.54	0.93**
		P4605	1.93	1.33**	-	-
		P4606	-	-	1.93	1.33**
C4603	0.669 - 0.866	P4631	1.14	0.91	-	-
		P4632	-	-	1.14	0.91
		P4633	1.54	0.91	-	-
		P4634	-	-	1.54	0.91
		P4635	1.93	1.35**	-	-
		P4636	-	-	1.93	1.35**
C4604	0.828 - 1.024	P4643	1.54	1.07	-	-
		P4644	-	-	1.54	1.07
		P4645	1.93	1.35**	-	-
		P4646	-	-	1.93	1.35**
C4605	0.984 - 1.181	P4653	1.54	1.22	-	-
		P4654	-	-	1.54	1.22
		P4655	1.93	1.22	-	-
		P4656	-	-	1.93	1.22
C4606	1.142 - 1.339	P4663	1.54	1.38	-	-
		P4664	-	-	1.54	1.38
		P4665	1.93	1.38	-	-
		P4666	-	-	1.93	1.38
C4607	1.299 - 1.496	P4675	1.93	1.54	-	-
		P4676	-	-	1.93	1.54

\*\* Chiseled edges for better gripping



# Mechanical Face Drivers

## TYPE 47

Driving Diameter Range: 1.54" - 2.32"

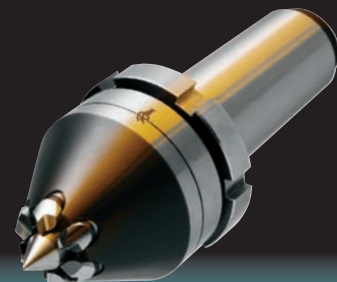

### Selecting the Face Driver components:

- #1 Determine the Face Driver model with the type of mounting required for the machine.
  - #2 If mounting directly to machine spindle, verify spindle size and select appropriate spindle adapter.
  - #3 Choose the center point with the diameter range closest to the center hole diameter.
  - #4 Determine machine spindle rotation and driving diameter to select the correct drive pins.
- Rotation is determined by looking directly at the spindle face or chuck face.  
(For detailed instructions on selecting a face driver, [see page 51](#)).

### Mounting Styles Available for Type 47



Morse Taper\*



Flange Mount\*

\* All mechanical styles can be chucked.

**TO ORDER:** A complete unit consists of a face driver, center point and drive pins. For direct mounts, a spindle adapter must be added.

#1 Face Driver  
order code: \_ \_ \_ \_

#2 Spindle Adapter  
order code: \_ \_ \_ \_ \_  
(only required for direct mount)

#3 Center Point  
order code: \_ \_ \_ \_ \_

#4 Drive Pins  
order code: \_ \_ \_ \_ \_  
(6 pins required)

### #1 FACE DRIVER

Order Code	Mounting Style
4705	#5 Morse Taper*
4706	#6 Morse Taper*
47FM	Flange Mount*

### #2 SPINDLE ADAPTER (For direct mount only)

Order Code	Spindle Size
708037	A2-5
708038	A2-6
708039	A2-8
708040	A2-11

### #3 CENTER POINT

Order Code	Center Hole Dia. Range
C4701	0.120 - 0.950
C4702	0.906 - 1.102
C4703	1.063 - 1.260
C4704	1.220 - 1.417
C4705	1.378 - 1.575
C4706	1.535 - 1.732

### #4 DRIVE PINS (6 pins required)

Order Code	Counterclockwise (Right)		Clockwise (Left)	
	Outer Driving Diameter	Inner Driving Diameter	Outer Driving Diameter	Inner Driving Diameter
P4701	1.54	1.14	-	-
P4702	-	-	1.54	1.14
P4703	1.93	1.32	-	-
P4704	-	-	1.93	1.32
P4705	2.32	1.72**	-	-
P4706	-	-	2.32	1.72**
P4731	1.54	1.30	-	-
P4732	-	-	1.54	1.30
P4733	1.93	1.30	-	-
P4734	-	-	1.93	1.30
P4735	2.32	1.72**	-	-
P4736	-	-	2.32	1.72**
P4743	1.93	1.46	-	-
P4744	-	-	1.93	1.46
P4745	2.32	1.72**	-	-
P4746	-	-	2.32	1.72**
P4753	1.93	1.62	-	-
P4754	-	-	1.93	1.62
P4755	2.32	1.62	-	-
P4756	-	-	2.32	1.62
P4763	1.93	1.77	-	-
P4764	-	-	1.93	1.77
P4765	2.32	1.77	-	-
P4766	-	-	2.32	1.77

\*\* Chiseled edges for better gripping





# Mechanical Face Drivers

## TYPE 48

Driving Diameter Range: 1.93" - 2.72"

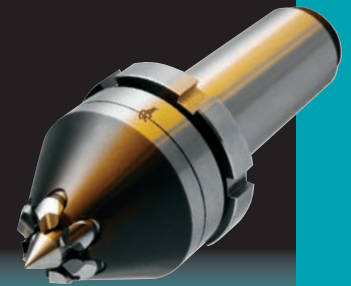

### Selecting the Face Driver components:

- #1 Determine the Face Driver model with the type of mounting required for the machine.
- #2 If mounting directly to machine spindle, verify spindle size and select appropriate spindle adapter.
- #3 Choose the center point with the diameter range closest to the center hole diameter.
- #4 Determine machine spindle rotation and driving diameter to select the correct drive pins.
  - Rotation is determined by looking directly at the spindle face or chuck face.
  - (For detailed instructions on selecting a face driver, [see page 51](#)).

### Mounting Styles Available for Type 48

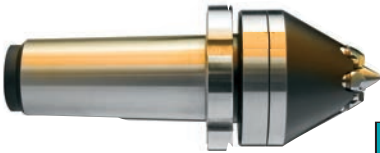

Morse Taper\*



Flange Mount\*

\* All mechanical styles can be chucked.

**TO ORDER:** A complete unit consists of a face driver, center point and drive pins. For direct mounts, a spindle adapter must be added.

#1 Face Driver  
order code: \_\_\_\_\_

#2 Spindle Adapter  
order code: \_\_\_\_\_  
(only required for direct mount)

#3 Center Point  
order code: \_\_\_\_\_

#4 Drive Pins  
order code: \_\_\_\_\_  
(6 pins required)

#1 FACE DRIVER	
Order Code	Mounting Style
4805	#5 Morse Taper*
4806	#6 Morse Taper*
48FM	Flange Mount*

#2 SPINDLE ADAPTER (For direct mount only)	
Order Code	Spindle Size
708037	A2-5
708038	A2-6
708039	A2-8
708040	A2-11

#3 CENTER POINT		#4 DRIVE PINS (6 pins required)				
Order Code	Center Hole Dia. Range	Order Code	Counterclockwise (Right)		Clockwise (Left)	
			Outer Driving Diameter	Inner Driving Diameter	Outer Driving Diameter	Inner Driving Diameter
C4801	0.120 - 1.100	P4801	1.93	1.53	-	-
		P4802	-	-	1.93	1.53
		P4803	2.32	1.71**	-	-
		P4804	-	-	2.32	1.71**
		P4805	2.72	2.12**	-	-
		P4806	-	-	2.72	2.12**
C4804	1.378 - 1.575	P4841	1.93	1.62	-	-
		P4842	-	-	1.93	1.62
		P4843	2.32	1.71**	-	-
		P4844	-	-	2.32	1.71**
		P4845	2.72	2.12**	-	-
		P4846	-	-	2.72	2.12**
C4805	1.535 - 1.732	P4851	1.93	1.78	-	-
		P4852	-	-	1.93	1.78
		P4853	2.32	1.78	-	-
		P4854	-	-	2.32	1.78
		P4855	2.72	2.12**	-	-
		P4856	-	-	2.72	2.12**
C4806	1.693 - 1.890	P4863	2.32	1.93	-	-
		P4864	-	-	2.32	1.93
		P4865	2.72	1.93	-	-
		P4866	-	-	2.72	1.93
C4807	1.850 - 2.047	P4873	2.32	2.09	-	-
		P4874	-	-	2.32	2.09
		P4875	2.72	2.09	-	-
		P4876	-	-	2.72	2.09

\*\* Chiseled edges for better gripping



# Mechanical Face Drivers

## TYPE 49

Driving Diameter Range: 2.72" - 3.90"

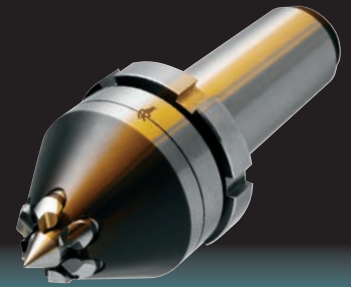

### Selecting the Face Driver components:

- #1 Determine the Face Driver model with the type of mounting required for the machine.
- #2 If mounting directly to machine spindle, verify spindle size and select appropriate spindle adapter.
- #3 Choose the center point with the diameter range closest to the center hole diameter.
- #4 Determine machine spindle rotation and driving diameter to select the correct drive pins.
  - Rotation is determined by looking directly at the spindle face or chuck face.
  - (For detailed instructions on selecting a face driver, [see page 51](#)).

### Mounting Styles Available for Type 49



Morse Taper\*



Flange Mount\*

\* All mechanical styles can be chucked.

**TO ORDER:** A complete unit consists of a face driver, center point and drive pins. For direct mounts, a spindle adapter must be added.

#1 Face Driver  
order code: \_\_\_\_\_

#2 Spindle Adapter  
order code: \_\_\_\_\_  
(only required for direct mount)

#3 Center Point  
order code: \_\_\_\_\_

#4 Drive Pins  
order code: \_\_\_\_\_  
(6 pins required)

#1 FACE DRIVER	
Order Code	Mounting Style
4906	#6 Morse Taper*
49FM	Flange Mount*

#2 SPINDLE ADAPTER (For direct mount only)	
Order Code	Spindle Size
708037	A2-5
708038	A2-6
708039	A2-8
708040	A2-11
708629	A2-15

#3 CENTER POINT		#4 DRIVE PINS (6 pins required)				
Order Code	Center Hole Dia. Range	Order Code	Counterclockwise (Right)		Clockwise (Left)	
			Outer Driving Diameter	Inner Driving Diameter	Outer Driving Diameter	Inner Driving Diameter
C5101	0.120 - 1.380	P4901	2.72	2.32	-	-
		P4902	-	-	2.72	2.32
		P4903	3.31	2.53**	-	-
		P4904	-	-	3.31	2.32
		P4905	3.90	3.12**	-	-
		P4906	-	-	3.90	3.12**
C5106	2.126 - 2.382	P4961	2.72	2.41	-	-
		P4962	-	-	2.72	2.41
		P4963	3.31	2.41	-	-
		P4964	-	-	3.31	2.41
		P4965	3.90	3.12**	-	-
		P4966	-	-	3.90	3.12**
C5107	2.323 - 2.559	P4971	2.72	2.60	-	-
		P4972	-	-	2.72	2.60
		P4973	3.31	2.60	-	-
		P4974	-	-	3.31	2.60
		P4975	3.90	3.12**	-	-
		P4976	-	-	3.90	3.12**
C5108	2.520 - 2.756	P4983	3.31	2.80	-	-
		P4984	-	-	3.31	2.80
		P4985	3.90	2.80	-	-
		P4986	-	-	3.90	2.80
C5109	2.717 - 2.953	P4993	3.31	3.00	-	-
		P4994	-	-	3.31	3.00
		P4995	3.90	3.00	-	-
		P4996	-	-	3.90	3.00

\*\* Chiseled edges for better gripping



# Mechanical Face Drivers

## TYPE 50

Driving Diameter Range: 4.33" - 5.51"

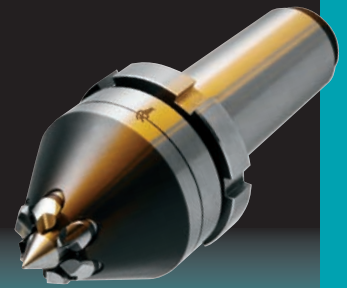

### Selecting the Face Driver components:

- #1 Determine the Face Driver model with the type of mounting required for the machine.
  - #2 If mounting directly to machine spindle, verify spindle size and select appropriate spindle adapter.
  - #3 Choose the center point with the diameter range closest to the center hole diameter.
  - #4 Determine machine spindle rotation and driving diameter to select the correct drive pins.
- Rotation is determined by looking directly at the spindle face or chuck face.  
(For detailed instructions on selecting a face driver, [see page 51](#)).

### Mounting Styles Available for Type 50



Morse Taper\*



Flange Mount\*

#1 FACE DRIVER	
Order Code	Mounting Style
5006	#6 Morse Taper*
50FM	Flange Mount*

#2 SPINDLE ADAPTER (For direct mount only)	
Order Code	Spindle Size
724761	A2-8
724762	A2-11

\* All mechanical styles can be chucked.

#3 CENTER POINT		#4 DRIVE PINS (6 pins required)				
Order Code	Center Hole Dia. Range	Order Code	Counterclockwise (Right)		Clockwise (Left)	
			Outer Driving Diameter	Inner Driving Diameter	Outer Driving Diameter	Inner Driving Diameter
C5101	0.120 - 1.380	P5001	4.33	3.94	-	-
C5102	1.339 - 1.575	P5002	-	-	4.33	3.94
C5103	1.535 - 1.772	P5003	4.92	3.94	-	-
C5104	1.732 - 1.969	P5004	-	-	4.92	3.94
C5105	1.929 - 2.165	P5005	5.51	4.73**	-	-
C5106	2.126 - 2.362	P5006	-	-	5.51	4.73**
C5107	2.323 - 2.559					
C5108	2.520 - 2.756					
C5109	2.717 - 2.953					

\*\* Half chiseled edges for better gripping

\* All mechanical styles can be chucked.

**TO ORDER:** A complete unit consists of a face driver, center point and drive pins. For direct mounts, a spindle adapter must be added.

#1 Face Driver order code: \_\_\_\_\_

#2 Spindle Adapter order code: \_\_\_\_\_  
(only required for direct mount)

#3 Center Point order code: \_\_\_\_\_

#4 Drive Pins order code: \_\_\_\_\_ (6 pins required)



# Actuated Face Driver Quick Change Spindle Adapter

## Actuated Fixed Point Face Driver

- Accurate to within .0001 to .0002 TIR
- Ideal for hard turning applications
- Mechanical clamping via actuating cylinder
- Fixed center point provides a constant reference datum.
- Clamping system and fixed center point provide maximum work piece support.
- Uses standard drive pins

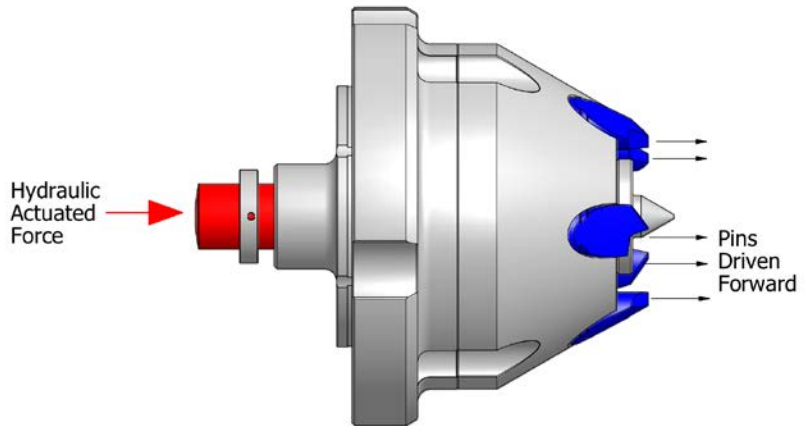

Model	Driving Diameter Range (inches)
74FM	1.02 - 1.42
75FM	1.34 - 1.73
77FM	1.54 - 2.32
78FM	1.93 - 2.72
79FM	2.72 - 3.90

Call Riten Technical Service at 800-338-0027 for product details and application assistance.

## Quick Change Spindle Adapter

- Changeout from one face driver to another in seconds
- Interchangeable Morse Taper sleeves
- Compensates for spindle nose error: four stirring screws allow run out adjustment to virtual zero
- Closer to spindle bearings for maximum rigidity
- High repeatability, reduced downtime

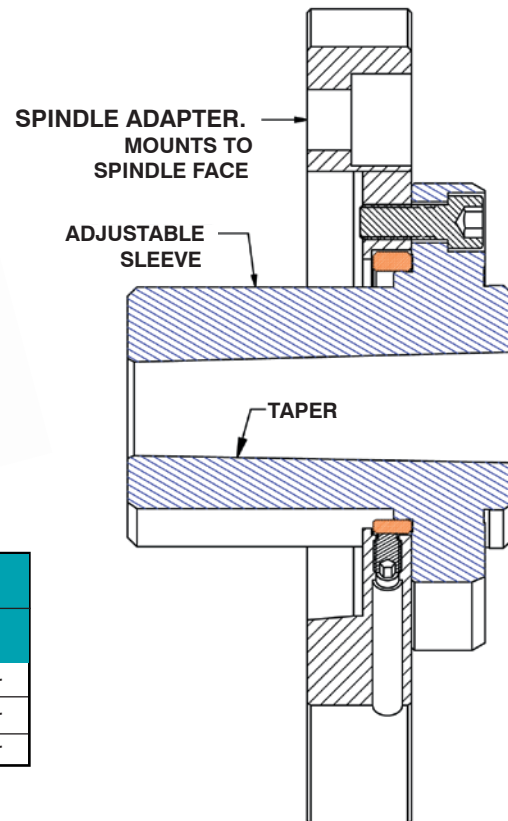
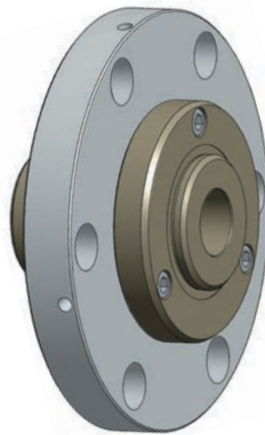

SPINDLE ADAPTER	
Order Code	Spindle Size
708037	A2-5
708038	A2-6
708039	A2-8
708040	A2-11

ADJUSTABLE SLEEVE	
Order Code	Taper Size
732597	#3 Morse Taper
732218	#4 Morse Taper
732219	#5 Morse Taper



# Hydraulic Face Drivers



### Selecting the Face Driver components:

- #1 Determine the Face Driver model with the type of mounting required for the machine.
- #2 Choose the center point with the diameter range closest to the center hole diameter.
- #3 Determine machine spindle rotation and driving diameter to select the correct drive pins.  
Rotation is determined by looking directly at the spindle face or chuck face.
- #4 If mounting directly to machine spindle, verify spindle size and select appropriate spindle adapter.  
(For detailed instructions on selecting a face driver, [see page 51](#)).

## TYPE 62: Driving Diameter Range: 0.94" - 1.73"

#1 FACE DRIVER								
Order Code	Mounting Style	Max. Part Weight	Order Code	Mounting Style	Max. Part Weight	Order Code	Mounting Style	Max. Part Weight
6204	#4 Morse Taper	84 lbs	62C1	Chuck Mount	160 lbs.	62F1	Flange Mount	84 lbs.
6205	#5 Morse Taper	84 lbs.	62C2	Chuck Mount H.D.	220 lbs.	62F2	Flange Mount H.D.	350 lbs
6206	#6 Morse Taper	84 lbs.	62C3	Chuck Mount H.D.	560 lbs.	62F3	Flange Mount H.D.	660 lbs.
			62C4	Chuck Mount H.D.	1000 lbs.			

#2 CENTER POINT	
Order Code	Center Hole Dia. Range
C6201	0.275 - 0.393
C6202	0.393 - 0.511
C6203	0.511 - 0.629
C6204	0.629 - 0.748
C6205	0.748 - 0.866
C6206	0.866 - 0.984
C6207	0.984 - 1.102
C6208	1.102 - 1.220
C6209	1.220 - 1.338

#3 DRIVE PINS (5 pins required)				
Order Code	Counterclockwise (Right)		Clockwise (Left)	
	Outer Driving Diameter	Inner Driving Diameter	Outer Driving Diameter	Inner Driving Diameter
P6201	0.94	0.71	1.73	1.50
P6202	1.73	1.50	0.94	0.71
P6203	1.21	0.71	1.73	1.23
P6204	1.73	1.23	1.21	0.71
P6205	1.42	1.02	1.42	1.02
P6206	1.73	0.71	1.73	0.71

#4 SPINDLE ADAPTER (For direct mount only)	
Order Code	Spindle Size
705046	A2-5
705047	A2-6
705048	A2-8
705049	A2-11

### Ordering Information:

A complete unit consists of a face driver, center point and drive pins. For direct mounts, a spindle adapter must be added.

- #1 Face Driver order code: \_\_\_\_\_
- #2 Center Point order code: \_\_\_\_\_
- #3 Drive Pins order code: \_\_\_\_\_ (See table for number of pins required)
- #4 Spindle Adapter order code: \_\_\_\_\_  
(only required for direct mount)



# Hydraulic Face Drivers (Cont.)



(See page 68 for component selection and ordering information.)

## TYPE 63: Driving Diameter Range: 1.44" - 2.38"

#1 FACE DRIVER								
Order Code	Mounting Style	Max. Part Weight	Order Code	Mounting Style	Max. Part Weight	Order Code	Mounting Style	Max. Part Weight
6305	#5 Morse Taper	160 lbs.	63C1	Chuck Mount	160 lbs.	63F1	Flange Mount	160 lbs.
6306	#6 Morse Taper	160 lbs.	63C2	Chuck Mount H.D.	220 lbs.	63F2	Flange Mount H.D.	220 lbs.
			63C3	Chuck Mount H.D.	560 lbs.	63F3	Flange Mount H.D.	560 lbs.
			63C4	Chuck Mount H.D.	1000 lbs.	63F4	Flange Mount H.D.	1000 lbs.

#2 CENTER POINT	
Order Code	Center Hole Dia. Range
C6301	0.393 - 0.511
C6302	0.511 - 0.629
C6303	0.629 - 0.748
C6304	0.748 - 0.866
C6305	0.866 - 0.984
C6306	0.984 - 1.102
C6307	1.102 - 1.220
C6308	1.220 - 1.338
C6309	1.338 - 1.456
C6310	1.456 - 1.574

#3 DRIVE PINS (5 pins required)				
Order Code	Counterclockwise (Right)		Clockwise (Left)	
	Outer Driving Diameter	Inner Driving Diameter	Outer Driving Diameter	Inner Driving Diameter
P6401	1.44	1.08	2.38	2.02
P6402	2.38	2.02	1.44	1.08
P6403	1.73	1.08	2.38	1.73
P6404	2.38	1.73	1.73	1.08
P6405	1.97	1.45	1.97	1.45
P6406	2.38	1.08	2.38	1.08

#4 SPINDLE ADAPTER (For direct mount only)	
Order Code	Spindle Size
705050	A2-6
705051	A2-8
705052	A2-11

## TYPE 64: Driving Diameter Range: 1.95" - 2.89"

#1 FACE DRIVER								
Order Code	Mounting Style	Max. Part Weight	Order Code	Mounting Style	Max. Part Weight	Order Code	Mounting Style	Max. Part Weight
6405	#5 Morse Taper	160 lbs.	64C2	Chuck Mount H.D.	220 lbs.	64F1	Flange Mount H.D.	160 lbs.
6406	#6 Morse Taper	160 lbs.	64C3	Chuck Mount H.D.	560 lbs.	64F2	Flange Mount H.D.	220 lbs.
64C1	Chuck Mount	160 lbs.	64C4	Chuck Mount H.D.	1000 lbs.	64F3	Flange Mount H.D.	560 lbs.

#2 CENTER POINT	
Order Code	Center Hole Dia. Range
C5501	0.393 - 0.590
C5502	0.590 - 0.787
C5503	0.787 - 0.984
C5504	0.984 - 1.181
C5505	1.181 - 1.378
C6401	1.378 - 1.575
C6402	1.575 - 1.772
C6403	1.772 - 1.969
C6404	1.969 - 2.166
C6405	2.166 - 2.363

#3 DRIVE PINS (6 pins required)				
Order Code	Counterclockwise (Right)		Clockwise (Left)	
	Outer Driving Diameter	Inner Driving Diameter	Outer Driving Diameter	Inner Driving Diameter
P6401	1.95	1.59	2.89	2.53
P6402	2.89	2.53	1.95	1.59
P6403	2.24	1.59	2.89	2.24
P6404	2.89	2.24	2.24	1.59
P6405	2.48	1.96	2.48	1.96
P6406	2.89	1.59	2.89	1.59

#4 SPINDLE ADAPTER (For direct mount only)	
Order Code	Spindle Size
705050	A2-6
705051	A2-8
705052	A2-11



# Hydraulic Face Drivers (Cont.)



(See page 68 for component selection and ordering information.)

## TYPE 66: Driving Diameter Range: 3.22" - 4.31"

#1 FACE DRIVER								
Order Code	Mounting Style	Max. Part Weight	Order Code	Mounting Style	Max. Part Weight	Order Code	Mounting Style	Max. Part Weight
6606	#6 Morse Taper	375 lbs.	66F2	Flange Mount H.D.	550 lbs.	66F4	Flange Mount H.D.	1470 lbs.
66F1	Flange Mount	375 lbs.	66F3	Flange Mount H.D.	920 lbs.	66F5	Flange Mount H.D.	2940 lbs.

#2 CENTER POINT	
Order Code	Center Hole Dia. Range
C6601	0.472 - 0.787
C6602	0.787 - 1.102
C6603	1.102 - 1.417
C6604	1.417 - 1.732
C6605	1.732 - 2.047
C6606	2.047 - 2.362
C6607	2.362 - 2.677
C6608	2.677 - 2.992
C6609	2.992 - 3.307
C6610	3.307 - 3.622

#3 DRIVE PINS (8 pins required)				
Order Code	Counterclockwise (Right)		Clockwise (Left)	
	Outer Driving Diameter	Inner Driving Diameter	Outer Driving Diameter	Inner Driving Diameter
P6801	3.22	2.77	4.31	3.86
P6802	4.31	3.86	3.22	2.77
P6803	3.53	2.77	4.31	3.55
P6804	4.31	3.55	3.53	2.77
P6805	3.84	3.21	3.84	3.21
P6806	4.31	2.77	4.31	2.77

#4 SPINDLE ADAPTER (For direct mount only)	
Order Code	Spindle Size
705053	A2-6
705054	A2-8
705055	A2-11
705056	A2-15

## TYPE 68: Driving Diameter Range: 4.64" - 5.73"

#1 FACE DRIVER								
Order Code	Mounting Style	Max. Part Weight	Order Code	Mounting Style	Max. Part Weight	Order Code	Mounting Style	Max. Part Weight
68F1	Flange Mount	600 lbs.	68F3	Flange Mount H.D.	1420 lbs.	68F5	Flange Mount H.D.	2500 lbs.
68F2	Flange Mount H.D.	900 lbs.	68F4	Flange Mount H.D.	1920 lbs.	68F6	Flange Mount H.D.	3000 lbs.

#2 CENTER POINT	
Order Code	Center Hole Dia. Range
C6801	0.629 - 0.984
C6802	0.984 - 1.338
C6803	1.338 - 1.692
C6804	1.692 - 2.047
C6805	2.047 - 2.401
C6806	2.401 - 2.755
C6807	2.755 - 3.110
C6808	3.110 - 3.464
C6809	3.464 - 3.818
C6810	3.818 - 4.173

#3 DRIVE PINS (10 pins required)				
Order Code	Counterclockwise (Right)		Clockwise (Left)	
	Outer Driving Diameter	Inner Driving Diameter	Outer Driving Diameter	Inner Driving Diameter
P6801	4.64	4.19	5.73	5.28
P6802	5.73	5.28	4.64	4.19
P6803	4.95	4.19	5.73	4.97
P6804	5.73	4.97	4.95	4.19
P6805	5.26	4.63	5.26	4.63
P6806	5.73	4.19	5.73	4.19

#4 SPINDLE ADAPTER (For direct mount only)	
Order Code	Spindle Size
705057	A2-6
705058	A2-8
705059	A2-11
705060	A2-15



## Face Driver Care and Maintenance

Properly maintained, Riten Face Drivers and Live Centers are trouble free. However, like all precision tools they should not be abused. The drive pins, center points and carrier bodies in a face driver are machined to tight tolerances to help prevent contamination. The high quality seals in both products resist coolant contamination.

The two types of compensating media in a face driver are hydraulic or mechanical. Standard mechanical face drivers should be inspected periodically for deterioration in the male and female spherical washers. Hydraulic face drivers should be inspected periodically for oil leakage. In either case, drive pins and center points should be periodically removed and inspected for wear. Cleaning these parts and coating them with light oil or lubricating paste will extend tool life. The following instructions are specific to each type of face driver.

### **Mechanical Type 40 - 50 Series**

Periodic maintenance may be required to insure that your Riten mechanical face driver functions as designed. The drive pins and center point are the primary wear parts. Changes in drive pin penetration are an indication that the drive pins may need to be replaced. Sharp drive pins indent the part in a well defined straight line. The indentations are symmetrical in terms of length, depth and appearance.

If the penetration line begins to show signs of a raised edge on one side, or there is other evidence that the pin is slipping, the drive pins should be changed immediately. Indentations that are "V" shaped rather than "I" shaped are clear indications of extreme slippage. Drive pins should be replaced well before this occurs. Waiting too long to replace worn drive pins can result in significant damage to the face driver.

Center point wear is easily identified by scoring or galling on the contact angle. Once this occurs the center point should be replaced. Worn center points can contribute to concentricity problems with the work piece.

When replacing drive pins or center points, a small amount of grease should be applied to the parts being replaced as well as the bores in the face driver carrier body. This will help prevent corrosion and provide lubrication in these critical areas.

The mechanical face driver does not contain hydraulic oil and therefore requires less maintenance. Over time however, the mechanical driver may require service. Internal wear parts include the spherical washer assembly, the tapered wedges, and the spring/spring pin assembly. The spherical washer assembly is responsible for the drive pin compensation. The spring and spring pin assembly control the center point travel, while the tapered wedges lock the center point in place at the appropriate point during chucking. Failure to actuate or excessive run out are indications of excessive wear in these critical components.

Riten offers a comprehensive repair service which includes a complete inspection and replacement of all internal components. Heavily worn or damaged face drivers may also need a new carrier body in addition to the normal maintenance. Mechanical face drivers can be easily repaired by the customer by following the detailed instructions of a Riten representative.

---

***Additional information can be found under Technical Support at [www.riten.com](http://www.riten.com).***

---





# Face Driver Care and Maintenance (cont.)

## Hydraulic Type 62 – 68 Series

Periodic maintenance may be required to insure that your Riten hydraulic face driver functions as designed. The drive pins and center point are the primary wear parts. Changes in the drive pin penetration are an indication that the drive pins may need to be replaced. Sharp drive pins indent the part in a well defined straight line. The indentations are symmetrical in terms of length, depth and appearance.

If the penetration line begins to show signs of a raised edge on one side or other evidence that the pin is slipping, the drive pins should be changed immediately. Indentations that are “V” shaped rather than “I” shaped are clear indications of extreme slippage. Drive pins should be replaced well before this occurs. Waiting too long to replace worn drive pins can result in significant damage to the face driver.

Center point wear is easily identified by scoring or galling on the contact angle. Once this occurs the center point should be replaced. Worn center points can contribute to concentricity problems with the work piece.

When replacing drive pins or center points a small amount of grease should be applied to the parts being replaced as well as the bores in the face driver carrier body. This will help prevent corrosion and provide lubrication in these critical areas. More extensive maintenance may be required if the face driver has lost hydraulic oil due to wear in the internal seals.

Refer to the hydraulic adjustment chart to determine if the drive pins are maintaining the correct standoff height. To make adjustments, remove the inlet screw and washer that seal the hydraulic chamber. With

the pistons and drive pins in full forward position, fill the chamber to overflowing with 80-90 weight gear oil. Allow all air bubbles to be displaced. Loosely replace the inlet screw and washer. Position the face driver in an arbor press with the drive pins against a flat plate. Displace excess oil from the chamber by compressing the drive pins to the appropriate dimension “J” in the hydraulic adjustment chart below. Tighten the inlet screw and washer. If hydraulic oil is visibly leaking or the drive pins fail to maintain the appropriate standoff height after service, the face driver should be removed from the machine immediately to prevent catastrophic failure.

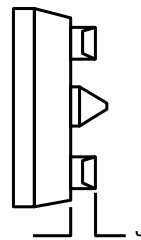

Tool Series	J
62	0.25
63	0.34
64	0.34

Tool Series	J
66	0.47
68	0.39

Riten offers a comprehensive repair service which includes a complete inspection, replacement of all internal seals and o-rings along with pressure testing. Heavily worn or damaged face drivers may also need a new carrier body in addition to the normal maintenance. This maintenance can also be done by the customer following the detailed instructions of a Riten representative.

**Additional information can be found under Technical Support at [www.riten.com](http://www.riten.com).**

### Mechanical Design – Type 40-50

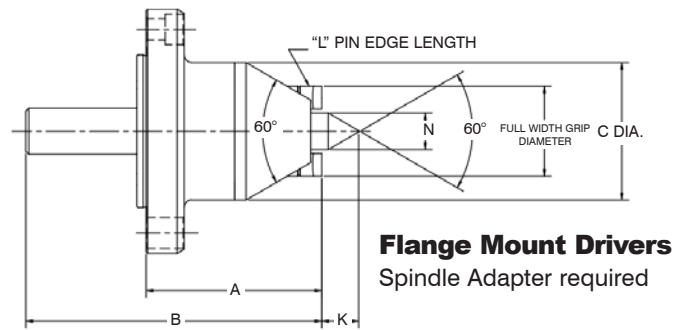
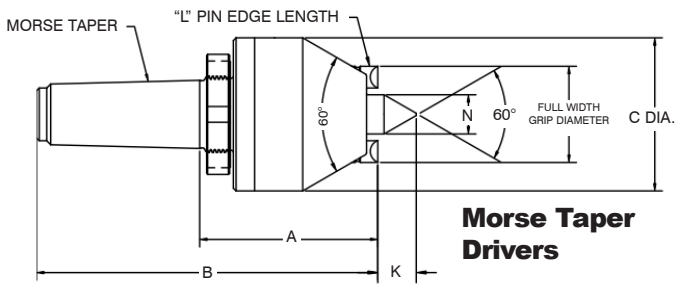

### Hydraulic Design – Type 62-68

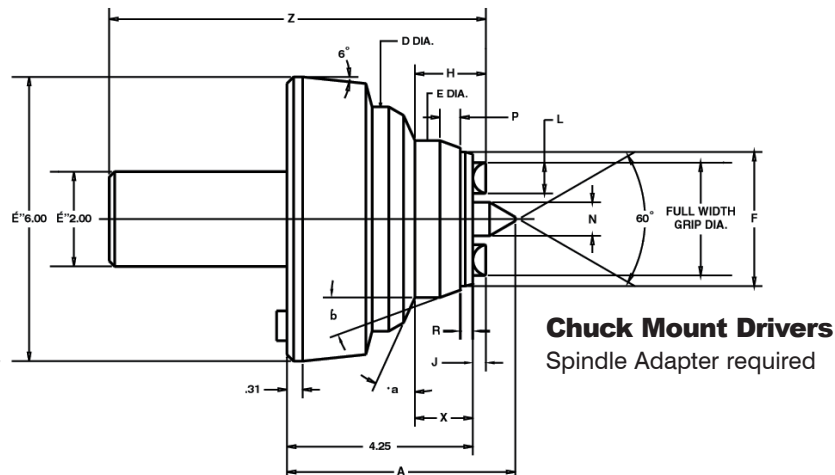
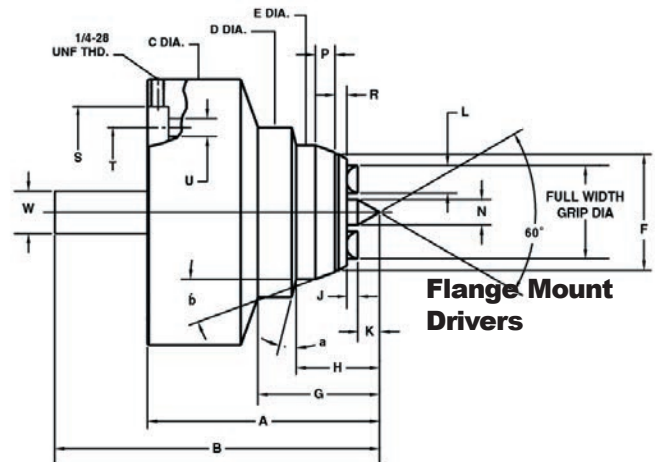
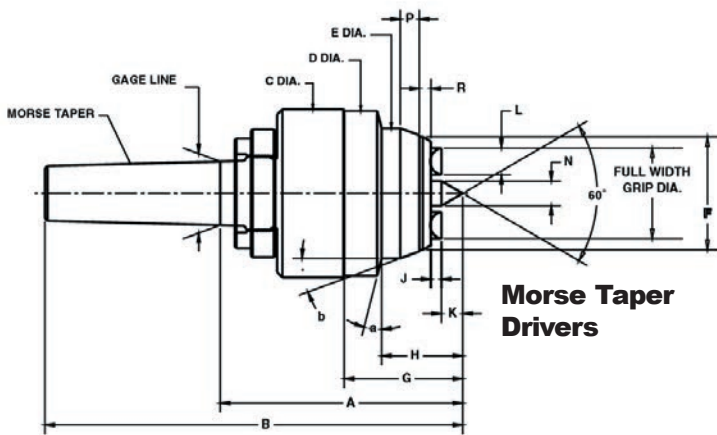



# Dimensions for Type 40-50 and 62-68

TOOL SERIES	MORSE TAPER	40	41	42	43	44	45	46	47	48	49	50	62	63	64	66	68				
DIMENSIONS FOR MORSE TAPER DRIVERS	A	2																			
		3	3.43	3.43	3.15	3.15															
		4	3.43	3.43	3.15	3.15	3.15	3.15						4.38	4.47						
		5	3.43	3.43	3.15	3.15	3.15	3.15		4.13				4.56	5.81	5.81					
		6								4.13		5.35		4.65	5.90	5.90	6.90				
		2																			
	B	3	5.83	5.83	5.55	5.55															
		4	6.34	6.34	6.06	6.06	6.06	6.06						8.03							
		5	7.25	7.25	6.97	6.97	6.97	6.97		7.95				8.69	9.94	9.91					
		6								9.41		10.63		9.91	11.16	11.16	12.16				
	C	3	1.89	1.89	1.65	1.89															
		4	1.89	1.89	1.65	1.89	2.76	2.76						3.25		4.81	6.22				
		5	1.89	1.89	1.65	1.89	2.76	2.76		3.54				3.25	4.81	4.81	6.22				
		6								3.54		5.20		3.25	3.25	4.81	4.81	6.22			
	COMMON DIMENSIONS FOR ALL MOUNTS	a												15°	25°	15°	15°	15°			
		b		60°	60°	60°	60°	60°	60°	60°	60°	60°	60°	15°	20°	20°	30°	30°			
		d												3.16	4.72	4.72	6.14	8.19			
		e												2.50	3.31	3.75	5.27	6.63			
f													2.08	2.75	3.21	4.63	6.05				
g													2.31	2.97	2.97	3.97	4.34				
h													1.59	2.06	2.13	3.13	3.28				
j													0.25	0.34	0.34	0.47	0.39				
k			.38	.38	.32	.37	.51	.66	.54	.95	1.17	1.25	1.39	0.40	0.50	0.59	0.84	1.03			
"L" PIN EDGE LENGTH		NO. OF PINS	3	3	3	3	6	6	6	6	6	6	6	5	5	6	8	10			
	OFFSET	0.06	0.06	0.06	0.06	0.20	0.20	0.20	0.20	0.20	0.20	0.20	0.12	0.18	0.18	0.24	0.24				
	HALF-OFFSET	0.12	0.16	0.12	0.16	0.30	0.30	0.39	0.39	0.39	0.49	0.49	0.26	0.33	0.33	0.39	0.39				
	FULL WIDTH	0.24	0.32	0.24	0.32	0.39	0.39	0.30	0.30	0.30	0.39	0.39	0.51	0.67	0.67	0.79	0.79				
	CENTRAL												0.21	0.27	0.27	0.32	0.32				
	n	0.87	0.87	0.24	0.32	0.55	0.71	0.55	0.94	1.10	1.38	1.38	0.47	0.71	0.79	1.18	1.57				
DIMENSIONS FOR CHUCK MOUNT DRIVERS	p												0.58	0.50	0.48	0.44	0.34				
	r												0.16	0.28	0.20	0.16	0.16				
	a												4.63	4.83	4.80						
	x												1.21	1.48	1.58						
	z												8.43	8.63	8.60						
	s												3.937	5.512	5.512	5.512	6.694				
	t												3.150	4.960	4.960	6.220	7.323				
	u	SIZE											0.332	0.332	0.332	0.413	0.422				
	u	NO.											6	8	8	8	8				
w												0.78	1.00	1.00	1.97	2.22					
DIMENSIONS FOR FLANGE MOUNT DRIVERS	A	4.528	4.528	4.528	4.528	4.528	4.528	4.528	4.528	4.528	4.528	4.528	4.37	5.31	5.31	6.41	6.59				
	B	5.348	5.348	5.348	5.038	4.998	5.108	6.098	7.668	7.668	7.708	11.163	6.06	8.16	8.16	11.22	11.25				
	C	1.89	1.89	1.65	1.89	2.76	2.76	3.15	3.54	3.94	5.20	7.17	4.94	6.28	6.28	7.06	8.25				



# Calculation of Tailstock Forces

## Mechanical Face Drivers

Proper tailstock force is vital for satisfactory face driving. The force can be calculated using the following 4 steps:

- Using Table 1, find the ratio of the rough workpiece diameter to the face driver driving diameter.
- In Table 2, determine the chip cross section.
- Using the results from Tables 1 and 2, find the appropriate tailstock force in Table 3. These values are a starting point and can be adjusted to meet specific variables in the machining operation.
- The tables assume that the direction of feed is toward the face driver. If the feed direction is away from the driver, the tailstock pressure must be increased by 100%. For plunge cutting, the tailstock pressure must be increased by 50%. The tables also assume that material hardness is between Rc 20 and Rc 40.

Harder materials may require special carbide tipped or diamond plated drive pins. Please contact Riten Technical Service for specific recommendations.

## Hydraulic Face Drivers

*Calculation of tailstock forces is similar to mechanical models, but the tables have different values and there are a few additional steps. Please refer to the User Guide packed with each unit or click on Technical Support at [www.riten.com](http://www.riten.com).*

Table 1. Ratio of Rough Workpiece Diameter to Driving Diameter						
		Driving Diameter				
		5.91"	3.94"	1.97"	0.79"	0.39"
Rough Workpiece Diameter	0.79"				1	2
	1.18"				1.5	3
	1.57"				2	
	1.97"			1	2.5	
	2.36"			1.2	3	
	3.15"			1.6		
	3.94"		1	2		
	5.91"	1	1.5	3		
	7.87"	1.3	2			
11.81"	2	3				

Table 2. Chip Cross Section						
		Feed per Revolution				
		.008"	.012"	.016"	.020"	.040"
Depth of Cut	.040"	.008"	.012"	.016"	.019"	.040"
	.080"	.016"	.024"	.030"	.040"	.080"
	.120"	.024"	.035"	.050"	.060"	.120"
	.160"	.030"	.050"	.060"	.080"	.160"
	.200"	.040"	.060"	.080"	.100"	.200"
	.400"	.080"	.120"	.160"	.200"	.400"

Table 3. Tailstock Force						
		Rough Workpiece/Driving Diameter Ratio				
		1	1.5	2	2.5	3
Chip Cross Section	.008"	495 lb	517 lb	540 lb	562 lb	584 lb
	.016"	540 lb	584 lb	629 lb	674 lb	719 lb
	.019"	562 lb	618 lb	674 lb	731 lb	787 lb
	.024"	584 lb	652 lb	719 lb	787 lb	854 lb
	.030"	629 lb	719 lb	809 lb	899 lb	989 lb
	.035"	652 lb	753 lb	854 lb	955 lb	1057 lb
	.040"	674 lb	787 lb	899 lb	1012 lb	1124 lb
	.050"	719 lb	854 lb	989 lb	1124 lb	1259 lb
	.060"	787 lb	955 lb	1124 lb	1293 lb	1461 lb
	.080"	899 lb	1124 lb	1349 lb	1574 lb	1798 lb
	.100"	1012 lb	1293 lb	1574 lb	1855 lb	2136 lb
	.120"	1124 lb	1461 lb	1798 lb	2136 lb	2473 lb
	.160"	1349 lb	1798 lb	2248 lb	2698 lb	3147 lb
.200"	1574 lb	2137 lb	2698 lb	3260 lb	3822 lb	
.400"	2698 lb	3822 lb	4946 lb	6070 lb	7194 lb	



[www.riten.com](http://www.riten.com)

The most useful and informative website in the workholding industry!

**CAD Drawings**

Download drawings of standard Riten products to finalize tool design layouts. 3D button allows viewing from all angles.

**Product Search**

Enter part number or keyword. Find technical specs and pricing on our online catalog.

**New Products**

Links to the latest offerings in Riten's expanding line of products & services

**Services**

Repair, rebuild, troubleshooting - in our plant or yours.

**Technical Support**

Valuable tutorials on the selection, installation, maintenance, and trouble-shooting of our complete product line.

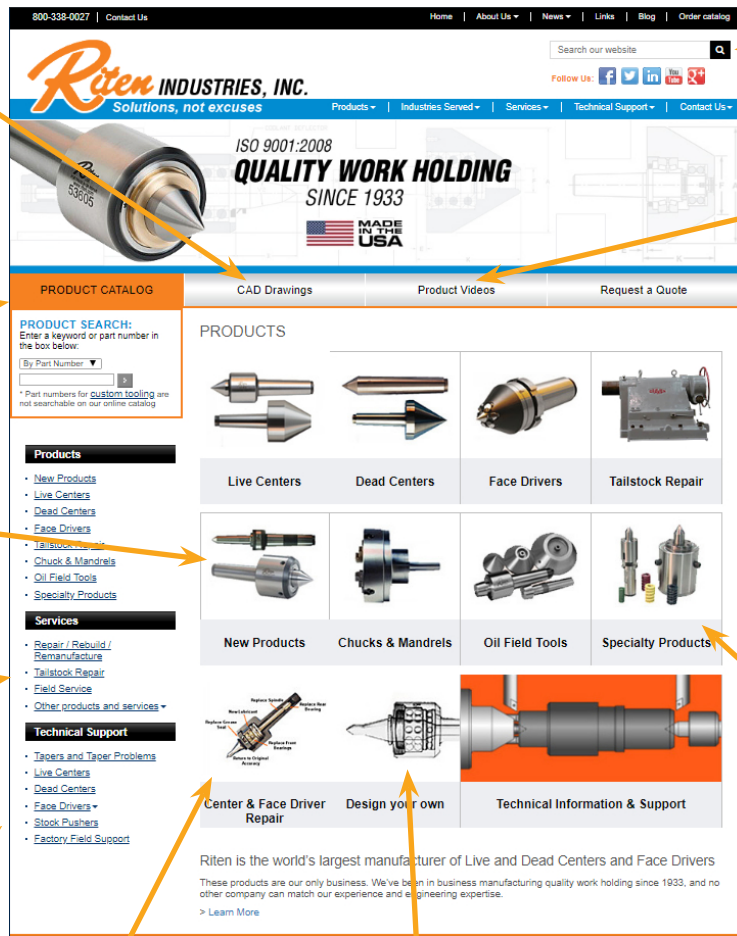

Text Search

Videos  
Product demos, application and installation tutorials

Product Selection  
Browse Riten's vast product offering, grouped by application category.

Special Products  
Hard to find workholding tools like gear hob tooling, flange centers, and completely custom tools engineered to your specifications.

**Repair/Rebuild**

All makes of live centers, dead centers, face drivers, tail & head stocks, and spindles.

**Design Your Own**

Standard products are easily modified with plug-in dimensions – you don't need to be an engineer. Complete menu of prompts guides your selection of dimensions and options. Visualize the result in simplified CAD format, ready for quoting. Download 2D drawings or rotatable 3D renderings, solid or hollow.

# Solutions, not excuses!

## Why Riten means value in workholding products:

- The industry's largest selection of live & dead centers, face drivers and engineered products
- Design and production of special products to meet specific requirements
- Nationally known for superb engineering
- Same day shipping on standards; fast delivery on specials

**RETURN POLICY** If a standard Riten product is ordered in error, not used, and in good working condition, it may be returned without a restocking charge if a replacement order is issued. Otherwise, the restocking charge will be 25% on unused, returned product. Please contact the customer service department at Riten before returning product for a "RETURN GOODS AUTHORIZATION" number. Returns will not be accepted without this number. Warranty returns must be within one year of the original purchase date.

### RITEN INDUSTRIES WARRANTY – DISCLAIMER OF WARRANTY

Riten warrants that its products shall be free from defects in material and workmanship under normal use when correctly installed and maintained. This warranty of quality shall terminate one year after delivery of the products to the buyer and shall not apply to products which have been subjected to accident, misuse, abuse, neglect or improper storage, handling or maintenance.

THIS STATEMENT OF WARRANTY IS IN LIEU OF ALL OTHER WARRANTIES WITH RESPECT TO THE PRODUCTS, EXPRESS OR IMPLIED, WHETHER WRITTEN OR ORAL, STATUTORY, BY OPERATION OF LAW OR OTHERWISE. THERE IS NO – AND RITEN DISCLAIMS ANY – WARRANTY OF MERCHANTABILITY OR FITNESS FOR A PARTICULAR PURPOSE OR USE OR WARRANTY ARISING BY USAGE OF TRADE OR PERFORMANCE OR COURSE OF DEALING.

Any affirmation of fact, description, sample, model or promise made or provided by Riten, other than the aforementioned Statement of Warranty, shall not create a warranty and shall not be part of the basis of the parties' bargain.

**Prices, specifications, designs, and policies are subject to change without notice.**



### LIMITATION OF DAMAGES – DISCLAIMER OF LIABILITY

BUYER'S SOLE AND EXCLUSIVE REMEDY AGAINST RITEN FOR BREACH OF WARRANTY SHALL BE LIMITED TO REPAIR OR REPLACEMENT OF ANY NONCONFORMING PRODUCTS, PURSUANT TO THE ABOVE STATEMENT OF WARRANTY.

RITEN SHALL NOT BE LIABLE TO BUYER OR ANY OTHER PERSON FOR ANY SPECIAL, INDIRECT, INCIDENTAL, CONSEQUENTIAL OR EXEMPLARY LOSSES, DAMAGES OR EXPENSES, DIRECTLY OR INDIRECTLY ARISING OUT OF THE SALE, HANDLING OR USE OF THE PRODUCTS OR FROM ANY OTHER CAUSE RELATING THERETO. RITEN'S LIABILITY WHETHER BASED ON CONTRACT, WARRANTY OR TORT (INCLUDING BUT NOT LIMITED TO NEGLIGENCE AND STRICT LIABILITY) OR OTHERWISE IS LIMITED TO, AT RITEN'S OPTION, THE REPAIR OR REPLACEMENT OF NONCONFORMING PRODUCTS OR THE REPAYMENT OF, OR CREDITING BUYER WITH, AN AMOUNT EQUAL TO THE PURCHASE PRICE UPON RETURN OF THE PRODUCTS. BUYER ACKNOWLEDGES THAT IF RITEN PERFORMS UNDER THIS LIMITED REMEDY, SUCH LIMITED REMEDY SHALL NOT HAVE FAILED ITS ESSENTIAL PURPOSE.



# Riten®



*Solutions, not excuses*

**Riten Industries, Inc.**

1100 Lakeview Avenue ■ P.O. Box 340  
Washington Court House, OH 43160 USA  
740-335-5353 ■ FAX 740-335-4622

E-mail: sales [riten.com](mailto:sales@riten.com)

[www.riten.com](http://www.riten.com)

UIC #662503, FSC #3460, CAGE #05467, Harmonized Schedule B, 8466.20.1010, 8466.20.1090

©2021 Riten Industries, Inc.