



ROYAL QUICK-GRIP™ CNC COLLET CHUCKS



The Most Advanced Collet Chucks Available for Today's CNC Lathes

- ✓ Ten-Second Collet Changes Slash Setup Times.
- ✓ Industry-Leading Gripping Range – 0.062".
- ✓ Ultra-Precision Accuracy – 0.0002" TIR Guaranteed.
- ✓ Extreme Grip Force = Most Aggressive Chip Removal/Fastest Cycle Times.
- ✓ Maximum Rigidity Produces Superior Part Finishes.
- ✓ Best Tool Clearance – Critical For Live Tooling.

Big Benefit #1 Ten-Second Collet Changes

With the Royal Quick-Grip™ CNC Collet Chuck, collet changes take just seconds. Here's how it works:

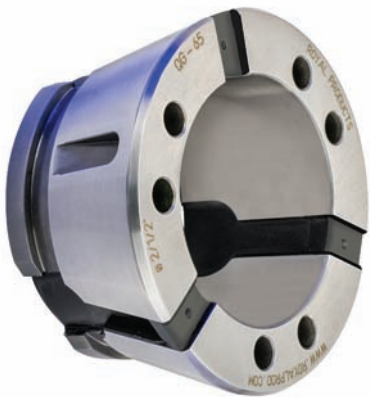

1. The unique collets are constructed of hardened steel segments securely joined together by vulcanized rubber. Each collet contains an annular hook and groove configuration on the rear section of its outer diameter.

2. The installation tool incorporates steel pins that align with drilled holes on the collet face. When these pins engage the face holes and the trigger on the tool is actuated, the collet becomes temporarily compressed.

ROYAL QUICK-GRIP™ CNC COLLET CHUCKS

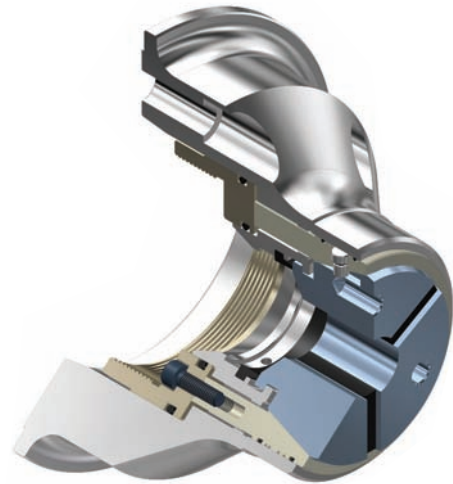

3. In its compressed state, the collet can then be inserted into the collet chuck, where the hooks on the rear of the collet segments become axially aligned with a retaining groove in the chuck.

4. Releasing the installation tool allows the collet to spring open, seating the hooks in the groove and drawing the matching ID/OD tapers into full, positive contact. The collet is now installed.

REDUCE SETUP TIME = GREATER THROUGHPUT AND HIGHER PROFITS!

Big Benefit #2 Ultra-Precision Accuracy – 0.0002" or Better

While many users purchase the Royal Quick-Grip™ CNC Collet Chuck for its lightning-fast collet changes and wide gripping range, another major benefit of this system is its extreme accuracy.

With CNC collet chucks, there are several factors which affect overall system accuracy. These include:

- Accuracy and tolerance of chuck mount (taper angle, gage line diameter, squareness of mounting flange, etc)
- Tolerance and fit between chuck components (body to mounting adapter, closing sleeve to chuck bore, etc.)
- Accuracy and tolerance of collets (OD collet angle, bore sizing, concentricity of ID to OD, etc.)

The manufacturing processes for Royal CNC collet chucks and collets have all been fully optimized to achieve the absolute tightest tolerances and highest accuracies. While we guarantee our chucks at 0.0002" TIR between the A-mount taper and collet chuck closing sleeve, they often run at 0.00005" or better! Round-bore collet accuracy is also guaranteed to be within 0.0002" TIR.

This means that out of the box, with absolutely no indicating in, you can expect to achieve a **Quick-Grip™ total system accuracy of 0.0004" TIR or better.** We know of no other collet chuck manufacturer that can consistently produce such an exact level of precision.

How much time do you waste boring jaws? The Royal Quick-Grip™ pays for itself in no time.



ROYAL QUICK-GRIP™ CNC COLLET CHUCKS

Big Benefit #3 Industry-Leading Gripping Range – 0.062"

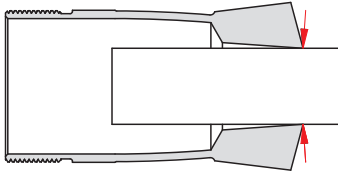

Spring-Type Collet

With a spring-type collet, unless the bore is exactly sized to the workpiece diameter there will be reduced contact, resulting in compromised accuracy and grip force.

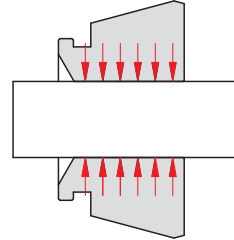

Royal Quick-Grip Collet

With a Quick-Grip™ collet, the segments always remain parallel to the workpiece, helping to maintain optimum accuracy and grip force.

Royal Quick-Grip™ Collets have a **much wider collapse range than conventional spring collets**. A spring-type collet can only be compressed by up to 0.005" before there is a sharp drop off in both grip force and accuracy due to the changing angle of the gripping surface.

However, with the unique design of the Quick-Grip™ collet, each collet segment is joined to the adjacent segments with vulcanized rubber. This ensures that **the collet segments always remain parallel to the workpiece** as the collet is compressed, giving the Quick-Grip™ collet a full collapse range of .062" (nominal diameter +/- .031).

Advantages of this system include:

- The ability to compensate for oversized and undersized bar stock.
- Superior accuracy and grip force – by remaining parallel to the workpiece, each collet segment **makes contact over its entire length**. With a spring-type collet, over-collapsing results in just a narrow ring of contact near the collet face.
- On secondary operations, the wide range of the Royal Quick-Grip™ collet provides the ability to clear larger diameters in order to grip on smaller diameters.

Big Benefit #4 Slash Cycle Times and Boost Throughput

Royal Quick-Grip™ Offers Unmatched Grip Force and Rigidity

The parallel-grip functionality of Royal Quick-Grip™ Collets provides extremely high grip force by maintaining workpiece contact over the entire length of each collet segment (see image above). Additionally, the design and construction of all Royal Quick-Grip™ CNC Collet Chucks has been optimized for rock-solid rigidity.

This combination of tremendous grip force and outstanding rigidity results in something that every manufacturer strives for – the ability to **drastically increase speeds, feeds, and depth of cut**, without sacrificing part accuracy or surface finish.

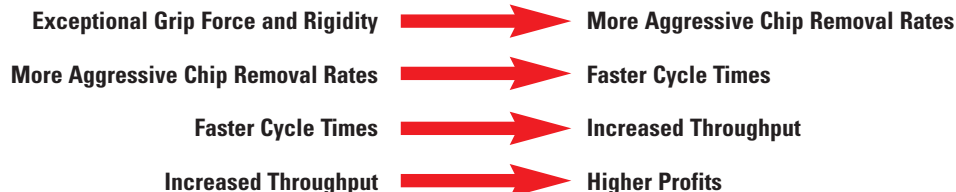

Many Royal Quick-Grip™ users have told us that they have made back their investment in just a few short weeks thanks to such a significant increase in throughput over their previous three-jaw chucks and older-style collet chucks.



Big Benefit #5 Most Compact Collet Chucks in the Industry

Royal Accu-Length™ CNC Collet Chucks have been optimized for tool clearance and rigidity. Short lengths **maximize the usable space inside the machining envelope**, while extremely compact nose diameters reduce tool interference and enable machining to take place closer to the spindle.

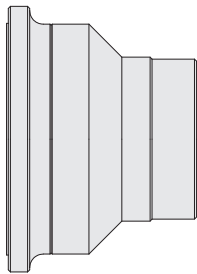

Compact

(Standard Length/Compact Nose Diameter)

The traditional length ensures that these chucks can accommodate most machine drawtubes, while a greatly reduced nose diameter offers the **best tool clearance in the industry**.

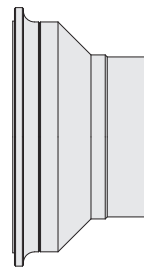

Ultra-Compact

(Compact Length/Compact Nose Diameter)

These are the smallest collet chucks available. Often mounted on sub-spindles, Royal's Ultra-Compact CNC Collet Chucks make a great choice when maximum z-axis capacity is the primary requirement.

Big Benefit #6 Exclusive Royal Bolt and Go™ Mounting Advantage

All Royal CNC Collet Chucks mount quickly, easily, and accurately due to our exclusive Bolt & Go™ mounting interface.

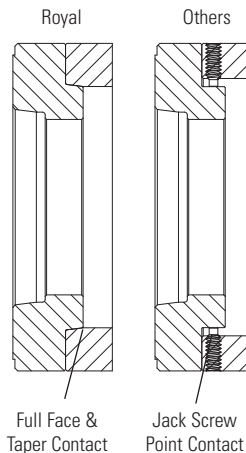

Many Royal chuck models mount directly to the lathe spindle without the need for an adapter plate. However, for models that do use a plate, a precision-ground tapered fit between the plate's male pilot and chuck body's female recess **ensures a consistent, near-perfect fit without the need for any adjustment**. This precision fit also enhances overall system rigidity by providing both face and taper contact.

Other chuck manufacturers use a less precise approach. Instead of providing a near-perfect tapered interface between the chuck body and plate, they rely on a loose fit between a male cylindrical pilot on the plate and an oversized bore within the chuck body. Because there is clearance between these two components, jack screws located around the circumference must be used to radially true-up the chuck on the plate. This process of using the jack screws and an indicator to dial out the runout each time a chuck is mounted wastes valuable production time. The rigidity of this design is also significantly lower due to the limited point-contact provided by the screws against the pilot as compared to the full-contact tapered fit of the Royal Bolt & Go™ interface.

Knock 30 Minutes Off Your Setup Time with Royal Bolt & Go™

Big Benefit #7 Royal Risk-Free Performance Guarantee



In addition to providing superior quality, service, support, and deliveries, Royal CNC Collet Chucks also carry an industry exclusive risk-free performance guarantee. This no-risk guarantee allows our customers to run a collet chuck on the toughest jobs in their shop for 45-days, and if they are not 100% satisfied with its performance, we will take it back and arrange for a full refund through their distributor.

When you buy a CNC collet chuck from Royal Products, you can have **complete confidence** that we will not let you down. For over 70 years, Royal has been recognized as one of the most reliable and trusted suppliers in the metalworking industry. We're here for you today, and we'll be here for you tomorrow.



ROYAL QUICK-GRIP™ ACCU-LENGTH™ CNC COLLET CHUCKS

Bolt & Go™

Our exclusive Bolt & Go™ mounting feature is standard on all Royal Quick-Grip™ Collet Chuck models. **Bolt & Go™ enables chucks to be mounted very quickly and ensures maximum accuracy and rigidity.** See page 7 for additional information.

Completely Sealed

Lubricated for life, these chucks incorporate multiple O-ring seals to keep contaminants out and prevent chip packing on bore-thru applications.

High RPM

All Royal Quick-Grip™ Collet Chucks are balanced by design for high-speed operation, and can often be run at higher speeds than conventional 3-jaw chucks because they are less affected by centrifugal force.



Proudly
Made
in U.S.A.

Shortest Length

Royal Quick-Grip™ CNC Collet Chucks are among **the shortest chucks available**, providing maximum work envelope utilization. This is especially important for smaller machines with limited z-axis travel.

Heavy-Duty Construction

All chuck components, except for the drawtube connector, are hardened to Rc 61-63 for high rigidity and durability.

Note: Collets sold separately

Extremely Fast Collet Changes

Changing collets on a Royal Quick-Grip™ CNC Collet Chuck takes just a few seconds. A unique hook and groove design for securing collets is used instead of traditional threads.

Wide Gripping Range

Royal Quick-Grip™ Collets have a .062" gripping range (+/- 0.031"), enabling them to easily accommodate undersized and oversized bar stock.

High Accuracy

Royal Quick-Grip™ CNC Collet Chucks are very accurate – runout on the closing angle is **guaranteed to be within 0.0002" TIR.**

Low-Profile

Royal Quick-Grip™ CNC Collet Chucks have smaller nose diameters than other quick-change collet chucks for superior tool clearance.

Collet Compatibility

Royal Quick-Grip™ Collet Chucks can also utilize some other brands of quick-change collets. Call Royal to verify.

Three Keys

All Royal Quick-Grip™ CNC Collet Chucks incorporate **three anti-rotation keys** for precise C-axis orientation.

Easy Installation

Royal Quick-Grip™ Collet Chucks include all mounting hardware, mounting wrenches, and a custom-machined drawtube connector to ensure hassle-free installation.

Specials

If you have a special application that goes beyond the scope of our standard line, we will be happy to design and build a custom system to meet your needs. Please contact a Royal applications engineer to discuss your requirements.

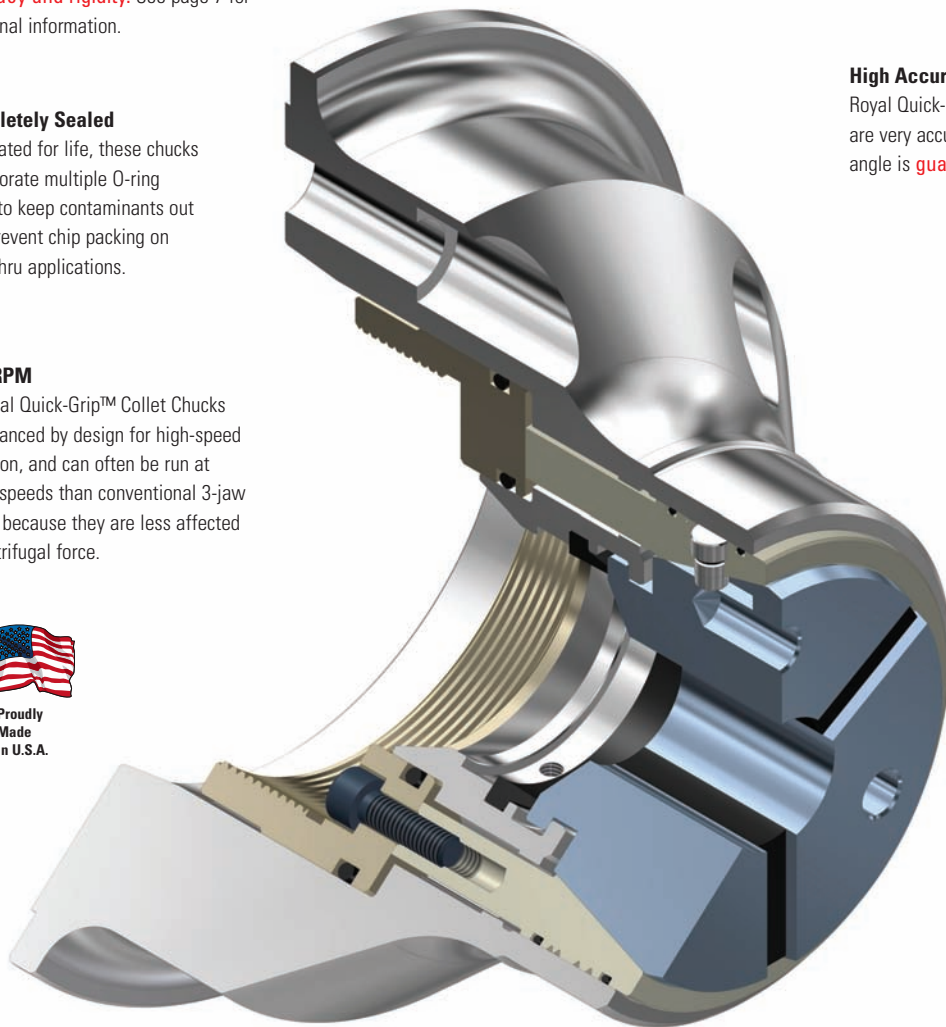

ROYAL QUICK-GRIP™ ACCU-LENGTH™ CNC COLLET CHUCKS



- ✓ 10-Second Collet Changes.
- ✓ **Widest Collet Gripping Range (.062").**
- ✓ Extremely Accurate – 0.0002" TIR.
- ✓ Parallel Workpiece Gripping.
- ✓ Compact and Ultra-Compact models to suit all machines and applications.

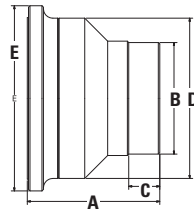

Compact
(Standard Length/
Compact Diameter)

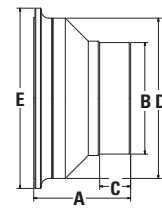

Ultra-Compact
(Compact Length/
Compact Diameter)



Royal Quick-Grip™ Accu-Length™ CNC Collet Chucks

SPINDLE TYPE	COLLET TYPE	CAPACITY	CHUCK STYLE	A OVERALL LENGTH	B NOSE DIAMETER	C NOSE LENGTH	D BODY DIAMETER	E FLANGE DIAMETER	CHUCK WEIGHT (lbs.)	MAX DRAWBAR FORCE (lbs.)	MAX CLAMPING FORCE (lbs.)	MAX RPM	PART NUMBER	PRICE*
A2-5	QG-42	1 5/8"	Compact	4.60	3.86	0.98	5.70	6.45	15	7,865	17,980	6,000	44055	\$3,260
A2-5	QG-42	1 5/8"	Ultra-Compact	4.00	3.86	0.98	5.70	6.45	13	7,865	17,980	6,000	44051	3,260
A2-6	QG-42	1 5/8"	Ultra-Compact	4.45	3.86	0.98	6.20	7.25	17	7,865	17,980	6,000	44053	3,260
140 MM	QG-42	1 5/8"	Ultra-Compact	3.95	3.86	0.98	5.70	5.70	13	7,865	17,980	6,000	44057	3,260
A2-5	QG-65	2 5/8"	Compact	4.80	4.69	1.00	6.45	7.25	19	10,115	23,600	6,000	44065	3,680
A2-5	QG-65	2 5/8"	Ultra-Compact	4.50	4.69	1.00	6.45	7.25	18	10,115	23,600	6,000	44061	3,680
A2-6	QG-65	2 5/8"	Compact	5.33	4.69	1.00	6.45	7.25	23	10,115	23,600	6,000	44067	3,680
A2-6	QG-65	2 5/8"	Ultra-Compact	4.65	4.69	1.00	6.45	7.25	18	10,115	23,600	6,000	44063	3,680
A2-6	QG-65	2 5/8"	Extended-Length**	7.00	4.69	1.00	6.45	7.25	33	10,115	23,600	6,000	44049	3,680
A2-8	QG-65	2 5/8"	Compact	5.50	4.69	1.00	8.00	9.45	37	10,115	23,600	6,000	44068	4,160
110 MM	QG-65	2 5/8"	Ultra-Compact	4.45	4.69	1.00	6.45	6.45	17	10,115	23,600	6,000	44076	4,030
140 MM	QG-65	2 5/8"	Ultra-Compact	4.80	4.69	1.00	6.45	7.45	25	10,115	23,600	6,000	44069	4,030
A2-5	QG-80	3 1/4"	Compact	4.95	5.35	1.00	7.45	7.45	28	11,240	25,850	5,000	44074	4,270
A2-6	QG-80	3 1/4"	Compact	4.95	5.35	1.00	7.45	7.45	28	11,240	25,850	5,000	44071	4,270
A2-8	QG-80	3 1/4"	Compact	5.20	5.35	1.00	8.00	9.45	31	11,240	25,850	5,000	44073	4,270
140 MM	QG-80	3 1/4"	Compact	4.75	5.35	1.00	7.45	7.45	28	11,240	25,850	5,000	44059	4,270
A2-6	QG-100	4"	Compact	6.18	6.62	0.87	9.40	10.75	84	14,610	33,720	5,000	44077	5,260
A2-8	QG-100	4"	Compact	6.43	6.62	0.87	9.40	10.75	86	14,610	33,720	5,000	44078	5,380
A2-11	QG-100	4"	Compact	6.68	6.62	0.87	9.40	12.50	88	14,610	33,720	5,000	44079	6,820

* Collets sold separately.

** For use on machines where z-axis turret travel is limited.



ROYAL QUICK-GRIP™ PULL-TO-A-STOP CNC COLLET CHUCKS

Bolt & Go™

Our exclusive Bolt & Go™ mounting feature is standard on all Royal Quick-Grip™ Collet Chuck models. **Bolt & Go™ enables chucks to be mounted very quickly and ensures maximum accuracy and rigidity.** See page 7 for additional information.

Completely Sealed

Lubricated for life, these chucks incorporate multiple O-ring seals to keep contaminants out and prevent chip packing on bore-thru applications.

High RPM

All Royal Quick-Grip™ Collet Chucks are balanced by design for high-speed operation, and can often be run at higher speeds than conventional 3-jaw chucks because they are less affected by centrifugal force.



Shortest Length

Royal Quick-Grip™ CNC Collet Chucks are among **the shortest chucks available**, providing maximum work envelope utilization. This is especially important for smaller machines with limited z-axis travel.

Heavy-Duty Construction

All chuck components, except for the drawtube connector, are hardened to Rc 61-63 for high rigidity and durability.

Note: Collets sold separately

Extremely Fast Collet Changes

Changing collets on a Royal Quick-Grip™ CNC Collet Chuck takes just a few seconds. A unique hook and groove design for securing collets is used instead of traditional threads.

Wide Gripping Range

Royal Quick-Grip™ Collets have a .062" gripping range (+/- 0.031"), enabling them to easily accommodate undersized and oversized bar stock.

High Accuracy

Royal Quick-Grip™ CNC Collet Chucks are very accurate – runout on the closing angle is **guaranteed to be within 0.0002" TIR.**

Low-Profile

Royal Quick-Grip™ CNC Collet Chucks have smaller nose diameters than other quick-change collet chucks for superior tool clearance.

Collet Compatibility

Royal Quick-Grip™ Collet Chucks can also utilize some other brands of quick-change collets. Call Royal to verify.

Three Keys

All Royal Quick-Grip™ CNC Collet Chucks incorporate **three anti-rotation keys** for precise C-axis orientation.

Easy Installation

Royal Quick-Grip™ Collet Chucks include all mounting hardware, mounting wrenches, and a custom-machined drawtube connector to ensure hassle-free installation.

Specials

If you have a special application that goes beyond the scope of our standard line, we will be happy to design and build a custom system to meet your needs. Please contact a Royal applications engineer to discuss your requirements.

Two-Chucks In One

The Royal Quick-Grip™ Pull-to-a-Stop CNC Collet Chuck includes a removable stop for precise, consistent workpiece positioning. The pullback action of the collet draws the workpiece securely against the stop, eliminating any chance of z-axis part movement and enabling very aggressive cutting.

When thru-hole capacity is required for bar feeding applications, simply remove the stop and the chuck will function as a normal pullback-style collet chuck.

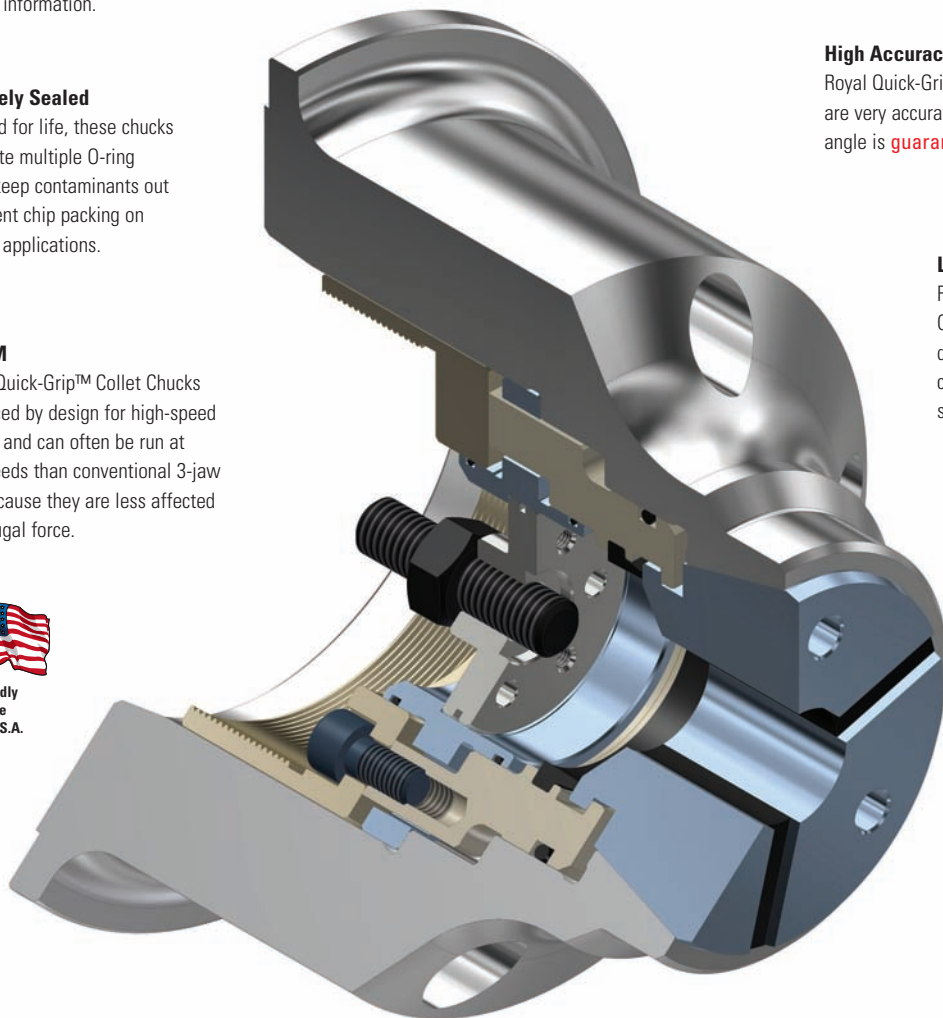

ROYAL QUICK-GRIP™ PULL-TO-A-STOP CNC COLLET CHUCKS



- ✓ Same great features as our Accu-Length™ Quick-Grip™ models, except that the collet is not fixed – it moves axially upon opening and closing.
- ✓ Adjustable stop guarantees precise, consistent z-axis part positioning and enables very aggressive cutting.
- ✓ Ideal for high-volume, robot-load applications in which the part needs to **locate against a shoulder and air-sensing / position confirmation is required.**
- ✓ Also a great choice for any CNC lathe equipped with a servo-driven bar feeder – simply remove the included stop.

NEW



Chuck includes removable standard stop.

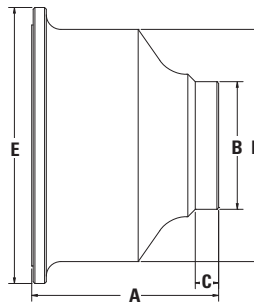

Royal Quick-Grip™ Pull-to-a-Stop CNC Collet Chucks

SPINDLE TYPE	COLLET TYPE	CAPACITY	A OVERALL LENGTH	B NOSE DIAMETER	C NOSE LENGTH	D BODY DIAMETER	E FLANGE DIAMETER	CHUCK WEIGHT (lbs.)	MAX DRAWBAR FORCE (lbs.)	MAX CLAMPING FORCE (lbs.)	MAX RPM	PART NUMBER	PRICE*
A2-5	QG-42	1 5/8"	5.10	3.54	0.62	6.00	6.70	21	7,865	17,980	6,000	46010	\$2,790
A2-6	QG-42	1 5/8"	5.50	3.54	0.62	6.25	7.45	25	7,865	17,980	6,000	46012	2,790
A2-5	QG-65	2 5/8"	5.50	4.37	0.80	6.70	7.62	28	10,115	23,600	6,000	46014	3,250
A2-6	QG-65	2 5/8"	6.00	4.37	0.80	6.70	7.62	29	10,115	23,600	6,000	46016	3,250
A2-6	QG-65	2 5/8"	7.00*	4.37	0.80	6.70	7.62	35	10,115	23,600	6,000	46017	3,250
A2-8	QG-65	2 5/8"	6.40	4.37	0.80	7.95	9.45	45	10,115	23,600	6,000	46018	3,250
A2-6	QG-80	3 1/4"	6.00	4.96	0.80	8.00	8.75	44	11,240	25,850	5,000	46020	3,580
A2-8	QG-80	3 1/4"	6.40	4.96	0.80	8.00	9.45	47	11,240	25,850	5,000	46022	3,580
A2-8	QG-100	4"	7.33	6.30	0.80	9.40	10.75	95	14,610	33,720	5,000	46024	3,850
A2-11	QG-100	4"	7.58	6.30	0.80	9.40	12.50	102	14,610	33,720	5,000	46026	4,170

* For use on machines where z-axis turret travel is limited.



ROYAL QUICK-GRIP™ PULLBACK CNC COLLET CHUCKS

Bolt & Go™

Our exclusive Bolt & Go™ mounting feature is standard on all Royal Quick-Grip™ Collet Chuck models. Bolt & Go™ enables chucks to be mounted very quickly and ensures maximum accuracy and rigidity. See page 7 for additional information.

Completely Sealed

Lubricated for life, these chucks incorporate **multiple O-ring seals to keep contaminants out** and prevent chip packing on bore-thru applications.

High RPM

All Royal Quick-Grip™ Collet Chucks are balanced by design for high-speed operation, and can often be run at higher speeds than conventional 3-jaw chucks because they are less affected by centrifugal force.

Collet Compatibility

Royal Quick-Grip™ Collet Chucks can also utilize other brands of quick-change collets. Call Royal to verify.

Shortest Length

Royal Quick-Grip™ CNC Collet Chucks are among the shortest chucks available, providing maximum work envelope utilization. This is especially important for smaller machines with limited z-axis travel.

Extremely Fast Collet Changes

Changing collets on a Royal Quick-Grip™ CNC Collet Chuck takes just a few seconds. A unique hook and groove design for securing collets is used instead of traditional threads.

Wide Gripping Range

Royal Quick-Grip™ Collets have a .062" gripping range (+/- 0.031"), enabling them to easily accommodate undersized and oversized bar stock.

High Accuracy

Royal Quick-Grip™ CNC Collet Chucks are very accurate – runout on the closing angle is guaranteed to be within 0.0002" TIR.

Low-Profile

Royal Quick-Grip™ CNC Collet Chucks have **smaller nose diameters** than other quick-change collet chucks for superior tool clearance.

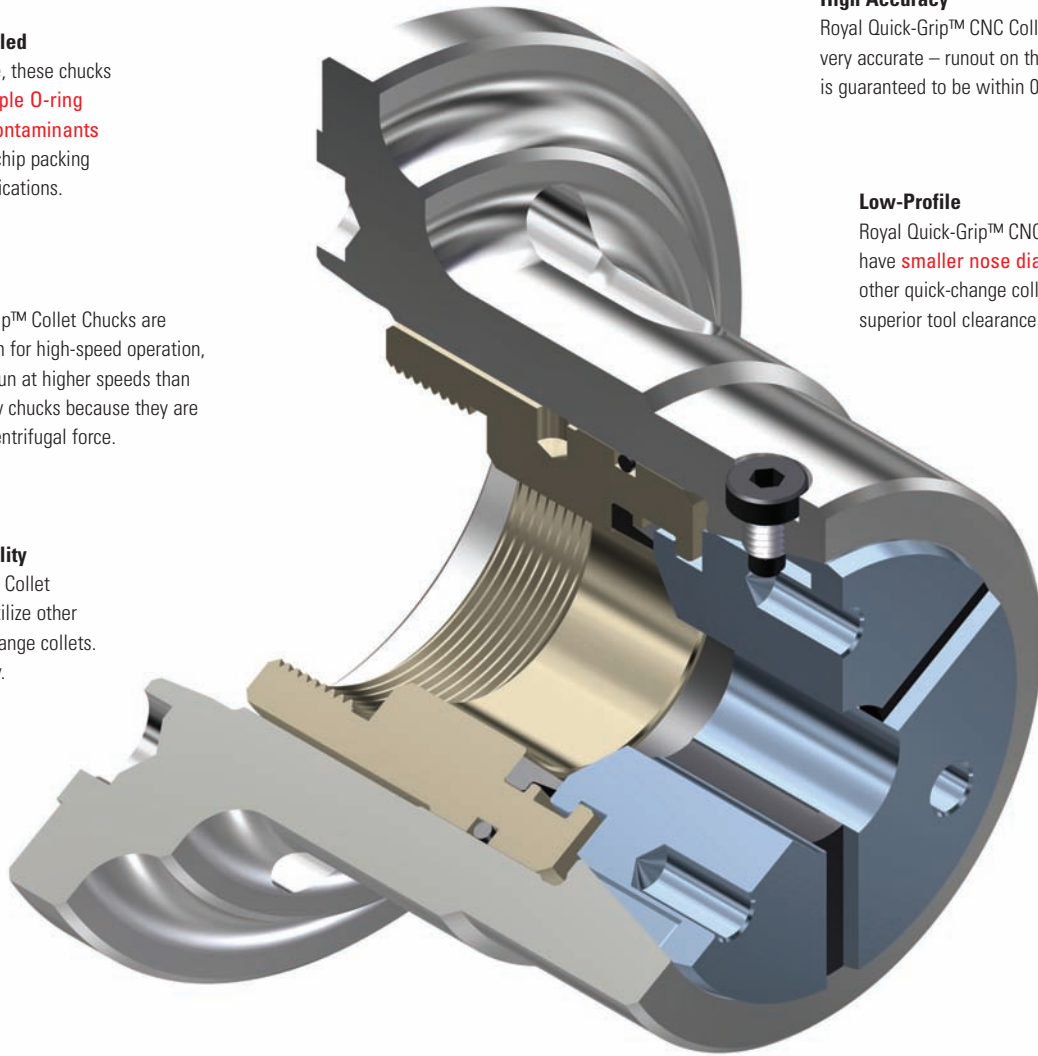

Specials

If you have a special application that goes beyond the scope of our standard line, we will be happy to design and build a custom system to meet your needs. Please contact a Royal applications engineer to discuss your requirements.

Heavy-Duty Construction

All chuck components, including the drawtube connector, are **hardened to Rc 61-63 for high rigidity and durability.**

Easy Installation

Royal Quick-Grip™ Collet Chucks include all mounting hardware, mounting wrenches, and a custom-machined drawtube connector to ensure hassle-free installation.

ROYAL QUICK-GRIP™ PULLBACK CNC COLLET CHUCKS



- ✓ Traditional pullback design – collet is pulled into chuck to close, pushed out to open.
- ✓ No collet stop capability, therefore this chuck style is **typically used only on jobs where holding precise axial position is not critical.**
- ✓ Includes many of the same features of our QG Accu-Length™ models, including:
 - 10-second collet changes
 - 0.0002" TIR accuracy on closing angle
 - Wide 0.062" collet range
 - Compact dimensions for superior clearance

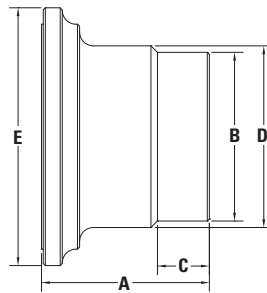

Royal Quick-Grip™ Pullback CNC Collet Chucks

SPINDLE TYPE	COLLET TYPE	CAPACITY	A OVERALL LENGTH	B NOSE DIAMETER	C NOSE LENGTH	D BODY DIAMETER	E FLANGE DIAMETER	CHUCK WEIGHT (lbs.)	MAX DRAWBAR FORCE (lbs.)	MAX CLAMPING FORCE (lbs.)	MAX RPM	PART NUMBER	PRICE*
A2-5	QG-42	1½"	4.45	4.11	3.50	5.25	6.45	11	7,865	17,980	6,000	44020	\$2,000
A2-6	QG-42	1½"	4.35	4.11	1.50	4.38	7.45	13	7,865	17,980	6,000	44022	2,150
A2-5	QG-65	2½"	4.30	4.88	1.50	6.45	6.45	19	10,115	23,600	6,000	44028	2,270
A2-6	QG-65	2½"	4.85	4.88	1.50	5.25	7.45	17	10,115	23,600	6,000	44030	2,270
A2-8	QG-65	2½"	5.00	4.88	1.50	5.72	9.45	25	10,115	23,600	6,000	44032	2,810
A2-6	QG-80	3¼"	4.85	5.47	1.25	5.68	7.45	25	11,240	25,850	5,000	44034	2,870
A2-8	QG-80	3¼"	5.00	5.47	1.25	5.72	9.45	25	11,240	25,850	5,000	44036	2,870

* Collets sold separately.



Check out the Royal Quick-Grip™ CNC Collet Chuck Video at www.colletchucks.com



ROYAL QUICK-GRIP™ CNC COLLET CHUCK ACCESSORIES

Royal Quick-Grip™ Collet Installation Tools

- Easy to use tools enable collets to be changed in seconds.
- Simply insert the steel pins into the collet face holes and squeeze the trigger to collapse the collet.
- Available in both manual and pneumatic versions.
Note – pneumatic changing tools require an air supply line.

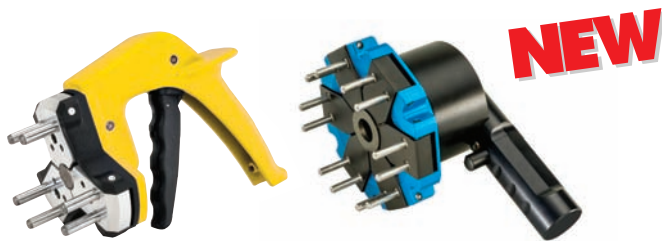

Royal Quick-Grip™ Collet Installation Tools

FITS COLLET MODEL	TYPE	PART NUMBER	PRICE
QG-42	Manual	44097	\$550
QG-42	Pneumatic	44371	1,164
QG-65	Manual	44098	550
QG-65	Pneumatic	44372	1,164
QG-80	Manual	44099	550
QG-80	Pneumatic	44373	1,995
QG-100	Pneumatic	44374	1,995

Quick-Grip™ Standard and Extra-Depth Stops

- A stop is used for accurate z-axis positioning of short workpieces within a collet.
- Rod length is easily adjusted according to workpiece parameters.
- Royal's easy-to-install stop assemblies locate against a shoulder within the chuck body and are held rigidly in-place with radially-located screws.
- Royal Quick-Grip™ Extra-Depth Stops have a greater throat depth than the standard stops, enabling **longer parts to be swallowed while minimizing protrusion beyond the collet face.**
- For use with Royal Accu-Length™ and Pull-to-a-Stop Quick-Grip™ Collet Chuck Models.

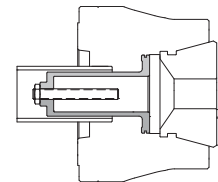

Royal Quick-Grip™ Standard Stops

FITS CHUCK MODEL	MAX THROAT DEPTH*		PART NUMBER	PRICE
	ACCU-LENGTH CHUCK MODELS	PULL-TO-A-STOP CHUCK MODELS		
QG-42	2.03	2.89	44080	\$180
QG-65	2.47	3.33	44081	205
QG-80	2.51	3.33	44084	233
QG-100	2.71	3.65	44816	265

* Measured from collet face.

Royal Quick-Grip™ Extra-Depth Stops

FITS CHUCK MODEL	MAX THROAT DEPTH*		PART DIAMETER	MAX DRAWTUBE I.D.	MIN PART NUMBER	PRICE
	ACCU-LENGTH CHUCK MODELS	PULL-TO-A-STOP CHUCK MODELS				
QG-42	5.00	5.86	1.25	1.66	44802	\$319
QG-65	6.00	6.86	1.25	1.66	44804	361
QG-65	6.00	6.86	2.25	2.73	44806	361
QG-80	6.00	6.82	2.00	2.48	44808	435
QG-80	6.00	6.82	2.75	3.23	44810	435
QG-100	6.00	6.94	2.75	3.23	44812	526
QG-100	6.00	6.94	3.50	3.91	44814	526

* Measured from collet face.

ROYAL QUICK-GRIP™ CNC COLLET CHUCK ACCESSORIES



Quick-Grip™ Ejectors

- ❑ Ejectors are used in sub-spindle applications on Accu-Length™ Chucks to push finished workpieces into the part catcher upon completion.
- ❑ A hardened plunger rod and a bronze bushing work together to provide **smooth, consistent operation**.
- ❑ New design enables tip to be changed without removing ejector assembly from the chuck.
- ❑ Available in standard and compact models:
 - Standard Model – for parts ranging in size from 0.81" to 4.00" dia.
 - Compact Model – for parts ranging in size from 0.18" to 1.50" dia.
- ❑ Easily customizable as workpiece configurations require.

For an alternative solution to an ejector, check out the Royal Grippex Coolant-Actuated Bar Puller. The Grippex, when fitted with special jaws, can be used to pull finished parts from a sub-spindle, eliminating the need for an ejector and **freeing up the spindle bore to swallow longer parts**.



Royal Quick-Grip™ Ejectors

FITS ACCU-LENGTH™ CHUCK MODEL	EJECTOR STYLE	PART DIAMETER RANGE	PART NUMBER	PRICE
QG-42	Standard	0.81"-1.63"	44040	\$698
QG-65	Standard	0.81"-2.63"	44041	709
QG-80	Standard	0.81"-3.25"	44042	719
QG-100	Standard	1.50"-4.00"	44046	731
QG-42	Compact	0.18"-1.25"	44043	604
QG-65	Compact	0.18"-1.25"	44044	614
QG-80	Compact	0.18"-1.25"	44045	625
QG-100	Compact	0.50"-1.50"	44047	637

Hardened and Ground Adapter Plates



- ❑ Adapter plates offer the flexibility to mount collet chucks and 3-jaw chucks to a wider range of spindles:
 - Mount a larger chuck on a smaller spindle for increased capacity.
 - Mount a smaller chuck on a larger spindle for increased tool clearance and higher speeds.
- ❑ All Royal adapter plates are **hardened to Rc 61-63**.
- ❑ High accuracy – 0.0002" TIR guaranteed.
- ❑ Metric screws included for mounting plate to spindle.
- ❑ Drive button included on all plates.



Royal Adapter Plates

SPINDLE MOUNT	CHUCK MOUNT	PLATE DIAMETER	PLATE THICKNESS	THRU-HOLE DIA.	SPINDLE MOUNTING BOLTS	CHUCK MOUNT THREADS	PART NUMBER	PRICE
A2-5	A2-6	6.68	1.00	2.63	M-10	M-12	44000	\$1,180
A2-6	A2-6	6.68	1.25	3.56	M-12	M-12	44009	1,048
A2-6	A2-8	8.68	1.00	3.75	M-12	M-16	44004	1,363
A2-8	A2-6	8.25	1.75	3.44	M-16	M-12	44010	1,363
A2-8	A2-8	8.69	2.00	4.76	M-16	M-16	44011	1,436
A2-11	A2-8	11.00	2.00	4.76	M-20	M-16	44014	1,728
110MM	A2-5	5.31	0.75	2.00	M-10	M-10	44006	1,021
140MM	A2-6	6.68	1.00	3.00	M-10	M-12	44008	1,212

Other configurations available. Contact a Royal Products applications engineer at 1-800-645-4174 with your requirements.

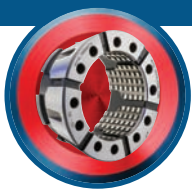

QUICK-GRIP™ COLLETS

These Extremely Advanced Collets Will Revolutionize Your Workholding



- Industry-leading **0.062" Gripping Range** – greater than other quick-change collets on the market and more than 12X that of traditional spring collets (see page 6).
- Royal Quick-Grip Collets are precision-ground to nominal size, with a gripping range of +/- 0.31" to handle undersized/oversized stock.

Example – a ½" collet is ground to 0.500" dia., and can hold any part ranging in size from 0.469" – 0.531" dia.
- Ultra-Precision Accuracy – 0.0002" TIR** or better guaranteed on round-bores (see page 5). Total system accuracy (chuck + collet) of 0.0004" or better.

- All Royal Quick-Grip™ Collets are designed for minimal projection beyond the chuck face ($\leq 0.020"$) for optimum rigidity and machine work-zone utilization.
- All models have a smooth gripping surface, but round-bores are also available in a double-serrated version for very aggressive first-op machining.
- Vulcanized rubber between the hardened steel collet segments provides outstanding protection against coolant and chip penetration, and Royal's advanced vulcanization process carries a **lifetime guarantee** against failure.
- Collets can be **counter-bored for increased capacity** (see page 21).
- Royal Quick-Grip™ Collets are compatible with some other brands of quick-change collets, but note that the QG-80 and QG-100 models have a six-slot design (for increased gripping torque) that requires the use of a Royal installation tool. Call us to verify compatibility.
- Custom sizes, shapes, and extended-nose versions available as **quick-ship specials**. Collet segments can also be carbide-coated for extremely harsh applications. Contact one of our applications engineers at 1-800-645-4174 to discuss your requirements.

Thousands of Round, Hex, Square, and Emergency Collets IN STOCK for Same-Day Shipping!

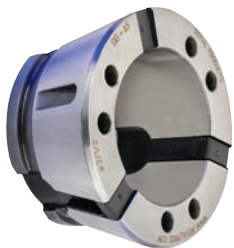

Round – Smooth



Round – Serrated



Hex

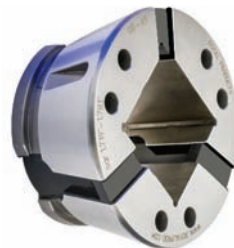

Square



Emergency

Royal Quick-Grip™ Collet Specifications

COLLET MODEL	NUMBER OF SLOTS	ROUND		HEX MAXIMUM THRU CAPACITY	SQUARE MAXIMUM THRU CAPACITY	EMERGENCY COLLETS AVAILABLE	CUSTOM SIZES AND SHAPES AVAILABLE	CARBIDE COATING AVAILABLE
		MAXIMUM THRU CAPACITY	MAXIMUM CAPACITY WHEN COUNTER-BORED**					
QG-42	3	1.656"	2.62"	1.406"	1.156"	Y	Y	Y
QG-65	3	2.656"	3.40"	2.281"	1.781"	Y	Y	Y
QG-80	6*	3.281"	4.00"	2.781"	2.031"	Y	Y	Y
QG-100	6*	4.031"	5.15"	3.281"	2.781"	Y	Y	Y

* The unique six-slot design of the Royal QG-80 and QG-100 Quick-Grip™ collets provides increased workpiece contact over the entire gripping range for superior gripping torque over other brands.

** Counter-boring collets is a special operation and it is important to note that the maximum counter-bore diameter varies with depth. For more information, please see page 21 or contact Royal.



ROYAL QUICK-GRIP™ COLLETS – QG-42

- Huge inventory of Round, Hex, Square, and Emergency styles always in stock, ready for same-day shipping.
- Smooth and serrated versions for round-bore models (all others smooth only).
- **Industry-leading 0.062" gripping range** covers a wide range of part diameters.
- Parallel-grip ensures full-length part contact for maximum grip force, rigidity, and accuracy.
- Can be counter-bored for increased part capacity up to 2.62" – see page 21 for details.
- Quick-ship specials available for custom shapes.

Royal QG-42 Round Collets – \$239 Each

GROUND DIAMETER	RANGE	SMOOTH PART NUMBER	SERRATED PART NUMBER
3/16"	0.157"-0.219"	44101	N/A
7/32"	0.188"-0.250"	44102	N/A
1/4"	0.219"-0.281"	44103	N/A
9/32"	0.250"-0.312"	44104	N/A
5/16"	0.282"-0.344"	44105	N/A
11/32"	0.313"-0.375"	44106	44155
3/8"	0.344"-0.406"	44107	44156
13/32"	0.375"-0.437"	44108	44157
7/16"	0.407"-0.469"	44109	44158
15/32"	0.438"-0.500"	44110	44159
1/2"	0.469"-0.531"	44111	44160
17/32"	0.500"-0.562"	44112	44161
9/16"	0.532"-0.594"	44113	44162
19/32"	0.563"-0.625"	44114	44163
5/8"	0.594"-0.656"	44115	44164
21/32"	0.625"-0.687"	44116	44165

GROUND DIAMETER	RANGE	SMOOTH PART NUMBER	SERRATED PART NUMBER
1 1/16"	0.657"-0.719"	44117	44166
23/32"	0.688"-0.750"	44118	44167
3/4"	0.719"-0.781"	44119	44168
25/32"	0.750"-0.812"	44120	44169
13/16"	0.782"-0.844"	44121	44170
27/32"	0.813"-0.875"	44122	44171
7/8"	0.844"-0.906"	44123	44172
29/32"	0.875"-0.937"	44124	44173
15/16"	0.907"-0.969"	44125	44174
31/32"	0.938"-1.000"	44126	44175
1"	0.969"-1.031"	44127	44176
1 1/32"	1.000"-1.062"	44128	Call
1 1/16"	1.032"-1.094"	44129	44177
1 1/8"	1.063"-1.125"	44130	Call
1 1/8"	1.094"-1.156"	44131	44178
1 5/32"	1.125"-1.187"	44132	Call

GROUND DIAMETER	RANGE	SMOOTH PART NUMBER	SERRATED PART NUMBER
1 3/16"	1.157"-1.219"	44133	44179
1 7/32"	1.188"-1.250"	44134	Call
1 1/4"	1.219"-1.281"	44135	44180
1 9/32"	1.250"-1.312"	44136	Call
1 5/16"	1.282"-1.344"	44137	44181
1 11/32"	1.313"-1.375"	44138	Call
1 3/8"	1.344"-1.406"	44139	44182
1 13/32"	1.375"-1.437"	44140	Call
1 7/16"	1.407"-1.469"	44141	44183
1 15/32"	1.438"-1.500"	44142	Call
1 1/2"	1.469"-1.531"	44143	44184
1 17/32"	1.500"-1.562"	44144	Call
1 9/16"	1.532"-1.594"	44145	44185
1 19/32"	1.563"-1.625"	44146	Call
1 5/8"	1.594"-1.656"	44147	44186

Royal QG-42 Hex Collets – \$329 Each

NOMINAL SIZE	RANGE	PART NUMBER
1/4"	0.219"-0.281"	44375
3/8"	0.344"-0.406"	44377
1/2"	0.469"-0.531"	44379
5/8"	0.594"-0.656"	44381

NOMINAL SIZE	RANGE	PART NUMBER
3/4"	0.719"-0.781"	44383
7/8"	0.844"-0.906"	44385
1"	0.969"-1.031"	44387
1 1/8"	1.094"-1.156"	44389

NOMINAL SIZE	RANGE	PART NUMBER
1 1/4"	1.219"-1.281"	44391
1 3/8"	1.344"-1.406"	44393

Royal QG-42 Square Collets – \$329 Each

NOMINAL SIZE	RANGE	PART NUMBER
1/4"	0.219"-0.281"	44670
3/8"	0.344"-0.406"	44672
1/2"	0.469"-0.531"	44674

NOMINAL SIZE	RANGE	PART NUMBER
5/8"	0.594"-0.656"	44676
3/4"	0.719"-0.781"	44678
7/8"	0.844"-0.906"	44680

NOMINAL SIZE	RANGE	PART NUMBER
1"	0.969"-1.031"	44682
1 1/8"	1.094"-1.156"	44684

Royal QG-42 Emergency Collets – \$337 Each – See Page 21



Check out the Royal Quick-Grip™ CNC Collet Chuck Video at www.colletchucks.com



ROYAL QUICK-GRIP™ COLLETS – QG-65

- Huge inventory of Round, Hex, Square, and Emergency styles always in stock, ready for same-day shipping.
- Industry-leading 0.062" gripping range covers a wide range of part diameters.
- Parallel-grip ensures **full-length part contact for maximum grip force, rigidity, and accuracy.**
- Can be counter-bored for increased part capacity up to 3.40" – see page 21 for details.
- Quick-ship specials available for custom shapes.

Royal QG-65 Round Collets – \$293 Each

GROUND DIAMETER	RANGE	SMOOTH PART NUMBER	SERRATED PART NUMBER
3/16"	0.157"-0.219"	44201	N/A
7/32"	0.188"-0.250"	44202	N/A
1/4"	0.219"-0.281"	44203	N/A
9/32"	0.250"-0.312"	44204	N/A
5/16"	0.282"-0.344"	44205	N/A
11/32"	0.313"-0.375"	44206	44306
3/8"	0.344"-0.406"	44207	44307
13/32"	0.375"-0.437"	44208	44308
7/16"	0.407"-0.469"	44209	44309
15/32"	0.438"-0.500"	44210	44310
1/2"	0.469"-0.531"	44211	44311
17/32"	0.500"-0.562"	44212	44312
9/16"	0.532"-0.594"	44213	44313
19/32"	0.563"-0.625"	44214	44314
5/8"	0.594"-0.656"	44215	44315
21/32"	0.625"-0.687"	44216	44316
11/16"	0.657"-0.719"	44217	44317
23/32"	0.688"-0.750"	44218	44318
3/4"	0.719"-0.781"	44219	44319
25/32"	0.750"-0.812"	44220	44320
13/16"	0.782"-0.844"	44221	44321
27/32"	0.813"-0.875"	44222	44322
7/8"	0.844"-0.906"	44223	44323
29/32"	0.875"-0.937"	44224	44324
15/16"	0.907"-0.969"	44225	44325
31/32"	0.938"-1.000"	44226	44326
1"	0.969"-1.031"	44227	44327

GROUND DIAMETER	RANGE	SMOOTH PART NUMBER	SERRATED PART NUMBER
1 1/32"	1.000"-1.062"	44228	Call
1 1/16"	1.032"-1.094"	44229	44328
1 3/32"	1.063"-1.125"	44230	Call
1 1/8"	1.094"-1.156"	44231	44329
1 5/32"	1.125"-1.187"	44232	Call
1 3/16"	1.157"-1.219"	44233	44330
1 7/32"	1.188"-1.250"	44234	Call
1 1/4"	1.219"-1.281"	44235	44331
1 9/32"	1.250"-1.312"	44236	Call
1 5/16"	1.282"-1.344"	44237	44332
1 11/32"	1.313"-1.375"	44238	Call
1 3/8"	1.344"-1.406"	44239	44333
1 13/32"	1.375"-1.437"	44240	Call
1 7/16"	1.407"-1.469"	44241	44334
1 15/32"	1.438"-1.500"	44242	Call
1 1/2"	1.469"-1.531"	44243	44335
1 17/32"	1.500"-1.562"	44244	Call
1 9/16"	1.532"-1.594"	44245	44336
1 19/32"	1.563"-1.625"	44246	Call
1 5/8"	1.594"-1.656"	44247	44337
1 21/32"	1.625"-1.687"	44248	Call
1 11/16"	1.657"-1.719"	44249	44338
1 23/32"	1.688"-1.750"	44250	Call
3/4"	1.719"-1.781"	44251	44339
1 25/32"	1.750"-1.812"	44252	Call
1 13/16"	1.782"-1.844"	44253	44340
1 27/32"	1.813"-1.875"	44254	Call

GROUND DIAMETER	RANGE	SMOOTH PART NUMBER	SERRATED PART NUMBER
1 7/8"	1.844"-1.906"	44255	44341
1 29/32"	1.875"-1.937"	44256	Call
1 15/16"	1.907"-1.969"	44257	44342
1 31/32"	1.938"-2.000"	44279	Call
2"	1.969"-2.031"	44258	44343
2 1/32"	2.000"-2.062"	44259	Call
2 1/16"	2.032"-2.094"	44260	44344
2 3/32"	2.063"-2.125"	44261	Call
2 1/8"	2.094"-2.156"	44262	44345
2 5/32"	2.125"-2.187"	44263	Call
2 3/16"	2.157"-2.219"	44264	44346
2 7/32"	2.188"-2.250"	44265	Call
2 1/4"	2.219"-2.281"	44266	44347
2 9/32"	2.250"-2.312"	44267	Call
2 5/16"	2.282"-2.344"	44268	44348
2 11/32"	2.313"-2.375"	44269	Call
2 3/8"	2.344"-2.406"	44270	44349
2 13/32"	2.375"-2.437"	44271	Call
2 7/16"	2.407"-2.469"	44272	44350
2 15/32"	2.438"-2.500"	44273	Call
2 1/2"	2.469"-2.531"	44274	44351
2 17/32"	2.500"-2.562"	44275	Call
2 9/16"	2.532"-2.594"	44276	44352
2 19/32"	2.563"-2.625"	44277	N/A
2 5/8"	2.594"-2.656"	44278	N/A

Royal QG-65 Hex Collets – \$439 Each

NOMINAL SIZE	RANGE	PART NUMBER
5/16"	0.282"-0.344"	44700
3/8"	0.344"-0.406"	44701
7/16"	0.407"-0.469"	44702
1/2"	0.469"-0.531"	44703
9/16"	0.532"-0.594"	44704
5/8"	0.594"-0.656"	44705
11/16"	0.657"-0.719"	44706
3/4"	0.719"-0.781"	44707
13/16"	0.782"-0.844"	44708
7/8"	0.844"-0.906"	44709
15/16"	0.907"-0.969"	44710

NOMINAL SIZE	RANGE	PART NUMBER
1"	0.969"-1.031"	44711
1 1/16"	1.032"-1.094"	44712
1 1/8"	1.094"-1.156"	44713
1 3/16"	1.156"-1.219"	44714
1 1/4"	1.219"-1.281"	44715
1 5/16"	1.281"-1.344"	44716
1 3/8"	1.344"-1.406"	44717
1 7/16"	1.406"-1.469"	44718
1 1/2"	1.469"-1.531"	44719
1 9/16"	1.531"-1.594"	44720
1 5/8"	1.594"-1.656"	44721

NOMINAL SIZE	RANGE	PART NUMBER
1 11/16"	1.656"-1.719"	44722
1 3/4"	1.719"-1.781"	44723
1 13/16"	1.781"-1.844"	44724
1 7/8"	1.844"-1.906"	44725
1 15/16"	1.906"-1.969"	44726
2"	1.969"-2.031"	44727
2 1/16"	2.031"-2.094"	44728
2 1/8"	2.094"-2.156"	44729
2 3/16"	2.156"-2.219"	44730
2 1/4"	2.219"-2.281"	44731

Royal QG-65 Square Collets – \$439 Each

NOMINAL SIZE	RANGE	PART NUMBER
3/8"	0.344"-0.406"	44787
1/2"	0.469"-0.531"	44734
5/8"	0.594"-0.656"	44788
3/4"	0.719"-0.781"	44735

NOMINAL SIZE	RANGE	PART NUMBER
7/8"	0.844"-0.906"	44789
1"	0.969"-1.031"	44736
1 1/8"	1.094"-1.156"	44790
1 1/4"	1.219"-1.281"	44737

NOMINAL SIZE	RANGE	PART NUMBER
1 3/8"	1.344"-1.406"	44791
1 1/2"	1.469"-1.531"	44738
1 5/8"	1.594"-1.656"	44792
1 3/4"	1.719"-1.781"	44739

Royal QG-65 Emergency Collets – \$438 Each – See Page 21



ROYAL QUICK-GRIP™ COLLETS – QG-80

- Huge inventory of Round, Hex, Square, and Emergency styles **always in stock, ready for same-day shipping.**
- Industry-leading 0.062" gripping range covers a wide range of part diameters.
- Parallel-grip ensures full-length part contact for maximum grip force, rigidity, and accuracy.
- Can be counter-bored for increased part capacity up to 4.00" – see page 21 for details.

Royal QG-80 Round Collets* – \$499 Each

GROUND DIAMETER	RANGE	SMOOTH PART NUMBER	SERRATED PART NUMBER
1/4"	0.219"-0.281"	44403	N/A
5/16"	0.282"-0.344"	44405	N/A
3/8"	0.344"-0.406"	44407	N/A
7/16"	0.407"-0.469"	44409	44509
1/2"	0.469"-0.531"	44411	44511
9/16"	0.532"-0.594"	44413	44513
5/8"	0.594"-0.656"	44415	44515
11/16"	0.657"-0.719"	44417	44517
3/4"	0.719"-0.781"	44419	44519
13/16"	0.782"-0.844"	44421	44521
7/8"	0.844"-0.906"	44423	44523
15/16"	0.907"-0.969"	44425	44525
1"	0.969"-1.031"	44427	44527
1 1/16"	1.032"-1.094"	44429	44529
1 1/8"	1.094"-1.156"	44431	44531
1 3/16"	1.157"-1.219"	44433	44533
1 1/4"	1.219"-1.281"	44435	44535

GROUND DIAMETER	RANGE	SMOOTH PART NUMBER	SERRATED PART NUMBER
1 5/16"	1.282"-1.344"	44437	44537
1 3/8"	1.344"-1.406"	44439	44539
1 7/16"	1.407"-1.469"	44441	44541
1 1/2"	1.469"-1.531"	44443	44543
1 9/16"	1.532"-1.594"	44445	44545
1 5/8"	1.594"-1.656"	44447	44547
1 11/16"	1.657"-1.719"	44449	44549
1 3/4"	1.719"-1.781"	44451	44551
1 13/16"	1.782"-1.844"	44453	44553
1 7/8"	1.844"-1.906"	44455	44555
1 15/16"	1.907"-1.969"	44457	44557
2"	1.969"-2.031"	44459	44559
2 1/16"	2.032"-2.094"	44461	44561
2 1/8"	2.094"-2.156"	44463	44563
2 3/16"	2.157"-2.219"	44465	44565
2 1/4"	2.219"-2.281"	44467	44567
2 5/16"	2.282"-2.344"	44469	44569

GROUND DIAMETER	RANGE	SMOOTH PART NUMBER	SERRATED PART NUMBER
2 3/8"	2.344"-2.406"	44471	44571
2 7/16"	2.407"-2.469"	44473	44573
2 1/2"	2.469"-2.531"	44475	44575
2 9/16"	2.532"-2.594"	44477	44577
2 5/8"	2.594"-2.656"	44479	44579
2 11/16"	2.657"-2.719"	44481	44581
2 3/4"	2.719"-2.781"	44483	44583
2 13/16"	2.782"-2.844"	44485	44585
2 7/8"	2.844"-2.906"	44487	44587
2 15/16"	2.907"-2.969"	44489	44589
3"	2.969"-3.031"	44491	44591
3 1/16"	3.032"-3.094"	44493	N/A
3 1/8"	3.094"-3.156"	44495	N/A
3 3/16"	3.157"-3.219"	44497	N/A
3 1/4"	3.219"-3.281"	44499	N/A

*Royal QG-80 Collets have six segments instead of three for increased gripping torque.

Royal QG-80 Hex Collets* – \$559 Each

NOMINAL SIZE	RANGE	PART NUMBER
7/16"	0.407"-0.469"	44740
1/2"	0.469"-0.531"	44741
9/16"	0.532"-0.594"	44742
5/8"	0.594"-0.656"	44743
11/16"	0.657"-0.719"	44744
3/4"	0.719"-0.781"	44745
13/16"	0.782"-0.844"	44746
7/8"	0.844"-0.906"	44747
15/16"	0.907"-0.969"	44748
1"	0.969"-1.031"	44749
1 1/16"	1.032"-1.094"	44750
1 1/8"	1.094"-1.156"	44751
1 3/16"	1.156"-1.219"	44752

NOMINAL SIZE	RANGE	PART NUMBER
1 1/4"	1.219"-1.281"	44753
1 5/16"	1.281"-1.344"	44754
1 3/8"	1.344"-1.406"	44755
1 7/16"	1.406"-1.469"	44756
1 1/2"	1.469"-1.531"	44757
1 9/16"	1.531"-1.594"	44758
1 5/8"	1.594"-1.656"	44759
1 11/16"	1.656"-1.719"	44760
1 3/4"	1.719"-1.781"	44761
1 13/16"	1.781"-1.844"	44762
1 7/8"	1.844"-1.906"	44763
1 15/16"	1.906"-1.969"	44764
2"	1.969"-2.031"	44765

NOMINAL SIZE	RANGE	PART NUMBER
2 1/16"	2.031"-2.094"	44766
2 1/8"	2.094"-2.156"	44767
2 3/16"	2.156"-2.219"	44768
2 1/4"	2.219"-2.281"	44769
2 5/16"	2.281"-2.344"	44770
2 3/8"	2.344"-2.406"	44771
2 7/16"	2.406"-2.469"	44772
2 1/2"	2.469"-2.531"	44773
2 9/16"	2.531"-2.594"	44774
2 5/8"	2.594"-2.656"	44775
2 11/16"	2.656"-2.719"	44776
2 3/4"	2.719"-2.781"	44777

*Royal QG-80 hex collets have six segments instead of three for increased gripping torque.

Royal QG-80 Square Collets – \$644 Each

NOMINAL SIZE	RANGE	PART NUMBER
3/8"	0.344"-0.406"	44793
1/2"	0.469"-0.531"	44780
5/8"	0.594"-0.656"	44794
3/4"	0.719"-0.781"	44781
7/8"	0.844"-0.906"	44795

NOMINAL SIZE	RANGE	PART NUMBER
1"	0.969"-1.031"	44782
1 1/8"	1.094"-1.156"	44796
1 1/4"	1.219"-1.281"	44783
1 3/8"	1.344"-1.406"	44797
1 1/2"	1.469"-1.531"	44784

NOMINAL SIZE	RANGE	PART NUMBER
1 5/8"	1.594"-1.656"	44798
1 3/4"	1.719"-1.781"	44785
1 7/8"	1.844"-1.906"	44799
2"	1.969"-2.031"	44786

*Royal QG-80 square collets have six segments instead of three for increased gripping torque.

Royal QG-80 Emergency Collets – \$663 Each – SEE PAGE 21



ROYAL QUICK-GRIP™ COLLETS – QG-100

- Huge inventory of Round, Hex, Square, and Emergency styles always in stock, ready for same-day shipping.
- Smooth and serrated versions for round-bore models (all others smooth only).
- Industry-leading 0.062" gripping range covers a wide range of part diameters.
- Parallel-grip ensures full-length part contact for maximum grip force, rigidity, and accuracy.
- Can be counter-bored for **increased part capacity up to 5.15"** – see page 21 for details.
- Quick-ship specials available for custom shapes.

Royal QG-100 Round Collets* – \$675 Each

GROUND DIAMETER	RANGE	SMOOTH PART NUMBER	SERRATED PART NUMBER
5/8"	0.594"-0.656"	45012	N/A
11/16"	0.657"-0.719"	45013	N/A
3/4"	0.719"-0.781"	45014	N/A
13/16"	0.782"-0.844"	45015	N/A
7/8"	0.844"-0.906"	45016	N/A
15/16"	0.907"-0.969"	45017	N/A
1"	0.969"-1.031"	45018	N/A
11/16"	1.032"-1.094"	45019	N/A
11/8"	1.094"-1.156"	45020	N/A
13/16"	1.157"-1.219"	45021	N/A
11/4"	1.219"-1.281"	45022	N/A
13/16"	1.282"-1.344"	45023	N/A
13/8"	1.344"-1.406"	45024	N/A
17/16"	1.407"-1.469"	45025	N/A
11/2"	1.469"-1.531"	45026	45201
13/16"	1.532"-1.594"	45027	45202
15/16"	1.594"-1.656"	45028	45203
111/16"	1.657"-1.719"	45029	45204
13/4"	1.719"-1.781"	45030	45205

GROUND DIAMETER	RANGE	SMOOTH PART NUMBER	SERRATED PART NUMBER
113/16"	1.782"-1.844"	45031	45206
17/8"	1.844"-1.906"	45032	45207
115/16"	1.907"-1.969"	45033	45208
2"	1.969"-2.031"	45034	45209
21/16"	2.032"-2.094"	45035	Call
27/16"	2.094"-2.156"	45036	45211
23/8"	2.157"-2.219"	45037	Call
21/4"	2.219"-2.281"	45038	45213
25/16"	2.282"-2.344"	45039	Call
23/8"	2.344"-2.406"	45040	45215
21/2"	2.407"-2.469"	45041	Call
21/2"	2.469"-2.531"	45042	45217
23/16"	2.532"-2.594"	45043	Call
25/8"	2.594"-2.656"	45044	45219
211/16"	2.657"-2.719"	45045	Call
23/4"	2.719"-2.781"	45046	45221
213/16"	2.782"-2.844"	45047	Call
27/8"	2.844"-2.906"	45048	45223
215/16"	2.907"-2.969"	45049	Call

GROUND DIAMETER	RANGE	SMOOTH PART NUMBER	SERRATED PART NUMBER
3"	2.969"-3.031"	45050	45225
31/16"	3.032"-3.094"	45051	Call
31/8"	3.094"-3.156"	45052	Call
33/16"	3.157"-3.219"	45053	Call
31/4"	3.219"-3.281"	45054	45229
35/16"	3.282"-3.344"	45055	Call
33/8"	3.344"-3.406"	45056	Call
31/2"	3.407"-3.469"	45057	Call
31/2"	3.469"-3.531"	45058	45233
33/8"	3.532"-3.594"	45059	Call
35/8"	3.594"-3.656"	45060	Call
311/16"	3.657"-3.719"	45061	Call
33/4"	3.719"-3.781"	45062	45237
313/16"	3.782"-3.844"	45063	N/A
37/8"	3.844"-3.906"	45064	N/A
315/16"	3.907"-3.969"	45065	N/A
4"	3.969"-4.031"	45066	N/A

*Royal QG-100 Collets have six segments instead of three for increased gripping torque.

Royal QG-100 Hex Collets – \$875 Each

NOMINAL SIZE	RANGE	PART NUMBER
3/4"	0.719" – 0.781"	44904
7/8"	0.844" – 0.906"	44906
1"	0.969" – 1.031"	44908
11/8"	1.094" – 1.156"	44910
11/4"	1.219" – 1.281"	44912
13/8"	1.344" – 1.406"	44914
11/2"	1.469" – 1.531"	44916

NOMINAL SIZE	RANGE	PART NUMBER
15/8"	1.594" – 1.656"	44918
13/4"	1.719" – 1.781"	44920
17/8"	1.844" – 1.906"	44922
2"	1.969" – 2.031"	44924
21/8"	2.094" – 2.156"	44926
21/4"	2.219" – 2.281"	44928
23/8"	2.344" – 2.406"	44930

NOMINAL SIZE	RANGE	PART NUMBER
21/2"	2.469" – 2.531"	44932
25/8"	2.594" – 2.656"	44934
23/4"	2.719" – 2.781"	44936
27/8"	2.781" – 2.844"	44938
3"	2.969" – 3.031"	44940
31/8"	3.094" – 3.156"	44942
31/4"	3.219" – 3.281"	44944

Royal QG-100 Square Collets – \$875 Each

NOMINAL SIZE	RANGE	PART NUMBER
1"	0.969" – 1.031"	44950
11/8"	1.094" – 1.156"	44952
11/4"	1.219" – 1.281"	44954
13/8"	1.344" – 1.406"	44956
11/2"	1.469" – 1.531"	44958

NOMINAL SIZE	RANGE	PART NUMBER
15/8"	1.594" – 1.656"	44960
13/4"	1.719" – 1.781"	44962
17/8"	1.844" – 1.906"	44964
2"	1.969" – 2.031"	44966
21/8"	2.094" – 2.156"	44968

NOMINAL SIZE	RANGE	PART NUMBER
21/4"	2.219" – 2.281"	44970
23/8"	2.344" – 2.406"	44972
21/2"	2.469" – 2.531"	44974
25/8"	2.594" – 2.656"	44976
23/4"	2.719" – 2.781"	44978

Royal QG-100 Emergency Collets – \$805 Each – See Page 21

ROYAL QUICK-GRIP™ COLLETS – EMERGENCY



- Semi-hard Quick-Grip™ emergency collets are designed to be machined in-place by the user to **accommodate special sizes, shapes, steps, etc.**
- Available in assorted pilot hole sizes to minimize machining time.
- Collets can be counter-bored beyond standard capacity, **eliminating the need for a three-jaw chuck on many jobs.** The chart below provides some basic counter-bore guidelines, but many other diameter/depth combinations are possible. Please contact Royal for additional information.
- Boring fixture holds collet segments firmly in-place and puts collet under slight compression to ensure accuracy and roundness during machining. Order fixture separately.

Royal Quick-Grip™ Emergency Collets

FITS CHUCK MODEL	PILOT HOLE SIZE	PART NUMBER	PRICE
QG-42	5mm (0.20")	44187	\$337
	15mm (0.59")	44188	337
	30mm (1.18")	44189	337
QG-65	8mm (0.31")	44353	438
	20mm (0.79")	44354	438
	30mm (1.18")	44355	438
	40mm (1.57")	44356	438
QG-80	8mm (0.31")	44360	663
	20mm (0.79")	44361	663
	40mm (1.57")	44362	663
	60mm (2.36")	44363	663
QG-100	30mm (1.18")	44367	805
	45mm (1.77")	44368	805
	90mm (3.54")	44370	805



Royal Boring Fixtures

COLLET MODEL	PART NUMBER	PRICE
QG-42	44082	\$193
QG-65	44083	273
QG-80	44088	445
QG-100	44089	535

Royal Quick-Grip™ Collet Counter-Bore Guidelines

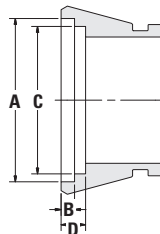

- The parameters shown represent a sampling of counter-bore possibilities. Other diameter/depth combinations are possible. Please contact Royal with your specific requirements.
- Users can counter-bore their own emergency collets, or **order to size as hardened and ground specials.**

COLLET MODEL	A	B	C	D
QG-42	2.62"	0.28"	2.53"	0.39"
QG-65	3.40"	0.28"	3.07"	0.51"
QG-80	4.00"	0.28"	3.66"	0.51"
QG-100	5.15"	0.28"	4.61"	0.79"