

SlimFIT SBL6 Extended Reach Collet System

SlimFIT: Extreme precision, slim design and extended reach.



Features

- Maximum T.I.R. 0.0001" from taper to collet pocket
- Balanced to 25,000 RPM at G2.5
- .55" nose diameters

SlimFIT is the best collet & nut holder solution for cutting tools from 3/32" up to 1/4" when cutting at extended lengths.

12" tapered collet chuck



SlimFIT collets are longer and more powerful than ER collets and provide better accuracy and performance at extended lengths.

Advantages of SlimFIT tool design

The drawbar tightening system eliminates collet nuts, saving time and money. Powerful 4° taper collets provide improved performance holding tool shanks from 3/32" to 1/4" (3mm-6mm). Perform fast tool changes using just the T-wrench.

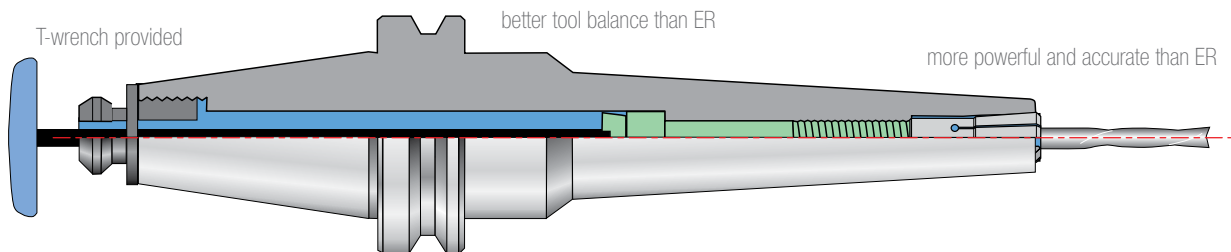

You lose 10% of tool life for every .0001" of T.I.R.
SlimFIT Chucks offer excellent accuracy at extended lengths.

Built for Speed.

All Techniks products are backed by our 100% satisfaction guarantee!



We stand behind all our products with our 100% Satisfaction Guarantee • www.techniksusa.com

CAT40, CAT50 Precision SlimFIT SBL6 Holders



Features

- Maximum T.I.R. 0.0001" from taper to collet pocket
- Balanced to 25,000 RPM at G2.5
- .55" nose diameters



Techniks Certified for accuracy and balance
Each holder comes with a complete lab report

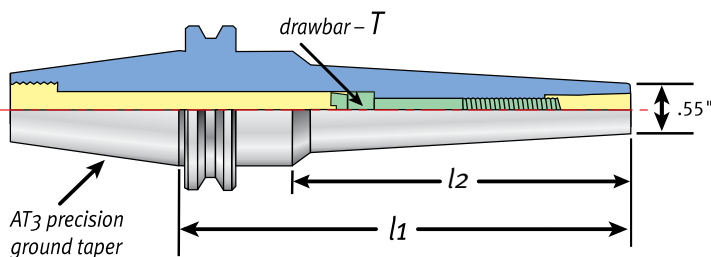

SlimFIT SBL6 holders feature 4° collets and a powerful drawbar tightening system that hold tools tighter and more accurately at extended lengths than ER systems. For tools 3/32" up to 1/4" (3mm-6mm).

Tool changes do not require tightening fixtures, or torque wrenches and can be performance by hand, using the supplied T-wrench.

CAT40, CAT50 SlimFIT Toolholders

Part No.	Description	l1	l2	Drawbar-T
23654	CAT40 x SBL6 - 3" SlimFIT	3"	1.625"	SYIC-SBL-M6C-60
23656	CAT40 x SBL6 - 4" SlimFIT	4"	2.625"	SYIC-SBL-M6C-35
23658	CAT40 x SBL6 - 6" SlimFIT	6"	4.625"	SYIC-SBL-M6C-80
23659	CAT40 x SBL6 - 8" SlimFIT	8"	6.622"	SYIC-SBL-M6C-130
23672	CAT50 x SBL6-3.5" SlimFIT	3.5"	2.12"	SYIC-SBL-M6C-65
23676	CAT50 x SBL6-6" SlimFIT	6"	4.622"	SYIC-SBL-M6C-80

Replacement T20 Wrenches

Part No.	Description
T2050TKIA81F	100mm T-Handle
T20L3TKIA81F	200mm slim shaft fits coolant pull stud



Order SlimFIT 6 collets individually or as a convenient set. See page 20.

Use SlimFIT holders for high-precision machining in tight areas at extended lengths

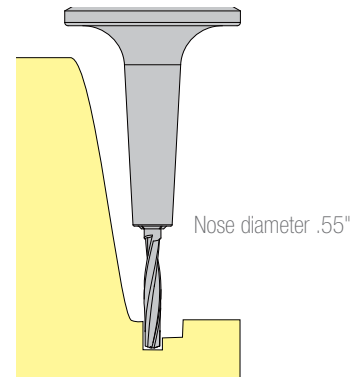

Use a coolant retention knob for coolant thru



BT30, BT40 Precision SlimFIT SBL6 Holders



Features

- Maximum T.I.R. 0.0001" from taper to collet pocket
- Balanced to 25,000 RPM at G2.5
- .55" nose diameters



Techniks Certified for accuracy and balance
Each holder comes with a complete lab report

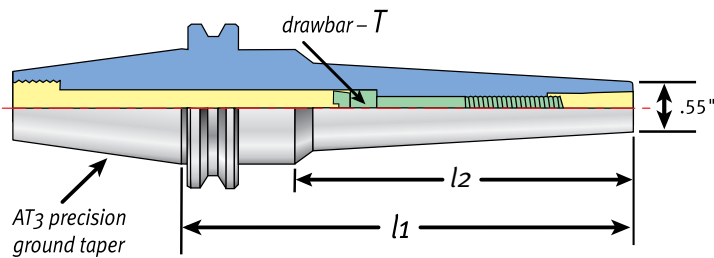

SlimFIT SBL6 holders feature 4° collets and a powerful drawbar tightening system that hold tools tighter and more accurately at extended lengths than ER systems. For tools 3/32" up to 1/4" (3mm-6mm).

Tool changes do not require tightening fixtures, or torque wrenches and can be performed by hand, using the supplied T-wrench.

BT30, BT40 SlimFIT Toolholders

Part No.	Description	l1	l2	Drawbar-T
18854	BT30 x SBL6-70	70mm	48mm	SYIC-SBL-M6C-45
18856	BT30 x SBL6-100	100mm	78mm	SYIC-SBL-M6C-65
18866	BT40 x SBL6-70	70mm	43mm	SYIC-SBL-M6C-45
18868	BT40 x SBL6-100	100mm	73mm	SYIC-SBL-M6C-80
18868-150	BT40 x SBL6-150	150mm	123mm	SYIC-SBL-M6C-65
18869	BT40 x SBL6-200	200mm	173mm	SYIC-SBL-M6C-130

Replacement T20 Wrenches

Part No.	Description
T2050TKIA81F	100mm T-Handle
T20L3TKIA81F	200mm slim shaft fits coolant pull stud



Order SlimFIT 6 collets individually or as a convenient set. See page 20.

Use SlimFIT holders for high-precision machining in tight areas at extended lengths

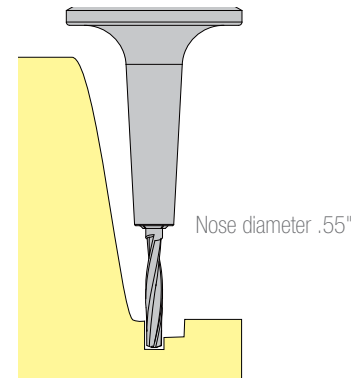

Use a coolant retention knob for coolant thru



HSK63A Precision SlimFIT SBL6 Holders



Features

- Maximum T.I.R. 0.0001" from taper to collet pocket
- Balanced to 25,000 RPM at G2.5
- .55" nose diameters



Techniks Certified for accuracy and balance
Each holder comes with a complete lab report

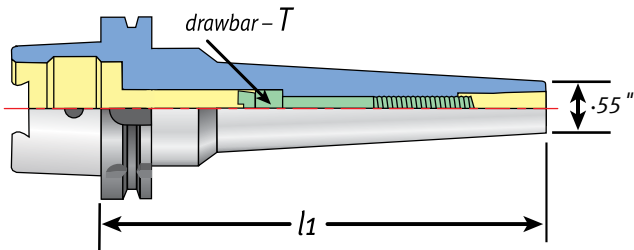

SlimFIT SBL6 holders feature 4° collets and a powerful drawbar tightening system that hold tools tighter and more accurately at extended lengths than ER systems. For tools 3/32" up to 1/4" (3mm-6mm).

Tool changes do not require tightening fixtures, or torque wrenches and can be performed by hand, using the supplied T-wrench.

HSK63A SlimFIT Toolholders

Part No.	Description	l1	l2	Drawbar-T
35470	HSK63A x SBL6-80 SlimFIT	80mm	54mm	SYIC-SBL-M6C-15
35472	HSK63A x SBL6-120 SlimFIT	120mm	94mm	SYIC-SBL-M6C-50

Replacement T20 Wrenches

Part No.	Description
T2050TKIA81F	100mm T-Handle
T20L3TKIA81F	200mm slim shaft fits coolant pull stud



Order SlimFIT 6 collets individually or as a convenient set. See page 20.

Use SlimFIT holders for high-precision machining in tight areas at extended lengths

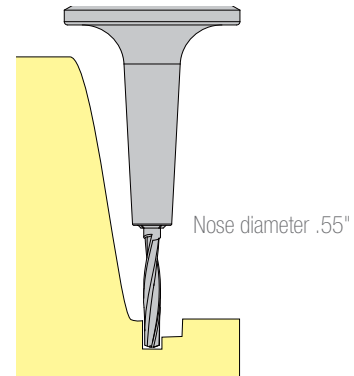

Use a coolant retention knob for coolant thru



SlimFIT High-Precision Extensions

Extensions turn any 1/2" or 5/8" holder into a SlimFIT tool!



Features

- Use with any 1/2" or 5/8" toolholder –even end mill holders
- 4° angle drawbar collet for greater holding power and accuracy
- Only .48" nose diameter!

Extensions feature a nose clearance of .48" which allows machining where other tools cannot reach.



Use a coolant retention knob for coolant thru



Use SlimFIT extensions with cutting tools from 3/32" up to 1/4" (3-6mm) shank sizes. Internal drawbar collet eliminates collet nut to permit narrow nose diameter.

Tool changes do not require tightening fixtures, or torque wrenches and can be performance by hand, using the supplied T-wrench.

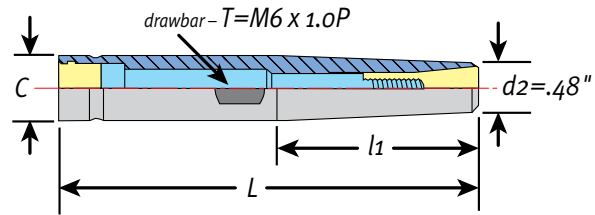

SlimFIT Extensions Fit 1/2" or 5/8" Toolholders

Part No.	Description	L	l1	C
06032-3	1/2" x OLP6-3" extension	3"	1.89"	.50"
06032	1/2" x OLP6-5" extension	5"	1.89"	.50"
06034	1/2" x OLP6-6" extension	6"	1.89"	.50"
06038	5/8" x OLP6-5" extension	5"	1.89"	.625"
06040	5/8" x OLP6-6" extension	6"	1.89"	.625"
06042	5/8" x OLP6-8" extension	8"	1.89"	.625"

Replacement T20 Wrenches

Part No.	Description
T2050TKIA81F	100mm T-Handle
T20L3TKIA81F	200mm slim shaft fits coolant pull stud



Order SlimFIT 6 collets individually or as a convenient set. See page 20.

High-Performance SlimFIT Collets



Features

- Made from high-carbon steel and heat-treated for long life
- Precision ground and polished
- Each collet individually inspected for quality

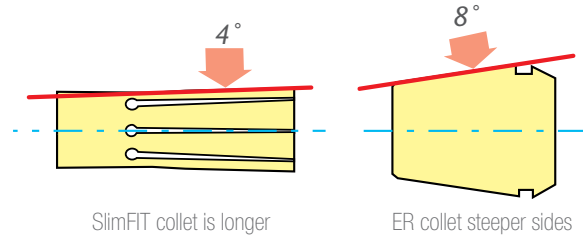

Why SlimFIT out-performs ER Collet systems

SlimFIT collets are longer overall than ER collets and feature a 4° taper, so there is more engagement with the tool shank and the drawbar clamping holds more securely than ER. Also the holder assembly is better balanced than ER since there is no collet nut needed.

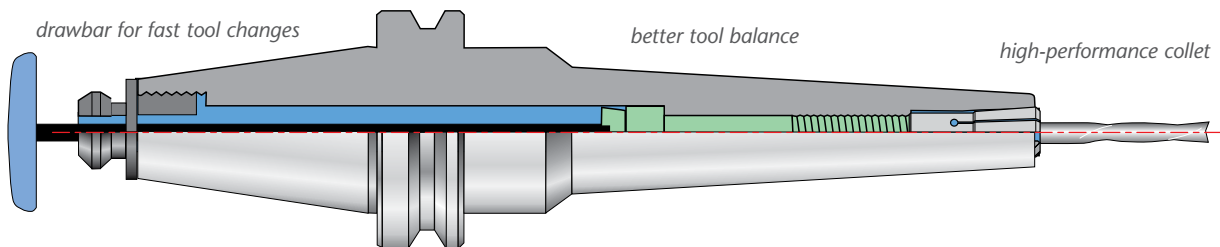

SlimFIT Inch Collets

Part No.	Description
18851-3/32	SlimFIT 6 - 3/32" collet
18851-7/64	SlimFIT 6 - 7/64" collet
18851-1/8	SlimFIT 6 - 1/8" collet
18851-9/64	SlimFIT 6 - 9/64" collet
18851-5/32	SlimFIT 6 - 5/32" collet
18851-11/64	SlimFIT 6 - 11/64" collet
18851-3/16	SlimFIT 6 - 3/16" collet
18851-13/64	SlimFIT 6 - 13/64" collet
18851-7/32	SlimFIT 6 - 7/32" collet
18851-15/64	SlimFIT 6 - 15/64" collet
18851-1/4	SlimFIT 6 - 1/4" collet

SlimFIT Inch & Metric Set

Part No.	Description
18851-12IMS	SlimFIT 12 piece set

Convenient collet set provides the collets you need, and the wooden tray prevents damage to collets.

Set includes 12 collets.

INCH: 7/64", 1/8", 9/64", 11/64", 3/16", 13/64", 15/64", 1/4"

METRIC: 3mm, 4mm, 5mm, 6mm and wooden tray.

SlimFIT Metric Collets

Part No.	Description
18851-03	SlimFIT 6 - 3mm collet
18851-04	SlimFIT 6 - 4mm collet
18851-05	SlimFIT 6 - 5mm collet
18851-05.5	SlimFIT 6 - 5.5mm collet
18851-06	SlimFIT 6 - 6mm collet

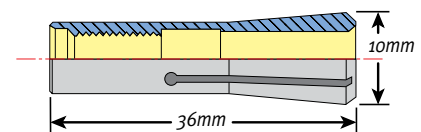

SlimFIT Collet Dimensions

NOTE: Tighten to 9 ft/lbs

Techniks Certified ER Collet & Nut Toolholders

Balanced to 25,000 RPM

Factory balanced to 25,000 RPM at G2.5
Custom balancing to 60,000 RPM available.



Ultra Precision Collet

Each collet hand inspected.
T.I.R. only 0.0002"

Taper Accuracy AT3

Taper ground to AT3 accuracy for
maximum contact with spindle.

Taper-to-Pocket T.I.R. 0.0001"

Measured from taper O.D. to collet pocket I.D.

Lab Certified Accuracy

Each toolholder is lab certified for
accuracy and balance.



Inch and
Metric Sizes



Sealed



Steel Sealed



T.I.R. 0.0002"



Quick-Change Tap



Floating Tap



Rigid Tap



PowerCOAT Nuts

Our PowerCOAT nut holds 75%
tighter than standard nuts for best
T.I.R. and rigidity.



Balanced Nut

Balanced nut reduces vibration
at high speeds to extend cutting tool life.



<http://ow.ly/rigp6>
View the video



Techniks Certified Tooling means the critical features of each holder has been individually lab tested, measured and inspected for quality. Depending on the holder this can include: balance, dimensional accuracy, collet pocket runout (T.I.R.), bore I.D. and taper accuracy.

You lose 10% of tool life for every .0001" of T.I.R.
Techniks collets & nut toolholders extend cutting tool life.

Built for Speed.



All Techniks products are backed by our 100% satisfaction guarantee!



We stand behind all our products with our 100% Satisfaction Guarantee • www.techniksusa.com

CAT40 Precision ER Toolholders

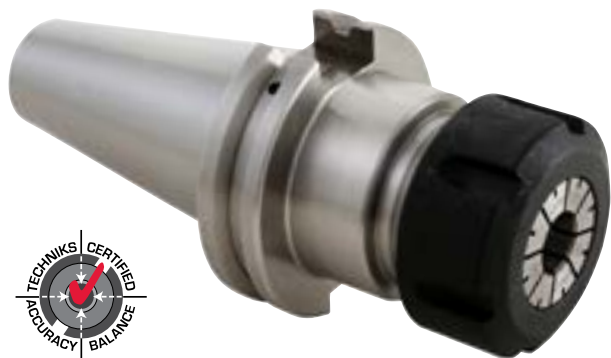

Techniks Certified for accuracy and balance
Each holder comes with a complete lab report

For shank sizes 1/8" (3mm) or smaller use our DNA (dead nuts accurate) collet results.

See page 54.



Features

- *Balanced to 25,000 RPM at G2.5*
- *T.I.R. 0.0001" measured from taper to collet pocket*
- *PowerCOAT nut included for 75% more clamping power*

For ER16 and 20 slotted nuts, add SLOTNUT to the end of the part number. For holders with coolant nut included add -C to the end of the part number. Coolant nuts are not available for ER50.



Collets
pg. 49



Nuts
pg. 64



Coolant
Rings
pg. 66



Retention
Knobs
pg. 228



Wrenches
pg. 232



Tightening
Stands
pg. 234

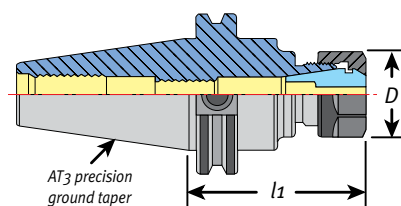

CAT40 ER Toolholders

Part No.	Description	l1	D	Max. Shank	Set Screw	Wrench
22213-3	CAT40 x ER11 - 3", hex nut	3"	.748"	.275"	16081	04608
22225	CAT40 x ER16 - 2.76", hex nut	2.76"	1.08"	.406"	16083	04609
22227	CAT40 x ER16 - 4", hex nut	4"	1.08"	.406"	16083	04609
22231	CAT40 x ER16 - 6", hex nut	6"	1.08"	.406"	16083	04609
22233	CAT40 x ER16 - 8", hex nut	8"	1.08"	.406"	16083	04609
NEW 22233-10	CAT40 x ER16 - 10", hex nut	10"	1.08"	.406"	16083	04609
22235	CAT40 x ER20 - 2.76", hex nut	2.76"	1.34"	.512"	16087	04610
22237	CAT40 x ER20 - 4", hex nut	4"	1.34"	.512"	16087	04610
22239	CAT40 x ER20 - 6", hex nut	6"	1.34"	.512"	16087	04610
NEW 22239-10	CAT40 x ER20 - 10", hex nut	10"	1.34"	.512"	16087	04610
22243-2.5	CAT40 x ER25 - 2.5", slotted nut	2.5"	1.65"	.630"	16089	04615
22243	CAT40 x ER25 - 2.76", slotted nut	2.76"	1.65"	.630"	16089	04615
22245	CAT40 x ER25 - 4", slotted nut	4"	1.65"	.630"	16089	04615
22247	CAT40 x ER25 - 6", slotted nut	6"	1.65"	.630"	16089	04615
22251	CAT40 x ER25 - 8", slotted nut	8"	1.65"	.630"	16089	04615
22253	CAT40 x ER32 - 2.76", slotted nut	2.76"	1.97"	.788"	16089	04616
22255	CAT40 x ER32 - 4", slotted nut	4"	1.97"	.788"	16089	04616
22257	CAT40 x ER32 - 6", slotted nut	6"	1.97"	.788"	16089	04616
22259	CAT40 x ER32 - 8", slotted nut	8"	1.97"	.788"	16089	04616
NEW 22259-10	CAT40 x ER32 - 10", slotted nut	10"	1.97"	.788"	16089	04616
22261	CAT40 x ER40 - 3.15", slotted nut	3.15"	2.48"	1.023"	16091	04617
22263	CAT40 x ER40 - 4", slotted nut	4"	2.48"	1.023"	16091	04617
22265	CAT40 x ER40 - 6", slotted nut	6"	2.48"	1.023"	16091	04617
22269	CAT40 x ER50 - 4", slotted nut	4"	3.07"	1.338"	16093	04618

CAT40 Precision CoolFLEX ER Toolholders



Techniks Certified for accuracy and balance
Each holder comes with a complete lab report

Features

- Coolant-thru spindle or thru flange (DIN B)
- Balanced to 25,000 RPM at G2.5
- T.I.R. 0.0001" or better from taper to collet pocket

For ER16 and 20 slotted nuts, add SLOTNUT to the end of the part number. For holders with coolant nut included add -C to the end of the part number. Coolant nuts are not available for ER50.

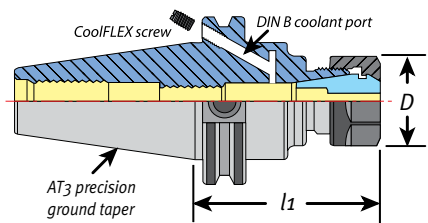

CoolFLEX Feature

CoolFLEX holders are factory set for coolant-thru spindle. Simply remove 2 stop screws for DIN B coolant-thru flange.

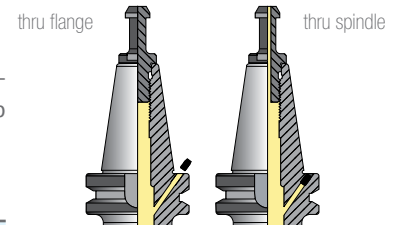

Part No. Description

HSA-4-6	40 taper DIN B screw
---------	----------------------

Coolant Set Screws page 47.

CAT40 CoolFLEX Coolant-Thru Spindle or Flange (DIN B)

Part No.	Description	l1	D	Max. Shank	Set Screw	Wrench
22225F	CAT40 x ER16 - 2.76", hex nut	2.76"	1.08"	.406"	16083	04609
22227F	CAT40 x ER16 - 4", hex nut	4"	1.08"	.406"	16083	04609
22231F	CAT40 x ER16 - 6", hex nut	6"	1.08"	.406"	16083	04609
22233F	CAT40 x ER16 - 8", hex nut	8"	1.08"	.406"	16083	04609
22235F	CAT40 x ER20 - 2.76", hex nut	2.76"	1.34"	.512"	16087	04610
22237F	CAT40 x ER20 - 4", hex nut	4"	1.34"	.512"	16087	04610
22239F	CAT40 x ER20 - 6", hex nut	6"	1.34"	.512"	16087	04610
22243F	CAT40 x ER25 - 2.76", slotted nut	2.76"	1.65"	.630"	16089	04615
22245F	CAT40 x ER25 - 4", slotted nut	4"	1.65"	.630"	16089	04615
22247F	CAT40 x ER25 - 6", slotted nut	6"	1.65"	.630"	16089	04615
22251F	CAT40 x ER25 - 8", slotted nut	8"	1.65"	.630"	16089	04615
22253F	CAT40 x ER32 - 2.76", slotted nut	2.76"	1.97"	.788"	16089	04616
22255F	CAT40 x ER32 - 4", slotted nut	4"	1.97"	.788"	16089	04616
22257F	CAT40 x ER32 - 6", slotted nut	6"	1.97"	.788"	16089	04616
22259F	CAT40 x ER32 - 8", slotted nut	8"	1.97"	.788"	16089	04616
22261F	CAT40 x ER40 - 3.15", slotted nut	3.15"	2.48"	1.023"	16091	04617
22263F	CAT40 x ER40 - 4", slotted nut	4"	2.48"	1.023"	16091	04617

Blue indicates coolant.



CAT40 Precision ER Mini Nut Holders



Techniks Certified for accuracy and balance.
Each holder comes with a complete lab report

Features

- *Narrow nut diameter for better clearance*
- *Balanced to 25,000 RPM at G2.5*
- *T.I.R. 0.0001" measured from taper to collet pocket*



Collets
pg. 49



Nuts
pg. 64



Coolant
Rings
pg. 66



Retention
Knobs
pg. 228



Wrenches
pg. 232



Tightening
Stands
pg. 234



Coolant Options

- *ER coolant rings (pg. 66)*
- *ER Steel Sealed collets (pg. 56)*
- *ER Sealed coolant collets (pg. 58)*

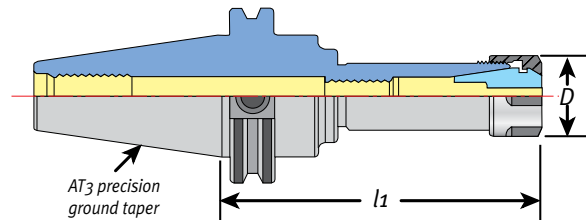

CAT40 ER Mini Nut Holders

Coolant Set Screws page 47.

Part No.	Description	l1	D	Max. Shank	Set Screw	Wrench
22352	CAT40 x ER11 - 2.75", mini nut	2.75"	.63"	.275"	16081	04621
22354	CAT40 x ER11 - 4", mini nut	4"	.63"	.275"	16081	04621
22354-6	CAT40 x ER11 - 6", mini nut	6"	.63"	.275"	16081	04621
22354-8.5	CAT40 x ER11 - 8.5", mini nut	8.5"	.63"	.275"	16081	04621
22356	CAT40 x ER16 - 2.76", mini nut	2.76"	.87"	.406"	16083	04622
22358	CAT40 x ER16 - 4", mini nut	4"	.87"	.406"	16083	04622
22359	CAT40 x ER16 - 6", mini nut	6"	.87"	.406"	16083	04622
22359-8	CAT40 x ER16 - 8", mini nut	8"	.87"	.406"	16083	04622
22360	CAT40 x ER20 - 2.76", mini nut	2.76"	1.102"	.512"	16087	04623
22362	CAT40 x ER20 - 4", mini nut	4"	1.102"	.512"	16087	04623

CAT40 Precision SuperRIGID Holders



Techniks Certified for accuracy and balance
 Each holder comes with a complete lab report
 Collet nut is included with each holder

Features

- *Balanced to 25,000 RPM at G2.5*
- *Best T.I.R. and Z axis of any collet chuck*
- *SuperRIGID for high torque or high speed machining*



Use SuperRIGID holders with ER32 collets.

SuperRIGID Holders

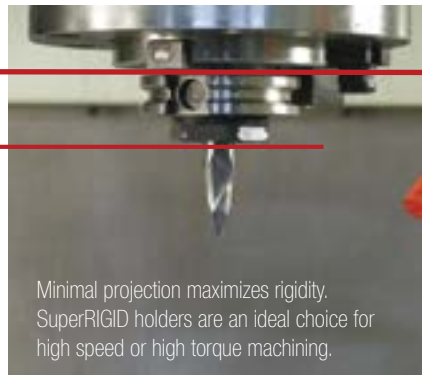

minimum projection

Minimal projection maximizes rigidity. SuperRIGID holders are an ideal choice for high speed or high torque machining.

Standard Holders

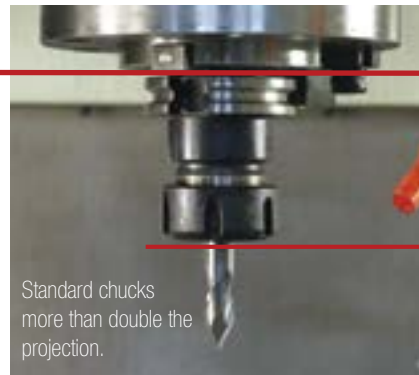

standard projection

Standard chucks more than double the projection.

Minimum projection = increased rigidity, better T.I.R. and extended cutter life.

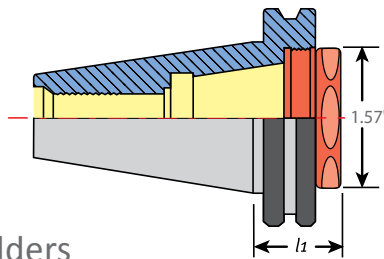

PowerCOAT
TE-22HN Nut

CAT40 SuperRIGID ER Toolholders

Part No.	Description	l1	Collet	Max. Shank	Wrench
22253S	CAT40 x ER32	1.10"	ER32	3/4" or 20mm	894-36
TE-22HN	hex style PowerCOAT replacement nut				



CAT40 DualDRIVE for Dual-Contact Spindles



Techniks Certified for accuracy and balance
Each holder comes with a complete lab report

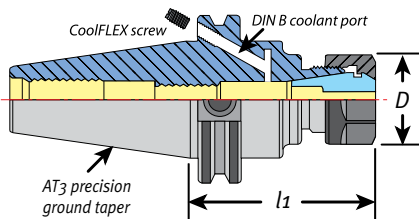

Features

- New one-piece design for dual-contact spindles
- Coolant-thru spindle or thru flange (DIN B)
- Balanced to 25,000 RPM at G2.5

Benefits

- Better rigidity and reduced vibration
- Improved performance at high metal removal rates and when machining at extended lengths

CoolFLEX Feature

CoolFLEX holders are factory set for coolant-thru spindle. Simply remove 2 stop screws for DIN B coolant-thru flange.

thru flange thru spindle

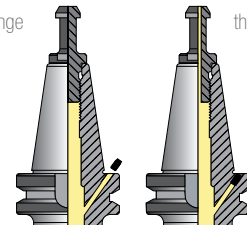

Coolant Set Screws page 47.

Part No. Description

HSA-4-6	40 taper DIN B screw
---------	----------------------

CAT40 DualDRIVE Coolant-Thru Spindle or Flange (DIN B)

Part No.	Description - L1	L1	D	Collet	Max. Shank	Set Screw	Wrench
46.122.16.276	CAT40 x ER16 -2.76" DualDRIVE	2.76"	1.08"	ER16	.406"	16083	04609
46.122.16.400	CAT40 x ER16 - 4" DualDRIVE	4"	1.08"	ER16	.406"	16083	04609
46.122.16.600	CAT40 x ER16 - 6" DualDRIVE	6"	1.08"	ER16	.406"	16083	04609
46.122.16.800	CAT40 x ER16 - 8" DualDRIVE	8"	1.08"	ER16	.406"	16083	04609
NEW 46.122.20.276	CAT40 x ER20 -2.76" DualDRIVE	2.76"	1.34"	ER20	.512"	16087	14610
NEW 46.122.20.400	CAT40 x ER20 - 4" DualDRIVE	4"	1.34"	ER20	.512"	16087	14610
NEW 46.122.20.600	CAT40 x ER20 - 6" DualDRIVE	6"	1.34"	ER20	.512"	16087	14610
NEW 46.122.20.800	CAT40 x ER20 - 8" DualDRIVE	8"	1.34"	ER20	.512"	16087	14610
46.122.32.276	CAT40 x ER32 - 2.76" DualDRIVE	2.76"	1.97"	ER32	.788"	16089	04616
46.122.32.400	CAT40 x ER32 - 4" DualDRIVE	4"	1.97"	ER32	.788"	16089	04616
46.122.32.600	CAT40 x ER32 - 6" DualDRIVE	6"	1.97"	ER32	.788"	16089	04616
NEW 46.122.32.800	CAT40 x ER32 - 8" DualDRIVE	8"	1.97"	ER32	.788"	16089	04616
46.122.40.315	CAT40 x ER40 - 3.15" DualDRIVE	3.15"	2.48"	ER40	1.023"	16091	04617
NEW 46.122.40.600	CAT40 x ER40 - 6" DualDRIVE	6"	2.48"	ER40	1.023"	16091	04617
NEW 46.122.40.800	CAT40 x ER40 - 8" DualDRIVE	8"	2.48"	ER40	1.023"	16091	04617

Blue indicates coolant.

Dual-Contact Spindles

Use Techniks DualDRIVE holders if your machine has a dual-contact spindle. Dual-Contact is a spindle option offered by some machine tool builders.

Dual-contact means both the toolholder taper and the flange make contact with the spindle. Dual-contact increases rigidity and accuracy during machining.

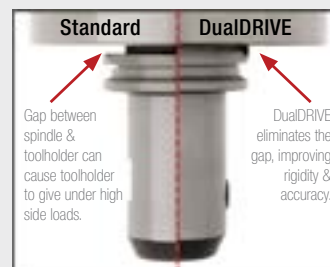

Gap between spindle & toolholder can cause toolholder to give under high side loads.

DualDRIVE eliminates the gap, improving rigidity & accuracy.



See our demonstration video of DualDRIVE at:
<http://ow.ly/sUOqL>

CAT50 Precision ER Toolholders



Techniks Certified for accuracy and balance
Each holder comes with a complete lab report

Features

- *Balanced to 25,000 RPM at G2.5*
- *T.I.R. 0.0001" measured from taper to collet pocket*
- *PowerCOAT nut included for 75% more clamping power*

For ER16 and 20 slotted nuts, add SLOTNUT to the end of the part number. For holders with coolant nut included add -C to the end of the part number. Coolant nuts are not available for ER50.

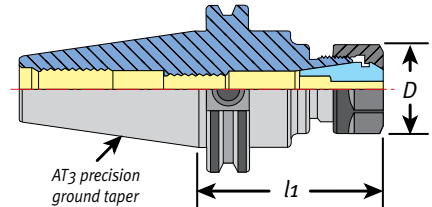

CAT50 ER Toolholders

Part No.	Description	l1	D	Max. Shank	Set Screw	Wrench
22281	CAT50 x ER16 - 4", hex nut	4"	1.08"	.406"	16083	04609
22285	CAT50 x ER16 - 6", hex nut	6"	1.08"	.406"	16083	04609
22287	CAT50 x ER16 - 8", hex nut	8"	1.08"	.406"	16083	04609
22291	CAT50 x ER20 - 4", hex nut	4"	1.34"	.512"	16087	04610
22293	CAT50 x ER20 - 6", hex nut	6"	1.34"	.512"	16087	04610
22295	CAT50 x ER20 - 8", hex nut	8"	1.34"	.512"	16087	04610
22303	CAT50 x ER25 - 4", slotted nut	4"	1.65"	.630"	16089	04615
22305	CAT50 x ER25 - 6", slotted nut	6"	1.65"	.630"	16089	04615
22307	CAT50 x ER25 - 8", slotted nut	8"	1.65"	.630"	16089	04615
22307-9	CAT50 x ER25 - 9", slotted nut	9"	1.65"	.630"	16089	04615
22311	CAT50 x ER32 - 4", slotted nut	4"	1.97"	.788"	16089	04616
22313	CAT50 x ER32 - 6", slotted nut	6"	1.97"	.788"	16089	04616
22317	CAT50 x ER32 - 8", slotted nut	8"	1.97"	.788"	16089	04616
22321	CAT50 x ER40 - 4", slotted nut	4"	2.48"	1.023"	16091	04617
22325	CAT50 x ER40 - 6", slotted nut	6"	2.48"	1.023"	16091	04617
22327	CAT50 x ER40 - 8", slotted nut	8"	2.48"	1.023"	16091	04617
22331	CAT50 x ER50 - 4", slotted nut	4"	3.07"	1.338"	16093	04618
22335	CAT50 x ER50 - 6", slotted nut	6"	3.07"	1.338"	16093	04618
22337	CAT50 x ER50 - 8", slotted nut	8"	3.07"	1.338"	16093	04618

Coolant Set Screws page 47.

CAT50 ER Tapered Style Toolholders (taper improves rigidity at extended lengths)

Part No.	Description	l1	D	Max. Shank	Set Screw	Wrench
NEW 22287-10T	CAT50 x ER16 - 10", hex nut	10"	1.08"	.406"	16083	04609
NEW 22287-12T	CAT50 x ER16 - 12", hex nut	12"	1.08"	.406"	16083	04609
NEW 22295-10T	CAT50 x ER20 - 10", hex nut	10"	1.34"	.512"	16087	04610
NEW 22295-12T	CAT50 x ER20 - 12", hex nut	12"	1.34"	.512"	16087	04610
NEW 22317-10T	CAT50 x ER32 - 10", slotted nut	10"	1.97"	.788"	16089	04616
NEW 22317-12T	CAT50 x ER32 - 12", slotted nut	12"	1.97"	.788"	16089	04616
NEW 22327-10T	CAT50 x ER40 - 10", slotted nut	10"	2.48"	1.023"	16091	04617



We stand behind all our products with our 100% Satisfaction Guarantee • www.techniksusa.com

CAT50 Precision CoolFLEX Toolholders



A PowerCOAT mini nut is included with each holder. Techniks Certified for accuracy and balance. Each holder comes with a complete lab report.

Features

- Coolant-thru spindle or thru flange (DIN B)
- Balanced to 25,000 RPM at G2.5
- T.I.R. 0.0001" or better from taper to collet pocket

For ER16 and 20 slotted nuts, add SLOTNUT to the end of the part number. For holders with coolant nut included add -C to the end of the part number. Coolant nuts are not available for ER50.



Collets
pg. 49



Nuts
pg. 64



Coolant
Rings
pg. 66



Retention
Knobs
pg. 228



Wrenches
pg. 232



Tightening
Stands
pg. 234

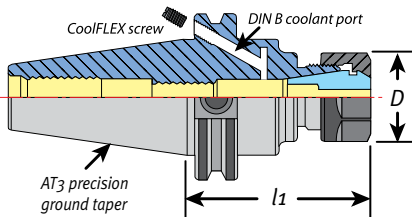

CoolFLEX Feature

CoolFLEX holders are factory set for coolant-thru spindle. Simply remove 2 stop screws for DIN B coolant-thru flange.

Part No.	Description
HSA-4-6	40 taper DIN B screw

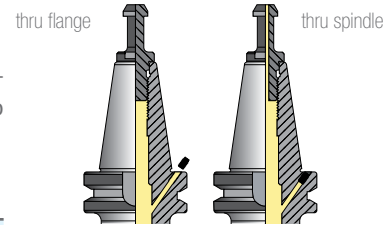

Coolant Set Screws page 47.

CAT50 CoolFLEX Coolant-Thru Spindle or Flange (DIN B)

Part No.	Description	l1	D	Max. Shank	Set Screw	Wrench
22281F	CAT50 x ER16 - 4", hex nut	4"	1.08"	.406"	16083	04609
22285F	CAT50 x ER16 - 6", hex nut	6"	1.08"	.406"	16083	04609
22291F	CAT50 x ER20 - 4", hex nut	4"	1.34"	.512"	16087	04610
22293F	CAT50 x ER20 - 6", hex nut	6"	1.34"	.512"	16087	04610
22295F	CAT50 x ER20 - 8", hex nut	8"	1.34"	.512"	16087	04610
22303F	CAT50 x ER25 - 4", slotted nut	4"	1.65"	.630"	16089	04615
22311F	CAT50 x ER32 - 4", slotted nut	4"	1.97"	.788"	16089	04616
22313F	CAT50 x ER32 - 6", slotted nut	6"	1.97"	.788"	16089	04616
22317F	CAT50 x ER32 - 8", slotted nut	8"	1.97"	.788"	16089	04616
22321F	CAT50 x ER40 - 4", slotted nut	4"	2.48"	1.023"	16091	04617
22327F	CAT50 x ER40 - 8", slotted nut	8"	2.48"	1.023"	16091	04617

Blue indicates coolant.

CAT50 Precision ER Mini Nut Holders



Features

- *Narrow nut diameter for better clearance*
- *Balanced to 25,000 RPM at G2.5*
- *T.I.R. 0.0001" measured from taper to collet pocket*



Collets
pg. 49



Nuts
pg. 64



Coolant
Rings
pg. 66



Retention
Knobs
pg. 228



Wrenches
pg. 232



Tightening
Stands
pg. 234

A PowerCOAT mini nut is included with each holder.
Techniks Certified for accuracy and balance.
Each holder comes with a complete lab report.



Coolant Options

- *ER coolant rings (pg. 66)*
- *ER Steel Sealed collets (pg. 56)*
- *ER Sealed coolant collets (pg. 58)*

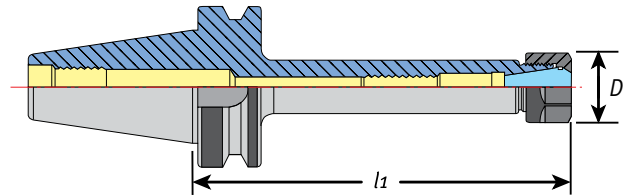

Coolant Set Screws page 47.

CAT50 ER Mini Nut Holders

Part No.	Description	l1	D	Max. Shank	Set Screw	Wrench
22364	CAT50 x ER16 - 4", mini nut	4"	.87"	.406"	16083	04622
22366	CAT50 x ER16 - 6", mini nut	6"	.87"	.406"	16083	04622
22368	CAT50 x ER20 - 4", mini nut	4"	1.102"	.512"	16087	04623
22370	CAT50 x ER20 - 6", mini nut	6"	1.102"	.512"	16087	04623

CAT50 Precision ER32 SuperRIGID Holders



Techniks Certified for accuracy and balance.
Each holder comes with a complete lab report.
Collet nut is included with each holder.

Features

- *Balanced to 25,000 RPM at G2.5*
- *Best T.I.R. and Z axis of any collet chuck*
- *SuperRIGID for high torque or high speed machining*



Use SuperRIGID holders with ER32 collets.

SuperRIGID Holders

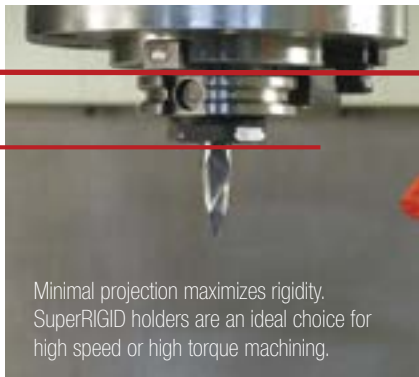

minimum
projection

Minimal projection maximizes rigidity.
SuperRIGID holders are an ideal choice for
high speed or high torque machining.

Standard Holders

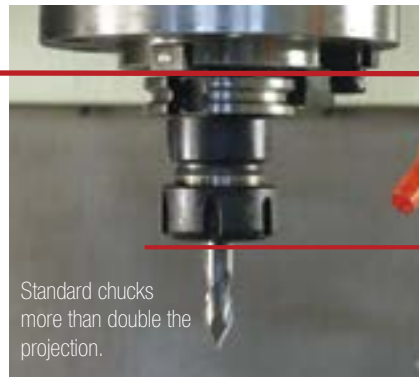

standard
projection

Standard chucks
more than double the
projection.

Minimum projection = increased rigidity, better T.I.R. and extended cutter life.

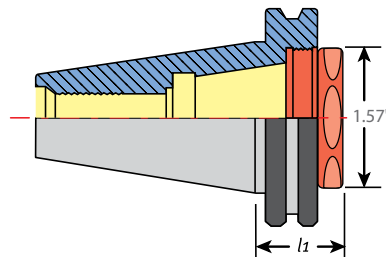

PowerCOAT
TE-22HN Nut

CAT50 SuperRIGID ER Toolholders

Part No.	Description	l1	Collet	Max. Shank	Wrench
22311S	CAT50 x ER32	1.10"	ER32	3/4" or 20mm	894-36
TE-22HN	hex style PowerCOAT nut				

CAT50 DualDRIVE for Dual-Contact Spindles



PowerCOAT nut is included with each holder
 Techniks Certified for accuracy and balance
 Each holder comes with a complete lab report

Features

- New one-piece design for dual-contact spindles
- Coolant-thru spindle or thru flange (DIN B)
- Balanced to 25,000 RPM at G2.5

Benefits

- Better rigidity and reduced vibration
- Improved performance at high metal removal rates and when machining at extended lengths

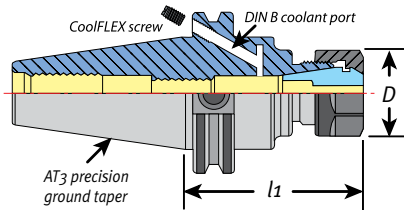

CoolFLEX Feature

CoolFLEX holders are factory set for coolant-thru spindle. Simply remove 2 stop screws for DIN B coolant-thru flange.

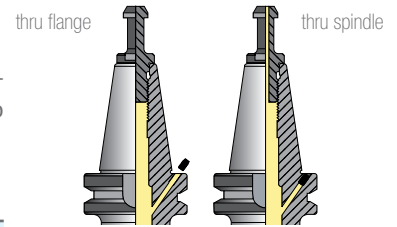

Part No. Description

HSA-4-6	40 taper DIN B screw
---------	----------------------

Coolant Set Screws page 47.

CAT50 ER DualDRIVE Coolant-Thru Spindle or Flange (DIN B)

Part No.	Description - l1	l1	D	Collet	Max. Shank	Set Screw	Wrench
47.122.16.400	CAT50 x ER16 - 4" DualDRIVE	4"	1.08"	ER16	.406"	16083	04609
47.122.16.600	CAT50 x ER16 - 6" DualDRIVE	6"	1.08"	ER16	.406"	16083	04609
47.122.16.800	CAT50 x ER16 - 8" DualDRIVE	8"	1.08"	ER16	.406"	16083	04609
NEW 47.122.20.400	CAT50 x ER20 - 4" DualDRIVE	4"	1.34"	.512"	16087	04610	
NEW 47.122.20.600	CAT50 x ER20 - 6" DualDRIVE	6"	1.34"	.512"	16087	04610	
NEW 47.122.20.800	CAT50 x ER20 - 8" DualDRIVE	8"	1.34"	.512"	16087	04610	
47.122.32.400	CAT50 x ER32 - 4" DualDRIVE	4"	1.97"	ER32	.788"	16089	04616
47.122.32.600	CAT50 x ER32 - 6" DualDRIVE	6"	1.97"	ER32	.788"	16089	04616
47.122.32.800	CAT50 x ER32 - 8" DualDRIVE	8"	1.97"	ER32	.788"	16089	04616
47.122.40.400	CAT50 x ER40 - 4" DualDRIVE	4"	2.48"	ER40	1.023"	16091	04617
NEW 47.122.40.600	CAT50 x ER40 - 6" DualDRIVE	6"	2.48"	1.023"	16091	04617	
NEW 47.122.40.800	CAT50 x ER40 - 8" DualDRIVE	8"	2.48"	1.023"	16091	04617	

Blue indicates coolant.

Dual-Contact Spindles

Use Techniks DualDRIVE holders if your machine has a dual-contact spindle. Dual-Contact is a spindle option offered by some machine tool builders.

Dual-contact means both the toolholder taper and the flange make contact with the spindle. Dual-contact increases rigidity and accuracy during machining.

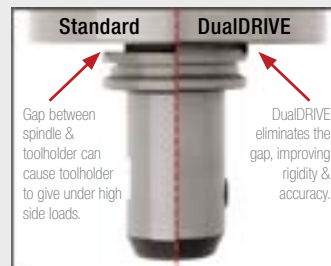

See our demonstration video of DualDRIVE at:
<http://ow.ly/sUOqL>



BT30 Precision ER Toolholders & Mini Nut Holders



Techniks Certified for accuracy and balance
Each holder comes with a complete lab report

BT30 Features

- *Balanced to 25,000 RPM at G2.5*
- *T.I.R. 0.0001" measured from taper to collet pocket*
- *Taper ground to AT3 accuracy or better*

For ER16 and 20 slotted nuts, add SLOTNUT to the end of the part number. For holders with coolant nut included add -C to the end of the part number. Coolant nuts are not available for ER50.

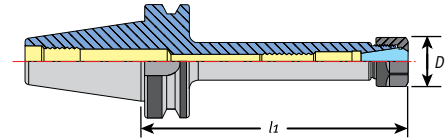

BT30 Precision ER Toolholders

Part No.	Description	L1	D	Max. Shank	Set Screw	Wrench
16102	BT30 x ER16 - 60mm, hex nut	60mm	1.08"	.406"	16083	04609
16101	BT30 x ER16 - 70mm, hex nut	70mm	1.08"	.406"	16083	04609
16103	BT30 x ER16 - 90mm, hex nut	90mm	1.08"	.406"	16083	04609
16104	BT30 x ER16 - 100mm, hex nut	100mm	1.08"	.406"	16083	04609
16105	BT30 x ER16 - 120mm, hex nut	120mm	1.08"	.406"	16083	04609
16106	BT30 x ER20 - 70mm, hex nut	70mm	1.34"	.512"	16087	04610
16107	BT30 x ER20 - 135mm, hex nut	135mm	1.34"	.512"	16087	04610
16108-2.5	BT30 x ER20 - 63.5mm, hex nut	63.5mm	1.34"	.512"	16087	04610
16109	BT30 x ER25 - 70mm, slotted nut	70mm	1.65"	.63"	16089	04615
16110	BT30 x ER25 - 60mm, slotted nut	60mm	1.65"	.63"	16089	04615
16111-90	BT30 x ER25 - 90mm, slotted nut	90mm	1.65"	.63"	16089	04615
16111	BT30 x ER25 - 135mm, slotted nut	135mm	1.65"	.63"	16089	04615
16112	BT30 x ER32 - 60mm, slotted nut	60mm	1.97"	.788"	16089	04616
16113	BT30 x ER32 - 70mm, slotted nut	70mm	1.97"	.788"	16089	04616
16114	BT30 x ER32 - 100mm, slotted nut	100mm	1.97"	.788"	16089	04616
16115	BT30 x ER40 - 80mm, slotted nut	80mm	2.48"	1.023"	16089	04617



BT30 Precision ER Mini Nut Holders

BT Mini Nut Features

- *Narrow nut diameter for better clearance*
- *Balanced to 25,000 RPM at G2.5*
- *T.I.R. 0.0001" measured from taper to collet pocket*

For coolant applications use ER16 or ER20 coolant mini nut (pg. 65)
Coolant Set Screws page 47.

Part No.	Description	L1	D	Max. Shank	Set Screw	Wrench
16302	BT30 x ER11 - 70mm, mini nut	70	.63"	.275"	16081	04621
16304	BT30 x ER11 - 100mm, mini nut	100mm	.63"	.275"	16081	04621
16308	BT30 x ER16 - 70mm, mini nut	70mm	.87"	.406"	16083	04622
16312	BT30 x ER16 - 120mm, mini nut	120mm	.87"	.406"	16083	04622
16313	BT30 x ER20 - 70mm, mini nut	70mm	1.102"	.512"	16087	04623
16314	BT30 x ER20 - 100mm, mini nut	100mm	1.102"	.512"	16087	04623
16318	BT30 x ER20 - 150mm, mini nut	150mm	1.102"	.512"	16087	04623

BT30 DualDRIVE for Dual-Contact Spindles



PowerCOAT nut is included with each holder
Techniks Certified for accuracy and balance
Each holder comes with a complete lab report

Features

- New one-piece design for dual-contact spindles
- Improves rigidity and reduces vibration
- Balanced to 25,000 RPM at G2.5

Benefits

- Better rigidity and reduced vibration
- Improved performance at high metal removal rates and when machining at extended lengths



Collets
pg. 49



Nuts
pg. 64



Coolant
Rings
pg. 66



Retention
Knobs
pg. 228



Wrenches
pg. 232



Tightening
Stands
pg. 234



Coolant Options

- ER coolant rings (pg. 66)
- ER Steel Sealed collets (pg. 56)
- ER Sealed coolant collets (pg. 58)

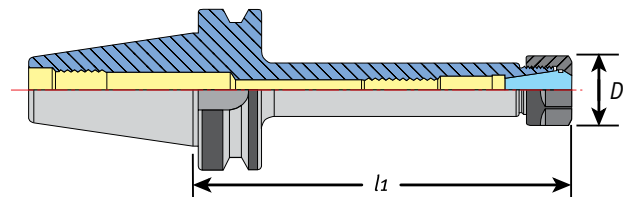

BT30 ER DualDRIVE Toolholders

Part No.	Description - l1	l1	D	Collet	Max. Shank	Set Screw	Wrench
25.122.16.060	BT30 x ER16 - 60mm DualDRIVE	60mm	27.43mm	ER16	.406"	16083	04609
25.122.16.090	BT30 x ER16 - 90mm DualDRIVE	90mm	27.43mm	ER16	.406"	16083	04609
25.122.16.105	BT30 x ER16 - 105mm DualDRIVE	105mm	27.43mm	ER16	.406"	16083	04609
25.122.20.105	BT30 x ER20 - 105mm DualDRIVE	105mm	34.04mm	ER20	.512"	16087	04610
25.122.20.060	BT30 x ER20 - 60mm DualDRIVE	60mm	34.04mm	ER20	.512"	16087	04610
25.122.20.090	BT30 x ER20 - 90mm DualDRIVE	90mm	34.04mm	ER20	.512"	16087	04610
25.122.25.060	BT30 x ER25 - 60mm DualDRIVE	60mm	41.91mm	ER25	.63"	16089	04615
25.122.32.060	BT30 x ER32 - 60mm DualDRIVE	60mm	50.04mm	ER32	.788"	16089	04616
25.122.32.090	BT30 x ER32 - 90mm DualDRIVE	90mm	50.04mm	ER32	.788"	16089	04616
25.122.40.080	BT30 x ER40 - 80mm DualDRIVE	80mm	62.99mm	ER40	1.023"	16091	04617

Coolant Set Screws page 47.

Dual-Contact Spindles

Use Techniks DualDRIVE holders if your machine has a dual-contact spindle. Dual-Contact is a spindle option offered by some machine tool builders.

Dual-contact means both the toolholder taper and the flange make contact with the spindle. Dual-contact increases rigidity and accuracy during machining.

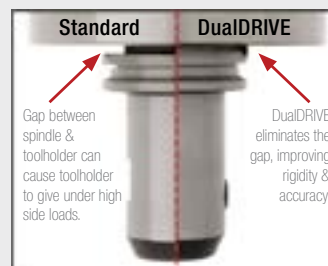

See our demonstration video of DualDRIVE at:
<http://ow.ly/sUOqL>



BT40 Precision ER Toolholders



Techniks Certified for accuracy and balance.
Each holder comes with a complete lab report.
A PowerCOAT nut is included with each holder.

Features

- *Balanced to 25,000 RPM at G2.5*
- *T.I.R. 0.0001" measured from taper to collet pocket*
- *PowerCOAT nut included for 75% more clamping power*

For ER16 and 20 slotted nuts, add SLOTNUT to the end of the part number. For holders with coolant nut included add -C to the end of the part number. Coolant nuts are not available for ER50.



Collets
pg. 49



Nuts
pg. 64



Coolant
Rings
pg. 66



Retention
Knobs
pg. 228



Wrenches
pg. 232



Tightening
Stands
pg. 234



Coolant Options

- *ER coolant rings (pg. 66)*
- *ER Steel Sealed collets (pg. 56)*
- *ER Sealed coolant collets (pg. 58)*

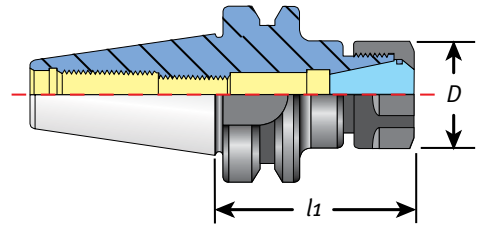

BT40 ER Toolholders

Part No.	Description	l1	D	Max. Shank	Set Screw	Wrench
16151	BT40 x ER16 - 70mm, hex nut	70mm	1.08"	.406"	16083	04609
16153	BT40 x ER16 - 100mm, hex nut	100mm	1.08"	.406"	16083	04609
16155	BT40 x ER16 - 125mm, hex nut	125mm	1.08"	.406"	16083	04609
16157	BT40 x ER16 - 150mm, hex nut	150mm	1.08"	.406"	16083	04609
16158	BT40 x ER16 - 180mm, hex nut	180mm	1.08"	.406"	16083	04609
16159	BT40 x ER20 - 70mm, hex nut	70mm	1.34"	.512"	16085	04610
16162	BT40 x ER20 - 100mm, hex nut	100mm	1.34"	.512"	16085	04610
16165	BT40 x ER20 - 135mm, hex nut	135mm	1.34"	.512"	16085	04610
16167	BT40 x ER20 - 150mm, hex nut	150mm	1.34"	.512"	16085	04610
16169	BT40 x ER25 - 70mm, slotted nut	70mm	1.65"	.630"	16089	04615
16171	BT40 x ER25 - 100mm, slotted nut	100mm	1.65"	.630"	16089	04615
16175	BT40 x ER25 - 150mm, slotted nut	150mm	1.65"	.630"	16089	04615
16177	BT40 x ER32 - 70mm, slotted nut	70mm	1.97"	.788"	16089	04616
16179	BT40 x ER32 - 100mm, slotted nut	100mm	1.97"	.788"	16089	04616
16181	BT40 x ER32 - 150mm, slotted nut	150mm	1.97"	.788"	16089	04616
161	BT40 x ER32 - 200mm, slotted nut	200mm	1.97"	.788"	16089	04616
16183	BT40 x ER40 - 80mm, slotted nut	80mm	2.48"	1.023"	16089	04617
16185	BT40 x ER40 - 100mm, slotted nut	100mm	2.48"	1.023"	16089	04617
16189	BT40 x ER40 - 150mm, slotted nut	150mm	2.48"	1.023"	16089	04617

BT40 Precision ER CoolFLEX Toolholders



Techniks Certified for accuracy and balance. Each holder comes with a complete lab report. A PowerCOAT nut is included with each holder.

Features

- Balanced to 25,000 RPM at G2.5
- Coolant-thru spindle or thru flange (DIN B)
- T.I.R. 0.0001" or better from taper to collet pocket

For ER16 and 20 slotted nuts, add SLOTNUT to the end of the part number. For holders with coolant nut included add -C to the end of the part number. Coolant nuts are not available for ER50.



Collets
pg. 49



Nuts
pg. 64



Coolant
Rings
pg. 66



Retention
Knobs
pg. 228



Wrenches
pg. 232



Tightening
Stands
pg. 234

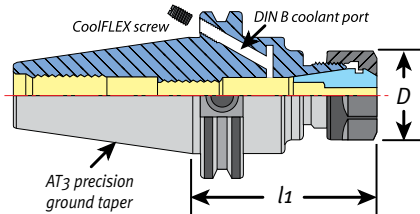

CoolFLEX Feature

CoolFLEX holders are factory set for coolant-thru spindle. Simply remove 2 stop screws for DIN B coolant-thru flange.

Part No.	Description
HSA-4-6	40 taper DIN B screw

thru flange

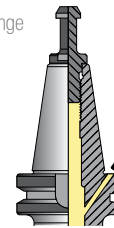

thru spindle

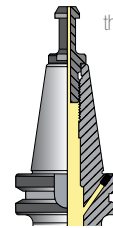

Coolant Set Screws page 47.

BT40 CoolFLEX Coolant -Thru Spindle or Flange (DIN B)

Part No.	Description	l1	D	Max. Shank	Set Screw	Wrench
16151F	BT40 x ER16 - 70mm, hex nut, CoolFLEX	70mm	1.08"	.406"	16083	04609
16153F	BT40 x ER16 - 100mm, hex nut, CoolFLEX	100mm	1.08"	.406"	16083	04609
16157F	BT40 x ER16 - 150mm, hex nut, CoolFLEX	150mm	1.08"	.406"	16083	04609
16159F	BT40 x ER20 - 70mm, hex nut, CoolFLEX	70mm	1.34"	.512"	16085	04610
16162F	BT40 x ER20 - 100mm, hex nut, CoolFLEX	100mm	1.34"	.512"	16085	04610
16167F	BT40 x ER20 - 150mm, hex nut, CoolFLEX	150mm	1.34"	.512"	16085	04610
16177F	BT40 x ER32 - 70mm, slotted, CoolFLEX	70mm	1.97"	.788"	16089	04616
16181F	BT40 x ER32 - 150mm, slotted, CoolFLEX	150mm	1.97"	.788"	16089	04616

Blue indicates coolant.



BT40 Precision ER Mini Nut Holders



Features

- Balanced to 25,000 RPM at G2.5
- T.I.R. 0.0001" measured from taper to collet pocket
- Taper ground to AT3 accuracy or better



PowerCOAT nut is included with each holder
Techniks Certified for accuracy and balance
Each holder comes with a complete lab report



Collets
pg. 49



Nuts
pg. 64



Coolant
Rings
pg. 66



Retention
Knobs
pg. 228



Wrenches
pg. 232



Tightening
Stands
pg. 234



Coolant Options

- ER coolant rings (pg. 66)
- ER Steel Sealed collets (pg. 56)
- ER Sealed coolant collets (pg. 58)

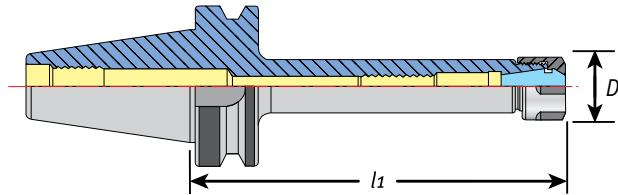

BT40 ER Mini Nut Holders

Part No.	Description	l1	D	Max. Shank	Set Screw	Wrench
16321	BT40 x ER11 - 70mm, mini nut	70mm	16mm	.275"	16081	04621
16324	BT40 x ER11 - 150mm, mini nut	150mm	16mm	.275"	16081	04621
16325	BT40 x ER16 - 70mm, mini nut	70mm	22mm	.406"	16083	04622
16328	BT40 x ER16 - 150mm, mini nut	150mm	22mm	.406"	16083	04622
16328-200	BT40 x ER16 - 200mm, mini nut	200mm	22mm	.406"	16083	04622
16329	BT40 x ER20 - 70mm, mini nut	70mm	28mm	.512"	16087	04623
16330	BT40 x ER20 - 100mm, mini nut	100mm	28mm	.512"	16087	04623
16332	BT40 x ER20 - 150mm, mini nut	150mm	28mm	.512"	16087	04623

Coolant Set Screws page 47.

BT40 Precision SuperRIGID Holders



Features

- *Balanced to 25,000 RPM at G2.5*
- *Best T.I.R. and Z axis of any collet chuck*
- *SuperRIGID for high torque or high speed machining*



Techniks Certified for accuracy and balance
 Each holder comes with a complete lab report
 Collet nut is included with each holder

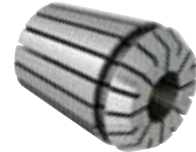

Use SuperRIGID holders with ER32 collets.

SuperRIGID Holders

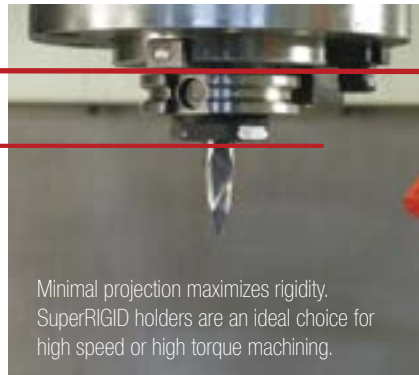

minimum projection

Minimal projection maximizes rigidity. SuperRIGID holders are an ideal choice for high speed or high torque machining.

Standard Holders

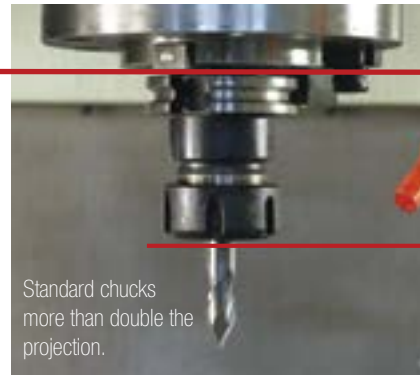

standard projection

Standard chucks more than double the projection.

Minimum projection = increased rigidity, better T.I.R. and extended cutter life.

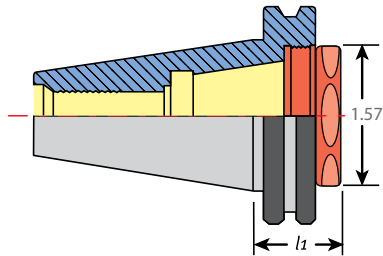

PowerCOAT
TE-22HN Nut

BT40 SuperRIGID ER Toolholders

Part No.	Description	l1	Collet	Max. Shank	Wrench
16177S	BT40 x ER32	36mm	ER32	3/4" or 20mm	894-36
TE-22HN	hex style PowerCOAT nut				



BT50 Precision ER Toolholders



Techniks Certified for accuracy and balance. Each holder comes with a complete lab report. A PowerCOAT nut is included with each holder.

Features

- *Balanced to 25,000 RPM at G2.5*
- *T.I.R. 0.0001" measured from taper to collet pocket*
- *PowerCOAT nut included for 75% more clamping power*

For ER16 and 20 slotted nuts, add SLOTNUT to the end of the part number. For holders with coolant nut included add -C to the end of the part number. Coolant nuts are not available for ER50.



Collets
pg. 49



Nuts
pg. 64



Coolant
Rings
pg. 66



Retention
Knobs
pg. 228



Wrenches
pg. 232



Tightening
Stands
pg. 234



Coolant Options

- *ER coolant rings (pg. 66)*
- *ER Steel Sealed collets (pg. 56)*
- *ER Sealed coolant collets (pg. 58)*

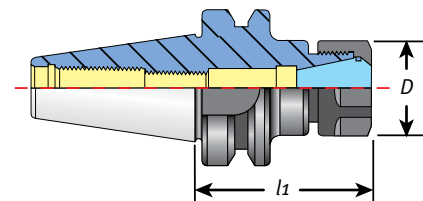

Coolant Set Screws page 47.

BT50 Precision Toolholders

Part No.	Description	l1	D	Max. Shank	Set Screw	Wrench
16251	BT50 x ER16 - 70mm, hex nut	70mm	1.08"	.406"	16083	04609
16252	BT50 x ER16 - 90mm, hex nut	90mm	1.08"	.406"	16083	04609
16253	BT50 x ER16 - 105mm, hex nut	105mm	1.08"	.406"	16083	04609
16254	BT50 x ER16 - 135mm, hex nut	135mm	1.08"	.406"	16083	04609
16255	BT50 x ER16 - 150mm, hex nut	150mm	1.08"	.406"	16083	04609
16263	BT50 x ER20 - 90mm, hex nut	90mm	1.34"	.512"	16087	04610
16265	BT50 x ER20 - 105mm, hex nut	105mm	1.34"	.512"	16087	04610
16267	BT50 x ER20 - 135mm, hex nut	135mm	1.34"	.512"	16087	04610
16271	BT50 x ER20 - 165mm, hex nut	165mm	1.34"	.512"	16087	04610
16275	BT50 x ER25 - 105mm, slotted nut	105mm	1.65"	.630"	16089	04615
16277	BT50 x ER25 - 135mm, slotted nut	135mm	1.65"	.630"	16089	04615
16279	BT50 x ER25 - 165mm, slotted nut	165mm	1.65"	.630"	16089	04615
16281	BT50 x ER32 - 80mm, slotted nut	80mm	1.97"	.788"	16089	04616
16283	BT50 x ER32 - 120mm, slotted nut	120mm	1.97"	.788"	16089	04616
16284	BT50 x ER32 - 150mm, slotted nut	150mm	1.97"	.788"	16089	04616
16285	BT50 x ER40 - 80mm, slotted nut	80mm	2.48"	1.023"	16091	04617
16289	BT50 x ER40 - 135mm, slotted nut	135mm	2.48"	1.023"	16091	04617
06291	BT50 x ER50 - 90mm, slotted nut	90mm	3.07"	1.338"	16093	04618

HSK32A, 40A, 50A, 63A Precision ER Toolholders



Techniks Certified for accuracy and balance.
Each holder comes with a complete lab report.
A PowerCOAT nut is included with each holder.

Features

- Balanced to 25,000 RPM at G2.5
- T.I.R. 0.0001" measured from taper to collet pocket
- PowerCOAT nut included for 75% more clamping power

For ER16 and 20 slotted nuts, add SLOTNUT to the end of the part number. For holders with coolant nut included add -C to the end of the part number. Coolant nuts are not available for ER50.

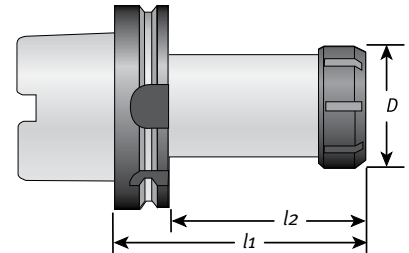

HSK32A, 40A, 50A, Toolholders

Part No.	Description	l1	l2	D	Wrench
31278	HSK32A x ER20 - 80mm, slotted nut	80mm	60mm	34mm	04614
31284	HSK32A x ER25 - 80mm, mini nut	80mm	60mm	35mm	04624
31374	HSK40A x ER11 - 80mm, mini nut	80mm	60mm	16mm	04621
31376	HSK40A x ER16 - 80mm, hex nut	80mm	54mm	28mm	04609
31384	HSK40A x ER25 - 80mm, slotted nut	80mm	60mm	35mm	04624
31385	HSK40A x ER32 - 80mm, slotted nut	80mm	60mm	50mm	04616
31420	HSK50A x ER32 - 100mm, slotted nut	100mm	74mm	50mm	04616

HSK63A Toolholders

Part No.	Description	l1	l2	D	Wrench
NEW 31430	HSK63A x ER11 - 100mm, mini nut	100mm	74mm	16mm	04621
31432	HSK63A x ER16 - 80mm, hex nut	80mm	54mm	28mm	04609
31434	HSK63A x ER16 - 100mm, hex nut	100mm	74mm	28mm	04609
31438	HSK63A x ER16 - 160mm, hex nut	160mm	134mm	28mm	04609
31440	HSK63A x ER20 - 80mm, hex nut	80mm	54mm	34mm	04610
31446	HSK63A x ER20 - 160mm, hex nut	160mm	134mm	34mm	04610
31462	HSK63A x ER32 - 100mm, slotted nut	100mm	74mm	50mm	04616
NEW 31466	HSK63A x ER32 - 160mm, slotted nut	160mm	134mm	50mm	04616
NEW 31466-8T	HSK63A x ER32 - 8", tapered style, slot nut	8"	134mm	50mm	04616
31468	HSK63A x ER40 - 80mm, slotted nut	80mm	54mm	63mm	04617
31472	HSK63A x ER40 - 120mm, slotted nut	120mm	94mm	63mm	04617
NEW 31476-8T	HSK63A x ER40 - 8", tapered style, slot nut	8"	94mm	63mm	04617

(Part Numbers with a -8T suffix indicate tapered style holder. Taper improves rigidity at extended lengths)



HSK100A Precision ER Toolholders



Features

- *Balanced to 25,000 RPM at G2.5*
- *T.I.R. 0.0001" measured from taper to collet pocket*
- *PowerCOAT nut included for 75% more clamping power*

For ER16 and 20 slotted nuts, add SLOTNUT to the end of the part number. For holders with coolant nut included add -C to the end of the part number. Coolant nuts are not available for ER50.



Techniks Certified for accuracy and balance. Each holder comes with a complete lab report. A PowerCOAT nut is included with each holder.

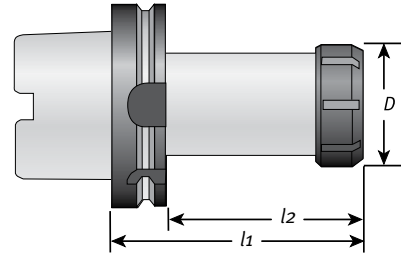

HSK100A Toolholders

Part No.	Description	l1	l2	D	Wrench
31484	HSK100A x ER16 - 100mm, hex nut	100mm	74mm	28mm	04609
31486	HSK100A x ER16 - 160mm, hex nut	160mm	134mm	28mm	04609
31490	HSK100A X ER20 - 100mm, hex nut	100mm	74mm	34mm	04610
31492	HSK100A X ER20 - 160mm, hex nut	160mm	134mm	34mm	04610
31494	HSK100A X ER25 -100mm, slotted nut	100mm	74mm	35mm	04624
31498	HSK100A x ER32 - 100mm, slotted nut	100mm	71mm	50mm	04616
31503	HSK100A x ER32 - 160mm, slotted nut	160mm	134mm	50mm	04616
31506	HSK100A x ER40 - 120mm, slotted nut	120mm	91mm	63mm	04617

HSKA Coolant Pipe and Wrench for HSKA and HSKE

Part No.	Description	HSK-AE	D	T	Wrench
92002	Coolant Pipe	40	8mm	M12 x 1	91.11.026.002
92003	Coolant Pipe	50	10mm	M16 x 1	92.11.026.003
92004	Coolant Pipe	63	12mm	M18 x 1	93.11.026.004
92005	Coolant Pipe	100	16mm	M24 x 1.5	95.11.026.005

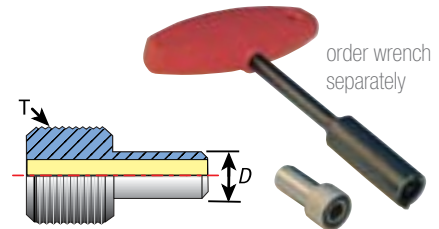

ISO & SK Holders for CNC Routers



Techniks Certified for accuracy and balance
Each holder comes with a complete lab report

Features

- *Balanced up to 40,000 RPM at G2.5*
- *T.I.R. 0.0001" or better from taper to collet pocket*
- *PowerCOAT nut and retention knob included*

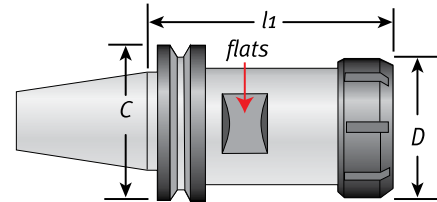

ISO 20 and ISO 25 Toolholders for CNC Routers

Part No.	Description	l1	C	D	Nut	Wrench	Flats
16000-2016MC	*ISO 20 x ER16 - 52mm, HS mini nut & pull stud	52mm	30mm	22mm	53116	04622	17
16000-2516	ISO 20 x ER16 - 52mm, slotted nut & pull stud	52mm	30mm	32mm	46116	04613	17
16000-2520	ISO 20 x ER20 - 52mm, slotted nut & pull stud	52mm	30mm	35mm	46120	04614	17
12194-ISO25	ISO 25 x ER25 - 50mm, slotted nut & pull stud	50mm	38mm	42mm	46125	04615	27
25077	ISO 25 x ER25 - 65mm, slotted nut & pull stud	65mm	38mm	42mm	23111	04615	27

*Balanced to 40,000 RPM. Use for Haas OM-1A, OM-2A Office Mills.

Haas is trademark of Haas Automation and used here for identification only.



Taper ground to AT3 accuracy or better
Techniks Certified for accuracy and balance

Features

- *Balanced to 25,000 RPM at G2.5*
- *T.I.R. 0.0001" or better from taper to collet pocket*
- *PowerCOAT nut included for 75% more clamping power*

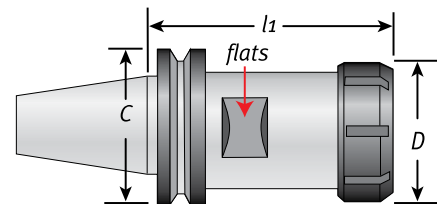

ISO 30 and SK 30 Toolholders for CNC Routers

Part No.	Description	l1	C	D	Nut	Wrench	Flats
42407-W	ISO 30 x ER11 - 100mm, mini nut	100mm	50mm	16mm	23111	04621	14
42213-W-50	ISO 30 x ER32 - 50mm, slotted nut	50mm	50mm	50mm	46132	04616	47
42213-W-63	ISO 30 x ER32 - 63mm, slotted nut	63mm	50mm	50mm	46132	04616	36
42213-W-90	ISO 30 x ER32 - 90mm, slotted nut	90mm	50mm	50mm	46132	04616	36
12000-CMS	ISO 30 x ER32 - CMS toolholder	58mm	46mm	50mm	46132	04616	36
12040-CMS	ISO 30 x ER40 - CMS toolholder	66mm	46mm	63mm	46140	04617	42
42215-W-57	ISO 30 x ER40 - 57mm, slotted nut	57mm	50mm	63mm	46140	04617	47
42261-W	ISO 40 x ER40 - 70mm, slotted nut	70mm	63.55mm	63mm	46140	04617	46
NT-54300130	SK-30 x SYOZ 25 toolholder	63mm	50mm	60mm	83632	03691	38



BT30 & BT35 Holders for CNC Routers



PowerCOAT nut is included with each holder
Techniks Certified for accuracy and balance
Each holder comes with a complete lab report

Features

- Balanced to 25,000 RPM at G2.5
- T.I.R. 0.0001" measured from taper to collet pocket
- PowerCOAT nut included for 75% more clamping power

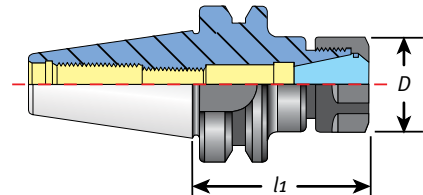

Coolant Set Screws page 47.

BT30, ER Toolholders

Part No.	Description	l1	D	Collet Nut	Set Screw	Wrench
16106-W	BT30 x ER20 - 70 without slots	70mm	34mm	41120	16087	04614
16121	BT30 x ER32 - 60, 41mm flats - Komo	60mm	50mm	46132	16089	04616
16131	BT30 x ER32 - 90 38mm flats - Komo	90mm	50mm	46132	16089	04616

BT30, SYOZ 25 Toolholders

Part No.	Description	l1	D	Collet Nut	Wrench
16001-W	BT30 x SYOZ 25 - 70, 38mm flats	70mm	60mm	83632	03691
16001	BT30 x SYOZ 25 - 70 with nut	70mm	60mm	83632	03691

BT 35, ER32, SYOZ 25 Toolholders for Heian Routers

Part No.	Description	l1	D	Collet Nut	Wrench
16010	BT 35 x SYOZ 25 - 76 with nut	76mm	60mm	83632	03691
161-BT35-ER32 76	BT 35 x ER32 - 76	76mm	50mm	46132	04616



Scan the QR code with a smartphone or enter this url: <http://ow.ly/rKs6W> to request our new CNC Router Tooling catalog. Or call us at 800.597.3921 to have it sent to you.



HSKE & HSKF Holders for CNC Routers



Techniks Certified for accuracy and balance

Features

- Balanced to 25,000 RPM at G2.5
- T.I.R. 0.0001" measured from taper to collet pocket
- PowerCOAT nut included for 75% more clamping power

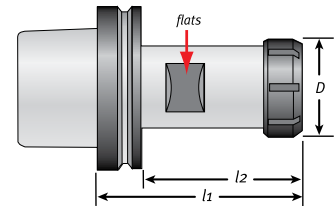

Coolant Set Screws page 47.

HSK32E, 40E, 50E, 63E Toolholders for HSK E Type Spindle

Part No.	Description	l1	l2	D	Nut	Set Screw	Wrench	Flats
31374-60-E	HSK32E x ER25 - 60mm, slotted nut	60mm	27mm	42mm	46125	16089	04615	22mm
31376-E	HSK40E x ER16 - 65mm, slotted nut	65mm	45mm	32mm	46116	16083	04613	24mm
31383-E	HSK40E x ER25 - 75mm, slotted nut	75mm	55mm	42mm	46125	16089	04615	27mm
31386-E	HSK40E x ER32 - 100mm, slotted nut	100mm	80mm	50mm	46132	16089	04616	35mm
31402-E	HSK50E x ER16 - 80mm, slotted nut	80mm	60mm	28mm	46116	16083	04613	27mm
31419-E	HSK50E x ER32 - 85mm, slotted nut	85mm	59mm	50mm	46132	16089	04616	36mm
31456-E	HSK63E x ER32 - 90mm, slotted nut	90mm	64mm	50mm	46132	16089	04616	36mm
31472-E	HSK63E x ER40 - 120mm, slotted nut	120mm	94mm	63mm	46140	16091	04617	46mm
50001	HSK63E x ER40 -75mm, slotted nut	75mm	49mm	63mm	46140	16091	04617	46mm



Techniks Certified for accuracy and balance

Features

- Balanced to 25,000 RPM at G2.5
- T.I.R. 0.0001" measured from taper to collet pocket
- PowerCOAT nut included for 75% more clamping power

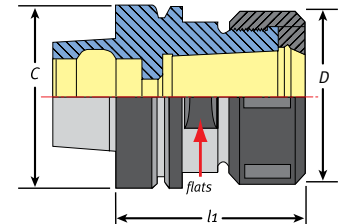

HSK50F, 63F Toolholders for CNC Routers

Part No.	Description	l1	D	Nut	Wrench	Flats
31419-F	HSK50F x ER32 - 80mm, slotted nut	80mm	50mm	46132	04616	36mm
103.123.11.100	HSK63F x ER11 - 100mm	100mm	16mm	23111	04621	-
31431-F	HSK63F x ER16 - 60mm, slotted nut	60mm	32mm	46116	04613	26mm
31434-F	HSK63F x ER16 - 100mm, slotted nut	100mm	32mm	46116	04613	26mm
30000	HSK63F x ER32 - 70mm, slotted nut	70mm	50mm	46132	04616	36mm
30001	HSK63F x ER40 - 75mm, slotted nut	75mm	63mm	46140	04617	46mm
30001-L	HSK63F x ER40 - 75mm, left-hand thread	75mm	63mm	46140-L	04617	46mm
30001-Solid	HSK63F x ER40 - 75mm, No thru hole	75mm	63mm	46140	04617	46mm
30002	HSK63F x ER40 - 90mm, slotted nut	90mm	63mm	46140	04617	46mm
30003	HSK63F x ER40 - 115mm, slotted nut	115mm	63mm	46140	04617	46mm
30005	HSK63F x ER40 - 125mm, slotted nut	125mm	63mm	46140	04617	46mm
31025F	HSK63 F x SYOZ 25 - 80mm, slotted nut	80mm	60mm	83632	03691	38mm



We stand behind all our products with our 100% Satisfaction Guarantee • www.techniksusa.com

Precision ER Mini-Nut & Straight Shank Extensions



Features

- Collet pocket T.I.R. 0.0001"
- PowerCOAT Nut included

For shank sizes 1/8" (3mm) or smaller use our DNA (dead nuts accurate) collets for best results (pg 48).

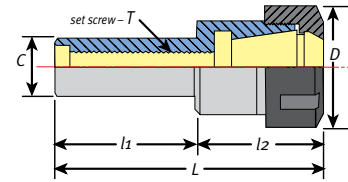

Coolant Set Screws page 47.

ER Straight Shank Extensions

Part No.	Description	C	L	l1	l2	D	Set Screw	Wrench
04851	16mm x ER11, - 140mm, hex nut	16mm	174.5mm	140mm	21.6mm	19mm	-	04608
04855	1/2" x ER11, - 140mm, hex nut	1/2"	174.5mm	140mm	21.6mm	19mm	-	04608
04854	5/8" x ER11, - 140mm, hex nut	5/8"	174.5mm	140mm	21.6mm	19mm	-	04608
04832	5/8" x ER16, - 60mm, hex nut	5/8"	95.1mm	60mm	35.1mm	28mm	-	04609
04834	3/4" x ER16, - 50mm, hex nut	3/4"	85.1mm	50mm	35.1mm	28mm	16083	04609
04835	3/4" x ER16, - 100mm, hex nut	3/4"	135.1mm	100mm	35.1mm	28mm	16083	04609
04856	3/4" x ER16, - 140mm, hex nut	3/4"	175.1mm	140mm	35.1mm	28mm	16083	04609
04836-2.5	3/4" x ER20, - 2-1/2", hex nut	3/4"	100mm	2-1/2"	38mm	34mm	16083	04610
04858	1.0" x ER20, - 140mm, hex nut	1.0"	180.5mm	140mm	40.5mm	34mm	16083	04610
04837	1.0" x ER25, - 50mm, slotted nut	1.0"	101mm	50mm	51mm	42mm	16089	04615
04817	20mm x ER32, - 50mm, slotted nut	20mm	97.1mm	50mm	47mm	50mm	16089	04616
04818	20mm x ER32, - 100mm, slotted nut	20mm	146.5mm	100mm	47mm	50mm	16083	04616
04818-150	20mm x ER32, - 150mm, slotted nut	20mm	196.5mm	150mm	47mm	50mm	16083	04616
04839	1.0" x ER32, - 50mm, slotted nut	1.0"	101.5mm	50mm	51.5mm	50mm	16089	04616
04839-140	1.0" x ER32, - 140mm, slotted nut	1.0"	191.5mm	140mm	51.5mm	50mm	16083	04616
04843	1-1/4" x ER32, - 60mm, slotted nut	1-1/4"	111.5mm	60mm	51.5mm	50mm	16089	04616
04841	1.0" x ER40, - 50mm, slotted nut	1.0"	115mm	50mm	65mm	63mm	16083	04617

Properly torque down the nut for best tool life. See the Torque Chart on page 41.



Features

- Collet pocket T.I.R. 0.0001"
- All surfaces precision ground
- PowerCOAT Nut included

Extension length should not exceed a 4 : 1 ratio of length to diameter.

Example: A 1/2" shank should not extend more than 2" in front of the holder.

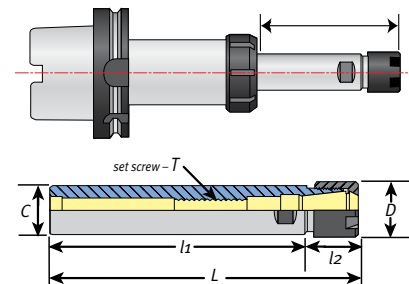

Mini-Nut ER Straight Shank Extensions

Part No.	Description	C	L	l1	l2	D	Set Screw	Wrench
04889	3/8" x ER8, - 100mm	3/8"	124mm	100mm	24mm	12mm	-	04620
04891	1/2" x ER11, - 140mm	1/2"	166.5mm	140mm	26.5mm	16mm	-	04621
04893	5/8" x ER11, - 140mm	5/8"	158.5mm	140mm	18.5mm	16mm	-	04621
04895	1/2" x ER16, - 140mm	1/2"	177mm	140mm	37mm	22mm	-	04622
04896	3/4" x ER16, - 140mm	3/4"	165mm	140mm	25mm	22mm	16083	04622
04892	1/2" x ER20, - 140mm	1/2"	180mm	140mm	40mm	28mm	16083	04623
04894	3/4" x ER20, - 140mm	3/4"	180mm	140mm	40mm	28mm	16083	04623
04881	20mm x ER20, - 180mm	20mm	220mm	180mm	40mm	28mm	16083	04623
04897	1.0" x ER20, - 140mm	1.0"	168mm	140mm	28mm	28mm	16083	04623
04898	3/4" x ER25, - 100mm	3/4"	149mm	100mm	49mm	35mm	16087	04624
04888	1.0" x ER25, - 140mm	1.0"	190mm	140mm	50mm	35mm	16083	04624

Precision ER Coolant-Thru Shanks & ER Double Ended



No. 04805-C

Features

- For coolant up to 1,500 PSI
- Collet pocket T.I.R. 0.0001"
- PowerCOAT coolant nut included

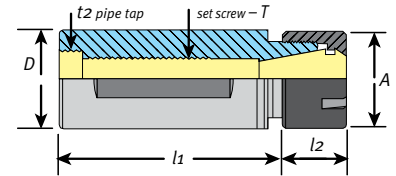

Use with Black Gold ER coolant rings for coolant-thru 04808C available with 1/8" NPT side entry coolant. Mini Coolant nuts page 59. Coolant-thru-tool set screws page 41.

Coolant-Thru Straight Shank Extensions

Part No.	Description	l1	l2	D	T	t2	A	Wrench
04802-C	3/4" x ER16, - 2" shank, coolant mini nut	1.65"	.916"	3/4"	m10 x 1.5	1/4" NPT	22mm	04622
04803-C	3/4" x ER16, - 3" shank, coolant mini nut	2.44"	.916"	3/4"	m10 x 1.5	1/4" NPT	22mm	04622
04804-C	3/4" x ER16, - 4" shank, coolant mini nut	3.42"	.916"	3/4"	m10 x 1.5	1/4" NPT	22mm	04622
04805-C	1.0" x ER20, - 3" shank, coolant mini nut	2.01"	1.07"	1.0"	m12 x 1.75	3/8" NPT	1.10"	04623
04806-C	1.0" x ER20, - 4" shank, coolant mini nut	3.31"	1.07"	1.0"	m12 x 1.75	3/8" NPT	1.10"	04623
04808-C	1.25" x ER32, - 2.36" shank, slotted nut	2.36"	2.16"	1-1/4"	m12 x 1.75	3/8" NPT	1.97"	04616

Blue indicates coolant.



O-ring seals coolant

Features

- For coolant up to 1,500 PSI
- Collet pocket T.I.R. 0.0001"
- PowerCOAT nut included

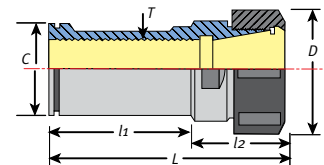

Perfect for CNC lathes and tapping applications. Seals coolant from the turret to the shank with an O-ring. Use black gold coolant rings (page 60) and PowerCOAT coolant nuts for coolant-thru tools, or CoolBLAST coolant for standard tools.

CNC Lathe Coolant-Thru Straight Shanks

Part No.	Description	C	l1	L	l2	D	T	Wrench
04782	1-1/4" x ER25, - 60mm shank	1-1/4"	60mm	97mm	37mm	42mm	M18 x 1.5	04615
04784	1-1/4" x ER32, - 60mm shank	1-1/4"	60mm	103mm	43mm	50mm	M22 x 1.5	04616
04788	1-1/2" x ER32, - 80mm shank	1-1/2"	80mm	118mm	38mm	50mm	M22 x 1.5	04616
04786	1-1/4" x ER40, - 60mm shank	1-1/4"	60mm	120mm	60mm	63mm	M28 x 1.5	04617
04790	1-1/2" x ER40, - 75mm shank	1-1/2"	75mm	135mm	60mm	63mm	M28 x 1.5	04617

Blue indicates coolant.

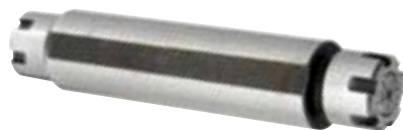

Features

- Collet pocket T.I.R. 0.0001"
- Wrench flats extend full length of shank

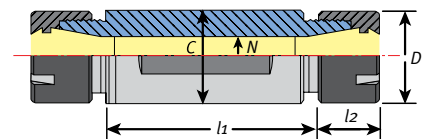

Double-Ended Straight Shank for CNC Swiss Machines

Part No.	Description	C	D	L1	L2	N	Wrench
04801-DE	3/4" x ER11, - 2.5" shank, double ended mini nut	3/4"	16mm	44mm	12mm	8mm	04621
04802-DE	3/4" x ER11, - 3.35" shank, double ended mini nut	3/4"	16mm	65mm	12mm	8mm	04621
04803-DE	3/4" x ER11, - 4.0" shank, double ended mini nut	3/4"	16mm	77mm	12mm	8mm	04621
04804-DE	3/4" x ER11, - 5.0" shank, double ended mini nut	3/4"	16mm	99.5mm	12mm	8mm	04621



TG75 & TG100 Precision Toolholders



Techniks Certified for accuracy and balance
Each holder comes with a complete lab report

Features

- *Balanced to 25,000 RPM at G2.5*
- *T.I.R. 0.0001" measured from taper to collet pocket*
- *PowerCOAT nut included for 75% more clamping power*

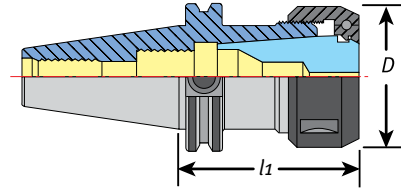

Coolant Set Screws page 47.

TG75 and TG100 Precision Toolholders

Part No.	Description	l1	D	Collet Range	Set Screw	Wrench
23008	CAT40 x TG75 - 2.75"	2.75"	1.88"	.094 - .750"	16089	04616
23014	CAT40 x TG100 - 3"	3"	2.362"	.094 - 1.0"	16093	03691
23016	CAT40 x TG100 - 4"	4"	2.362"	.094 - 1.0"	16093	03691
23018	CAT40 x TG100 - 6"	6"	2.362"	.094 - 1.0"	16093	03691
23030	CAT50 x TG100 - 3"	3"	2.362"	.094 - 1.0"	16093	03691
23032	CAT50 x TG100 - 4"	4"	2.362"	.094 - 1.0"	16093	03691
23034	CAT50 x TG100 - 6"	6"	2.362"	.094 - 1.0"	16093	03691
23035	CAT50 x TG100 - 8"	8"	2.362"	.094 - 1.0"	16093	03691



Techniks Certified for accuracy and balance
Each holder comes with a complete lab report

Features

- *Balanced to 25,000 RPM at G2.5*
- *Coolant-thru spindle or thru flange (DIN B)*
- *T.I.R. 0.0001" or better from taper to collet pocket*

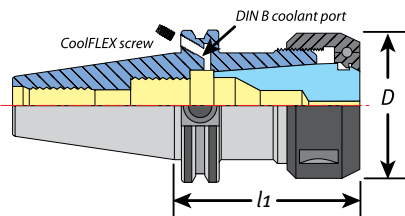

CoolFLEX Feature

CoolFLEX holders are factory set for coolant-thru spindle. Simply remove 2 stop screws for DIN B coolant-thru flange.

Part No. Description

HSA-4-6 40 taper DIN B screw

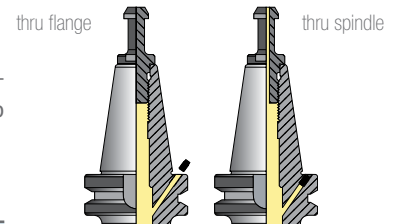

Coolant Set Screws page 47.

TG100 CoolFLEX Coolant-Thru Spindle or Flange (DIN B)

Part No.	Description	l1	D	Collet	Collet Range	Set Screw	Wrench
23014F	CAT40 CoolFLEX x TG100 - 3"	3"	2.362"	TG100	.094 - 1.0"	16093	03691
23016F	CAT40 CoolFLEX x TG100 - 4"	4"	2.362"	TG100	.094 - 1.0"	16093	03691
23018F	CAT40 CoolFLEX x TG100 - 6"	6"	2.362"	TG100	.094 - 1.0"	16093	03691
23030F	CAT50 CoolFLEX x TG100 - 3"	3"	2.362"	TG100	.094 - 1.0"	16093	03691

Blue indicates coolant.

Recommended Torque Values & Coolant Set Screws

Recommended Collet Nut & Retention Knob Tightening Torque

Collet	Nut Type	Collets I.D. OVER 1/16" (2mm)	Collets I.D. UNDER 1/16" (2mm)	Order Torque Wrench Adapter
ER16	slotted	42 ft/lbs	30 ft/lbs	04580-16
ER16	hex	42 ft/lbs	30 ft/lbs	04601-16
ER20	slotted	59 ft/lbs	24 ft/lbs	04580-20
ER20	hex	59 ft/lbs	24 ft/lbs	04602-20
ER25	slotted	77 ft/lbs	77 ft/lbs	04603-25
ER25	mini nut	25 ft/lbs	25 ft/lbs	04587
ER32	slotted	100 ft/lbs	100 ft/lbs	04604-32
ER40	slotted	130 ft/lbs	130 ft/lbs	04605-40
SYOZ 25	hook	90 ft/lbs	90 ft/lbs	03690-25
TG75	slotted	90 ft/lbs	90 ft/lbs	04604-32
TG100	hook	90 ft/lbs	90 ft/lbs	03690-25



Collets
pg. 49



Nuts
pg. 64



Coolant
Rings
pg. 66



Retention
Knobs
pg. 228



Wrenches
pg. 232



Tightening
Stands
pg. 234

Always tighten retention knobs to exact specification or damage to tooling or bodily harm may occur.

Retention Knobs	Wrench Flats	Drive	Torque	Order Socket
BT30 Taper	0.535"	1/4"	36 ft/lbs	PSS-30BT
ISO 30 Taper	0.535"	3/8"	36 ft/lbs	PSS-30ISO
Any 40 Taper	0.750"	3/8"	76 ft/lbs	PSS-40
BT50 Taper	1.187"	1/2"	99 ft/lbs	PSC-50
CAT50 Taper	1.250"	1/2"	99 ft/lbs	PSC-50

**Always use a torque wrench and tightening stand when tightening collet nuts and retention knobs. Overtightening collet nuts will cause premature damage to collets and increase run-out.



Use coolant set screws for coolant-thru tools or with Black Gold Rings for CoolBLAST option using standard cutting tools. See page 66 for more information.

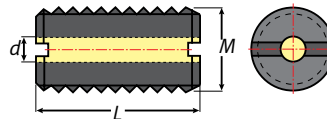

Coolant Set Screws

Part No.	Description	M	L	d
16080C-20	Coolant Set Screw	M5 x 0.8P	20mm	2.5
16082C-20	Coolant Set Screw	M8 x 1.25P	20mm	4
16083C-20	Coolant Set Screw	M10 x 1.5P	20mm	4
16085C-20	Coolant Set Screw	M12 x 1.75P	20mm	4
16089C-20	Coolant Set Screw	M16 x 02.0P	20mm	5
16091C-20	Coolant Set Screw	M20 x 2.0P	20mm	5

Blue indicates coolant.

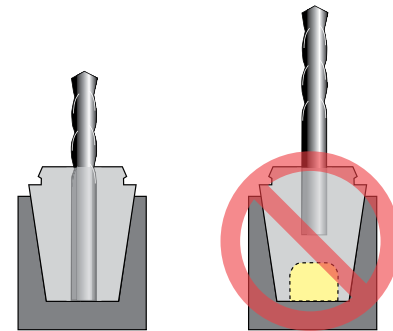

For maximum holding power fill the collet all the way with the tool shank (left) and use a PowerCOAT nut.

DIRECTIONS

- Snap collet into nut.
- Insert cutting tool into collet. Make sure shank extends to the bottom of the collet.
- Hand tighten collet nut assembly into toolholder.
- Insert toolholder assembly into tightening fixture and secure it.
- Tighten collet nut to recommended torque using a torque wrench and adapter.

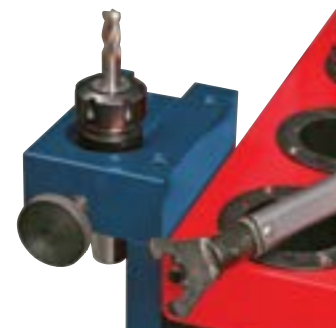

Measurement Guide for Special Order Toolholders

V-flange CNC machine
make, model and spindle

Fill in all the required dimensions (left).
Then, fax or phone in your order for a fast quote.

v-flange tool #1 dimensions

D = _____
 F = _____
 W = _____
 A = _____
 N = _____

v-flange tool #2 dimensions

D = _____
 F = _____
 W = _____
 A = _____
 N = _____

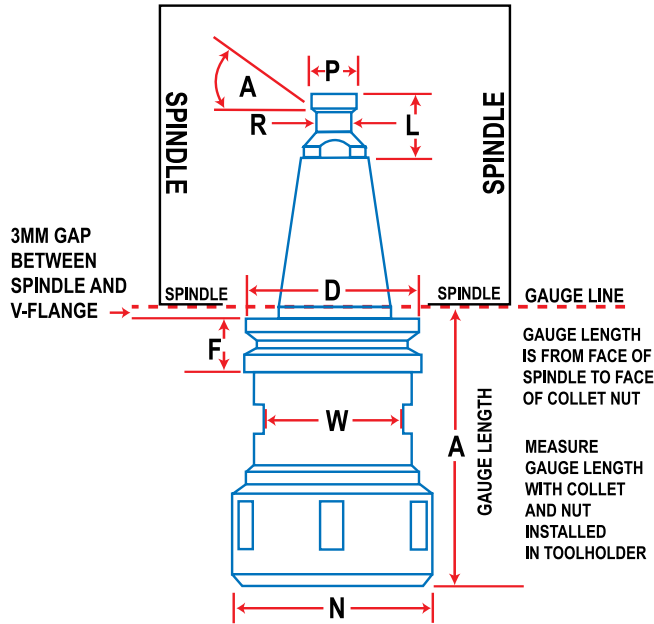

HSK CNC machine
make, model and spindle

HSK tool #1 dimensions

D = _____
 F = _____
 W = _____
 A = _____
 N = _____

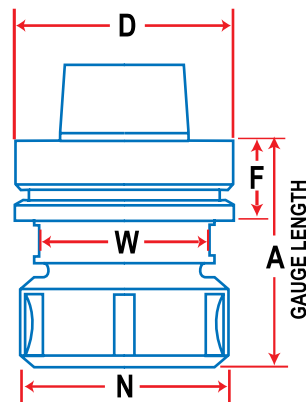

HSK tool #2 dimensions

D = _____
 F = _____
 W = _____
 A = _____
 N = _____

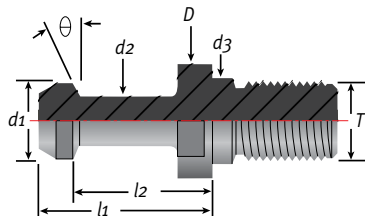

For special order retention knobs see page 231
or call (800) 597-3921

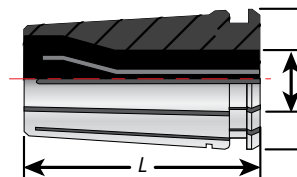

For special order collets see page 74 or
call (800) 597-3921