



TRUMPF



TruServices

Genuine Parts

All the information you need to order your Genuine Part.

Have you thought of everything?

- Name
- Order number
- Machine number
- Quantity
- Desired delivery date

Important ordering information

For prices, please consult your local TRUMPF subsidiary or agent.
Or, if the service is available from your national subsidiary, order directly online from www.mytrumpf.com.

TRUMPF Werkzeugmaschinen GmbH + Co. KG
Johann-Maus-Straße 2
71254 Ditzingen, Germany
Phone: +49 7156 303-0
Fax: +49 7156 303-30309
E-mail: info@de.trumpf.com
Website: www.trumpf.com

Contents



General Information

Genuine Parts
TRUMPF Logistics

Your product benefits

4



Genuine Parts for your machine

TruLaser

20

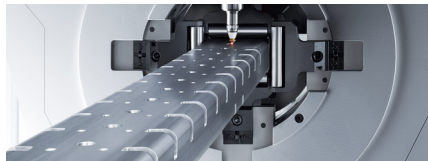

TruLaser Tube

68



TruMatic

80



TruPunch

94



Multi-series Genuine Parts

95



Genuine Accessories

Cleaning products
Tools

Fluids

98



Application Tips

Perfect lens cleaning
Quick protective glass cleaning

Cleaning and changing the cooling water
Reconditioning of cooling water

104



Your order

MyTRUMPF customer portal
Global contacts

General information

114

TruServices

Your Partner in Performance

What do you need for your success?

To be successful in the future, you need the right services to keep you on track for the long term. Do you want to create the perfect manufacturing environment or make the best use of your TRUMPF equipment and tailor it to your evolving needs? Whatever the case, we're on hand to help you maximize your added value and lock those benefits in. TRUMPF is the right choice if you're looking for a reliable partner that can support you with a wide range of custom solutions and service packages, ensuring that your manufacturing business continues to be a resounding success.

EMPOWER

Looking to create the best conditions for successful manufacturing? We can give you the support you need.

SUPPORT

Are flexibility and machine availability top priorities in your ongoing manufacturing activities? We're on hand to help.

IMPROVE

Do you want to gradually shift your production processes towards maximum added value? We can achieve that together.



Genuine Parts

Quality in every detail

Genuine Parts from TRUMPF – Keep your machine an original

Genuine Parts from TRUMPF are the best protection for your investment. Perfectly attuned to your TRUMPF machine right from the start, Genuine Parts ensure maximum performance and productivity for the long term.



1 Expertise: Knowing what counts

How can our expertise help you? For decades, we've made it our business every day to know and understand what your needs are. Regular communication with you, the expertise of TRUMPF engineers and knowledge of technological trends are some of the most important drivers when it comes to developing spare parts. Always with the aim of providing you with Genuine Parts that give you real added value.



2 Availability: At the right place, at the right time

In a crisis, every minute counts. That is why with TRUMPF, you get the required spare part delivered to you quickly whenever and wherever you need it. Order your spare part from our comprehensive parts range simply and conveniently – either online, over the telephone, via fax or e-mail. In Europe and the USA, our 24/7 service can even deliver around the clock.

3 Quality: Details that make the difference

When it comes to quality, nothing should be left to chance. Right from the development stage, TRUMPF Genuine Parts and machines are attuned to each other down to the finest detail. This means that we not only guarantee top process reliability, but also offer "plug & play" spare parts that can be used right away, without the need for complex installation work. TRUMPF guarantees the highest of quality standards to keep it this way.



4 Service: Impressive expertise

Our experts are always happy to advise and support you. Our sales representatives are here to give you expert and reliable advice for questions related to identifying and ordering spare parts whenever you need it. If you need help at your location, our experienced Technical Service Department can help and support you when replacing spare parts. If you are looking for extra tips for your machine, you have come to the right place with TRUMPF.



Your benefit

Our logistics

Often, the availability of your machine can come down to a single tiny part. Our sales and logistics experts around the world make sure that you get the spare parts you need as quickly as possible. After all, when you really need that part, every minute counts.

Global network

Whether you produce in Europe, America or Asia: Our spare parts logistics make sure your machines are available when you need them. Our global logistics network of over 130 TRUMPF logistics specialists make it their mission every day to ensure quick and reliable delivery of your Genuine Parts. In our central logistics hub in Germany alone, we have over 35,000 different spare parts ready for you and make sure that over 340,000 packages are quickly delivered to you every year.

Reliable logistics specialists

Machinery downtimes cost time and money. That's why our staff give their all to supply you quickly and reliably. The majority of orders received by our logistics centers are delivered the next day. Our logistics experts always ensure that your desired delivery date is met.

Long-term security

Even when a TRUMPF machine has long since gone out of production, our logistics centers still have the right spare parts ready for you. Not only does this mean that your production is secured for the long term, but you also benefit from high prices when reselling machines.



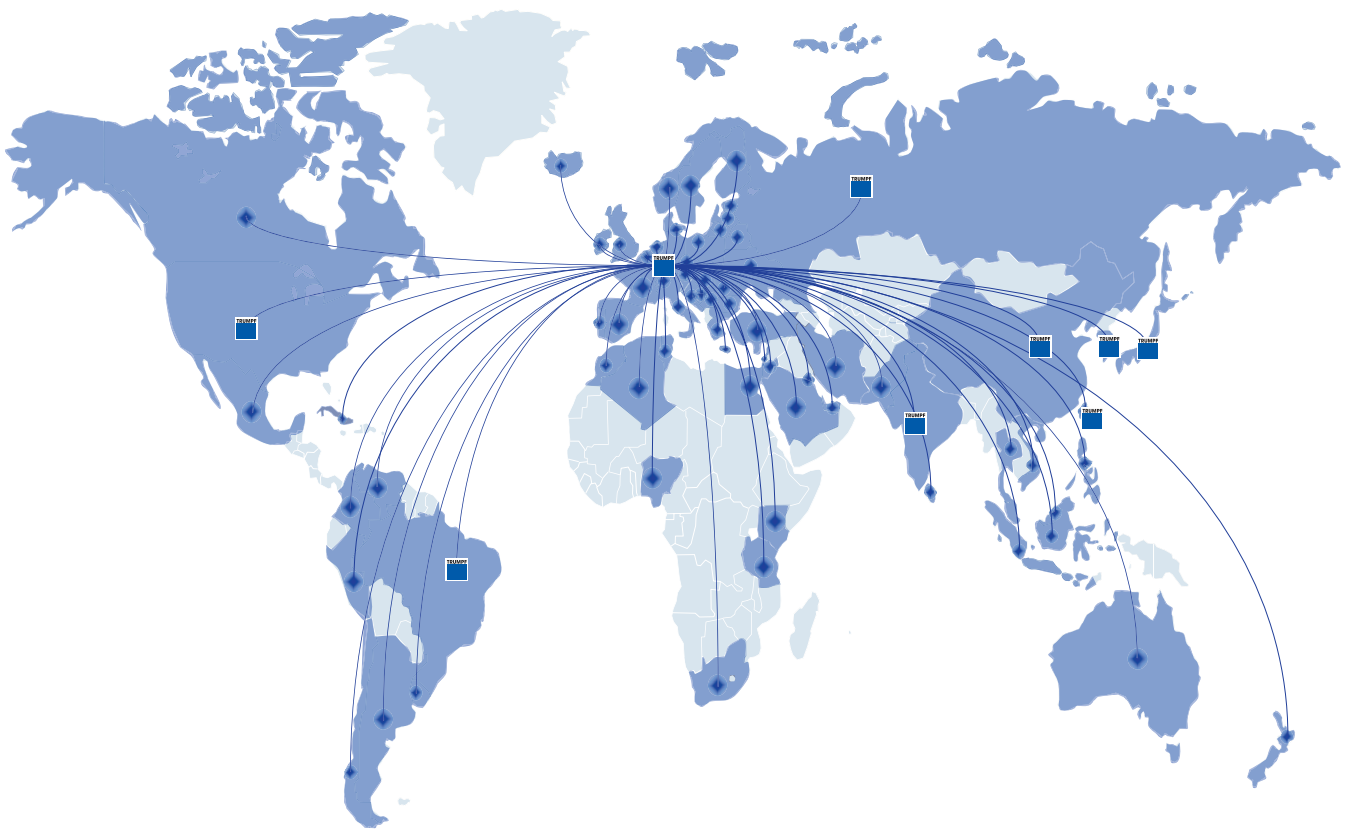

Spare part logistics 4.0 Data & facts.

- Delivery of over 75,000 items per month
- Over 340,000 deliveries per year
- Over 85% of all parts ordered are dispatched on the same day
- More than 12,500 customers in over 87 countries



Experience Logistics 4.0 in action
www.trumpf.info/l9bsgu



Genuine Lenses
and Protective
Glasses

Excellent results

Premium products

A premium lens that meets TRUMPF specifications is essential to ensure that you get excellent cutting results from your laser machine. We carefully select materials and strenuously check quality to make sure that Genuine Lenses focus the laser beam perfectly. That means you get a single, precisely attuned unit, from the machine and sensors all the way to the Genuine Lens. This also includes perfect focus positioning and excellent cutting results.

Process reliability is vital

With the intelligent lens with RFID chip and the LensLine sensors with status check, Genuine Parts now offer you even greater reliability. This major innovation means that the correct installation and focal length of the lens is always guaranteed. This protects the cutting head and makes your processes even more reliable.

Ideas that add up

You enjoy the returns of our constant efforts to develop our components. Did you know that the combination of LensLine and a Genuine Lens with RFID chip improves cleaning cycles? You can reduce your non-productive times up to 40%. This means you can lower your operating costs throughout the entire life cycle of the machine.

Environmentally aware service

Not sure what to do with used lenses? Don't worry. Simply return your used Genuine Lenses to us and we will dispose of them for you – free of charge.





Perfect protection

In solid-state laser machines, the lens is guarded against contamination by a protective glass. This acts as a pressure window for the cutting gas that is used and keeps spatter, smoke residue and vapors away from the lenses. Not every protective glass can withstand this pressure.



Clever coating.

Genuine Protective Glasses from TRUMPF are produced according to precise specifications to suit the wavelength of the laser light and satisfy the requirements of the cutting process and sensors. A special coating, together with the use of particularly pure raw materials, ensures low reflectivity and prevents thermal changes to the glass. With Genuine Protective Glasses, there is nothing to stand in the way of a reliable cutting process.

Genuine Nozzles
and Nozzle Holders

Convincing quality

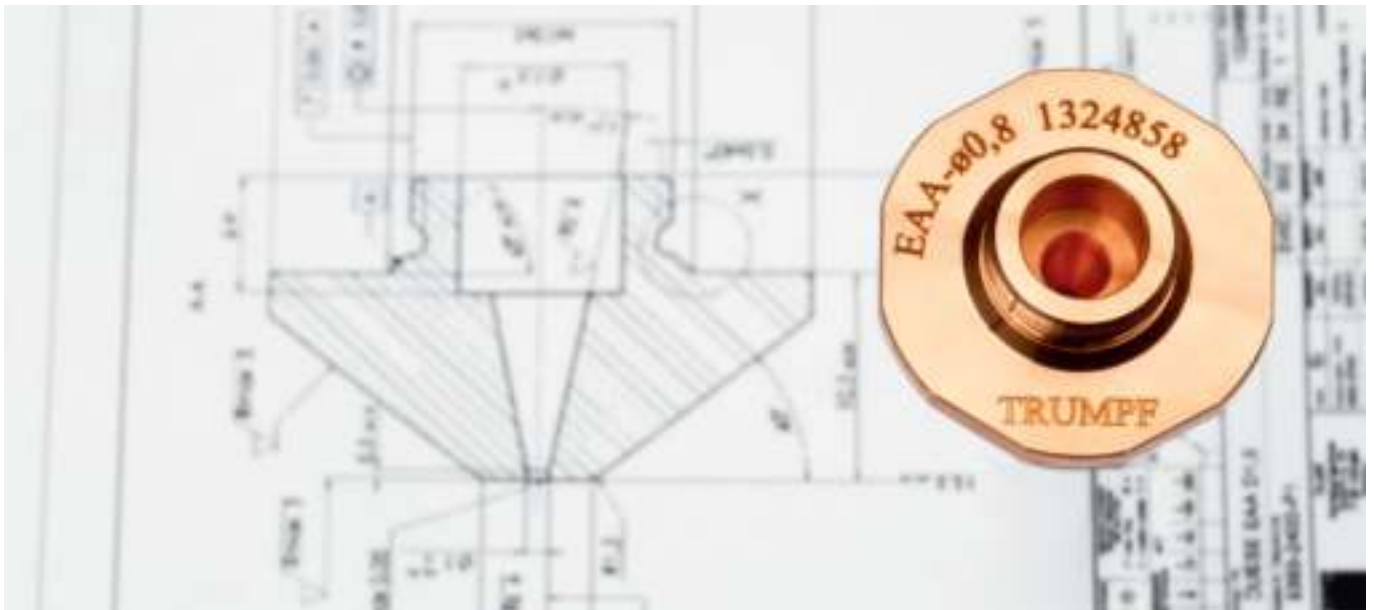

Not to be underestimated

The cutting nozzle is a vital part, as it is here that the laser beam and the cutting gas meet the workpiece. Choosing the right nozzle is therefore essential for the quality of your parts. Leave nothing to chance. Guarantee the best cut quality with Genuine Nozzles from TRUMPF.

Long service life guaranteed

"Made in Germany" – Genuine Nozzles are manufactured according to very strict quality specifications. Naturally, we only use materials of the highest quality, which ensures the longest service life possible.

The nozzle's precisely manufactured surface minimizes the adhesion of slag spatter. A special alloy dissipates the heat perfectly and also guarantees a long service life for the nozzle.

Making saving easy

Aside from careful selection of materials, the manufacturing process needs to be precise, as the geometry of the nozzle determines the flow profile and therefore the quality of your cutting result. Genuine Nozzles guarantee a perfect gas flow and minimize burr formation. They only consume as much cutting gas as is required, saving you money.

Good to know

Thanks to strict production tolerances, Genuine Nozzles from TRUMPF are ready to use right away, with no need for time-consuming re-centering work.

A unit that lasts

Optimally attuned nozzle holders, nozzles and distance sensors ensure an excellent cutting process and ideal cutting results. In order to guarantee this at all times, Genuine Nozzles Holders are also subjected to tough quality standards in production. The ceramic part and thread insert are bonded with utmost precision. Once bonded, they are inseparable and extremely robust.

Keeping the right distance

The resistant materials used in the nozzle holder do not just withstand extremely high temperatures, but also ensure electrical insulation in the high-frequency range. This is required to ensure that the distance sensors always maintain the perfect distance between the sheet and the nozzle. Combined with the original, you achieve consistent focus positioning.



Genuine Power Tubes
and Filter Plates

Top performance

Maximum power guaranteed

The Genuine Power Tube (transmission tube) from TRUMPF is a part of many CO₂ laser machines. It is the heart of your laser generator and ensures the maximum laser power. With our decades of experience and the attuned electrical parameters of the Power Tube and TRUMPF generator, you can be sure of perfect interaction and the highest process reliability.

Focus on quality

Before we send the Power Tube on its way to you, we subject every single one to a strict quality check in Germany and enclose a quality certificate with it. In these checks, the Power Tube is tested for optimum performance parameters, perfect surface quality and production quality. This guarantees you a high degree of reliability and a premium product that will last.

The choice is yours

We always provide the right product for your needs. Benefit from our extended warranty. Interested? The sales representative responsible for you will be happy to provide you with more information.





Consistently high filter performance

TRUMPF-tested Genuine Filter Plates work according to the principle of surface filtration. The dust is filtered directly at the surface thanks to a substrate made from permeable polyester fleece with a Teflon-coated surface, meaning that it cannot penetrate deep. This means that more than 99.995% of the particles are filtered, even in the micrometer range – an outstanding result. Genuine Filter Plates guarantee consistently high filter performance for years.



Optimal health protection

Laser cutting creates emissions that can be harmful to your employees, the environment and the components of your machine. TRUMPF makes no compromises with its Genuine Filter Plates and even exceeds legal requirements. The cleaning intervals for your Genuine Filter Plates are stored in the machine control unit to provide long-term protection.

Genuine Bellows
and Mirrors

Perfect beam guidance



Top protection

The axes of your machine are covered with protective bellows to guard your laser's sensitive beam guidance optics against dust and other particles. Only purified air or nitrogen are permitted inside the bellows, so that the laser beam is not absorbed or deflected. Thanks to their material composition and high manufacturing quality, Genuine Bellows from TRUMPF ensure that the beam path has optimal protection. When using the original, you achieve perfect focus positioning on the workpiece.

Long service life

Due to the high speeds of the entire motion unit and the resulting pressure change, the bellows are subjected to extreme mechanical stresses.

That is why Genuine Bellows from TRUMPF are made from a particularly flexible, but stable and self-extinguishing synthetic material. Even in a three-shift operation, you can count on the long service life of your Genuine Bellows.

Outstanding parts quality

The laser beam in your CO₂ laser machine is shaped, controlled and focused by many optical elements. At TRUMPF, we pour all of our specialist expertise into our high-quality Genuine Mirrors, so that you can be sure that the parts you hold in your hands after the cutting process are of the very best quality. Our development and production engineers work constantly to improve the Genuine Mirrors along the entire beam path.



High-precision production

TRUMPF produces its diamond-cut optics in a high-precision manufacturing process using its own equipment developed in-house. It is very important to us that the mirrors are produced under precisely defined conditions, so that the shape and dimensions of the Genuine Mirrors are perfect. Continuous process testing ensures that you always receive brilliant quality.



Genuine Easy Kits
and Easy Filter

Excellent cooling

Sustainable cleaning.

With reliable cooling for all your machine components, you can maintain the maximum availability of both your machine and laser. The genuine Easy Kits offer you a sustainable, clean cooling circuit and therefore the best possible protection. You get everything you need for the cleaning process - the cleaning biocide and anticorrosive agent - in one convenient set.

Easy Kits – Your advantages:

- Sustainable cleaning and increased service life of all cooled components
- Production is possible during the cleaning process
- Easy and quick use
- Easy Kit sets adapted to your laser and machine type

The quick alternative.

To increase the service life of the machine and laser, change the cooling water annually and in doing so free the cooling circuit of impurities and particles. We are offering the Easy Filter as a quick alternative: Recondition your used cooling water and you can avoid time-consuming water changes. Using the genuine Easy Kit you can keep producing without worries for another year.

Easy Filter – your advantages:

- Maintenance work is far easier with the reconditioning of the used cooling water in about 3 hours
- Simple and process-reliable use, because the Easy Filter and genuine Easy Kits are designed to be perfectly compatible
- Quick installation, even for the first time





Reliable cooling

The Genuine Filter Cartridges consist of a covered fiber, whose fleece layers are fused securely to each other in a special process. This manufacturing process provides you with special benefits. The outstanding strength allows the Genuine Filter Cartridges to withstand extreme pressure differences without losing fibers.

This means the filter components and water cooling channels are constantly kept free of loose fibers. The original helps ensure your machine is optimally cooled for the long term.

Genuine Parts

Quality in every detail

Your TRUMPF machine – an Original

Genuine Parts from TRUMPF are characterized by top-quality and service life, guaranteed availability, and first-class service. We offer you exclusively spare parts made of top-quality materials using state-of-the-art, high-precision manufacturing techniques. The best conditions for your production.

Need the right lens to match your machine? Or want to know which nozzles and nozzle holders can be used for the BrightLine option? All you have to do is select your machine series and you will get a complete overview on just one double-page spread.



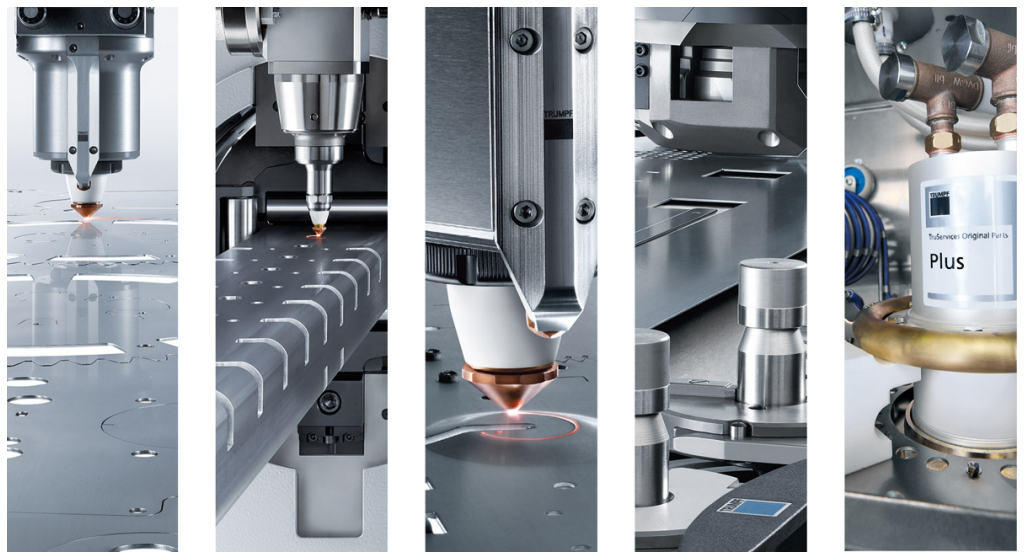

Genuine Parts for your machine.

TruLaser

Series 1000	22
Series 1000 fiber	24
Series 2000 / 3000	30
Series 2000 fiber	32
Series 3000	34
Series 3000 fiber	42
Series 5000	48
Series 5000 fiber	54
Series 7000 / 8000	60
Series 7000 fiber	64
Center 7030 fiber	66

TruLaser Tube

Series 3000 fiber	68
Series 3000 / 5000 (T01)	70
Series 5000 (T05) / 7000	72
Series 5000 fiber	74

TruMatic

Series 1000 fiber	80
Series 3000	82
Series 3000 fiber	84
Series 6000 (K01)	88
Series 6000 (K05) / 7000	90
Series 6000 fiber	92

TruPunch

Series 1000	94
Series 2000	94
Series 3000	94
Series 5000	94

Multi-series Genuine Parts

Power Tube	95
Filter plate	95
Easy Kit	95
Filter cartridge	95
Easy Filter	96



Important ordering information

For prices please consult your local TRUMPF subsidiary or agent. Or, if the service is available from your national subsidiary, order directly online from www.mytrumpf.com.

TruLaser Series 1000



Machine type

TruLaser 1030 (L22)

Cutting optics type

Cutting head with inch focal length and nozzle with M8 connection thread

Application tips

p. 104

Lens



Advantages of the Genuine Lens

- Optimal process reliability with the lens failure sensor system
- Plug & play based on perfectly combined cutting parameters
- Optimum cutting result based on tried and proven TRUMPF quality

High-pressure lens

Name	Focal length	Order no.
ZnSe high-pressure lens	7.5 "	0097517

Nozzle



Advantages of the Genuine Nozzle

- Outstanding parts quality: made in Germany
- Excellent cut quality in every processing direction thanks to direction-independent gas flow
- Cutting gas consumption minimized due to precise geometries and strict production tolerances

Not chrome-plated (Pack of 5)

Name	Ø	Order no.
Nozzle ECE, not chrome-plated	0.8 mm	0124561
	1.0 mm	0124562
	1.2 mm	0966809
	1.4 mm	0237497
	1.7 mm	0237501
	2.0 mm	1253211
	2.3 mm	0126933
	2.7 mm	0942742

Chrome-plated (Pack of 5)

Name	Ø	Order no.
Nozzle ECE, chrome-plated	0.8 mm	0352280
	1.0 mm	0352281
	1.2 mm	0352282
	1.4 mm	0352283
	1.7 mm	0352284
	2.0 mm	1253212
	2.3 mm	0352285
	2.7 mm	0352286

Nozzle holder



Advantages of the Genuine Nozzle Holder

- High-grade raw materials for correct distance regulation and consistent focus positioning
- Ideal beam properties at the workpiece thanks to the use of Genuine Nozzle Holders and Nozzles

Standard		
Name	Ø thread	Order no.
Nozzle holder	M8	0260432

Additional items related to the nozzle holder

Union nut		
Name	Ø thread	Order no.
Union nut	M50	0256152

Cover cap	
Name	Order no.
Cover cap	0955826

Multi-series Genuine Parts

Additional Genuine Parts that are important for your machine's productivity can be found in the chapter "Multi-series Genuine Parts".

Power Tube (for TruCoax 2000)



Filter plate



Easy Kit



Filter cartridge



TruLaser Series 1000 fiber



Machine type

TruLaser 1030 fiber (L46), 1030 fiber (L88), 1040 fiber (L88), 1060 fiber (L88), TruLaser 18 Edition (L88)

Cutting optics type

Cutting unit

Part-relevant options

BrightLine fiber, Performance package, Highspeed cutting process, Highspeed Eco cutting process

Application tips

p. 104

Protective glass



Advantages of the Genuine Protective Glass

- Optimal protection of the beam path against disruptive contamination
- Top cutting result thanks to special coating and excellent glass purity

Protective glass

Name	Ø	Order no.
Protective glass D34	34.0 mm	2602937

Nozzle

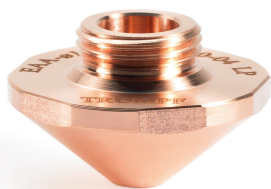

Advantages of the Genuine Nozzle

- Excellent cut quality in every processing direction thanks to direction-independent gas flow
- Cutting gas consumption minimized due to precise geometries and strict production tolerances
- High process reliability due to perfect interaction with the nozzle changer

Standard (Pack of 5)

Name	Ø	Order no.
Nozzle EAA	0.8 mm	1324858
	1.0 mm	1324860
	1.2 mm	1324861
	1.4 mm	1324863
	1.7 mm	1324864
	2.0 mm	1324865
	2.3 mm	1324866
2.7 mm	1324867	

BrightLine

Name	Ø	Order no.
Nozzle EAK	4.0 mm	1835747
Nozzle EAQ	6.0 mm	1809091
	7.5 mm	1809421
	9.5 mm	1886199

Highspeed (packaging unit x 5)

Name	Ø	Order no.
Nozzle EAU	10.0 mm	2253595

Slim (Pack of 5)

Name	Ø	Order no.
Nozzle EAB	0.8 mm	1373324
	1.0 mm	1373325
	1.2 mm	1373326
	1.4 mm	1373327
	1.7 mm	1373328
	2.0 mm	1373329
	2.3 mm	1373330
	2.7 mm	1373331

Performance (packaging unit x 5)

Name	Ø	Order no.
Nozzle EAU	2.5 mm	2059462
	3.0 mm	2060001
	4.0 mm	2060004
	6.0 mm	2060025

Highspeed Eco

Name	Ø	Order no.
Nozzle EAV (x 1)		2228806
Inner part EAV (x 5)	3.0 mm	2228802
Sleeve EAV (x 20)		2284349

Nozzle holder



Advantages of the Genuine Nozzle Holder

- High-grade raw materials for correct distance regulation and constant focus positioning
- Long service life thanks to the precise joining process of the ceramic and thread insert

Standard / BrightLine		
Name	Ø thread	Order no.
Nozzle holder	M12	1755673

Additional items related to the nozzle holder

Union nut		
Name	Ø thread	Order no.
Union nut	M48	1339994

Crossjet nozzle (Pack of 5)		
Name	Ø	Order no.
Crossjet nozzle	2.0 mm	1384753

Multi-series Genuine Parts

Additional Genuine Parts that are important for your machine's productivity can be found in the chapter "Multi-series Genuine Parts".

Filter plate



Easy Kit



Filter cartridge



Easy Filter



TruLaser Serie 1000 fiber

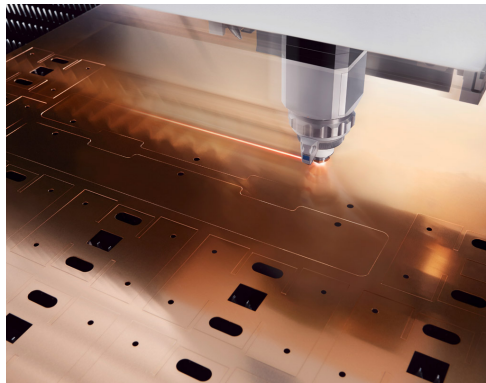

Machine type

TruLaser 1030 Basic Edition (L92), 1060 Basic Edition (L92)

Cutting optics type

Cutting unit

Part-relevant options

BrightLine fiber, Performance package, Highspeed cutting process

Application tips

p. 104

Protective glass



Advantages of the Genuine Protective Glass

- Optimal protection of the beam path against disruptive contamination
- Top cutting result thanks to special coating and excellent glass purity

Protective glass

Name	Ø	Order no.
Protective glass D34	34.0 mm	2602937

Nozzle

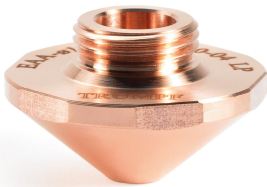

Advantages of the Genuine Nozzle

- Excellent cut quality in every processing direction thanks to direction-independent gas flow
- Cutting gas consumption minimized due to precise geometries and strict production tolerances
- High process reliability due to perfect interaction with the nozzle changer

Standard (Pack of 5)

Name	Ø	Order no.
Nozzle EAA	0.8 mm	1324858
	1.0 mm	1324860
	1.2 mm	1324861
	1.4 mm	1324863
	1.7 mm	1324864
	2.0 mm	1324865
	2.3 mm	1324866
	2.7 mm	1324867

BrightLine

Name	Ø	Order no.
Nozzle EAQ	7.5 mm	1809421
	9.5 mm	1886199

Highspeed (packaging unit x 5)

Name	Ø	Order no.
Nozzle EAU	10.0 mm	2253595

Slim (Pack of 5)

Name	Ø	Order no.
Nozzle EAB	0.8 mm	1373324
	1.0 mm	1373325
	1.2 mm	1373326
	1.4 mm	1373327
	1.7 mm	1373328
	2.0 mm	1373329
	2.3 mm	1373330
	2.7 mm	1373331

Performance (packaging unit x 5)

Name	Ø	Order no.
Nozzle EAU	2.5 mm	2059462
	3.0 mm	2060001
	4.0 mm	2060004
	6.0 mm	2060025

Nozzle holder



Advantages of the Genuine Nozzle Holder

- High-grade raw materials for correct distance regulation and constant focus positioning
- Long service life thanks to the precise joining process of the ceramic and thread insert

Standard / BrightLine

Name	Ø thread	Order no.
Nozzle holder	M12	1755673

Other items relating to the nozzle holder

Union nut

Name	Ø thread	Order no.
Union nut	M48	1339994

Crossjet nozzle (Pack of 5)

Name	Ø	Order no.
Crossjet nozzle	2.0 mm	1384753

Multi-series Genuine Parts

Additional Genuine Parts that are important for your machine's productivity can be found in the chapter "Multi-series Genuine Parts".

Filter element

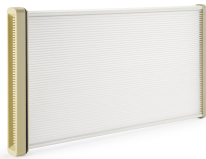

Easy Kit



Filter cartridge



Easy Filter



TruLaser Serie 1000 fiber

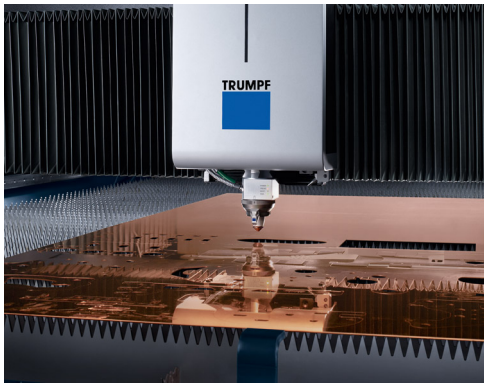

Machine type	TruLaser	1030 fiber (L94), 1040 fiber (L94), 1060 fiber (L94)
Cutting optics type		Cutting unit
Part-relevant options		BrightLine fiber, CoolLine, Performance package, Highspeed cutting process, Highspeed Eco cutting process
Application tips		p. 104

Protective glass



Advantages of the Genuine Protective Glass

- Optimal protection of the beam path against disruptive contamination
- Top cutting result thanks to special coating and excellent glass purity

Protective glass		
Name	Ø	Order no.
Protective glass D34	34.0 mm	2602937

Nozzle

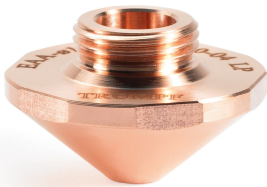

Advantages of the Genuine Nozzle

- Excellent cut quality in every processing direction thanks to direction-independent gas flow
- Cutting gas consumption minimized due to precise geometries and strict production tolerances
- High process reliability due to perfect interaction with the nozzle changer

Standard (Pack of 5)		
Name	Ø	Order no.
Nozzle EAA	0.8 mm	1324858
	1.0 mm	1324860
	1.2 mm	1324861
	1.4 mm	1324863
	1.7 mm	1324864
	2.0 mm	1324865
	2.3 mm	1324866
	2.7 mm	1324867

BrightLine		
Name	Ø	Order no.
Nozzle EAK	4.0 mm	1835747
Nozzle EAQ	6.0 mm	1809091
	7.5 mm	1809421
	9.5 mm	1886199

CoolLine		
Name	Ø	Order no.
Nozzle EGL	1.4 mm	1879940
	1.7 mm	1879951
	2.0 mm	1879952
	2.3 mm	1879953

Slim (Pack of 5)		
Name	Ø	Order no.
Nozzle EAB	0.8 mm	1373324
	1.0 mm	1373325
	1.2 mm	1373326
	1.4 mm	1373327
	1.7 mm	1373328
	2.0 mm	1373329
	2.3 mm	1373330
	2.7 mm	1373331

Performance (packaging unit x 5)		
Name	Ø	Order no.
Nozzle EAU	2.5 mm	2059462
	3.0 mm	2060001
	4.0 mm	2060004
	6.0 mm	2060025

Highspeed (packaging unit x 5)		
Name	Ø	Order no.
Nozzle EAU	10.0 mm	2253595

Highspeed Eco		
Name	Ø	Order no.
Nozzle EAV (x 1)		2228806
Inner part EAV (x 5)	3.0 mm	2228802
Sleeve EAV (x 20)		2284349

Nozzle holder



Advantages of the Genuine Nozzle Holder

- High-grade raw materials for correct distance regulation and constant focus positioning
- Full utilization of nozzle changer functionality with the Original

Standard / BrightLine

Name	Ø thread	Order no.
Nozzle holder	M12	1755673

Standard / BrightLine / CoolLine

Name	Ø thread	Order no.
Nozzle holder	M12	1906032

Other items relating to the nozzle holder

Union nut

Name	Ø thread	Order no.
Union nut	M48	1339994

Crossjet nozzle (Pack of 5)

Name	Ø	Order no.
Crossjet nozzle	2.0 mm	1384753

Multi-series Genuine Parts

Additional Genuine Parts that are important for your machine's productivity can be found in the chapter "Multi-series Genuine Parts".

Filter element



Easy Kit



Filter cartridge



Easy Filter



TruLaser Series 2000, 3000

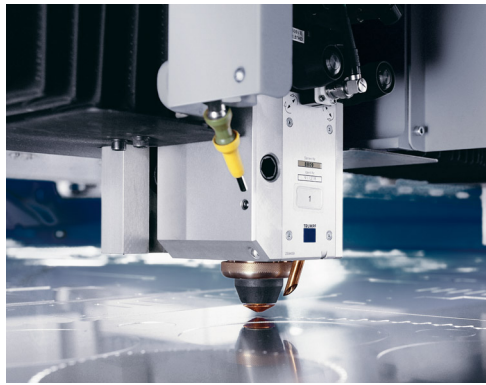

Machine type

TruLaser 2025, 2030, 2525, 3030, 3030 Basic Edition, 3030 Classic Edition, 3040, 3060

TCL

2510, 2530, 3020, 3030, 3040, 4030, 6030

Cutting optics type

Cutting head with inch focal length and nozzle with M8 connection thread

Application tips

p. 104

Lens



Advantages of the Genuine Lens

- Optimal process reliability with the lens failure sensor system
- Plug & play based on perfectly combined cutting parameters
- Optimum cutting result based on tried and proven TRUMPF quality

High-pressure lens

Name	Focal length	Order no.
	3.75 "	0346104
ZnSe high-pressure lens	5 "	0088114
	7.5 "	0097517

Nozzle



Advantages of the Genuine Nozzle

- Outstanding parts quality: made in Germany
- Excellent cut quality in every processing direction thanks to direction-independent gas flow
- Cutting gas consumption minimized due to precise geometries and strict production tolerances

Not chrome-plated (Pack of 5)

Name	Ø	Order no.
	0.8 mm	0124561
	1.0 mm	0124562
	1.2 mm	0966809
Nozzle ECE, not chrome-plated	1.4 mm	0237497
	1.7 mm	0237501
	2.0 mm	1253211
	2.3 mm	0126933
	2.7 mm	0942742

Chrome-plated (Pack of 5)

Name	Ø	Order no.
	0.8 mm	0352280
	1.0 mm	0352281
	1.2 mm	0352282
Nozzle ECE, chrome-plated	1.4 mm	0352283
	1.7 mm	0352284
	2.0 mm	1253212
	2.3 mm	0352285
	2.7 mm	0352286

Nozzle holder



Advantages of the Genuine Nozzle Holder

- High-grade raw materials for correct distance regulation and constant focus positioning
- Ideal beam properties at the workpiece thanks to the use of Genuine Nozzle Holders and Nozzles

Standard		
Name	Ø thread	Order no.
Nozzle holder	M8	0260432

Additional items related to the nozzle holder

Union nut		
Name	Ø thread	Order no.
Union nut	M50	0256152

Cover cap	
Name	Order no.
Cover cap	0955826

Multi-series Genuine Parts

Additional Genuine Parts that are important for your machine's productivity can be found in the chapter "Multi-series Genuine Parts".

Power Tube



Filter plate



Easy Kit



Filter cartridge



Easy Filter



TruLaser Series 2000 fiber

General Information

Genuine Parts for your machine

Genuine Accessories

Application Tips

Your order

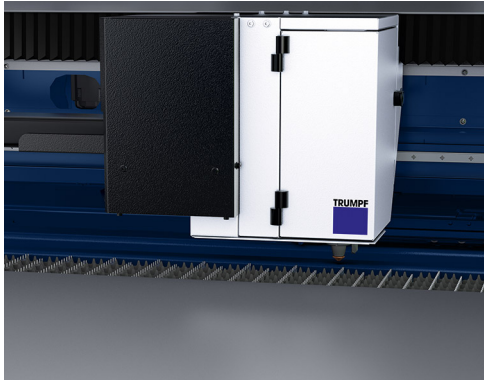

Machine type

TruLaser 2030 fiber (L72), 2030 fiber (L82)

Cutting optics type

Cutting unit

Part-relevant options

BrightLine fiber

Application tips

p. 104

Protective glass



Advantages of the Genuine Protective Glass

- Optimal protection of the beam path against disruptive contamination
- Top cutting result thanks to special coating and excellent glass purity

Protective glass

Name	Ø	Order no.
Protective glass D34	34.0 mm	2602937

Nozzle

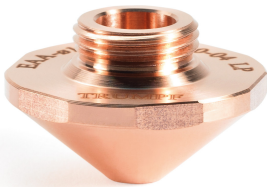

Advantages of the Genuine Nozzle

- Excellent cut quality in every processing direction thanks to direction-independent gas flow
- Cutting gas consumption minimized due to precise geometries and strict production tolerances
- Best cutting result thanks to minimal spatter adhesion on the nozzle surface

Standard (Pack of 5)

Name	Ø	Order no.
Nozzle EAA	0.8 mm	1324858
	1.0 mm	1324860
	1.2 mm	1324861
	1.4 mm	1324863
	1.7 mm	1324864
	2.0 mm	1324865
	2.3 mm	1324866
	2.7 mm	1324867

Slim (Pack of 5)

Name	Ø	Order no.
Nozzle EAB	0.8 mm	1373324
	1.0 mm	1373325
	1.2 mm	1373326
	1.4 mm	1373327
	1.7 mm	1373328
	2.0 mm	1373329
	2.3 mm	1373330
	2.7 mm	1373331

BrightLine

Name	Ø	Order no.
Nozzle EAK	4.0 mm	1835747
Nozzle EAQ	7.5 mm	1809421

Nozzle holder



Advantages of the Genuine Nozzle Holder

- Perfect focus position - High-grade ceramic ensures correct distance control
- Nozzle changer – Only fully usable with Genuine Nozzle Holder

Standard / BrightLine		
Name	Ø thread	Order no.
Nozzle holder	M12	1755673

Additional items related to the nozzle holder

Union nut		
Name	Ø thread	Order no.
Union nut	M48	1339994

Crossjet nozzle (Pack of 5)		
Name	Ø	Order no.
Crossjet nozzle	2.0 mm	1384753

Multi-series Genuine Parts

Additional Genuine Parts that are important for your machine's productivity can be found in the chapter "Multi-series Genuine Parts".

Filter plate

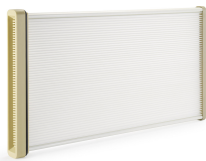

Easy Kit



Filter cartridge



TruLaser Series 3000

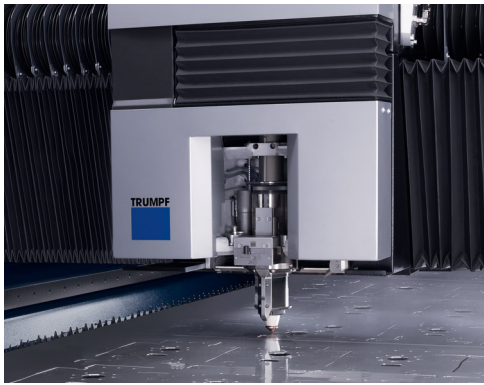

Machine type

TruLaser 3030 (L20), 3030 Lean Edition, 3040 (L32)

Cutting optics type

Cutting head with mm focal length and nozzle with M12 connection thread

Part-relevant options

BrightLine, CoolLine

Application tips

p. 104

General Information

Genuine Parts for your machine

Genuine Accessories

Application Tips

Your order

Lens



Advantages of the Genuine Lens

- Over 40 % time saving thanks to needs-based lens cleaning
- Increased process reliability thanks to RFID condition monitoring
- Lower part costs thanks to optimized cleaning cycles

Cut-lens with RFID chip

Name	Focal length	Order no.
ZnSe lens 130 D40	130 mm	1772319
ZnSe lens 250 D40	250 mm	1770805

Nozzle

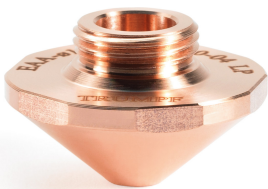

Advantages of the Genuine Nozzle

- Excellent cut quality in every processing direction thanks to direction-independent gas flow
- Cutting gas consumption minimized due to precise geometries and strict production tolerances
- High process reliability due to perfect interaction with the nozzle changer

Standard (Pack of 5)

Name	Ø	Order no.
Nozzle EAA	0.8 mm	1324858
	1.0 mm	1324860
	1.2 mm	1324861
	1.4 mm	1324863
	1.7 mm	1324864
	2.0 mm	1324865
	2.3 mm	1324866
	2.7 mm	1324867

BrightLine

Name	Ø	Order no.
Nozzle EAN	1.7 mm	1664569
	2.0 mm	1664602
	2.5 mm	1664625
Nozzle EAC	5.3 mm	1633046

Slim (Pack of 5)

Name	Ø	Order no.
Nozzle EAB	0.8 mm	1373324
	1.0 mm	1373325
	1.2 mm	1373326
	1.4 mm	1373327
	1.7 mm	1373328
	2.0 mm	1373329
	2.3 mm	1373330
	2.7 mm	1373331

CoolLine

Name	Ø	Order no.
Nozzle EFL	1.4 mm	1774018
	1.7 mm	1838745
	2.0 mm	1774020
	2.3 mm	1774092

Nozzle holder



Advantages of the Genuine Nozzle Holder

- High-grade raw materials for correct distance regulation and constant focus positioning
- Full utilization of nozzle changer functionality with the Original

Standard / BrightLine

Name	Ø thread	Order no.
Nozzle holder	M12	1755673

CoolLine

Name	Ø thread	Order no.
Nozzle holder	M28	1707005

Additional items related to the nozzle holder

Union nut

Name	Ø thread	Order no.
Union nut	M48	1339994
Union nut, CoolLine	M60	1668992

Multi-series Genuine Parts

Additional Genuine Parts that are important for your machine's productivity can be found in the chapter "Multi-series Genuine Parts".

Power Tube



Filter plate



Easy Kit



Filter cartridge



Easy Filter



TruLaser Series 3000

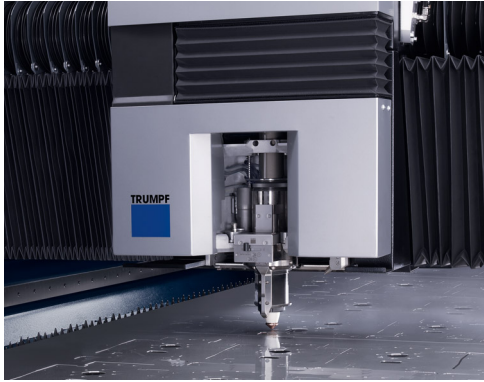

Machine type

TruLaser Starting with version 09.00: 3030 (L20), 3030 Lean Edition, 3040 (L32)

Cutting optics type

Cutting head with mm focal length and nozzle with M12 connection thread

Part-relevant options

BrightLine, CoolLine

Application tips

p. 104

General Information

Genuine Parts for your machine

Genuine Accessories

Application Tips

Your order

Lens



Advantages of the Genuine Lens

- Over 40 % time saving thanks to needs-based lens cleaning
- Increased process reliability thanks to RFID condition monitoring
- Lower part costs thanks to optimized cleaning cycles

Cut-lens with RFID chip

Name	Focal length	Order no.
ZnSe lens 250 D40	250 mm	1770805

Nozzle



Advantages of the Genuine Nozzle

- Excellent cut quality in every processing direction thanks to direction-independent gas flow
- Cutting gas consumption minimized due to precise geometries and strict production tolerances
- High process reliability due to perfect interaction with the nozzle changer

Standard (Pack of 5)

Name	Ø	Order no.
Nozzle EAA	0.8 mm	1324858
	1.0 mm	1324860
	1.2 mm	1324861
	1.4 mm	1324863
	1.7 mm	1324864
	2.0 mm	1324865
	2.3 mm	1324866
	2.7 mm	1324867

BrightLine

Name	Ø	Order no.
Nozzle EAQ	6.0 mm	1809091
	7.5 mm	1809421
	9.5 mm	1886199
Nozzle EAC	5.3 mm	1633046

Slim (Pack of 5)

Name	Ø	Order no.
Nozzle EAB	0.8 mm	1373324
	1.0 mm	1373325
	1.2 mm	1373326
	1.4 mm	1373327
	1.7 mm	1373328
	2.0 mm	1373329
	2.3 mm	1373330
	2.7 mm	1373331

CoolLine

Name	Ø	Order no.
Nozzle EGL	1.4 mm	1879940
	1.7 mm	1879951
	2.0 mm	1879952
	2.3 mm	1879953

Nozzle holder



Advantages of the Genuine Nozzle holder

- High-grade raw materials for correct distance regulation and constant focus positioning
- Full utilization of nozzle changer functionality with the Original

Standard / BrightLine

Name	Ø thread	Order no.
Nozzle holder	M12	1755673

Standard / BrightLine / CoolLine

Name	Ø thread	Order no.
Nozzle holder	M12	1906032

Additional items related to the nozzle holder

Union nut

Name	Ø thread	Order no.
Union nut	M48	1339994

Crossjet nozzle (Pack of 5)

Name	Ø	Order no.
Crossjet nozzle	2.0 mm	1589610

Multi-series Genuine Parts

Additional Genuine Parts that are important for your machine's productivity can be found in the chapter "Multi-series Genuine Parts".

Power Tube



Filter plate



Easy Kit



Filter cartridge



Easy Filter



TruLaser Series 3000

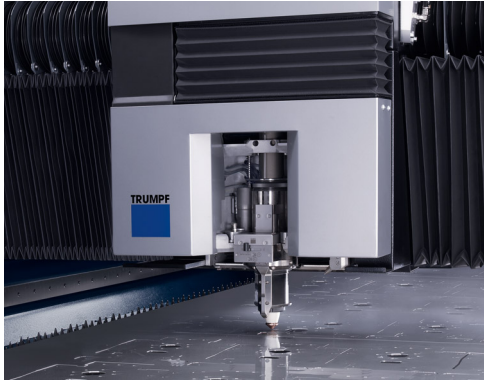

Machine type

TruLaser 3030 (L55), 3030 Basic Edition (L77), 3030 Prime Edition (L77), 3040 Prime Edition (L70)

Cutting optics type

Cutting head with mm focal length and nozzle with M12 connection thread

Part-relevant options

CoolLine

Application tips

p. 104

General Information

Genuine Parts for your machine

Genuine Accessories

Application Tips

Your order

Lens



Advantages of the Genuine Lens

- Over 40 % time saving thanks to needs-based lens cleaning
- Increased process reliability thanks to RFID condition monitoring
- Lower part costs thanks to optimized cleaning cycles

Cut-lens with RFID chip

Name	Focal length	Order no.
ZnSe lens 130 D40	130 mm	1772319
ZnSe lens 250 D40	250 mm	1770805

Nozzle



Advantages of the Genuine Nozzle

- Excellent cut quality in every processing direction thanks to direction-independent gas flow
- Cutting gas consumption minimized due to precise geometries and strict production tolerances
- Best cutting result thanks to minimal spatter adhesion on the nozzle surface

Standard (Pack of 5)

Name	Ø	Order no.
Nozzle EAA	0.8 mm	1324858
	1.0 mm	1324860
	1.2 mm	1324861
	1.4 mm	1324863
	1.7 mm	1324864
	2.0 mm	1324865
	2.3 mm	1324866
	2.7 mm	1324867

Slim (Pack of 5)

Name	Ø	Order no.
Nozzle EAB	0.8 mm	1373324
	1.0 mm	1373325
	1.2 mm	1373326
	1.4 mm	1373327
	1.7 mm	1373328
	2.0 mm	1373329
	2.3 mm	1373330
	2.7 mm	1373331

CoolLine

Name	Ø	Order no.
Nozzle EFL	1.4 mm	1774018
	1.7 mm	1838745
	2.0 mm	1774020
	2.3 mm	1774092

Nozzle holder



Advantages of the Genuine Nozzle Holder

- High-grade raw materials for correct distance regulation and constant focus positioning
- Full utilization of nozzle changer functionality with the Original

Standard

Name	Ø thread	Order no.
Nozzle holder	M12	1755673

CoolLine

Name	Ø thread	Order no.
Nozzle holder	M28	1707005

Additional items related to the nozzle holder

Union nut

Name	Ø thread	Order no.
Union nut	M48	1339994
Union nut, CoolLine	M60	1668992

Crossjet nozzle (Pack of 5)

Name	Ø	Order no.
Crossjet nozzle	2.0 mm	1589610
Crossjet nozzle, CoolLine	1.0 mm	1736458

Multi-series Genuine Parts

Additional Genuine Parts that are important for your machine's productivity can be found in the chapter "Multi-series Genuine Parts".

Power Tube



Filter plate



Easy Kit



Filter cartridge



Easy Filter



TruLaser Series 3000

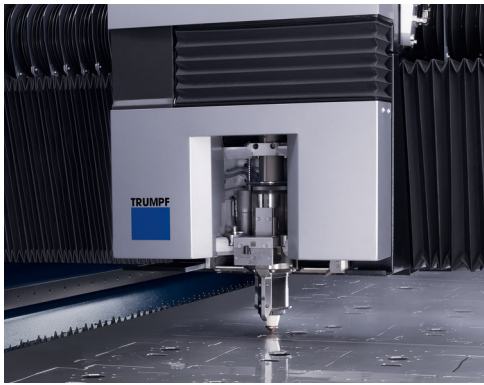

Machine type

TruLaser from version 03.00: 3030 Basic Edition (L77), 3030 Prime Edition (L77), 3040 Prime Edition (L70)

Cutting optics type

Cutting head with mm focal length and nozzle with M12 connection thread

Part-relevant options

CoolLine

Application tips

p. 104



Lens

Advantages of the Genuine Lens

- Over 40 % time saving thanks to needs-based lens cleaning
- Increased process reliability thanks to RFID condition monitoring
- Lower part costs thanks to optimized cleaning cycles

Cut-lens with RFID chip

Name	Focal length	Order no.
ZnSe lens 250 D40	250 mm	1770805



Nozzle

Advantages of the Genuine Nozzle

- Excellent cut quality in every processing direction thanks to direction-independent gas flow
- Cutting gas consumption minimized due to precise geometries and strict production tolerances
- Best cutting result thanks to minimal spatter adhesion on the nozzle surface

Standard (Pack of 5)

Name	Ø	Order no.
Nozzle EAA	0.8 mm	1324858
	1.0 mm	1324860
	1.2 mm	1324861
	1.4 mm	1324863
	1.7 mm	1324864
	2.0 mm	1324865
	2.3 mm	1324866
	2.7 mm	1324867

Slim (Pack of 5)

Name	Ø	Order no.
Nozzle EAB	0.8 mm	1373324
	1.0 mm	1373325
	1.2 mm	1373326
	1.4 mm	1373327
	1.7 mm	1373328
	2.0 mm	1373329
	2.3 mm	1373330
	2.7 mm	1373331

CoolLine

Name	Ø	Order no.
Nozzle EGL	1.4 mm	1879940
	1.7 mm	1879951
	2.0 mm	1879952
	2.3 mm	1879953

Nozzle holder



Advantages of the Genuine Nozzle Holder

- High-grade raw materials for correct distance regulation and constant focus positioning
- Full utilization of nozzle changer functionality with the Original

Standard

Name	Ø thread	Order no.
Nozzle holder	M12	1755673

Standard / CoolLine

Name	Ø thread	Order no.
Nozzle holder	M12	1906032

Additional items related to the nozzle holder

Union nut

Name	Ø thread	Order no.
Union nut	M48	1339994

Crossjet nozzle (Pack of 5)

Name	Ø	Order no.
Crossjet nozzle	2.0 mm	1589610

Multi-series Genuine Parts

Additional Genuine Parts that are important for your machine's productivity can be found in the chapter "Multi-series Genuine Parts".

Power Tube



Filter plate



Easy Kit



Filter cartridge



Easy Filter



TruLaser Series 3000 fiber



Machine type

TruLaser 3030 fiber (L49), 3030 fiber (L81), 3040 fiber (L50), 3040 fiber (L81), 3060 fiber (L66), 3060 fiber (L81)

Cutting optics type

Cutting unit

Part-relevant options

BrightLine fiber, CoolLine, Performance package, Highspeed cutting process, Highspeed Eco cutting process

Application tips

p. 104

Protective glass



Advantages of the Genuine Protective Glass

- Optimal protection of the beam path against disruptive contamination
- Top cutting result thanks to special coating and excellent glass purity

Protective glass

Name	Ø	Order no.
Protective glass D34	34.0 mm	2602937

Nozzle

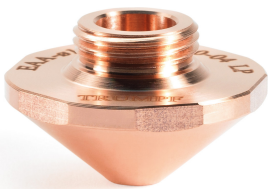

Advantages of the Genuine Nozzle

- Excellent cut quality in every processing direction thanks to direction-independent gas flow
- Cutting gas consumption minimized due to precise geometries and strict production tolerances
- High process reliability due to perfect interaction with the nozzle changer

Standard (Pack of 5)

Name	Ø	Order no.
Nozzle EAA	0.8 mm	1324858
	1.0 mm	1324860
	1.2 mm	1324861
	1.4 mm	1324863
	1.7 mm	1324864
	2.0 mm	1324865
	2.3 mm	1324866
	2.7 mm	1324867

BrightLine

Name	Ø	Order no.
Nozzle EAK	4.0 mm	1835747
Nozzle EAQ	6.0 mm	1809091
	7.5 mm	1809421
	9.5 mm	1886199

CoolLine

Name	Ø	Order no.
Nozzle EGL	1.4 mm	1879940
	1.7 mm	1879951
	2.0 mm	1879952
	2.3 mm	1879953

Slim (Pack of 5)

Name	Ø	Order no.
Nozzle EAB	0.8 mm	1373324
	1.0 mm	1373325
	1.2 mm	1373326
	1.4 mm	1373327
	1.7 mm	1373328
	2.0 mm	1373329
	2.3 mm	1373330
	2.7 mm	1373331

Performance (Pack of 5)

Name	Ø	Order no.
Nozzle EAU	2.5 mm	2059462
	3.0 mm	2060001
	4.0 mm	2060004
	6.0 mm	2060025

Highspeed (packaging unit x 5)

Name	Ø	Order no.
Nozzle EAU	10.0 mm	2253595

Highspeed Eco

Name	Ø	Order no.
Nozzle EAV (x 1)		2228806
Inner part EAV (x 5)	3.0 mm	2228802
Sleeve EAV (x 20)		2284349

Nozzle holder



Advantages of the Genuine Nozzle Holder

- High-grade raw materials for correct distance regulation and constant focus positioning
- Full utilization of nozzle changer functionality with the Original

Standard / BrightLine		
Name	Ø thread	Order no.
Nozzle holder	M12	1755673

Standard / BrightLine / CoolLine		
Name	Ø thread	Order no.
Nozzle holder	M12	1906032

Additional items related to the nozzle holder

Union nut		
Name	Ø thread	Order no.
Union nut	M48	1339994

Crossjet nozzle (Pack of 5)		
Name	Ø	Order no.
Crossjet nozzle	2.0 mm	1384753

Multi-series Genuine Parts

Additional Genuine Parts that are important for your machine's productivity can be found in the chapter "Multi-series Genuine Parts".

Filter plate



Easy Kit



Filter cartridge



Easy Filter



TruLaser Serie 3000 fiber

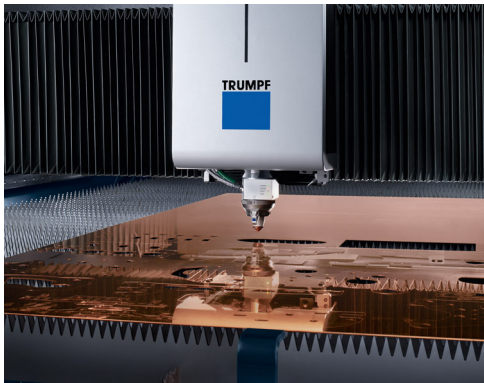

Machine type

TruLaser 3030 fiber (L95), 3040 fiber (L95), 3060 fiber (L95), 3080 fiber (L95)

Cutting optics type

Cutting unit

Part-relevant options

BrightLine fiber, CoolLine, Performance package, Highspeed cutting process, Highspeed Eco cutting process

Application tips

p. 104

Protective glas



Advantages of the Genuine Protective Glass

- Optimal protection of the beam path against disruptive contamination
- Top cutting result thanks to special coating and excellent glass purity

Protective glass

Name	Ø	Order no.
Protective glass	30.0 mm	0766719
Protective glass D34	34.0 mm	2602937

Nozzle



Advantages of the Genuine Nozzle

- Excellent cut quality in every processing direction thanks to direction-independent gas flow
- Cutting gas consumption minimized due to precise geometries and strict production tolerances
- High process reliability due to perfect interaction with the nozzle changer

Standard (Pack of 5)

Name	Ø	Order no.
Nozzle EAA	0.8 mm	1324858
	1.0 mm	1324860
	1.2 mm	1324861
	1.4 mm	1324863
	1.7 mm	1324864
	2.0 mm	1324865
	2.3 mm	1324866
2.7 mm	1324867	

BrightLine

Name	Ø	Order no.
Nozzle EAK	4.0 mm	1835747
Nozzle EAQ	6.0 mm	1809091
	7.5 mm	1809421
	9.5 mm	1886199

CoolLine

Name	Ø	Order no.
Nozzle EGL	1.4 mm	1879940
	1.7 mm	1879951
	2.0 mm	1879952
	2.3 mm	1879953

Slim (Pack of 5)

Name	Ø	Order no.
Nozzle EAB	0.8 mm	1373324
	1.0 mm	1373325
	1.2 mm	1373326
	1.4 mm	1373327
	1.7 mm	1373328
	2.0 mm	1373329
	2.3 mm	1373330
2.7 mm	1373331	

Performance (packaging unit x 5)

Name	Ø	Order no.
Nozzle EAU	2.5 mm	2059462
	3.0 mm	2060001
	4.0 mm	2060004
	6.0 mm	2060025

Highspeed (packaging unit x 5)

Name	Ø	Order no.
Nozzle EAU	10.0 mm	2253595

Highspeed Eco

Name	Ø	Order no.
Nozzle EAV (x 1)		2228806
Inner part EAV (x 5)	3.0 mm	2228802
Sleeve EAV (x 20)		2284349

Nozzle holder



Advantages of the Genuine Nozzle Holder

- High-grade raw materials for correct distance regulation and constant focus positioning
- Full utilization of nozzle changer functionality with the Original

Standard / BrightLine

Name	Ø thread	Order no.
Nozzle holder	M12	1755673

Standard / BrightLine / CoolLine

Name	Ø thread	Order no.
Nozzle holder	M12	1906032

Other items relating to the nozzle holder

Union nut

Name	Ø thread	Order no.
Union nut	M48	1339994

Crossjet nozzle (Pack of 5)

Name	Ø	Order no.
Crossjet nozzle	2.0 mm	1384753

Multi-series Genuine Parts

Additional Genuine Parts that are important for your machine's productivity can be found in the chapter "Multi-series Genuine Parts".

Filter element



Easy Kit



Filter cartridge



Easy Filter



TruLaser Series 3000 fiber



Machine type

TruLaser 3030 Prime Edition (L75), 3040 Prime Edition (L79)

Cutting optics type

Cutting unit

Part-relevant options

BrightLine fiber, Performance package, Highspeed cutting process

Application tips

p. 104

Protective glass



Advantages of the Genuine Protective Glass

- Optimal protection of the beam path against disruptive contamination
- Top cutting result thanks to special coating and excellent glass purity

Protective glass

Name	Ø	Order no.
Protective glass D34	34.0 mm	2602937

Nozzle

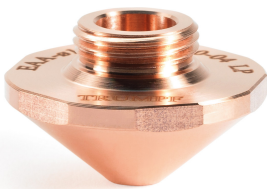

Advantages of the Genuine Nozzle

- Excellent cut quality in every processing direction thanks to direction-independent gas flow
- Cutting gas consumption minimized due to precise geometries and strict production tolerances
- Best cutting result thanks to minimal spatter adhesion on the nozzle surface

Standard (Pack of 5)

Name	Ø	Order no.
Nozzle EAA	0.8 mm	1324858
	1.0 mm	1324860
	1.2 mm	1324861
	1.4 mm	1324863
	1.7 mm	1324864
	2.0 mm	1324865
	2.3 mm	1324866
2.7 mm	1324867	

Slim (Pack of 5)

Name	Ø	Order no.
Nozzle EAB	0.8 mm	1373324
	1.0 mm	1373325
	1.2 mm	1373326
	1.4 mm	1373327
	1.7 mm	1373328
	2.0 mm	1373329
	2.3 mm	1373330
2.7 mm	1373331	

BrightLine

Name	Ø	Order no.
Nozzle EAK	4.0 mm	1835747
Nozzle EAQ	6.0 mm	1809091
	7.5 mm	1809421
	9.5 mm	1886199

Performance (packaging unit x 5)

Name	Ø	Order no.
Nozzle EAU	2.5 mm	2059462
	3.0 mm	2060001
	4.0 mm	2060004
	6.0 mm	2060025

Highspeed (packaging unit x 5)

Name	Ø	Order no.
Nozzle EAU	10.0 mm	2253595

Nozzle holder



Advantages of the Genuine Nozzle Holder

- High-grade raw materials for correct distance regulation and constant focus positioning
- Full utilization of nozzle changer functionality with the Original

Standard		
Name	Ø thread	Order no.
Nozzle holder	M12	1755673

Additional items related to the nozzle holder

Union nut		
Name	Ø thread	Order no.
Union nut	M48	1339994

Crossjet nozzle (Pack of 5)		
Name	Ø	Order no.
Crossjet nozzle	2.0 mm	1384753

Multi-series Genuine Parts

Additional Genuine Parts that are important for your machine's productivity can be found in the chapter "Multi-series Genuine Parts".

Filter plate



Easy Kit



Filter cartridge



Easy Filter



TruLaser Series 5000

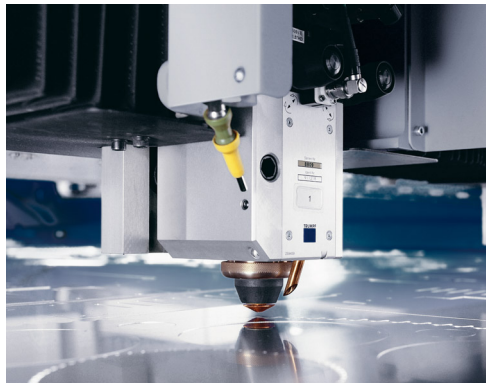

Machine type

TruLaser	5030 Classic Edition, up to version 02.00: 5030 (L16)
TCL	3050, 4050, 6050

Cutting optics type

Cutting head with inch focal length and nozzle with M8 connection thread

Application tips

p. 104

Lens



Advantages of the Genuine Lens

- Optimal process reliability with the lens failure sensor system
- Plug & play based on perfectly combined cutting parameters
- Optimum cutting result based on tried and proven TRUMPF quality

High-pressure lens

Name	Focal length	Order no.
ZnSe high-pressure lens	3.75 "	0346104
	5 "	0088114
	7.5 "	0097517
	9 "	0141972
	10 "	0350163

Nozzle



Advantages of the Genuine Nozzle

- Outstanding parts quality: made in Germany
- Excellent cut quality in every processing direction thanks to direction-independent gas flow
- Cutting gas consumption minimized due to precise geometries and strict production tolerances

Not chrome-plated (Pack of 5)

Name	Ø	Order no.
Nozzle ECE, not chrome-plated	0.8 mm	0124561
	1.0 mm	0124562
	1.2 mm	0966809
	1.4 mm	0237497
	1.7 mm	0237501
	2.0 mm	1253211
	2.3 mm	0126933
	2.7 mm	0942742

Chrome-plated (Pack of 5)

Name	Ø	Order no.
Nozzle ECE, chrome-plated	0.8 mm	0352280
	1.0 mm	0352281
	1.2 mm	0352282
	1.4 mm	0352283
	1.7 mm	0352284
	2.0 mm	1253212
	2.3 mm	0352285
	2.7 mm	0352286

Nozzle holder



Advantages of the Genuine Nozzle Holder

- High-grade raw materials for correct distance regulation and constant focus positioning
- Ideal beam properties at the workpiece thanks to the use of Genuine Nozzle Holders and Nozzles

Standard		
Name	Ø thread	Order no.
Nozzle holder	M8	0260432

Additional items related to the nozzle holder

Union nut		
Name	Ø thread	Order no.
Union nut	M50	0256152

Cover cap	
Name	Order no.
Cover cap	0955826

Multi-series Genuine Parts

Additional Genuine Parts that are important for your machine's productivity can be found in the chapter "Multi-series Genuine Parts".

Power Tube



Filter plate



Easy Kit



Filter cartridge



Easy Filter



TruLaser Series 5000

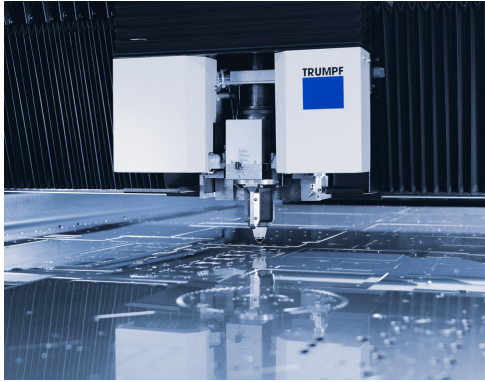

Machine type

TruLaser 5030 (L16), 5040 (L18), 5060 (L19)

Cutting optics type

Cutting head with mm focal length and nozzle with M12 connection thread

Part-relevant options

BrightLine, CoolLine, Mirror cutting head

Application tips

p. 104

General Information

Genuine Parts for your machine

Genuine Accessories

Application Tips

Your order

Lens



Advantages of the Genuine Lens

- Over 40 % time saving thanks to needs-based lens cleaning
- Increased process reliability thanks to RFID condition monitoring
- Lower part costs thanks to optimized cleaning cycles

Cut-lens with RFID chip

Name	Focal length	Order no.
ZnSe lens 175 D50	175 mm	1795719
ZnSe lens 250 D50	250 mm	1796128

Nozzle



Advantages of the Genuine Nozzle

- Excellent cut quality in every processing direction thanks to direction-independent gas flow
- Cutting gas consumption minimized due to precise geometries and strict production tolerances
- High process reliability due to perfect interaction with the nozzle changer

Standard (Pack of 5)

Name	Ø	Order no.
Nozzle EAA	0.8 mm	1324858
	1.0 mm	1324860
	1.2 mm	1324861
	1.4 mm	1324863
	1.7 mm	1324864
	2.0 mm	1324865
	2.3 mm	1324866
	2.7 mm	1324867

BrightLine

Name	Ø	Order no.
Nozzle EAK	2.5 mm	1579549
Nozzle EAK	3.0 mm	1579556
Nozzle EAC	5.3 mm	1633046

Slim (Pack of 5)

Name	Ø	Order no.
Nozzle EAB	0.8 mm	1373324
	1.0 mm	1373325
	1.2 mm	1373326
	1.4 mm	1373327
	1.7 mm	1373328
	2.0 mm	1373329
	2.3 mm	1373330
	2.7 mm	1373331

CoolLine

Name	Ø	Order no.
Nozzle EFL	1.4 mm	1774018
	1.7 mm	1838745
	2.0 mm	1774020
	2.3 mm	1774092

Mirror cutting head (two-part nozzle)		
Name	Ø	Order no.
Nozzle exterior part AAC	1.0 mm	1791595
Nozzle exterior part AAA	2.0 mm	1791698
Nozzle exterior part AAL	2.3 mm	1791899
Nozzle exterior part AAI	2.7 mm	1791882
Nozzle exterior part AAH	3.0 mm	1791895
Nozzle exterior part AAM	3.3 mm	1791863
Nozzle exterior part AAO	7.5 mm	1792008
Nozzle exterior part AAP	9.2 mm	1792007

Mirror cutting head (two-part nozzle)	
Name	Order no.
Nozzle interior part IAA	1791597
Nozzle interior part IAC	1791697
Nozzle interior part IAF	1791900
Nozzle interior part IAG	1791884
Nozzle interior part IAG	1792355
Nozzle interior part IAH	1791865
Nozzle interior part IAA	1792002
Nozzle interior part IAA	1792001

Nozzle holder



Advantages of the Genuine Nozzle Holder

- High-grade raw materials for correct distance regulation and constant focus positioning
- Full utilization of nozzle changer functionality with the Original

Standard / BrightLine		
Name	Ø thread	Order no.
Nozzle holder	M12	1755673

CoolLine		
Name	Ø thread	Order no.
Nozzle holder	M28	1707005

Mirror cutting head		
Name	Ø thread	Order no.
Nozzle holder	M22	1791593

Additional items related to the nozzle holder

Union nut		
Name	Ø thread	Order no.
Union nut	M48	1339994
Union nut, CoolLine	M60	1668992
Union nut, mirror cutting head	M60	1474082

Crossjet nozzle		
Name	Ø	Order no.
Crossjet nozzle	2.0 mm	1384753
Crossjet nozzle, CoolLine	1.0 mm	1736458

Multi-series Genuine Parts

Additional Genuine Parts that are important for your machine's productivity can be found in the chapter "Multi-series Genuine Parts".

Power Tube



Filter plate



Easy Kit



Filter cartridge



Easy Filter



TruLaser Series 5000

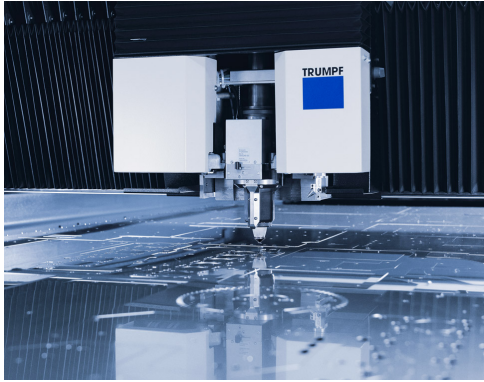

Machine type

TruLaser 5030 (L52), 5040 (L53), 5060 (L54)

Cutting optics type

Cutting head with mm focal length and nozzle with M12 connection thread

Part-relevant options

BrightLine, CoolLine, Mirror cutting head

Application tips

p. 104

Lens



Advantages of the Genuine Lens

- Over 40 % time saving thanks to needs-based lens cleaning
- Increased process reliability thanks to RFID condition monitoring
- Lower part costs thanks to optimized cleaning cycles

Cut-lens with RFID chip

Name	Focal length	Order no.
ZnSe lens 175 D50	175 mm	1795719
ZnSe lens 250 D50	250 mm	1796128

Nozzle



Advantages of the Genuine Nozzle

- Excellent cut quality in every processing direction thanks to direction-independent gas flow
- Cutting gas consumption minimized due to precise geometries and strict production tolerances
- High process reliability due to perfect interaction with the nozzle changer

Standard (Pack of 5)

Name	Ø	Order no.
Nozzle EAA	0.8 mm	1324858
	1.0 mm	1324860
	1.2 mm	1324861
	1.4 mm	1324863
	1.7 mm	1324864
	2.0 mm	1324865
	2.3 mm	1324866
	2.7 mm	1324867

BrightLine

Name	Ø	Order no.
Nozzle EAK	2.5 mm	1579549
	3.0 mm	1579556
	6.0 mm	1809091
Nozzle EAQ	7.5 mm	1809421
	9.5 mm	1886199

Slim (Pack of 5)

Name	Ø	Order no.
Nozzle EAB	0.8 mm	1373324
	1.0 mm	1373325
	1.2 mm	1373326
	1.4 mm	1373327
	1.7 mm	1373328
	2.0 mm	1373329
	2.3 mm	1373330
	2.7 mm	1373331

CoolLine

Name	Ø	Order no.
Nozzle EGL	1.4 mm	1879940
	1.7 mm	1879951
	2.0 mm	1879952
	2.3 mm	1879953

Mirror cutting head (two-part nozzle)		
Name	Ø	Order no.
Nozzle exterior part AAC	1.0 mm	1791595
Nozzle exterior part AAA	2.0 mm	1791698
Nozzle exterior part AAL	2.3 mm	1791899
Nozzle exterior part AAI	2.7 mm	1791882
Nozzle exterior part AAH	3.0 mm	1791895
Nozzle exterior part AAM	3.3 mm	1791863
Nozzle exterior part AAO	7.5 mm	1792008
Nozzle exterior part AAP	9.2 mm	1792007

Mirror cutting head (two-part nozzle)	
Name	Order no.
Nozzle interior part IAA	1791597
Nozzle interior part IAC	1791697
Nozzle interior part IAF	1791900
Nozzle interior part IAG	1791884
Nozzle interior part IAG	1792355
Nozzle interior part IAH	1791865
Nozzle interior part IAA	1792002
Nozzle interior part IAA	1792001

Nozzle holder



Advantages of the Genuine Nozzle Holder

- High-grade raw materials for correct distance regulation and constant focus positioning
- Full utilization of nozzle changer functionality with the Original

Standard / BrightLine		
Name	Ø thread	Order no.
Nozzle holder	M12	1755673

Standard / BrightLine / CoolLine		
Name	Ø thread	Order no.
Nozzle holder	M12	1906032

Mirror cutting head		
Name	Ø thread	Order no.
Nozzle holder	M22	1791593

Additional items related to the nozzle holder

Union nut		
Name	Ø thread	Order no.
Union nut	M48	1339994
Union nut, mirror cutting head	M60	1474082

Crossjet nozzle		
Name	Ø	Order no.
Crossjet nozzle	2.0 mm	1384753
Crossjet nozzle, CoolLine	1.0 mm	1736458

Multi-series Genuine Parts

Additional Genuine Parts that are important for your machine's productivity can be found in the chapter "Multi-series Genuine Parts".

Power Tube



Filter plate



Easy Kit



Filter cartridge



Easy Filter



TruLaser Series 5000 fiber

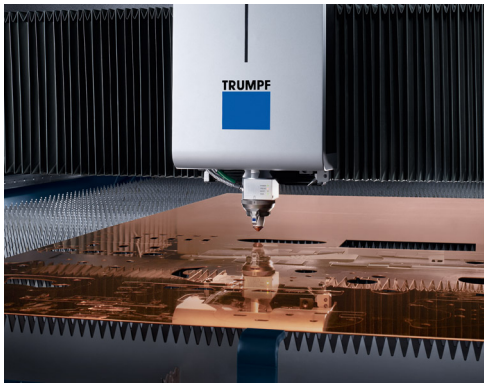

Machine type

TruLaser 5030 fiber (L41), 5030 fiber (L56), 5040 fiber (L47), 5040 fiber (L57)

Cutting optics type

Cutting unit

Part-relevant options

BrightLine fiber

Application tips

p. 104

Protective glass



Advantages of the Genuine Protective Glass

- Optimal protection of the beam path against disruptive contamination
- Top cutting result thanks to special coating and excellent glass purity

Protective glass

Name	Ø	Order no.
Protective glass D34	34.0 mm	2602937

Nozzle

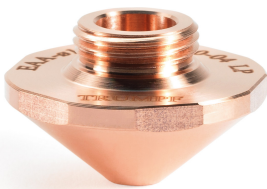

Advantages of the Genuine Nozzle

- Excellent cut quality in every processing direction thanks to direction-independent gas flow
- Cutting gas consumption minimized due to precise geometries and strict production tolerances
- High process reliability due to perfect interaction with the nozzle changer

Standard (Pack of 5)

Name	Ø	Order no.
Nozzle EAA	0.8 mm	1324858
	1.0 mm	1324860
	1.2 mm	1324861
	1.4 mm	1324863
	1.7 mm	1324864
	2.0 mm	1324865
	2.3 mm	1324866
	2.7 mm	1324867

Slim (Pack of 5)

Name	Ø	Order no.
Nozzle EAB	0.8 mm	1373324
	1.0 mm	1373325
	1.2 mm	1373326
	1.4 mm	1373327
	1.7 mm	1373328
	2.0 mm	1373329
	2.3 mm	1373330
	2.7 mm	1373331

BrightLine

Name	Ø	Order no.
Nozzle EAK	4.0 mm	1835747
Nozzle EAQ	7.5 mm	1809421

Nozzle holder



Advantages of the Genuine Nozzle Holder

- High-grade raw materials for correct distance regulation and constant focus positioning
- Full utilization of nozzle changer functionality with the Original

Standard / BrightLine		
Name	Ø thread	Order no.
Nozzle holder	M12	1755673

Additional items related to the nozzle holder

Union nut		
Name	Ø thread	Order no.
Union nut	M48	1339994

Crossjet nozzle (Pack of 5)		
Name	Ø	Order no.
Crossjet nozzle	2.0 mm	1384753

Multi-series Genuine Parts

Additional Genuine Parts that are important for your machine's productivity can be found in the chapter "Multi-series Genuine Parts".

Filter plate



Easy Kit



Filter cartridge



Easy Filter



TruLaser Series 5000 fiber

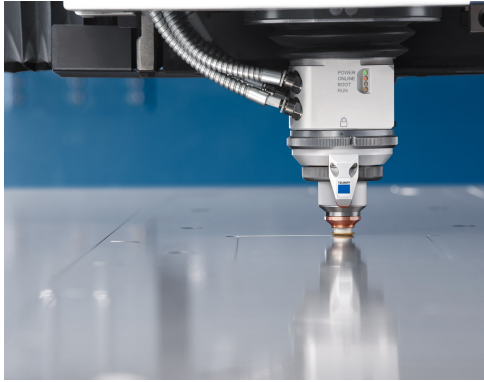

Machine type	TruLaser	5030 fiber (L68), 5040 fiber (L69)
Cutting optics type		Cutting unit
Part-relevant options		BrightLine fiber, CoolLine, Performance package, Highspeed cutting process, Highspeed Eco cutting process
Application tips		p. 104

Protective glass



- Advantages of the Genuine Protective Glass**
- Optimal protection of the beam path against disruptive contamination
 - Top cutting result thanks to special coating and excellent glass purity

Protective glass		
Name	Ø	Order no.
Protective glass	30.0 mm	0766719

Nozzle



- Advantages of the Genuine Nozzle**
- Excellent cut quality in every processing direction thanks to direction-independent gas flow
 - Cutting gas consumption minimized due to precise geometries and strict production tolerances
 - High process reliability due to perfect interaction with the nozzle changer

Standard (Pack of 5)		
Name	Ø	Order no.
Nozzle EAA	0.8 mm	1324858
	1.0 mm	1324860
	1.2 mm	1324861
	1.4 mm	1324863
	1.7 mm	1324864
	2.0 mm	1324865
	2.3 mm	1324866
	2.7 mm	1324867

BrightLine		
Name	Ø	Order no.
Nozzle EAK	4.0 mm	1835747
Nozzle EAQ	6.0 mm	1809091
	7.5 mm	1809421
	9.5 mm	1886199

Performance (Pack of 5)		
Name	Ø	Order no.
Nozzle EAU	2.5 mm	2059462
	3.0 mm	2060001
	4.0 mm	2060004
	6.0 mm	2060025

Slim (Pack of 5)		
Name	Ø	Order no.
Nozzle EAB	0.8 mm	1373324
	1.0 mm	1373325
	1.2 mm	1373326
	1.4 mm	1373327
	1.7 mm	1373328
	2.0 mm	1373329
	2.3 mm	1373330
	2.7 mm	1373331

CoolLine		
Name	Ø	Order no.
Nozzle EGL	1.4 mm	1879940
	1.7 mm	1879951
	2.0 mm	1879952
	2.3 mm	1879953

Highspeed (packaging unit x 5)		
Name	Ø	Order no.
Nozzle EAU	10.0 mm	2253595

Highspeed Eco		
Name	Ø	Order no.
Nozzle EAV (x 1)		2228806
Inner part EAV (x 5)	3.0 mm	2228802
Sleeve EAV (x 20)		2284349

Nozzle holder



Advantages of the Genuine Nozzle Holder

- High-grade raw materials for correct distance regulation and constant focus positioning
- Full utilization of nozzle changer functionality with the Original

Standard / BrightLine		
Name	Ø thread	Order no.
Nozzle holder	M12	1755673

Standard / BrightLine / CoolLine		
Name	Ø thread	Order no.
Nozzle holder	M12	1906032

Additional items related to the nozzle holder

Union nut		
Name	Ø thread	Order no.
Union nut	M48	1339994

Crossjet nozzle (Pack of 5)		
Name	Ø	Order no.
Crossjet nozzle	2.0 mm	1384753

Multi-series Genuine Parts

Additional Genuine Parts that are important for your machine's productivity can be found in the chapter "Multi-series Genuine Parts".

Filter plate



Easy Kit



Filter cartridge



Easy Filter



TruLaser Series 5000 fiber

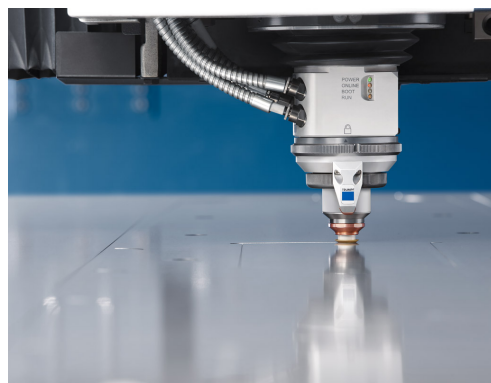

Machine type

TruLaser 5030 fiber (L76), 5040 fiber (L76), 5060 fiber (L76)

Cutting optics type

Cutting unit

Part-relevant options

BrightLine fiber, CoolLine, Performance package, Highspeed cutting process, Highspeed Eco cutting process, Active Speed Control

Application tips

p. 104

Protective glass



Advantages of the Genuine Protective Glass

- Optimal protection of the beam path against disruptive contamination
- Top cutting result thanks to special coating and excellent glass purity

Protective glass

Name	Ø	Order no.
Protective glass	30.0 mm	0766719

Nozzle

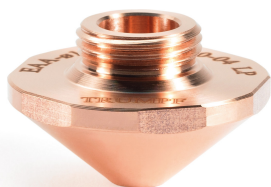

Advantages of the Genuine Nozzle

- Excellent cut quality in every processing direction thanks to direction-independent gas flow
- Cutting gas consumption minimized due to precise geometries and strict production tolerances
- High process reliability due to perfect interaction with the nozzle changer

Standard (packaging unit x 5)

Name	Ø	Order no.
Nozzle EAA	0.8 mm	1324858
	1.0 mm	1324860
	1.2 mm	1324861
	1.4 mm	1324863
	1.7 mm	1324864
	2.0 mm	1324865
	2.3 mm	1324866
	2.7 mm	1324867

BrightLine

Name	Ø	Order no.
Nozzle EAK	4.0 mm	1835747
Nozzle EAQ	6.0 mm	1809091
	7.5 mm	1809421
	9.5 mm	1886199

Performance (packaging unit x 5)

Name	Ø	Order no.
Nozzle EAU	2.5 mm	2059462
	3.0 mm	2060001
	4.0 mm	2060004
	6.0 mm	2060025

Slim (packaging unit x 5)

Name	Ø	Order no.
Nozzle EAB	0.8 mm	1373324
	1.0 mm	1373325
	1.2 mm	1373326
	1.4 mm	1373327
	1.7 mm	1373328
	2.0 mm	1373329
	2.3 mm	1373330
	2.7 mm	1373331

CoolLine

Name	Ø	Order no.
Nozzle EGL	1.4 mm	1879940
	1.7 mm	1879951
	2.0 mm	1879952
	2.3 mm	1879953

Highspeed (packaging unit x 5)

Name	Ø	Order no.
Nozzle EAU	10.0 mm	2253595

Highspeed Eco

Name	Ø	Order no.
Nozzle EAV (x 1)		2228806
Inner part EAV (x 5)	3.0 mm	2228802
Sleeve EAV (x 20)		2284349

TruLaser Series 5000 fiber

Standard, reflection-free (Pack of 5)		
Name	Ø	Order no.
Nozzle CAA	0.8 mm	2488819
	1.0 mm	2488864
	1.2 mm	2472681
	1.4 mm	2472683
	1.7 mm	2488865
	2.0 mm	2472684
	2.3 mm	2488868
2.7 mm	2488902	

CoolLine, reflection-free		
Name	Ø	Order no.
Nozzle CGL	1.4 mm	2484583
	1.7 mm	2484629
	2.0 mm	2484725
	2.3 mm	2484771

Highspeed Eco, reflection-free		
Name	Ø	Order no.
Nozzle CAV (1 pc)		2493840
Inner part CAV (5 pcs)	3.0 mm	2493881
Sleeve EAV (x 20)		2284349

Highspeed, reflection-free (Pack of 5)		
Name	Ø	Order no.
Nozzle CAU	10.0 mm	2491660

Nozzle holder



- Advantages of the Genuine Nozzle Holder**
- High-grade raw materials for correct distance regulation and constant focus positioning
 - Full utilization of nozzle changer functionality with the Original

Standard / BrightLine		
Name	Ø thread	Order no.
Nozzle holder	M12	1755673

Standard / BrightLine / CoolLine		
Name	Ø thread	Order no.
Nozzle holder	M12	1906032

Other items relating to the nozzle holder

Union nut		
Name	Ø thread	Order no.
Union nut	M48	1339994

Crossjet nozzle (packaging unit x 5)		
Name	Ø	Order no.
Crossjet nozzle	2.0 mm	1384753

Genuine Parts across series

Additional Genuine Parts that are important for your machine's productivity can be found in the chapter "Multi-series Genuine Parts".

Filter element



Easy Kit



Filter cartridge



Easy Filter



TruLaser Series 7000, 8000



Machine type

TruLaser	7025, 7040, 8000
TC HSL	2502, 4002

Cutting optics type

Cutting head with inch focal length and nozzle with M8 connection thread

Application tips

p. 104

Lens



Advantages of the Genuine Lens

- Optimal process reliability with the lens failure sensor system
- Plug & play based on perfectly combined cutting parameters
- Optimum cutting result based on tried and proven TRUMPF quality

High-pressure lens

Name	Focal length	Order no.
	3.75 "	0346104
ZnSe high-pressure lens	5 "	0088114
	7.5 "	0097517

Nozzle



Advantages of the Genuine Nozzle

- Outstanding parts quality: made in Germany
- Excellent cut quality in every processing direction thanks to direction-independent gas flow
- Cutting gas consumption minimized due to precise geometries and strict production tolerances

Not chrome-plated (Pack of 5)

Name	Ø	Order no.
	0.8 mm	0124561
	1.0 mm	0124562
	1.2 mm	0966809
Nozzle ECE, not chrome-plated	1.4 mm	0237497
	1.7 mm	0237501
	2.0 mm	1253211
	2.3 mm	0126933
	2.7 mm	0942742

Chrome-plated (Pack of 5)

Name	Ø	Order no.
	0.8 mm	0352280
	1.0 mm	0352281
	1.2 mm	0352282
Nozzle ECE, chrome-plated	1.4 mm	0352283
	1.7 mm	0352284
	2.0 mm	1253212
	2.3 mm	0352285
	2.7 mm	0352286

Nozzle holder



Advantages of the Genuine Nozzle Holder

- High-grade raw materials for correct distance regulation and constant focus positioning
- Ideal beam properties at the workpiece thanks to the use of Genuine Nozzle Holders and Nozzles

Standard		
Name	Ø thread	Order no.
Nozzle holder	M8	0260432

Additional items related to the nozzle holder

Union nut		
Name	Ø thread	Order no.
Union nut	M50	0256152

Cover cap	
Name	Order no.
Cover cap	0955826

Multi-series Genuine Parts

Additional Genuine Parts that are important for your machine's productivity can be found in the chapter "Multi-series Genuine Parts".

Power Tube



Filter plate



Easy Kit



Filter cartridge



Easy Filter



TruLaser Series 7000, 8000

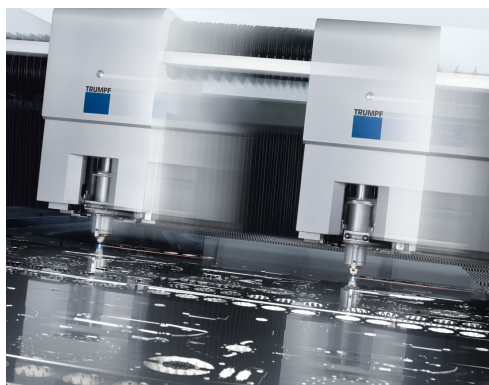

Machine type

TruLaser 7040 (L62), 8000 (L63)

Cutting optics type

Cutting head with mm focal length and nozzle with M12 connection thread

Part-relevant options

BrightLine, CoolLine

Application tips

p. 104

Lens



Advantages of the Genuine Lens

- Over 40 % time saving thanks to needs-based lens cleaning
- Increased process reliability thanks to RFID condition monitoring
- Lower part costs thanks to optimized cleaning cycles

Cut-lens with RFID chip

Name	Focal length	Order no.
ZnSe lens 130 D40	130 mm	1772319
ZnSe lens 250 D40	250 mm	1770805

Nozzle

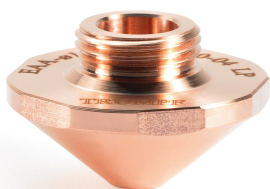

Advantages of the Genuine Nozzle

- Excellent cut quality in every processing direction thanks to direction-independent gas flow
- Cutting gas consumption minimized due to precise geometries and strict production tolerances
- Best cutting result thanks to minimal spatter adhesion on the nozzle surface

Standard (Pack of 5)

Name	Ø	Order no.
Nozzle EAA	0.8 mm	1324858
	1.0 mm	1324860
	1.2 mm	1324861
	1.4 mm	1324863
	1.7 mm	1324864
	2.0 mm	1324865
	2.3 mm	1324866
	2.7 mm	1324867

BrightLine

Name	Ø	Order no.
Nozzle EAC	5.3 mm	1633046
Nozzle EAK	2.5 mm	1579549
	3.0 mm	1579556
	6.0 mm	1809091
Nozzle EAQ	7.5 mm	1809421
	9.5 mm	1886199

Slim (Pack of 5)

Name	Ø	Order no.
Nozzle EAB	0.8 mm	1373324
	1.0 mm	1373325
	1.2 mm	1373326
	1.4 mm	1373327
	1.7 mm	1373328
	2.0 mm	1373329
	2.3 mm	1373330
	2.7 mm	1373331

CoolLine

Name	Ø	Order no.
Nozzle EFL	1.4 mm	1774018
	1.7 mm	1838745
	2.0 mm	1774020
	2.3 mm	1774092

Nozzle holder



Advantages of the Genuine Nozzle Holder

- High-grade raw materials for correct distance regulation and constant focus positioning
- Long service life thanks to the precise joining process of the ceramic and thread insert

Standard / BrightLine

Name	Ø thread	Order no.
Nozzle holder	M12	1755673

CoolLine

Name	Ø thread	Order no.
Nozzle holder	M28	1707005

Additional items related to the nozzle holder

Union nut

Name	Ø thread	Order no.
Union nut	M48	1339994
Union nut, CoolLine	M60	1668992

Multi-series Genuine Parts

Additional Genuine Parts that are important for your machine's productivity can be found in the chapter "Multi-series Genuine Parts".

Power Tube



Filter plate



Easy Kit



Filter cartridge



Easy Filter



TruLaser Series 7000 fiber

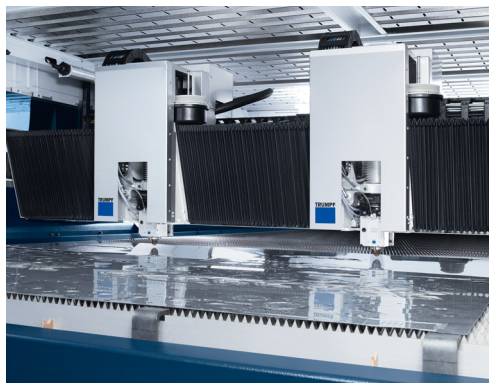

Machine type

TruLaser 7025 fiber (L43), 7040 fiber (L30)

Cutting optics type

Cutting unit

Application tips

p. 104

Lens



Advantages of the Genuine Lens

- Plug & play based on perfectly combined cutting parameters
- Optimum cutting result based on tried and proven TRUMPF quality

Plano-convex lens

Name	Focal length	Order no.
Plano-convex lens F150 D45	150 mm	1641439
Plano-convex lens F200 D45	200 mm	1641473

Nozzle



Advantages of the Genuine Nozzle

- Outstanding parts quality: made in Germany
- Excellent cut quality in every processing direction thanks to direction-independent gas flow
- Cutting gas consumption minimized due to precise geometries and strict production tolerances

Not chrome-plated (Pack of 5)

Name	Ø	Order no.
Nozzle ECE, not chrome-plated	0.8 mm	0124561
	1.0 mm	0124562
	1.2 mm	0966809
	1.4 mm	0237497
	1.7 mm	0237501
	2.0 mm	1253211
	2.3 mm	0126933
	2.7 mm	0942742

Nozzle holder



Advantages of the Genuine Nozzle Holder

- High-grade raw materials for correct distance regulation and constant focus positioning
- Ideal beam properties at the workpiece thanks to the use of Genuine Nozzle Holders and Nozzles

Standard		
Name	Ø thread	Order no.
Nozzle holder	M8	0260432

Additional items related to the nozzle holder

Union nut		
Name	Ø thread	Order no.
Union nut	M50	0256152

Cover cap	
Name	Order no.
Cover cap	0955826

Multi-series Genuine Parts

Additional Genuine Parts that are important for your machine's productivity can be found in the chapter "Multi-series Genuine Parts".

Filter plate



Easy Kit



Filter cartridge



TruLaser Center 7030 fiber

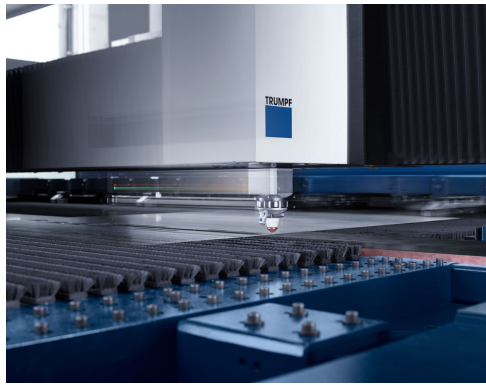

Machine type

TruLaser 7030 fiber (L26)

Cutting optics type

Cutting unit

Application tips

p. 104

Protective glass



Advantages of the Genuine Protective Glass

- Optimal protection of the beam path against disruptive contamination
- Top cutting result thanks to special coating and excellent glass purity

Protective glass

Name	Ø	Order no.
Protective glass D34	34.0 mm	2602937

Nozzle

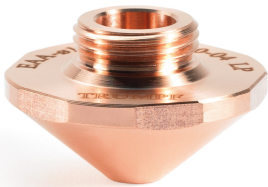

Advantages of the Genuine Nozzle

- Excellent cut quality in every processing direction thanks to direction-independent gas flow
- Cutting gas consumption minimized due to precise geometries and strict production tolerances
- Best cutting result thanks to minimal spatter adhesion on the nozzle surface

Standard (Pack of 5)

Name	Ø	Order no.
Nozzle EAA	0.8 mm	1324858
	1.0 mm	1324860
	1.2 mm	1324861
	1.4 mm	1324863
	1.7 mm	1324864
	2.0 mm	1324865
	2.3 mm	1324866
	2.7 mm	1324867

BrightLine (Pack of 5)

Name	Ø	Order no.
Nozzle EAQ	6.0 mm	1809091
	7.5 mm	1809421
Nozzle EAU	10.0 mm	2253595

Highspeed Eco

Name	Ø	Order no.
Nozzle EAV (x 1)		2228806
Inner part EAV (x 5)	3.0 mm	2228802
Sleeve EAV (x 20)		2284349

Slim (Pack of 5)

Name	Ø	Order no.
Nozzle EAB	0.8 mm	1373324
	1.0 mm	1373325
	1.2 mm	1373326
	1.4 mm	1373327
	1.7 mm	1373328
	2.0 mm	1373329
	2.3 mm	1373330
	2.7 mm	1373331

Performance (Pack of 5)

Name	Ø	Order no.
Nozzle EAU	2.5 mm	2059462
	3.0 mm	2060001
	4.0 mm	2060004
	6.0 mm	2060025

Nozzle holder



Advantages of the Genuine Nozzle Holder

- High-grade raw materials for correct distance regulation and constant focus positioning
- Full utilization of nozzle changer functionality with the Original

Standard

Name	Ø thread	Order no.
Nozzle holder	M12	1755673

Other items relating to the nozzle holder

Union nut

Name	Ø thread	Order no.
Union nut	M48	1339994

Crossjet nozzle (Pack of 5)

Name	Ø	Order no.
Crossjet nozzle	2.0 mm	1384753

Genuine Parts across series

Additional Genuine Parts that are important for your machine's productivity can be found in the chapter "Multi-series Genuine Parts".

Filter element



Easy Kit



Filter cartridge



TruLaser Tube Series 3000 fiber

General Information

Genuine Parts for your machine

Genuine Accessories

Application Tips

Your order



Machine type

TruLaser Tube 3000 (T10)

Cutting optics type

Cutting unit

Application tips

p. 104

Lens



Advantages of the Genuine Lens

- Plug & play based on perfectly combined cutting parameters
- Optimum cutting result based on tried and proven TRUMPF quality

Plano-convex lens

Name	Focal length	Order no.
Plano-convex lens F150 D40	150 mm	1603107

Nozzle



Advantages of the Genuine Nozzle

- Outstanding parts quality: made in Germany
- Excellent cut quality in every processing direction thanks to direction-independent gas flow
- Cutting gas consumption minimized due to precise geometries and strict production tolerances

Standard (Pack of 5)

Name	Ø	Order no.
Nozzle EBD	0.8 mm	1354230
	1.0 mm	0212334
	1.2 mm	1479581
	1.4 mm	0216199
	1.7 mm	0225213
	2.0 mm	1487009
	2.3 mm	0126156

Slim (Pack of 5)

Name	Ø	Order no.
Nozzle EBG	0.8 mm	0913799
	1.0 mm	0913800
	1.2 mm	1487034
	1.4 mm	0913801
	1.7 mm	0937988
Nozzle EBF	2.0 mm	1487036
	2.3 mm	0937989

Nozzle holder



Advantages of the Genuine Nozzle Holder

- High-grade raw materials for correct distance regulation and consistent focus positioning
- Ideal beam properties at the workpiece thanks to the use of Genuine Nozzle Holders and Nozzles

Standard		
Name	Ø thread	Order no.
Nozzle holder	M6	2509767

Additional items related to the nozzle holder

Union nut		
Name	Ø thread	Order no.
Union nut	M19	0913965

Multi-series Genuine Parts

Additional Genuine Parts that are important for your machine's productivity can be found in the chapter "Multi-series Genuine Parts".

Filter plate



Easy Kit



Filter cartridge



Easy Filter



TruLaser Tube Series 3000, 5000

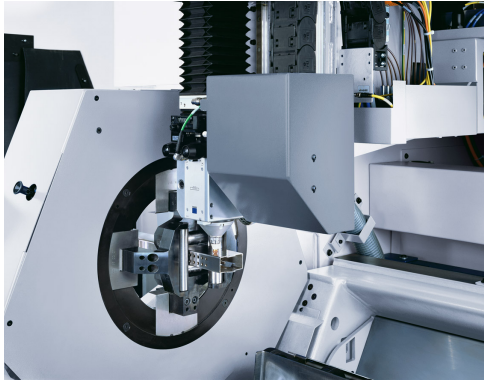

Machine type

TruLaser Tube 3000, 5000 (T01)

Tubematic Tubematic, Tubematic RC

Cutting optics type

Cutting head with inch focal length and nozzle with M6 connection thread

Application tips

p. 104

Lens



Advantages of the Genuine Lens

- Optimal process reliability with the lens failure sensor system
- Plug & play based on perfectly combined cutting parameters
- Optimum cutting result based on tried and proven TRUMPF quality

High-pressure lens

Name	Focal length	Order no.
ZnSe high-pressure lens	5 "	0088114

Nozzle



Advantages of the Genuine Nozzle

- Outstanding parts quality: made in Germany
- Excellent cut quality in every processing direction thanks to direction-independent gas flow
- Cutting gas consumption minimized due to precise geometries and strict production tolerances

Standard (Pack of 5)

Name	Ø	Order no.
Nozzle EBD	0.8 mm	1354230
	1.0 mm	0212334
	1.2 mm	1479581
	1.4 mm	0216199
	1.7 mm	0225213
	2.0 mm	1487009
	2.3 mm	0126156

Slim (Pack of 5)

Name	Ø	Order no.
Nozzle EBG	0.8 mm	0913799
	1.0 mm	0913800
	1.2 mm	1487034
	1.4 mm	0913801
	1.7 mm	0937988
Nozzle EBF	2.0 mm	1487036
	2.3 mm	0937989

Nozzle holder



Advantages of the Genuine Nozzle Holder

- High-grade raw materials for correct distance regulation and consistent focus positioning
- Ideal beam properties at the workpiece thanks to the use of Genuine Nozzle Holders and Nozzles

Standard		
Name	Ø thread	Order no.
Nozzle holder	M6	2509767

Additional items related to the nozzle holder

Union nut		
Name	Ø thread	Order no.
Union nut	M19	0960350

Cover cap	
Name	Order no.
Cover cap	0960354

Multi-series Genuine Parts

Additional Genuine Parts that are important for your machine's productivity can be found in the chapter "Multi-series Genuine Parts".

Power Tube



Filter plate



Easy Kit



Filter cartridge



Easy Filter



TruLaser Tube Series 5000, 7000

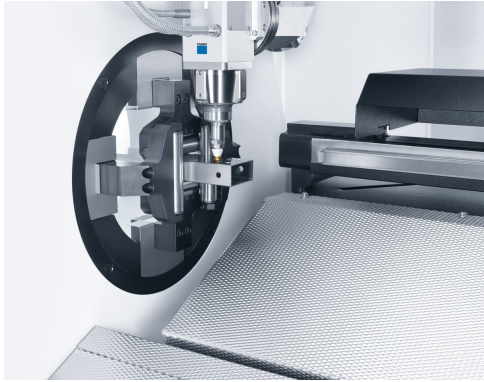

Machine type

TruLaser Tube 5000 (T05), 7000

Cutting optics type

Cutting head with mm focal length and nozzle with M6 connection thread

Application tips

p. 104



Lens

Advantages of the Genuine Lens

- Up to 40 % time saving thanks to needs-based lens cleaning
- Optimal process reliability with the lens failure sensor system
- Lower part costs thanks to optimized cleaning cycles

Cut-lens

Name	Focal length	Order no.
ZnSe lens 155 D40	155 mm	1383925



Nozzle

Advantages of the Genuine Nozzle

- Outstanding parts quality: made in Germany
- Excellent cut quality in every processing direction thanks to direction-independent gas flow
- Cutting gas consumption minimized due to precise geometries and strict production tolerances

Standard (Pack of 5)

Name	Ø	Order no.
Nozzle EBD	0.8 mm	1354230
	1.0 mm	0212334
	1.2 mm	1479581
	1.4 mm	0216199
	1.7 mm	0225213
	2.0 mm	1487009
	2.3 mm	0126156

Slim (Pack of 5)

Name	Ø	Order no.
Nozzle EBG	0.8 mm	0913799
	1.0 mm	0913800
	1.2 mm	1487034
	1.4 mm	0913801
Nozzle EBF	1.7 mm	0937988
	2.0 mm	1487036
	2.3 mm	0937989

Nozzle holder



Advantages of the Genuine Nozzle Holder

- High-grade raw materials for correct distance regulation and constant focus positioning
- Ideal beam properties at the workpiece thanks to the use of Genuine Nozzle Holders and Nozzles

Standard		
Name	Ø thread	Order no.
Nozzle holder	M6	2509767

Additional items related to the nozzle holder

Union nut		
Name	Ø thread	Order no.
Union nut	M19	0960350

Multi-series Genuine Parts

Additional Genuine Parts that are important for your machine's productivity can be found in the chapter "Multi-series Genuine Parts".

Power Tube



Filter plate



Easy Kit



Filter cartridge



Easy Filter



TruLaser Tube Series 5000 fiber



Machine type

TruLaser Tube 5000 fiber (T06)

Cutting optics type

Cutting unit

Application tips

p. 104

Lens



Advantages of the Genuine Lens

- Plug & play based on perfectly combined cutting parameters
- Optimum cutting result based on tried and proven TRUMPF quality

Plano-convex lens

Name	Focal length	Order no.
Plano-convex lens F150 D40	150 mm	1603107

Nozzle



Advantages of the Genuine Nozzle

- Outstanding parts quality: made in Germany
- Excellent cut quality in every processing direction thanks to direction-independent gas flow
- Cutting gas consumption minimized due to precise geometries and strict production tolerances

Standard (Pack of 5)

Name	Ø	Order no.
Nozzle EBD	0.8 mm	1354230
	1.0 mm	0212334
	1.2 mm	1479581
	1.4 mm	0216199
	1.7 mm	0225213
	2.0 mm	1487009
	2.3 mm	0126156

Slim (Pack of 5)

Name	Ø	Order no.
Nozzle EBG	0.8 mm	0913799
	1.0 mm	0913800
	1.2 mm	1487034
	1.4 mm	0913801
	1.7 mm	0937988
Nozzle EBF	2.0 mm	1487036
	2.3 mm	0937989

Nozzle holder



Advantages of the Genuine Nozzle Holder

- High-grade raw materials for correct distance regulation and consistent focus positioning
- Ideal beam properties at the workpiece thanks to the use of Genuine Nozzle Holders and Nozzles

Standard		
Name	Ø thread	Order no.
Nozzle holder	M6	2509767

Additional items related to the nozzle holder

Union nut		
Name	Ø thread	Order no.
Union nut	M19	0960350

Multi-series Genuine Parts

Additional Genuine Parts that are important for your machine's productivity can be found in the chapter "Multi-series Genuine Parts".

Filter plate



Easy Kit



Filter cartridge



Easy Filter



TruLaser Tube Series 5000



Machine type

TruLaser Tube 5000 (T08)

Cutting optics type

Cutting head with inch focal length and nozzle with M6 connection thread

Application tips

p. 104

Lens



Advantages of the Genuine Lens

- Up to 40 % time saving thanks to needs-based lens cleaning
- Optimal process reliability with the lens failure sensor system
- Lower part costs thanks to optimized cleaning cycles

Plano-convex Lens

Name	Focal length	Order no.
ZnSe lens 155 D40	155 mm	1383925

Nozzle



Advantages of the Genuine Nozzle

- Outstanding parts quality: made in Germany
- Excellent cut quality in every processing direction thanks to direction-independent gas flow
- Cutting gas consumption minimized due to precise geometries and strict production tolerances

Standard (packaging unit x 5)

Name	Ø	Order no.
Nozzle EBD	0.8 mm	1354230
	1.0 mm	0212334
	1.2 mm	1479581
	1.4 mm	0216199
	1.7 mm	0225213
	2.0 mm	1487009
	2.3 mm	0126156

Slim (packaging unit x 5)

Name	Ø	Order no.
Nozzle EBG	0.8 mm	0913799
	1.0 mm	0913800
	1.2 mm	1487034
	1.4 mm	0913801
Nozzle EBF	1.7 mm	0937988
	2.0 mm	1487036
	2.3 mm	0937989

Nozzle holder



Advantages of the Genuine Nozzle Holder

- High-grade raw materials for correct distance regulation and constant focus positioning
- Ideal beam properties at the workpiece thanks to the use of Genuine Nozzle Holders and Nozzles

Standard

Name	Ø thread	Order no.
Nozzle holder	M6	2509767

Other items relating to the nozzle holder

Union nut

Name	Ø thread	Order no.
Union nut	M19	0913965

Genuine Parts across series

Additional Genuine Parts that are important for your machine's productivity can be found in the chapter "Multi-series Genuine Parts".

Filter element



Easy Kit



Filter cartridge



Easy Filter



TruLaser Tube Series 7000 fiber



Machine type

TruLaser Tube 7000 fiber (T07)

Cutting optics type

Cutting unit

Application tips

p. 104

Lens



Advantages of the Genuine Lens

- Plug & play based on perfectly combined cutting parameters
- Optimum cutting result based on tried and proven TRUMPF quality

Plano-convex Lens

Name	Focal length	Order no.
Plano-convex lens F150 D40	150 mm	1603107

Nozzle



Advantages of the Genuine Nozzle

- Outstanding parts quality: made in Germany
- Excellent cut quality in every processing direction thanks to direction-independent gas flow
- Cutting gas consumption minimized due to precise geometries and strict production tolerances

Standard (packaging unit x 5)

Name	Ø	Order no.
Nozzle EBD	0.8 mm	1354230
	1.0 mm	0212334
	1.2 mm	1479581
	1.4 mm	0216199
	1.7 mm	0225213
	2.0 mm	1487009
	2.3 mm	0126156

Slim (packaging unit x 5)

Name	Ø	Order no.
Nozzle EBG	0.8 mm	0913799
	1.0 mm	0913800
	1.2 mm	1487034
	1.4 mm	0913801
	1.7 mm	0937988
Nozzle EBF	2.0 mm	1487036
	2.3 mm	0937989

Nozzle holder



Advantages of the Genuine Nozzle Holder

- High-grade raw materials for correct distance regulation and constant focus positioning
- Ideal beam properties at the workpiece thanks to the use of Genuine Nozzle Holders and Nozzles

Standard		
Name	Ø thread	Order no.
Nozzle holder	M6	2509767

Other items relating to the nozzle holder

Union nut		
Name	Ø thread	Order no.
Union nut	M19	0913965

Genuine Parts across series

Additional Genuine Parts that are important for your machine's productivity can be found in the chapter "Multi-series Genuine Parts".

Filter element



Easy Kit



Filter cartridge



Easy Filter



TruMatic Series 1000 fiber

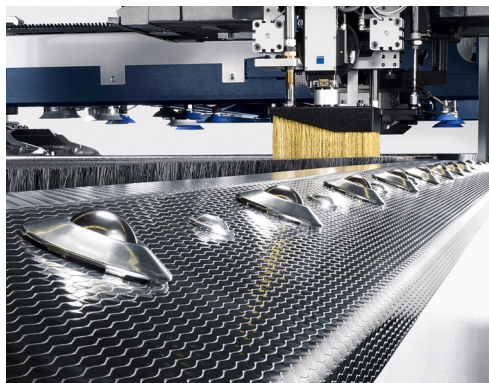

Machine type

TruMatic 1000 fiber (K07)

Cutting optics type

Cutting unit

Application tips

p. 104

Protective glass



Advantages of the Genuine Protective Glass

- Optimal protection of the beam path against disruptive contamination
- Top cutting result thanks to special coating and excellent glass purity

Protective glass

Name	Ø	Order no.
Protective glass D24	24.0 mm	1792250

Nozzle



Advantages of the Genuine Nozzle

- Excellent cut quality in every processing direction thanks to direction-independent gas flow
- Cutting gas consumption minimized due to precise geometries and strict production tolerances
- Best cutting result thanks to minimal spatter adhesion on the nozzle surface

Standard (Pack of 5)

Name	Ø	Order no.
Nozzle ECP	0.8 mm	1851641
	1.0 mm	1851587
	1.2 mm	1851588
	1.4 mm	1851618
	1.7 mm	1851619
	2.0 mm	1851620
	2.3 mm	1851651
	2.7 mm	1851652

Nozzle holder



Advantages of the Genuine Nozzle Holder

- High-grade raw materials for correct distance regulation and constant focus positioning
- Ideal beam properties at the workpiece thanks to the use of Genuine Nozzle Holders and Nozzles

Standard		
Name	Ø thread	Order no.
Nozzle holder	M8	0260432

Additional items related to the nozzle holder

Union nut		
Name	Ø thread	Order no.
Union nut	M50	0256152

Mounting ring



Advantages of the Genuine Mounting Ring

- Ensures excellent protection against collisions, and therefore prevents expensive machine damage
- Plug & play thanks to extremely close manufacturing tolerances and precise positioning tolerances

Mounting ring	
Name	Order no.
Mounting ring incl. screws	1865648

Multi-series Genuine Parts

Additional Genuine Parts that are important for your machine's productivity can be found in the chapter "Multi-series Genuine Parts".

Filter plate



Easy Kit



Filter cartridge



Easy Filter



TruMatic Series 3000

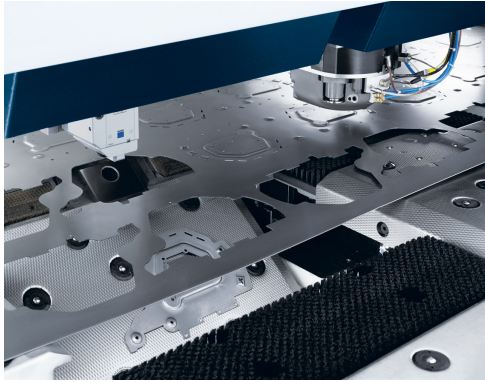

Machine type

TruMatic	3000 (K03)
TC	3000 L

Cutting optics type

Cutting head with inch focal length and nozzle with M8 connection thread

Application tips

p. 104

Lens



Advantages of the Genuine Lens

- Optimal process reliability with the lens failure sensor system
- Plug & play based on perfectly combined cutting parameters
- Optimum cutting result based on tried and proven TRUMPF quality

High-pressure lens

Name	Focal length	Order no.
ZnSe high-pressure lens	5 "	0088114
	7,5 "	0097517

Nozzle



Advantages of the Genuine Nozzle

- Outstanding parts quality: made in Germany
- Excellent cut quality in every processing direction thanks to direction-independent gas flow
- Cutting gas consumption minimized due to precise geometries and strict production tolerances

Not chrome-plated (Pack of 5)

Name	Ø	Order no.
Nozzle ECE, not chrome-plated	0.8 mm	0124561
	1.0 mm	0124562
	1.2 mm	0966809
	1.4 mm	0237497
	1.7 mm	0237501
	2.0 mm	1253211
	2.3 mm	0126933
	2.7 mm	0942742

Chrome-plated (Pack of 5)

Name	Ø	Order no.
Nozzle ECE, chrome-plated	0.8 mm	0352280
	1.0 mm	0352281
	1.2 mm	0352282
	1.4 mm	0352283
	1.7 mm	0352284
	2.0 mm	1253212
	2.3 mm	0352285
	2.7 mm	0352286

Nozzle holder



Advantages of the Genuine Nozzle Holder

- High-grade raw materials for correct distance regulation and constant focus positioning
- Ideal beam properties at the workpiece thanks to the use of Genuine Nozzle Holders and Nozzles

Standard		
Name	Ø thread	Order no.
Nozzle holder	M8	0260432

Additional items related to the nozzle holder

Union nut		
Name	Ø thread	Order no.
Union nut	M42	1290856

Cover cap	
Name	Order no.
Cover cap	0955826

Mounting ring



Advantages of the Genuine Mounting Ring

- Ensures excellent protection against collisions, and therefore prevents expensive machine damage
- Plug & play thanks to extremely close manufacturing tolerances and precise positioning tolerances

Mounting ring	
Name	Order no.
Mounting ring incl. screws	1865648

Multi-series Genuine Parts

Additional Genuine Parts that are important for your machine's productivity can be found in the chapter "Multi-series Genuine Parts".

Power Tube



Filter plate



Easy Kit



Filter cartridge



Easy Filter



TruMatic Series 3000 fiber



Machine type

TruMatic 3000 fiber (K04)

Cutting optics type

Cutting unit

Application tips

p. 104

Lens



Advantages of the Genuine Lens

- Plug & play based on perfectly combined cutting parameters
- Optimum cutting result based on tried and proven TRUMPF quality

Bi-convex lens

Name	Focal length	Order no.
Bikonvex lens 200 D52	200 mm	1572063

Nozzle



Advantages of the Genuine Nozzle

- Outstanding parts quality: made in Germany
- Excellent cut quality in every processing direction thanks to direction-independent gas flow
- Cutting gas consumption minimized due to precise geometries and strict production tolerances

Not chrome-plated (Pack of 5)

Name	Ø	Order no.
Nozzle ECE, not chrome-plated	0.8 mm	0124561
	1.0 mm	0124562
	1.2 mm	0966809
	1.4 mm	0237497
	1.7 mm	0237501
	2.0 mm	1253211
	2.3 mm	0126933
	2.7 mm	0942742

Nozzle holder



Advantages of the Genuine Nozzle Holder

- High-grade raw materials for correct distance regulation and constant focus positioning
- Ideal beam properties at the workpiece thanks to the use of Genuine Nozzle Holders and Nozzles

Standard		
Name	Ø thread	Order no.
Nozzle holder	M8	0260432

Additional items related to the nozzle holder

Union nut		
Name	Ø thread	Order no.
Union nut	M42	1290856

Cover cap	
Name	Order no.
Cover cap	0955826

Mounting ring



Advantages of the Genuine Mounting Ring

- Ensures excellent protection against collisions, and therefore prevents expensive machine damage
- Plug & play thanks to extremely close manufacturing tolerances and precise positioning tolerances

Mounting ring	
Name	Order no.
Mounting ring incl. screws	1865648

Multi-series Genuine Parts

Additional Genuine Parts that are important for your machine's productivity can be found in the chapter "Multi-series Genuine Parts".

Filter plate



Easy Kit



Filter cartridge



TruMatic Serie 3000 fiber

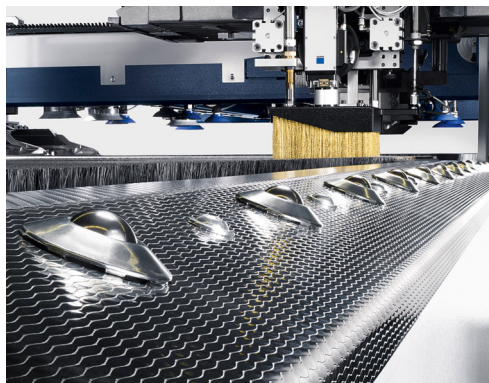

Machine type

TruMatic 3000 fiber (K09)

Cutting optics type

Cutting unit

Application tips

p. 104

Protective glass



Advantages of the Genuine Protective Glass

- Optimal protection of the beam path against disruptive contamination
- Top cutting result thanks to special coating and excellent glass purity

Protective glass

Name	Ø	Order no.
Protective glass D24	24.0 mm	1792250

Nozzle



Advantages of the Genuine Nozzle

- Excellent cut quality in every processing direction thanks to direction-independent gas flow
- Cutting gas consumption minimized due to precise geometries and strict production tolerances
- Best cutting result thanks to minimal spatter adhesion on the nozzle surface

Standard (Pack of 5)

Name	Ø	Order no.
Nozzle ECP	0.8 mm	1851641
	1.0 mm	1851587
	1.2 mm	1851588
	1.4 mm	1851618
	1.7 mm	1851619
	2.0 mm	1851620
	2.3 mm	1851651
	2.7 mm	1851652

Nozzle holder



Advantages of the Genuine Nozzle Holder

- High-grade raw materials for correct distance regulation and constant focus positioning
- Ideal beam properties at the workpiece thanks to the use of Genuine Nozzle Holders and Nozzles

Standard		
Name	Ø thread	Order no.
Nozzle holder	M8	0260432

Other items relating to the nozzle holder

Union nut		
Name	Ø thread	Order no.
Union nut	M50	0256152

Mounting ring



Advantages of the Genuine Mounting Ring

- Ensures excellent protection against collisions, and therefore prevents expensive machine damage
- Plug & play thanks to extremely close manufacturing tolerances and precise positioning tolerances

Mounting ring	
Name	Order no.
Mounting ring incl. screws	1865648

Multi-series Genuine Parts

Additional Genuine Parts that are important for your machine's productivity can be found in the chapter "Multi-series Genuine Parts".

Filter element

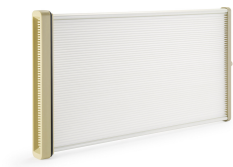

Easy Kit



Filter cartridge



Easy Filter



TruMatic Series 6000

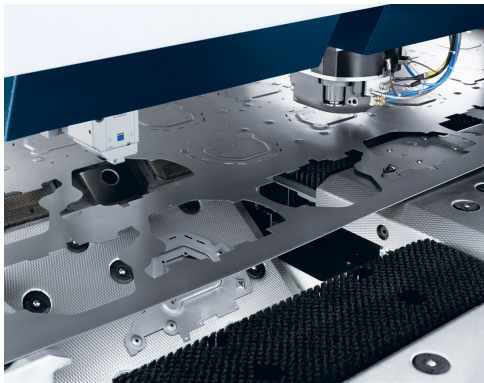

Machine type

TruMatic	6000 (K01)
TC	6000 L

Cutting optics type

Cutting head with inch focal length and nozzle with M8 connection thread

Application tips

p. 104

Lens



Advantages of the Genuine Lens

- Optimal process reliability with the lens failure sensor system
- Plug & play based on perfectly combined cutting parameters
- Optimum cutting result based on tried and proven TRUMPF quality

High-pressure lens

Name	Focal length	Order no.
ZnSe high-pressure lens	5 "	0088114
	7,5 "	0097517

Nozzle



Advantages of the Genuine Nozzle

- Outstanding parts quality: made in Germany
- Excellent cut quality in every processing direction thanks to direction-independent gas flow
- Cutting gas consumption minimized due to precise geometries and strict production tolerances

Not chrome-plated (packaging unit x 5)

Name	Ø	Order no.
	0.8 mm	0124561
	1.0 mm	0124562
	1.2 mm	0966809
Nozzle ECE, not chrome-plated	1.4 mm	0237497
	1.7 mm	0237501
	2.0 mm	1253211
	2.3 mm	0126933
	2.7 mm	0942742

Chrome-plated (packaging unit x 5)

Name	Ø	Order no.
	0.8 mm	0352280
	1.0 mm	0352281
	1.2 mm	0352282
Nozzle ECE, chrome-plated	1.4 mm	0352283
	1.7 mm	0352284
	2.0 mm	1253212
	2.3 mm	0352285
	2.7 mm	0352286

Nozzle holder



Advantages of the Genuine Nozzle Holder

- High-grade raw materials for correct distance regulation and constant focus positioning
- Ideal beam properties at the workpiece thanks to the use of Genuine Nozzle Holders and Nozzles

Standard		
Name	Ø thread	Order no.
Nozzle holder	M8	0260432

Other items relating to the nozzle holder

Union nut		
Name	Ø thread	Order no.
Union nut	M50	0256152

Cover cap	
Name	Order no.
Cover cap	0955826

Mounting ring



Advantages of the Genuine Mounting Ring

- Ensures excellent protection against collisions, and therefore prevents expensive machine damage
- Plug & play thanks to extremely close manufacturing tolerances and precise positioning tolerances

Mounting ring	
Name	Order no.
Mounting ring incl. Screws	1865649

Genuine Parts across series

Additional Genuine Parts that are important for your machine's productivity can be found in the chapter "Multi-series Genuine Parts".

Power Tube



Filter element



Easy Kit



Filter cartridge



Easy Filter



TruMatic Series 6000, 7000

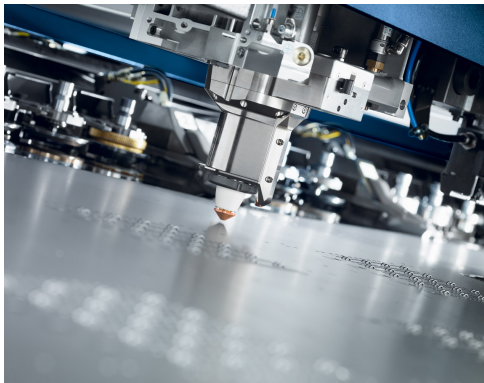

Machine type

TruMatic TruMatic 6000 (K05), 7000 (K02), 7000 (K08)

Cutting optics type

Cutting head with mm focal length and nozzle with M12 connection thread

Application tips

p. 104

Lens



Advantages of the Genuine Lens

- Over 40 % time saving thanks to needs-based lens cleaning
- Increased process reliability thanks to RFID condition monitoring
- Lower part costs thanks to optimized cleaning cycles

Cut-lens with RFID chip

Name	Focal length	Order no.
ZnSe lens 170 D50	170 mm	1830767

Nozzle

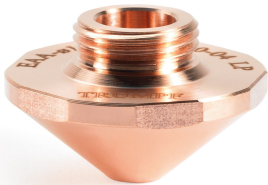

Advantages of the Genuine Nozzle

- Excellent cut quality in every processing direction thanks to direction-independent gas flow
- Cutting gas consumption minimized due to precise geometries and strict production tolerances
- Best cutting result thanks to minimal spatter adhesion on the nozzle surface

Standard (Pack of 5)

Name	Ø	Order no.
Nozzle EAA	0.8 mm	1324858
	1.0 mm	1324860
	1.2 mm	1324861
	1.4 mm	1324863
	1.7 mm	1324864
	2.0 mm	1324865
	2.3 mm	1324866
	2.7 mm	1324867

Slim (Pack of 5)

Name	Ø	Order no.
Nozzle EAB	0.8 mm	1373324
	1.0 mm	1373325
	1.2 mm	1373326
	1.4 mm	1373327
	1.7 mm	1373328
	2.0 mm	1373329
	2.3 mm	1373330
	2.7 mm	1373331

Nozzle holder



Advantages of the Genuine Nozzle Holder

- High-grade raw materials for correct distance regulation and constant focus positioning
- Long service life thanks to the precise joining process of the ceramic and thread insert

Standard

Name	Ø thread	Order no.
Nozzle holder	M12	1755673

Additional items related to the nozzle holder

Union nut

Name	Ø thread	Order no.
Union nut	M48	1339994

Mounting ring



Advantages of the Genuine Mounting Ring

- Ensures excellent protection against collisions, and therefore prevents expensive machine damage
- Plug & play thanks to extremely close manufacturing tolerances and precise positioning tolerances

Mounting ring

Name	Order no.
Mounting ring incl. Screws	1865649

Multi-series Genuine Parts

Additional Genuine Parts that are important for your machine's productivity can be found in the chapter "Multi-series Genuine Parts".

Power Tube



Filter plate



Easy Kit



Filter cartridge



Easy Filter



TruMatic Series 6000 fiber

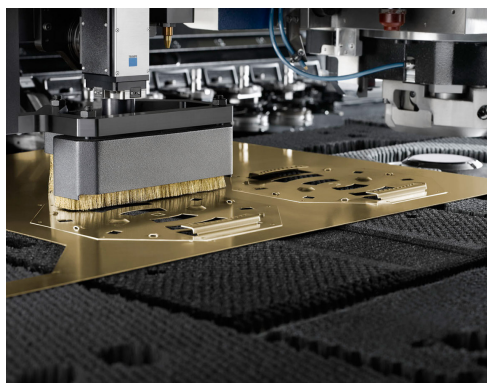

Machine type

TruMatic 6000 fiber (K06)

Cutting optics type

Cutting unit

Application tips

p. 104

Protective glass



Advantages of the Genuine Protective Glass

- Optimal protection of the beam path against disruptive contamination
- Top cutting result thanks to special coating and excellent glass purity

Protective glass

Name	Ø	Order no.
Protective glass D24	24.0 mm	1792250

Nozzle



Advantages of the Genuine Nozzle

- Excellent cut quality in every processing direction thanks to direction-independent gas flow
- Cutting gas consumption minimized due to precise geometries and strict production tolerances
- Best cutting result thanks to minimal spatter adhesion on the nozzle surface

Standard (Pack of 5)

Name	Ø	Order no.
Nozzle ECP	0.8 mm	1851641
	1.0 mm	1851587
	1.2 mm	1851588
	1.4 mm	1851618
	1.7 mm	1851619
	2.0 mm	1851620
	2.3 mm	1851651
	2.7 mm	1851652

Nozzle holder



Advantages of the Genuine Nozzle Holder

- Perfect focus position - High-grade ceramic ensures correct distance control
- Nozzle changer – Only fully usable with Genuine Nozzle Holder

Standard		
Name	Ø thread	Order no.
Nozzle holder	M8	0260432

Additional items related to the nozzle holder

Union nut		
Name	Ø thread	Order no.
Union nut	M50	0256152

Cover cap	
Name	Order no.
Cover cap	0955826

Mounting ring



Advantages of the Genuine Mounting Ring

- Ensures excellent protection against collisions, and therefore prevents expensive machine damage
- Plug & play thanks to extremely close manufacturing tolerances and precise positioning tolerances

Mounting ring	
Name	Order no.
Mounting ring incl. Screws	1865649

Multi-series Genuine Parts

Additional Genuine Parts that are important for your machine's productivity can be found in the chapter "Multi-series Genuine Parts".

Filter plate



Easy Kit



Filter cartridge



Easy Filter



Genuine Parts for your machine

TruPunch Series 1000, 2000, 3000, 5000



Machine type

TruPunch 1000 (S05), 1000 (S19), 2000 (S18), 2020 (S02), 3000 (S06), 3000 (S11), 3000 (S20), 5000 (S01), 5000 (S07), 5000 (S10), 5000 (S12)

TC

1000 R, 2000 R, 2010 R, 2020 R, 3000 R, 5000 R

Punching head type

Standard

Application tips

p. 104

Mounting ring



Advantages of the Genuine Mounting Ring

- Ensures excellent protection against collisions, and therefore prevents expensive machine damage
- Plug & play thanks to extremely close manufacturing tolerances and precise positioning tolerances

Mounting ring

Name	Machine type	Order no.
Mounting ring incl. screws	TruPunch 1000 (S05), TruPunch 1000 (S19), TruPunch 2000 (S18), TC 1000 R	1865648
	TruPunch 2020, TruPunch 3000 (S06), TruPunch 3000 (S20), TruPunch 5000 (S01), TruPunch 5000 (S10), TruPunch 5000 (S12), TC 2000 R, TC 2010 R, TC 2020 R, TC 3000 R, TC 5000 R	1865649
	TruPunch 3000 (S11)	1865650

Multi-series Genuine Parts

Additional Genuine Parts that are important for your machine's productivity can be found in the chapter "Multi-series Genuine Parts".

Easy Kit



Filter cartridge



Easy Filter



Power Tube



Advantages of the Genuine Power Tube

- Full laser power thanks to parameters specially adjusted to the TRUMPF generator
- Power Tube Plus: 24 months warranty / 5000 hours
- Power Tube Basic: 12 months warranty / 3000 hours
- Uncompromising safety based on tried and proven TRUMPF quality

Power Tube			Plus	Basic
Name	HF power	Laser power	Order no.	Order no.
Power Tube RT 3021	11 - 22 kW	< 4 kW	1800928	1801047
Power Tube RT 2048	30 - 44 kW	> 4 kW	1811787	1812660

Filter plate



Advantages of the Genuine Filter Plate

- Special coating ensures consistently high exhaust and filter performance
- Compliance with strict legal requirements for the protection of people and the environment

Filter plate			
Name	Dimensions	Dust extractor	Order no.
	556 x 74 x 1050 mm	MF 25/5/1, MF 30/6/1, MF 40/8/1, MF 50/10/1	0345064
Filter plate	500 x 52 x 600 mm	MF 17/8/1	0139809
	685 x 100 x 1043 mm	MF 2000, MF 2500, MF 3000, MF 2000-L41	0380757

Easy Kit



Advantages of the Genuine Easy Kit

- Extended service life of the resonator and optics thanks to specially adapted composition
- Simple and quick cooling water replacement thanks to product group specific Easy Kits

Easy Kit		Standard	USA	Canada	Belgium	Netherlands	Thailand
Name	Water in the cooling circuit	Order no.	Order no.	Order no.	Order no.	Order no.	Order no.
Easy Kit Cu-1	5 - 14 l	1652981	1652991	1652992	1652993	1652994	-
Easy Kit Cu-2	15 - 49 l	1652995	1653088	1653089	1653090	1653111	2503640
Easy Kit Cu-3	50 - 119 l	1653112	1653113	1653114	1653119	1653120	2503595
Easy Kit Cu-3 KK4*	50 - 119 l	1861047	1861047	1861047	1861047	1861047	-
Easy Kit Cu-4	120 - 359 l	1653107	1653108	1653109	1653130	1653131	2503624
Easy Kit Cu-5	360 - 999 l	1653132	1653124	1653125	1653126	1653127	-
Easy Kit Al-1	30 - 79 l	1652091	1652623	1652606	1652625	1652624	2519471
Easy Kit Al-2	80 - 199 l	1652630	1652631	1652607	1652604	1652632	2519468
Easy Kit Al-3	200 - 599 l	1652605	1652608	1652609	1652640	1652943	2519410
Easy Kit Al-4	600 - 1199 l	1652964	1652965	1652968	1652969	1653122	-

* For the energy-efficient laser of the TruLaser series 5000 (L52, L53, L54).

Filter cartridge



Advantages of the Genuine Filter Cartridge

- Longer service life of resonator and optics when using the high-quality Genuine Parts

Filter	
Name	Order no.
Filter cartridge	0146152

Multi-series Genuine Parts

Easy Filter



Advantages of the Genuine Easy Filter

- Reconditioning of the used cooling water replaces the time-consuming water change
- Significant simplification of time and effort during maintenance

Easy Filter starter sets (for two cooling circuits)

Name	Contents	Order no.
Easy Filter starter set (2 x M)	1 x Assembly kit (order no. 1725484) 2 x Easy Filter - filter valve (order no. 2290174) 2 x Easy Filter - size M (order no. 2290172)	2298440
Easy Filter starter set (1 x M, 1 x XXL)	1 x Assembly kit (order no. 1725484) 2 x Easy Filter - filter valve (order no. 2290174) 1 x Easy Filter - size M (order no. 2290172) 1 x Easy Filter - size XXL (order no. 2290173)	2298445
Easy Filter starter set (2 x XXL)	1 x Assembly kit (order no. 1725484) 2 x Easy Filter - filter valve (order no. 2290174) 2 x Easy Filter - size XXL (order no. 2290173)	2298446

Easy Filter starter sets (for three cooling circuits)

Name	Contents	Order no.
Easy Filter starter set (2 x M, 1 x XXL)	1 x Assembly kit (order no. 1725484) 1 x Assembly kit (order no. 2306604) 3 x Easy Filter - filter valve (order no. 2290174) 2 x Easy Filter - size M (order no. 2290172) 1 x Easy Filter - size XXL (Best.-Nr. 2290173)	2375795
Easy Filter starter set (1 x M, 2 x XXL)	1 x Assembly kit (order no. 1725484) 1 x Assembly kit (order no. 2306604) 3 x Easy Filter - filter valve (order no. 2290174) 1 x Easy Filter - size M (order no. 2290172) 2 x Easy Filter - size XXL (order no. 2290173)	2375796

For the cooling unit of an external optic

Name	Contents	Order no.
Easy Filter starter set (1 x M)	1 x Assembly kit (order no. 2512213) 1 x Easy Filter - filter valve (order no. 2290174) 1 x Easy Filter - size M (order no. 2290172)	2512211

For the internal cooling unit of a laser (SSL)

Name	Contents	Order no.
Easy Filter starter set (1 x M)	1 x Assembly kit (order no. 2512214) 1 x Easy Filter - filter valve (order no. 2290174) 1 x Easy Filter - size M (order no. 2290172)	2512212

When using the Easy Filter for the first time, in addition to the corresponding Easy Filters, you will also need a permanent filter valve for each Easy Filter and an assembly kit for connection to the cooling circuit.

Easy Filter replacement sets (for two cooling circuits)

Name	Contents	Order no.
Easy Filter set (2 x M)	2 x Easy Filter - size M (order no. 2290172)	2298442
Easy Filter set (1 x M, 1 x XXL)	1 x Easy Filter - size M (order no. 2290172) 1 x Easy Filter - size XXL (order no. 2290173)	2298444
Easy Filter set (2 x XXL)	2 x Easy Filter - size XXL (order no. 2290173)	2298443

Easy Filter follow-up sets (for three cooling circuits)

Name	Contents	Order no.
Easy Filter set (2 x M, 1 x XXL)	2 x Easy Filter - size M (order no. 2290172) 1 x Easy Filter - size XXL (order no. 2290173)	2375793
Easy Filter set (1 x M, 2 x XXL)	1 x Easy Filter - size M (order no. 2290172) 2 x Easy Filter - size XXL (order no. 2290173)	2375794

Because both filter valves and the assembly kit can be reused, you only need the individual Easy Filters for each additional application.

Easy Filter single parts

Name	Contents	Order no.
Easy Filter - Size M	Separate filter, size M	2290172
Easy Filter - size XXL	Separate filter, size XXL	2290173
Easy Filter - filter valve	Separate filter valve incl. dust protection cap	2290174
Assembly kit, Easy Filter	Assembly kit for two cooling circuits	1725484
Assembly kit, Easy Filter (1x)	Assembly kit for one cooling circuit	2306604
Conductivity meter	Meter for measuring the water conductivity	0140745

We offer the different components separately as well so you can use the Easy Filter in individual cooling circuits or in machines with three cooling circuits. The single parts can also be reordered for spare parts.

Original accessories

Everything for your machine

Genuine Accessories for TRUMPF machines

TRUMPF not only offers you the complete portfolio of Genuine Parts, but also Genuine Accessories. Find out more on the following pages. After all, the right cleaning products for your lenses and protective glasses are essential in achieving a flawless cutting result. Changing nozzles is also simple when you've got the right tool. And to keep everything running smoothly, check out the overview of key operating fluids and oils.





Genuine Accessories

TruLaser, TruLaser Tube, TruMatic

Cleaning accessories _____	100
Tools _____	101
CutFluid _____	101
Auxiliary equipment _____	101

TruPunch, TruMatic

Setup aids _____	102
Machining oils _____	102



Important ordering information

For prices please consult your local TRUMPF subsidiary or agent. Or, if the service is available from your national subsidiary, order directly online from www.mytrumpf.com.

Genuine Accessories

TruLaser, TruLaser Tube, TruMatic

Cleaning accessories, for CO₂ lasers

Cleaning set for CO₂ optics



Order no. 0378463

Optics Cleaner – 80 ml



Order no. 2243506

Lens cleaning paper - 80 x 165 mm



Order no. 1687226

1-propanol - 30 ml dropper bottle



Order no. 0378178

Box with cotton pads (50 pcs.)



Order no. 0370681

Cotton pads (3x 50 pcs.)



Order no. 0367430

Lens holder



Order no. 0247451

Dust blower



Order no. 0779473

Disposable filter (air gun)



Order no. 0358580

Window cleaning set



Order no. 1713014

Cleaning accessories, for solid-state laser

Cleaning set for SSL optics



Order no. 1675885

Methanol - 50 ml dropper bottle



Order no. 0764334

Protective glass holder with lamp mount



Order no. 1652982

Photo paper - 4" x 8"



Order no. 1335798

Dust blower



Order no. 0779473

Knitted polyester swabs - 100 swabs



Order no. 1222024

Window cleaning set



Order no. 1713014

TruLaser, TruLaser Tube, TruMatic

Lens changing tools

High-pressure lens tool



Order no. 0960634

Lens tool - Ø 40 mm



Order no. 1504922

Lens tool - Ø 50 mm



Order no. 1969196

Lens tool - Ø 50 mm



Order no. 1548659

Lens tool - Ø 40 mm (TruLaser Tube)

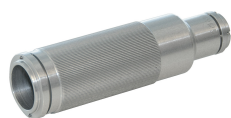

Order no. 1420986

Nozzle changing tools

Nozzle tool - Standard / BrightLine M12



Order no. 1369441

Nozzle tool - CoolLine



Order no. 1718413

Nozzle tool - Mirror cutting head



Order no. 1792285

CutFluid

CutFluid - 1 l container



Order no. 0356258

CutFluid - 5 l container



Order no. 0356259

Auxiliary equipment

Pick-up magnet



Order no. 0018343

Conductivity meter



Order no. 0140745

Auxiliary equipment

Measuring magnifier



Order no. 1967985

Reticle for measuring magnifier, circular, 0.1/0.01 mm



Order no. 1968012

Scotch adhesive tape – 19 mm x 7.5 m



Order no. 0056875

Flat key for the touchdown nozzle
order no. 2228804 (EAV)
order no. 2494062 (CAV)



Order no. 2228804

Genuine Accessories

TruPunch, TruMatic

Setup aids

Tool setup aid



Order no. 0232090

Tool adjustment aid



Order no. 0937592

Lever for removing the cartridges



Order no. 0259684

Fixture for opening the die clamp



Order no. 0919978

Punching and nibbling oil

Punching and nibbling oil - 500 ml spray



Order no. 0111309

Punching and nibbling oil - 1 l container



Order no. 0111310

Punching and nibbling oil - 10 l container



Order no. 0111311

Tapping oil for aluminum

Variocut C462 - 1 l container



Order no. 0116941

Variocut C462 - 20 l container



Order no. 0116938

Tapping oil for stainless steel and mild steel

Variocut B30 - 1 l container



Order no. 0124302

Variocut B30 - 20 l container



Order no. 0113149

Akamin cutting oil

Akamin cutting oil - 1 l container



Order no. 0125874

Akamin cutting oil - 20 l container



Order no. 0061461

Tips for application

Knowing how

Application tips for your Genuine Parts

Questions routinely occur in your day-to-day production operations. What steps are involved in lens cleaning? What's the best ways to clean and replace the cooling water? Which cooling water additive belongs in which tank? We explain everything step by step, to make sure you are prepared to face the future.

If you are interested in more tips for using our Genuine Parts, let us know what you need by e-mailing spareparts.catalog@de.trumpf.com. We will be glad to help you out with some additional tips and tricks.





Application Tips

Perfect lens cleaning _____	106
Quick protective glass cleaning _____	108
Cleaning and replacing cooling water _____	110
Reconditioning of cooling water _____	112

Perfect lens cleaning

Cleaning Genuine Lenses

With the TRUMPF optics cleaning set for CO₂ lasers (see chapter "Genuine Accessories"), you can clean your Genuine Lens easily, step by step.



Step 1 – Preparation

Always clean the lenses in a clean environment and always use the finger stalls from the cleaning set every time before cleaning the lenses. Place the lens onto the lens holder with the convex side facing down.



Step 2 – Preparation

Carefully blow any particles off the lens using the dust blower or N₂ pistol. Please use the filter attachment.



Step 3 – Pre-cleaning

Place the cleaning paper onto the lens and moisten it with a few drops of 1-propanol, so that the surface of the lens is completely covered.



Step 4 – Pre-cleaning

Slowly pull the cleaning paper over the lens without pressure to remove all of the propanol. Following this, dispose of the paper.

Step 5 – Main cleaning

In the next step, clean the lens using the Optics Cleaner. Shake the bottle well every time before use and ensure that the Optics Cleaner is in liquid form. To clean, place approximately 1-2 drops onto a cotton pad.

**Step 6 – Main cleaning**

Now wipe the lens with the cotton pad in a circular motion and with light pressure. You can dry any remaining Optics Cleaner on the lens surface with the dust blower or the N₂ pistol.

Please always follow this sequence and never use 1-propanol after using Optics Cleaner, as any residual propanol film can lead to stronger absorption of the laser beam.

**Step 7 – After-treatment**

Using new cotton pads, remove any residual Optics Cleaner from around the edge of the lens and polish the surface with a light, circular rubbing motion. Keep using fresh pads until there is no more residue visible.

**Step 8 – Change of side**

Turn the lens on the cleaning fixture, so that the convex side faces up. Repeat steps 2 to 7 and achieve excellent cutting results once more with the thoroughly cleaned lens.



Quick protective glass cleaning

Cleaning the Genuine Protective Glass

With the TRUMPF optics cleaning set for solid-state lasers (see chapter "Genuine Accessories"), you can clean your Genuine Protective Glass simply and step by step.



Step 1 – Preparation

Always clean the protective glass in a clean environment. Use the finger stalls from the cleaning set every time before cleaning the protective glass, then place the protective glass onto the intended mounting device. After doing so, switch on the flashlight to help you detect impurities more effectively.



Step 2 – Preparation

Carefully blow any loose dirt particles off the protective glass using the dust blower or N₂ pistol.



Step 3 – Cleaning

Place a few drops of methanol onto the polyester swab.



Step 4 – Cleaning

Start by removing the larger dirt particles, before moving finer impurities to the edge with even strokes of the swab. Do not put the swab down on the protective glass in order to avoid residues.

Quick protective glass cleaning

Step 5 – Preparing to change sides

If the swab comes in contact with the table it can pick up impurities that would scratch the glass. Do not, therefore, put the swab down on the table. Please dispose of any used swabs and do not reuse them.

**Step 6 – Changing sides**

Next, turn the protective glass over and clean the other side, following steps 2 - 4. Getting your protective glass ready for use again really is as quick and easy as this.



Cleaning and replacing cooling water

Use of Genuine Easy Kit and Filter Cartridge

The cooling water in your machine should be cleaned and changed once a year in order to ensure continued reliable cooling of all the machine's important components. **A full guide with all the details for your machine type can be found in the corresponding operating instructions in the chapter "Maintenance".**



Step 1 – Choose the correct Easy Kit

You can find out which Easy Kit is needed by looking at the label on your machine or the note in the operator's manual.

You can receive the right Easy Kit with the correct dosage for each machine, laser and unit, according to water quantity and circuit type. The corresponding order numbers can be found in the chapter "Multi-series Genuine Parts".

Coolant circuit	Water quantity = tank fill level + hose volume	Easy Kit
Copper	5 - 14 l	Easy Kit Cu-1
	15 - 49 l	Easy Kit Cu-2
	50 - 119 l	Easy Kit Cu-3
	50 - 119 l	Easy Kit CU-3 KK4
	120 - 359 l	Easy Kit Cu-4
Aluminum	360 - 999 l	Easy Kit Cu-5
	30 - 79 l	Easy Kit AL-1
	80 - 199 l	Easy Kit AL-2
	200 - 599 l	Easy Kit AL-3
	600 - 1199 l	Easy Kit AL-4

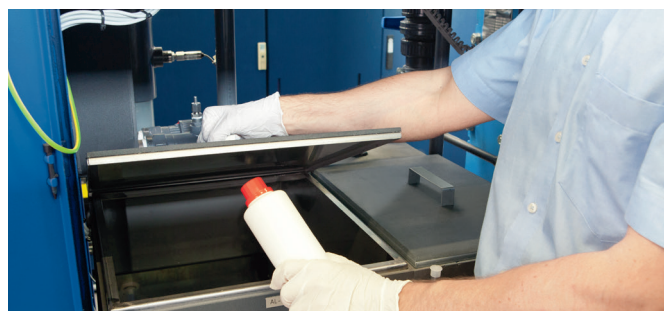

Step 2 – Cleaning procedure

In the Easy Kit Al, you can find the cleaning biocide, pre-metered for your tank, in the bottle with the red cap. Pour it all into the aluminum tank. Proceed in exactly the same way with the Easy Kit Cu and the copper tank. Next, start the two-hour cleaning procedure using the machine control. During this time, your TRUMPF machine can continue producing as normal.



Step 3 – Draining and flushing the water

Prior to changing the water, production must be briefly stopped. Drain the water completely and dispose of it according to the applicable national regulations.

Next, fill the tanks up to 60% of capacity with fresh, demineralized water and allow it to circulate for 10 minutes. Repeat the flushing process until the conductivity of the water is no more than 20 µS/cm and the water is clear and free of suspended matter.



Step 4 – Replacing the filters

Replace the filters in the cooling water circuits and clean the existing sieves and nozzles on the adaptive mirrors.

Cleaning and replacing cooling water

Step 5 – Refilling the water

Fill the tanks completely (100%) with fresh, demineralized water.

**Step 6 – Adding corrosion protection**

Pour the complete contents of the bottle of corrosion protection (with the light blue cap) from the Easy Kit Al into the aluminum cooling circuit. Pour the corrosion protection from the bottle with the yellow cap from the Easy Kit Cu into the copper cooling circuit. Circulate the water for a few minutes.

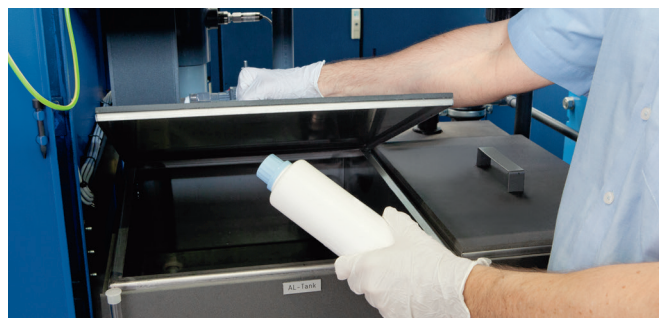
**Step 7 – Checking conductivity**

Check the conductivity of the cooling water:

- Limit value in copper cooling circuit max. 200 $\mu\text{S}/\text{cm}$
- Limit value in aluminum cooling circuit max. 500 $\mu\text{S}/\text{cm}$

**Step 8 – Documentation**

Document the successful cleaning on the sign "Cleaning the cooling circuit". Your machine components are now perfectly cleaned for another year.



Reconditioning of cooling water

Use of Genuine Easy Filter, Easy Kit and Filter Cartridge

The process cooler of your machine and your laser should be serviced once a year. The alternative to the time-consuming water change is the reconditioning of the cooling water with the Genuine Easy Filter. **A full guide with all the details for your machine type can be found in the corresponding operating instructions in the chapter „Maintenance“.**



Step 1 – Choose the correct Easy Filter

Contact us before you use the Easy Filter the first time, in order to figure out whether the Easy Filter can be used with your machine or your laser. We will be happy to advise you. You can find out which type of Easy Filter you need on the basis of the used Easy Kit. The following table will help you to choose the correct Easy Filter. The corresponding order numbers can be found in the chapter „Multi-series Genuine Parts“.

Easy Kit	Easy Filter	Water in cooling circuit
Easy Kit Cu-1	Easy Filter - size M	5 - 14 l
Easy Kit Cu-2	Easy Filter - size M	15 - 49 l
Easy Kit Cu-3	Easy Filter - size M	50 - 119 l
Easy Kit CU-3 KK4	Easy Filter - size M	50 - 119 l
Easy Kit Cu-4	Easy Filter - size XXL	120 - 359 l
Easy Kit Cu-5	Easy Filter - size XXL	360 - 999 l
Easy Kit AL-1	Easy Filter - size M	30 - 79 l
Easy Kit AL-2	Easy Filter - size XXL	80 - 199 l
Easy Kit AL-3	Easy Filter - size XXL	200 - 599 l
Easy Kit AL-4	2 x Easy Filter - size XXL	600 - 1199 l

The cooling circuits have to be prepared before using the Easy Filter the first time. To do this, a retrofit kit with a mounting manual is part of the starter sets of the Easy Filter. The retrofit is performed in a few easy steps.



Step 2 – Cleaning procedure

In the Easy Kit Al, you can find the cleaning biocide, pre-metered for your tank, in the bottle with the red cap. Pour it all into the aluminum tank. Proceed in exactly the same way with the Easy Kit Cu and the copper tank. Next, start the two-hour cleaning procedure using the machine control. During this time, your TRUMPF machine can continue producing as normal.



Step 3 - Mounting the Easy Filter

Mount the corresponding Easy Filter to each cooling circuit. Open the valve of the supply tube of the Easy Filter and turn on the process cooler. In doing so, the cooling water will be pumped through the Easy Filter. The Easy Filter cleans the used cooling water, so that you have demineralized water again.



Step 4 - Measure the conductivity

Measure the conductivity of the cooling water every 30 – 60 minutes during the filtering process. This is done by opening the tank and holding the conductivity meter in the cooling water. After a few seconds you can see the conductivity of the water. When it is less than 10 µS, it has been filtered enough. The required time depends on the size of the tank.

Step 5 – Removing the Easy Filter and replacing the filter cartridges

Remove the Easy Filter and seal the filter valves with the protective cover. Then, replace the filter cartridges in the cooling water circuits and clean the existing sieves and nozzles on the adaptive mirrors.



Step 6 – Refilling the water

Some water might be lost during the process or has evaporated. Fill the tanks completely (100%) with fresh, demineralized water.



Step 7 – Adding corrosion protection

Pour the complete contents of the bottle of corrosion protection (with the light blue cap) from the Easy Kit Al into the aluminum cooling circuit. Pour the corrosion protection from the bottle with the yellow cap from the Easy Kit Cu into the copper cooling circuit. Circulate the water for a few minutes.



Step 8 – Checking conductivity

Check the conductivity of the cooling water:

- Limit value in copper cooling circuit max. 200 µS/cm
- Limit value in aluminum cooling circuit max. 500 µS/cm



Step 9 – Documentation

Document the successful cleaning on the sign „Cleaning the cooling circuit“. Your machine components are now perfectly cleaned for another year.

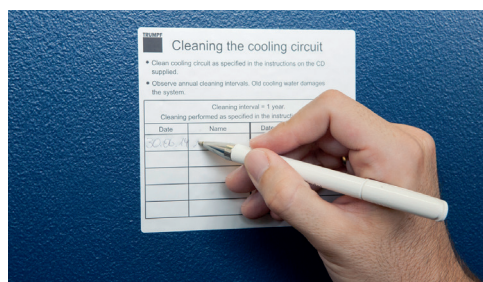

Your order

Easy and convenient ordering

Ordering your Genuine Parts

A convenient and easy ordering process is essential for ensuring rapid delivery of your Genuine Parts. Here you will find all the key details about your order.

You choose the ordering channel that suits you best! Whether by e-mail, phone, fax, or online at www.mytrumpf.com: we will be glad to supply you promptly and reliably.

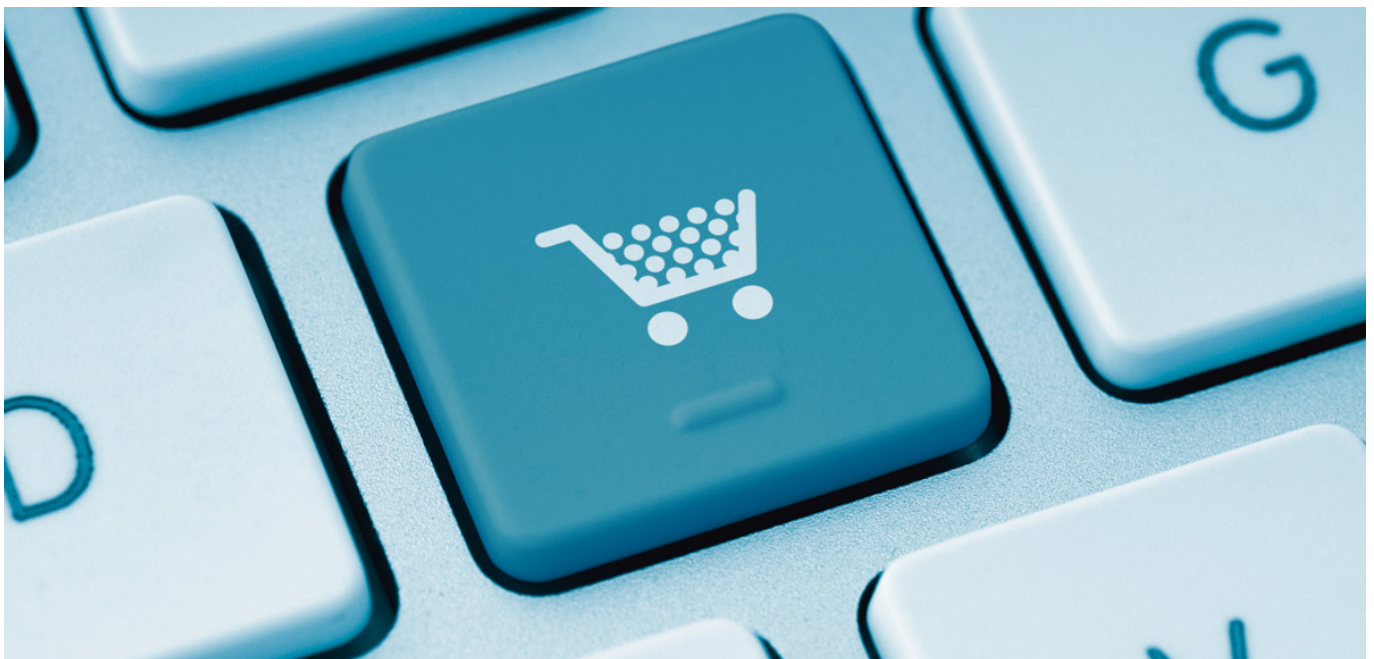



Your order

MyTRUMPF customer portal _____	116
Global contacts _____	117
General information _____	121

MyTRUMPF customer portal

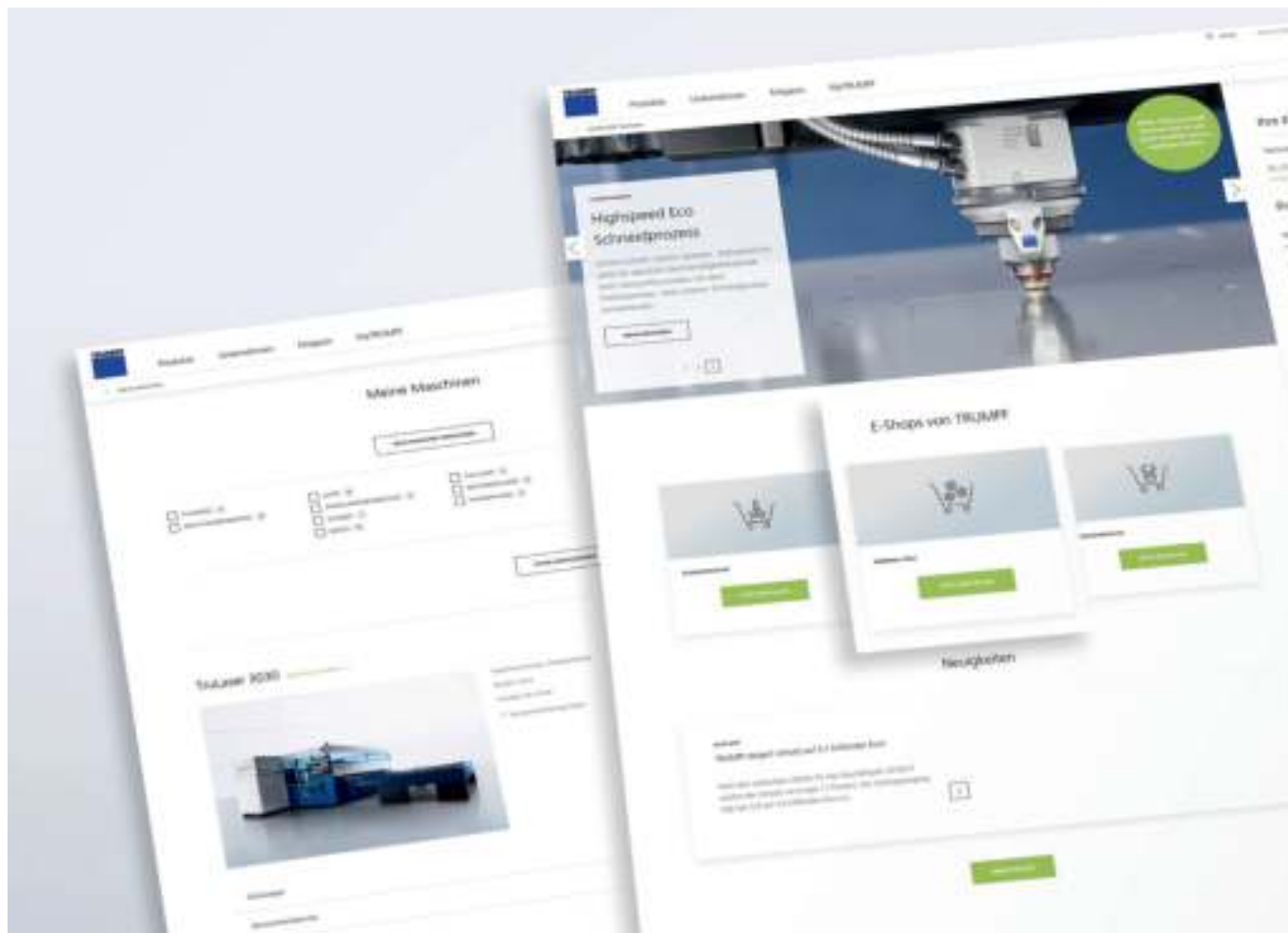

Everything needed for your TRUMPF machines in one portal

In your everyday work, you can profit from your personal access to the TRUMPF world. Use the many individual benefits of our free customer portal - customized for your own machinery. MyTRUMPF is a real complete package and supports you right through the process. Thanks to exclusive online deals and insider tips from our experts, you can save hard cash and will always be one step ahead.

MyTRUMPF – Your advantages:

The ordering of Genuine Parts, punching and bending tools in our E-Shop. You keep an eye on all your orders, and can track deliveries thanks to a detailed order overview. The download of software updates, programming data or technical documents. An overview of your machinery, including software versions and other reserved services. Regular online offers and discount offers with attractive price advantages. Helpful application tips and technical articles from TRUMPF product experts.

Take advantage of all of the MyTRUMPF benefits and register free of charge at:
www.trumpf.com/mytrumpf

Your expert point of contact worldwide

Africa

Country	Address	Telephone	E-mail
Egypt	TRUMPF Werkzeugmaschinen GmbH + Co. KG Egypt Branch P.O. Box 5697 Heliopolis West 11771 Cairo	+ 20 2 24519974	admin.eg@de.trumpf.com
South Africa	Retecon (Pty) Ltd. 100 Plane Road Spartan / Kempston Park 1619 Gauteng	+ 27 11 976 8600	spares@retecon.co.za

America

Country	Address	Telephone	E-mail
Argentina	Grassmann S.A. Uspallata 345 San Isidro CP 1642, Provincia de Buenos Aires	+ 54 11 4763 4009	info@grassmann.com.ar
Brazil	TRUMPF Maquinas Ind. E. Com. Ltda. Avenida Juruá, 150 – Alphaville 06455-10 Barueri – São Paulo	+ 55 11 4133 3560	trumpf@trumpf.com.br
Chile	Chile Soldadura Y Corte (CSC) Doctor Lira Valencia N° 1586 Quilicura Santiago	+ 56 224 375 000	info@weldingcutting.com
Canada	TRUMPF Canada Inc. 1-3755 Laird Road Mississauga, ON L5L 0B3	+ 1 800 306 1077	spareparts@ca.trumpf.com
Mexico	TRUMPF Mexico S. de R.L. de C.V. Bld. Apodaca 210 Apodaca Technology Park Apodaca, NL 66627 Mexico	+ 52 81 8131 2100	spareparts@mx.trumpf.com
Colombia	MAKSER S.A.S Autopista Medellín KM 7 Parque Industrial Celta Trade Park Lote 155 Bodega 2 110931 Bogota D.C.	+ 57 1 4862090	repuestos@Makserweb.com
Peru	Andes Technology Av. Flora Tristán 765 Lima 12	+ 511 348 7611	ventas@andestechnology.com
USA	TRUMPF Inc. Farmington Industrial Park Farmington, CT 06032	+ 1 860 255 6	spareparts@us.trumpf.com

Asia-Pacific

Country	Address	Telephone	E-mail
Australia	Headland Machinery Pty. Ltd. 95 Highbury Road Burwood Victoria 3125	+ 61 3 9244 3500	spareparts@headland.com.au
China	TRUMPF China Co. Ltd. 6F, Central Plaza 381 Huaihai Zhong Road Shanghai 200020	+ 86 21 6171 9000	info@cn.trumpf.com
India	TRUMPF India Pvt. Ltd. Raisoni Industrial Park S. No. 276, Hissa No. 1. Village Mann, Taluka: Mulshi Pune - 411 057	+ 91 20 66759830	spares@in.trumpf.com
Indonesia	PT. TRUMPF Indonesia Delta Silicon VI Jl. Ramin 1 Blok G 6/6, Lippo Cikarang Bekasi 17550	+ 62 21 80608200	spareparts@id.trumpf.com

Your expert point of contact worldwide

Asia-Pacific

Country	Address	Telephone	E-mail
Iran	Ario Felez Co Mirmotahari St, Unit 8 No 19 Seyed Khandan Bridge Tehran, 1541939533	+ 98 21 26702213	info@ario.co
Israel	Tavor Advanced Machinery LTD 13 Sdehrot Hamikzoot Blv. (Einav Center) Modi'in 7171801	+ 972 89398282	arie.elmalem@tavor-am.co.il
Japan	TRUMPF Corporation 1-18-2 Hakusan Midori-ku Yokohama 2260006	+ 81 45 9 31 57 10	parts@jp.trumpf.com
South Korea	TRUMPF Korea Co. Ltd. 7th Floor TRUTEK Building Sangam-dong, 12, WorldCupbuk-ro 56-gil Mapo-gu Seoul 121-835	+ 82 2 6096 2500	spareparts@kr.trumpf.com
Malaysia	TRUMPF Malaysia Sdn Bhd Seksyen 51 No. 12A, Jalan Tandang 51/205A 46050 Petaling Jaya, Selangor Darul Ehsan	+ 60 3 7770 0088	spareparts@my.trumpf.com
New Zealand	AOTEAMACHINERY GROUP LTD. Maurice Road 10e P.O.Box 12 646 Penrose Auckland	+ 64 9 5256907	sales@aoteamachinery.co.nz
Philippines	TRUMPF Philippines Inc. Representative Office Unit 5S, 26th Floor, Twenty-Four Seven Mc Kinley, 24th Street corner 7th Avenue, BONIFACIO GLOBAL CITY TAGUIG		spareparts@sg.trumpf.com
Russia	TRUMPF OOO 1-j proezd Perova Polja, 9 Stroenie 4 111141, Moscow	+ 74 95 234-5713	spl@ru.trumpf.com
Saudi Arabia	Al Ruqee Technical Services P.O.Box 3657 Al Khobar 31952	+ 966 138594797	4service@alruqee.com
Serbia	SV Technologies & Consulting doo Batajnickski put 23 11080 Zemun	+ 381 11 3073 527	office@svtc.rs
Singapore	TRUMPF Asia Pacific (TSG) 25 International Business Park 02-28/29 German Center Singapore 609916	+ 65 6571 8000	spareparts@sg.trumpf.com
Taiwan	TRUMPF Taiwan Industries Co. Ltd. No. 28, Huaya 1st Rd., Gueishan Dist. Taoyuan City, 33383	+ 88 63 270 8000	sparepart@tw.trumpf.com
Thailand	TRUMPF Ltd. 19, 21 Motorway Road, Klongsongtonnun, Lat Krabang 10520 Bangkok	+ 66 63 202 1431	info@th.trumpf.com
United Arab Emirates	ATAD International general trading LLC Office 106, First Floor Commercial Bank of Dubai Building Shk. Zayed Road PO Box 19212 Dubai	+ 97 14 3306063	info@atad.ae
Vietnam	TRUMPF Pte Ltd. Representation Office 4th Floor, VTP Building No. 8 Nguyen Hue Blvd., Ben Nghe Ward, District 1 HCM CITY	+ 84 8 3822 0528	spareparts@sg.trumpf.com
Belarus	InterTechnoMarket Ulitzja Parnikovaia, 7-80 220114, Minsk	+ 375 17 2676877	info@itmstanki.com

Your expert point of contact worldwide

Europe

Country	Address	Telephone	E-mail
Belgium	V.A.C. MACHINES NV/SA Kleine Pathoekeweg 13-15 8000 Bruges	+ 32 50 315083	spare.parts@vac-machines.be
Bulgaria	TRUMPF Bulgaria Ltd. Mimi Balkanska Str.140 1517 Sofia	+ 35 92 8601492	info@bg.trumpf.com
Denmark	AVN Pladeteknik A/S Dalager 1 2605 Brøndby	+ 45 70200411	spareparts.pladeteknik@avn.dk
Germany	TRUMPF Werkzeugmaschinen Deutschland Vertrieb + Service GmbH + Co. KG Johann-Maus-Str. 2 71254 Ditzingen	+ 49 7156/303-0	kundenbetreuung@de.trumpf.com
Estonia	Rolands Moisejs OÜ Tuleviku tee 2 Peetri, 75312, Harju maakond	+ 37 26139860	info@rm.ee
Finland	TruTekniikka Oy Varsikuja 4 01740 Vantaa	+ 35 820 728 9880	info@trutek.fi
France	TRUMPF S.A.S Paris Nord 2 86, Allée des Erables CS 52239 Villepinte, 95956 Roissy CDG Cedex	+ 33 148 17 37 57	pieces.detachees@fr.trumpf.com
Greece	Big Blue Tools Georgia Sempou Athanasios Kotsianis O.E. Kleovoulou 1 15344 Gerakas	+ 30 210 6047117	sales@bbtools.gr
Great Britain	TRUMPF Ltd. President Way Airport Executive Park Luton, BEDS. LU2 9NL	+ 44 1582 725335	spares@uk.trumpf.com
Ireland	Lister Machine Tools Ltd. P. O. Box 838 Bluebell Industrial Estate Dublin 12	+ 35 314 50 88 66	sales@listermachinetools.com
Italy	TRUMPF srl a socio unico Via del Commercio 6 20090 Buccinasco/MI	+ 39 02 48489420	ricambi@trumpf.com
Latvia	Rolands Moisejs SIA Ciekurkalna 1.linija 40, LV-1026, Riga	+ 371 67 501 616	info@rolandsmoisejs.lv
Lithuania	Rolands Moisejs UAB Kirtimų 47-202, LT-02244, Vilnius	+ 370 52640769	info@rolandsmoisejs.lt
Netherlands	TRUMPF Nederland B.V. John Maynard Keynesstraat 301 7559 SV Hengelo (Ov)	+31 88 4002 400	onderdelen@nl.trumpf.com
Northern Ireland	Lister Machine Tools NI Ltd. 4 Ferguson Way Kilbegs Business Park Antrim, BT41 4LZ	+ 44 2890 663804	ruth@listermachinetools.co.uk
Austria	TRUMPF Maschinen Austria GmbH + Co. KG Industriepark 24 4061 Pasching	+ 43 7221 603-0	ersatzteile@at.trumpf.com
Poland	TRUMPF Polska Spółka z ograniczoną odpowiedzialnością Sp.k ul. Połczyńska 111 01-303 Warsaw	+ 48 22 575 39 00	czesci.zamienne@pl.trumpf.com
Portugal	TRUMPF Máquinas-Ferramentas e Laser, Unipessoal, Lda. Lagoas Park Edifício 11 Piso 1 2740-270 Porto Salvo, Oeiras	+ 420 251 106200	repuestos@es.trumpf.com
Romania	TRUMPF Laser + Machinery S.R.L. Str. Dorobanților nr. 112, bl. G2, ap. 4. 400609 Cluj-Napoca	+ 40 21 3273820	info@ro.trumpf.com

Your expert point of contact worldwide

Europe

Country	Address	Telephone	E-mail
Sweden	TRUMPF Maskin AB Aleforsvaegen 5 Box 606 44117 Alingsås	+ 46 322 669 700	order@se.trumpf.com
Switzerland	TRUMPF Maschinen AG Ruessenstrasse 18 6340 Baar	+ 41 41 7696666	ch-ersatzteile@ch.trumpf.com
Slovakia	TRUMPF Slovakia, s.r.o. Galgovecká 7 040 011 Košice	+ 421 55 7280915	diely@sk.trumpf.com
Slovenia	Mastroj d.o.o. Sentiljska 39 a 2000 Maribor	+ 386 2 234 2867	valerija.stergar@mastroj.si
Spain	TRUMPF Maquinaria, S.A. Calle Valportillo Primera, Nº 1 28108 Alcobendas (Madrid)	+ 34 91 657 36 70	repuestos@es.trumpf.com
Czech Republic	TRUMPF Praha spol. s.r.o. K Hájum 1355/2a 155 00 Prague A 5	+ 420 251 106200	servis@cz.trumpf.com
Turkey	TRUMPF MAKİNA SANAYİİ ANONİM ŞİRKETİ Kosuyolu Mah. Cenap Sahabettin Cad. No. 70 34718 – Kadıköy / İstanbul	+ 90 216 5704556	yedek.parca@tr.trumpf.com
Hungary	TRUMPF Hungary Kft. H-2220 Vecsés, Lincoln u.1. l. em. 1211 Budapest	+ 36 29 999 100	alkatresz@hu.trumpf.com
Ukraine	SFERA-TECHNO Post-Volynskaya str. 5 Kiev 03061	+ 380 44 4918625	

Terms of delivery

For delivery of the products listed in this catalog, the applicable terms of delivery stipulated by the supplying TRUMPF company or its representative are decisive. TRUMPF or its representative will be happy to provide you with these terms.

Service

Please only use Genuine Parts and Genuine Accessories from TRUMPF. This guarantees you complete, correct and safe use and the acknowledgement of any warranty claims in the event of a complaint.

Prices

For prices, please consult your local TRUMPF subsidiary or agent. Or, if the service is available from your national subsidiary, order directly online from www.mytrumpf.com.

Subject to change

The data contained within this catalog is subject to change, errors, and printing errors; any liability is excluded. Technical data in particular are subject to change without prior notification. Individual features may vary depending on country-specific factors.

Images are not exact and may contain minor deviations from the original.

All specifications without guarantee.

Notes

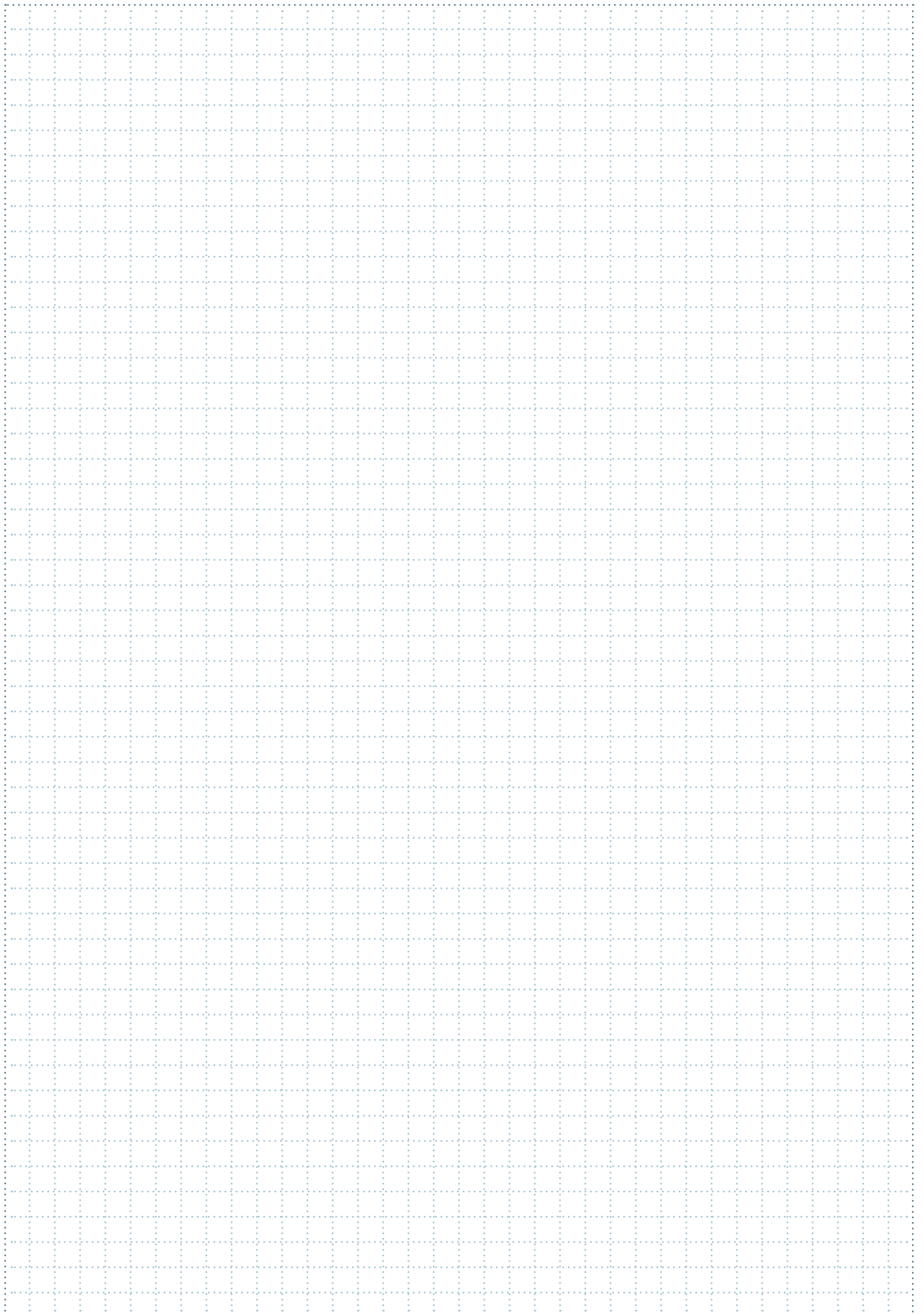

The TRUMPF nozzle selection



Standard nozzle M12
Nozzle EAA



Slim nozzle M12
Nozzle EAB



BrightLine nozzle M12
Nozzle EAC, EAK, EAN, EAQ



CoolLine nozzle M12/M28
Nozzle EFL, EGL



Performance nozzle M12
Nozzle EAU

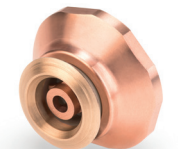

Touchdown nozzle M12
Nozzle EAV



Bi-flow nozzle M12
Nozzle EAU



Standard nozzle M8,
not chrome-plated
Nozzle ECE, not chrome-plated

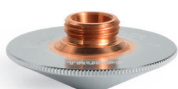

Standard nozzle M8,
chrome-plated
Nozzle ECE, chrome-plated



Standard nozzle M8 TruMatic
Nozzle ECP



Standard nozzle M6, TruLaser Tube
Nozzle EBD



Slim nozzle M6, TruLaser Tube
Nozzle EBF, EBG



Mirror cutting head nozzle
Two-part nozzle AA*, IA*



Bi-flow nozzle
Touchdown nozzle
Highspeed & Highspeed Eco



Touchdown nozzle
Highspeed Eco



BrightLine nozzle



CoolLine nozzle



Mirror cutting head

TRUMPF is certified to ISO 9001:2008

(For more information go to www.trumpf.com/unternehmen/qualitaet)

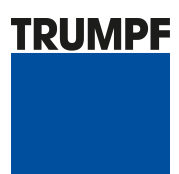

www.trumpf.com